

FCC Radio Test Report

FCC ID: TE7A10V2

This report concerns: **Original Grant**

Project No. : 2003C215
Equipment : AC2600 MU-MIMO Wi-Fi Router
Brand Name : tp-link
Test Model : Archer A10
Series Model : N/A
Applicant : TP-Link Technologies Co., Ltd.
Address : Building 24(floors 1,3,4,5) and 28(floors 1-4) Central Science and Technology Park, Shennan Rd, Nanshan, Shenzhen, China
Manufacturer : TP-Link Technologies Co., Ltd.
Address : Building 24(floors 1,3,4,5) and 28(floors 1-4) Central Science and Technology Park, Shennan Rd, Nanshan, Shenzhen, China
Date of Receipt : Mar. 27, 2020
Date of Test : Mar. 30, 2020 ~ Jul. 08, 2020
Issued Date : Jul. 09, 2020
Report Version : R01
Test Sample : Engineering Sample No.: DG20200327177.
Standard(s) : FCC Part15, Subpart E(15.407)
ANSI C63.10-2013
FCC KDB 789033 D02 General UNII Test Procedures New Rules v02r01
FCC KDB 662911 D01 Multiple Transmitter Output v02r01

The above equipment has been tested and found compliance with the requirement of the relative standards by BTL Inc.

Chay Cai

Prepared by : Chay Cai

Ethan Ma

Approved by : Ethan Ma



Certificate #5123.02

Add: No.3, Jinshagang 1st Road, Shixia, Dalang Town, Dongguan, Guangdong, China.

Tel: +86-769-8318-3000

Web: www.newbtl.com

Declaration

BTL represents to the client that testing is done in accordance with standard procedures as applicable and that test instruments used has been calibrated with standards traceable to international standard(s) and/or national standard(s).

BTL's reports apply only to the specific samples tested under conditions. It is manufacture's responsibility to ensure that additional production units of this model are manufactured with the identical electrical and mechanical components. **BTL** shall have no liability for any declarations, inferences or generalizations drawn by the client or others from **BTL** issued reports.

The report must not be used by the client to claim product certification, approval, or endorsement by NVLAP, NIST, A2LA, or any agency of the U.S. Government.

This report is the confidential property of the client. As a mutual protection to the clients, the public and ourselves, the test report shall not be reproduced, except in full, without our written approval.

BTL's laboratory quality assurance procedures are in compliance with the **ISO/IEC 17025** requirements, and accredited by the conformity assessment authorities listed in this test report.

BTL is not responsible for the sampling stage, so the results only apply to the sample as received.

The information, data and test plan are provided by manufacturer which may affect the validity of results, so it is manufacturer's responsibility to ensure that the apparatus meets the essential requirements of applied standards and in all the possible configurations as representative of its intended use.

Limitation

For the use of the authority's logo is limited unless the Test Standard(s)/Scope(s)/Item(s) mentioned in this test report is (are) included in the conformity assessment authorities acceptance respective.

Please note that the measurement uncertainty is provided for informational purpose only and are not use in determining the Pass/Fail results.

Table of Contents	Page
REPORT ISSUED HISTORY	6
1 . SUMMARY OF TEST RESULTS	7
1.1 TEST FACILITY	8
1.2 MEASUREMENT UNCERTAINTY	8
1.3 TEST ENVIRONMENT CONDITIONS	9
2 . GENERAL INFORMATION	10
2.1 GENERAL DESCRIPTION OF EUT	10
2.2 TEST MODES	13
2.3 PARAMETERS OF TEST SOFTWARE	16
2.4 DUTY CYCLE	17
2.5 BLOCK DIAGRAM SHOWING THE CONFIGURATION OF SYSTEM TESTED	18
2.6 SUPPORT UNITS	18
3 . AC POWER LINE CONDUCTED EMISSIONS TEST	19
3.1 LIMIT	19
3.2 TEST PROCEDURE	19
3.3 DEVIATION FROM TEST STANDARD	19
3.4 TEST SETUP	20
3.5 EUT OPERATION CONDITIONS	20
3.6 TEST RESULTS	20
4 . RADIATED EMISSIONS TEST	21
4.1 LIMIT	21
4.2 TEST PROCEDURE	22
4.3 DEVIATION FROM TEST STANDARD	22
4.4 TEST SETUP	23
4.5 EUT OPERATION CONDITIONS	24
4.6 TEST RESULTS - 9 KHZ to 30 MHZ	24
4.7 TEST RESULTS - 30 MHz TO 1000 MHz	24
4.8 TEST RESULTS - ABOVE 1000 MHz	24
5 . BANDWIDTH TEST	25
5.1 LIMIT	25
5.2 TEST PROCEDURE	25
5.3 DEVIATION FROM STANDARD	26

Table of Contents	Page
5.4 TEST SETUP	26
5.5 EUT OPERATION CONDITIONS	26
5.6 TEST RESULTS	26
6 . MAXIMUM OUTPUT POWER TEST	27
6.1 LIMIT	27
6.2 TEST PROCEDURE	27
6.3 DEVIATION FROM STANDARD	27
6.4 TEST SETUP	27
6.5 EUT OPERATION CONDITIONS	27
6.6 TEST RESULTS	27
7 . POWER SPECTRAL DENSITY TEST	28
7.1 LIMIT	28
7.2 TEST PROCEDURE	28
7.3 DEVIATION FROM STANDARD	28
7.4 TEST SETUP	28
7.5 EUT OPERATION CONDITIONS	28
7.6 TEST RESULTS	28
8 . FREQUENCY STABILITY MEASUREMENT	29
8.1 LIMIT	29
8.2 TEST PROCEDURE	29
8.3 DEVIATION FROM STANDARD	29
8.4 TEST SETUP	29
8.5 EUT OPERATION CONDITIONS	29
8.6 TEST RESULTS	29
9 . MEASUREMENT INSTRUMENTS LIST	30
10 . EUT TEST PHOTOS	32
APPENDIX A - AC POWER LINE CONDUCTED EMISSIONS	36
APPENDIX B - RADIATED EMISSION - 9 KHZ TO 30 MHZ	39
APPENDIX C - RADIATED EMISSION - 30 MHZ TO 1 GHZ	44
APPENDIX D - RADIATED EMISSION - ABOVE 1000 MHZ	47
APPENDIX E - BANDWIDTH	168
APPENDIX F - MAXIMUM OUTPUT POWER	176

Table of Contents**Page****APPENDIX G - POWER SPECTRAL DENSITY****191****APPENDIX H - FREQUENCY STABILITY****223**

REPORT ISSUED HISTORY

Report Version	Description	Issued Date
R00	Original Issue.	Jun. 17, 2020
R01	Updated the data of Power Spectral Density for UNII-3.	Jul. 09, 2020

1. SUMMARY OF TEST RESULTS

Test procedures according to the technical standard(s):

FCC Part15, Subpart E(15.407)				
Standard(s) Section	Test Item	Test Result	Judgment	Remark
15.207 15.407(b)	AC Power Line Conducted Emissions	APPENDIX A	PASS	-----
15.407(b) 15.205(a) 15.209(a)	Radiated Emissions	APPENDIX B APPENDIX C APPENDIX D	PASS	-----
15.407(a) 15.407(e)	Spectrum Bandwidth	APPENDIX E	PASS	-----
15.407(a)	Maximum Output Power	APPENDIX F	PASS	-----
15.407(a)	Power Spectral Density	APPENDIX G	PASS	-----
15.407(g)	Frequency Stability	APPENDIX H	PASS	-----
15.203	Antenna Requirements	-----	PASS	NOTE (2)
15.407(c)	Automatically Discontinue Transmission	-----	PASS	NOTE (3)

Note:

- (1) "N/A" denotes test is not applicable in this test report.
- (2) The device what use a permanently attached antenna were considered sufficient to comply with the provisions of 15.203.
- (3) During no any information transmission, the EUT can automatically discontinue transmission and become standby mode for power saving. the EUT can detect the controlling signal of ACK message transmitting from remote device and verify whether it shall resend or discontinue transmission.
- (4) For UNII-1 this device was functioned as a
 Access point device Client device

1.1 TEST FACILITY

The test facilities used to collect the test data in this report is at the location of No.3, Jinshagang 1st Road, Shixia, Dalang Town, Dongguan, Guangdong, China.

BTL's Test Firm Registration Number for FCC: 357015

BTL's Designation Number for FCC: CN1240

1.2 MEASUREMENT UNCERTAINTY

ISO/IEC 17025 requires that an estimate of the measurement uncertainties associated with the emissions test results be included in the report. The measurement uncertainties given below are based on a 95% confidence level (based on a coverage factor ($k=2$))

The BTL measurement uncertainty as below table:

A. AC power line conducted emissions test:

Test Site	Method	Measurement Frequency Range	U, (dB)
DG-C02	CISPR	150kHz ~ 30MHz	2.60

B. Radiated emissions test:

Test Site	Method	Measurement Frequency Range	Ant. H / V	U, (dB)
DG-CB03	CISPR	9kHz ~ 30MHz	V	3.79
		9kHz ~ 30MHz	H	3.57
		30MHz ~ 200MHz	V	4.88
		30MHz ~ 200MHz	H	4.14
		200MHz ~ 1,000MHz	V	4.62
		200MHz ~ 1,000MHz	H	4.80
		1GHz ~ 6GHz	-	4.58
		6GHz ~ 18GHz	-	5.18
		18GHz ~ 26.5GHz	-	3.62
		26.5GHz ~ 40GHz	-	4.00

C. Other Measurement:

Parameter	Uncertainty
Spectrum Bandwidth	± 3.8 %
Maximum Output Power	± 0.95 dB
Power Spectral Density	± 0.86 dB
Frequency Stability	± 0.16 dB
Temperature	± 0.08 °C
Time	± 0.58 %
Supply voltages	± 0.3 %

Note: Unless specifically mentioned, the uncertainty of measurement has not been taken into account to declare the compliance or non-compliance to the specification.

1.3 TEST ENVIRONMENT CONDITIONS

Test Item	Temperature	Humidity	Test Voltage	Tested By
AC Power Line Conducted Emissions	25°C	55%	AC 120V/60Hz	Kwok Guo
Radiated Emissions-9K-30MHz	25°C	60%	AC 120V/60Hz	Kwok Guo
Radiated Emissions-30 MHz to 1GHz	24°C	68%	AC 120V/60Hz	Kwok Guo
Radiated Emissions-Above 1000 MHz	25°C	60%	AC 120V/60Hz	Kwok Guo
Spectrum Bandwidth	22°C	43%	AC 120V/60Hz	Hayden Chen
Maximum Output Power	22°C	43%	AC 120V/60Hz	Laughing Zhang
Power Spectral Density	22°C	43%	AC 120V/60Hz	Hayden Chen
Frequency Stability	Normal & Extreme	43%	Normal & Extreme	Hayden Chen

2. GENERAL INFORMATION

2.1 GENERAL DESCRIPTION OF EUT

Equipment	AC2600 MU-MIMO Wi-Fi Router
Brand Name	tp-link
Test Model	Archer A10
Series Model	N/A
Model Difference(s)	N/A
Power Source	DC voltage supplied from AC adapter. Model: T120150-2B1
Power Rating	I/P: 100-240V~ 50/60Hz 0.6A O/P: 12V \equiv 1.5A
Operation Frequency Bands	UNII-1: 5150 MHz ~ 5250 MHz UNII-3: 5725 MHz ~ 5850 MHz
Modulation Type	OFDM
Bit Rate of Transmitter	Up to 1733.2Mbps
Maximum Output Power for UNII-1 _Non Beamforming	IEEE 802.11a: 26.41 dBm (0.4375 W) IEEE 802.11ac (VHT20): 26.18 dBm (0.4150 W) IEEE 802.11ac (VHT40): 27.33 dBm (0.5408 W) IEEE 802.11ac (VHT80): 22.75 dBm (0.1884 W)
Maximum Output Power for UNII-3 _Non Beamforming	IEEE 802.11a: 29.11 dBm (0.8147 W) IEEE 802.11ac (VHT20): 29.20 dBm (0.8318 W) IEEE 802.11ac (VHT40): 28.32 dBm (0.6792 W) IEEE 802.11ac (VHT80): 28.74 dBm (0.7482 W)
Maximum Output Power for UNII-1 _Beamforming	IEEE 802.11ac (VHT20): 25.00 dBm (0.3162 W) IEEE 802.11ac (VHT40): 24.86 dBm (0.3062 W) IEEE 802.11ac (VHT80): 18.93 dBm (0.0782 W)
Maximum Output Power for UNII-3 _Beamforming	IEEE 802.11ac (VHT20): 26.30 dBm (0.4266 W) IEEE 802.11ac (VHT40): 25.97 dBm (0.3954 W) IEEE 802.11ac (VHT80): 25.99 dBm (0.3972 W)

Note:

1. For a more detailed features description, please refer to the manufacturer's specifications or the user's manual.

2. Channel List:

IEEE 802.11a IEEE 802.11n (HT20) IEEE 802.11ac (VHT20)		IEEE 802.11n (HT40) IEEE 802.11ac (VHT40)		IEEE 802.11ac (VHT80)	
UNII-1		UNII-1		UNII-1	
Channel	Frequency (MHz)	Channel	Frequency (MHz)	Channel	Frequency (MHz)
36	5180	38	5190	42	5210
40	5200	46	5230		
44	5220				
48	5240				

IEEE 802.11a IEEE 802.11n (HT20) IEEE 802.11ac (VHT20)		IEEE 802.11n (HT40) IEEE 802.11ac (VHT40)		IEEE 802.11ac (VHT80)	
UNII-3		UNII-3		UNII-3	
Channel	Frequency (MHz)	Channel	Frequency (MHz)	Channel	Frequency (MHz)
149	5745	151	5755	155	5775
153	5765	159	5795		
157	5785				
161	5805				
165	5825				

3. Antenna Specification:

Ant.	Brand	P/N	Antenna Type	Connector	Gain (dBi)	Note
1	tp-link	3101502909	Dipole	I-PEX	4.98	UNII-1
2	tp-link	3101502908	Dipole	I-PEX	4.98	UNII-1
3	tp-link	3101502910	Dipole	I-PEX	4.98	UNII-1
4	tp-link	3101502911	PCB	I-PEX	4.98	UNII-1
1	tp-link	3101502909	Dipole	I-PEX	3.64	UNII-3
2	tp-link	3101502908	Dipole	I-PEX	3.64	UNII-3
3	tp-link	3101502910	Dipole	I-PEX	3.64	UNII-3
4	tp-link	3101502911	PCB	I-PEX	3.64	UNII-3

Note:

This EUT supports CDD, and all antennas have the same gain, then,

- 1) Non Beamforming function, Directional gain = $G_{ANT} + \text{Array Gain}$,
 - a) For UNII-1:

For power measurements, Array Gain = 0 dB ($N_{ANT} \leq 4$), so the Directional gain=4.98.
 For power spectral density measurements, $N_{ANT} = 4$, $N_{SS} = 1$. So Directional gain = $G_{ANT} + \text{Array Gain} = G_{ANT} + 10\log(N_{ANT}/N_{SS})$ dB = $4.98 + 10\log(4/1)$ dBi=11.00. Then, the power spectral density limit is $17 - (11.00 - 6) = 12.00$.
 - b) For UNII-3:

For power measurements, Array Gain = 0 dB ($N_{ANT} \leq 4$), so the Directional gain=3.64.
 For power spectral density measurements, $N_{ANT} = 4$, $N_{SS} = 1$. So Directional gain = $G_{ANT} + \text{Array Gain} = G_{ANT} + 10\log(N_{ANT}/N_{SS})$ dB = $3.64 + 10\log(4/1)$ dBi=9.66. Then, the power spectral density limit is $30 - (9.66 - 6) = 26.34$.
- 2) Beamforming function, Beamforming Gain: 6dB. So,
 - a) For UNII-1:

The Directional gain= $6 + 4.98 = 10.98$. Then, the average output power limit is $30 - (10.98 - 6) = 25.02$, the power spectral density limit is $17 - (10.98 - 6) = 12.02$.
 - b) For UNII-3:

The Directional gain= $6 + 3.64 = 9.64$. Then, the average output power limit is $30 - (9.64 - 6) = 26.36$, the power spectral density limit is $30 - (9.64 - 6) = 26.36$.

4. Table for Antenna Configuration:

Non Beamforming:

Operating Mode / TX Mode	4TX
IEEE 802.11a	V (Ant. 1 + Ant. 2 + Ant. 3 + Ant. 4)
IEEE 802.11n (HT20)	V (Ant. 1 + Ant. 2 + Ant. 3 + Ant. 4)
IEEE 802.11n (HT40)	V (Ant. 1 + Ant. 2 + Ant. 3 + Ant. 4)
IEEE 802.11ac (VHT20)	V (Ant. 1 + Ant. 2 + Ant. 3 + Ant. 4)
IEEE 802.11ac (VHT40)	V (Ant. 1 + Ant. 2 + Ant. 3 + Ant. 4)
IEEE 802.11ac (VHT80)	V (Ant. 1 + Ant. 2 + Ant. 3 + Ant. 4)

Beamforming:

Operating Mode / TX Mode	4TX
IEEE 802.11n (HT20)	V (Ant. 1 + Ant. 2 + Ant. 3 + Ant. 4)
IEEE 802.11n (HT40)	V (Ant. 1 + Ant. 2 + Ant. 3 + Ant. 4)
IEEE 802.11ac (VHT20)	V (Ant. 1 + Ant. 2 + Ant. 3 + Ant. 4)
IEEE 802.11ac (VHT40)	V (Ant. 1 + Ant. 2 + Ant. 3 + Ant. 4)
IEEE 802.11ac (VHT80)	V (Ant. 1 + Ant. 2 + Ant. 3 + Ant. 4)

2.2 TEST MODES

The test system was pre-tested based on the consideration of all possible combinations of EUT operation mode.

Pretest Mode	Description
Mode 1	TX A Mode / CH36, CH40, CH48 (UNII-1)
Mode 2	TX AC (VHT20) Mode / CH36, CH40, CH48 (UNII-1)
Mode 3	TX AC (VHT40) Mode / CH38, CH46 (UNII-1)
Mode 4	TX AC (VHT80) Mode / CH42 (UNII-1)
Mode 5	TX A Mode / CH149,CH157,CH165 (UNII-3)
Mode 6	TX AC (VHT20) Mode / CH149,CH157,CH165 (UNII-3)
Mode 7	TX AC (VHT40) Mode / CH151,CH159 (UNII-3)
Mode 8	TX AC (VHT80) Mode / CH155 (UNII-3)
Mode 9	TX AC(VHT20) Mode / CH149 (UNII-3)

Following mode(s) was (were) found to be the worst case(s) and selected for the final test.

AC power line conducted emissions test	
Final Test Mode	Description
Mode 9	TX AC(VHT20) Mode / CH149 (UNII-3)

Radiated emissions test - Below 1GHz	
Final Test Mode	Description
Mode 9	TX AC(VHT20) Mode / CH149 (UNII-3)

Radiated emissions test - Above 1GHz_Non Beamforming	
Final Test Mode	Description
Mode 1	TX A Mode / CH36, CH40, CH48 (UNII-1)
Mode 2	TX AC (VHT20) Mode / CH36, CH40, CH48 (UNII-1)
Mode 3	TX AC (VHT40) Mode / CH38, CH46 (UNII-1)
Mode 4	TX AC (VHT80) Mode / CH42 (UNII-1)
Mode 5	TX A Mode / CH149,CH157,CH165 (UNII-3)
Mode 6	TX AC (VHT20) Mode / CH149,CH157,CH165 (UNII-3)
Mode 7	TX AC (VHT40) Mode / CH151,CH159 (UNII-3)
Mode 8	TX AC (VHT80) Mode / CH155 (UNII-3)

Radiated emissions test - Above 1GHz_Beamforming	
Final Test Mode	Description
Mode 2	TX AC (VHT20) Mode / CH36, CH40, CH48 (UNII-1)
Mode 3	TX AC (VHT40) Mode / CH38, CH46 (UNII-1)
Mode 4	TX AC (VHT80) Mode / CH42 (UNII-1)
Mode 6	TX AC (VHT20) Mode / CH149,CH157,CH165 (UNII-3)
Mode 7	TX AC (VHT40) Mode / CH151,CH159 (UNII-3)
Mode 8	TX AC (VHT80) Mode / CH155 (UNII-3)

Output Power & Power spectral density test_Non Beamforming	
Final Test Mode	Description
Mode 1	TX A Mode / CH36, CH40, CH48 (UNII-1)
Mode 2	TX AC (VHT20) Mode / CH36, CH40, CH48 (UNII-1)
Mode 3	TX AC (VHT40) Mode / CH38, CH46 (UNII-1)
Mode 4	TX AC (VHT80) Mode / CH42 (UNII-1)
Mode 5	TX A Mode / CH149,CH157,CH165 (UNII-3)
Mode 6	TX AC (VHT20) Mode / CH149,CH157,CH165 (UNII-3)
Mode 7	TX AC (VHT40) Mode / CH151,CH159 (UNII-3)
Mode 8	TX AC (VHT80) Mode / CH155 (UNII-3)

Output Power & Power spectral density test_Beamforming	
Final Test Mode	Description
Mode 2	TX AC (VHT20) Mode / CH36, CH40, CH48 (UNII-1)
Mode 3	TX AC (VHT40) Mode / CH38, CH46 (UNII-1)
Mode 4	TX AC (VHT80) Mode / CH42 (UNII-1)
Mode 6	TX AC (VHT20) Mode / CH149,CH157,CH165 (UNII-3)
Mode 7	TX AC (VHT40) Mode / CH151,CH159 (UNII-3)
Mode 8	TX AC (VHT80) Mode / CH155 (UNII-3)

Other Conducted test_Non Beamforming	
Final Test Mode	Description
Mode 1	TX A Mode / CH36, CH40, CH48 (UNII-1)
Mode 2	TX AC (VHT20) Mode / CH36, CH40, CH48 (UNII-1)
Mode 3	TX AC (VHT40) Mode / CH38, CH46 (UNII-1)
Mode 4	TX AC (VHT80) Mode / CH42 (UNII-1)
Mode 5	TX A Mode / CH149,CH157,CH165 (UNII-3)
Mode 6	TX AC (VHT20) Mode / CH149,CH157,CH165 (UNII-3)
Mode 7	TX AC (VHT40) Mode / CH151,CH159 (UNII-3)
Mode 8	TX AC (VHT80) Mode / CH155 (UNII-3)

Note:

- (1) For radiated emission below 1 GHz test, the IEEE 802.11ac20 channel 149 is found to be the worst case and recorded.
- (2) For radiated emission above 1 GHz test, 1GHz~26.5GHz and 26.5GHz~40GHz have been pre-tested and in this report only recorded the worst case. The remaining spurious points are all below the limit value of 20dB.
- (3) The measurements for Average Output Power were tested, the Non Beamforming and Beamforming are recorded in the report. The worst case was Non Beamforming and only worst case were documented for other test items except Power Spectral Density and Radiated Emissions above 1GHz.
- (4) VHT20/VHT40 covers HT20/HT40, due to same modulation. The power setting for 802.11n HT20 and HT40 are the same or lower than 802.11ac VHT20 and VHT40.

2.3 PARAMETERS OF TEST SOFTWARE

Non Beamforming

UNII-1			
Test Software	N/A		
Test Frequency (MHz)	5180	5200	5240
IEEE 802.11a	2	2	2
IEEE 802.11ac (VHT20)	2	2	3
Test Frequency (MHz)	5190	5230	
IEEE 802.11ac (VHT40)	5	7	
Test Frequency (MHz)	5210		
IEEE 802.11ac (VHT80)	-5		

UNII-3			
Test Software	N/A		
Test Frequency (MHz)	5745	5785	5825
IEEE 802.11a	10	10	10
IEEE 802.11ac (VHT20)	10	10	10
Test Frequency (MHz)	5755	5795	
IEEE 802.11ac (VHT40)	9	10	
Test Frequency (MHz)	5775		
IEEE 802.11ac (VHT80)	11		

Beamforming

UNII-1			
Test Software	N/A		
Test Frequency (MHz)	5180	5200	5240
IEEE 802.11ac (VHT20)	-1	-1	0
Test Frequency (MHz)	5190	5230	
IEEE 802.11ac (VHT40)	-1	0	
Test Frequency (MHz)	5210		
IEEE 802.11ac (VHT80)	-10		

UNII-3			
Test Software	N/A		
Test Frequency (MHz)	5745	5785	5825
IEEE 802.11ac (VHT20)	4	5	5
Test Frequency (MHz)	5755	5795	
IEEE 802.11ac (VHT40)	4	5	
Test Frequency (MHz)	5775		
IEEE 802.11ac (VHT80)	5		

2.4 DUTY CYCLE

If duty cycle is $\geq 98\%$, duty factor is not required.

If duty cycle is $< 98\%$, duty factor shall be considered.

The output power = measured power + duty factor.

The power spectral density = measured power spectral density + duty factor.

IEEE 802.11a

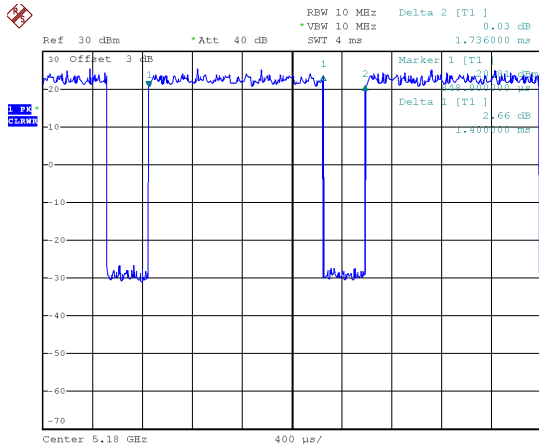

Date: 3.APR.2020 09:30:20

Duty cycle = 1.400 ms / 1.736 ms = 80.65%
 Duty Factor = $10 \log(1 / \text{Duty cycle}) = 0.93$

IEEE 802.11ac (VHT20)

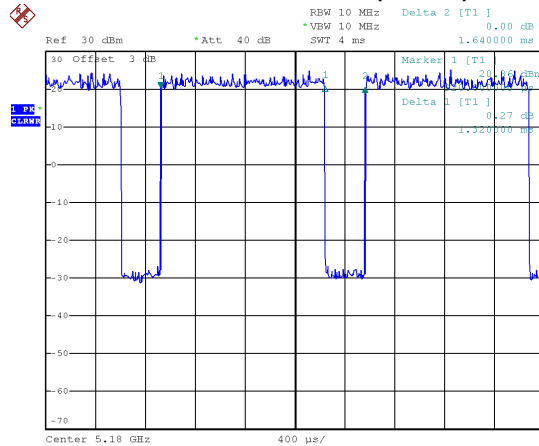

Date: 3.APR.2020 09:31:40

Duty cycle = 1.320 ms / 1.640 ms = 80.49%
 Duty Factor = $10 \log(1 / \text{Duty cycle}) = 0.94$

IEEE 802.11ac (VHT40)

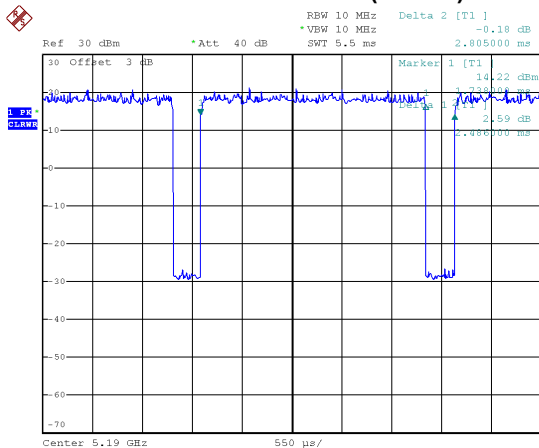

Date: 3.APR.2020 09:33:47

Duty cycle = 2.486 ms / 2.805 ms = 88.63%
 Duty Factor = $10 \log(1 / \text{Duty cycle}) = 0.52$

IEEE 802.11ac (VHT80)

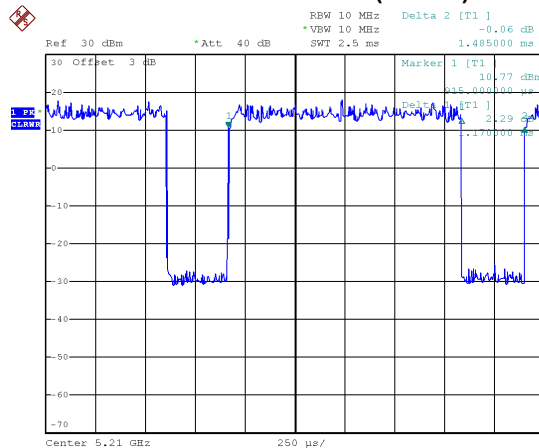

Date: 3.APR.2020 09:34:42

Duty cycle = 1.170 ms / 1.485 ms = 78.79%
 Duty Factor = $10 \log(1 / \text{Duty cycle}) = 1.04$

NOTE:

For IEEE 802.11a, IEEE 802.11n (HT20) and IEEE 802.11ac (VHT20):

For radiated emissions frequency above 1 GHz, the resolution bandwidth of test receiver/spectrum analyzer is 1 MHz and the video bandwidth is 1 kHz (Duty cycle $< 98\%$).

For IEEE 802.11n (HT40) and IEEE 802.11ac (VHT40):

For radiated emissions frequency above 1 GHz, the resolution bandwidth of test receiver/spectrum analyzer is 1 MHz and the video bandwidth is 2 kHz (Duty cycle $< 98\%$).

For IEEE 802.11ac (VHT80):

For radiated emissions frequency above 1 GHz, the resolution bandwidth of test receiver/spectrum analyzer is 1 MHz and the video bandwidth is 3 kHz (Duty cycle $< 98\%$).

2.5 BLOCK DIAGRAM SHOWING THE CONFIGURATION OF SYSTEM TESTED

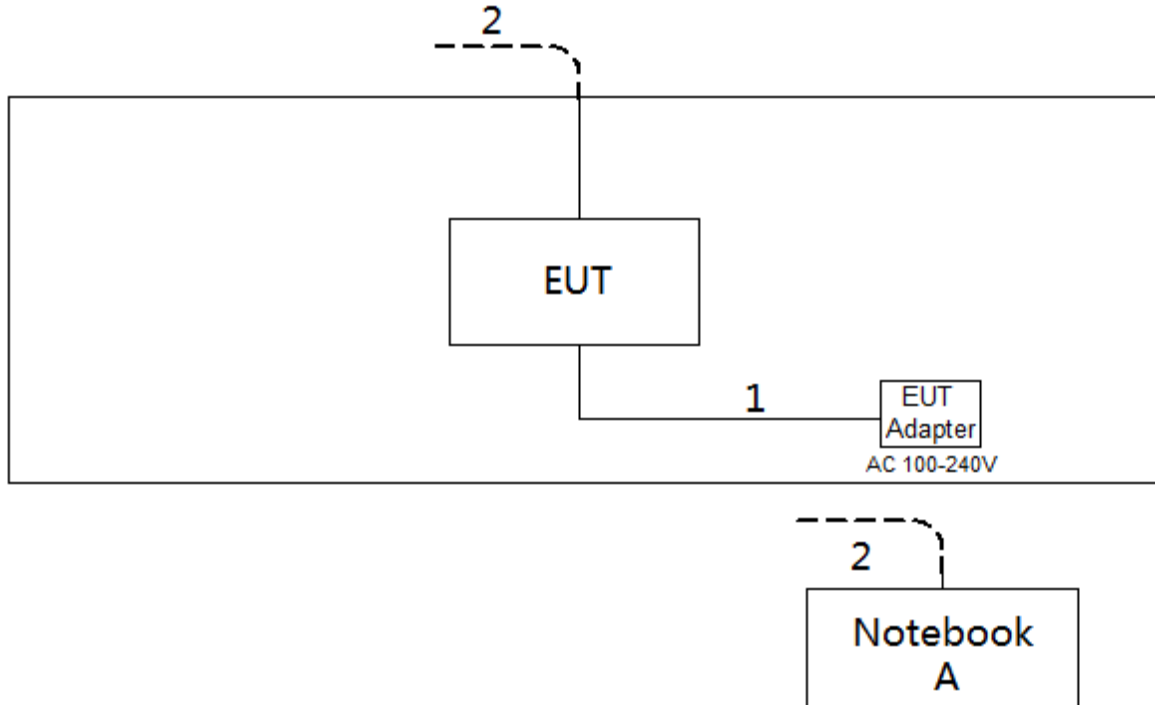

2.6 SUPPORT UNITS

Item	Equipment	Brand	Model No.	Series No.
A	Notebook	Dell	Inspiron 15-7559	N/A

Item	Cable Type	Shielded Type	Ferrite Core	Length
1	DC Cable	NO	NO	1.5m
2	RJ45 Cable	NO	NO	10m

3. AC POWER LINE CONDUCTED EMISSIONS TEST

3.1 LIMIT

Frequency (MHz)	Limit (dB μ V)	
	Quasi-peak	Average
0.15 - 0.5	66 to 56*	56 to 46*
0.5 - 5.0	56	46
5.0 - 30.0	60	50

NOTE:

- (1) The tighter limit applies at the band edges.
- (2) The limit of " * " marked band means the limitation decreases linearly with the logarithm of the frequency in the range.

The following table is the setting of the receiver

Receiver Parameter	Setting
Attenuation	10 dB
Start Frequency	0.15 MHz
Stop Frequency	30 MHz
IF Bandwidth	9 KHz

3.2 TEST PROCEDURE

- a. The EUT was placed 0.8 meters from the horizontal ground plane with EUT being connected to the power mains through a line impedance stabilization network (LISN). All other support equipment powered from additional LISN(s). The LISN provide 50 Ohm/ 50uH of coupling impedance for the measuring instrument.
- b. Interconnecting cables that hang closer than 40 cm to the ground plane shall be folded back and forth in the center forming a bundle 30 to 40 cm long.
- c. I/O cables that are not connected to a peripheral shall be bundled in the center. The end of the cable may be terminated, if required, using the correct terminating impedance. The overall length shall not exceed 1 m.
- d. LISN at least 80 cm from nearest part of EUT chassis.
- e. For the actual test configuration, please refer to the related Item -EUT Test Photos.

3.3 DEVIATION FROM TEST STANDARD

No deviation

3.4 TEST SETUP

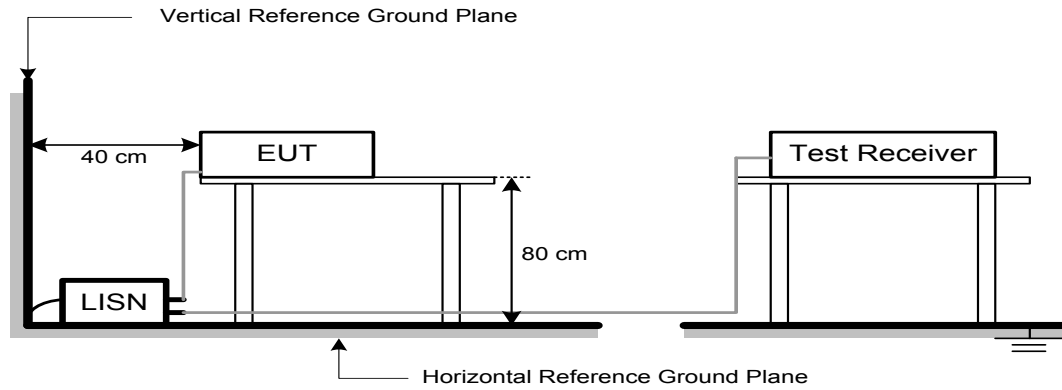

3.5 EUT OPERATION CONDITIONS

The EUT was configured for testing in a typical fashion (as a customer would normally use it). The EUT has been programmed to continuously transmit during test. This operating condition was tested and used to collect the included data.

The EUT was programmed to be in continuously transmitting/TX mode.

3.6 TEST RESULTS

Please refer to the APPENDIX A.

4. RADIATED EMISSIONS TEST

4.1 LIMIT

In case the emission fall within the restricted band specified on 15.205(a), then the 15.209(a) limit in the table below has to be followed.

LIMITS OF RADIATED EMISSIONS MEASUREMENT (9 kHz to 1000 MHz)

Frequency (MHz)	Field Strength (microvolts/meter)	Measurement Distance (meters)
0.009-0.490	2400/F(kHz)	300
0.490-1.705	24000/F(kHz)	30
1.705-30.0	30	30
30-88	100	3
88-216	150	3
216-960	200	3
Above 960	500	3

LIMITS OF UNWANTED EMISSION OUT OF THE RESTRICTED BANDS

Frequency (MHz)	EIRP Limit (dBm/MHz)	Equivalent Field Strength at 3m (dBμV/m)
5150-5250	-27	68.3
5725-5850	-27 NOTE (2)	68.3
	10 NOTE (2)	105.3
	15.6 NOTE (2)	110.9
	27 NOTE (2)	122.3

NOTE:

(1) The following formula is used to convert the equipment isotropic radiated power (eirp) to field strength:

$$E = \frac{1000000\sqrt{30P}}{3} \mu\text{V/m, where } P \text{ is the eirp (Watts)}$$

(2) According to 15.407(b)(4)(i), all emissions shall be limited to a level of -27 dBm/MHz at 75 MHz or more above or below the band edge increasing linearly to 10 dBm/MHz at 25 MHz above or below the band edge, and from 25 MHz above or below the band edge increasing linearly to a level of 15.6 dBm/MHz at 5 MHz above or below the band edge, and from 5 MHz above or below the band edge increasing linearly to a level of 27 dBm/MHz at the band edge.

4.2 TEST PROCEDURE

- a. The measuring distance of 3 m shall be used for measurements. The EUT was placed on the top of a rotating table 0.8 meter above the ground at a 3 meter semi-anechoic chamber. The table was rotated 360 degrees to determine the position of the highest radiation.(below 1GHz)
- b. The measuring distance of 3 m shall be used for measurements. The EUT was placed on the top of a rotating table 1.5 meter above the ground at a 3 meter semi-anechoic chamber. The table was rotated 360 degrees to determine the position of the highest radiation.(above 1GHz)
- c. The height of the equipment or of the substitution antenna shall be 0.8m or 1.5m; the height of the test antenna shall vary between 1 m to 4 m. Both horizontal and vertical polarizations of the antenna are set to make the measurement.
- d. For each suspected emission, the EUT was arranged to its worst case and then the antenna was tuned to heights find the maximum reading (used Bore sight function).
- e. The receiver system was set to peak and average detect function and specified bandwidth with maximum hold mode when the test frequency is above 1 GHz.
- f. The initial step in collecting radiated emission data is a receiver peak detector mode pre-scanning the measurement frequency range. Significant peaks are then marked and then Quasi Peak detector mode re-measured.
- g. All readings are Peak unless otherwise stated QP in column of Note. Peak denotes that the Peak reading compliance with the QP Limits and then QP Mode measurement didn't perform. (below 1 GHz)
- h. All readings are Peak Mode value unless otherwise stated AVG in column of Note. If the Peak Mode Measured value compliance with the Peak Limits and lower than AVG Limits, the EUT shall be deemed to meet both Peak & AVG Limits and then only Peak Mode was measured, but AVG Mode didn't perform. (above 1 GHz)
- i. For the actual test configuration, please refer to the related Item – EUT Test Photos.

4.3 DEVIATION FROM TEST STANDARD

No deviation

4.4 TEST SETUP

9 kHz to 30 MHz

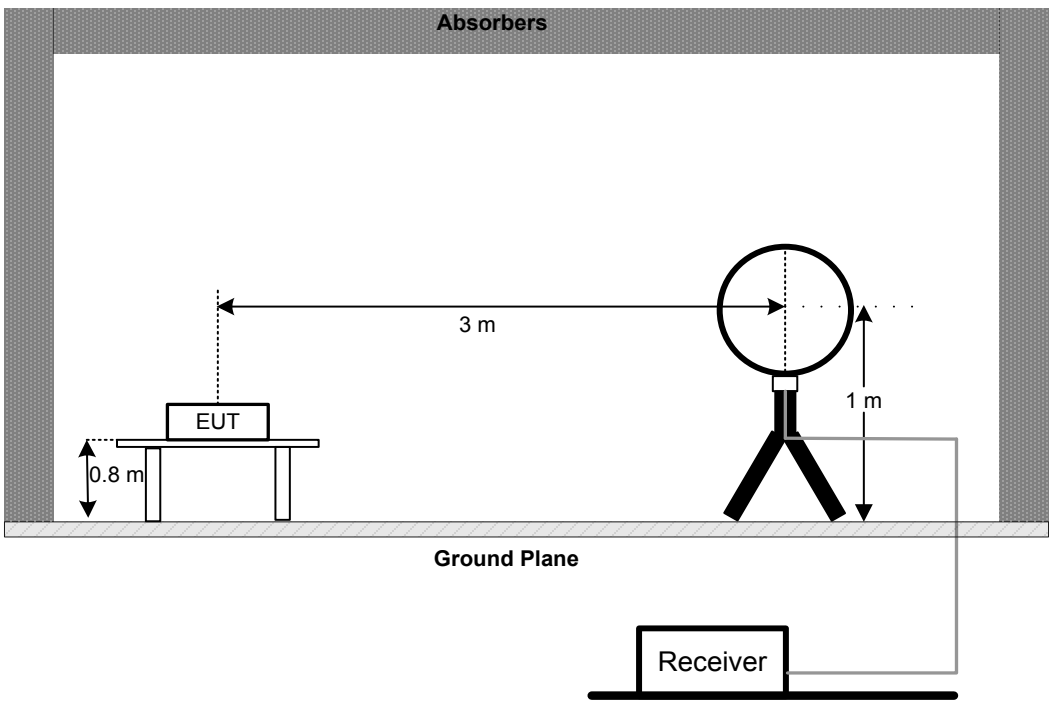

30 MHz to 1 GHz

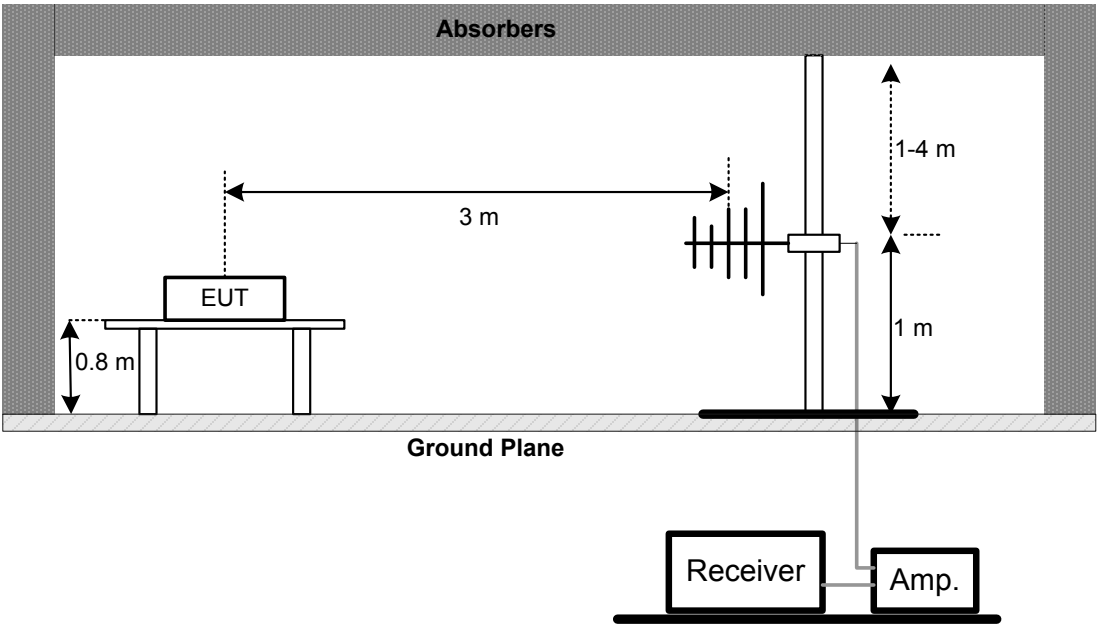

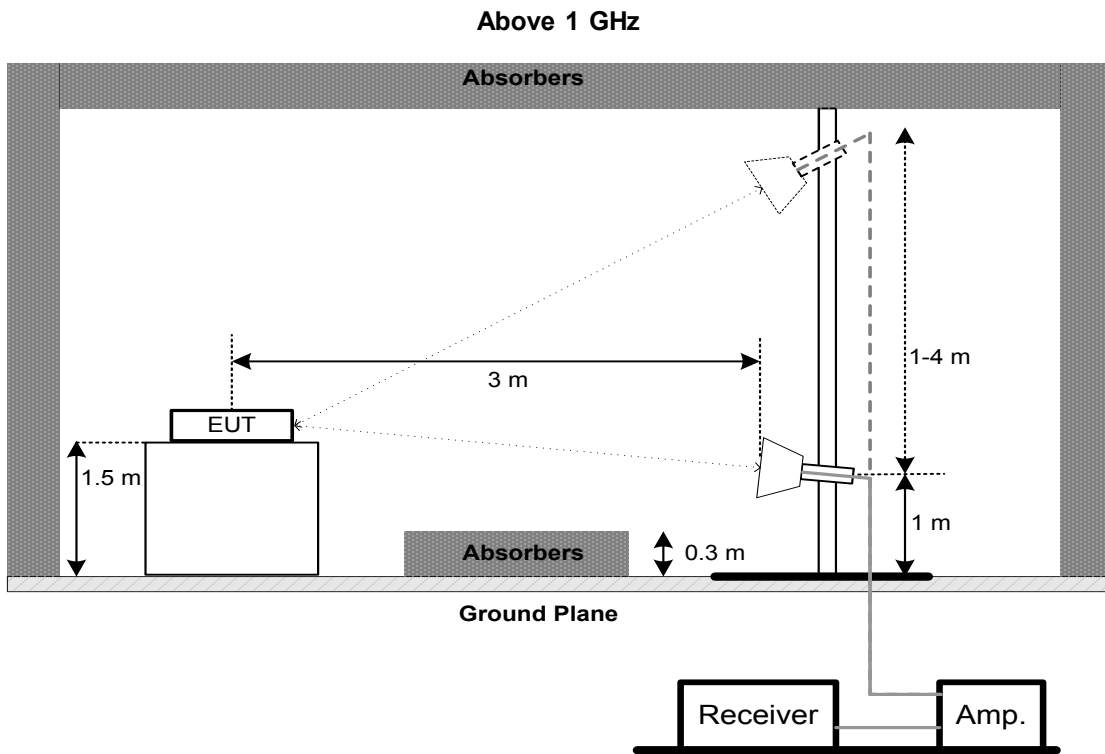

4.5 EUT OPERATION CONDITIONS

The EUT tested system was configured as the statements of 3.5 unless otherwise a special operating condition is specified in the follows during the testing.

4.6 TEST RESULTS - 9 KHZ to 30 MHZ

Please refer to the APPENDIX B

Remark:

- (1) Distance extrapolation factor = $40 \log(\text{specific distance} / \text{test distance})$ (dB).
- (2) Limit line = specific limits (dBuV) + distance extrapolation factor.

4.7 TEST RESULTS - 30 MHz TO 1000 MHz

Please refer to the APPENDIX C.

4.8 TEST RESULTS - ABOVE 1000 MHz

Please refer to the APPENDIX D.

Remark:

- (1) No limit: This is fundamental signal, the judgment is not applicable.
For fundamental signal judgment was referred to Peak output test.

5. BANDWIDTH TEST

5.1 LIMIT

FCC Part15, Subpart E (15.407)			
Section	Test Item	Limit	Frequency Range (MHz)
15.407(a)	26 dB Bandwidth	-	5150-5250
15.407(e)	6 dB Bandwidth	Minimum 500 kHz	5725-5850

5.2 TEST PROCEDURE

- a. The EUT was directly connected to the spectrum analyzer and antenna output port as show in the block diagram below
- b. Spectrum Setting:

For UNII-1:

Spectrum Parameter	Setting
Attenuation	Auto
Span Frequency	> 26 dB Bandwidth
RBW	300 kHz (Bandwidth 20 MHz & Bandwidth 40 MHz) 1 MHz (Bandwidth 80 MHz)
VBW	1 MHz (Bandwidth 20 MHz & Bandwidth 40 MHz) 3 MHz (Bandwidth 80 MHz)
Detector	Peak
Trace	Max Hold
Sweep Time	Auto

For UNII-3:

Spectrum Parameter	Setting
Attenuation	Auto
Span Frequency	6 dB Bandwidth
RBW	100 kHz
VBW	300 kHz
Detector	Peak
Trace	Max Hold
Sweep Time	Auto

- c. Measured the spectrum width with power higher than 26 dB / 6 dB below carrier.

5.3 DEVIATION FROM STANDARD

No deviation.

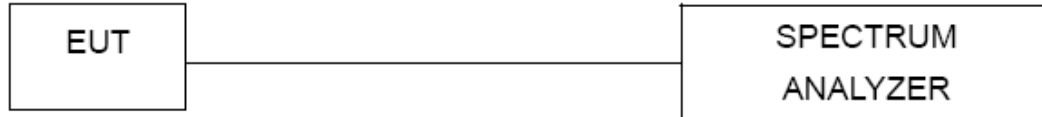
5.4 TEST SETUP**5.5 EUT OPERATION CONDITIONS**

The EUT was programmed to be in continuously transmitting mode.

5.6 TEST RESULTS

Please refer to the APPENDIX E.

6. MAXIMUM OUTPUT POWER TEST

6.1 LIMIT

FCC Part15, Subpart E (15.407)			
Section	Test Item	Limit	Frequency Range (MHz)
15.407(a)	Maximum Output Power	AP device: 1 Watt (30 dBm) Client device: 250 mW (24 dBm)	5150-5250
		1 Watt (30dBm)	5725-5850

Note:

- a. For an indoor access point operating in the band 5.15-5.25 GHz, the maximum conducted output power over the frequency band of operation shall not exceed 1 W provided the maximum antenna gain does not exceed 6 dBi. In addition, the maximum power spectral density shall not exceed 17 dBm in any 1 megahertz band. If transmitting antennas of directional gain greater than 6 dBi are used, both the maximum conducted output power and the maximum power spectral density shall be reduced by the amount in dB that the directional gain of the antenna exceeds 6 dBi.

6.2 TEST PROCEDURE

- a. The EUT was directly connected to the power meter and antenna output port as show in the block diagram below.
- b. Test test was performed in accordance with method of FCC KDB 789033 D02 General UNII Test Procedures New Rules v02r01.

6.3 DEVIATION FROM STANDARD

No deviation.

6.4 TEST SETUP

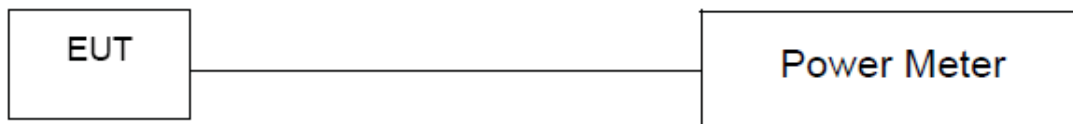

6.5 EUT OPERATION CONDITIONS

The EUT was programmed to be in continuously transmitting mode.

6.6 TEST RESULTS

Please refer to the APPENDIX F.

7. POWER SPECTRAL DENSITY TEST

7.1 LIMIT

FCC Part15, Subpart E (15.407)			
Section	Test Item	Limit	Frequency Range (MHz)
15.407(a)	Power Spectral Density	AP device: 17 dBm/MHz Client device: 11 dBm/MHz	5150-5250
		30 dBm/500 kHz	5725-5850

7.2 TEST PROCEDURE

- The EUT was directly connected to the spectrum analyzer and antenna output port as show in the block diagram below.
- Spectrum Setting:

Spectrum Parameter	Setting
Attenuation	Auto
Span Frequency	Encompass the entire emissions bandwidth (EBW) of the signal
RBW	= 1 MHz.
VBW	≥ 3 MHz.
Detector	RMS
Trace average	100 trace
Sweep Time	Auto

Note:

- For UNII-3, according to KDB publication 789033 D02 General UNII Test Procedures New Rules v02r01, section II.F.5., it is acceptable to set RBW at 1 MHz and VBW at 3 MHz if the spectrum analyzer does not have 500 kHz RBW.
- The value measured with RBW=100kHz is to be added with $10\log(500 \text{ kHz}/100\text{kHz})$ which is +7 dB. For example, if the measured value is +10dBm using RBW=100kHz (that is +10 dBm/MHz), then the converted value will be +17dBm/500kHz.

7.3 DEVIATION FROM STANDARD

No deviation.

7.4 TEST SETUP

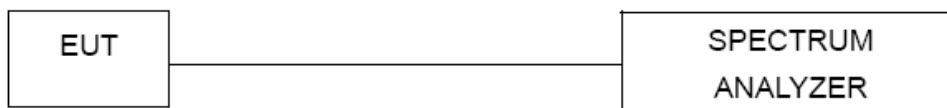

7.5 EUT OPERATION CONDITIONS

The EUT was programmed to be in continuously transmitting mode.

7.6 TEST RESULTS

Please refer to the APPENDIX G.

8. FREQUENCY STABILITY MEASUREMENT

8.1 LIMIT

FCC Part15, Subpart E (15.407)			
Section	Test Item	Limit	Frequency Range (MHz)
15.407(g)	Frequency Stability	An emission is maintained within the band of operation under all conditions of normal operation as specified in the users manual.	5150-5250
			5725-5850

8.2 TEST PROCEDURE

- a. The EUT was directly connected to the spectrum analyzer and antenna output port as show in the block diagram below.
- b. Spectrum Setting:

Spectrum Parameter	Setting
Attenuation	Auto
Span Frequency	Entire absence of modulation emissions bandwidth
RBW	10 kHz
VBW	10 kHz
Sweep Time	Auto

- c. The test extreme voltage is to change the primary supply voltage from 85 to 115 percent of the nominal value.
- d. User manual temperature is 0°C~40°C.

8.3 DEVIATION FROM STANDARD

No deviation.

8.4 TEST SETUP

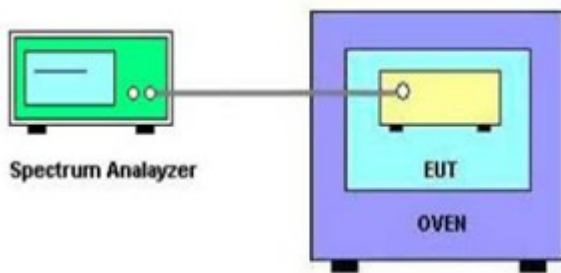

8.5 EUT OPERATION CONDITIONS

The EUT was programmed to be in continuously transmitting mode.

8.6 TEST RESULTS

Please refer to the APPENDIX H.

9. MEASUREMENT INSTRUMENTS LIST

AC Power Line Conducted Emissions					
Item	Kind of Equipment	Manufacturer	Type No.	Serial No.	Calibrated until
1	EMI Test Receiver	R&S	ESCI	100382	Feb. 28, 2021
2	LISN	EMCO	3816/2	52765	Mar. 01, 2021
3	TWO-LINE V-NETWORK	R&S	ENV216	101447	Feb. 28, 2021
4	50Ω Terminator	SHX	TF5-3	15041305	Mar. 01, 2021
5	Measurement Software	Farad	EZ-EMC Ver.NB-03A1-01	N/A	N/A
6	Cable	N/A	RG223	12m	Mar. 10, 2021

Radiated Emissions - 9 kHz to 30 MHz					
Item	Kind of Equipment	Manufacturer	Type No.	Serial No.	Calibrated until
1	Antenna	EM	EM-6876-1	230	Apr. 16, 2021
2	Cable	N/A	RG 213/U	N/A	May 29, 2021
3	EMI Test Receiver	R&S	ESCI	100895	Feb. 28, 2021
4	Measurement Software	Farad	EZ-EMC Ver.NB-03A1-01	N/A	N/A

Radiated Emissions - 30 MHz to 1 GHz					
Item	Kind of Equipment	Manufacturer	Type No.	Serial No.	Calibrated until
1	Antenna	Schwarzbeck	VULB9160	9160-3232	Mar. 09, 2021
2*	Amplifier	HP	8447D	2944A09673	Aug. 11, 2021
3	Receiver	Agilent	N9038A	MY52130039	Aug. 03, 2020
4	Cable	emci	LMR-400(30MHz-1 GHz)(8m+5m)	N/A	May 22, 2021
5	Controller	CT	SC100	N/A	N/A
6	Controller	MF	MF-7802	MF780208416	N/A
7	Measurement Software	Farad	EZ-EMC Ver.NB-03A1-01	N/A	N/A

Radiated Emissions - Above 1 GHz					
Item	Kind of Equipment	Manufacturer	Type No.	Serial No.	Calibrated until
1	Double Ridged Guide Antenna	ETS	3115	75789	May 12, 2021
2	Broad-Band Horn Antenna	Schwarzbeck	BBHA 9170	9170319	Jun. 22, 2021
3	Amplifier	Agilent	8449B	3008A02333	Mar. 01, 2021
4	Microwave Preamplifier With Adaptor	EMC INSTRUMENT	EMC2654045	980039 & HA01	Mar. 07, 2021
5	Receiver	Agilent	N9038A	MY52130039	Aug. 03, 2020
6	Controller	CT	SC100	N/A	N/A
7	Controller	MF	MF-7802	MF780208416	N/A
8	Cable	N/A	EMC104-SM-SM-6 000	N/A	May 09, 2021
9	Measurement Software	Farad	EZ-EMC Ver.NB-03A1-01	N/A	N/A

Bandwidth					
Item	Kind of Equipment	Manufacturer	Type No.	Serial No.	Calibrated until
1	Spectrum Analyzer	R&S	FSP40	100185	Aug. 03, 2020

Power Spectral Density					
Item	Kind of Equipment	Manufacturer	Type No.	Serial No.	Calibrated until
1	EXA Spectrum Analyzer	Agilent	N9010A	MY55150209	Mar. 01, 2021
2	Spectrum Analyzer	R&S	FSP40	100185	Aug. 03, 2020

Maximum Output Power					
Item	Kind of Equipment	Manufacturer	Type No.	Serial No.	Calibrated until
1	Peak Power Analyzer	Keysight	8990B	MY51000506	Aug. 03, 2020
2	Wideband power sensor	Keysight	N1923A	MY58310004	Aug. 03, 2020

Frequency Stability					
Item	Kind of Equipment	Manufacturer	Type No.	Serial No.	Calibrated until
1	Spectrum Analyzer	R&S	FSP40	100185	Aug. 03, 2020
2	Const Temp. & Humidity Chamber	CEPREI	CEEC-M64T-40	15-008	Feb. 28, 2021

Remark: "N/A" denotes no model name, serial no. or calibration specified.

"*" calibration period of equipment list is three year.

Except * item, all calibration period of equipment list is one year.

10. EUT TEST PHOTOS**AC Power Line Conducted Emissions Test Photos**

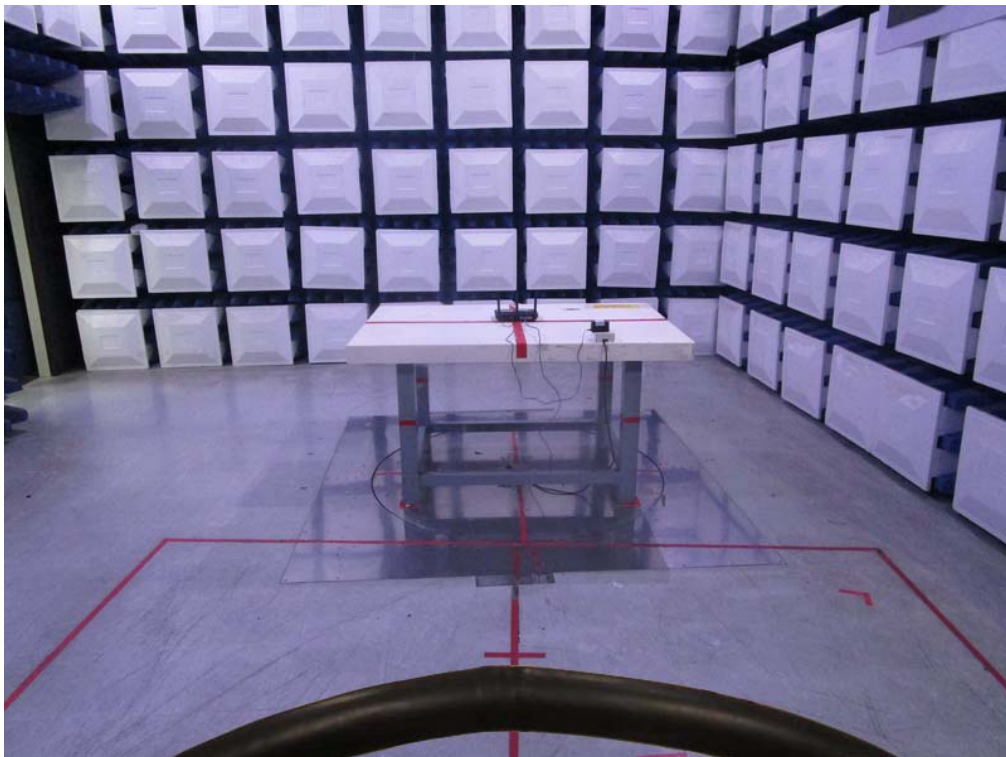
Radiated Emissions Test Photos**9 kHz to 30 MHz**

Radiated Emissions Test Photos**30 MHz to 1 GHz**

Radiated Emissions Test Photos**Above 1 GHz**

APPENDIX A - AC POWER LINE CONDUCTED EMISSIONS

Test Mode: TX AC20 MODE CHANNEL 149

Line

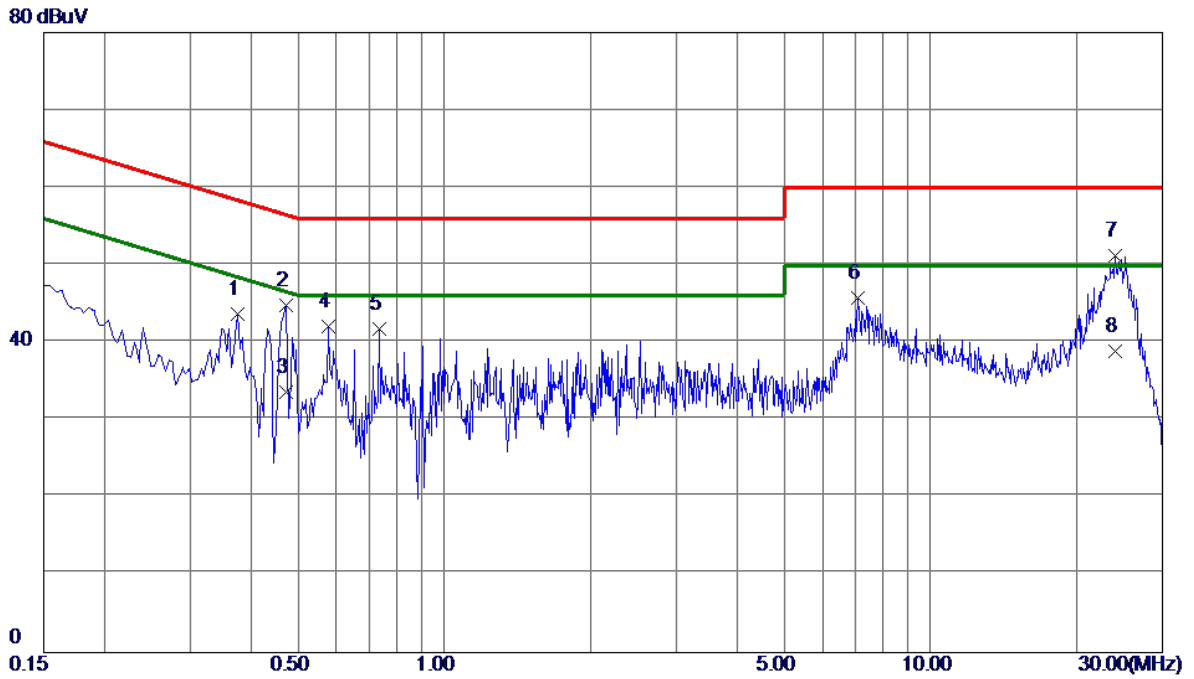

No.	Freq. MHz	Reading Level dBuV	Correct Factor dB	Measure ment dBuV	Limit dBuV	Margin dB	Detector	Comment
1	0.3750	33.83	9.91	43.74	58.39	-14.65	Peak	
2	0.4740	34.91	9.94	44.85	56.44	-11.59	Peak	
3	0.4740	23.70	9.94	33.64	46.44	-12.80	AVG	
4	0.5775	32.10	9.96	42.06	56.00	-13.94	Peak	
5	0.7350	31.80	9.91	41.71	56.00	-14.29	Peak	
6	7.1115	35.22	10.49	45.71	60.00	-14.29	Peak	
7 *	23.9325	40.22	11.02	51.24	60.00	-8.76	Peak	
8	23.9325	27.90	11.02	38.92	50.00	-11.08	AVG	

REMARKS:

- (1) Measurement Value = Reading Level + Correct Factor.
- (2) Margin Level = Measurement Value - Limit Value.
- (3) The test result has included the cable loss.

Test Mode: TX AC20 MODE CHANNEL 149

Neutral

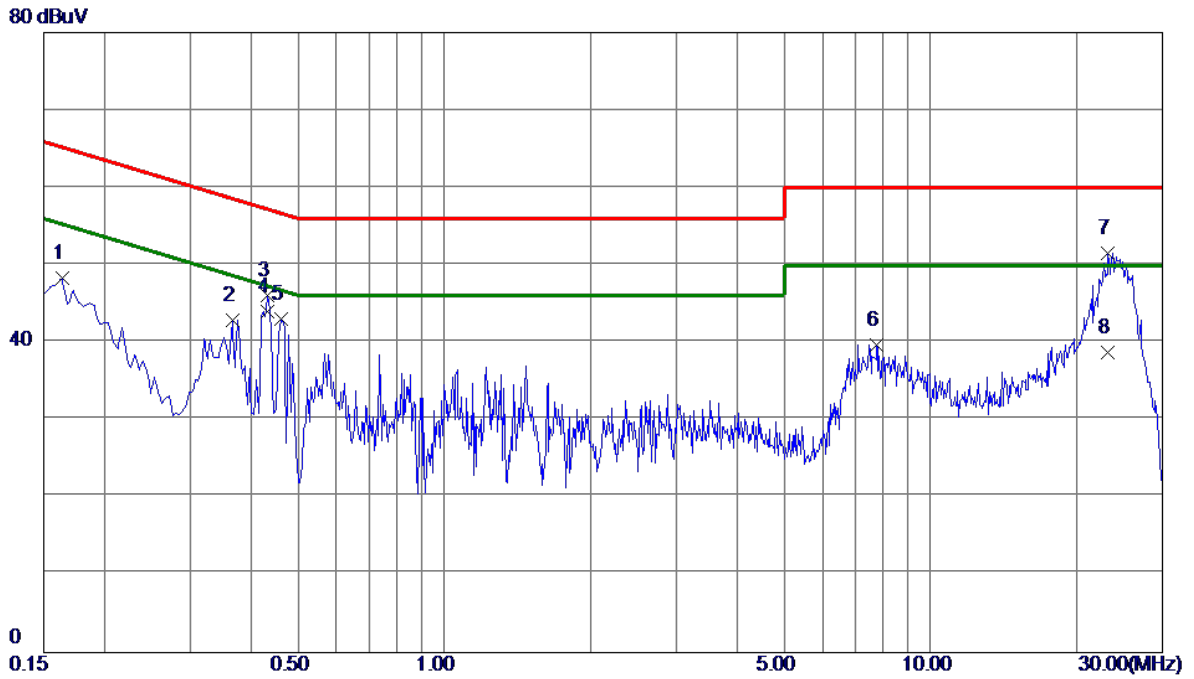

No.	Freq. MHz	Reading Level dBuV	Correct Factor dB	Measurement dBuV	Limit dBuV	Margin dB	Detector	Comment
1	0.1635	38.52	9.85	48.37	65.28	-16.91	Peak	
2	0.3660	32.78	10.06	42.84	58.59	-15.75	Peak	
3	0.4335	35.92	10.11	46.03	57.19	-11.16	Peak	
4 *	0.4335	33.89	10.11	44.00	47.19	-3.19	AVG	
5	0.4605	32.94	10.12	43.06	56.68	-13.62	Peak	
6	7.7370	28.79	10.88	39.67	60.00	-20.33	Peak	
7	23.1585	40.24	11.31	51.55	60.00	-8.45	Peak	
8	23.1585	27.40	11.31	38.71	50.00	-11.29	AVG	

REMARKS:

- (1) Measurement Value = Reading Level + Correct Factor.
- (2) Margin Level = Measurement Value - Limit Value.
- (3) The test result has included the cable loss.

APPENDIX B - RADIATED EMISSION - 9 KHZ TO 30 MHZ

Test Mode: TX AC20 MODE CHANNEL 149

Ant 0°

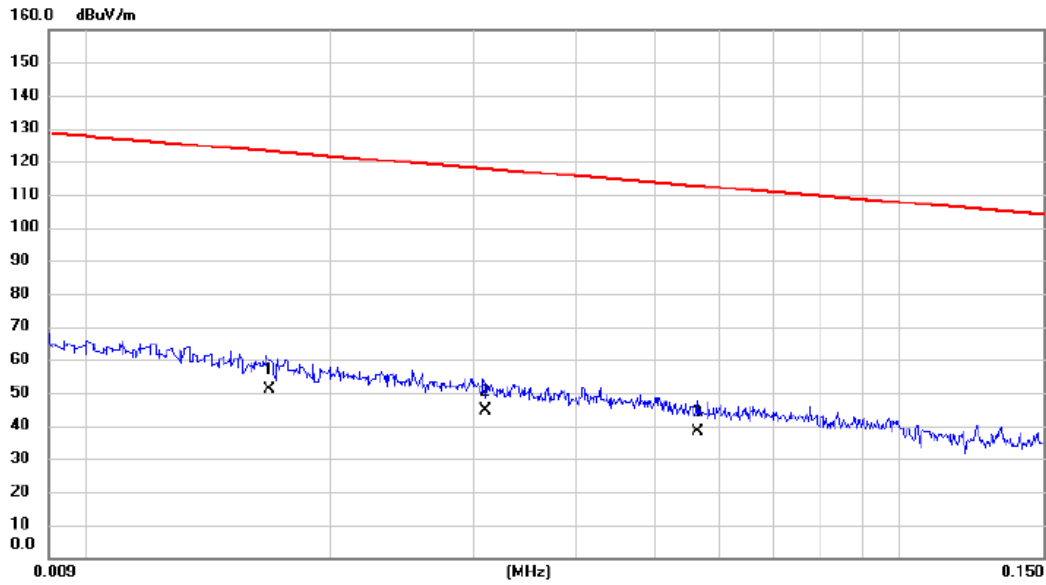

No.	Mk.	Freq. MHz	Reading Level dBuV	Correct Factor dB	Measure- ment dBuV/m	Limit dBuV/m	Margin dB	Detector	Comment
1	*	0.017	36.20	14.78	50.98	123.10	-72.12	AVG	
2		0.031	30.60	13.86	44.46	117.78	-73.32	AVG	
3		0.057	24.30	13.83	38.13	112.56	-74.43	AVG	

REMARKS:

- (1) Measurement Value = Reading Level + Correct Factor.
- (2) Margin Level = Measurement Value - Limit Value.

Test Mode: TX AC20 MODE CHANNEL 149

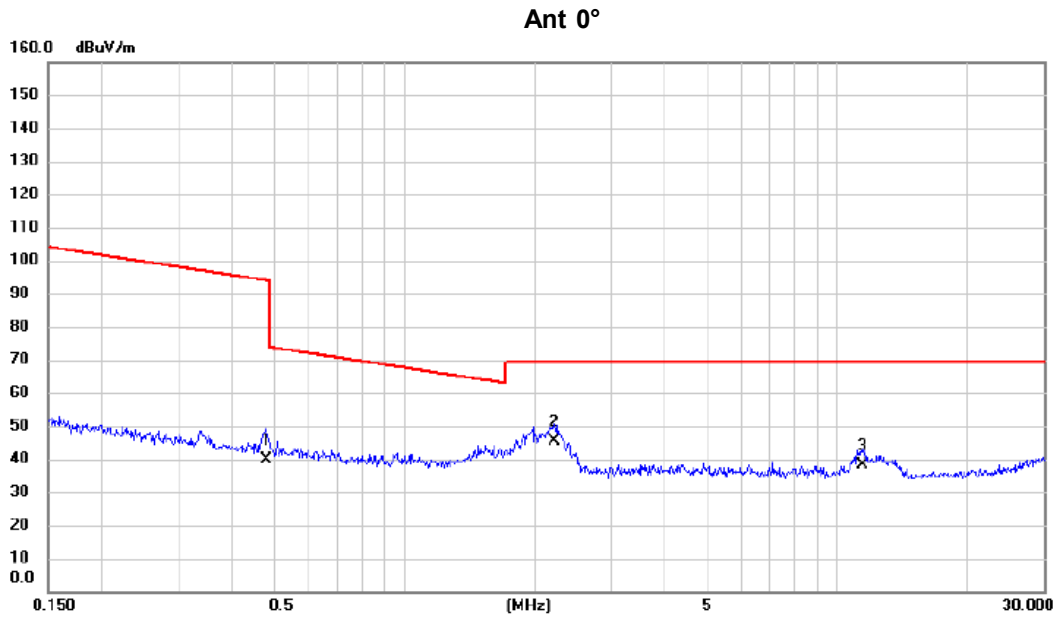

No.	Mk.	Freq. MHz	Reading Level dBuV	Correct Factor dB	Measure- ment dBuV/m	Limit dBuV/m	Margin dB	Detector	Comment
1		0.479	26.50	13.11	39.61	94.00	-54.39	AVG	
2	*	2.225	33.91	11.68	45.59	69.54	-23.95	QP	
3		11.438	26.70	11.61	38.31	69.54	-31.23	QP	

REMARKS:

- (1) Measurement Value = Reading Level + Correct Factor.
- (2) Margin Level = Measurement Value - Limit Value.

Test Mode: TX AC20 MODE CHANNEL 149

Ant 90°

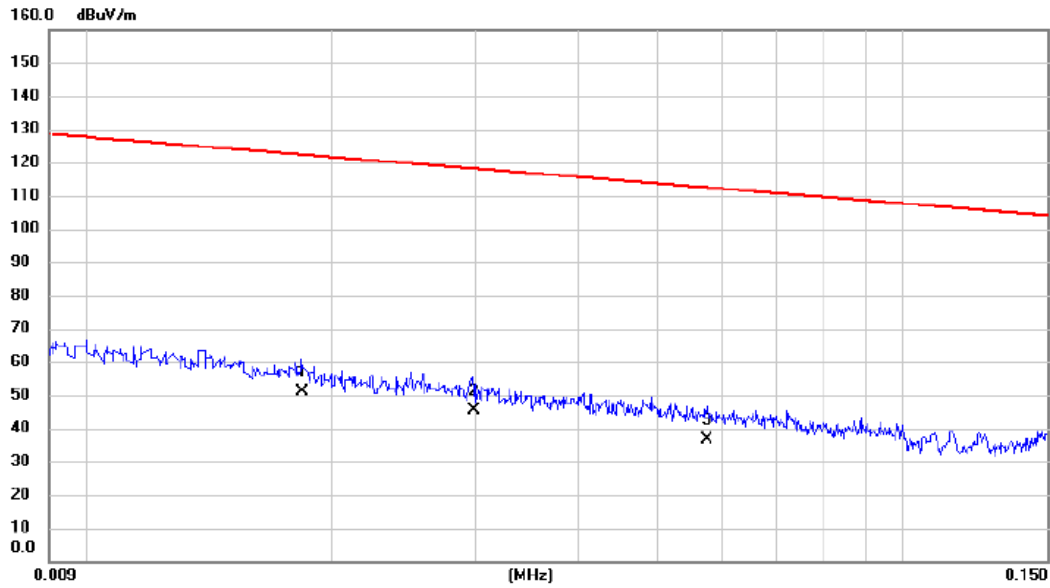

No.	Mk.	Freq.	Reading Level	Correct Factor	Measurement	Limit	Margin		
		MHz	dBuV	dB	dBuV/m	dBuV/m	dB	Detector	Comment
1	*	0.018	36.70	14.30	51.00	122.31	-71.31	AVG	
2		0.030	31.60	13.85	45.45	118.12	-72.67	AVG	
3		0.058	22.80	13.81	36.61	112.40	-75.79	AVG	

REMARKS:

- (1) Measurement Value = Reading Level + Correct Factor.
- (2) Margin Level = Measurement Value - Limit Value.

Test Mode: TX AC20 MODE CHANNEL 149

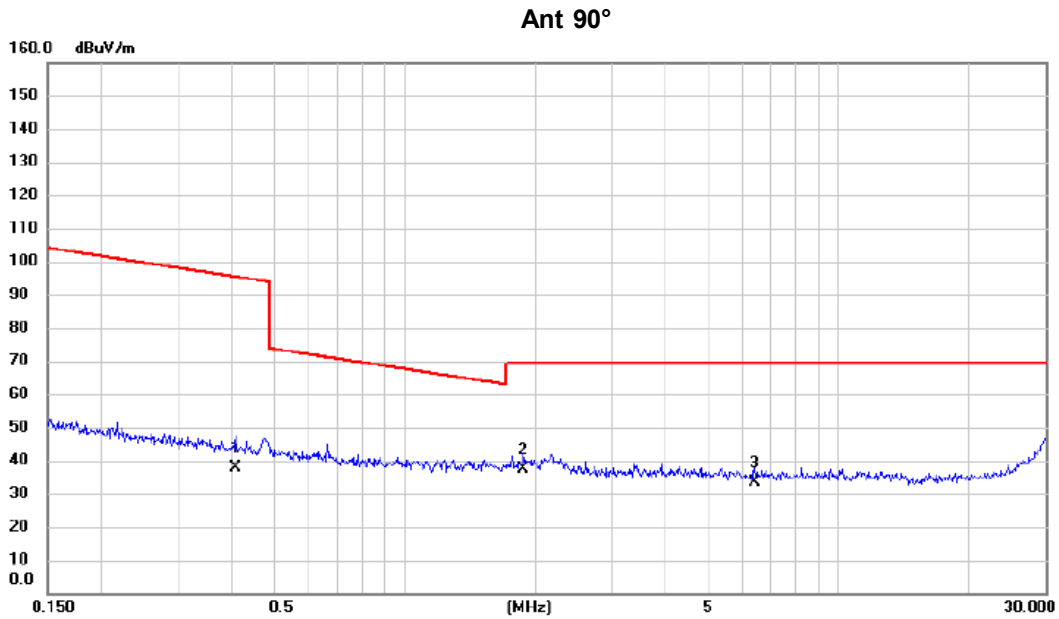

No.	Mk.	Freq. MHz	Reading Level dBuV	Correct Factor dB	Measure- ment dBuV/m	Limit dBuV/m	Margin dB	Detector	Comment
1		0.408	24.50	13.28	37.78	95.38	-57.60	AVG	
2	*	1.878	25.50	11.90	37.40	69.54	-32.14	QP	
3		6.420	22.30	11.08	33.38	69.54	-36.16	QP	

REMARKS:

- (1) Measurement Value = Reading Level + Correct Factor.
- (2) Margin Level = Measurement Value - Limit Value.

APPENDIX C - RADIATED EMISSION - 30 MHZ TO 1 GHZ

Test Mode: TX AC20 MODE CHANNEL 149

Vertical

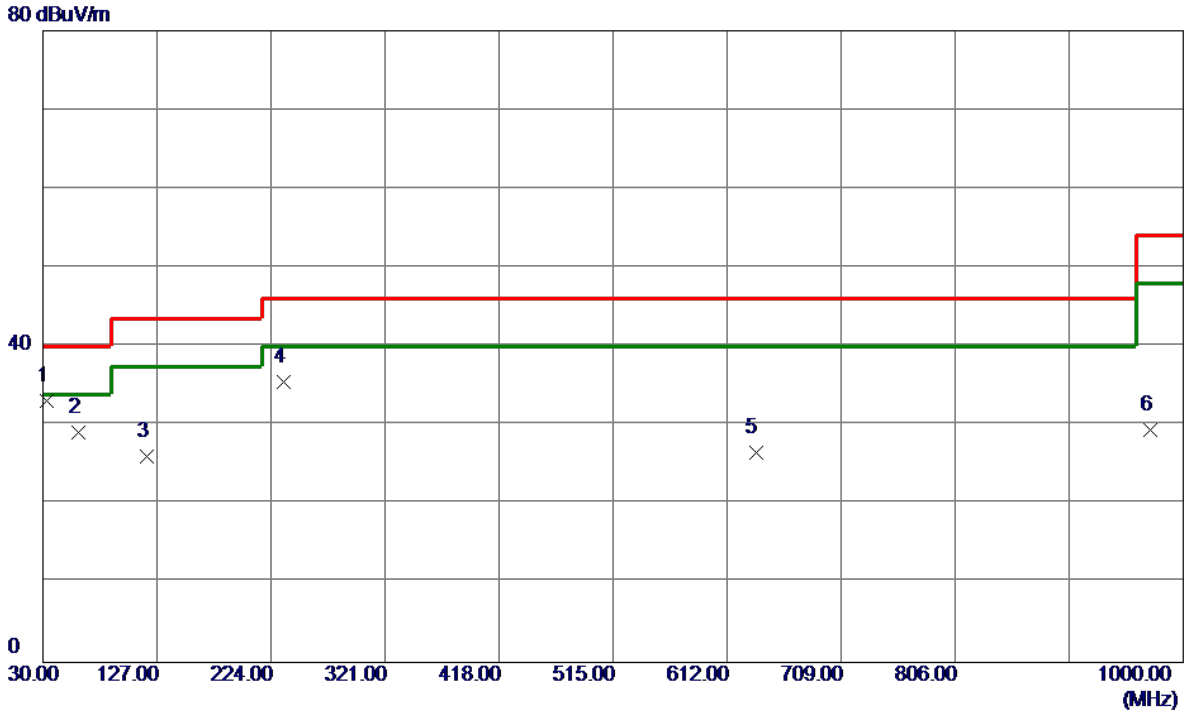

No.	Freq. MHz	Reading Level dBuV/m	Correct Factor dB	Measure ment dBuV/m	Limit dBuV/m	Margin dB	Detector	Comment
1 *	32.9100	47.84	-14.71	33.13	40.00	-6.87	Peak	
2	60.0700	43.88	-14.74	29.14	40.00	-10.86	Peak	
3	118.2700	39.44	-13.38	26.06	43.50	-17.44	Peak	
4	234.6700	49.80	-14.29	35.51	46.00	-10.49	Peak	
5	636.2500	31.97	-5.41	26.56	46.00	-19.44	Peak	
6	971.8700	29.96	-0.48	29.48	54.00	-24.52	Peak	

REMARKS:

- (1) Measurement Value = Reading Level + Correct Factor.
- (2) Margin Level = Measurement Value - Limit Value.

Test Mode: TX AC20 MODE CHANNEL 149

Horizontal

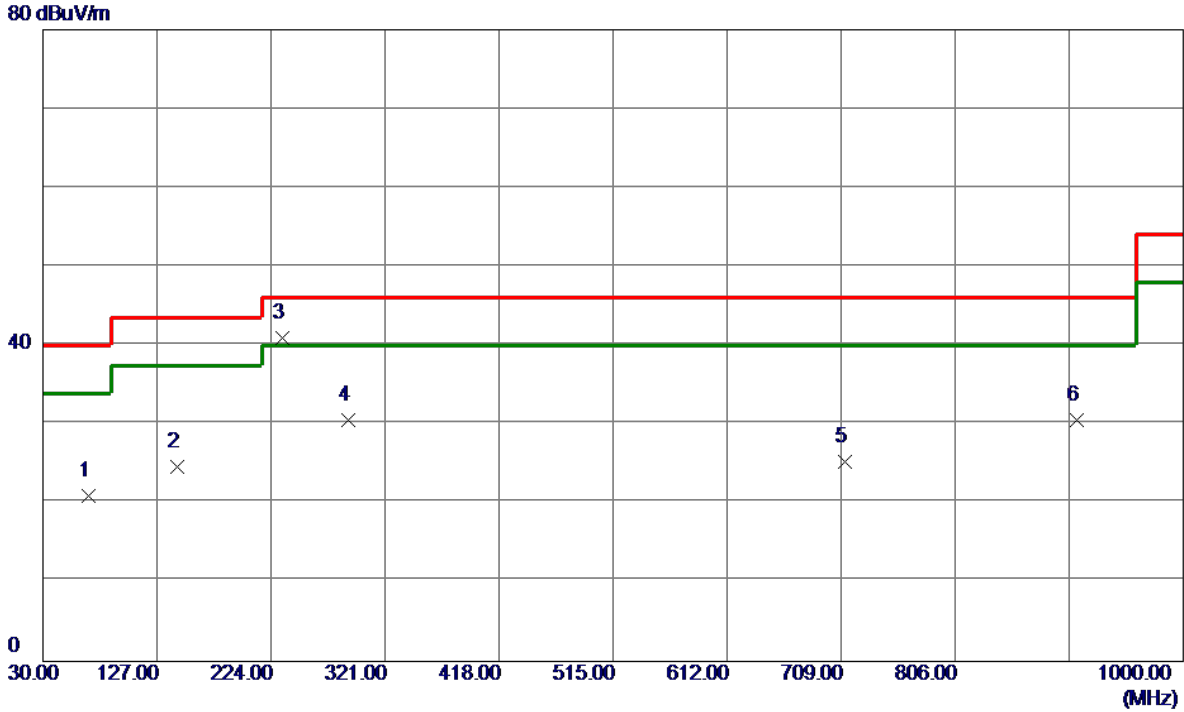

No.	Freq. MHz	Reading Level dBuV/m	Correct Factor dB	Measure ment dBuV/m	Limit dBuV/m	Margin dB	Detector	Comment
1	68.8000	36.87	-15.91	20.96	40.00	-19.04	Peak	
2	144.4600	37.34	-12.72	24.62	43.50	-18.88	Peak	
3 *	233.7000	55.27	-14.32	40.95	46.00	-5.05	Peak	
4	289.9600	42.70	-12.10	30.60	46.00	-15.40	Peak	
5	711.9099	29.66	-4.38	25.28	46.00	-20.72	Peak	
6	909.7900	32.53	-1.90	30.63	46.00	-15.37	Peak	

REMARKS:

- (1) Measurement Value = Reading Level + Correct Factor.
- (2) Margin Level = Measurement Value - Limit Value.

APPENDIX D - RADIATED EMISSION - ABOVE 1000 MHZ

Non Beamforming

Orthogonal Axis	X
Test Mode	UNII-1_TX A Mode 5180 MHz

Vertical

130 dBuV/m

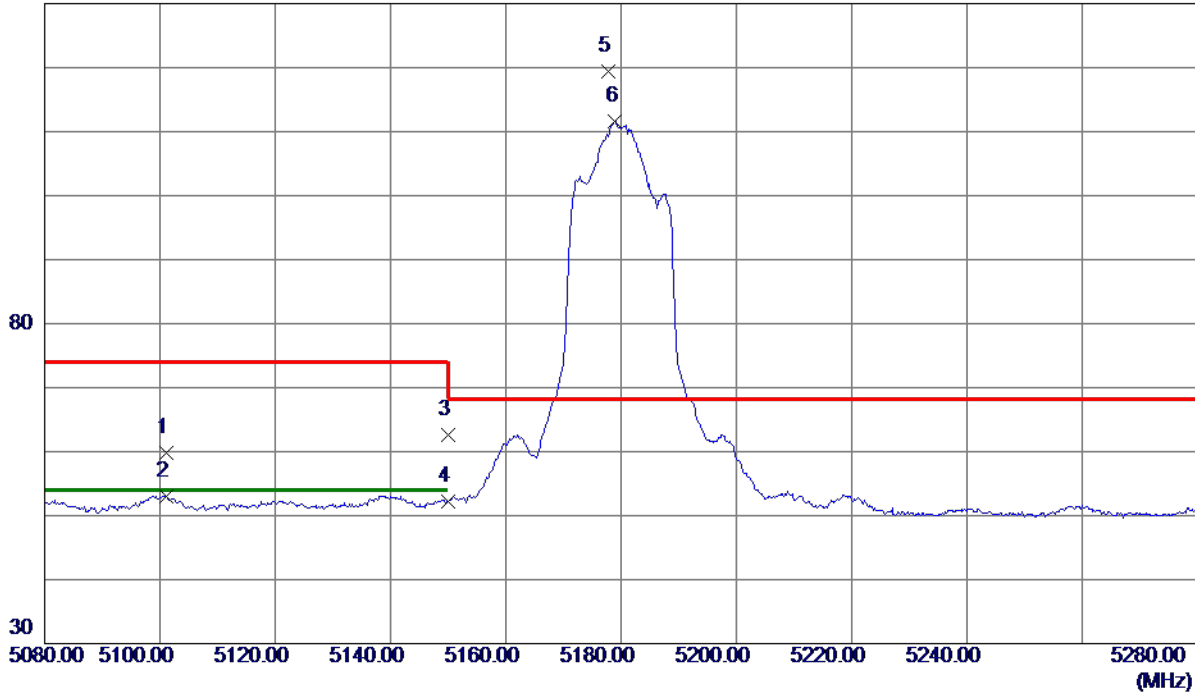

No.	Freq. MHz	Reading Level dBuV/m	Correct Factor dB	Measure ment dBuV/m	Limit dBuV/m	Margin dB	Detector	Comment
1	5101.1000	42.60	17.16	59.76	74.00	-14.24	Peak	
2	5101.1000	35.91	17.16	53.07	54.00	-0.93	AVG	
3	5150.0000	45.29	17.26	62.55	74.00	-11.45	Peak	
4	5150.0000	35.00	17.26	52.26	54.00	-1.74	AVG	
5 *	5177.8000	102.06	17.31	119.37	68.30	51.07	Peak	No Limit
6	5179.0000	94.28	17.32	111.60	999.00	-887.40	AVG	No Limit

REMARKS:

- (1) Measurement Value = Reading Level + Correct Factor.
- (2) Margin Level = Measurement Value - Limit Value.

Orthogonal Axis	X
Test Mode	UNII-1_TX A Mode 5180 MHz

Vertical

80 dBuV/m

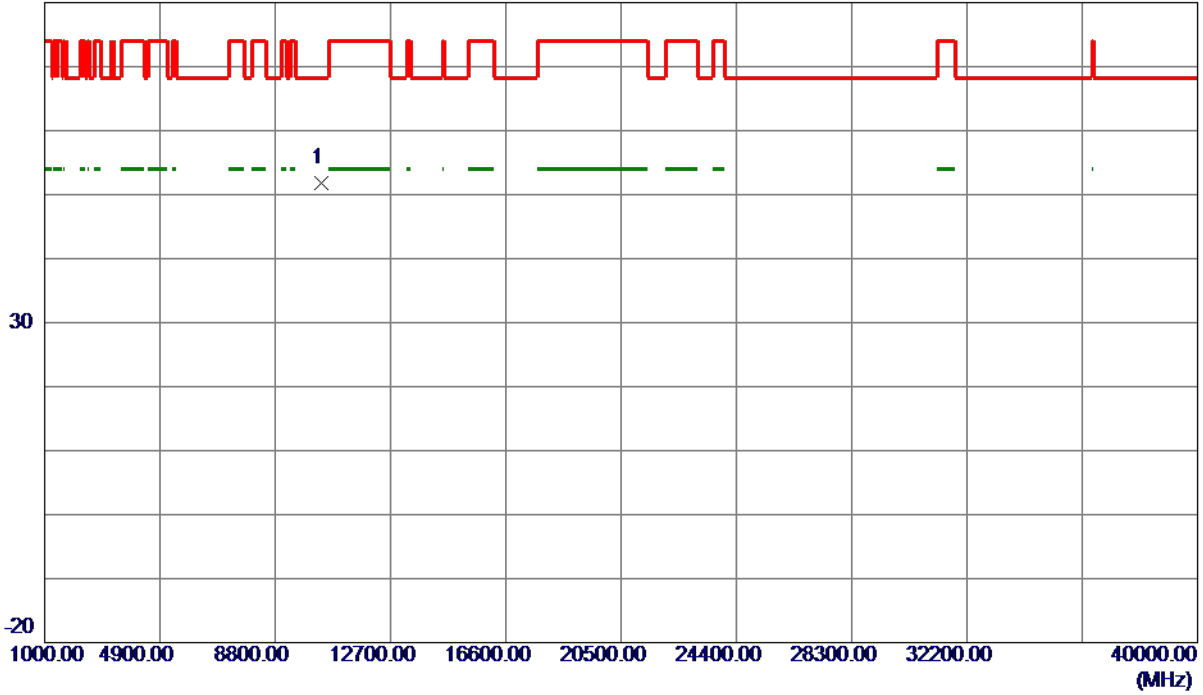

No.	Freq. MHz	Reading Level dBuV/m	Correct Factor dB	Measure ment dBuV/m	Limit dBuV/m	Margin dB	Detector	Comment
1 *	10351.3500	37.27	14.61	51.88	68.30	-16.42	Peak	

REMARKS:

- (1) Measurement Value = Reading Level + Correct Factor.
- (2) Margin Level = Measurement Value - Limit Value.

Orthogonal Axis	X
Test Mode	UNII-1_TX A Mode 5180 MHz

Horizontal

130 dBuV/m

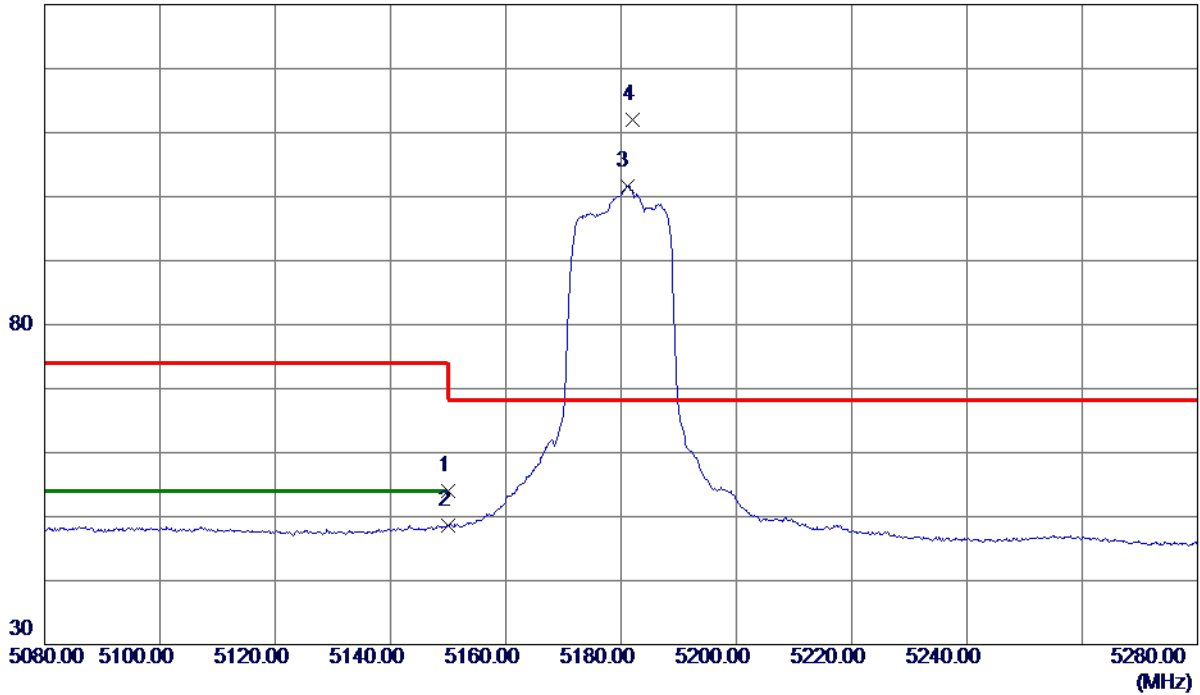

No.	Freq. MHz	Reading Level dBuV/m	Correct Factor dB	Measure ment dBuV/m	Limit dBuV/m	Margin dB	Detector	Comment
1	5150.0000	36.67	17.26	53.93	74.00	-20.07	Peak	
2	5150.0000	31.43	17.26	48.69	54.00	-5.31	AVG	
3	5181.0000	84.29	17.32	101.61	999.00	-897.39	AVG	No Limit
4 *	5182.1000	94.72	17.32	112.04	68.30	43.74	Peak	No Limit

REMARKS:

- (1) Measurement Value = Reading Level + Correct Factor.
- (2) Margin Level = Measurement Value - Limit Value.

Orthogonal Axis	X
Test Mode	UNII-1_TX A Mode 5180 MHz

Horizontal

80 dBuV/m

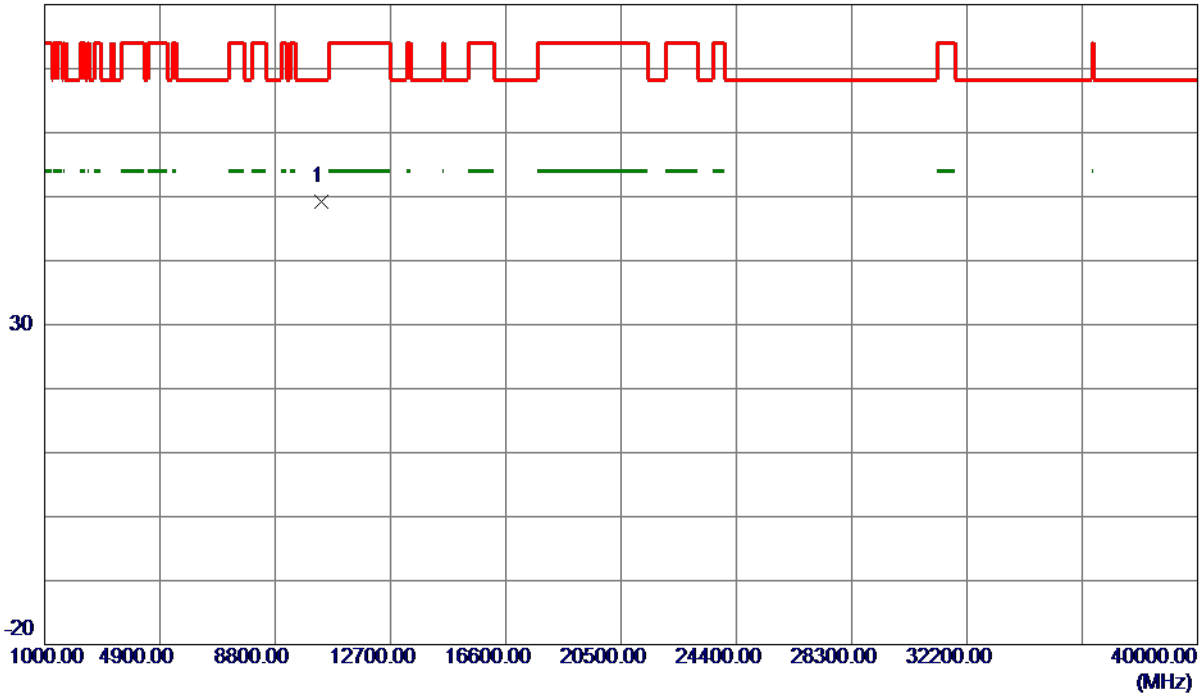

No.	Freq. MHz	Reading Level dBuV/m	Correct Factor dB	Measure ment dBuV/m	Limit dBuV/m	Margin dB	Detector	Comment
1 *	10366.2800	34.59	14.63	49.22	68.30	-19.08	Peak	

REMARKS:

- (1) Measurement Value = Reading Level + Correct Factor.
- (2) Margin Level = Measurement Value - Limit Value.

Orthogonal Axis	X
Test Mode	UNII-1_TX A Mode 5200 MHz

Vertical

130 dBuV/m

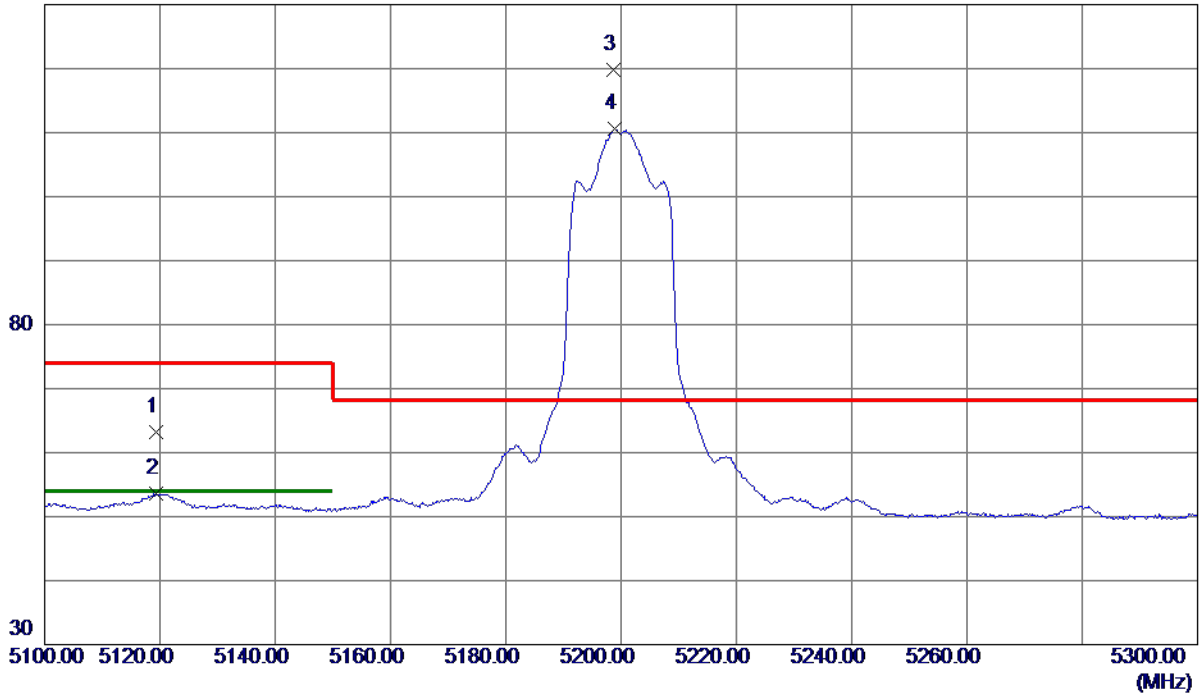

No.	Freq. MHz	Reading Level dBuV/m	Correct Factor dB	Measure ment dBuV/m	Limit dBuV/m	Margin dB	Detector	Comment
1	5119.4000	46.09	17.20	63.29	74.00	-10.71	Peak	
2	5119.4000	36.37	17.20	53.57	54.00	-0.43	AVG	
3 *	5198.6000	102.34	17.36	119.70	68.30	51.40	Peak	No Limit
4	5198.8000	93.15	17.36	110.51	999.00	-888.49	AVG	No Limit

REMARKS:

- (1) Measurement Value = Reading Level + Correct Factor.
- (2) Margin Level = Measurement Value - Limit Value.

Orthogonal Axis	X
Test Mode	UNII-1_TX A Mode 5200 MHz

Vertical

80 dBuV/m

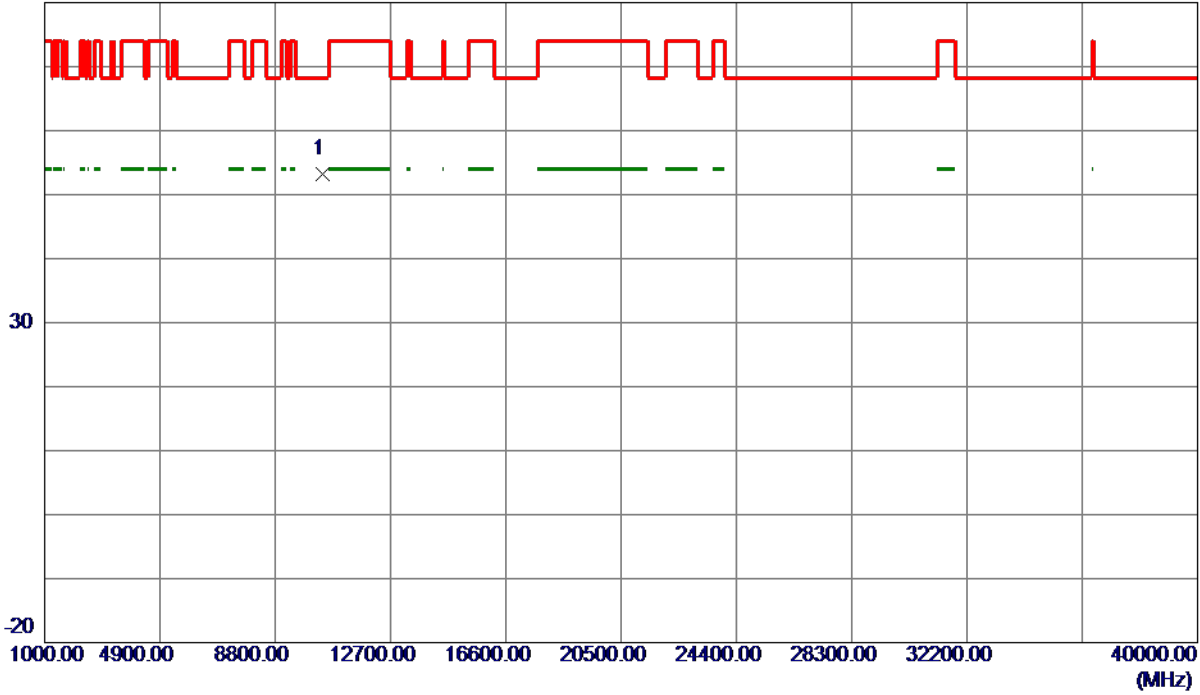

No.	Freq. MHz	Reading Level dBuV/m	Correct Factor dB	Measure ment dBuV/m	Limit dBuV/m	Margin dB	Detector	Comment
1 *	10390.2000	38.53	14.67	53.20	68.30	-15.10	Peak	

REMARKS:

- (1) Measurement Value = Reading Level + Correct Factor.
- (2) Margin Level = Measurement Value - Limit Value.

Orthogonal Axis	X
Test Mode	UNII-1_TX A Mode 5200 MHz

Horizontal

130 dBuV/m

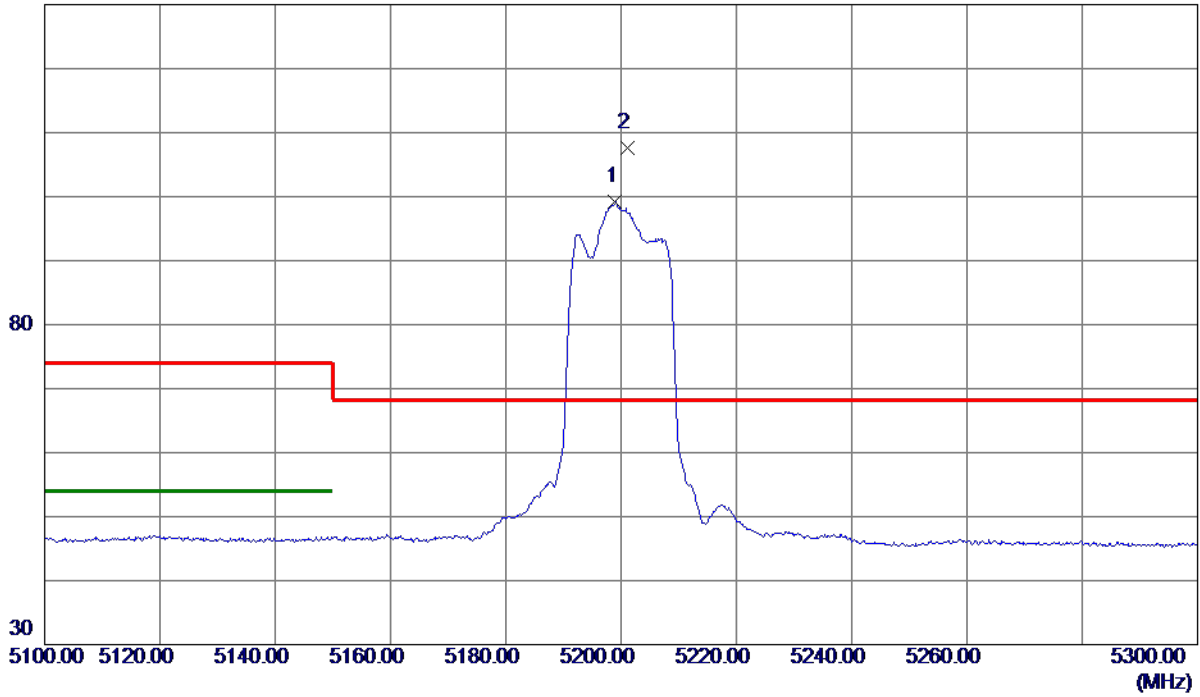

No.	Freq. MHz	Reading Level dBuV/m	Correct Factor dB	Measure ment dBuV/m	Limit dBuV/m	Margin dB	Detector	Comment
1	5199.0000	81.75	17.36	99.11	999.00	-899.89	AVG	No Limit
2 *	5201.1000	90.24	17.36	107.60	68.30	39.30	Peak	No Limit

REMARKS:

- (1) Measurement Value = Reading Level + Correct Factor.
- (2) Margin Level = Measurement Value - Limit Value.

Orthogonal Axis	X
Test Mode	UNII-1_TX A Mode 5200 MHz

Horizontal

80 dBuV/m

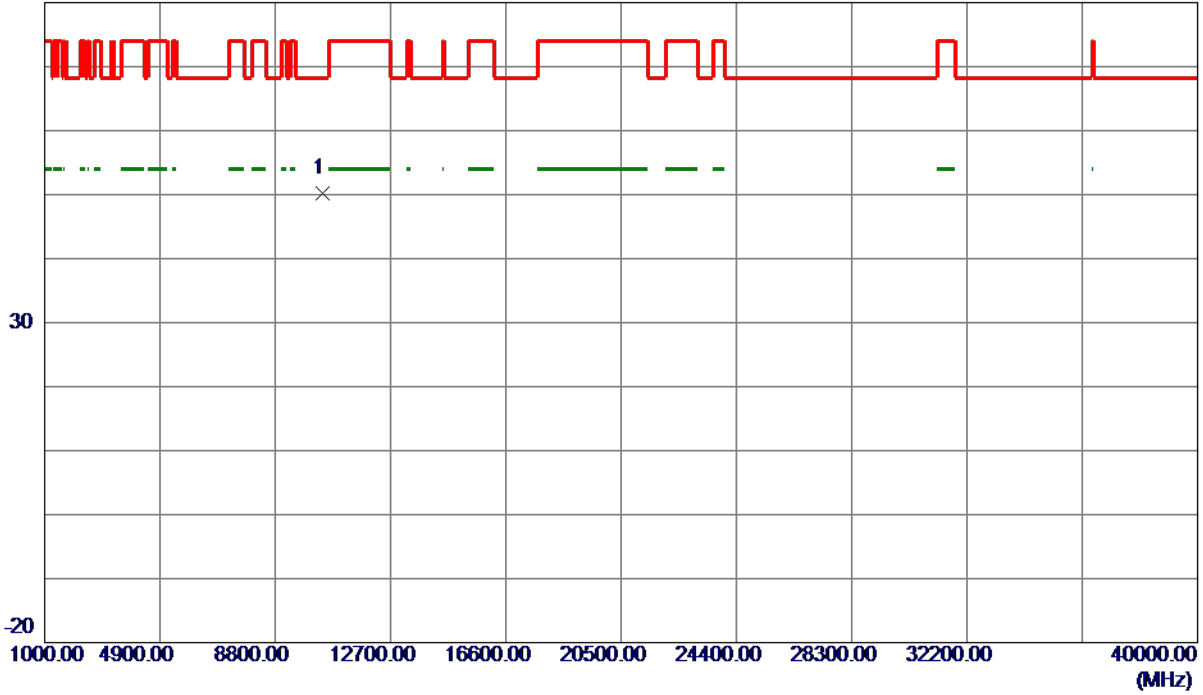

No.	Freq. MHz	Reading Level dBuV/m	Correct Factor dB	Measure ment dBuV/m	Limit dBuV/m	Margin dB	Detector	Comment
1 *	10396.0100	35.43	14.68	50.11	68.30	-18.19	Peak	

REMARKS:

- (1) Measurement Value = Reading Level + Correct Factor.
- (2) Margin Level = Measurement Value - Limit Value.

Orthogonal Axis	X
Test Mode	UNII-1_TX A Mode 5240 MHz

Vertical

130 dBuV/m

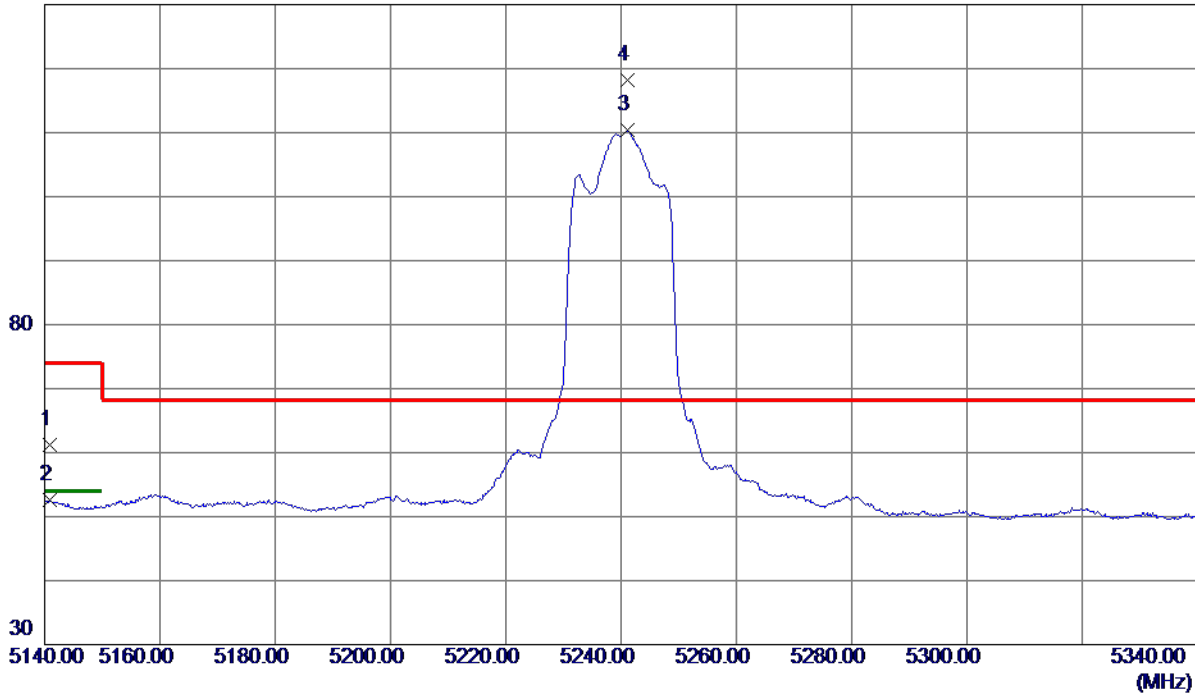

No.	Freq. MHz	Reading Level dBuV/m	Correct Factor dB	Measure ment dBuV/m	Limit dBuV/m	Margin dB	Detector	Comment
1	5140.9000	43.88	17.24	61.12	74.00	-12.88	Peak	
2	5140.9000	35.27	17.24	52.51	54.00	-1.49	AVG	
3	5241.1000	92.97	17.44	110.41	999.00	-888.59	AVG	No Limit
4 *	5241.2000	100.79	17.44	118.23	68.30	49.93	Peak	No Limit

REMARKS:

- (1) Measurement Value = Reading Level + Correct Factor.
- (2) Margin Level = Measurement Value - Limit Value.

Orthogonal Axis	X
Test Mode	UNII-1_TX A Mode 5240 MHz

Vertical

80 dBuV/m

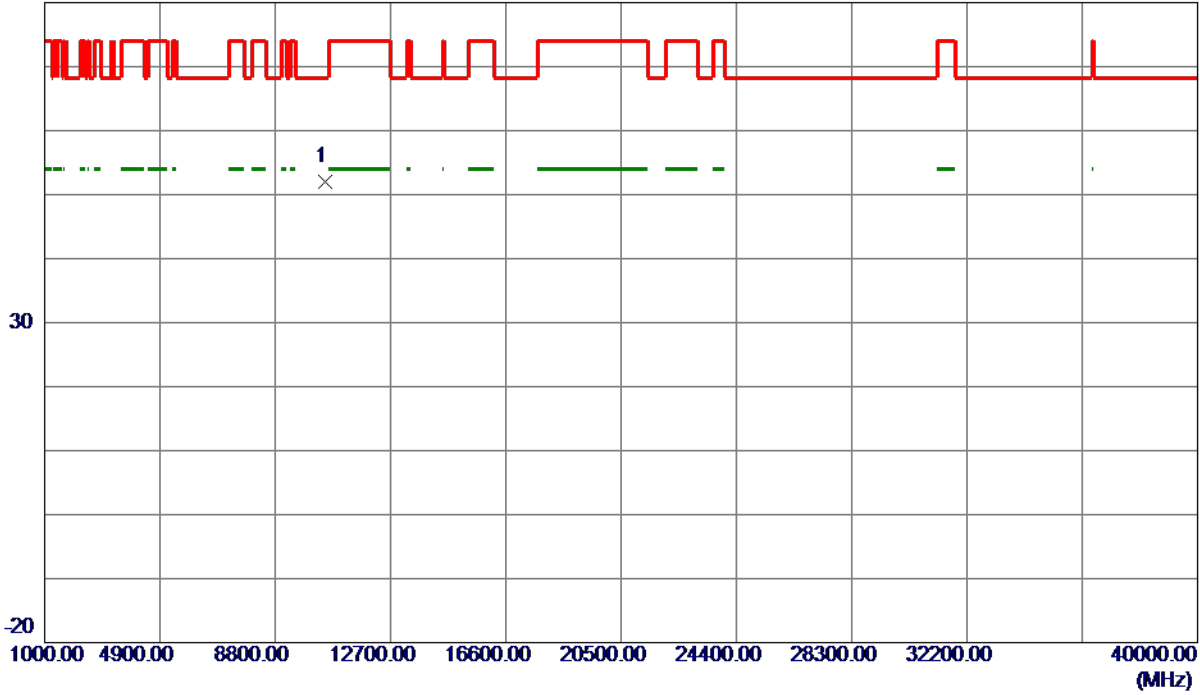

No.	Freq. MHz	Reading Level dBuV/m	Correct Factor dB	Measure ment dBuV/m	Limit dBuV/m	Margin dB	Detector	Comment
1 *	10486.7000	37.25	14.84	52.09	68.30	-16.21	Peak	

REMARKS:

- (1) Measurement Value = Reading Level + Correct Factor.
- (2) Margin Level = Measurement Value - Limit Value.

Orthogonal Axis	X
Test Mode	UNII-1_TX A Mode 5240 MHz

Horizontal

130 dBuV/m

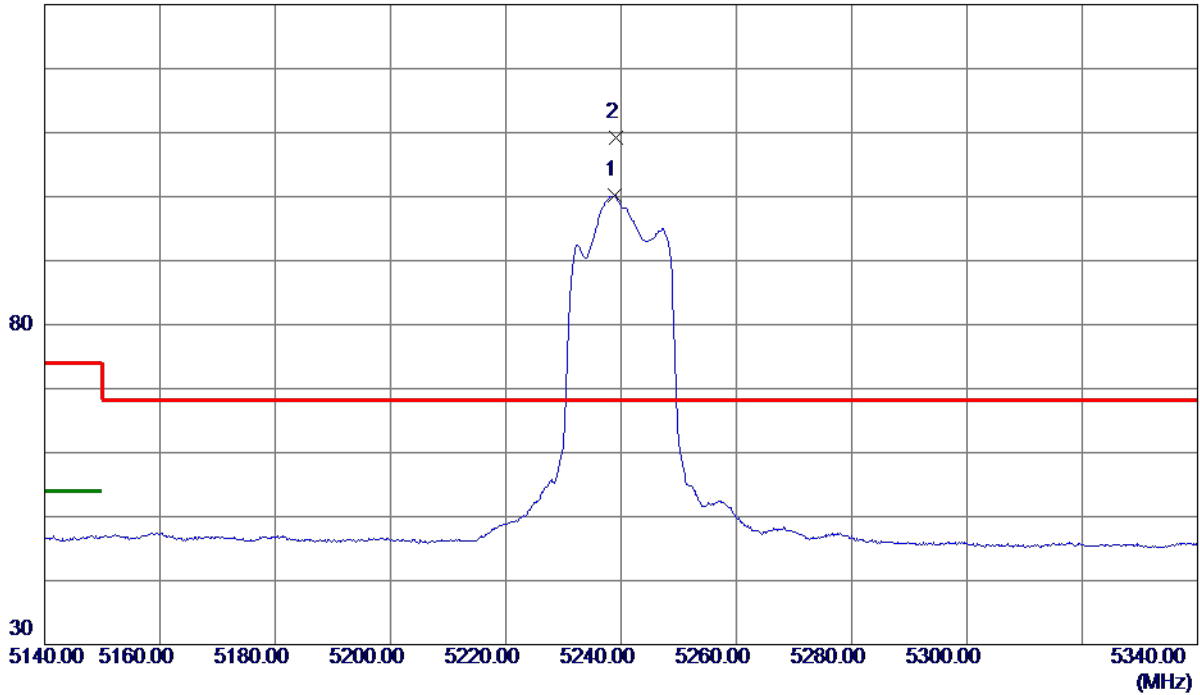

No.	Freq. MHz	Reading Level dBuV/m	Correct Factor dB	Measure ment dBuV/m	Limit dBuV/m	Margin dB	Detector	Comment
1	5238.9000	82.83	17.44	100.27	999.00	-898.73	AVG	No Limit
2 *	5239.2000	91.84	17.44	109.28	68.30	40.98	Peak	No Limit

REMARKS:

- (1) Measurement Value = Reading Level + Correct Factor.
- (2) Margin Level = Measurement Value - Limit Value.

Orthogonal Axis	X
Test Mode	UNII-1_TX A Mode 5240 MHz

Horizontal

80 dBuV/m

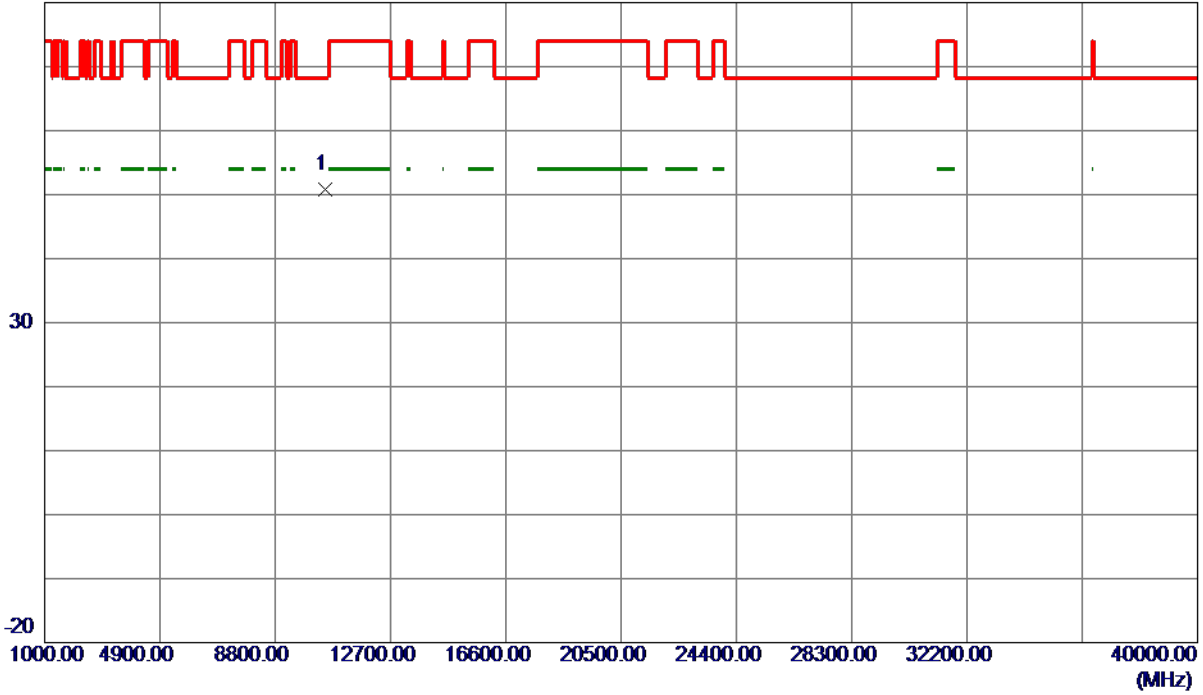

No.	Freq. MHz	Reading Level dBuV/m	Correct Factor dB	Measure ment dBuV/m	Limit dBuV/m	Margin dB	Detector	Comment
1 *	10481.1600	35.89	14.83	50.72	68.30	-17.58	Peak	

REMARKS:

- (1) Measurement Value = Reading Level + Correct Factor.
- (2) Margin Level = Measurement Value - Limit Value.

Orthogonal Axis	X
Test Mode	UNII-3_TX A Mode 5745 MHz

Vertical

130 dBuV/m

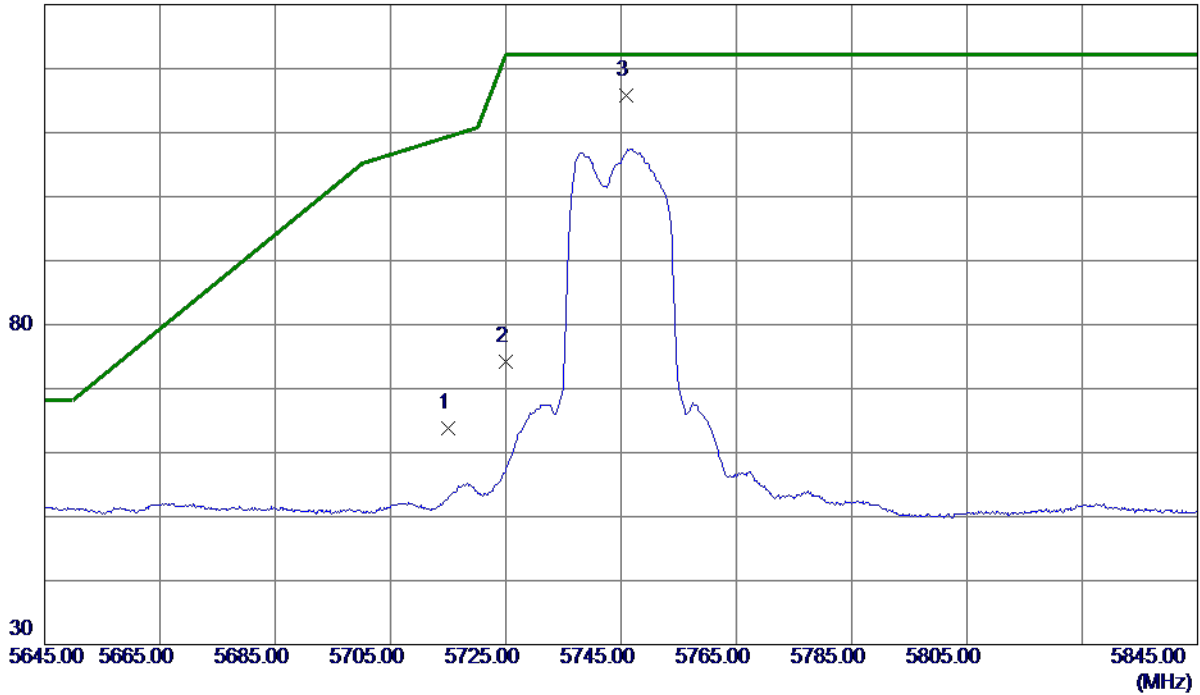

No.	Freq. MHz	Reading Level dBuV/m	Correct Factor dB	Measure ment dBuV/m	Limit dBuV/m	Margin dB	Detector	Comment
1	5715.0000	45.12	18.65	63.77	109.40	-45.63	Peak	
2	5725.0000	55.51	18.69	74.20	122.20	-48.00	Peak	
3 *	5745.8000	96.96	18.75	115.71	122.20	-6.49	Peak	No Limit

REMARKS:

- (1) Measurement Value = Reading Level + Correct Factor.
- (2) Margin Level = Measurement Value - Limit Value.

Orthogonal Axis	X
Test Mode	UNII-3_TX A Mode 5745 MHz

Vertical

80 dBuV/m

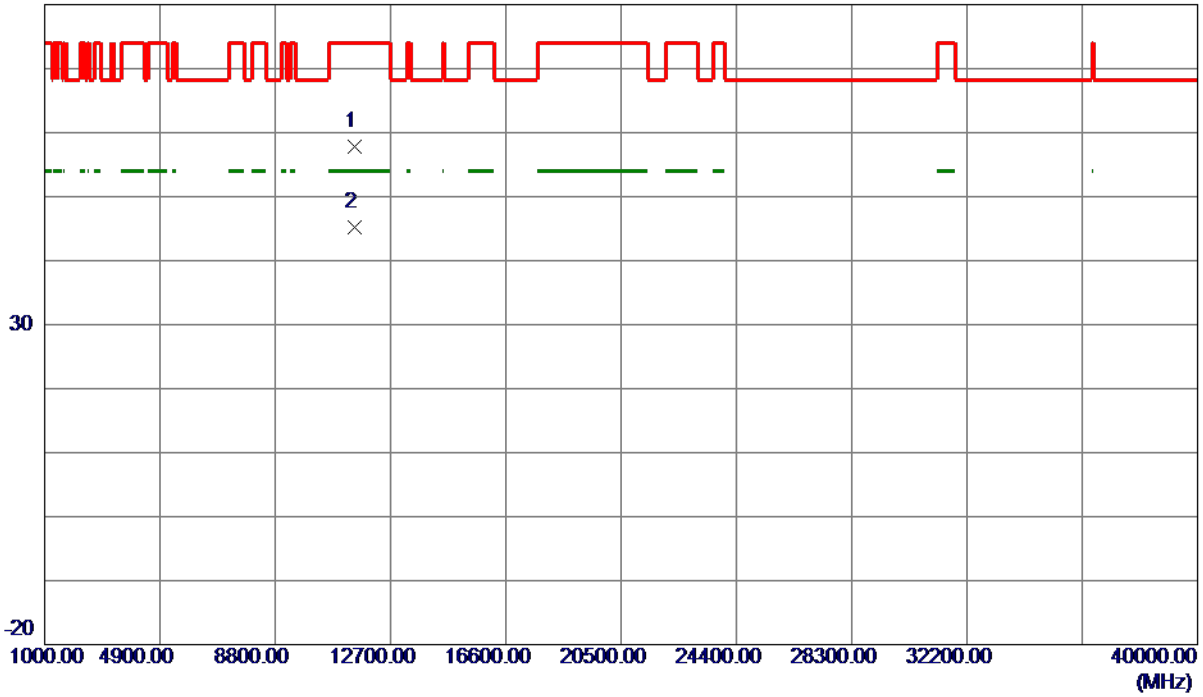

No.	Freq. MHz	Reading Level dBuV/m	Correct Factor dB	Measure ment dBuV/m	Limit dBuV/m	Margin dB	Detector	Comment
1	11495.3900	40.65	17.17	57.82	74.00	-16.18	Peak	
2 *	11495.8200	27.94	17.17	45.11	54.00	-8.89	AVG	

REMARKS:

- (1) Measurement Value = Reading Level + Correct Factor.
- (2) Margin Level = Measurement Value - Limit Value.

Orthogonal Axis	X
Test Mode	UNII-3_TX A Mode 5745 MHz

Horizontal

130 dBuV/m

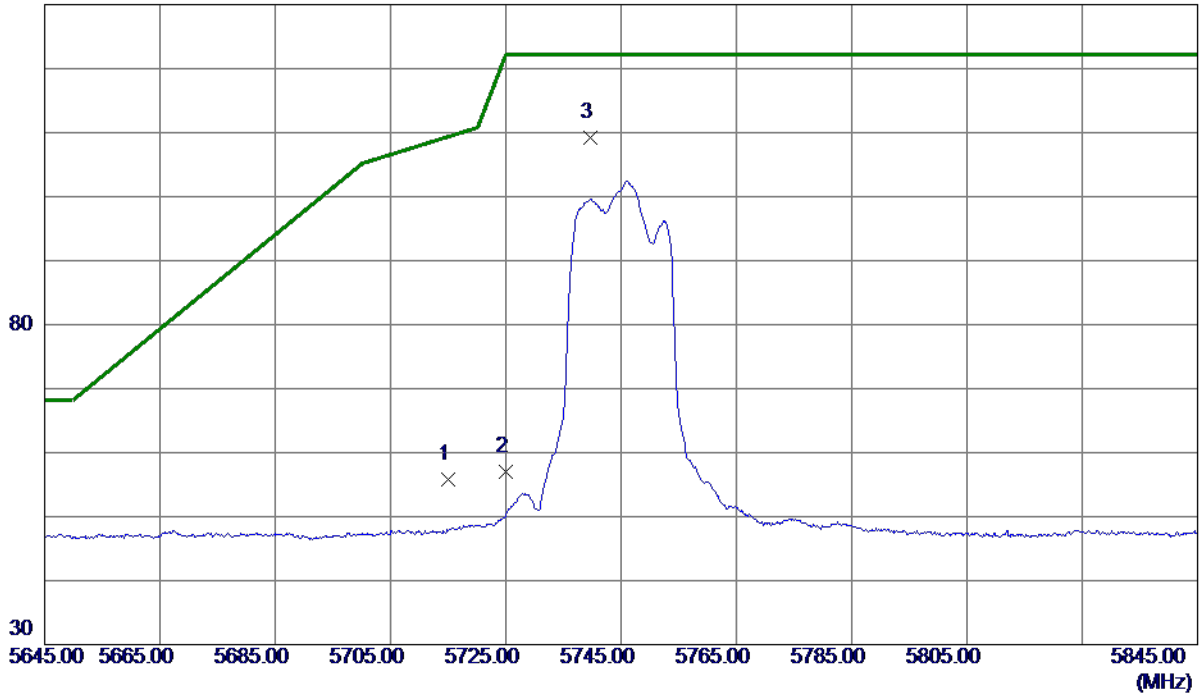

No.	Freq. MHz	Reading Level dBuV/m	Correct Factor dB	Measure ment dBuV/m	Limit dBuV/m	Margin dB	Detector	Comment
1	5715.0000	37.12	18.65	55.77	109.40	-53.63	Peak	
2	5725.0000	38.33	18.69	57.02	122.20	-65.18	Peak	
3 *	5739.6000	90.40	18.73	109.13	122.20	-13.07	Peak	No Limit

REMARKS:

- (1) Measurement Value = Reading Level + Correct Factor.
- (2) Margin Level = Measurement Value - Limit Value.

Orthogonal Axis	X
Test Mode	UNII-3_TX A Mode 5745 MHz

Horizontal

80 dBuV/m

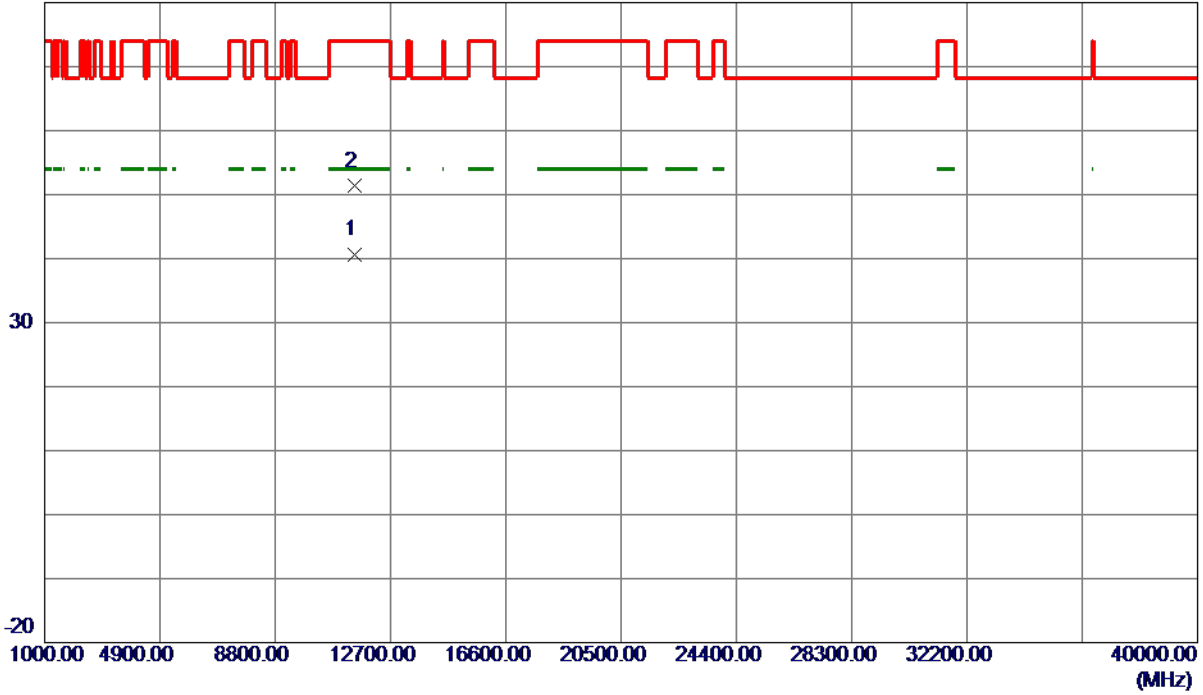

No.	Freq. MHz	Reading Level dBuV/m	Correct Factor dB	Measure ment dBuV/m	Limit dBuV/m	Margin dB	Detector	Comment
1 *	11487.5599	23.41	17.15	40.56	54.00	-13.44	AVG	
2	11488.7600	34.15	17.15	51.30	74.00	-22.70	Peak	

REMARKS:

- (1) Measurement Value = Reading Level + Correct Factor.
- (2) Margin Level = Measurement Value - Limit Value.

Orthogonal Axis	X
Test Mode	UNII-3_TX A Mode 5785 MHz

Vertical

130 dBuV/m

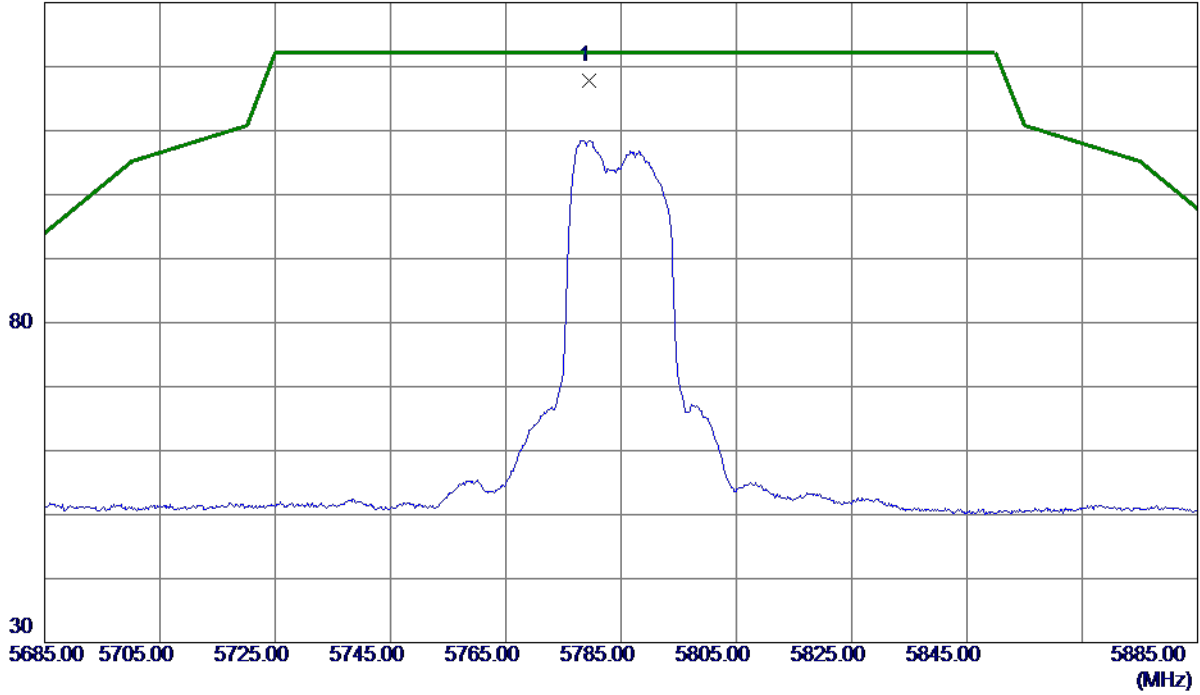

No.	Freq. MHz	Reading Level dBuV/m	Correct Factor dB	Measure ment dBuV/m	Limit dBuV/m	Margin dB	Detector	Comment
1 *	5779.4000	98.89	18.86	117.75	122.20	-4.45	Peak	No Limit

REMARKS:

- (1) Measurement Value = Reading Level + Correct Factor.
- (2) Margin Level = Measurement Value - Limit Value.

Orthogonal Axis	X
Test Mode	UNII-3_TX A Mode 5785 MHz

Vertical

80 dBuV/m

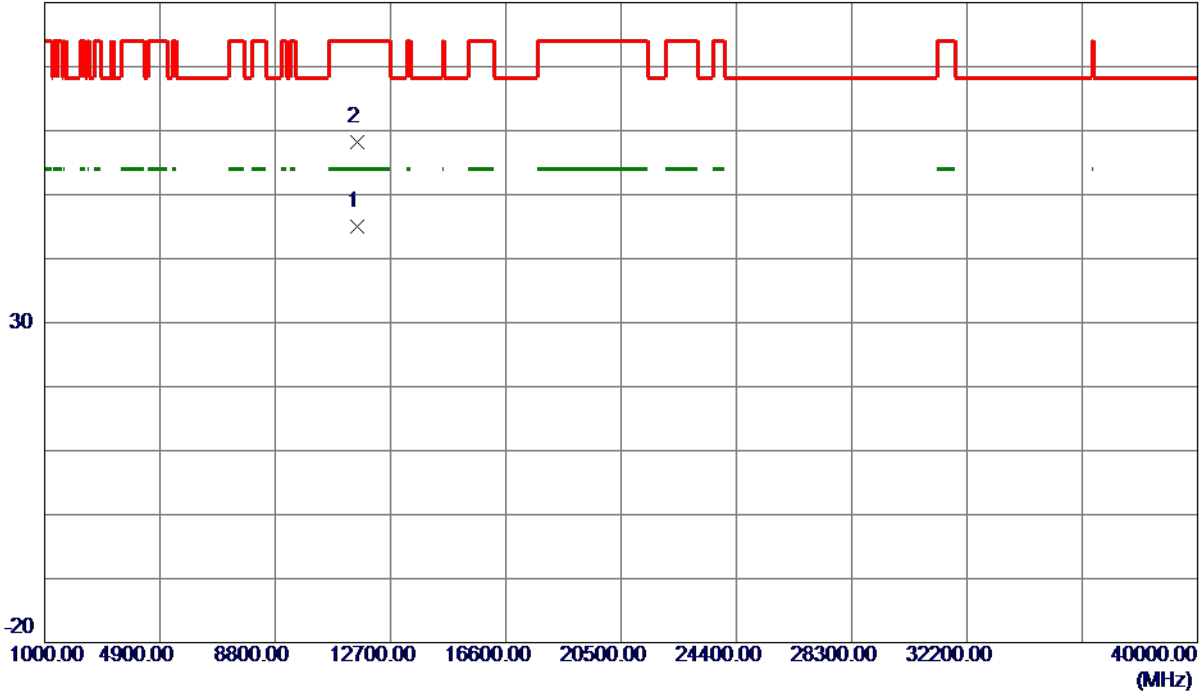

No.	Freq. MHz	Reading Level dBuV/m	Correct Factor dB	Measure ment dBuV/m	Limit dBuV/m	Margin dB	Detector	Comment
1 *	11575.8700	27.84	17.20	45.04	54.00	-8.96	AVG	
2	11576.1600	40.96	17.20	58.16	74.00	-15.84	Peak	

REMARKS:

- (1) Measurement Value = Reading Level + Correct Factor.
- (2) Margin Level = Measurement Value - Limit Value.

Orthogonal Axis	X
Test Mode	UNII-3_TX A Mode 5785 MHz

Horizontal

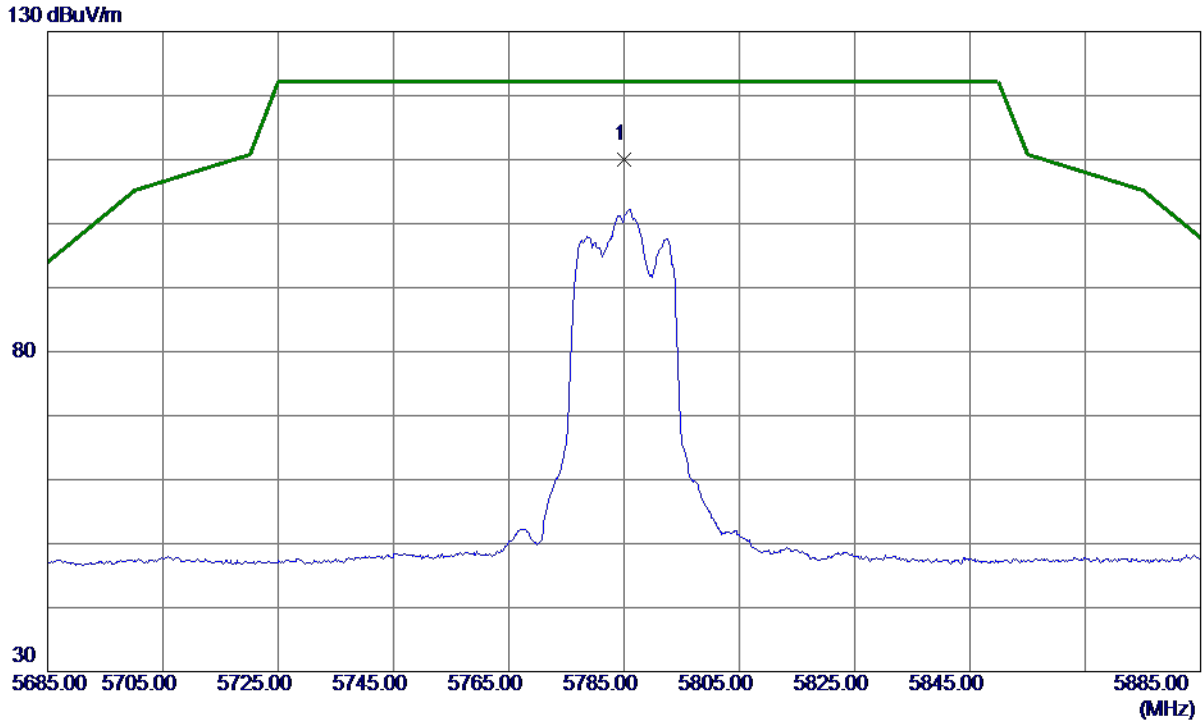

No.	Freq. MHz	Reading Level dBuV/m	Correct Factor dB	Measure ment dBuV/m	Limit dBuV/m	Margin dB	Detector	Comment
1 *	5784.9000	91.08	18.88	109.96	122.20	-12.24	Peak	No Limit

REMARKS:

- (1) Measurement Value = Reading Level + Correct Factor.
- (2) Margin Level = Measurement Value - Limit Value.

Orthogonal Axis	X
Test Mode	UNII-3_TX A Mode 5785 MHz

Horizontal

80 dBuV/m

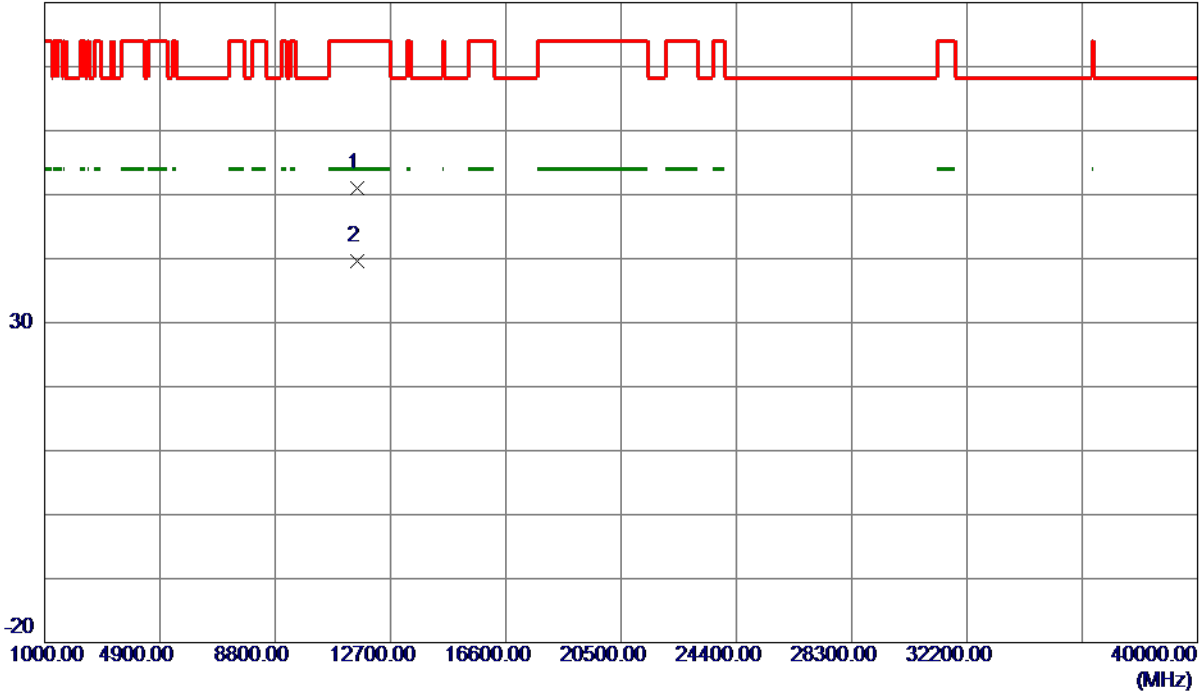

No.	Freq. MHz	Reading Level dBuV/m	Correct Factor dB	Measure ment dBuV/m	Limit dBuV/m	Margin dB	Detector	Comment
1	11566.3800	33.77	17.20	50.97	74.00	-23.03	Peak	
2 *	11567.0700	22.32	17.20	39.52	54.00	-14.48	AVG	

REMARKS:

- (1) Measurement Value = Reading Level + Correct Factor.
- (2) Margin Level = Measurement Value - Limit Value.

Orthogonal Axis	X
Test Mode	UNII-3_TX A Mode 5825 MHz

Vertical

130 dBuV/m

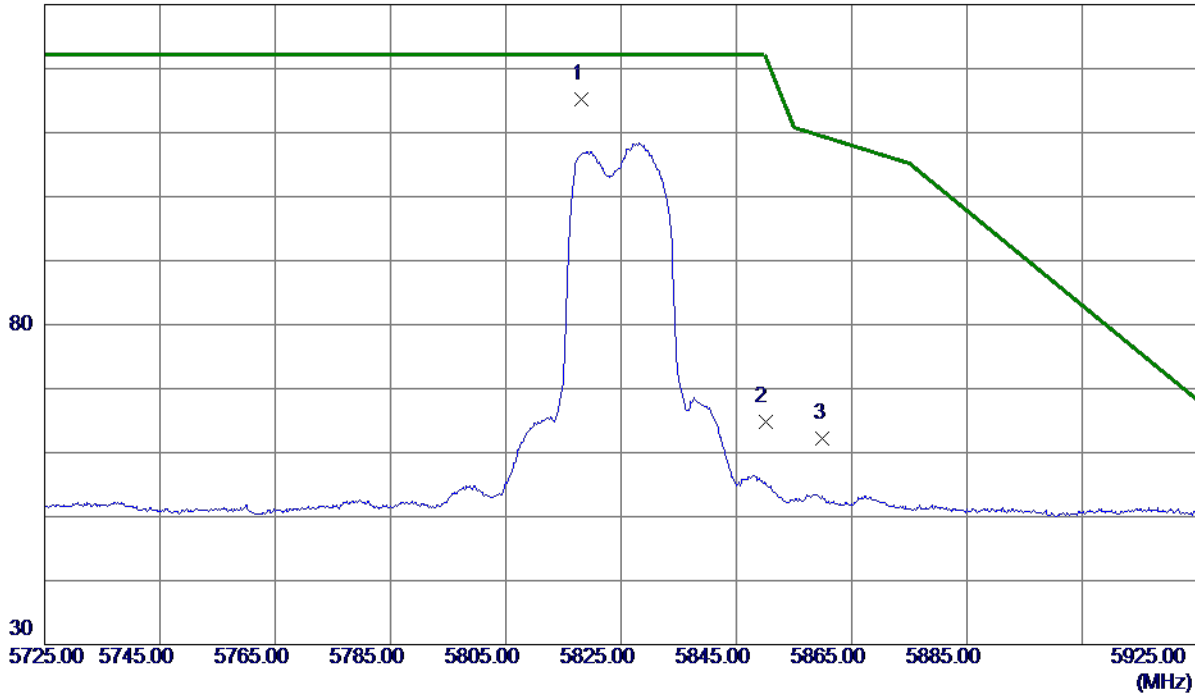

No.	Freq. MHz	Reading Level dBuV/m	Correct Factor dB	Measure ment dBuV/m	Limit dBuV/m	Margin dB	Detector	Comment
1 *	5818.1000	96.19	18.99	115.18	122.20	-7.02	Peak	No Limit
2	5850.0000	45.69	19.09	64.78	122.20	-57.42	Peak	
3	5860.0000	42.98	19.13	62.11	109.40	-47.29	Peak	

REMARKS:

- (1) Measurement Value = Reading Level + Correct Factor.
- (2) Margin Level = Measurement Value - Limit Value.

Orthogonal Axis	X
Test Mode	UNII-3_TX A Mode 5825 MHz

Vertical

80 dBuV/m

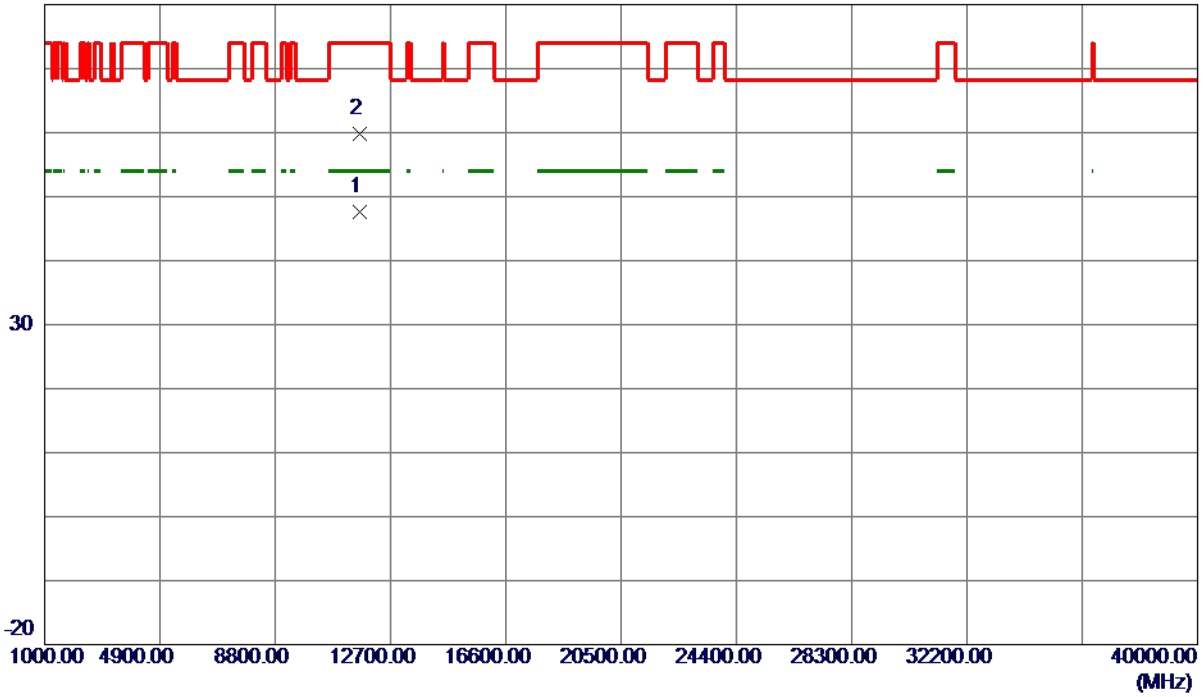

No.	Freq. MHz	Reading Level dBuV/m	Correct Factor dB	Measure ment dBuV/m	Limit dBuV/m	Margin dB	Detector	Comment
1 *	11655.9000	30.33	17.23	47.56	54.00	-6.44	AVG	
2	11656.9100	42.64	17.23	59.87	74.00	-14.13	Peak	

REMARKS:

- (1) Measurement Value = Reading Level + Correct Factor.
- (2) Margin Level = Measurement Value - Limit Value.

Orthogonal Axis	X
Test Mode	UNII-3_TX A Mode 5825 MHz

Horizontal

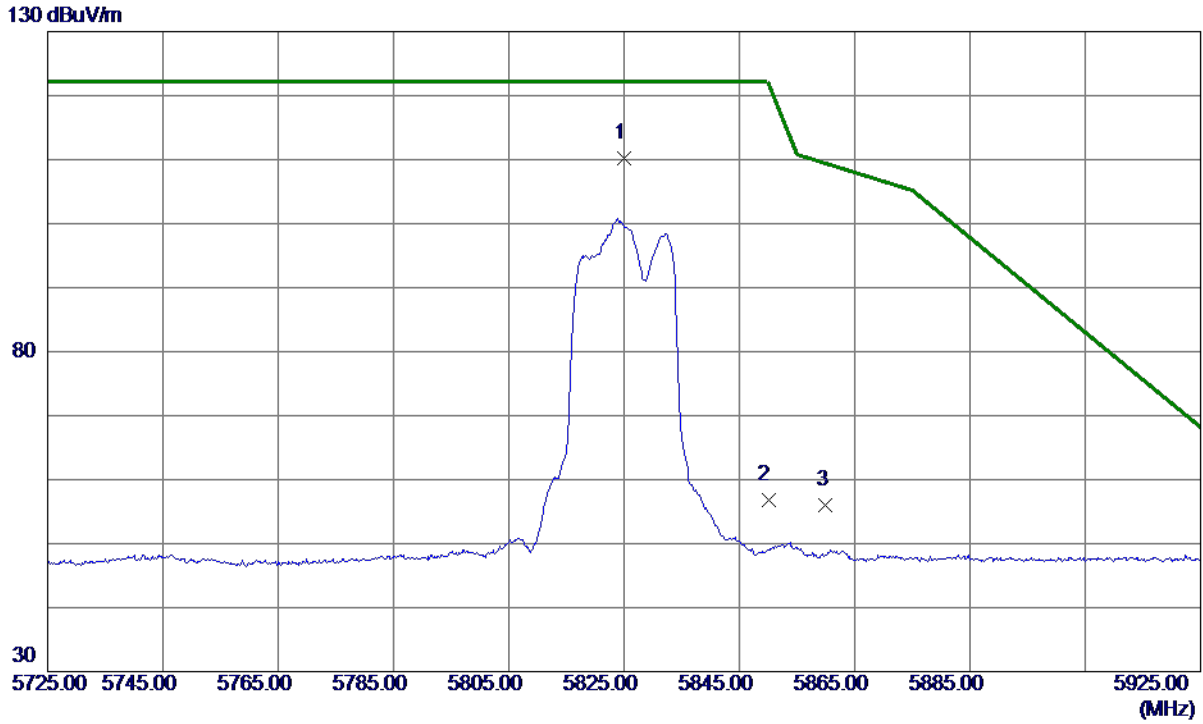

No.	Freq. MHz	Reading Level dBuV/m	Correct Factor dB	Measure ment dBuV/m	Limit dBuV/m	Margin dB	Detector	Comment
1 *	5824.9000	91.18	19.01	110.19	122.20	-12.01	Peak	No Limit
2	5850.0000	37.79	19.09	56.88	122.20	-65.32	Peak	
3	5860.0000	36.84	19.13	55.97	109.40	-53.43	Peak	

REMARKS:

- (1) Measurement Value = Reading Level + Correct Factor.
- (2) Margin Level = Measurement Value - Limit Value.

Orthogonal Axis	X
Test Mode	UNII-3_TX A Mode 5825 MHz

Horizontal

80 dBuV/m

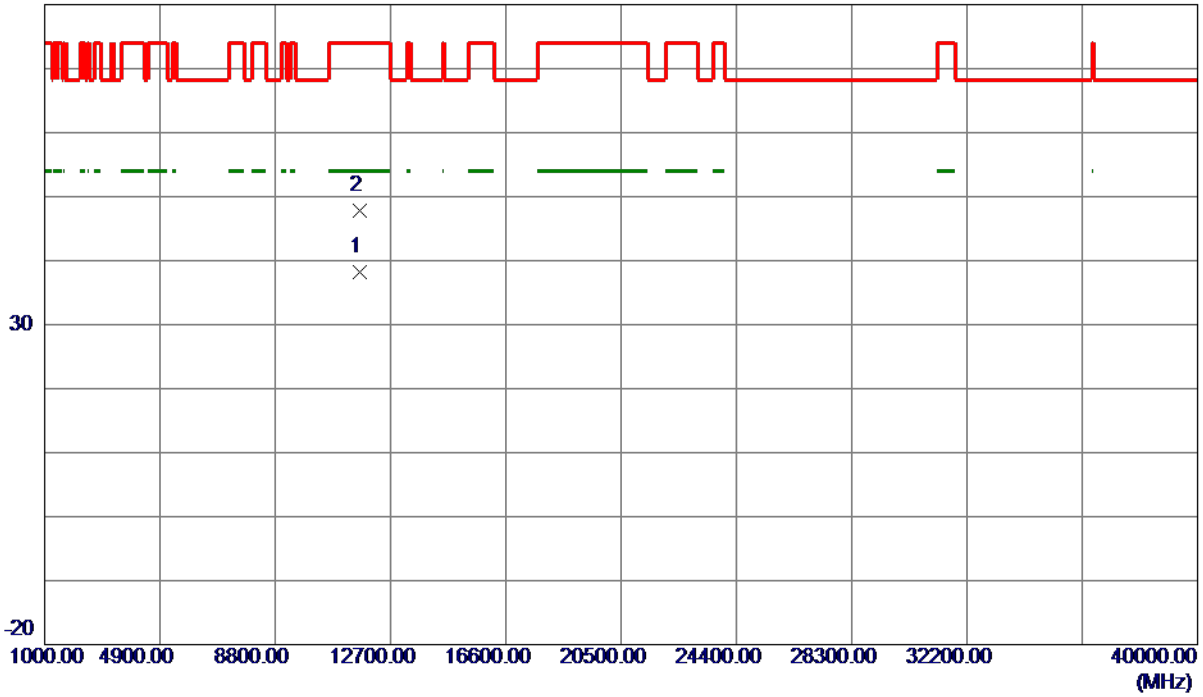

No.	Freq. MHz	Reading Level dBuV/m	Correct Factor dB	Measure ment dBuV/m	Limit dBuV/m	Margin dB	Detector	Comment
1 *	11644.2400	20.98	17.23	38.21	54.00	-15.79	AVG	
2	11646.9900	30.64	17.23	47.87	74.00	-26.13	Peak	

REMARKS:

- (1) Measurement Value = Reading Level + Correct Factor.
- (2) Margin Level = Measurement Value - Limit Value.

Orthogonal Axis	X
Test Mode	UNII-1_TX AC (VHT20) Mode 5180 MHz

Vertical

130 dBuV/m

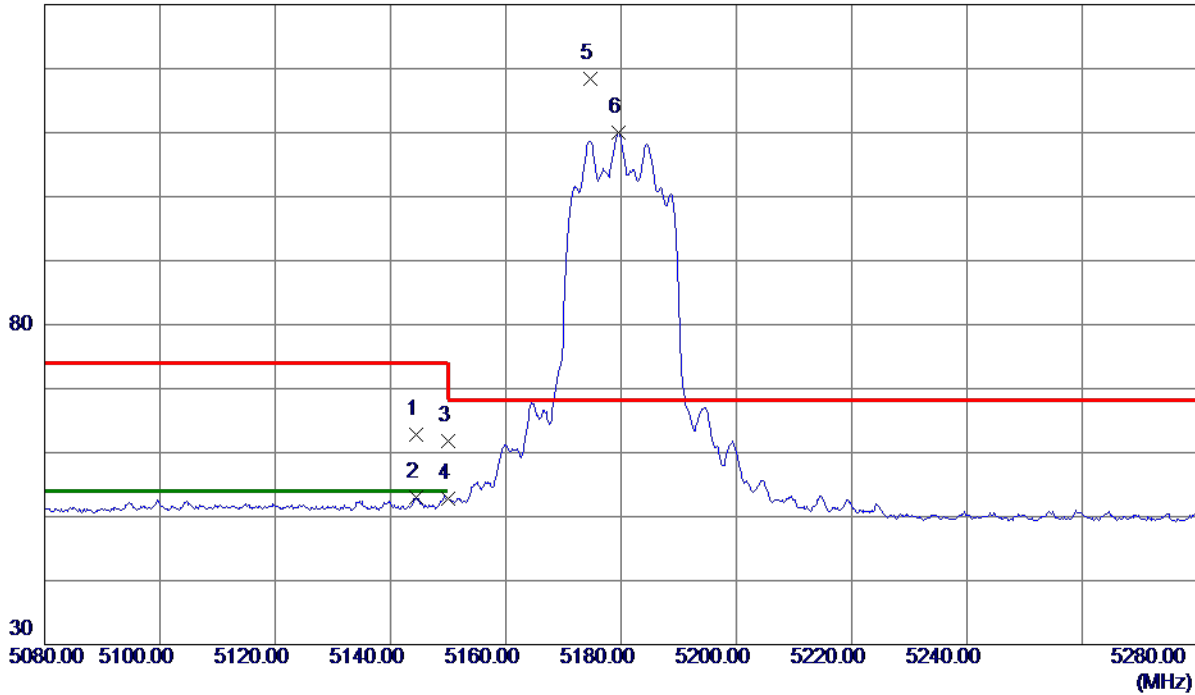

No.	Freq. MHz	Reading Level dBuV/m	Correct Factor dB	Measure ment dBuV/m	Limit dBuV/m	Margin dB	Detector	Comment
1	5144.5000	45.58	17.25	62.83	74.00	-11.17	Peak	
2	5144.5000	35.84	17.25	53.09	54.00	-0.91	AVG	
3	5150.0000	44.50	17.26	61.76	74.00	-12.24	Peak	
4	5150.0000	35.62	17.26	52.88	54.00	-1.12	AVG	
5 *	5174.7000	101.18	17.31	118.49	68.30	50.19	Peak	No Limit
6	5179.6000	92.73	17.32	110.05	999.00	-888.95	AVG	No Limit

REMARKS:

- (1) Measurement Value = Reading Level + Correct Factor.
- (2) Margin Level = Measurement Value - Limit Value.

Orthogonal Axis	X
Test Mode	UNII-1_TX AC (VHT20) Mode 5180 MHz

Vertical

80 dBuV/m

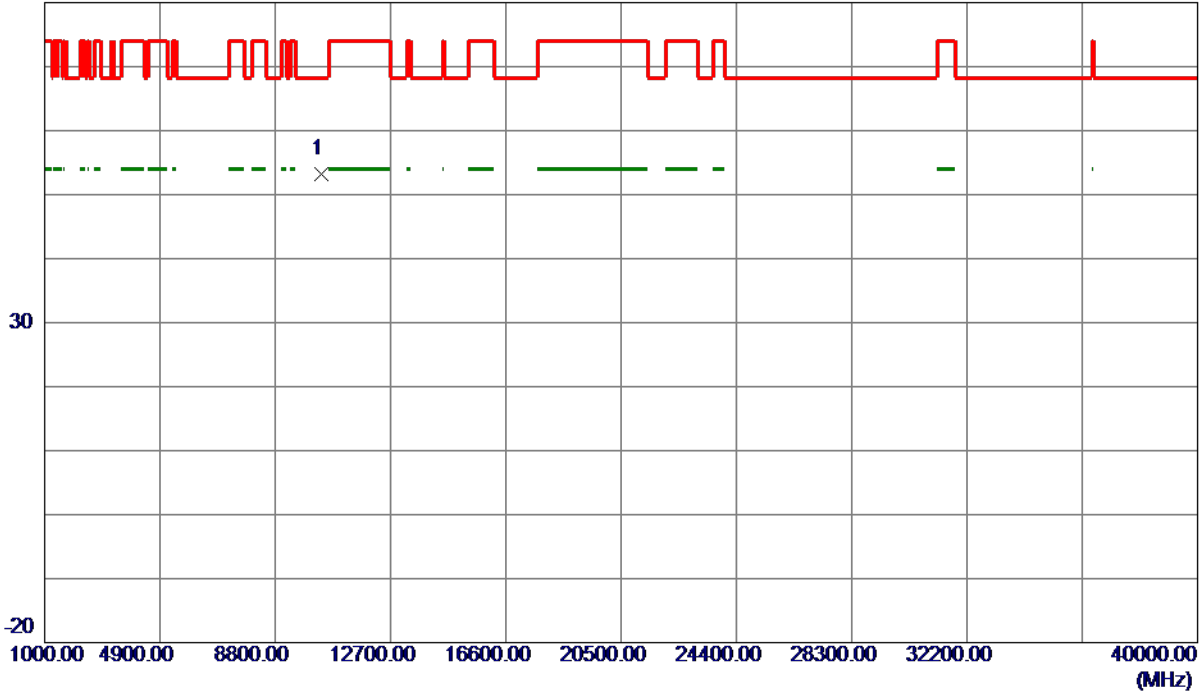

No.	Freq. MHz	Reading Level dBuV/m	Correct Factor dB	Measure ment dBuV/m	Limit dBuV/m	Margin dB	Detector	Comment
1 *	10359.0250	38.65	14.62	53.27	68.30	-15.03	Peak	

REMARKS:

- (1) Measurement Value = Reading Level + Correct Factor.
- (2) Margin Level = Measurement Value - Limit Value.

Orthogonal Axis	X
Test Mode	UNII-1_TX AC (VHT20) Mode 5180 MHz

Horizontal

130 dBuV/m

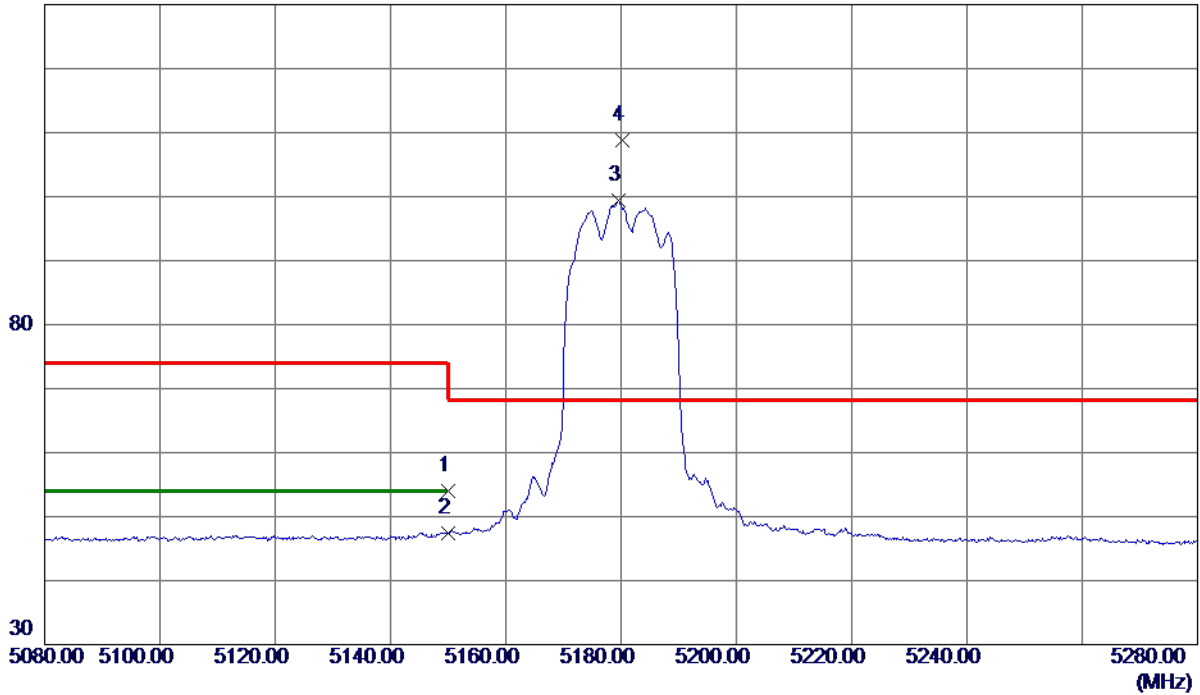

No.	Freq. MHz	Reading Level dBuV/m	Correct Factor dB	Measure ment dBuV/m	Limit dBuV/m	Margin dB	Detector	Comment
1	5150.0000	36.69	17.26	53.95	74.00	-20.05	Peak	
2	5150.0000	30.18	17.26	47.44	54.00	-6.56	AVG	
3	5179.5000	82.09	17.32	99.41	999.00	-899.59	AVG	No Limit
4 *	5180.3000	91.49	17.32	108.81	68.30	40.51	Peak	No Limit

REMARKS:

- (1) Measurement Value = Reading Level + Correct Factor.
- (2) Margin Level = Measurement Value - Limit Value.

Orthogonal Axis	X
Test Mode	UNII-1_TX AC (VHT20) Mode 5180 MHz

Horizontal

80 dBuV/m

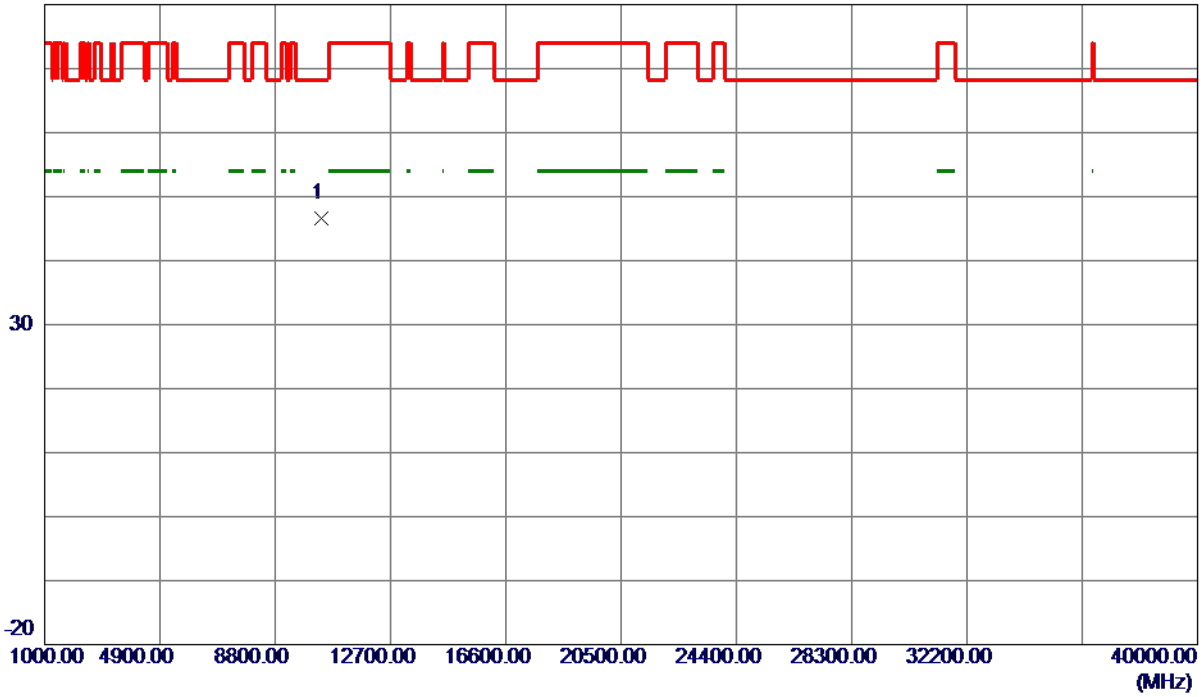

No.	Freq. MHz	Reading Level dBuV/m	Correct Factor dB	Measure ment dBuV/m	Limit dBuV/m	Margin dB	Detector	Comment
1 *	10358.0100	31.90	14.62	46.52	68.30	-21.78	Peak	

REMARKS:

- (1) Measurement Value = Reading Level + Correct Factor.
- (2) Margin Level = Measurement Value - Limit Value.

Orthogonal Axis	X
Test Mode	UNII-1_TX AC (VHT20) Mode 5200 MHz

Vertical

130 dBuV/m

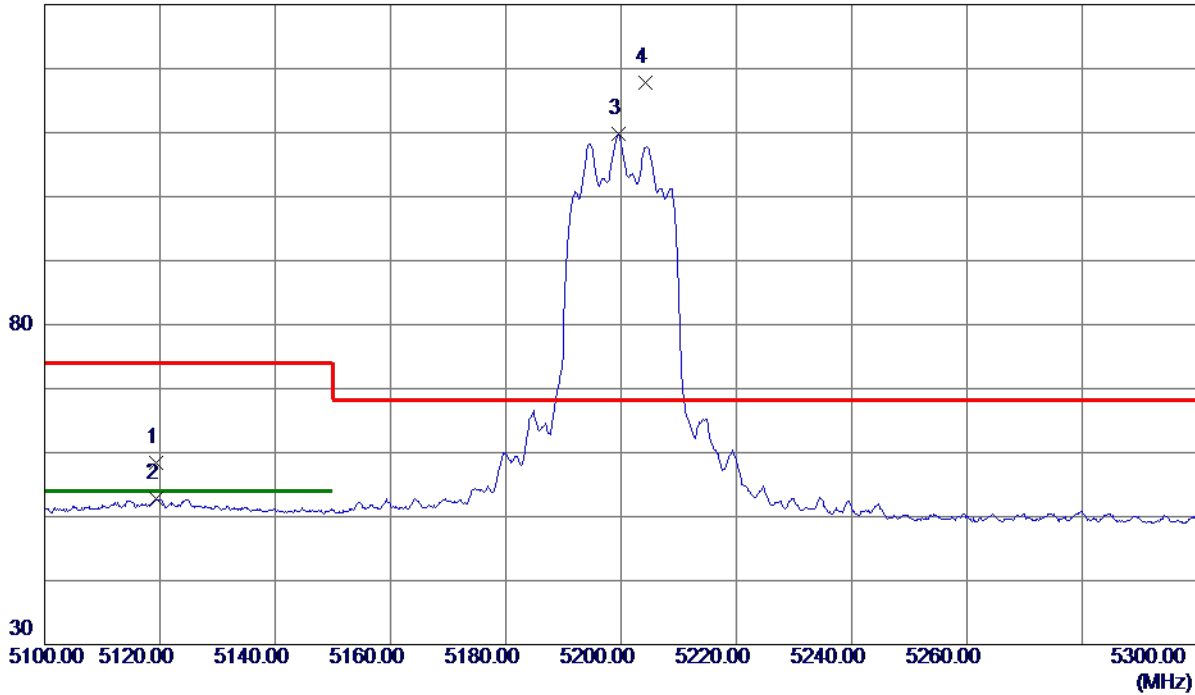

No.	Freq. MHz	Reading Level dBuV/m	Correct Factor dB	Measure ment dBuV/m	Limit dBuV/m	Margin dB	Detector	Comment
1	5119.4000	41.27	17.20	58.47	74.00	-15.53	Peak	
2	5119.4000	35.58	17.20	52.78	54.00	-1.22	AVG	
3	5199.5000	92.43	17.36	109.79	999.00	-889.21	AVG	No Limit
4 *	5204.2000	100.43	17.37	117.80	68.30	49.50	Peak	No Limit

REMARKS:

- (1) Measurement Value = Reading Level + Correct Factor.
- (2) Margin Level = Measurement Value - Limit Value.

Orthogonal Axis	X
Test Mode	UNII-1_TX AC (VHT20) Mode 5200 MHz

Vertical

80 dBuV/m

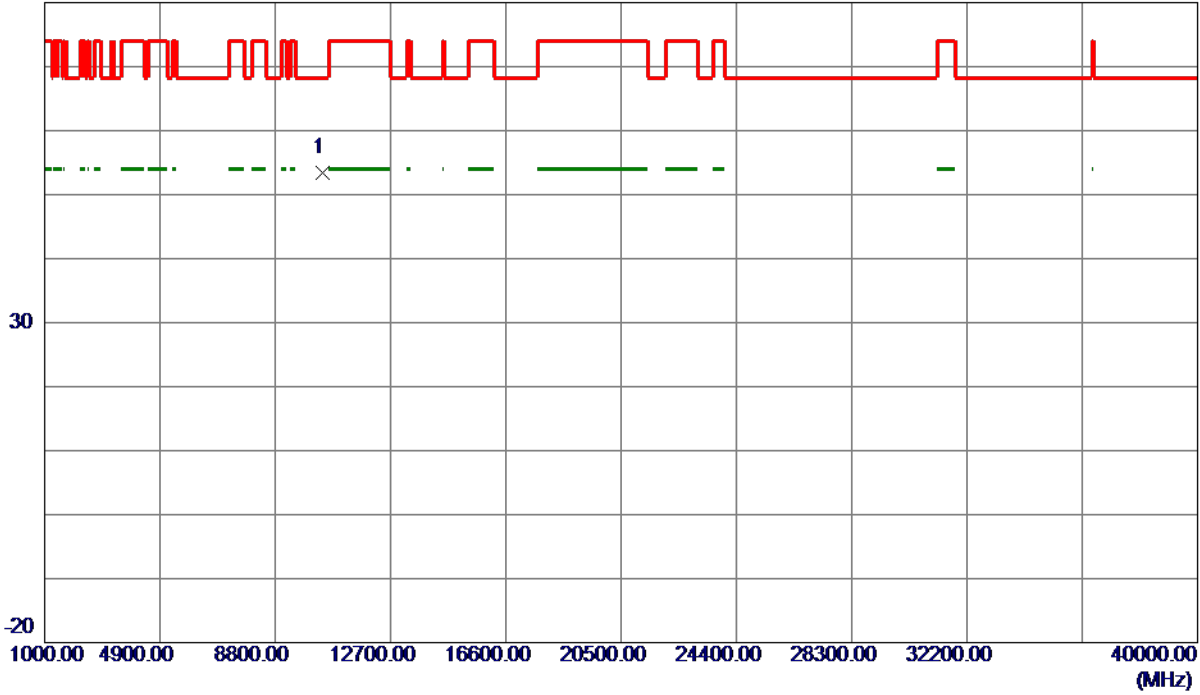

No.	Freq. MHz	Reading Level dBuV/m	Correct Factor dB	Measure ment dBuV/m	Limit dBuV/m	Margin dB	Detector	Comment
1 *	10401.1000	38.69	14.69	53.38	68.30	-14.92	Peak	

REMARKS:

- (1) Measurement Value = Reading Level + Correct Factor.
- (2) Margin Level = Measurement Value - Limit Value.

Orthogonal Axis	X
Test Mode	UNII-1_TX AC (VHT20) Mode 5200 MHz

Horizontal

130 dBuV/m

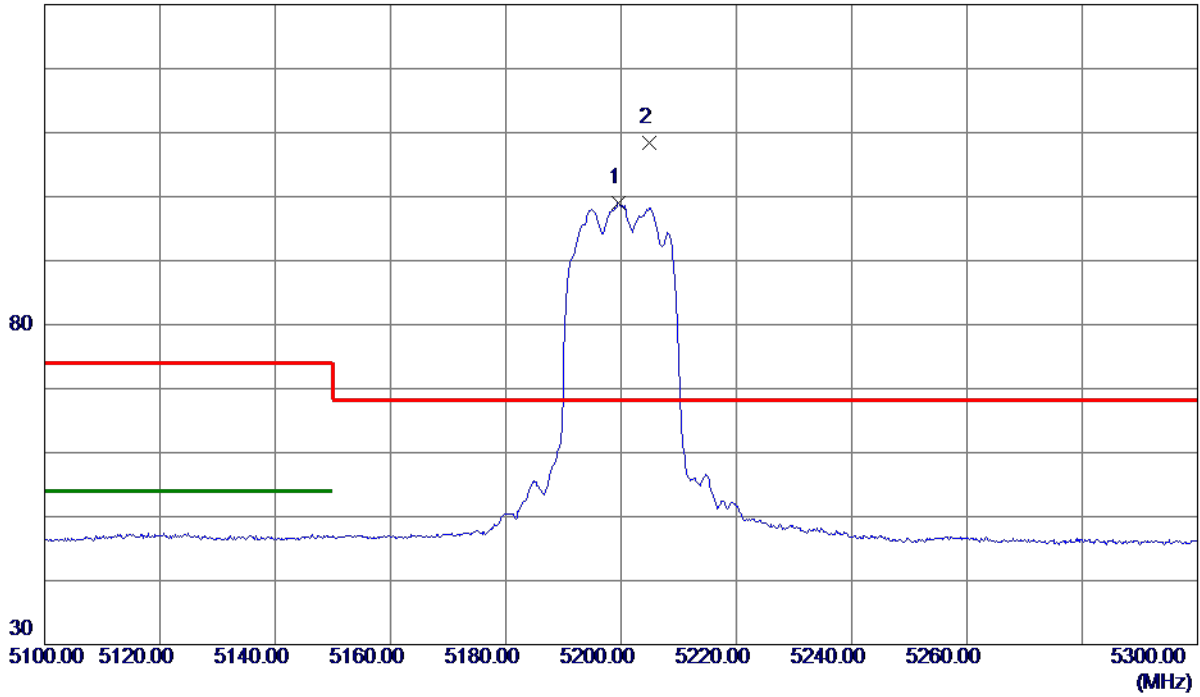

No.	Freq. MHz	Reading Level dBuV/m	Correct Factor dB	Measure ment dBuV/m	Limit dBuV/m	Margin dB	Detector	Comment
1	5199.6000	81.58	17.36	98.94	999.00	-900.06	AVG	No Limit
2 *	5204.9000	91.04	17.37	108.41	68.30	40.11	Peak	No Limit

REMARKS:

- (1) Measurement Value = Reading Level + Correct Factor.
- (2) Margin Level = Measurement Value - Limit Value.

Orthogonal Axis	X
Test Mode	UNII-1_TX AC (VHT20) Mode 5200 MHz

Horizontal

80 dBuV/m

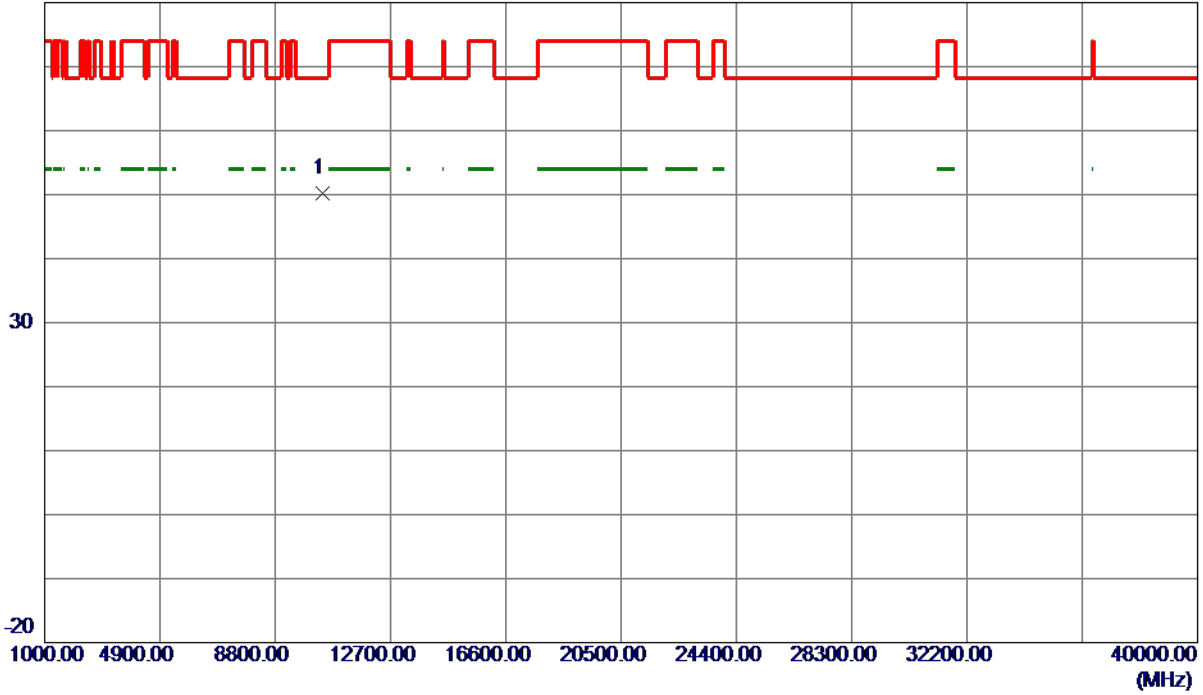

No.	Freq. MHz	Reading Level dBuV/m	Correct Factor dB	Measure ment dBuV/m	Limit dBuV/m	Margin dB	Detector	Comment
1 *	10391.0400	35.44	14.67	50.11	68.30	-18.19	Peak	

REMARKS:

- (1) Measurement Value = Reading Level + Correct Factor.
- (2) Margin Level = Measurement Value - Limit Value.

Orthogonal Axis	X
Test Mode	UNII-1_TX AC (VHT20) Mode 5240 MHz

Vertical

130 dBuV/m

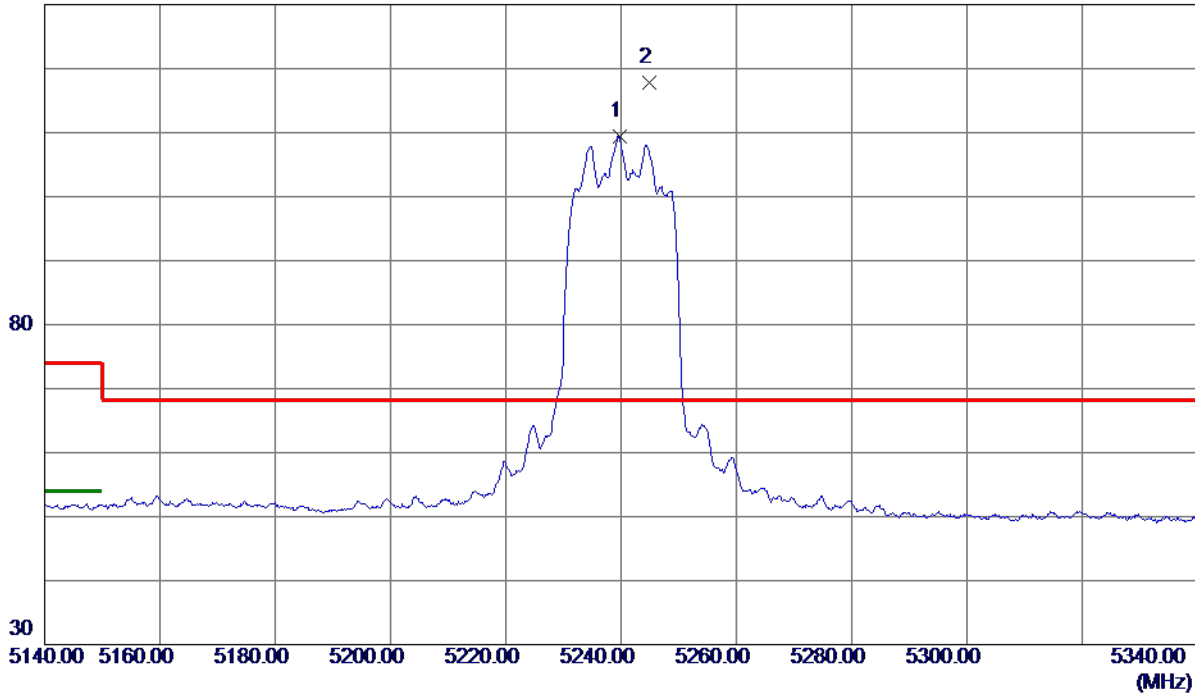

No.	Freq. MHz	Reading Level dBuV/m	Correct Factor dB	Measure ment dBuV/m	Limit dBuV/m	Margin dB	Detector	Comment
1	5239.7000	91.90	17.44	109.34	999.00	-889.66	AVG	No Limit
2 *	5244.8000	100.34	17.45	117.79	68.30	49.49	Peak	No Limit

REMARKS:

- (1) Measurement Value = Reading Level + Correct Factor.
- (2) Margin Level = Measurement Value - Limit Value.

Orthogonal Axis	X
Test Mode	UNII-1_TX AC (VHT20) Mode 5240 MHz

Vertical

80 dBuV/m

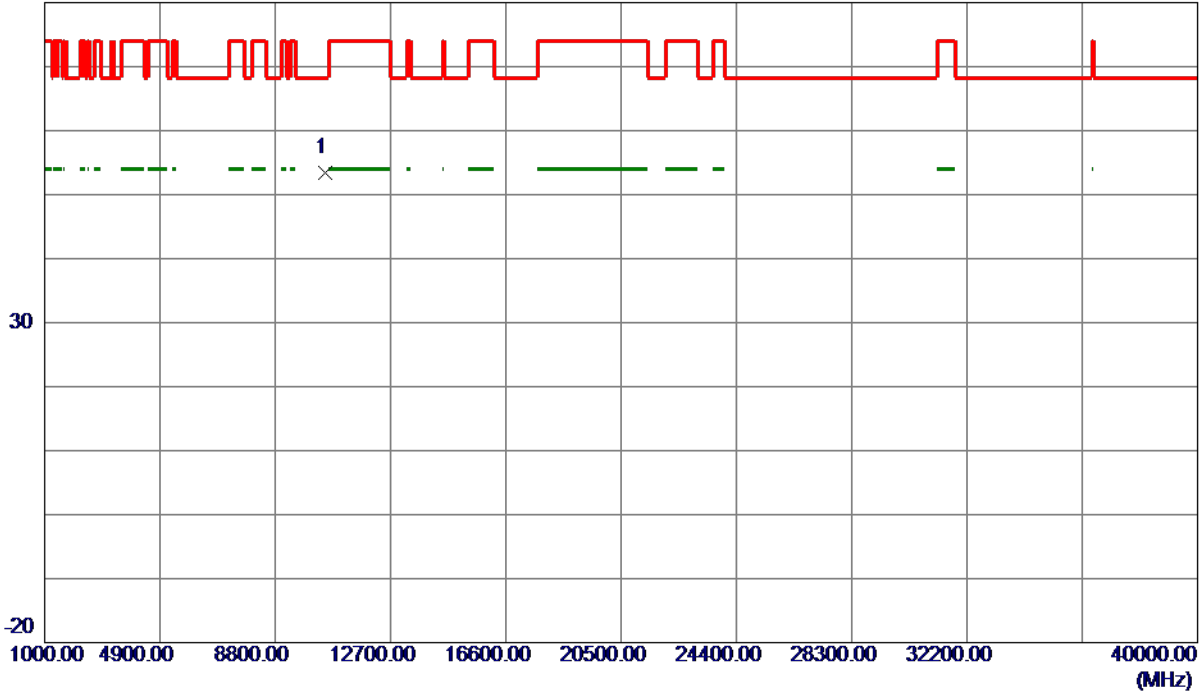

No.	Freq. MHz	Reading Level dBuV/m	Correct Factor dB	Measure ment dBuV/m	Limit dBuV/m	Margin dB	Detector	Comment
1 *	10483.2750	38.61	14.83	53.44	68.30	-14.86	Peak	

REMARKS:

- (1) Measurement Value = Reading Level + Correct Factor.
- (2) Margin Level = Measurement Value - Limit Value.

Orthogonal Axis	X
Test Mode	UNII-1_TX AC (VHT20) Mode 5240 MHz

Horizontal

130 dBuV/m

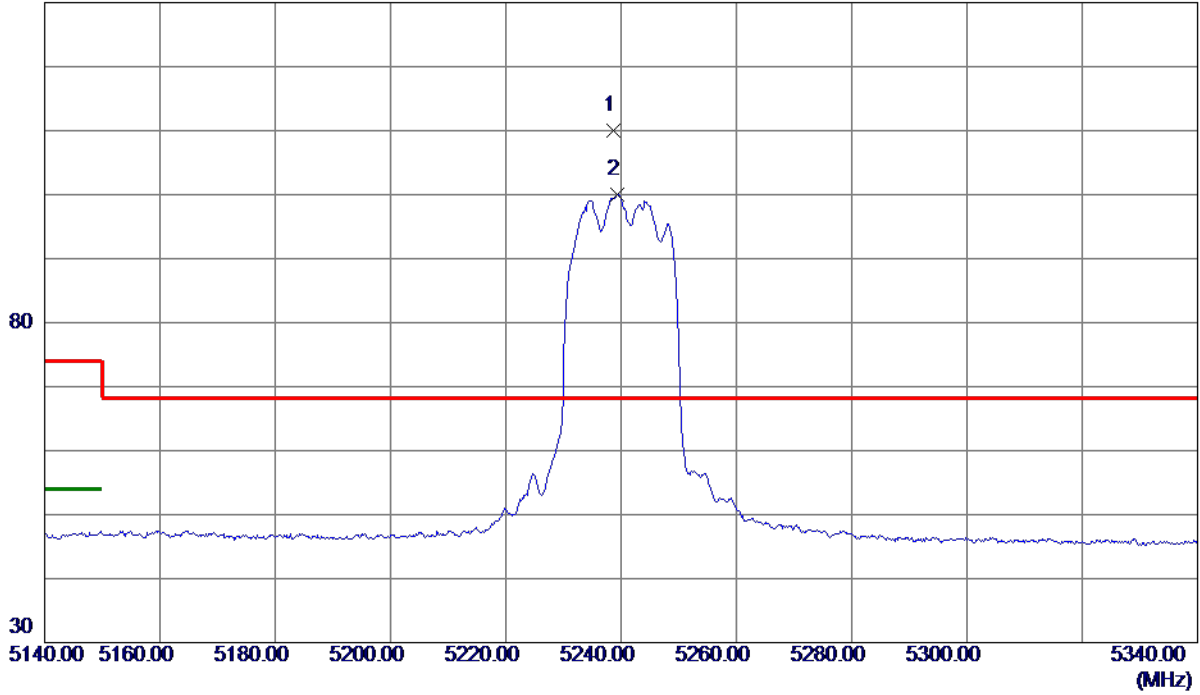

No.	Freq. MHz	Reading Level dBuV/m	Correct Factor dB	Measure ment dBuV/m	Limit dBuV/m	Margin dB	Detector	Comment
1 *	5238.7000	92.53	17.44	109.97	68.30	41.67	Peak	No Limit
2	5239.4000	82.52	17.44	99.96	999.00	-899.04	AVG	No Limit

REMARKS:

- (1) Measurement Value = Reading Level + Correct Factor.
- (2) Margin Level = Measurement Value - Limit Value.

Orthogonal Axis	X
Test Mode	UNII-1_TX AC (VHT20) Mode 5240 MHz

Horizontal

80 dBuV/m

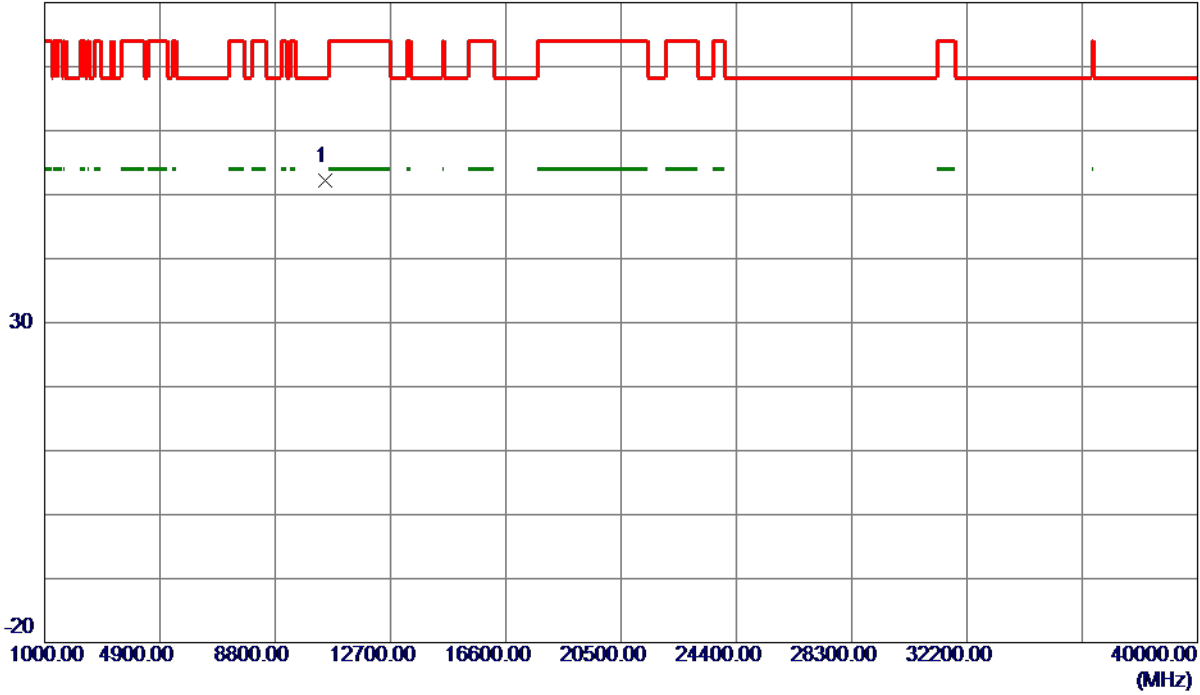

No.	Freq. MHz	Reading Level dBuV/m	Correct Factor dB	Measure ment dBuV/m	Limit dBuV/m	Margin dB	Detector	Comment
1 *	10480.6300	37.27	14.83	52.10	68.30	-16.20	Peak	

REMARKS:

- (1) Measurement Value = Reading Level + Correct Factor.
- (2) Margin Level = Measurement Value - Limit Value.

Orthogonal Axis	X
Test Mode	UNII-1_TX AC (VHT40) Mode 5190 MHz

Vertical

130 dBuV/m

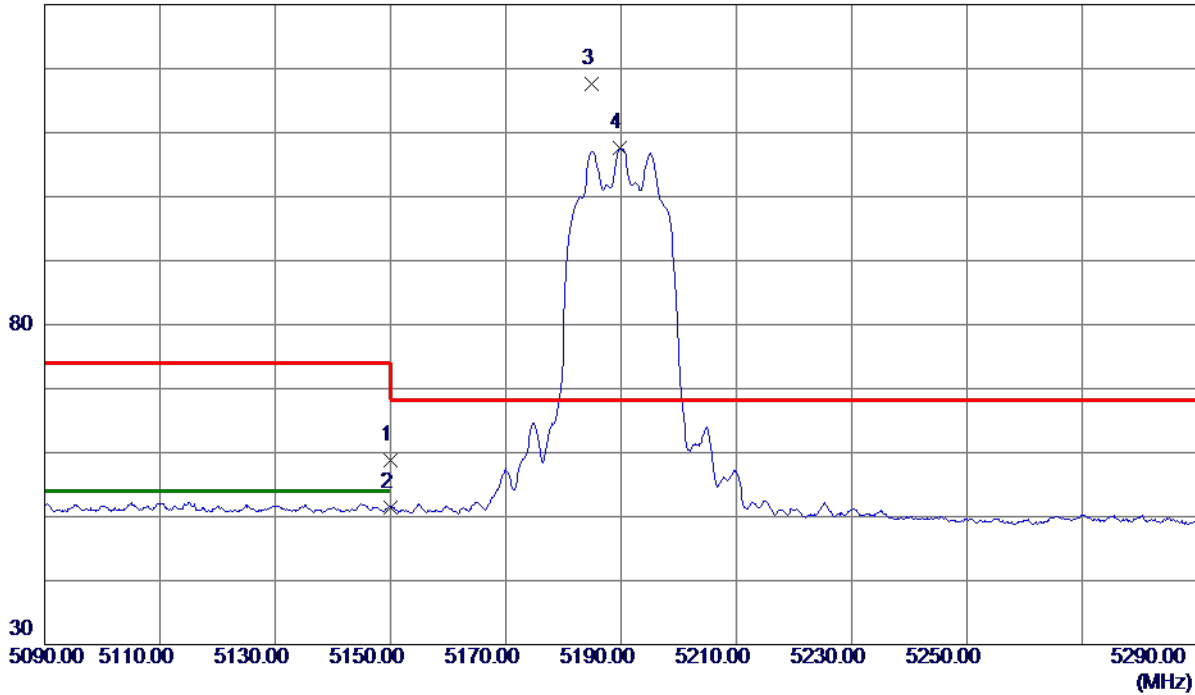

No.	Freq. MHz	Reading Level dBuV/m	Correct Factor dB	Measure ment dBuV/m	Limit dBuV/m	Margin dB	Detector	Comment
1	5150.0000	41.62	17.26	58.88	74.00	-15.12	Peak	
2	5150.0000	34.20	17.26	51.46	54.00	-2.54	AVG	
3 *	5184.8000	100.24	17.33	117.57	68.30	49.27	Peak	No Limit
4	5189.7000	90.17	17.34	107.51	999.00	-891.49	AVG	No Limit

REMARKS:

- (1) Measurement Value = Reading Level + Correct Factor.
- (2) Margin Level = Measurement Value - Limit Value.

Orthogonal Axis	X
Test Mode	UNII-1_TX AC (VHT40) Mode 5190 MHz

Vertical

80 dBuV/m

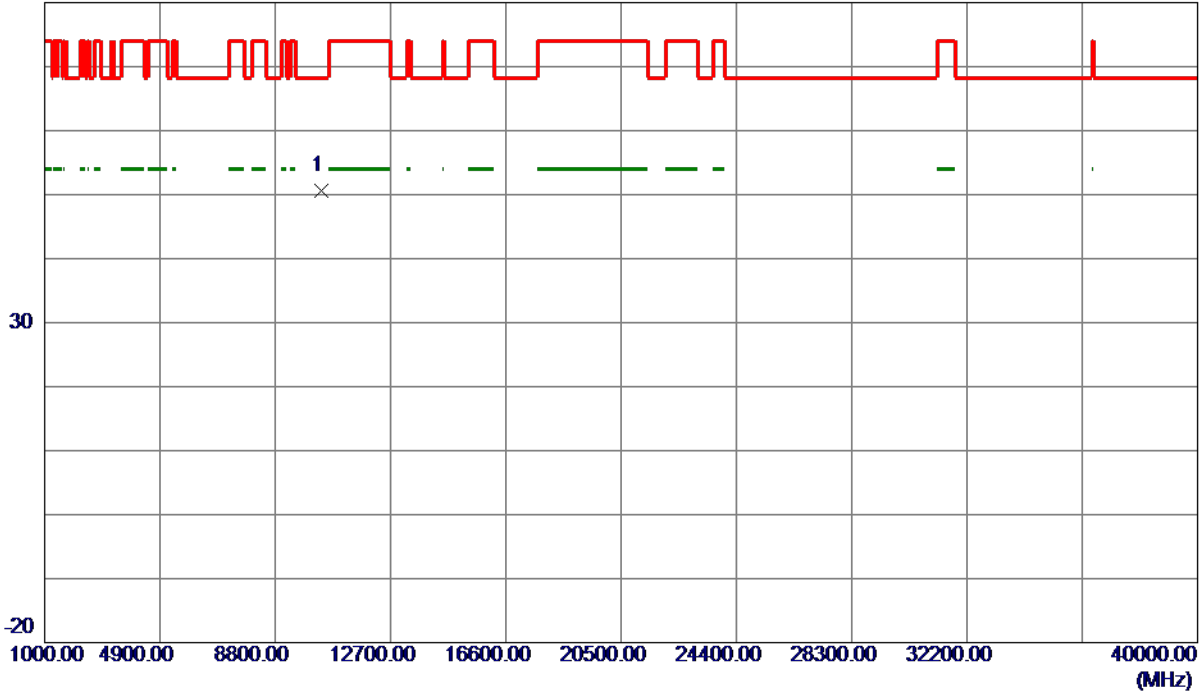

No.	Freq. MHz	Reading Level dBuV/m	Correct Factor dB	Measure ment dBuV/m	Limit dBuV/m	Margin dB	Detector	Comment
1 *	10380.4250	35.90	14.66	50.56	68.30	-17.74	Peak	

REMARKS:

- (1) Measurement Value = Reading Level + Correct Factor.
- (2) Margin Level = Measurement Value - Limit Value.

Orthogonal Axis	X
Test Mode	UNII-1_TX AC (VHT40) Mode 5190 MHz

Horizontal

130 dBuV/m

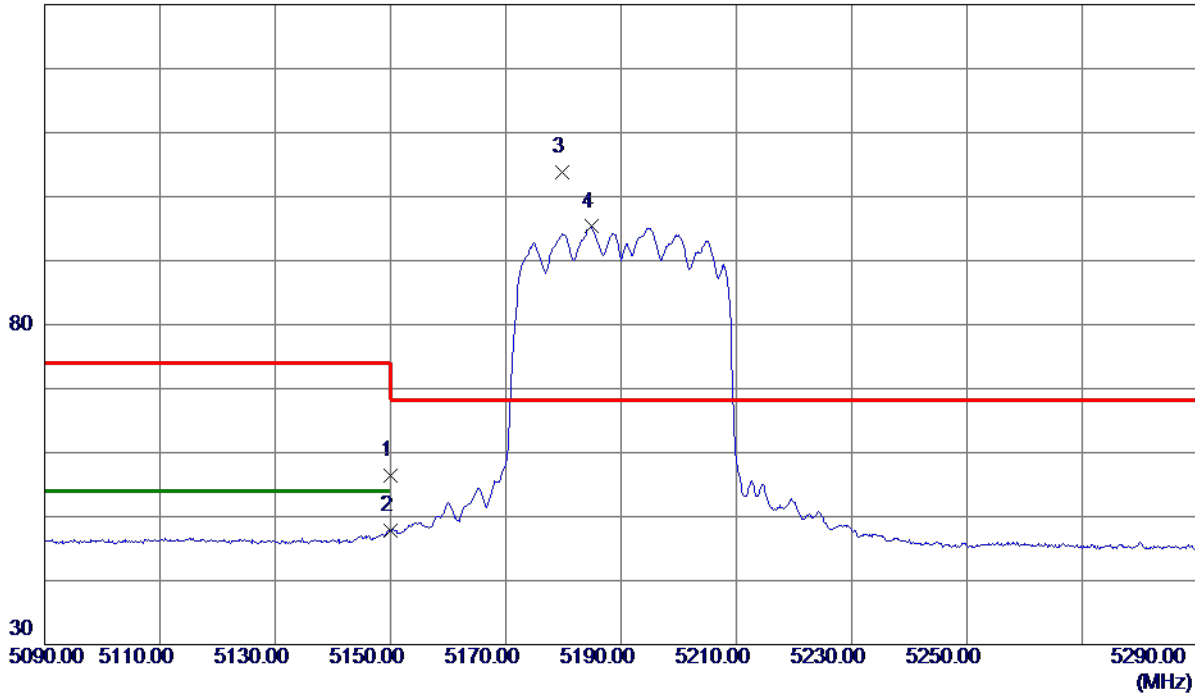

No.	Freq. MHz	Reading Level dBuV/m	Correct Factor dB	Measure ment dBuV/m	Limit dBuV/m	Margin dB	Detector	Comment
1	5150.0000	39.16	17.26	56.42	74.00	-17.58	Peak	
2	5150.0000	30.49	17.26	47.75	54.00	-6.25	AVG	
3 *	5179.7000	86.40	17.32	103.72	68.30	35.42	Peak	No Limit
4	5184.8000	77.97	17.33	95.30	999.00	-903.70	AVG	No Limit

REMARKS:

- (1) Measurement Value = Reading Level + Correct Factor.
- (2) Margin Level = Measurement Value - Limit Value.

Orthogonal Axis	X
Test Mode	UNII-1_TX AC (VHT40) Mode 5190 MHz

Horizontal

80 dBuV/m

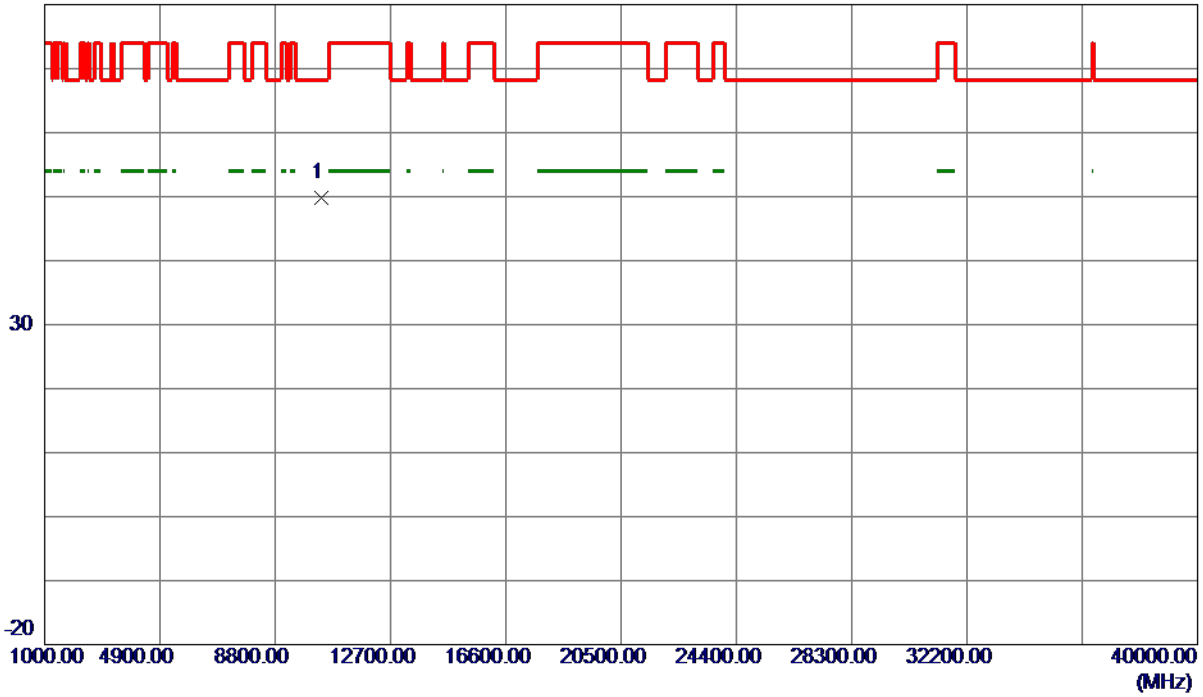

No.	Freq. MHz	Reading Level dBuV/m	Correct Factor dB	Measure ment dBuV/m	Limit dBuV/m	Margin dB	Detector	Comment
1 *	10380.6100	35.12	14.66	49.78	68.30	-18.52	Peak	

REMARKS:

- (1) Measurement Value = Reading Level + Correct Factor.
- (2) Margin Level = Measurement Value - Limit Value.

Orthogonal Axis	X
Test Mode	UNII-1_TX AC (VHT40) Mode 5230 MHz

Vertical

130 dBuV/m

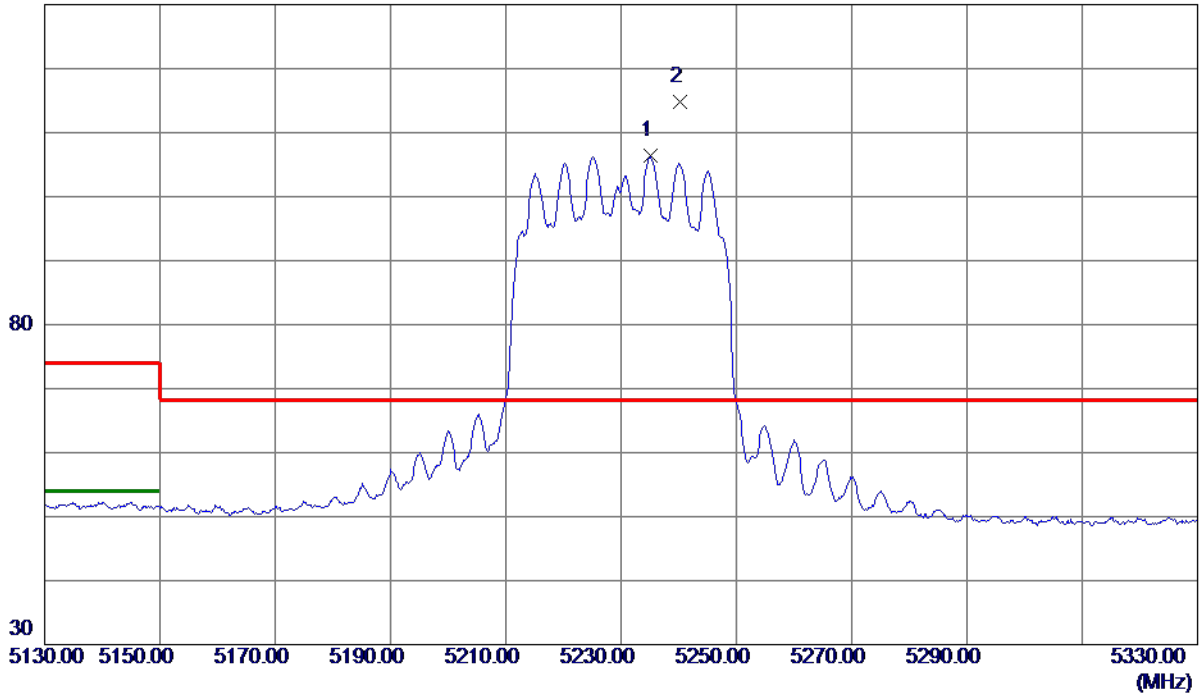

No.	Freq. MHz	Reading Level dBuV/m	Correct Factor dB	Measure ment dBuV/m	Limit dBuV/m	Margin dB	Detector	Comment
1	5235.1000	88.89	17.43	106.32	999.00	-892.68	AVG	No Limit
2 *	5240.2000	97.32	17.44	114.76	68.30	46.46	Peak	No Limit

REMARKS:

- (1) Measurement Value = Reading Level + Correct Factor.
- (2) Margin Level = Measurement Value - Limit Value.

Orthogonal Axis	X
Test Mode	UNII-1_TX AC (VHT40) Mode 5230 MHz

Vertical

80 dBuV/m

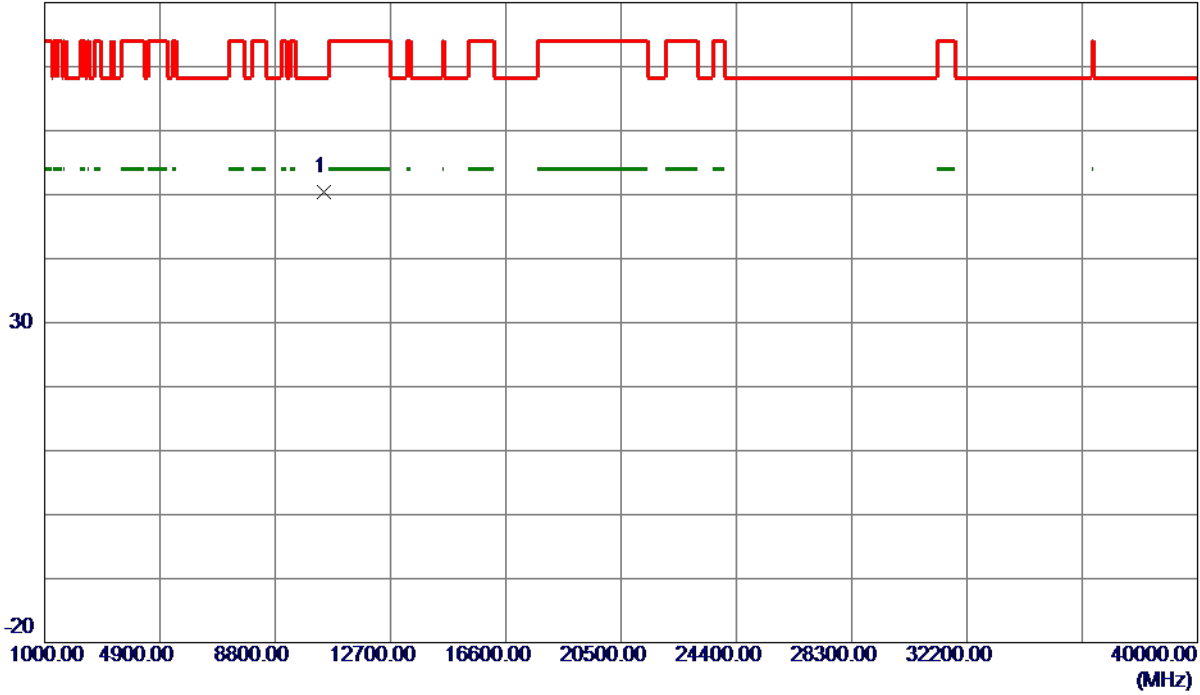

No.	Freq. MHz	Reading Level dBuV/m	Correct Factor dB	Measure ment dBuV/m	Limit dBuV/m	Margin dB	Detector	Comment
1 *	10451.0500	35.63	14.78	50.41	68.30	-17.89	Peak	

REMARKS:

- (1) Measurement Value = Reading Level + Correct Factor.
- (2) Margin Level = Measurement Value - Limit Value.

Orthogonal Axis	X
Test Mode	UNII-1_TX AC (VHT40) Mode 5230 MHz

Horizontal

130 dBuV/m

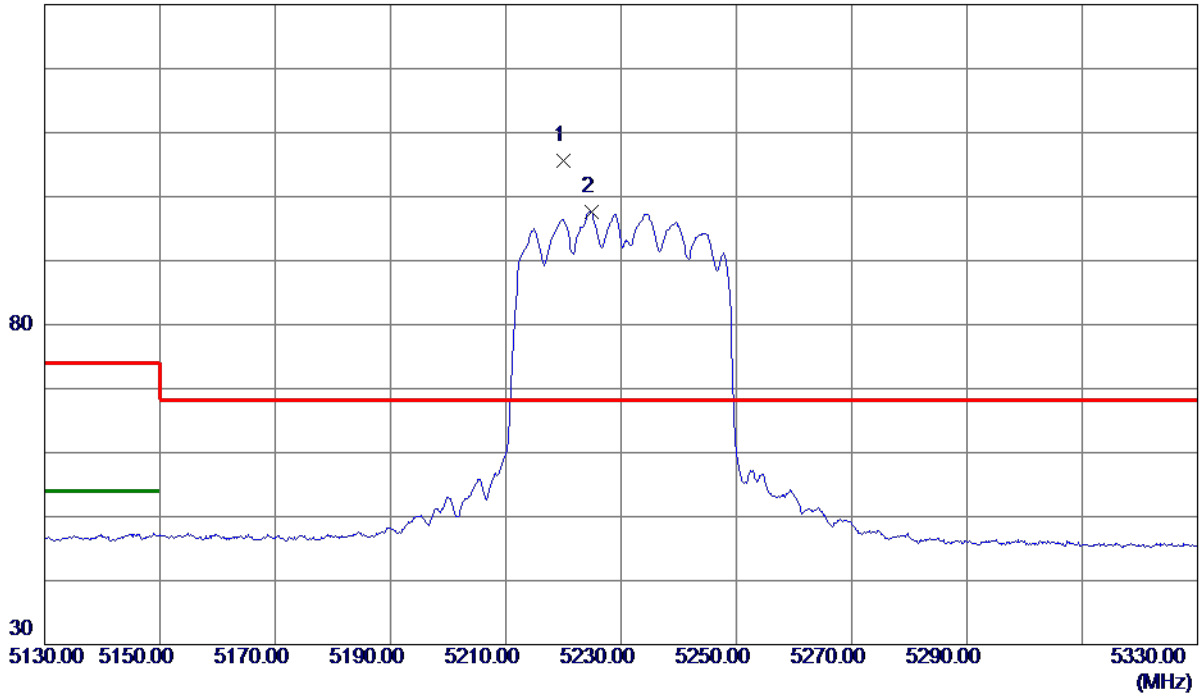

No.	Freq. MHz	Reading Level dBuV/m	Correct Factor dB	Measure ment dBuV/m	Limit dBuV/m	Margin dB	Detector	Comment
1 *	5220.1000	88.14	17.40	105.54	68.30	37.24	Peak	No Limit
2	5224.8000	80.26	17.41	97.67	999.00	-901.33	AVG	No Limit

REMARKS:

- (1) Measurement Value = Reading Level + Correct Factor.
- (2) Margin Level = Measurement Value - Limit Value.

Orthogonal Axis	X
Test Mode	UNII-1_TX AC (VHT40) Mode 5230 MHz

Horizontal

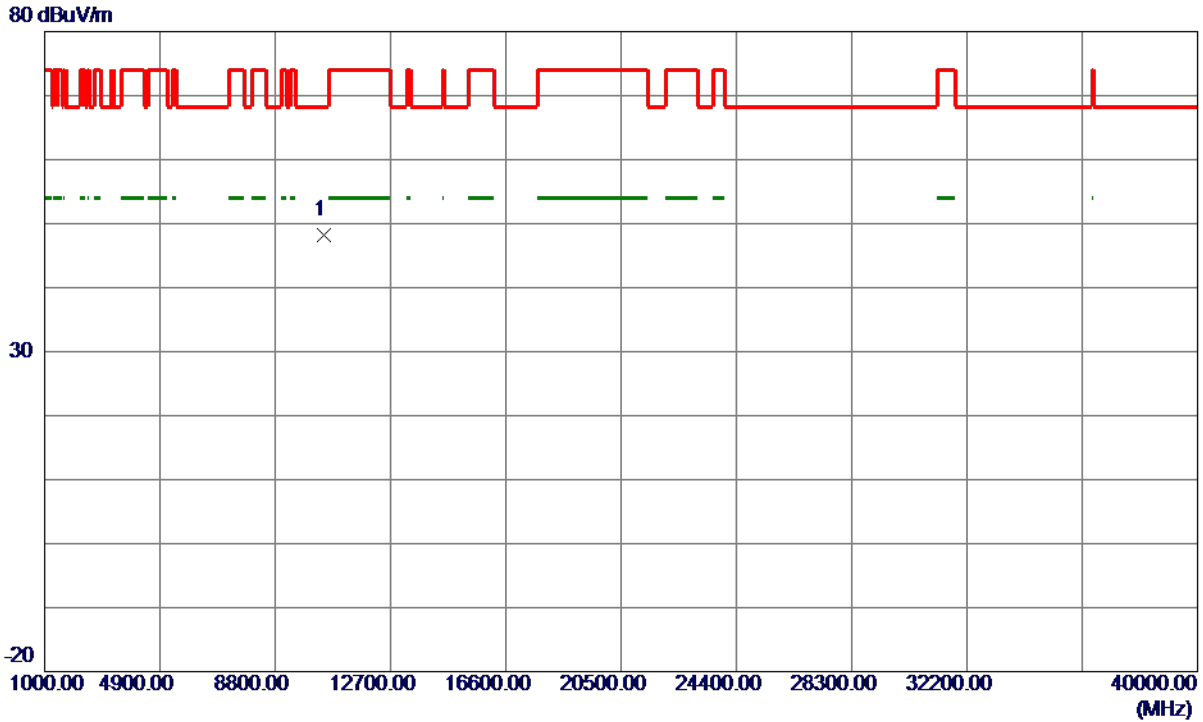

No.	Freq. MHz	Reading Level dBuV/m	Correct Factor dB	Measure ment dBuV/m	Limit dBuV/m	Margin dB	Detector	Comment
1 *	10451.1400	33.37	14.78	48.15	68.30	-20.15	Peak	

REMARKS:

- (1) Measurement Value = Reading Level + Correct Factor.
- (2) Margin Level = Measurement Value - Limit Value.

Orthogonal Axis	X
Test Mode	UNII-1_TX AC (VHT80) Mode 5210 MHz

Vertical

130 dBuV/m

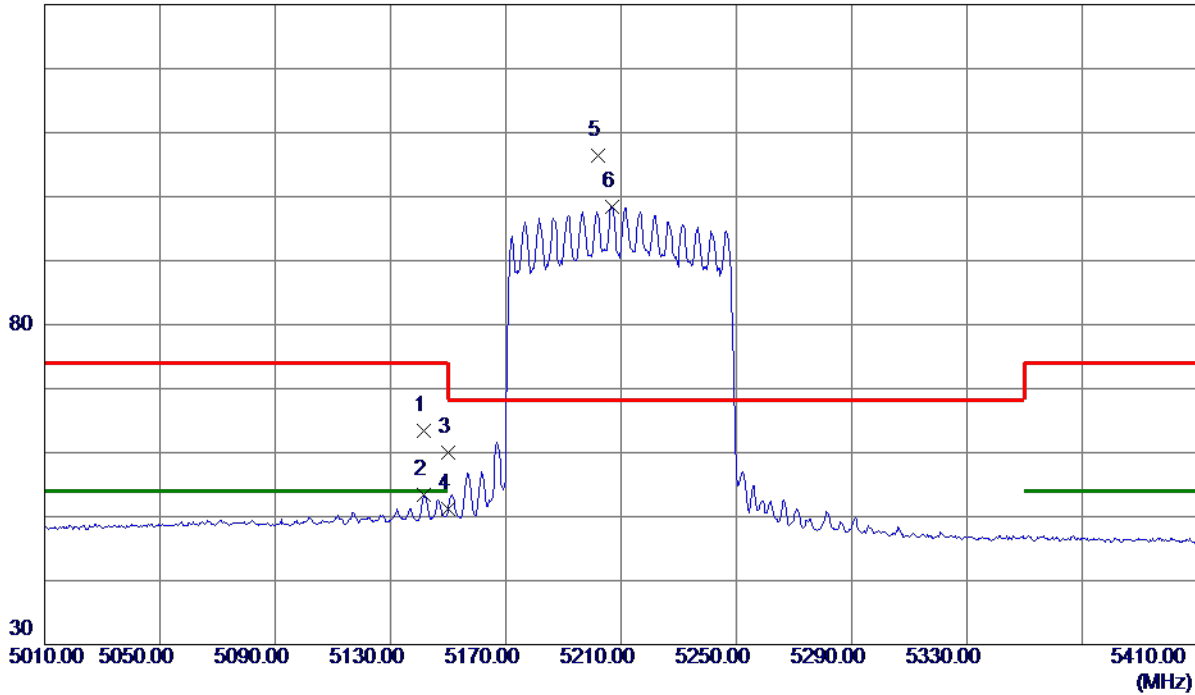

No.	Freq. MHz	Reading Level dBuV/m	Correct Factor dB	Measure ment dBuV/m	Limit dBuV/m	Margin dB	Detector	Comment
1	5141.4000	46.07	17.24	63.31	74.00	-10.69	Peak	
2	5141.4000	36.13	17.24	53.37	54.00	-0.63	AVG	
3	5150.0000	42.65	17.26	59.91	74.00	-14.09	Peak	
4	5150.0000	33.95	17.26	51.21	54.00	-2.79	AVG	
5 *	5201.8000	89.01	17.36	106.37	68.30	38.07	Peak	No Limit
6	5206.8000	81.03	17.37	98.40	999.00	-900.60	AVG	No Limit

REMARKS:

- (1) Measurement Value = Reading Level + Correct Factor.
- (2) Margin Level = Measurement Value - Limit Value.

Orthogonal Axis	X
Test Mode	UNII-1_TX AC (VHT80) Mode 5210 MHz

Vertical

80 dBuV/m

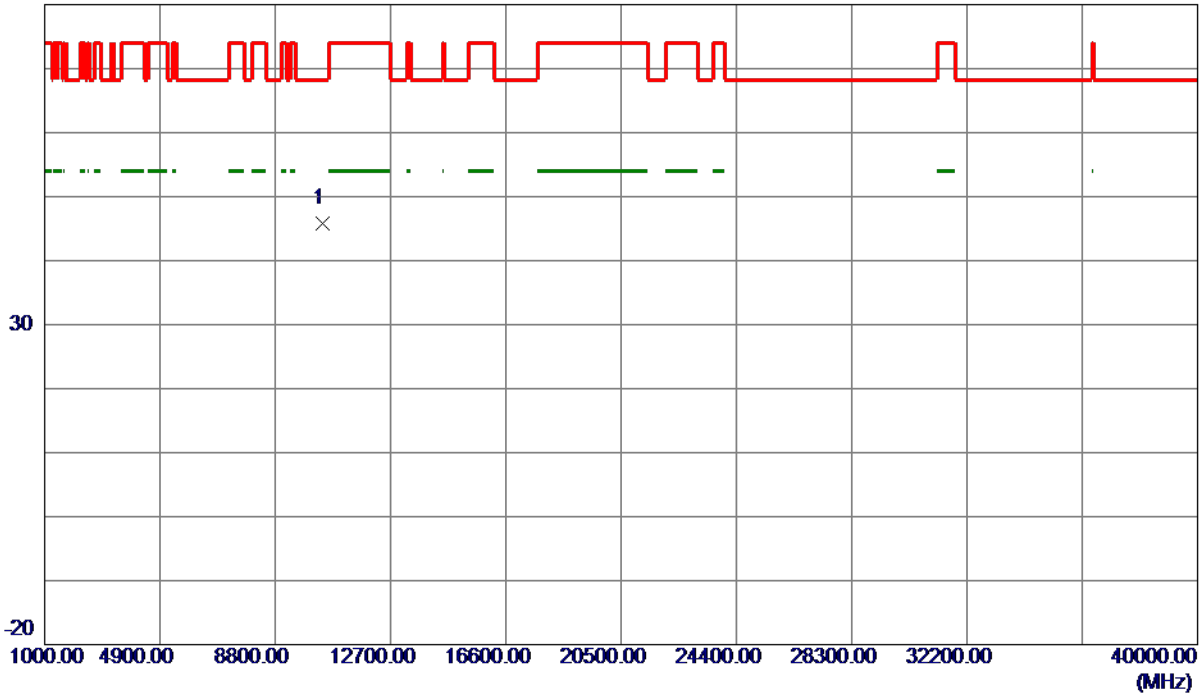

No.	Freq. MHz	Reading Level dBuV/m	Correct Factor dB	Measure ment dBuV/m	Limit dBuV/m	Margin dB	Detector	Comment
1 *	10407.5250	31.04	14.70	45.74	68.30	-22.56	Peak	

REMARKS:

- (1) Measurement Value = Reading Level + Correct Factor.
- (2) Margin Level = Measurement Value - Limit Value.

Orthogonal Axis	X
Test Mode	UNII-1_TX AC (VHT80) Mode 5210 MHz

Horizontal

130 dBuV/m

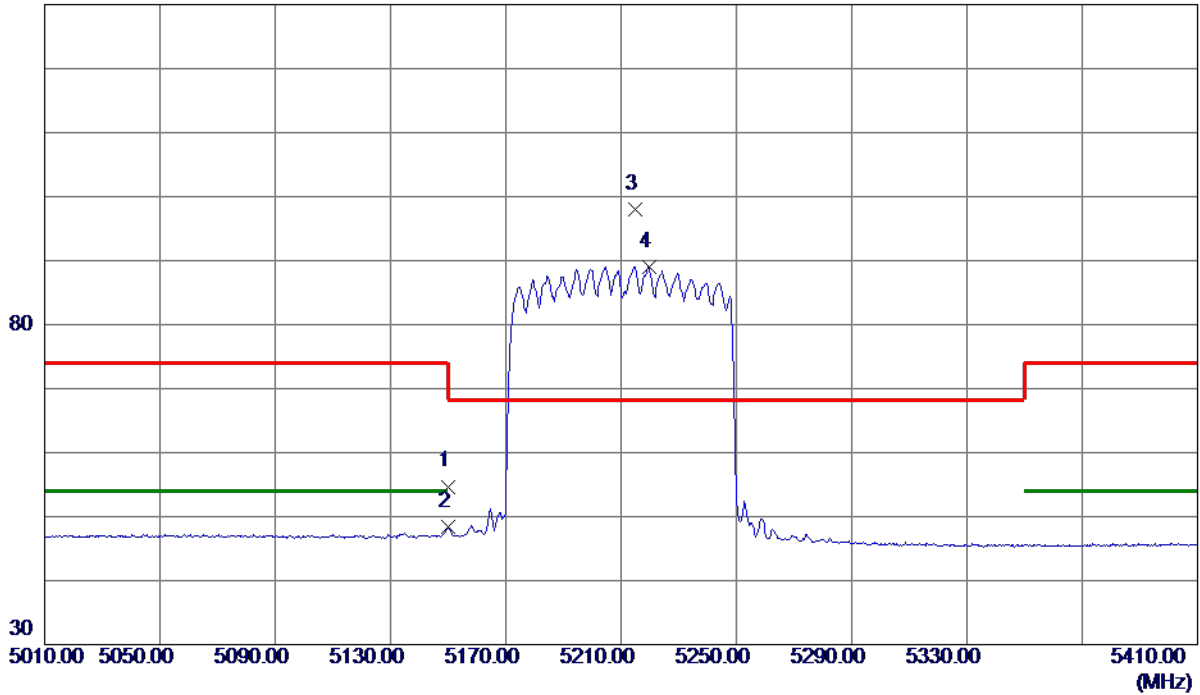

No.	Freq. MHz	Reading Level dBuV/m	Correct Factor dB	Measure ment dBuV/m	Limit dBuV/m	Margin dB	Detector	Comment
1	5150.0000	37.44	17.26	54.70	74.00	-19.30	Peak	
2	5150.0000	31.14	17.26	48.40	54.00	-5.60	AVG	
3 *	5215.0000	80.58	17.39	97.97	68.30	29.67	Peak	No Limit
4	5219.6000	71.62	17.40	89.02	999.00	-909.98	AVG	No Limit

REMARKS:

- (1) Measurement Value = Reading Level + Correct Factor.
- (2) Margin Level = Measurement Value - Limit Value.

Orthogonal Axis	X
Test Mode	UNII-1_TX AC (VHT80) Mode 5210 MHz

Horizontal

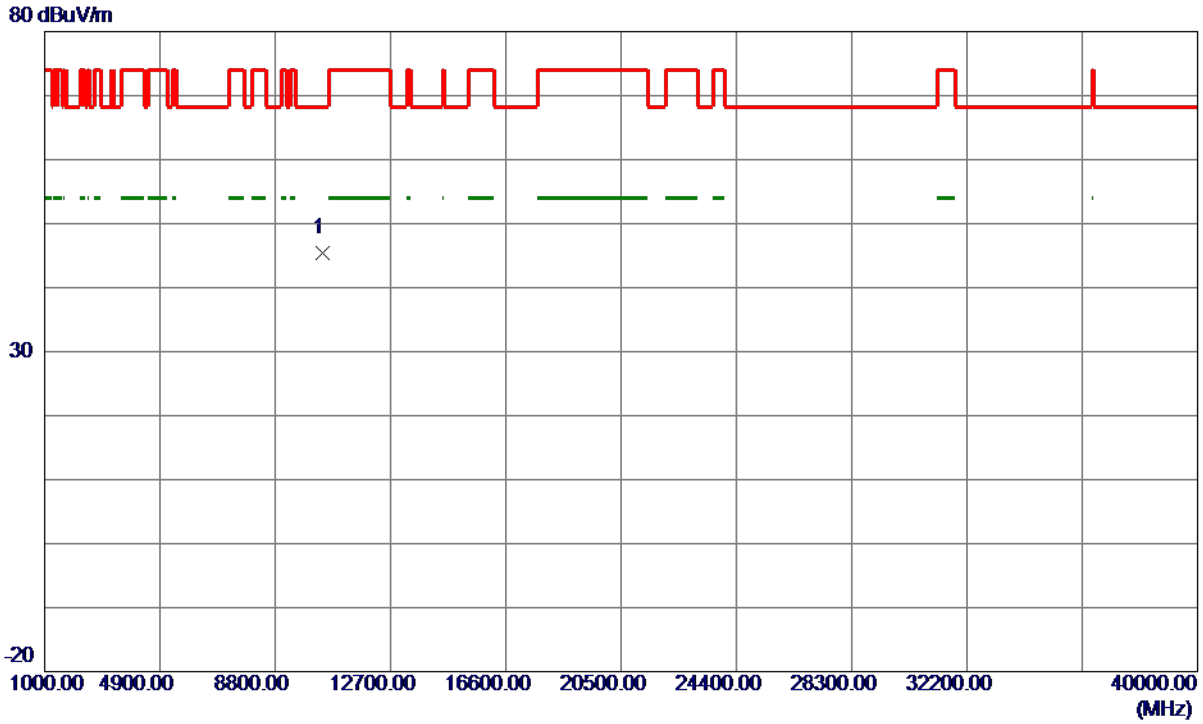

No.	Freq. MHz	Reading Level dBuV/m	Correct Factor dB	Measure ment dBuV/m	Limit dBuV/m	Margin dB	Detector	Comment
1 *	10420.3500	30.68	14.72	45.40	68.30	-22.90	Peak	

REMARKS:

- (1) Measurement Value = Reading Level + Correct Factor.
- (2) Margin Level = Measurement Value - Limit Value.

Orthogonal Axis	X
Test Mode	UNII-3_TX AC (VHT20) Mode 5745 MHz

Vertical

130 dBuV/m

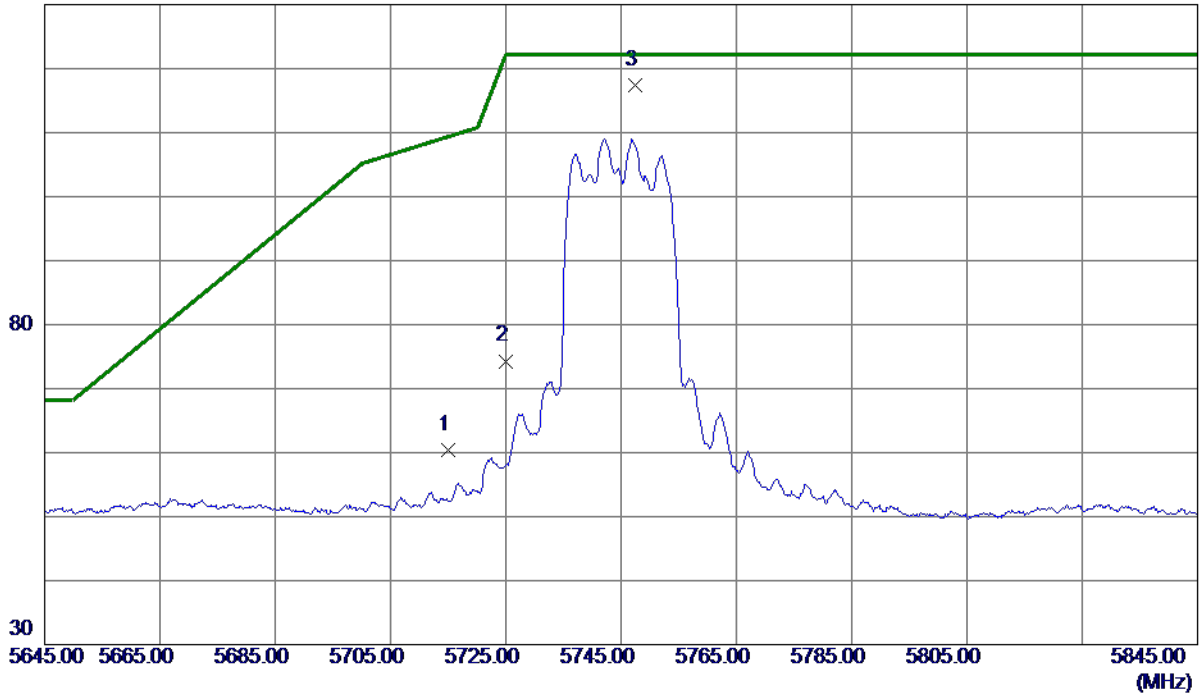

No.	Freq. MHz	Reading Level dBuV/m	Correct Factor dB	Measure ment dBuV/m	Limit dBuV/m	Margin dB	Detector	Comment
1	5715.0000	41.67	18.65	60.32	109.40	-49.08	Peak	
2	5725.0000	55.61	18.69	74.30	122.20	-47.90	Peak	
3 *	5747.4000	98.72	18.76	117.48	122.20	-4.72	Peak	No Limit

REMARKS:

- (1) Measurement Value = Reading Level + Correct Factor.
- (2) Margin Level = Measurement Value - Limit Value.

Orthogonal Axis	X
Test Mode	UNII-3_TX AC (VHT20) Mode 5745 MHz

Vertical

80 dBuV/m

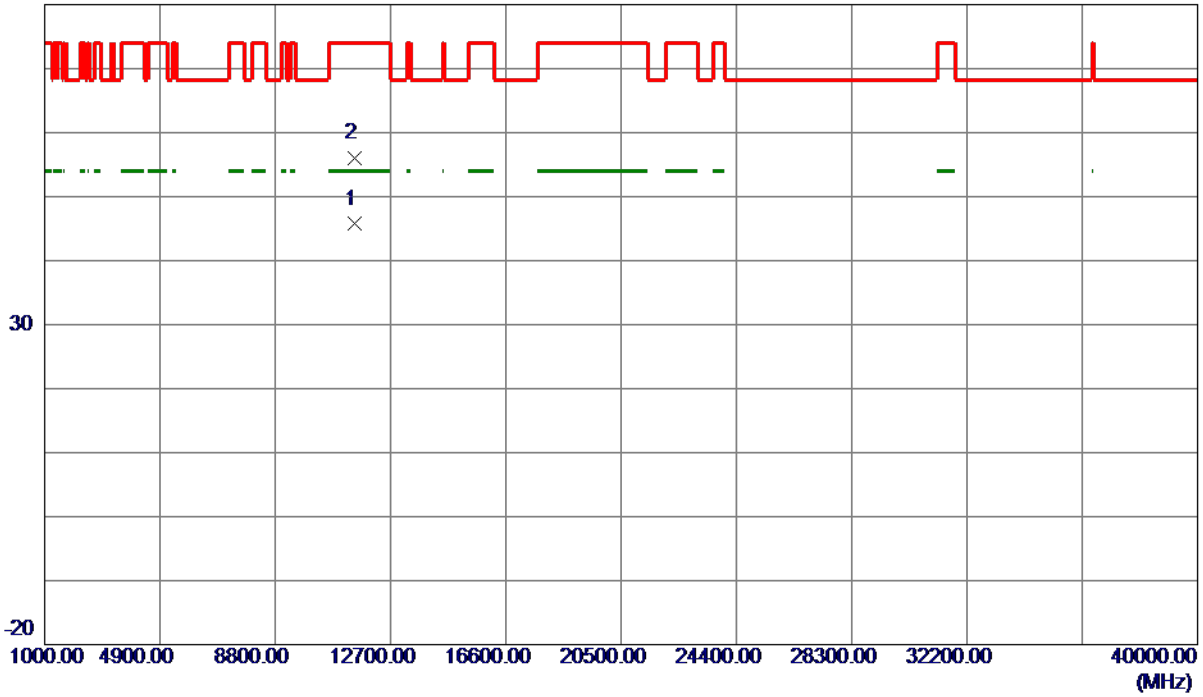

No.	Freq. MHz	Reading Level dBuV/m	Correct Factor dB	Measure ment dBuV/m	Limit dBuV/m	Margin dB	Detector	Comment
1 *	11488.6500	28.55	17.15	45.70	54.00	-8.30	AVG	
2	11493.7000	38.74	17.17	55.91	74.00	-18.09	Peak	

REMARKS:

- (1) Measurement Value = Reading Level + Correct Factor.
- (2) Margin Level = Measurement Value - Limit Value.

Orthogonal Axis	X
Test Mode	UNII-3_TX AC (VHT20) Mode 5745 MHz

Horizontal

130 dBuV/m

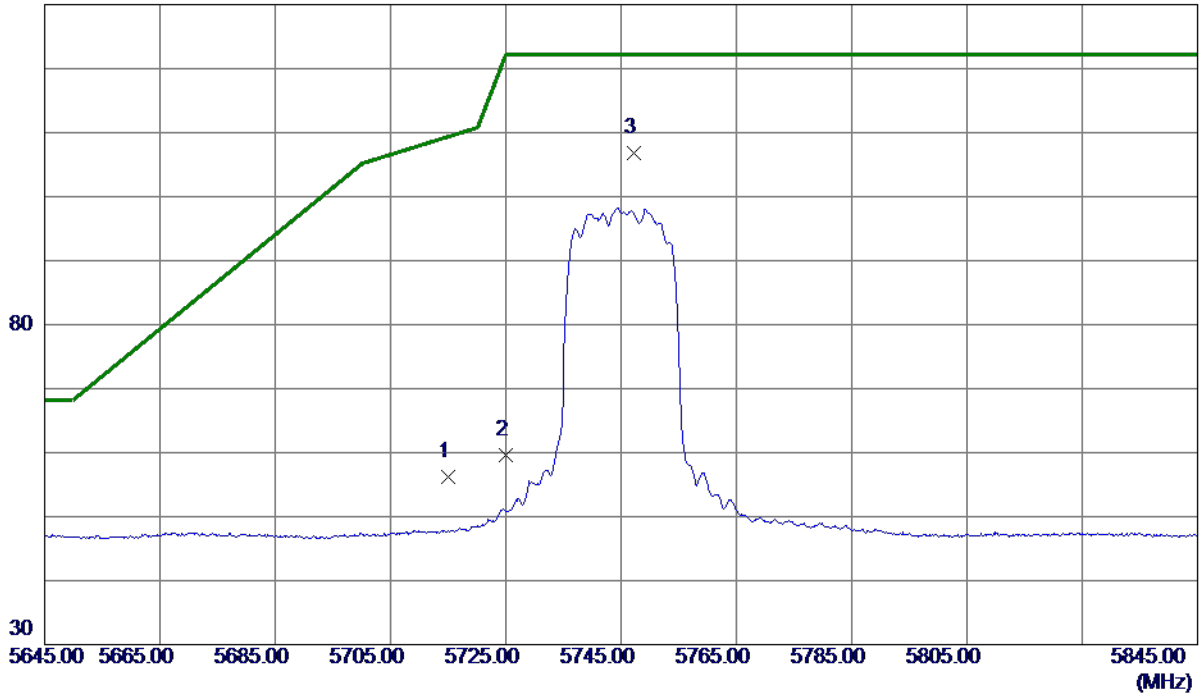

No.	Freq. MHz	Reading Level dBuV/m	Correct Factor dB	Measure ment dBuV/m	Limit dBuV/m	Margin dB	Detector	Comment
1	5715.0000	37.57	18.65	56.22	109.40	-53.18	Peak	
2	5725.0000	40.85	18.69	59.54	122.20	-62.66	Peak	
3 *	5747.2000	87.95	18.76	106.71	122.20	-15.49	Peak	No Limit

REMARKS:

- (1) Measurement Value = Reading Level + Correct Factor.
- (2) Margin Level = Measurement Value - Limit Value.

Orthogonal Axis	X
Test Mode	UNII-3_TX AC (VHT20) Mode 5745 MHz

Horizontal

80 dBuV/m

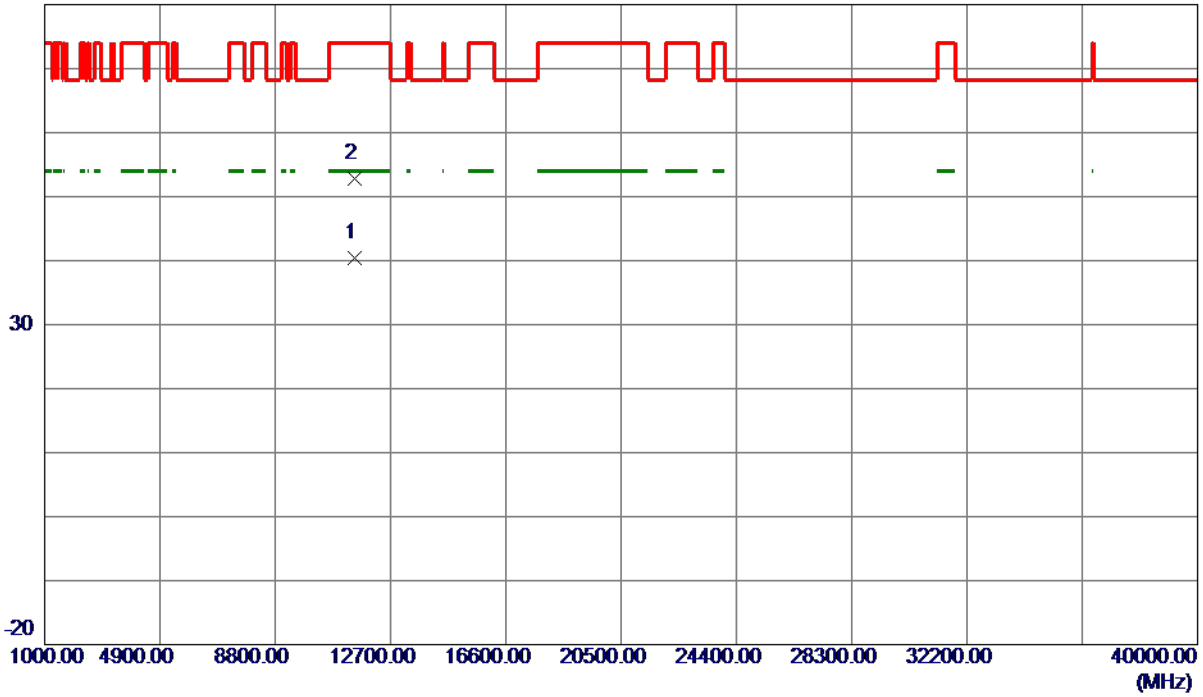

No.	Freq. MHz	Reading Level dBuV/m	Correct Factor dB	Measure ment dBuV/m	Limit dBuV/m	Margin dB	Detector	Comment
1 *	11489.1400	23.22	17.15	40.37	54.00	-13.63	AVG	
2	11494.1700	35.60	17.17	52.77	74.00	-21.23	Peak	

REMARKS:

- (1) Measurement Value = Reading Level + Correct Factor.
- (2) Margin Level = Measurement Value - Limit Value.

Orthogonal Axis	X
Test Mode	UNII-3_TX AC (VHT20) Mode 5785 MHz

Vertical

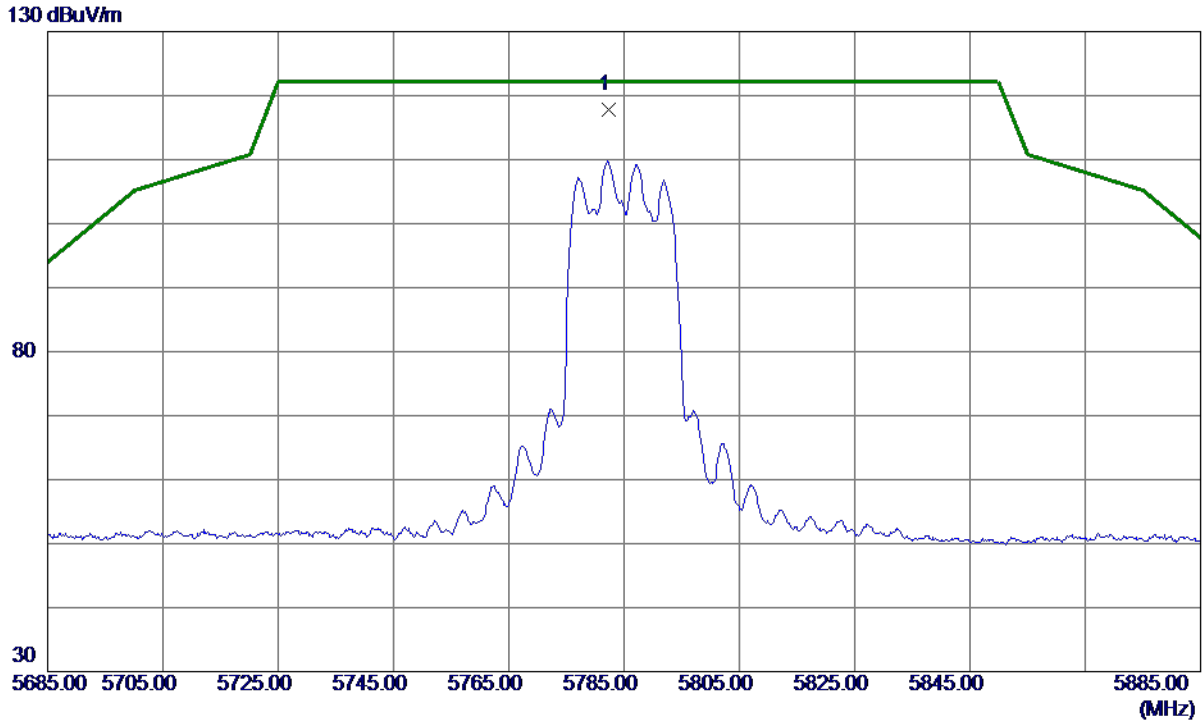

No.	Freq. MHz	Reading Level dBuV/m	Correct Factor dB	Measure ment dBuV/m	Limit dBuV/m	Margin dB	Detector	Comment
1 *	5782.3000	98.92	18.87	117.79	122.20	-4.41	Peak	No Limit

REMARKS:

- (1) Measurement Value = Reading Level + Correct Factor.
- (2) Margin Level = Measurement Value - Limit Value.

Orthogonal Axis	X
Test Mode	UNII-3_TX AC (VHT20) Mode 5785 MHz

Vertical

80 dBuV/m

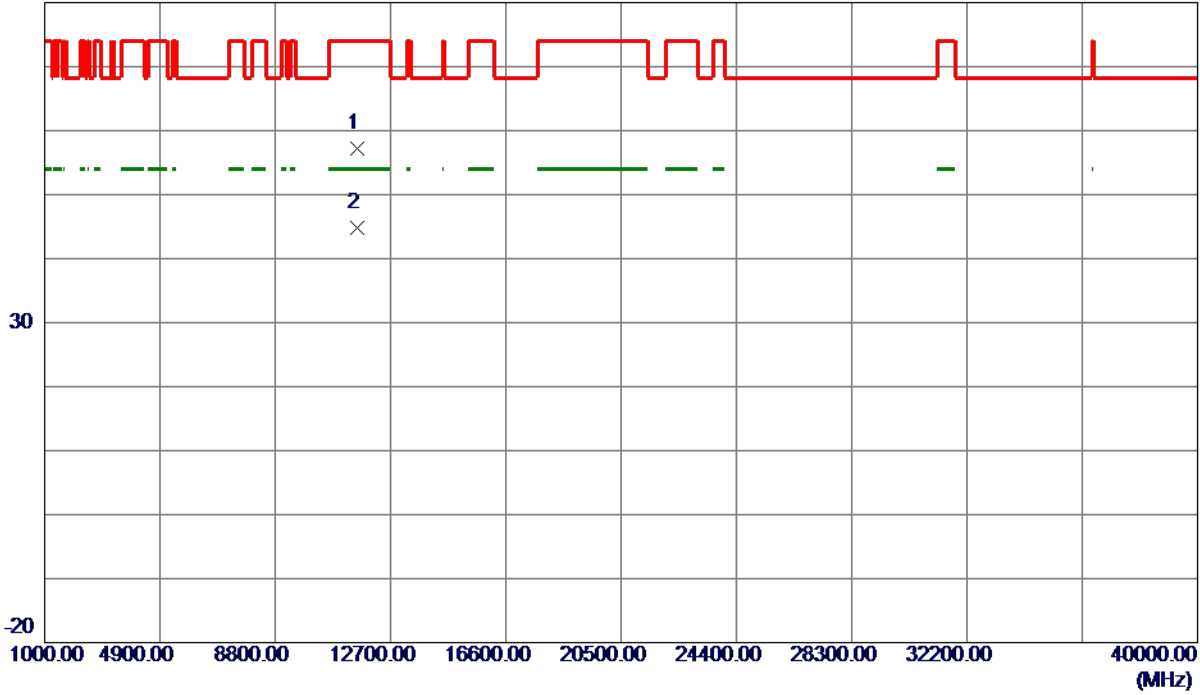

No.	Freq. MHz	Reading Level dBuV/m	Correct Factor dB	Measure ment dBuV/m	Limit dBuV/m	Margin dB	Detector	Comment
1	11573.2250	40.00	17.20	57.20	74.00	-16.80	Peak	
2 *	11573.4250	27.67	17.20	44.87	54.00	-9.13	AVG	

REMARKS:

- (1) Measurement Value = Reading Level + Correct Factor.
- (2) Margin Level = Measurement Value - Limit Value.

Orthogonal Axis	X
Test Mode	UNII-3_TX AC (VHT20) Mode 5785 MHz

Horizontal

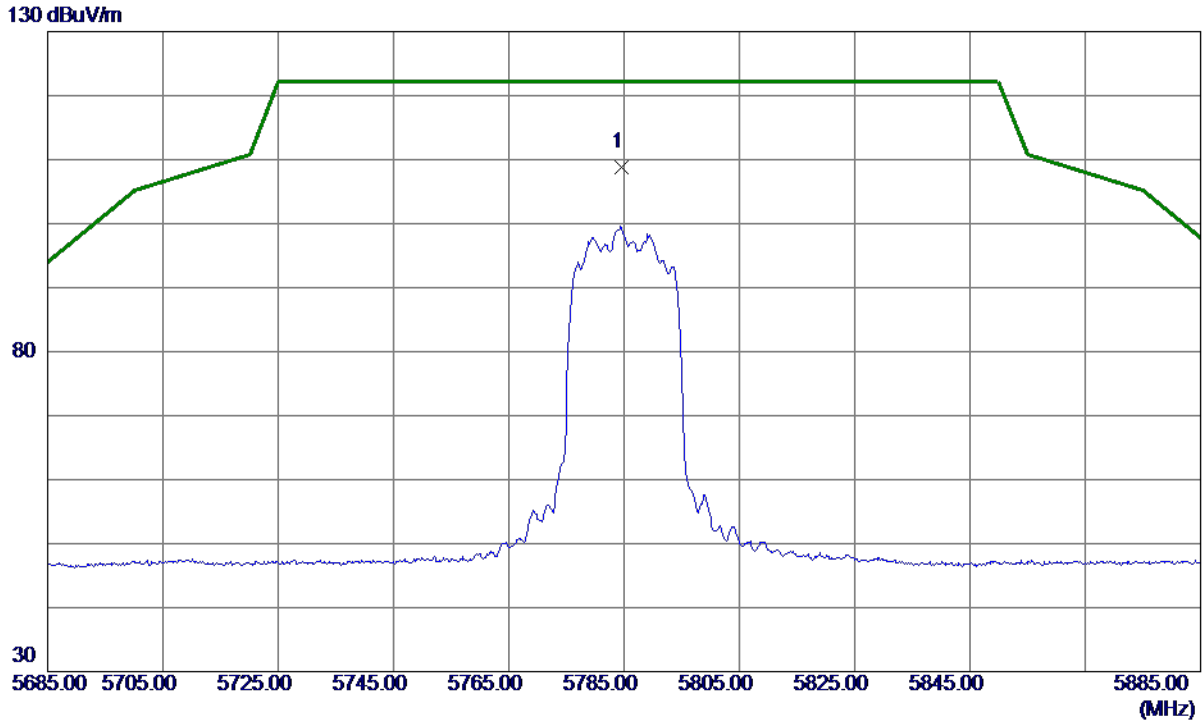

No.	Freq. MHz	Reading Level dBuV/m	Correct Factor dB	Measure ment dBuV/m	Limit dBuV/m	Margin dB	Detector	Comment
1 *	5784.5000	89.95	18.88	108.83	122.20	-13.37	Peak	No Limit

REMARKS:

- (1) Measurement Value = Reading Level + Correct Factor.
- (2) Margin Level = Measurement Value - Limit Value.

Orthogonal Axis	X
Test Mode	UNII-3_TX AC (VHT20) Mode 5785 MHz

Horizontal

80 dBuV/m

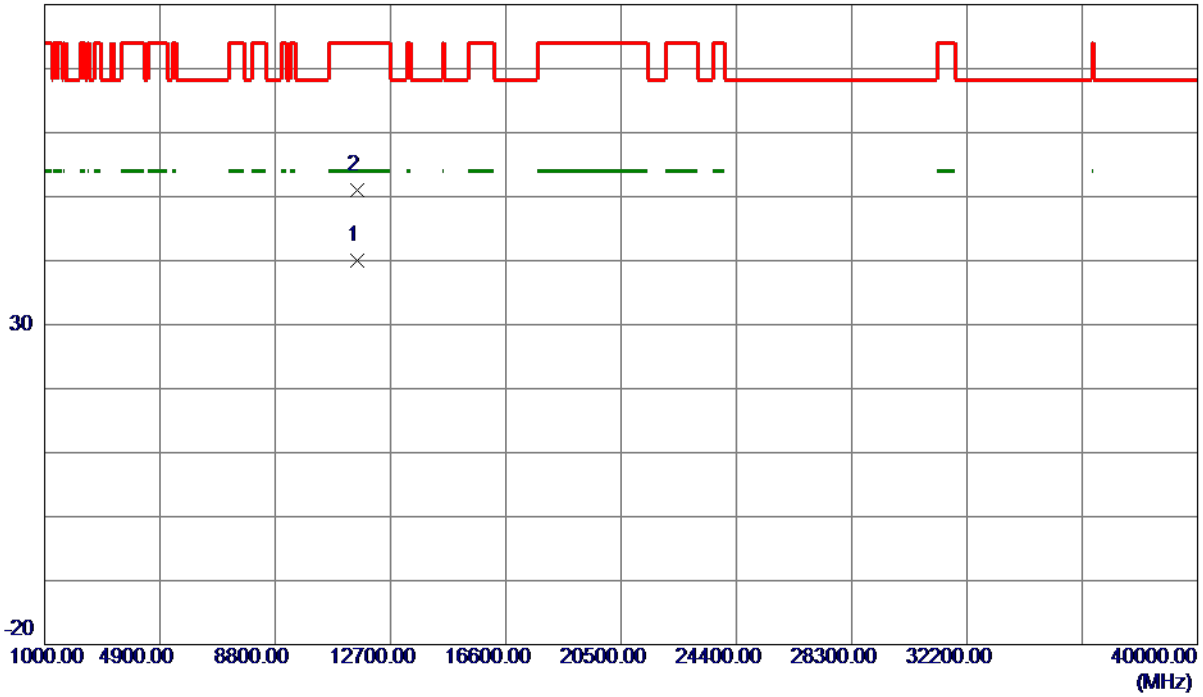

No.	Freq. MHz	Reading Level dBuV/m	Correct Factor dB	Measure ment dBuV/m	Limit dBuV/m	Margin dB	Detector	Comment
1 *	11573.8099	22.84	17.20	40.04	54.00	-13.96	AVG	
2	11578.1200	33.75	17.20	50.95	74.00	-23.05	Peak	

REMARKS:

- (1) Measurement Value = Reading Level + Correct Factor.
- (2) Margin Level = Measurement Value - Limit Value.

Orthogonal Axis	X
Test Mode	UNII-3_TX AC (VHT20) Mode 5825 MHz

Vertical

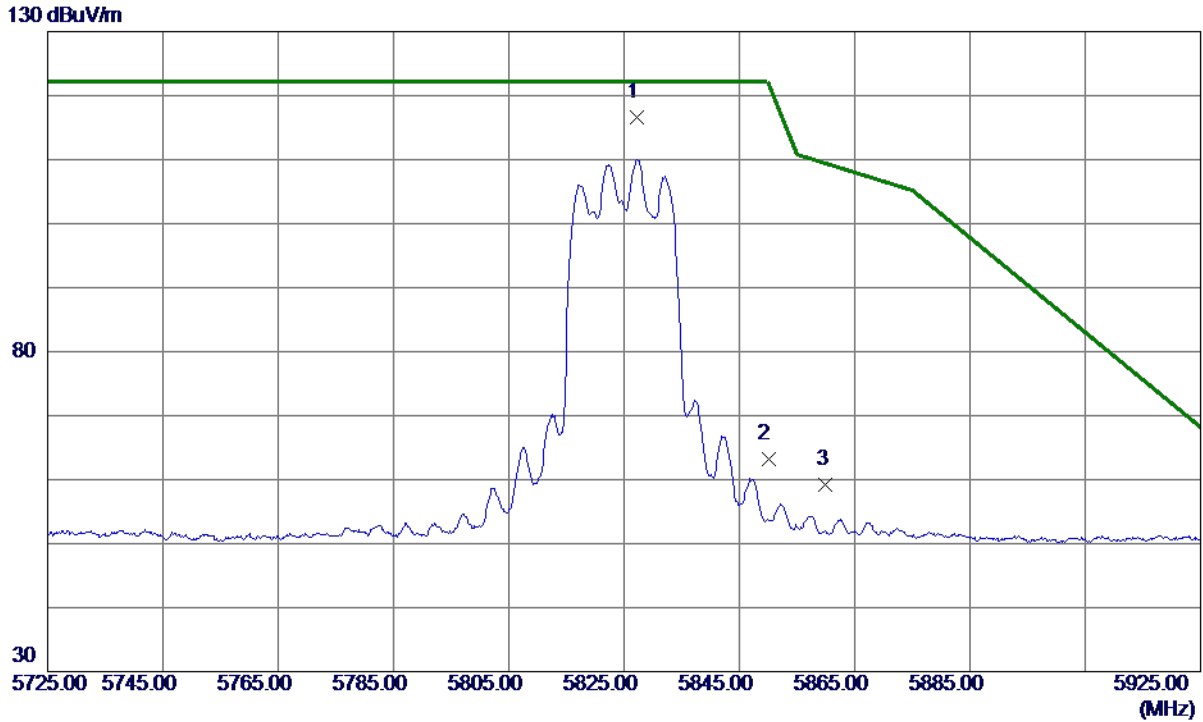

No.	Freq. MHz	Reading Level dBuV/m	Correct Factor dB	Measure ment dBuV/m	Limit dBuV/m	Margin dB	Detector	Comment
1 *	5827.3000	97.65	19.02	116.67	122.20	-5.53	Peak	No Limit
2	5850.0000	44.19	19.09	63.28	122.20	-58.92	Peak	
3	5860.0000	40.15	19.13	59.28	109.40	-50.12	Peak	

REMARKS:

- (1) Measurement Value = Reading Level + Correct Factor.
- (2) Margin Level = Measurement Value - Limit Value.

Orthogonal Axis	X
Test Mode	UNII-3_TX AC (VHT20) Mode 5825 MHz

Vertical

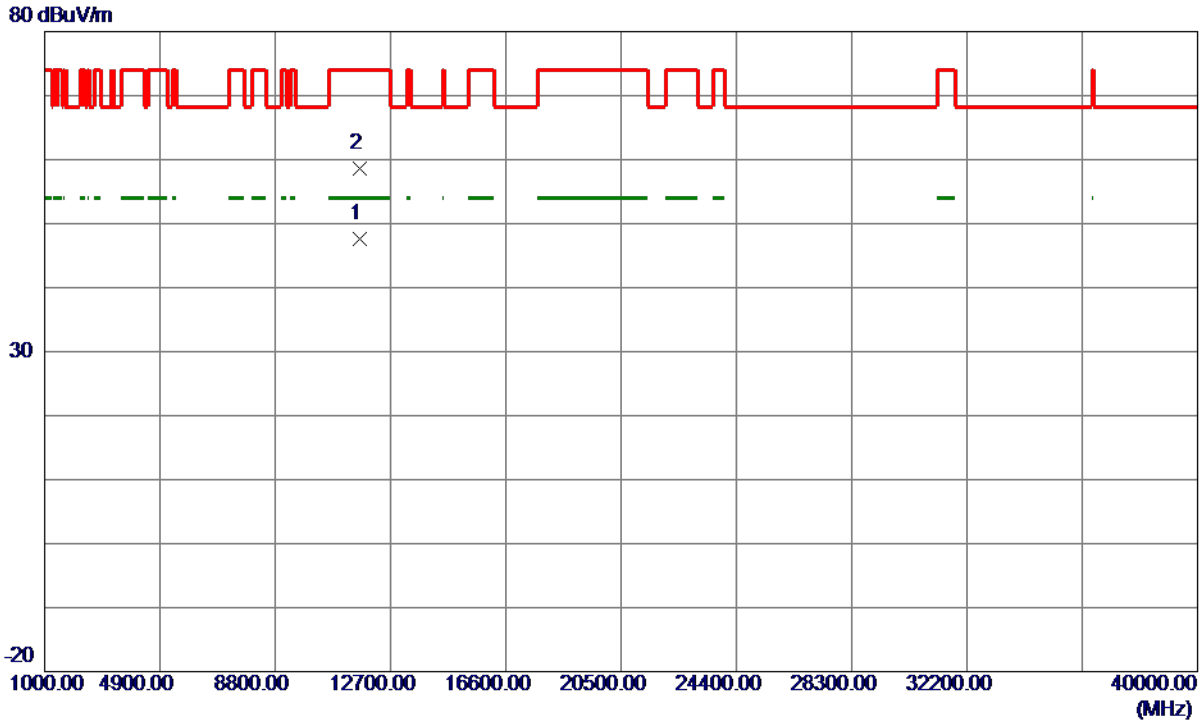

No.	Freq. MHz	Reading Level dBuV/m	Correct Factor dB	Measure ment dBuV/m	Limit dBuV/m	Margin dB	Detector	Comment
1 *	11648.6700	30.28	17.23	47.51	54.00	-6.49	AVG	
2	11653.4600	41.37	17.23	58.60	74.00	-15.40	Peak	

REMARKS:

- (1) Measurement Value = Reading Level + Correct Factor.
- (2) Margin Level = Measurement Value - Limit Value.

Orthogonal Axis	X
Test Mode	UNII-3_TX AC (VHT20) Mode 5825 MHz

Horizontal

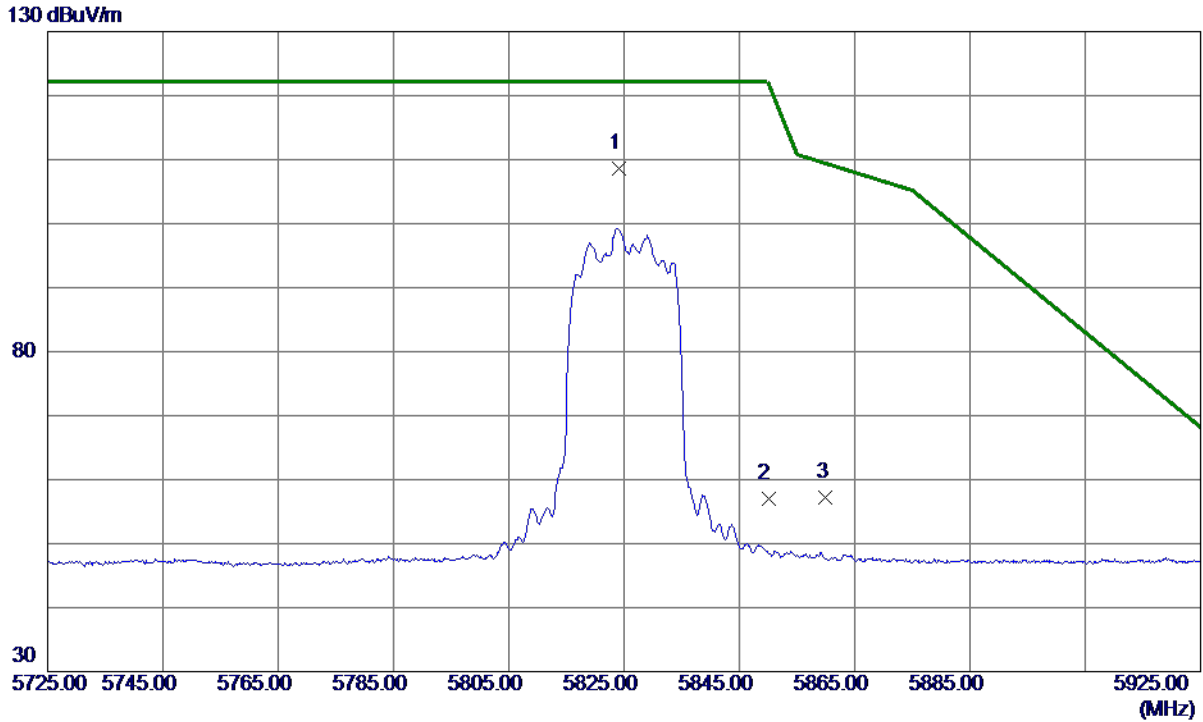

No.	Freq. MHz	Reading Level dBuV/m	Correct Factor dB	Measure ment dBuV/m	Limit dBuV/m	Margin dB	Detector	Comment
1 *	5824.1000	89.57	19.01	108.58	122.20	-13.62	Peak	No Limit
2	5850.0000	38.00	19.09	57.09	122.20	-65.11	Peak	
3	5860.0000	38.13	19.13	57.26	109.40	-52.14	Peak	

REMARKS:

- (1) Measurement Value = Reading Level + Correct Factor.
- (2) Margin Level = Measurement Value - Limit Value.

Orthogonal Axis	X
Test Mode	UNII-3_TX AC (VHT20) Mode 5825 MHz

Horizontal

80 dBuV/m

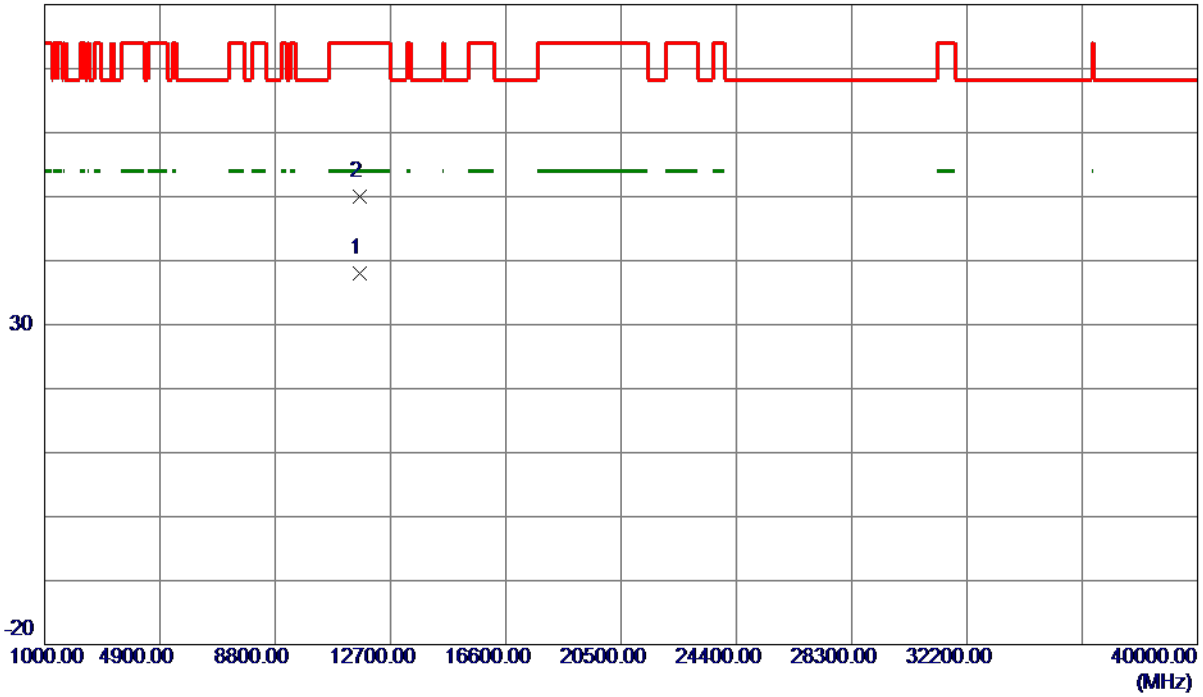

No.	Freq. MHz	Reading Level dBuV/m	Correct Factor dB	Measure ment dBuV/m	Limit dBuV/m	Margin dB	Detector	Comment
1 *	11651.4000	20.82	17.23	38.05	54.00	-15.95	AVG	
2	11651.5300	32.69	17.23	49.92	74.00	-24.08	Peak	

REMARKS:

- (1) Measurement Value = Reading Level + Correct Factor.
- (2) Margin Level = Measurement Value - Limit Value.

Orthogonal Axis	X
Test Mode	UNII-3_TX AC (VHT40) Mode 5755 MHz

Vertical

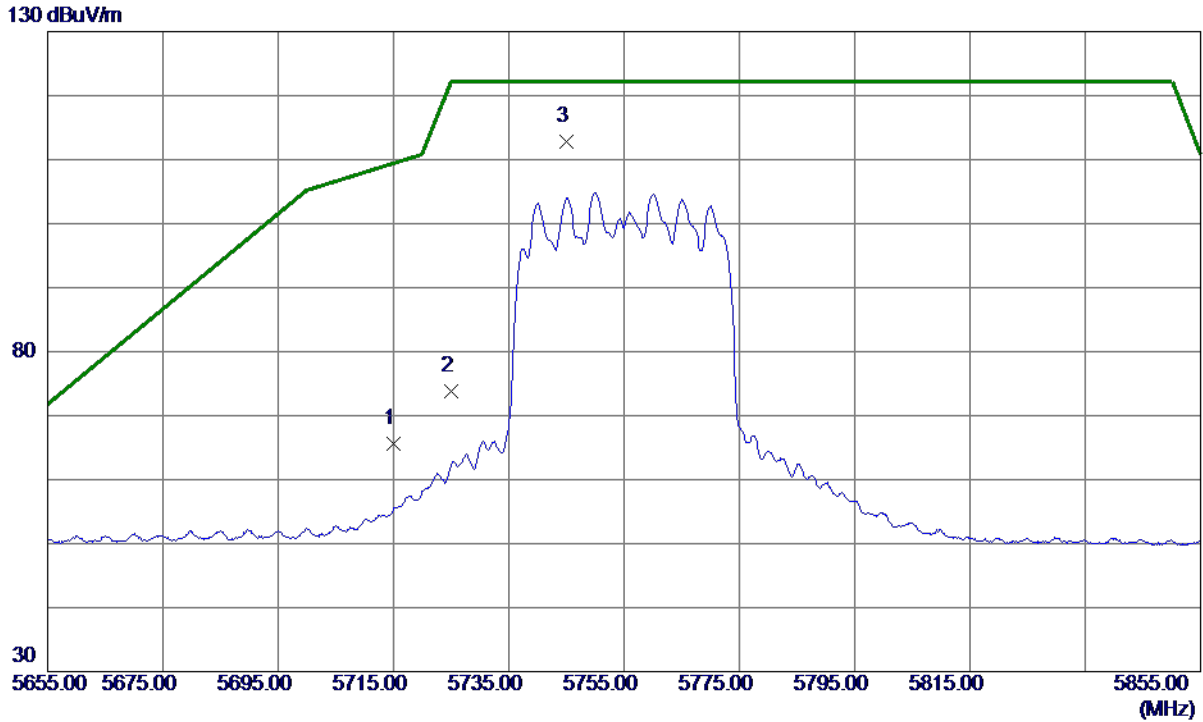

No.	Freq. MHz	Reading Level dBuV/m	Correct Factor dB	Measure ment dBuV/m	Limit dBuV/m	Margin dB	Detector	Comment
1	5715.0000	46.96	18.65	65.61	109.40	-43.79	Peak	
2	5725.0000	55.04	18.69	73.73	122.20	-48.47	Peak	
3 *	5745.1000	94.13	18.75	112.88	122.20	-9.32	Peak	No Limit

REMARKS:

- (1) Measurement Value = Reading Level + Correct Factor.
- (2) Margin Level = Measurement Value - Limit Value.

Orthogonal Axis	X
Test Mode	UNII-3_TX AC (VHT40) Mode 5755 MHz

Vertical

80 dBuV/m

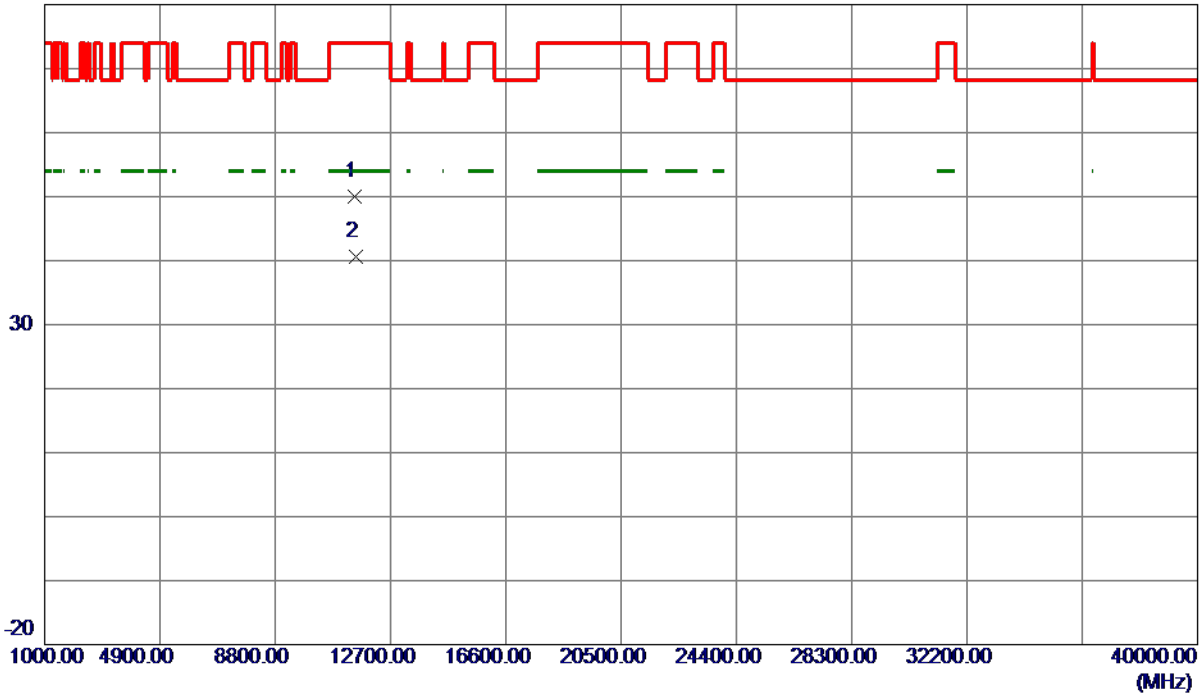

No.	Freq. MHz	Reading Level dBuV/m	Correct Factor dB	Measure ment dBuV/m	Limit dBuV/m	Margin dB	Detector	Comment
1	11503.8500	32.78	17.18	49.96	74.00	-24.04	Peak	
2 *	11508.5000	23.49	17.18	40.67	54.00	-13.33	AVG	

REMARKS:

- (1) Measurement Value = Reading Level + Correct Factor.
- (2) Margin Level = Measurement Value - Limit Value.

Orthogonal Axis	X
Test Mode	UNII-3_TX AC (VHT40) Mode 5755 MHz

Horizontal

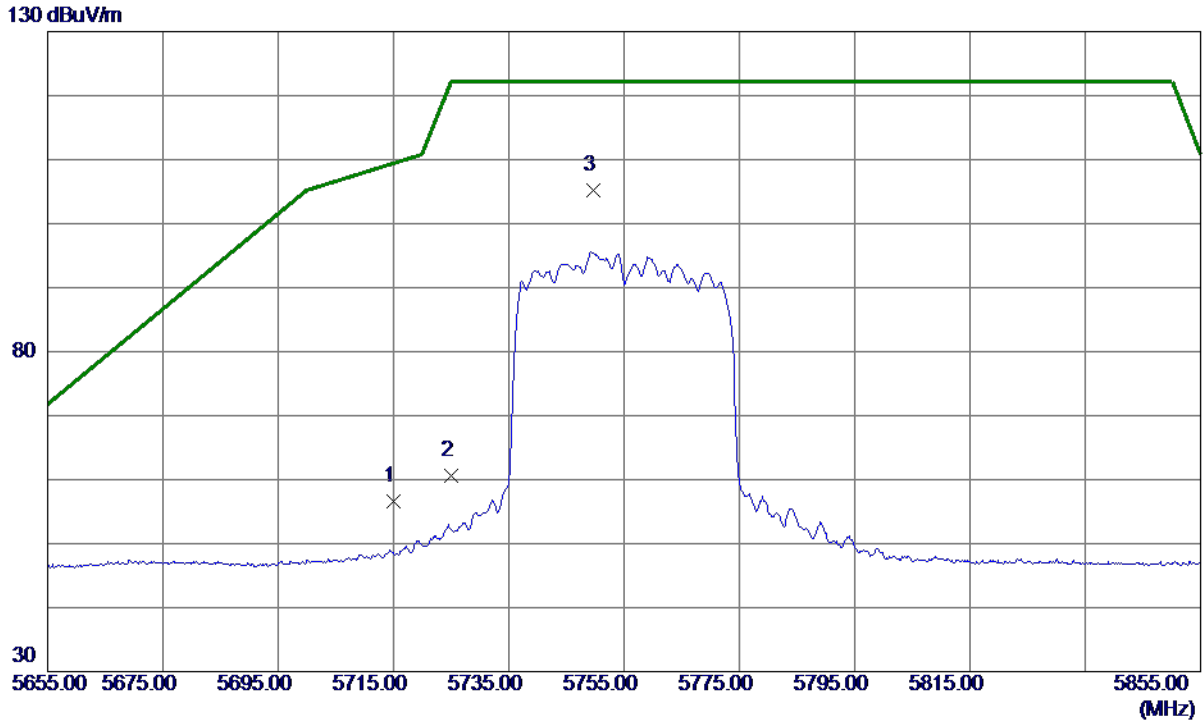

No.	Freq. MHz	Reading Level dBuV/m	Correct Factor dB	Measure ment dBuV/m	Limit dBuV/m	Margin dB	Detector	Comment
1	5715.0000	37.90	18.65	56.55	109.40	-52.85	Peak	
2	5725.0000	41.98	18.69	60.67	122.20	-61.53	Peak	
3 *	5749.6000	86.40	18.77	105.17	122.20	-17.03	Peak	No Limit

REMARKS:

- (1) Measurement Value = Reading Level + Correct Factor.
- (2) Margin Level = Measurement Value - Limit Value.

Orthogonal Axis	X
Test Mode	UNII-3_TX AC (VHT40) Mode 5755 MHz

Horizontal

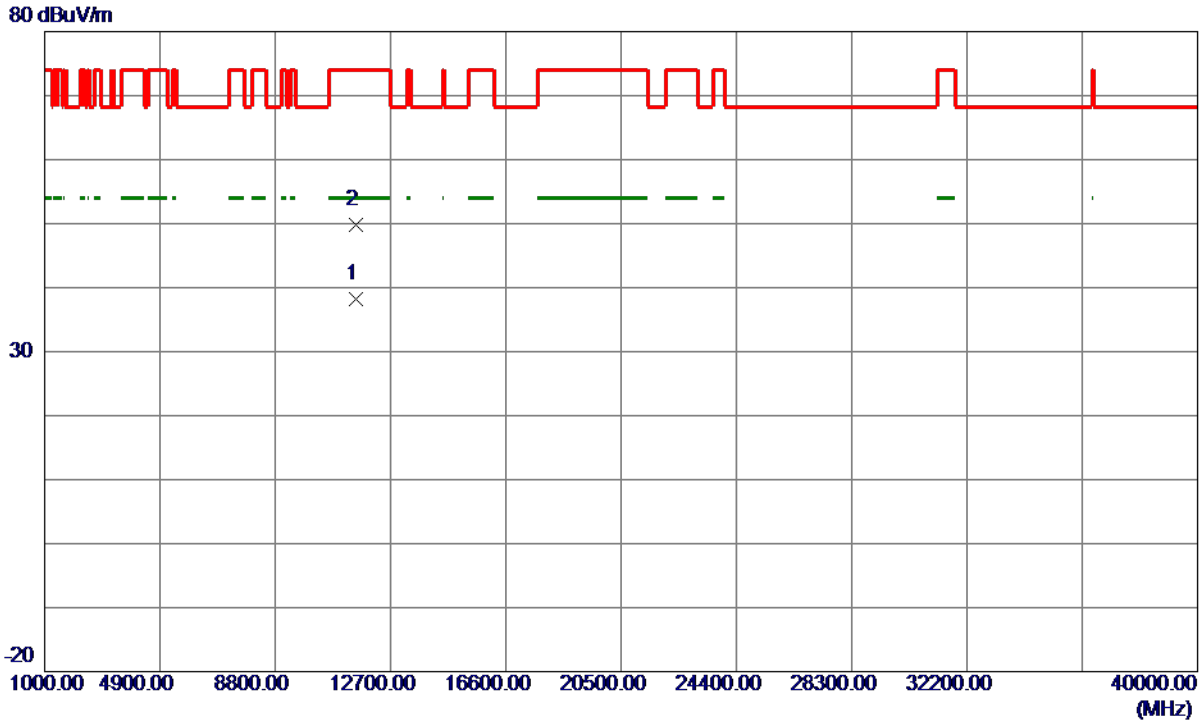

No.	Freq. MHz	Reading Level dBuV/m	Correct Factor dB	Measure ment dBuV/m	Limit dBuV/m	Margin dB	Detector	Comment
1 *	11509.2900	21.10	17.18	38.28	54.00	-15.72	AVG	
2	11509.6900	32.54	17.18	49.72	74.00	-24.28	Peak	

REMARKS:

- (1) Measurement Value = Reading Level + Correct Factor.
- (2) Margin Level = Measurement Value - Limit Value.

Orthogonal Axis	X
Test Mode	UNII-3_TX AC (VHT40) Mode 5795 MHz

Vertical

130 dBuV/m

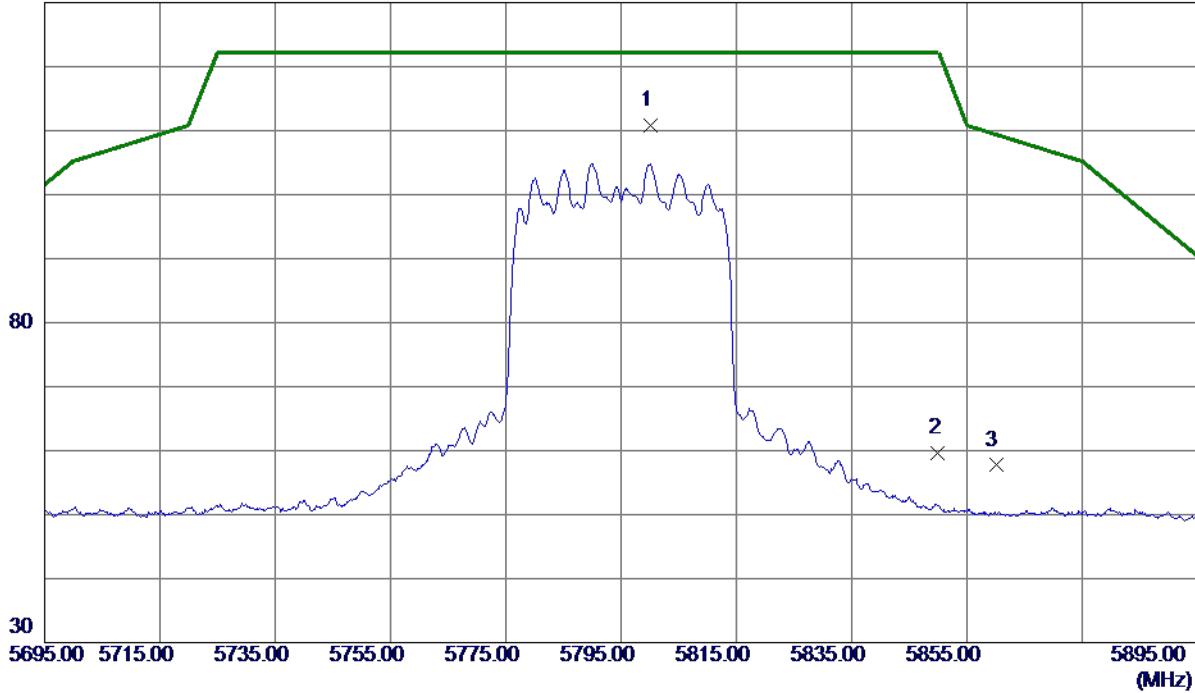

No.	Freq. MHz	Reading Level dBuV/m	Correct Factor dB	Measure ment dBuV/m	Limit dBuV/m	Margin dB	Detector	Comment
1 *	5800.2000	91.95	18.93	110.88	122.20	-11.32	Peak	No Limit
2	5850.0000	40.58	19.09	59.67	122.20	-62.53	Peak	
3	5860.0000	38.57	19.13	57.70	109.40	-51.70	Peak	

REMARKS:

- (1) Measurement Value = Reading Level + Correct Factor.
- (2) Margin Level = Measurement Value - Limit Value.

Orthogonal Axis	X
Test Mode	UNII-3_TX AC (VHT40) Mode 5795 MHz

Vertical

80 dBuV/m

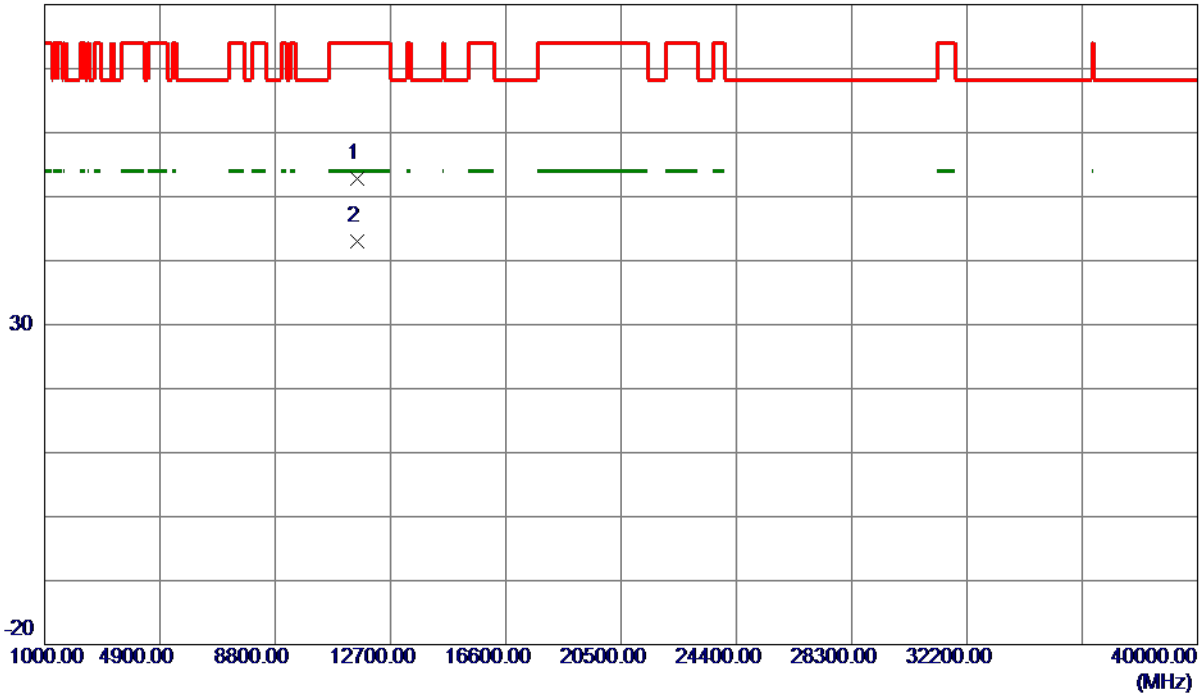

No.	Freq. MHz	Reading Level dBuV/m	Correct Factor dB	Measure ment dBuV/m	Limit dBuV/m	Margin dB	Detector	Comment
1	11584.1500	35.56	17.21	52.77	74.00	-21.23	Peak	
2 *	11593.6000	25.77	17.21	42.98	54.00	-11.02	AVG	

REMARKS:

- (1) Measurement Value = Reading Level + Correct Factor.
- (2) Margin Level = Measurement Value - Limit Value.

Orthogonal Axis	X
Test Mode	UNII-3_TX AC (VHT40) Mode 5795 MHz

Horizontal

130 dBuV/m

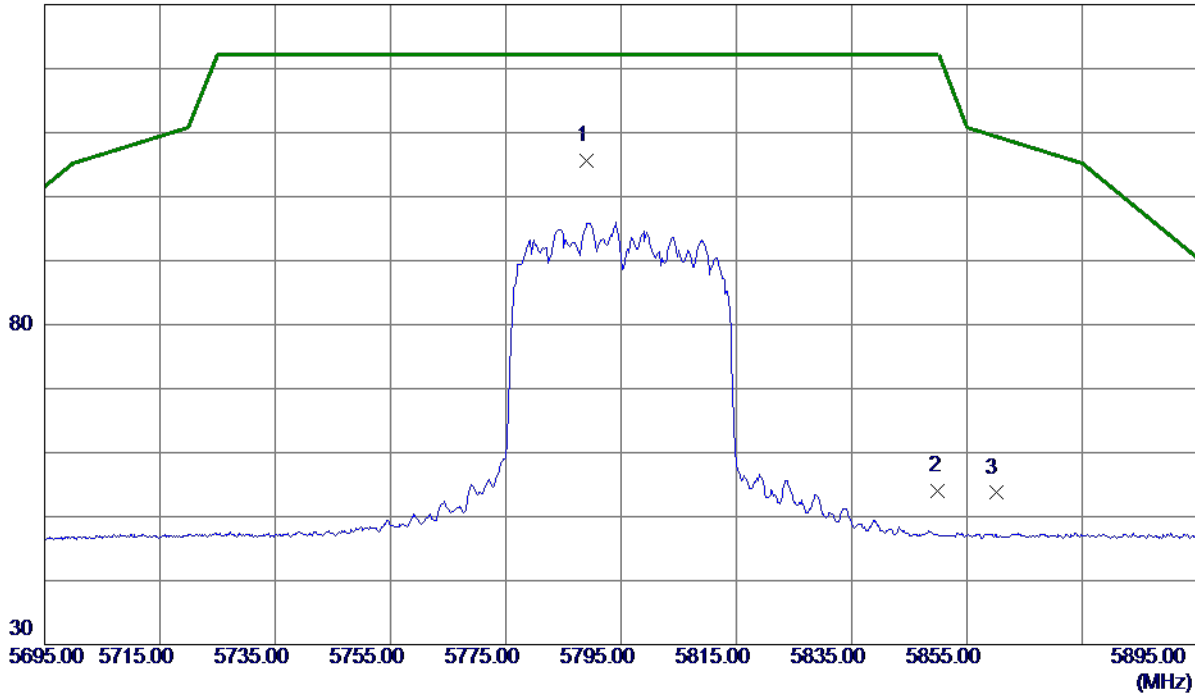

No.	Freq. MHz	Reading Level dBuV/m	Correct Factor dB	Measure ment dBuV/m	Limit dBuV/m	Margin dB	Detector	Comment
1 *	5789.1000	86.73	18.89	105.62	122.20	-16.58	Peak	No Limit
2	5850.0000	34.86	19.09	53.95	122.20	-68.25	Peak	
3	5860.0000	34.57	19.13	53.70	109.40	-55.70	Peak	

REMARKS:

- (1) Measurement Value = Reading Level + Correct Factor.
- (2) Margin Level = Measurement Value - Limit Value.

Orthogonal Axis	X
Test Mode	UNII-3_TX AC (VHT40) Mode 5795 MHz

Horizontal

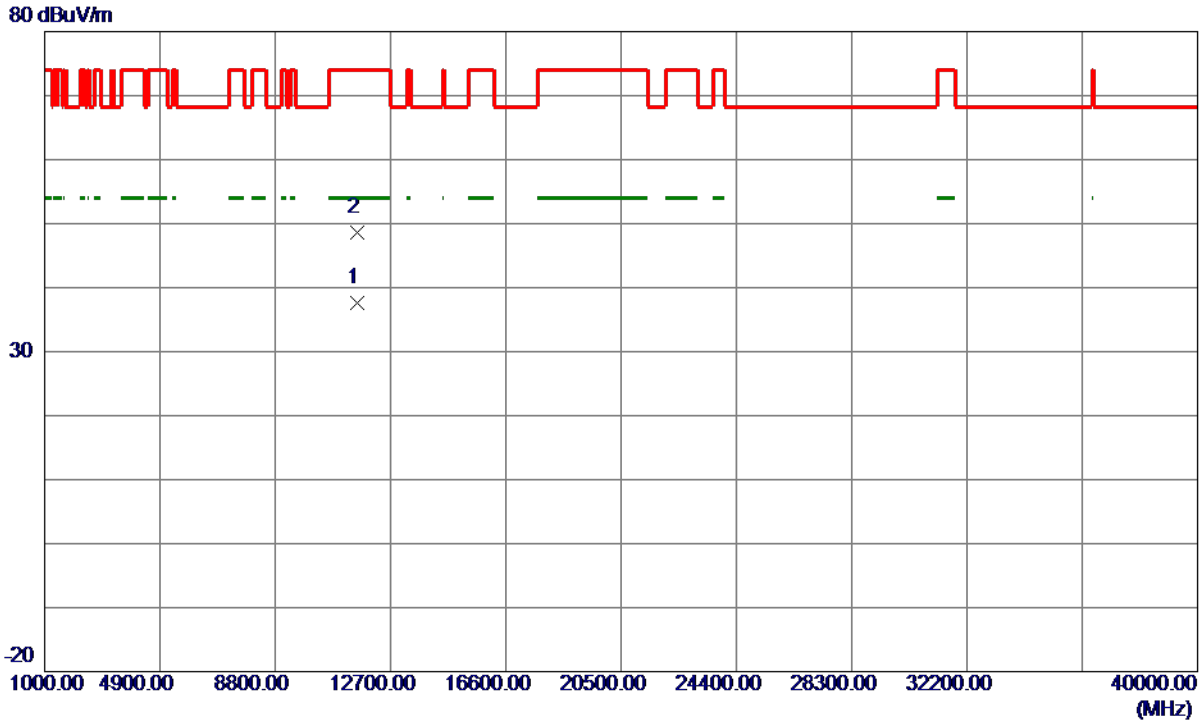

No.	Freq. MHz	Reading Level dBuV/m	Correct Factor dB	Measure ment dBuV/m	Limit dBuV/m	Margin dB	Detector	Comment
1 *	11584.0199	20.48	17.21	37.69	54.00	-16.31	AVG	
2	11587.4300	31.45	17.21	48.66	74.00	-25.34	Peak	

REMARKS:

- (1) Measurement Value = Reading Level + Correct Factor.
- (2) Margin Level = Measurement Value - Limit Value.

Orthogonal Axis	X
Test Mode	UNII-3_TX AC (VHT80) Mode 5775 MHz

Vertical

130 dBuV/m

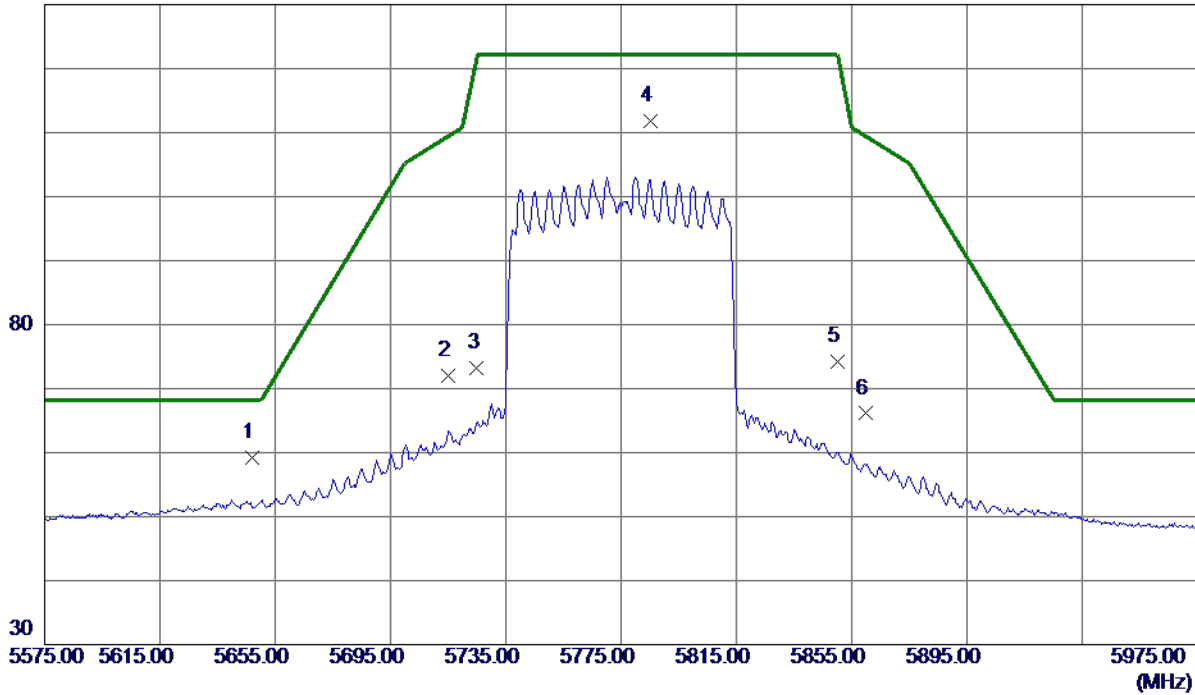

No.	Freq. MHz	Reading Level dBuV/m	Correct Factor dB	Measure ment dBuV/m	Limit dBuV/m	Margin dB	Detector	Comment
1 *	5647.0000	40.72	18.43	59.15	68.20	-9.05	Peak	
2	5715.0000	53.39	18.65	72.04	109.40	-37.36	Peak	
3	5725.0000	54.50	18.69	73.19	122.20	-49.01	Peak	
4	5785.2000	93.00	18.88	111.88	122.20	-10.32	Peak	No Limit
5	5850.0000	55.05	19.09	74.14	122.20	-48.06	Peak	
6	5860.0000	46.97	19.13	66.10	109.40	-43.30	Peak	

REMARKS:

- (1) Measurement Value = Reading Level + Correct Factor.
- (2) Margin Level = Measurement Value - Limit Value.

Orthogonal Axis	X
Test Mode	UNII-3_TX AC (VHT80) Mode 5775 MHz

Vertical

80 dBuV/m

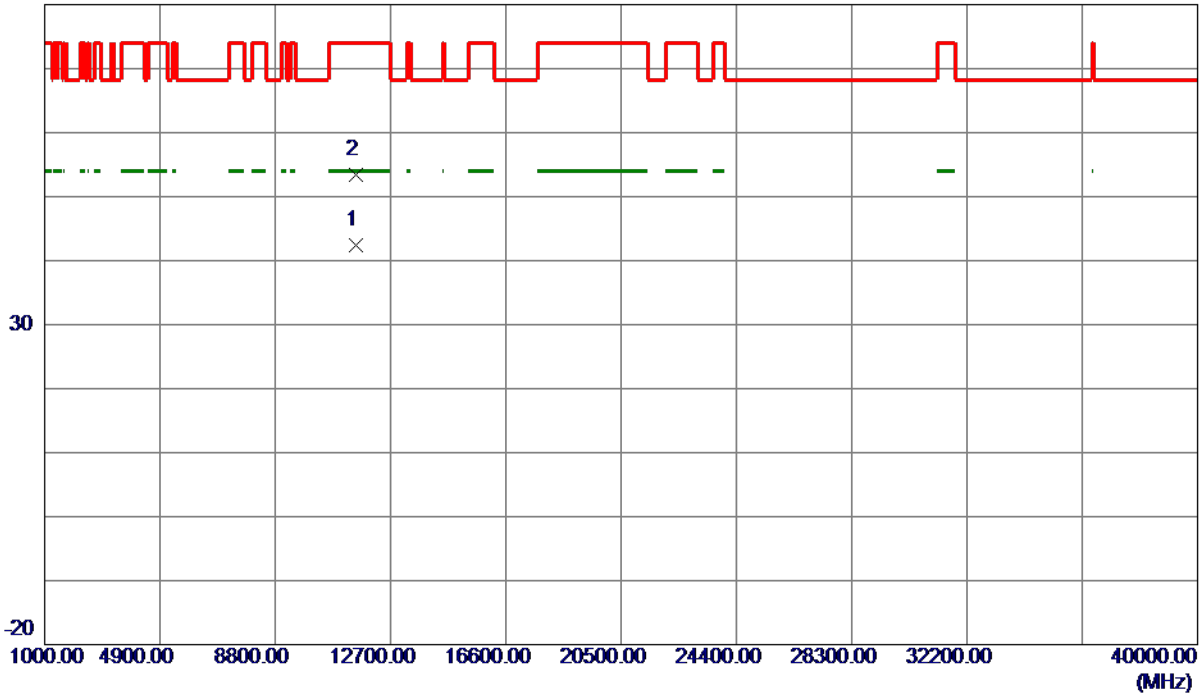

No.	Freq. MHz	Reading Level dBuV/m	Correct Factor dB	Measure ment dBuV/m	Limit dBuV/m	Margin dB	Detector	Comment
1 *	11548.7750	25.13	17.20	42.33	54.00	-11.67	AVG	
2	11548.8500	36.27	17.20	53.47	74.00	-20.53	Peak	

REMARKS:

- (1) Measurement Value = Reading Level + Correct Factor.
- (2) Margin Level = Measurement Value - Limit Value.

Orthogonal Axis	X
Test Mode	UNII-3_TX AC (VHT80) Mode 5775 MHz

Horizontal

130 dBuV/m

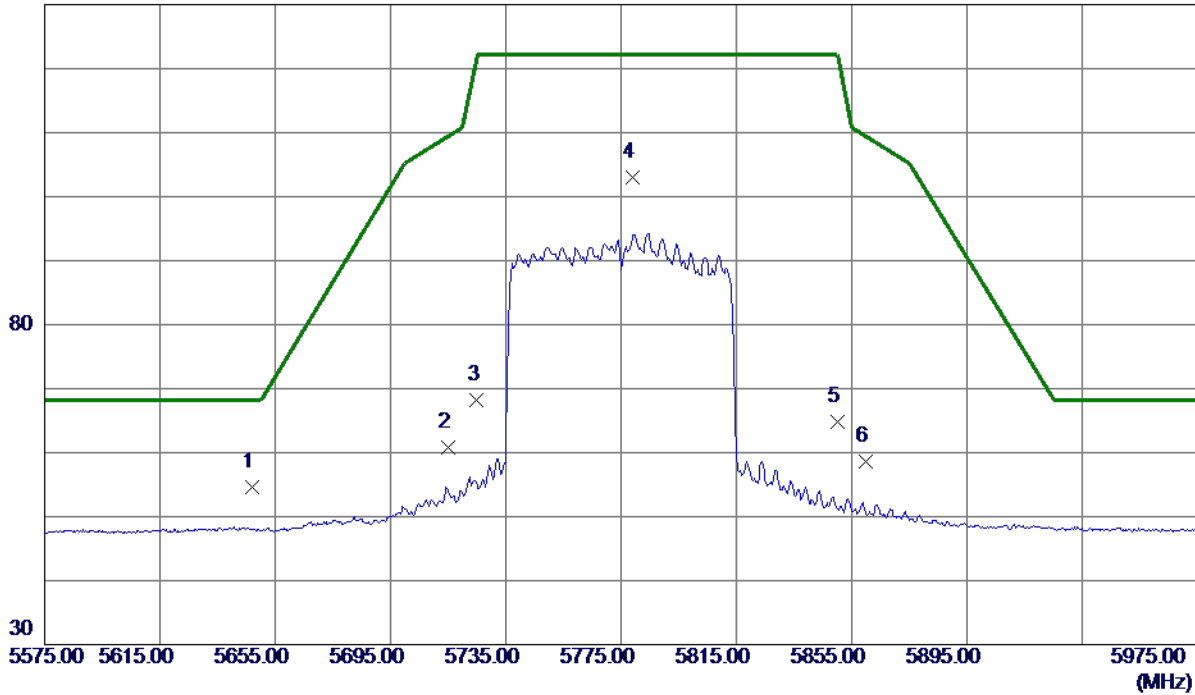

No.	Freq. MHz	Reading Level dBuV/m	Correct Factor dB	Measure ment dBuV/m	Limit dBuV/m	Margin dB	Detector	Comment
1 *	5647.0000	36.13	18.43	54.56	68.20	-13.64	Peak	
2	5715.0000	42.10	18.65	60.75	109.40	-48.65	Peak	
3	5725.0000	49.50	18.69	68.19	122.20	-54.01	Peak	
4	5779.0000	84.17	18.86	103.03	122.20	-19.17	Peak	No Limit
5	5850.0000	45.69	19.09	64.78	122.20	-57.42	Peak	
6	5860.0000	39.53	19.13	58.66	109.40	-50.74	Peak	

REMARKS:

- (1) Measurement Value = Reading Level + Correct Factor.
- (2) Margin Level = Measurement Value - Limit Value.

Orthogonal Axis	X
Test Mode	UNII-3_TX AC (VHT80) Mode 5775 MHz

Horizontal

80 dBuV/m

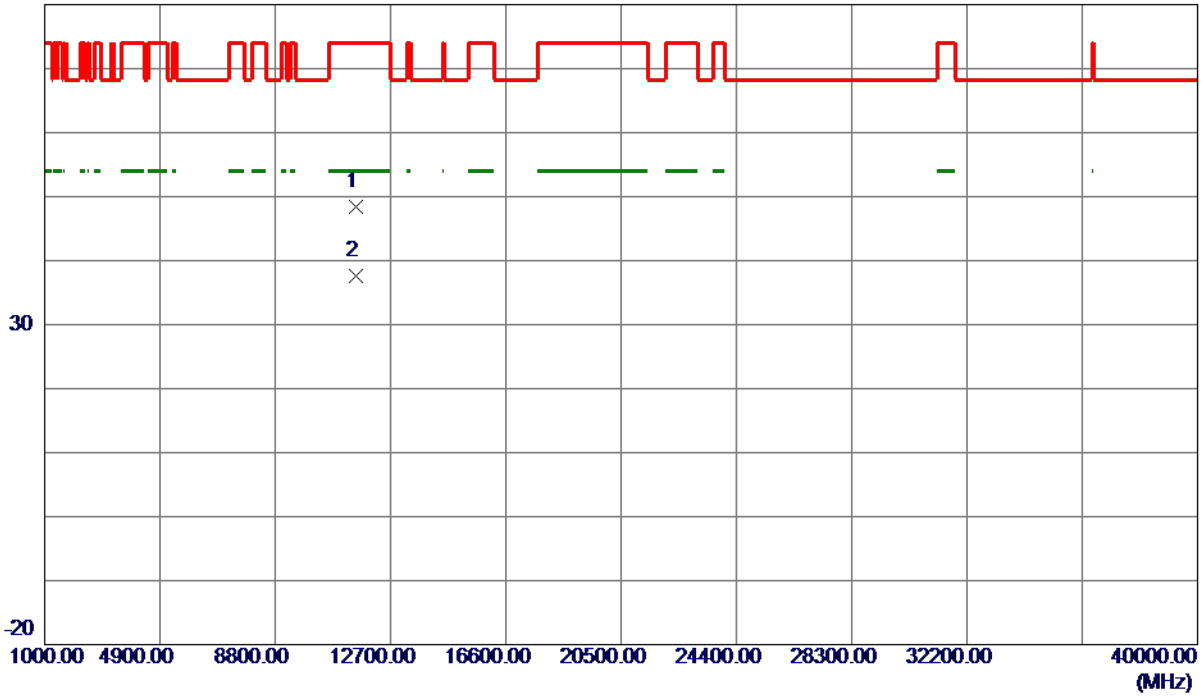

No.	Freq. MHz	Reading Level dBuV/m	Correct Factor dB	Measure ment dBuV/m	Limit dBuV/m	Margin dB	Detector	Comment
1	11543.5300	31.16	17.19	48.35	74.00	-25.65	Peak	
2 *	11548.9200	20.44	17.20	37.64	54.00	-16.36	AVG	

REMARKS:

- (1) Measurement Value = Reading Level + Correct Factor.
- (2) Margin Level = Measurement Value - Limit Value.

Beamforming

Orthogonal Axis	X
Test Mode	UNII-1_TX AC (VHT20) Mode 5180 MHz

Vertical

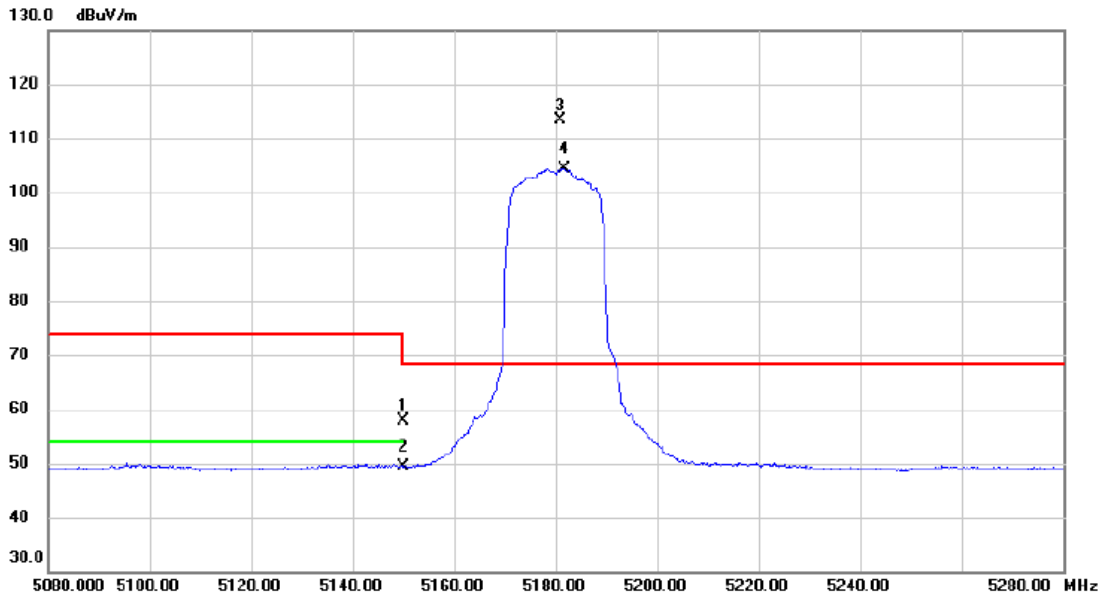

No.	Mk.	Freq. MHz	Reading Level dBuV	Correct Factor dB	Measure- ment dBuV/m	Limit dBuV/m	Margin dB	Detector	Comment
1		5150.000	40.22	17.71	57.93	74.00	-16.07	peak	
2		5150.000	31.63	17.71	49.34	54.00	-4.66	AVG	
3	*	5180.900	95.68	17.80	113.48	68.30	45.18	peak	No Limit
4	X	5181.600	86.64	17.80	104.44	68.30	36.14	AVG	No Limit

REMARKS:

- (1) Measurement Value = Reading Level + Correct Factor.
- (2) Margin Level = Measurement Value - Limit Value.

Orthogonal Axis	X
Test Mode	UNII-1_TX AC (VHT20) Mode 5180 MHz

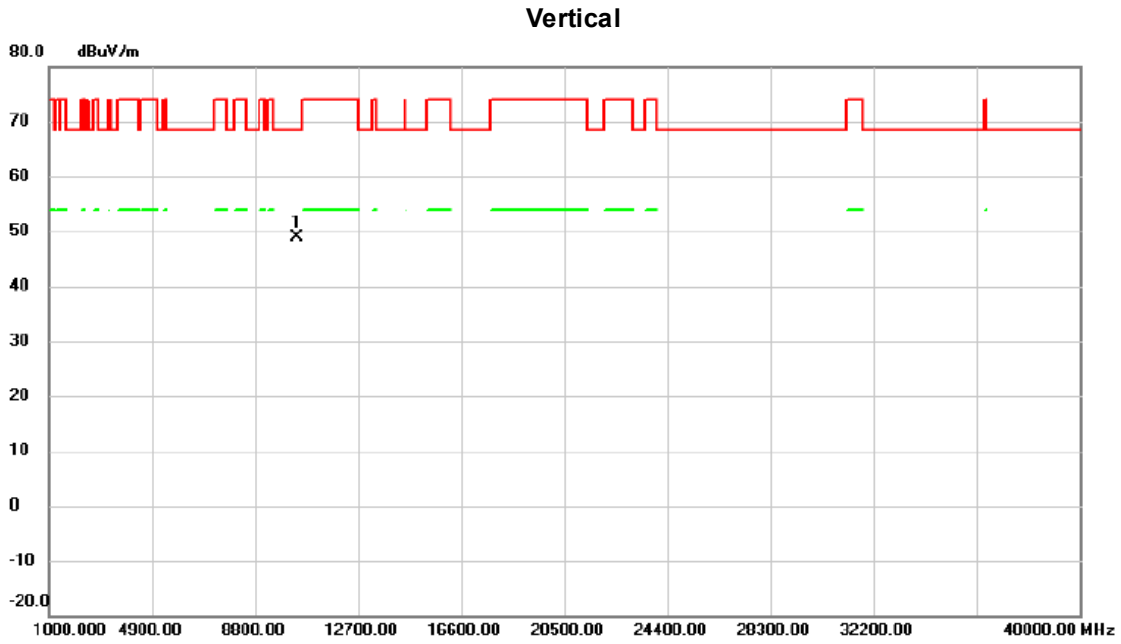

No.	Mk.	Freq.	Reading Level	Correct Factor	Measurement	Limit	Margin	Detector	Comment
		MHz	dBuV	dB	dBuV/m	dBuV/m	dB		
1	*	10361.46	33.87	14.93	48.80	68.30	-19.50	peak	

REMARKS:

- (1) Measurement Value = Reading Level + Correct Factor.
- (2) Margin Level = Measurement Value - Limit Value.

Orthogonal Axis	X
Test Mode	UNII-1_TX AC (VHT20) Mode 5180 MHz

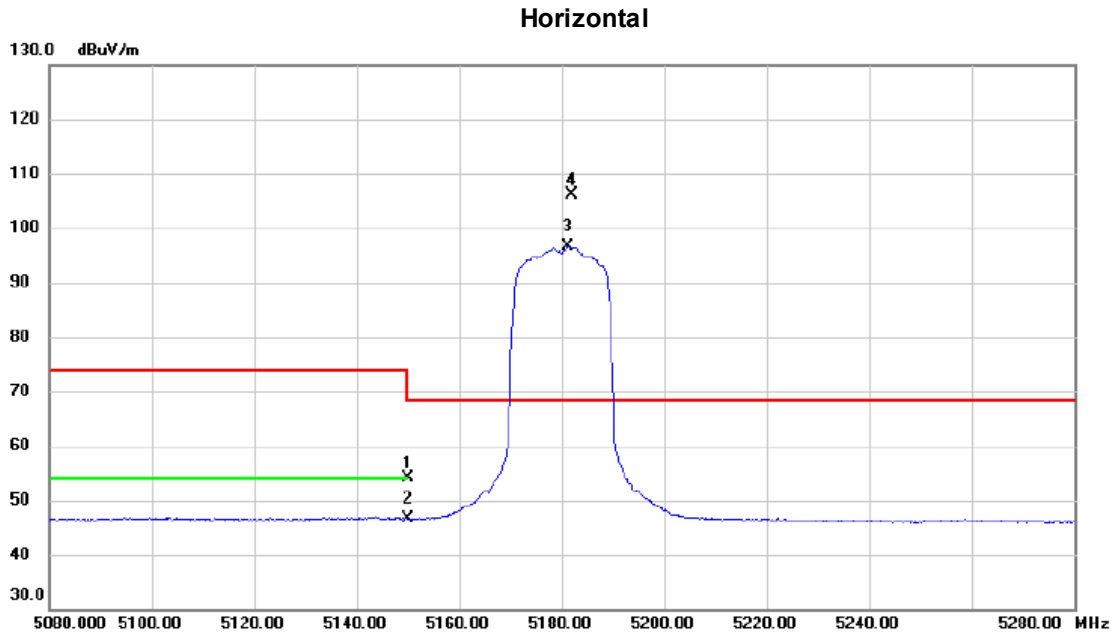

No.	Mk.	Freq. MHz	Reading Level dBuV	Correct Factor dB	Measure- ment dBuV/m	Limit dBuV/m	Margin dB	Detector	Comment
1		5150.000	36.39	17.71	54.10	74.00	-19.90	peak	
2		5150.000	28.92	17.71	46.63	54.00	-7.37	AVG	
3	X	5181.300	78.77	17.80	96.57	68.30	28.27	AVG	No Limit
4	*	5181.900	88.32	17.80	106.12	68.30	37.82	peak	No Limit

REMARKS:

- (1) Measurement Value = Reading Level + Correct Factor.
- (2) Margin Level = Measurement Value - Limit Value.

Orthogonal Axis	X
Test Mode	UNII-1_TX AC (VHT20) Mode 5180 MHz

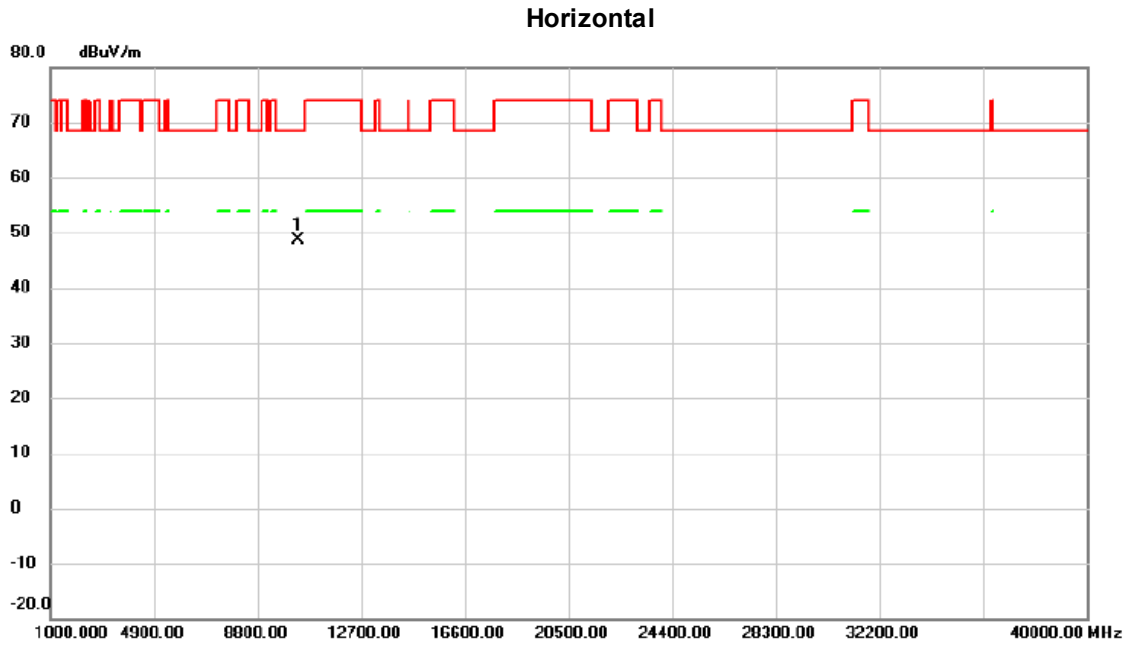

No.	Mk.	Freq.	Reading Level	Correct Factor	Measurement	Limit	Margin	Detector	Comment
		MHz	dBuV	dB	dBuV/m	dBuV/m	dB		
1	*	10357.74	33.63	14.92	48.55	68.30	-19.75	peak	

REMARKS:

- (1) Measurement Value = Reading Level + Correct Factor.
- (2) Margin Level = Measurement Value - Limit Value.

Orthogonal Axis	X
Test Mode	UNII-1_TX AC (VHT20) Mode 5200 MHz

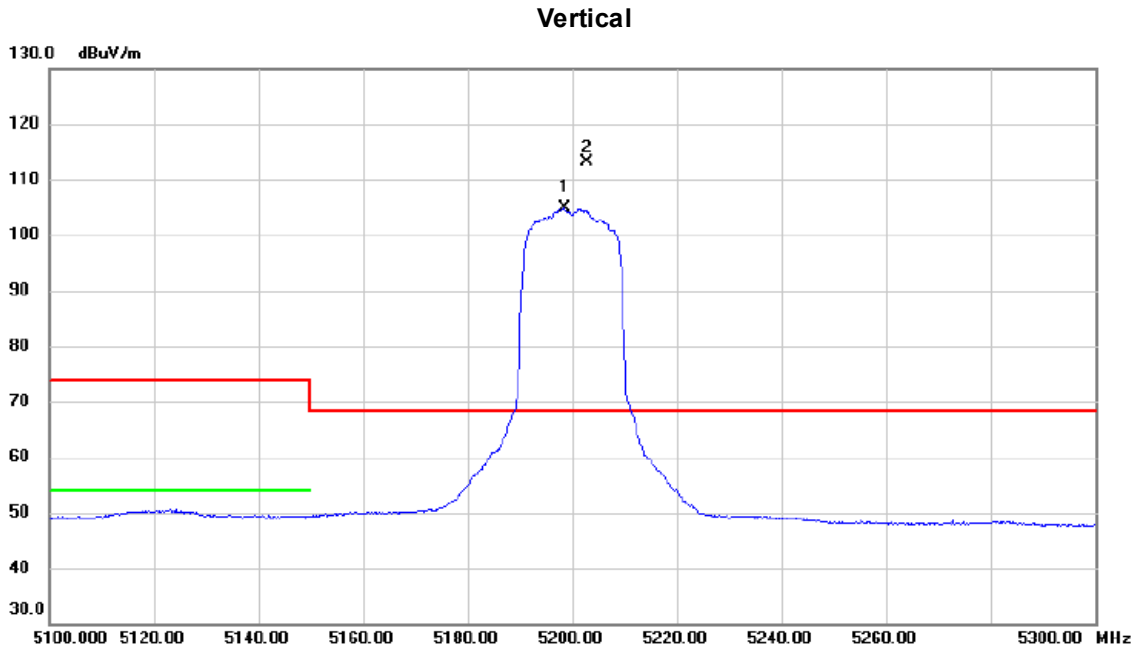

No.	Mk.	Freq. MHz	Reading Level dBuV	Correct Factor dB	Measure- ment dBuV/m	Limit dBuV/m	Margin dB	Detector	Comment
1	X	5198.600	86.96	17.86	104.82	68.30	36.52	AVG	No Limit
2	*	5202.800	95.19	17.87	113.06	68.30	44.76	peak	No Limit

REMARKS:

- (1) Measurement Value = Reading Level + Correct Factor.
- (2) Margin Level = Measurement Value - Limit Value.

Orthogonal Axis	X
Test Mode	UNII-1_TX AC (VHT20) Mode 5200 MHz

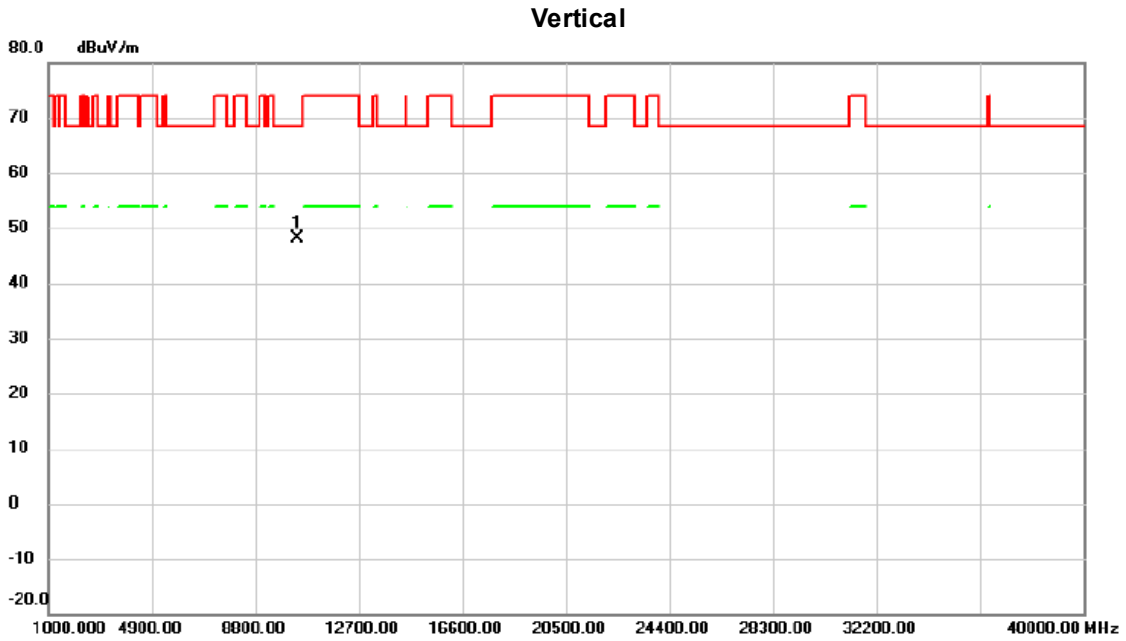

No.	Mk.	Freq.	Reading Level	Correct Factor	Measurement	Limit	Margin	Detector	Comment
		MHz	dBuV	dB	dBuV/m	dBuV/m	dB		
1	*	10398.71	33.03	14.99	48.02	68.30	-20.28	peak	

REMARKS:

- (1) Measurement Value = Reading Level + Correct Factor.
- (2) Margin Level = Measurement Value - Limit Value.

Orthogonal Axis	X
Test Mode	UNII-1_TX AC (VHT20) Mode 5200 MHz

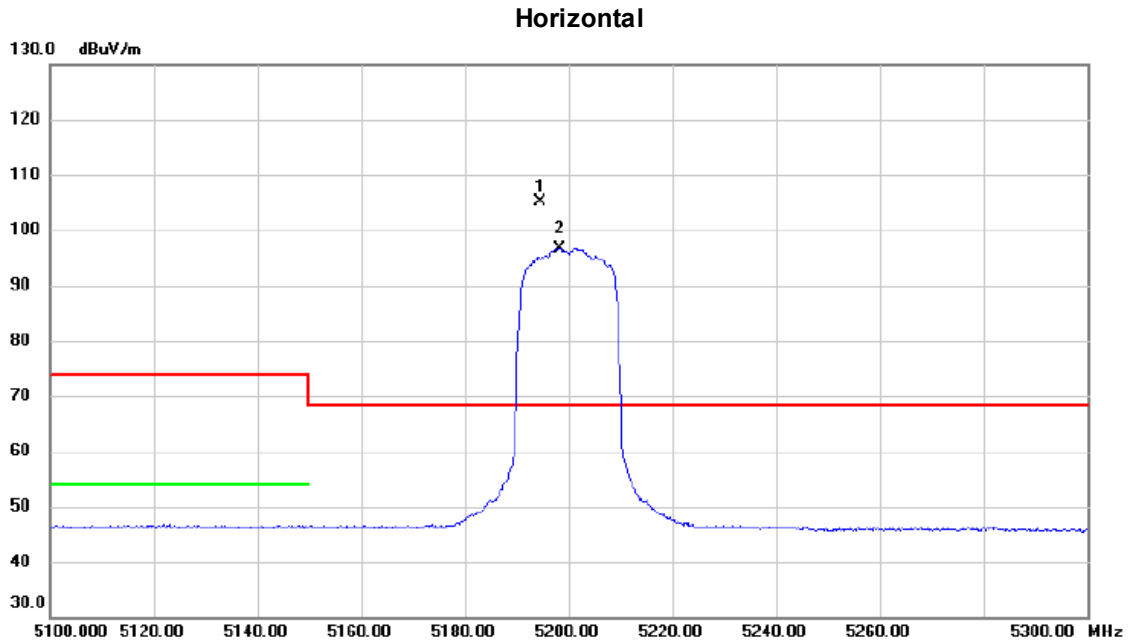

No.	Mk.	Freq.	Reading Level	Correct Factor	Measurement	Limit	Margin		
		MHz	dBuV	dB	dBuV/m	dBuV/m	dB	Detector	Comment
1	*	5194.600	87.38	17.84	105.22	68.30	36.92	peak	No Limit
2	X	5198.200	78.86	17.86	96.72	68.30	28.42	AVG	No Limit

REMARKS:

- (1) Measurement Value = Reading Level + Correct Factor.
- (2) Margin Level = Measurement Value - Limit Value.

Orthogonal Axis	X
Test Mode	UNII-1_TX AC (VHT20) Mode 5200 MHz

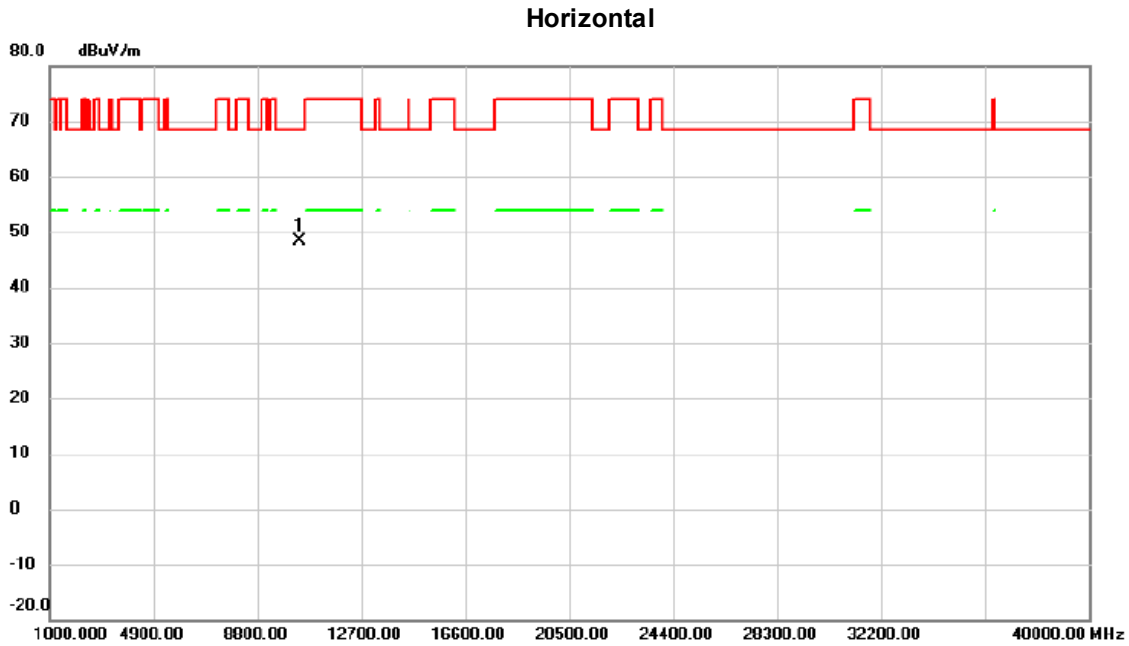

No.	Mk.	Freq.	Reading Level	Correct Factor	Measurement	Limit	Margin	Detector	Comment
		MHz	dBuV	dB	dBuV/m	dBuV/m	dB		
1	*	10398.06	33.35	14.99	48.34	68.30	-19.96	peak	

REMARKS:

- (1) Measurement Value = Reading Level + Correct Factor.
- (2) Margin Level = Measurement Value - Limit Value.

Orthogonal Axis	X
Test Mode	UNII-1_TX AC (VHT20) Mode 5240 MHz

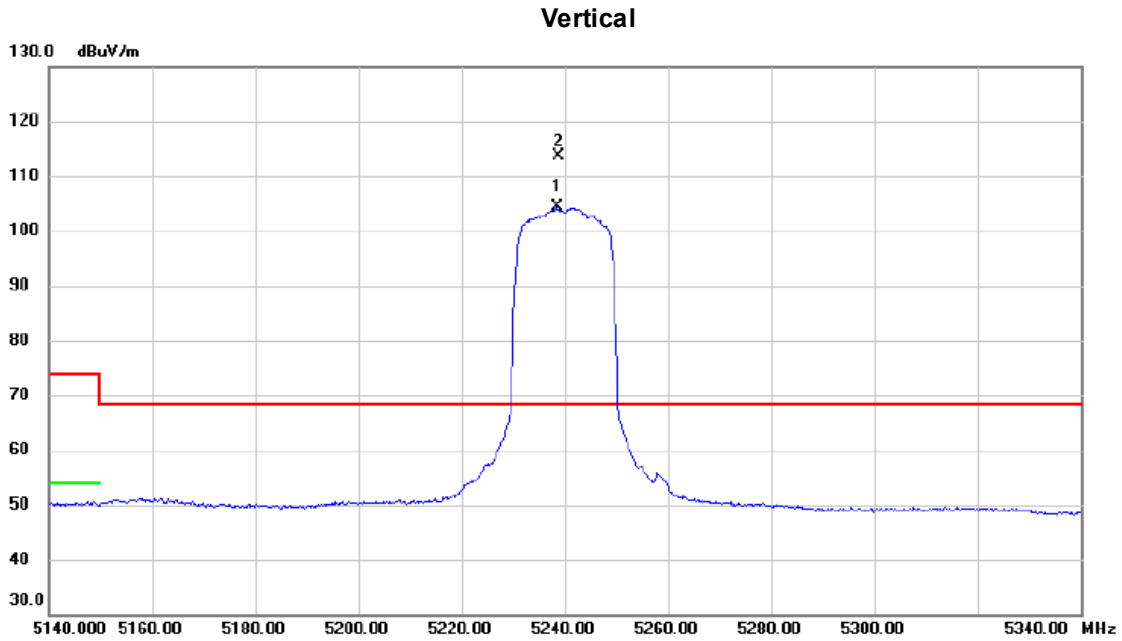

No.	Mk.	Freq.	Reading Level	Correct Factor	Measurement	Limit	Margin	Detector	Comment
		MHz	dBuV	dB	dBuV/m	dBuV/m	dB		
1	X	5238.500	86.31	17.97	104.28	68.30	35.98	AVG	No Limit
2	*	5238.800	95.73	17.97	113.70	68.30	45.40	peak	No Limit

REMARKS:

- (1) Measurement Value = Reading Level + Correct Factor.
- (2) Margin Level = Measurement Value - Limit Value.

Orthogonal Axis	X
Test Mode	UNII-1_TX AC (VHT20) Mode 5240 MHz

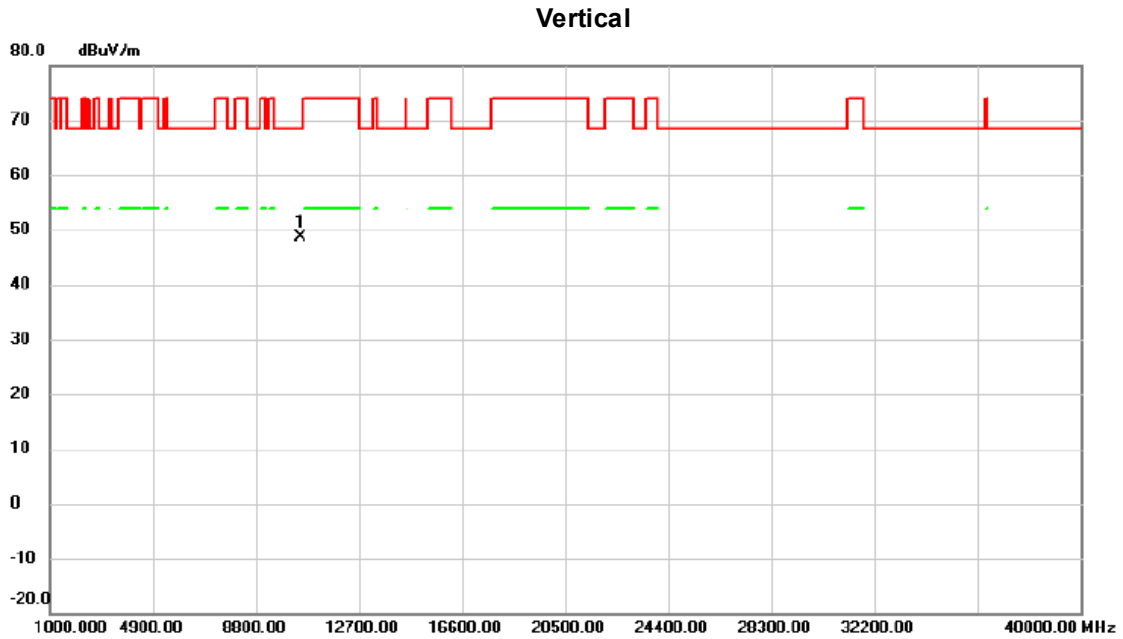

No.	Mk.	Freq.	Reading Level	Correct Factor	Measurement	Limit	Margin	Detector	Comment
		MHz	dBuV	dB	dBuV/m	dBuV/m	dB		
1	*	10482.08	33.42	15.13	48.55	68.30	-19.75	peak	

REMARKS:

- (1) Measurement Value = Reading Level + Correct Factor.
- (2) Margin Level = Measurement Value - Limit Value.

Orthogonal Axis	X
Test Mode	UNII-1_TX AC (VHT20) Mode 5240 MHz

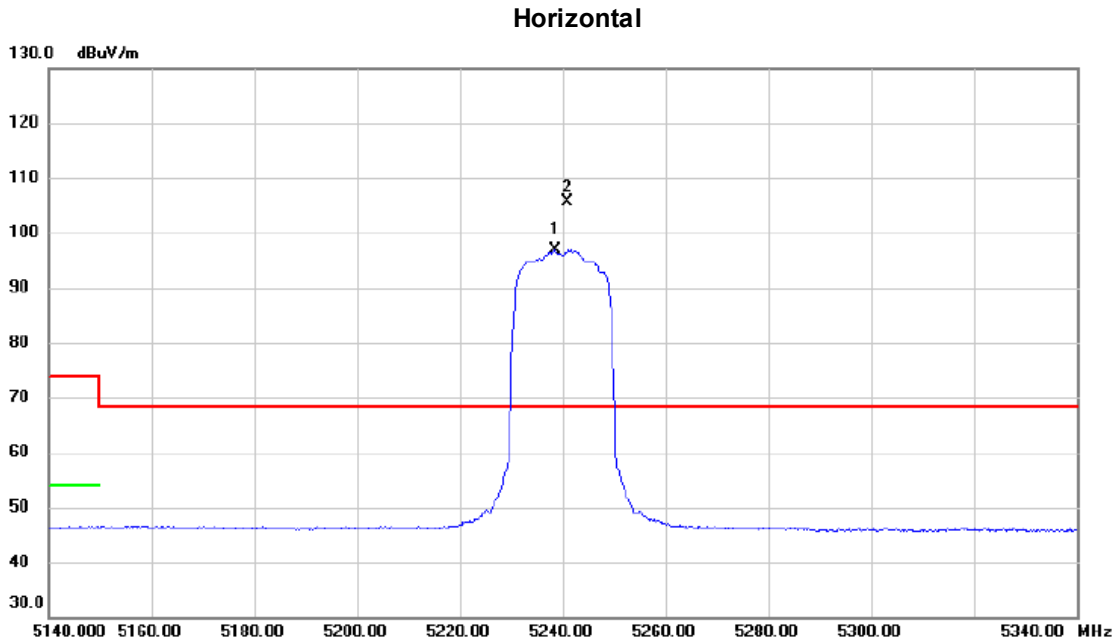

No.	Mk.	Freq. MHz	Reading Level dBuV	Correct Factor dB	Measure- ment dBuV/m	Limit dBuV/m	Margin dB	Detector	Comment
1	X	5238.500	78.85	17.97	96.82	68.30	28.52	AVG	No Limit
2	*	5240.800	87.67	17.98	105.65	68.30	37.35	peak	No Limit

REMARKS:

- (1) Measurement Value = Reading Level + Correct Factor.
- (2) Margin Level = Measurement Value - Limit Value.

Orthogonal Axis	X
Test Mode	UNII-1_TX AC (VHT20) Mode 5240 MHz

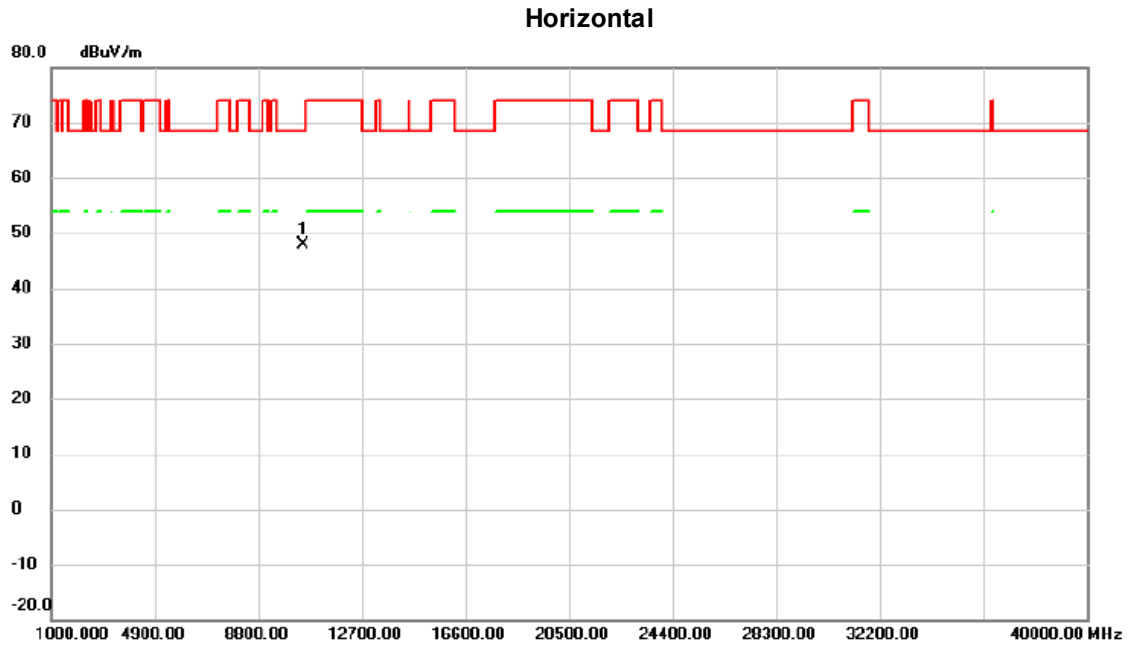

No.	Mk.	Freq. MHz	Reading Level dBuV	Correct Factor dB	Measure- ment dBuV/m	Limit dBuV/m	Margin dB	Detector	Comment
1	*	10478.03	32.74	15.12	47.86	68.30	-20.44	peak	

REMARKS:

- (1) Measurement Value = Reading Level + Correct Factor.
- (2) Margin Level = Measurement Value - Limit Value.

Orthogonal Axis	X
Test Mode	UNII-1_TX AC (VHT40) Mode 5190 MHz

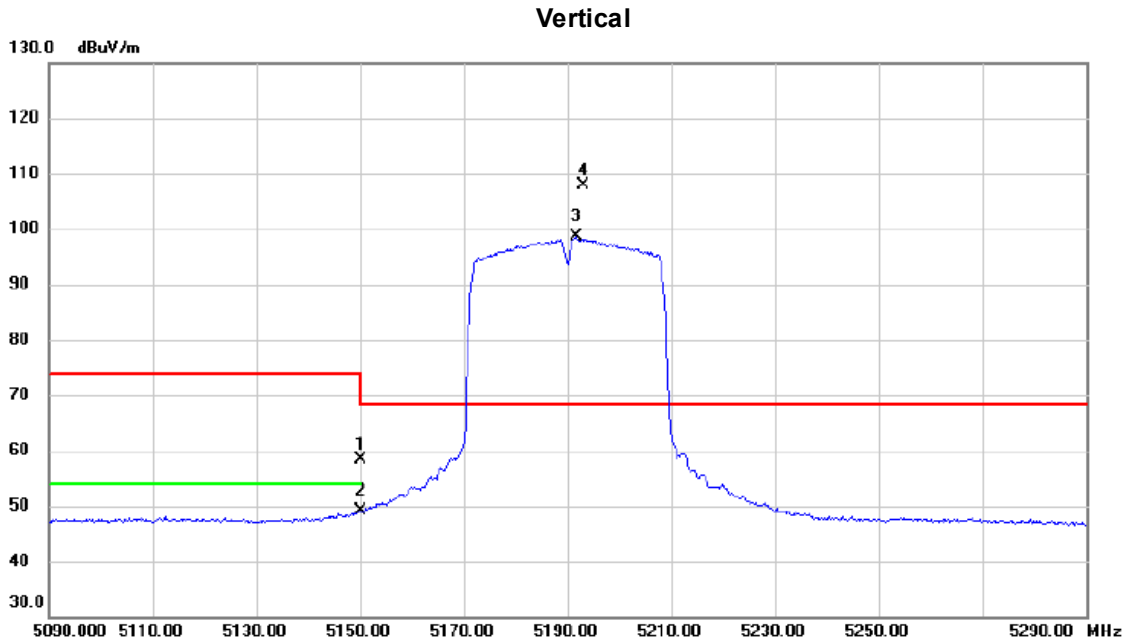

No.	Mk.	Freq. MHz	Reading Level dBuV	Correct Factor dB	Measure- ment dBuV/m	Limit dBuV/m	Margin dB	Detector	Comment
1		5150.000	40.69	17.71	58.40	74.00	-15.60	peak	
2		5150.000	31.33	17.71	49.04	54.00	-4.96	AVG	
3	X	5191.700	80.68	17.83	98.51	68.30	30.21	AVG	No Limit
4	*	5193.200	90.01	17.84	107.85	68.30	39.55	peak	No Limit

REMARKS:

- (1) Measurement Value = Reading Level + Correct Factor.
- (2) Margin Level = Measurement Value - Limit Value.

Orthogonal Axis	X
Test Mode	UNII-1_TX AC (VHT40) Mode 5190 MHz

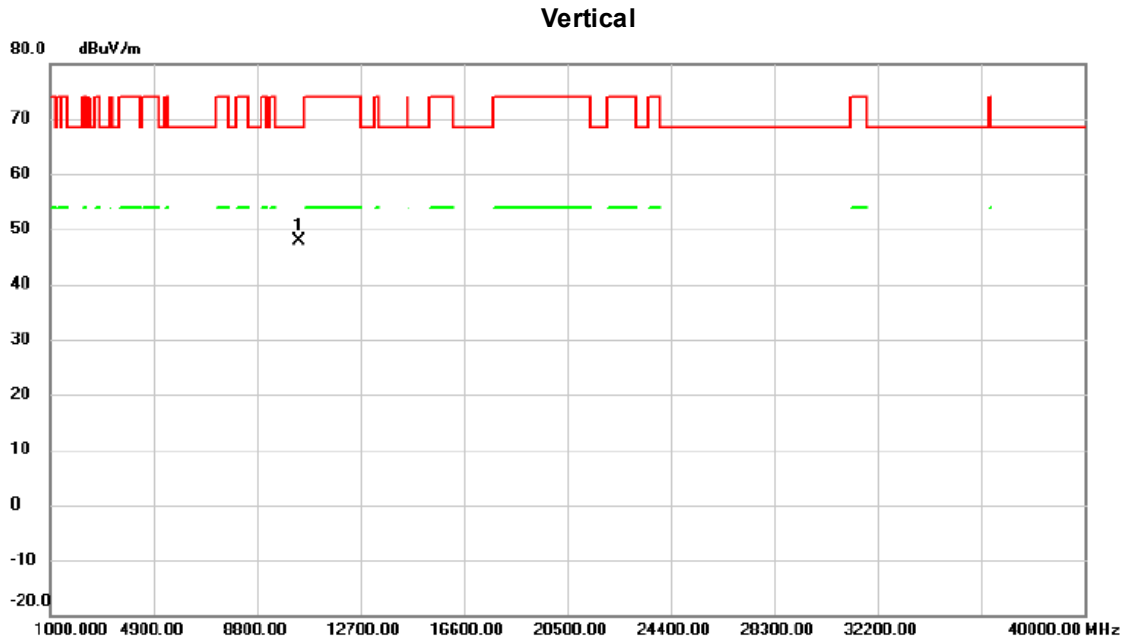

No.	Mk.	Freq. MHz	Reading Level dBuV	Correct Factor dB	Measure- ment dBuV/m	Limit dBuV/m	Margin dB	Detector	Comment
1	*	10381.68	32.94	14.96	47.90	68.30	-20.40	peak	

REMARKS:

- (1) Measurement Value = Reading Level + Correct Factor.
- (2) Margin Level = Measurement Value - Limit Value.

Orthogonal Axis	X
Test Mode	UNII-1_TX AC (VHT40) Mode 5190 MHz

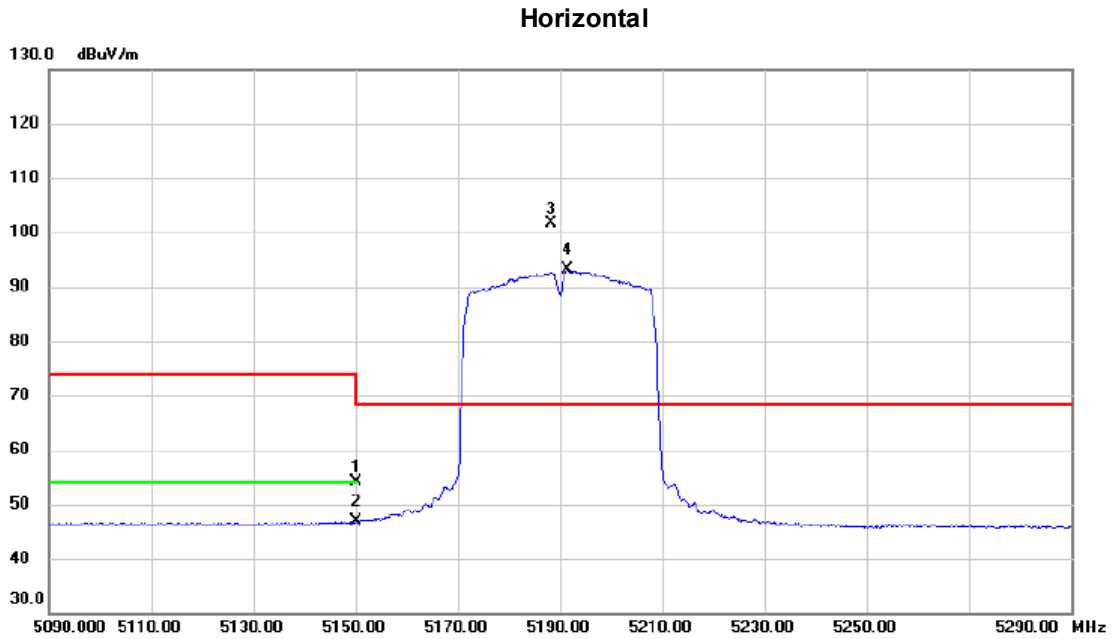

No.	Mk.	Freq. MHz	Reading Level dBuV	Correct Factor dB	Measure- ment dBuV/m	Limit dBuV/m	Margin dB	Detector	Comment
1		5150.000	36.50	17.71	54.21	74.00	-19.79	peak	
2		5150.000	29.08	17.71	46.79	54.00	-7.21	AVG	
3	*	5188.300	83.80	17.83	101.63	68.30	33.33	peak	No Limit
4	X	5191.500	75.18	17.83	93.01	68.30	24.71	AVG	No Limit

REMARKS:

- (1) Measurement Value = Reading Level + Correct Factor.
- (2) Margin Level = Measurement Value - Limit Value.

Orthogonal Axis	X
Test Mode	UNII-1_TX AC (VHT40) Mode 5190 MHz

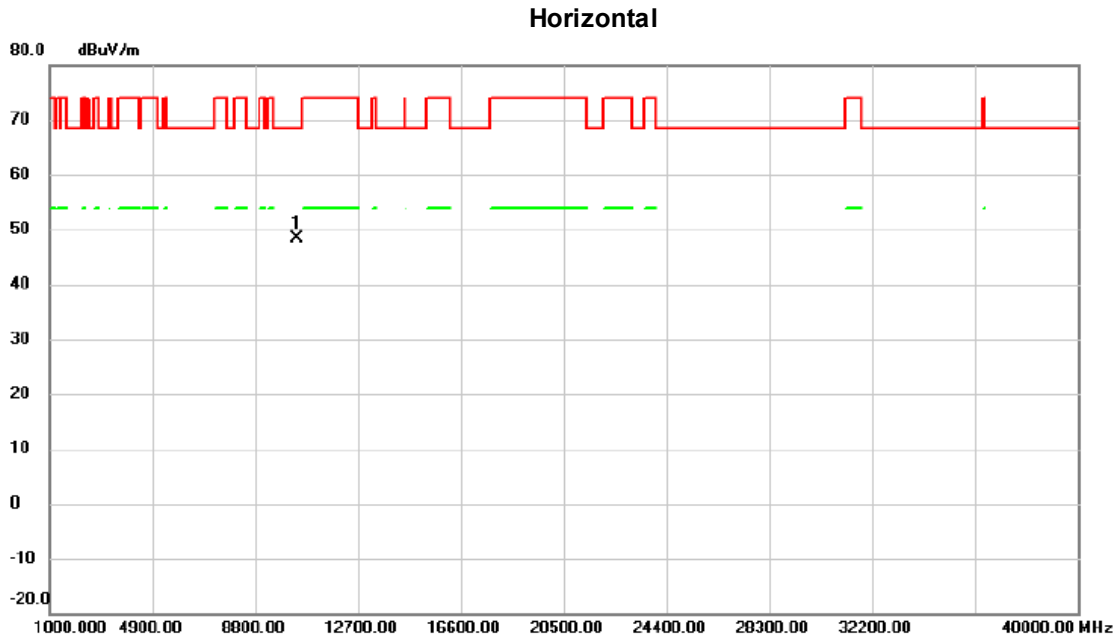

No.	Mk.	Freq.	Reading Level	Correct Factor	Measurement	Limit	Margin	Detector	Comment
		MHz	dBuV	dB	dBuV/m	dBuV/m	dB		
1	*	10381.58	33.52	14.96	48.48	68.30	-19.82	peak	

REMARKS:

- (1) Measurement Value = Reading Level + Correct Factor.
- (2) Margin Level = Measurement Value - Limit Value.

Orthogonal Axis	X
Test Mode	UNII-1_TX AC (VHT40) Mode 5230 MHz

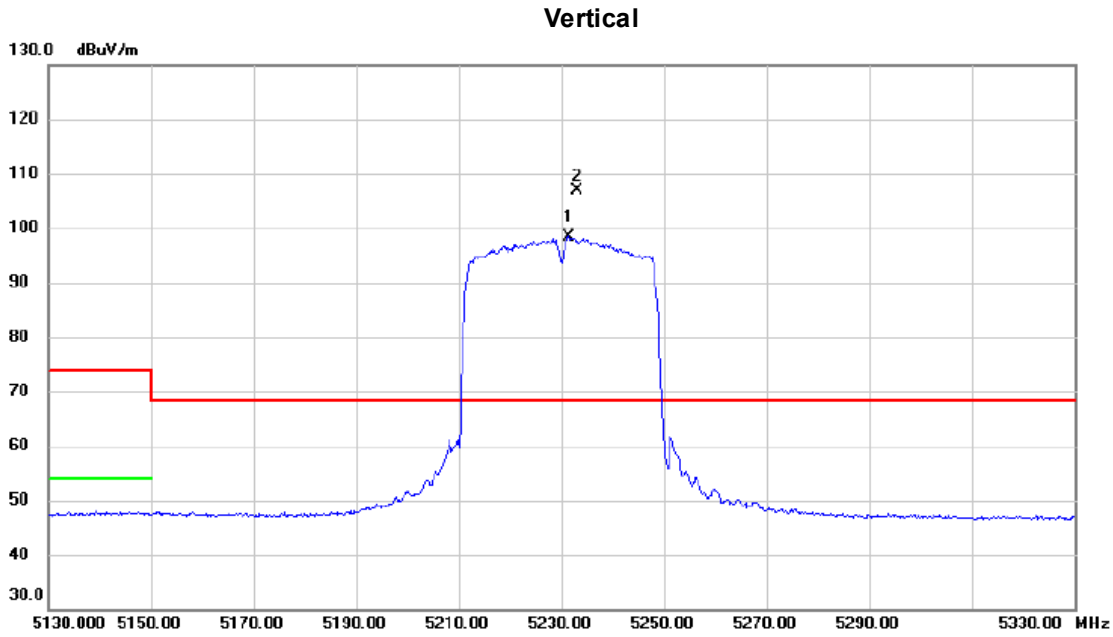

No.	Mk.	Freq. MHz	Reading Level dBuV	Correct Factor dB	Measure- ment dBuV/m	Limit dBuV/m	Margin dB	Detector	Comment
1	X	5231.400	80.55	17.95	98.50	68.30	30.20	AVG	No Limit
2	*	5233.000	89.04	17.96	107.00	68.30	38.70	peak	No Limit

REMARKS:

- (1) Measurement Value = Reading Level + Correct Factor.
- (2) Margin Level = Measurement Value - Limit Value.

Orthogonal Axis	X
Test Mode	UNII-1_TX AC (VHT40) Mode 5230 MHz

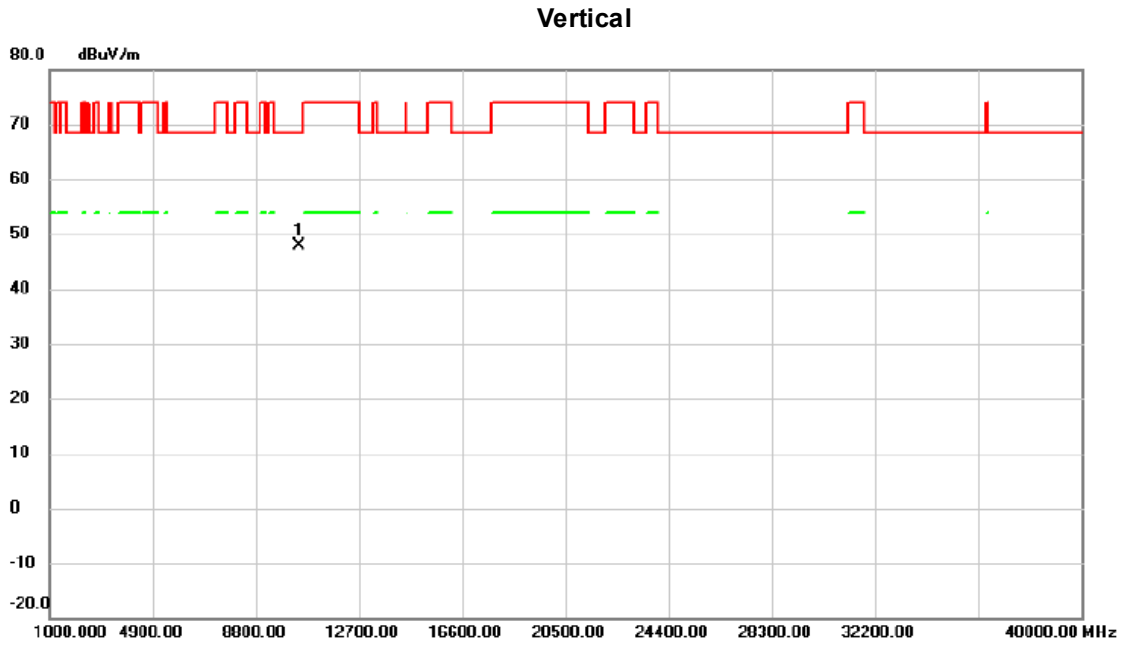

No.	Mk.	Freq.	Reading Level	Correct Factor	Measurement	Limit	Margin	Detector	Comment
		MHz	dBuV	dB	dBuV/m	dBuV/m	dB		
1	*	10460.36	32.85	15.10	47.95	68.30	-20.35	peak	

REMARKS:

- (1) Measurement Value = Reading Level + Correct Factor.
- (2) Margin Level = Measurement Value - Limit Value.

Orthogonal Axis	X
Test Mode	UNII-1_TX AC (VHT40) Mode 5230 MHz

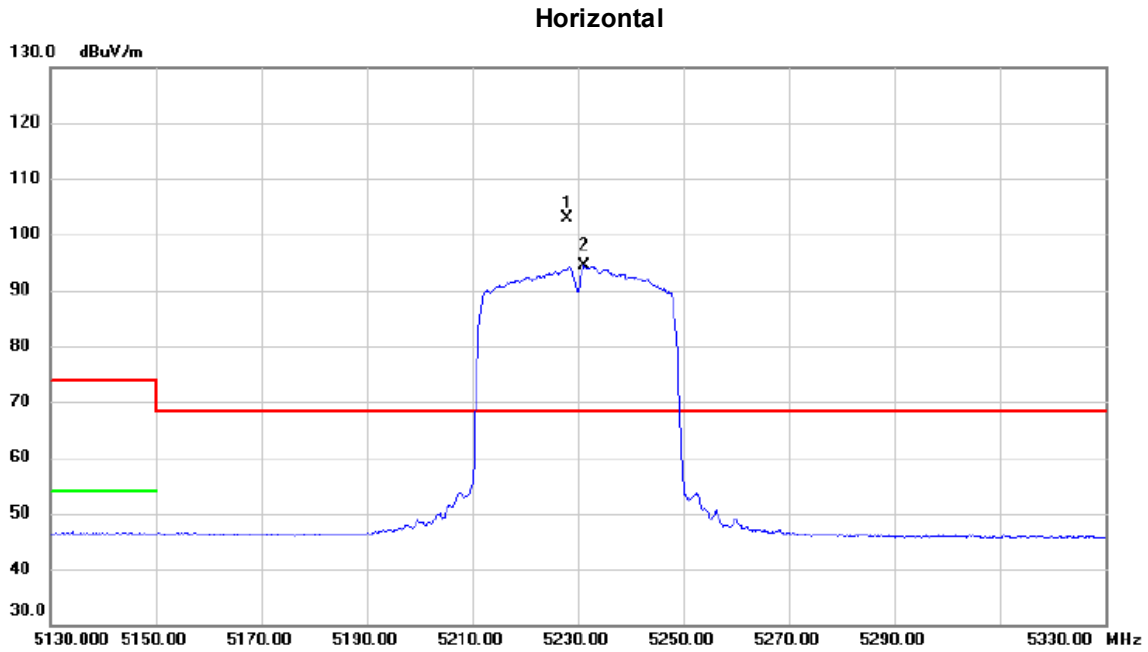

No.	Mk.	Freq. MHz	Reading Level dBuV	Correct Factor dB	Measure- ment dBuV/m	Limit dBuV/m	Margin dB	Detector	Comment
1	*	5227.900	84.86	17.94	102.80	68.30	34.50	peak	No Limit
2	X	5231.200	76.33	17.95	94.28	68.30	25.98	AVG	No Limit

REMARKS:

- (1) Measurement Value = Reading Level + Correct Factor.
- (2) Margin Level = Measurement Value - Limit Value.

Orthogonal Axis	X
Test Mode	UNII-1_TX AC (VHT40) Mode 5230 MHz

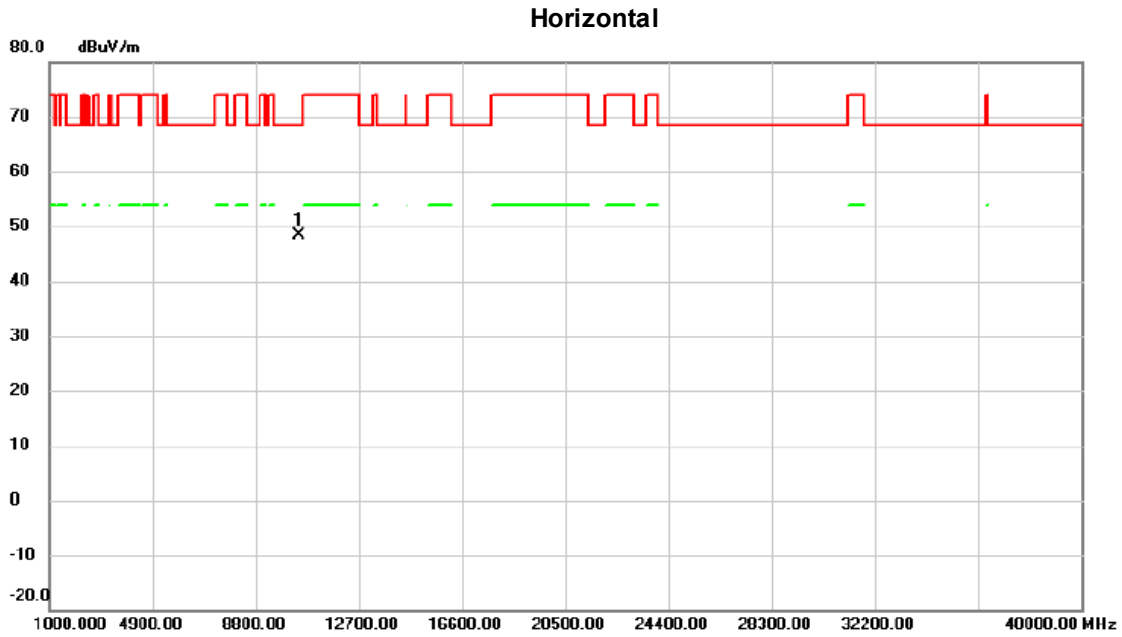

No.	Mk.	Freq. MHz	Reading Level dBuV	Correct Factor dB	Measure- ment dBuV/m	Limit dBuV/m	Margin dB	Detector	Comment
1	*	10460.61	33.16	15.10	48.26	68.30	-20.04	peak	

REMARKS:

- (1) Measurement Value = Reading Level + Correct Factor.
- (2) Margin Level = Measurement Value - Limit Value.

Orthogonal Axis	X
Test Mode	UNII-1_TX AC (VHT80) Mode 5210 MHz

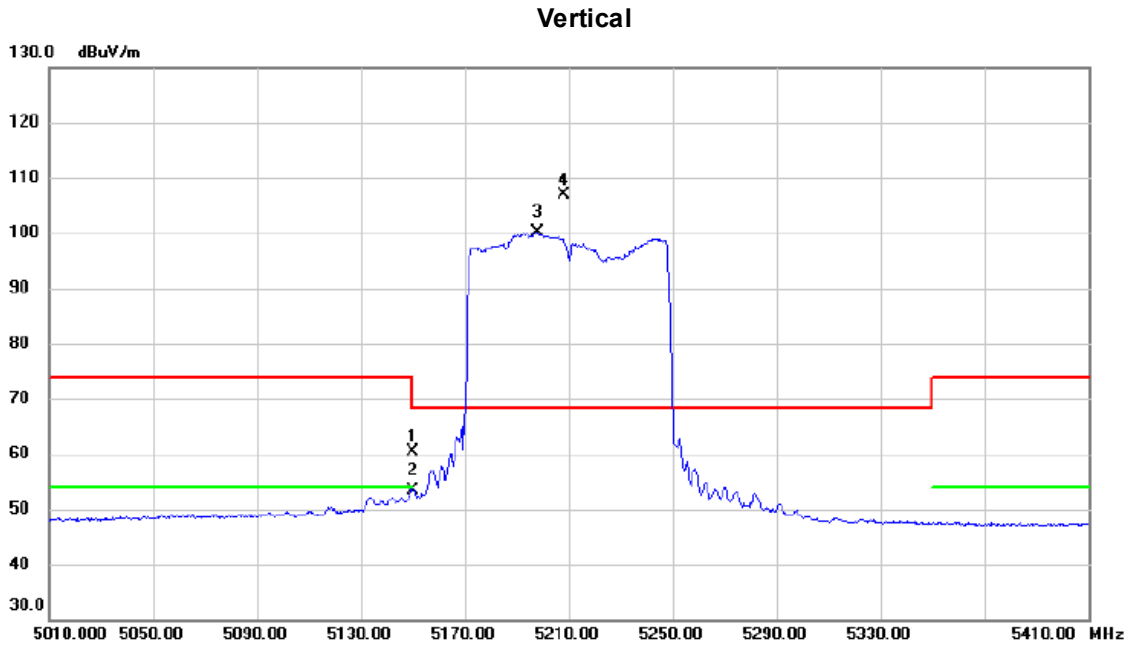

No.	Mk.	Freq. MHz	Reading Level dBuV	Correct Factor dB	Measure- ment dBuV/m	Limit dBuV/m	Margin dB	Detector	Comment
1		5150.000	42.69	17.71	60.40	74.00	-13.60	peak	
2		5150.000	35.75	17.71	53.46	54.00	-0.54	AVG	
3	X	5197.800	82.36	17.86	100.22	68.30	31.92	AVG	No Limit
4	*	5208.000	88.95	17.89	106.84	68.30	38.54	peak	No Limit

REMARKS:

- (1) Measurement Value = Reading Level + Correct Factor.
- (2) Margin Level = Measurement Value - Limit Value.

Orthogonal Axis	X
Test Mode	UNII-1_TX AC (VHT80) Mode 5210 MHz

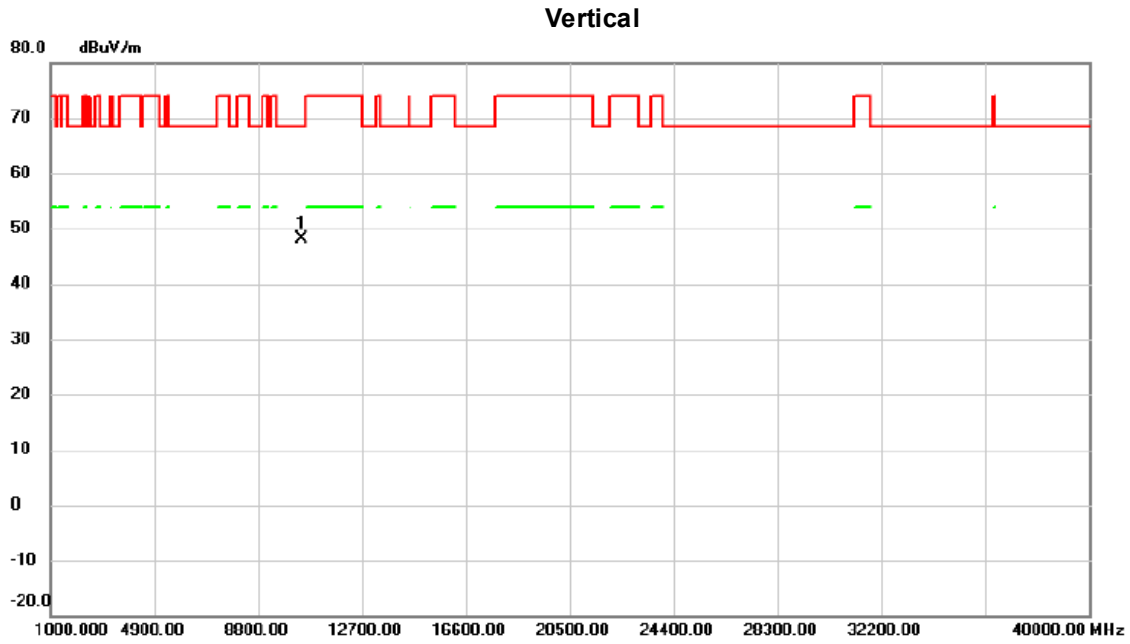

No.	Mk.	Freq.	Reading Level	Correct Factor	Measurement	Limit	Margin	Detector	Comment
		MHz	dBuV	dB	dBuV/m	dBuV/m	dB		
1	*	10418.15	33.15	15.02	48.17	68.30	-20.13	peak	

REMARKS:

- (1) Measurement Value = Reading Level + Correct Factor.
- (2) Margin Level = Measurement Value - Limit Value.

Orthogonal Axis	X
Test Mode	UNII-1_TX AC (VHT80) Mode 5210 MHz

Horizontal

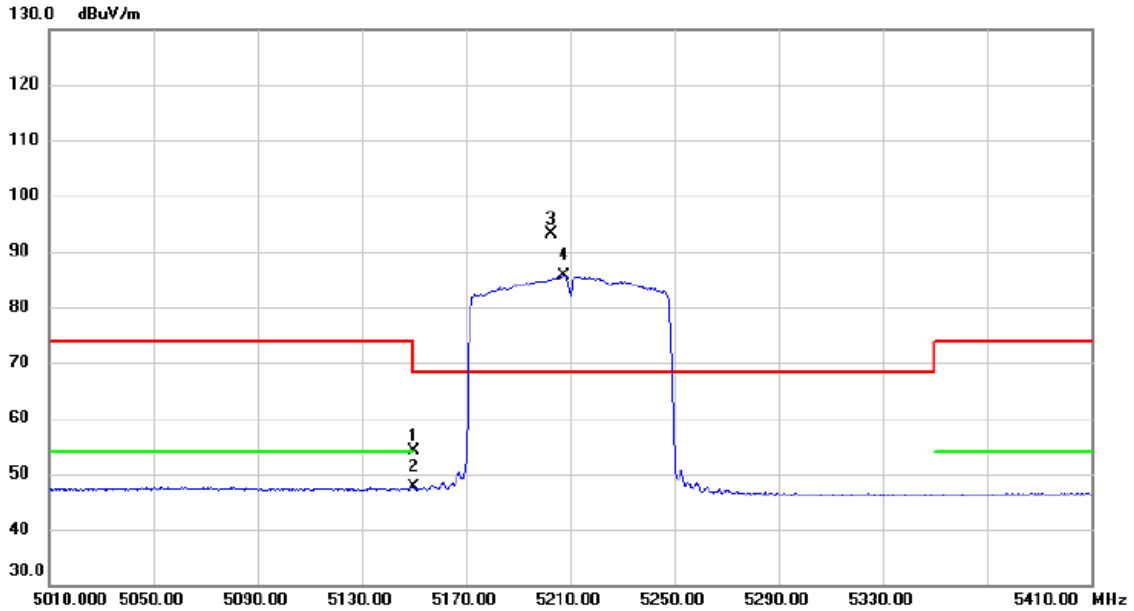

No.	Mk.	Freq. MHz	Reading Level dBuV	Correct Factor dB	Measure- ment dBuV/m	Limit dBuV/m	Margin dB	Detector	Comment
1		5150.000	36.45	17.71	54.16	74.00	-19.84	peak	
2		5150.000	29.94	17.71	47.65	54.00	-6.35	AVG	
3	*	5202.800	75.35	17.87	93.22	68.30	24.92	peak	No Limit
4	X	5207.800	67.74	17.89	85.63	68.30	17.33	AVG	No Limit

REMARKS:

- (1) Measurement Value = Reading Level + Correct Factor.
- (2) Margin Level = Measurement Value - Limit Value.

Orthogonal Axis	X
Test Mode	UNII-1_TX AC (VHT80) Mode 5210 MHz

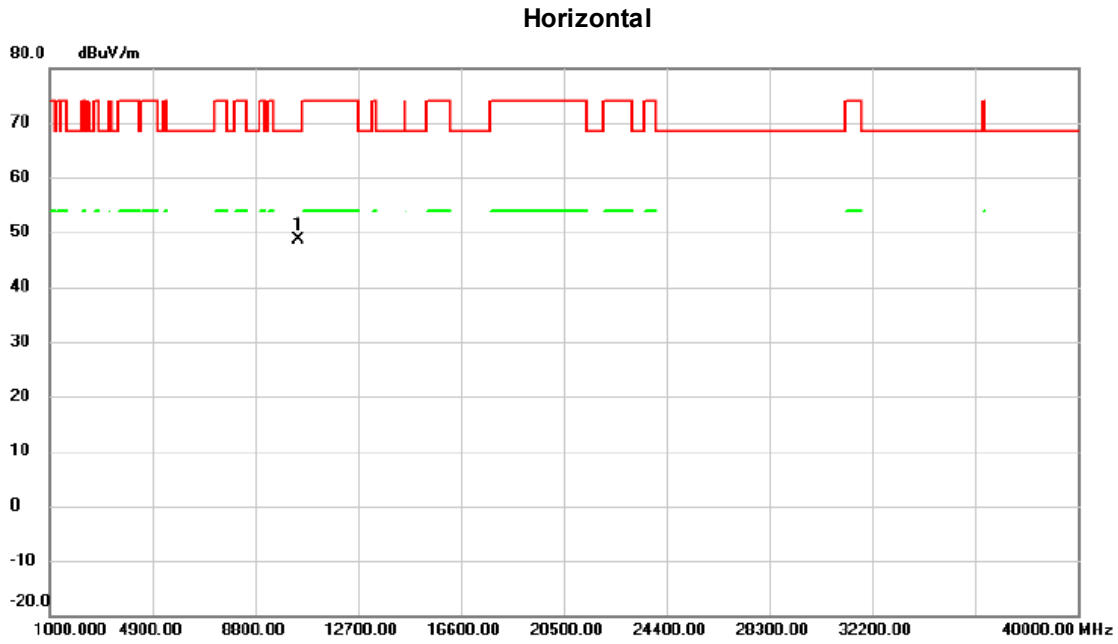

No.	Mk.	Freq.	Reading Level	Correct Factor	Measurement	Limit	Margin	Detector	Comment
		MHz	dBuV	dB	dBuV/m	dBuV/m	dB		
1	*	10421.30	33.71	15.03	48.74	68.30	-19.56	peak	

REMARKS:

- (1) Measurement Value = Reading Level + Correct Factor.
- (2) Margin Level = Measurement Value - Limit Value.

Orthogonal Axis	X
Test Mode	UNII-3_TX AC (VHT20) Mode 5745 MHz

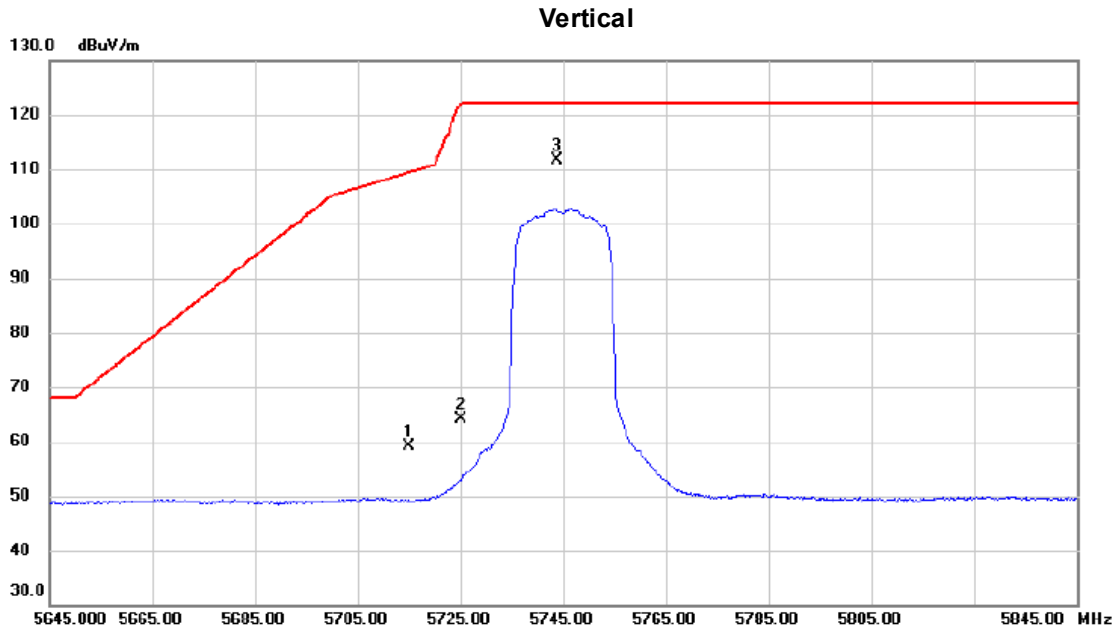

No.	Mk.	Freq. MHz	Reading Level dBuV	Correct Factor dB	Measure- ment dBuV/m	Limit dBuV/m	Margin dB	Detector	Comment
1		5715.000	39.66	19.46	59.12	109.40	-50.28	peak	
2		5725.000	44.53	19.49	64.02	122.20	-58.18	peak	
3	*	5743.800	92.11	19.56	111.67	122.20	-10.53	peak	No Limit

REMARKS:

- (1) Measurement Value = Reading Level + Correct Factor.
- (2) Margin Level = Measurement Value - Limit Value.

Orthogonal Axis	X
Test Mode	UNII-3_TX AC (VHT20) Mode 5745 MHz

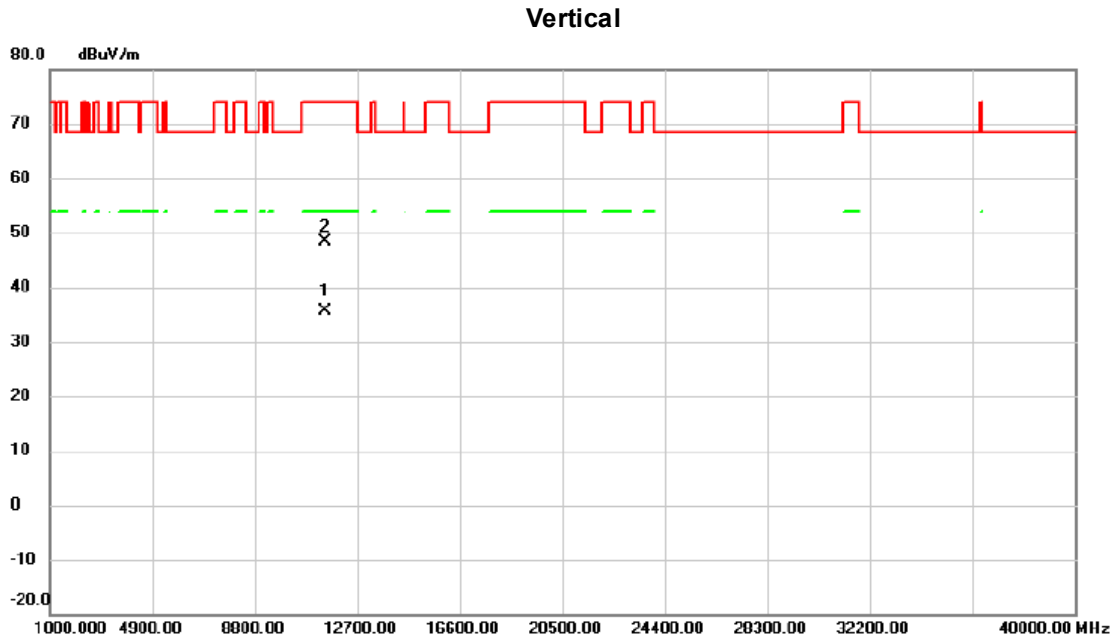

No.	Mk.	Freq. MHz	Reading Level dBuV	Correct Factor dB	Measure- ment dBuV/m	Limit dBuV/m	Margin dB	Detector	Comment
1	*	11491.70	18.65	16.98	35.63	54.00	-18.37	AVG	
2		11491.85	31.52	16.98	48.50	74.00	-25.50	peak	

REMARKS:

- (1) Measurement Value = Reading Level + Correct Factor.
- (2) Margin Level = Measurement Value - Limit Value.

Orthogonal Axis	X
Test Mode	UNII-3_TX AC (VHT20) Mode 5745 MHz

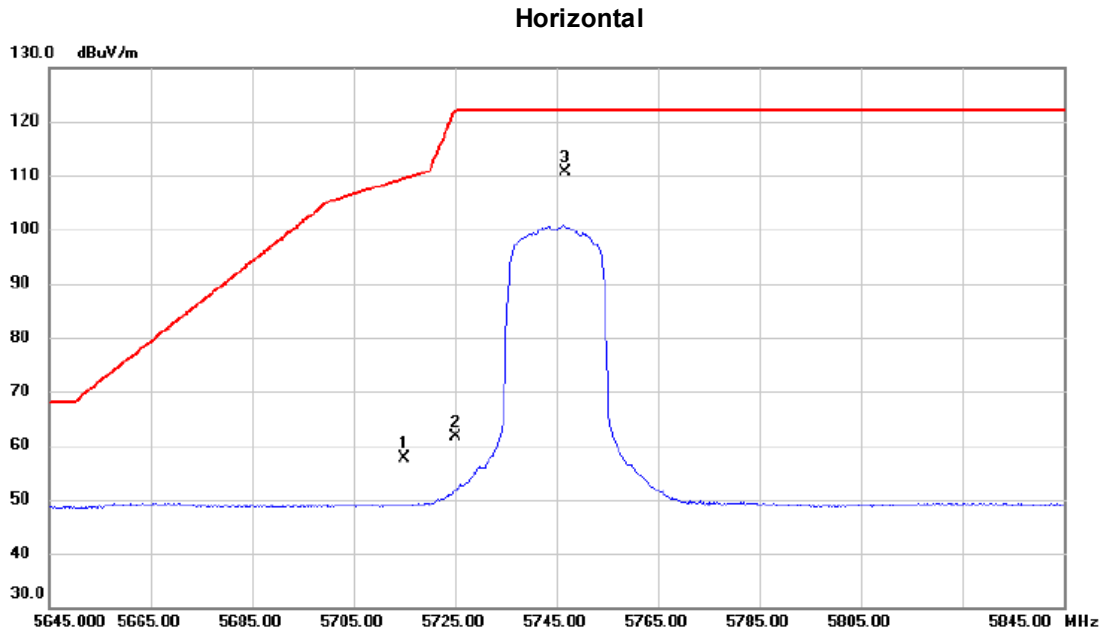

No.	Mk.	Freq. MHz	Reading Level dBuV	Correct Factor dB	Measure- ment dBuV/m	Limit dBuV/m	Margin dB	Detector	Comment
1		5715.000	38.07	19.46	57.53	109.40	-51.87	peak	
2		5725.000	42.14	19.49	61.63	122.20	-60.57	peak	
3	*	5746.700	91.19	19.56	110.75	122.20	-11.45	peak	No Limit

REMARKS:

- (1) Measurement Value = Reading Level + Correct Factor.
- (2) Margin Level = Measurement Value - Limit Value.

Orthogonal Axis	X
Test Mode	UNII-3_TX AC (VHT20) Mode 5745 MHz

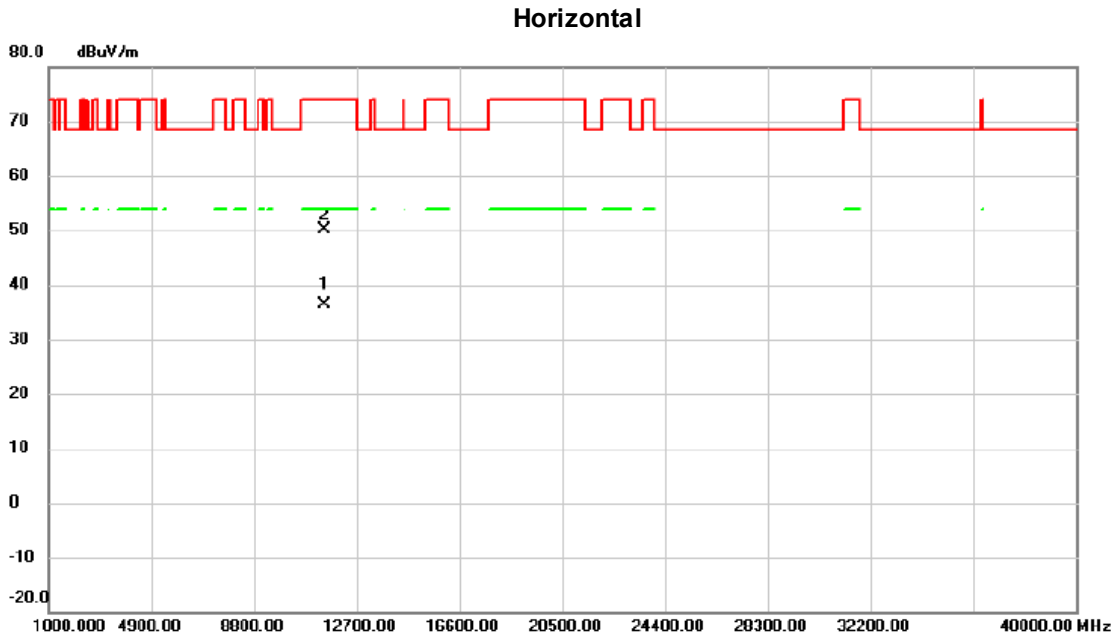

No.	Mk.	Freq. MHz	Reading Level dBuV	Correct Factor dB	Measure- ment dBuV/m	Limit dBuV/m	Margin dB	Detector	Comment
1	*	11488.37	19.38	16.98	36.36	54.00	-17.64	AVG	
2		11492.46	33.08	16.98	50.06	74.00	-23.94	peak	

REMARKS:

- (1) Measurement Value = Reading Level + Correct Factor.
- (2) Margin Level = Measurement Value - Limit Value.

Orthogonal Axis	X
Test Mode	UNII-3_TX AC (VHT20) Mode 5785 MHz

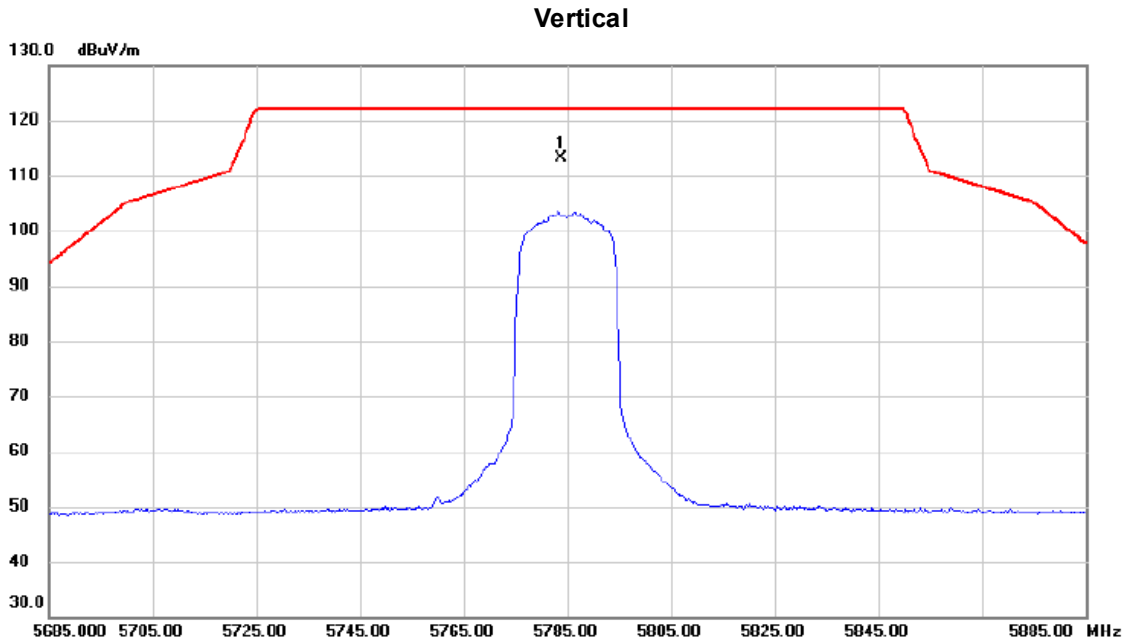

No.	Mk.	Freq.	Reading Level	Correct Factor	Measurement	Limit	Margin		
		MHz	dBuV	dB	dBuV/m	dBuV/m	dB	Detector	Comment
1	*	5783.700	93.48	19.68	113.16	122.20	-9.04	peak	No Limit

REMARKS:

- (1) Measurement Value = Reading Level + Correct Factor.
- (2) Margin Level = Measurement Value - Limit Value.

Orthogonal Axis	X
Test Mode	UNII-3_TX AC (VHT20) Mode 5785 MHz

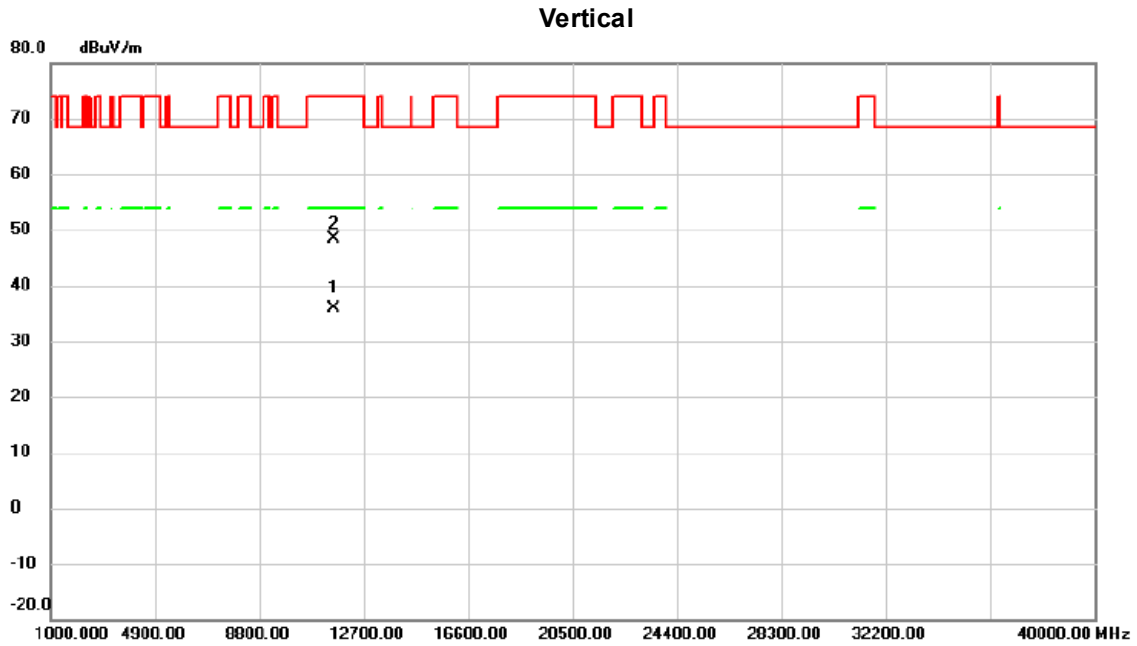

No.	Mk.	Freq.	Reading Level	Correct Factor	Measurement	Limit	Margin	Detector	Comment
		MHz	dBuV	dB	dBuV/m	dBuV/m	dB		
1	*	11567.67	19.04	16.96	36.00	54.00	-18.00	AVG	
2		11569.91	31.53	16.96	48.49	74.00	-25.51	peak	

REMARKS:

- (1) Measurement Value = Reading Level + Correct Factor.
- (2) Margin Level = Measurement Value - Limit Value.

Orthogonal Axis	X
Test Mode	UNII-3_TX AC (VHT20) Mode 5785 MHz

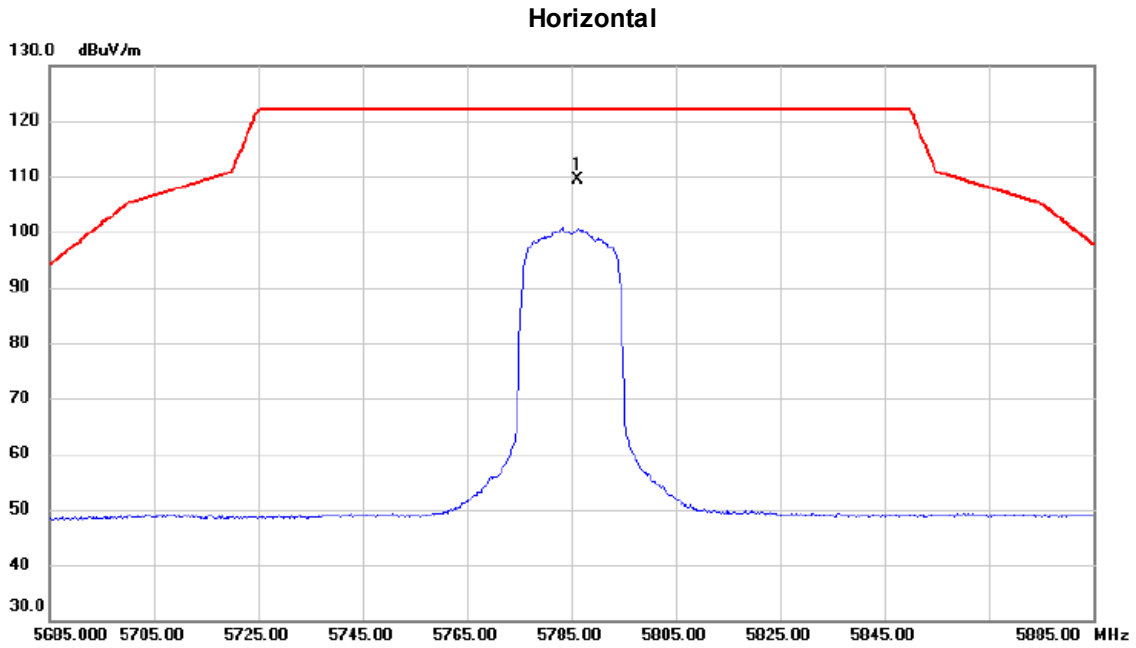

No.	Mk.	Freq.	Reading Level	Correct Factor	Measurement	Limit	Margin	Detector	Comment
		MHz	dBuV	dB	dBuV/m	dBuV/m	dB		
1	*	5786.300	89.68	19.69	109.37	122.20	-12.83	peak	No Limit

REMARKS:

- (1) Measurement Value = Reading Level + Correct Factor.
- (2) Margin Level = Measurement Value - Limit Value.

Orthogonal Axis	X
Test Mode	UNII-3_TX AC (VHT20) Mode 5785 MHz

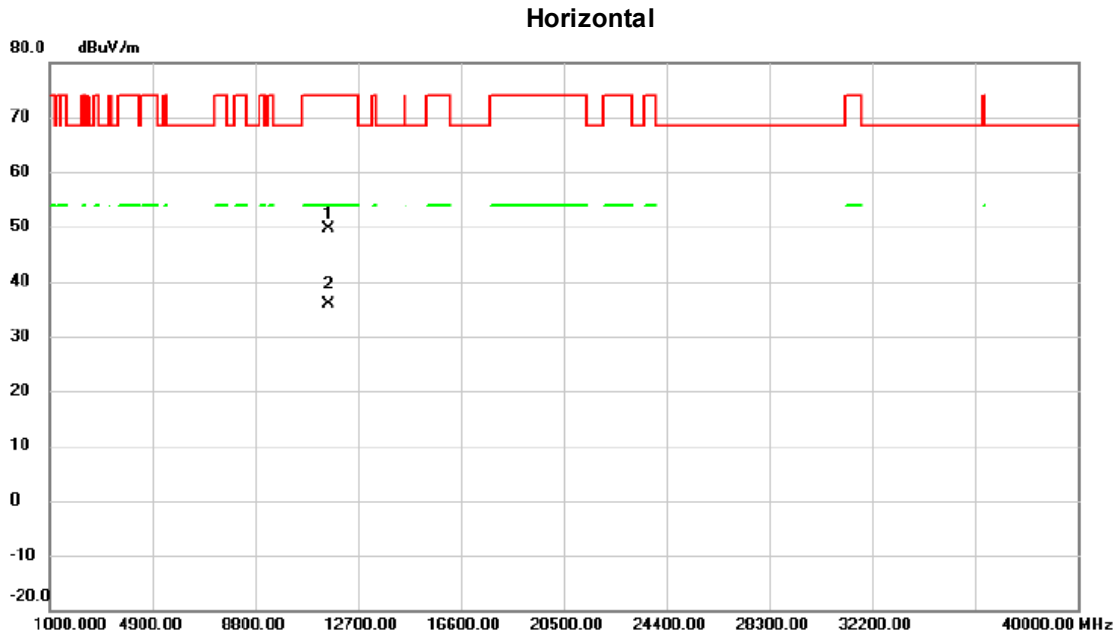

No.	Mk.	Freq. MHz	Reading Level dBuV	Correct Factor dB	Measure- ment dBuV/m	Limit dBuV/m	Margin dB	Detector	Comment
1		11569.64	32.78	16.96	49.74	74.00	-24.26	peak	
2	*	11570.76	19.01	16.96	35.97	54.00	-18.03	AVG	

REMARKS:

- (1) Measurement Value = Reading Level + Correct Factor.
- (2) Margin Level = Measurement Value - Limit Value.

Orthogonal Axis	X
Test Mode	UNII-3_TX AC (VHT20) Mode 5825 MHz

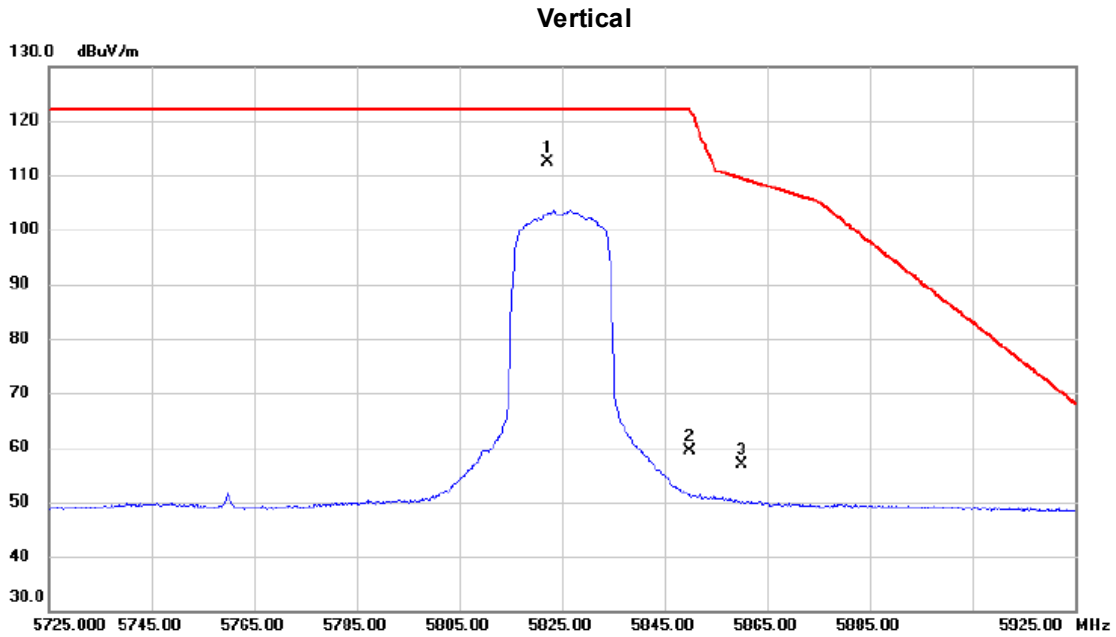

No.	Mk.	Freq. MHz	Reading Level dBuV	Correct Factor dB	Measure- ment dBuV/m	Limit dBuV/m	Margin dB	Detector	Comment
1	*	5822.100	92.50	19.80	112.30	122.20	-9.90	peak	No Limit
2		5850.000	39.53	19.89	59.42	122.20	-62.78	peak	
3		5860.000	36.87	19.92	56.79	109.40	-52.61	peak	

REMARKS:

- (1) Measurement Value = Reading Level + Correct Factor.
- (2) Margin Level = Measurement Value - Limit Value.

Orthogonal Axis	X
Test Mode	UNII-3_TX AC (VHT20) Mode 5825 MHz

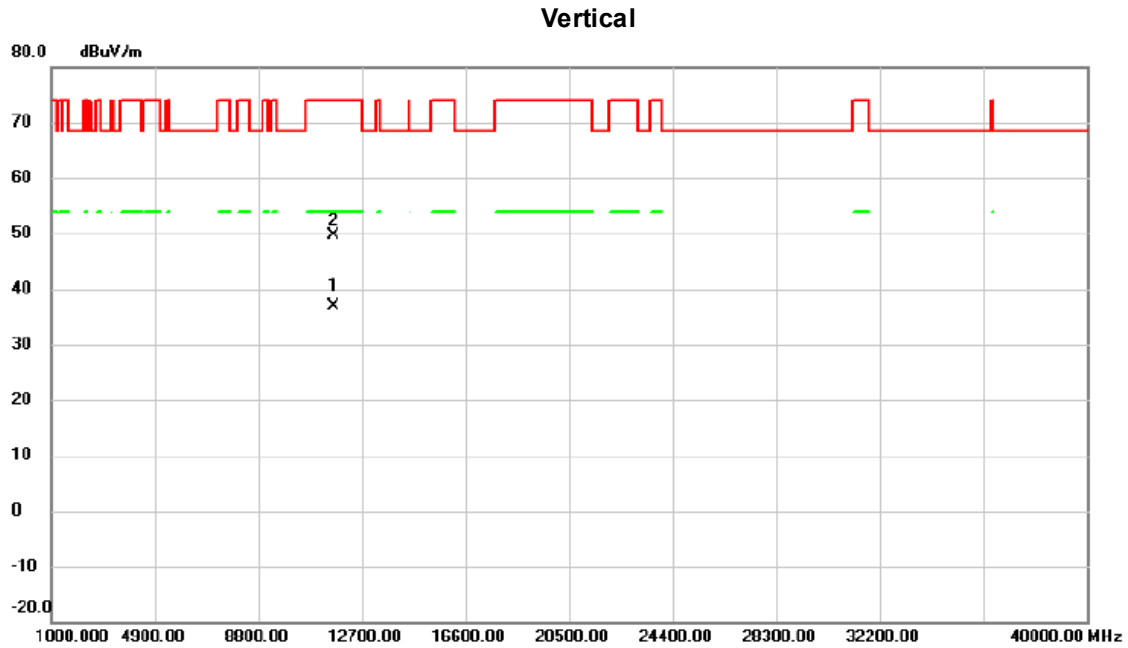

No.	Mk.	Freq. MHz	Reading Level dBuV	Correct Factor dB	Measure- ment dBuV/m	Limit dBuV/m	Margin dB	Detector	Comment
1	*	11648.11	20.01	16.93	36.94	54.00	-17.06	AVG	
2		11650.01	32.69	16.94	49.63	74.00	-24.37	peak	

REMARKS:

- (1) Measurement Value = Reading Level + Correct Factor.
- (2) Margin Level = Measurement Value - Limit Value.

Orthogonal Axis	X
Test Mode	UNII-3_TX AC (VHT20) Mode 5825 MHz

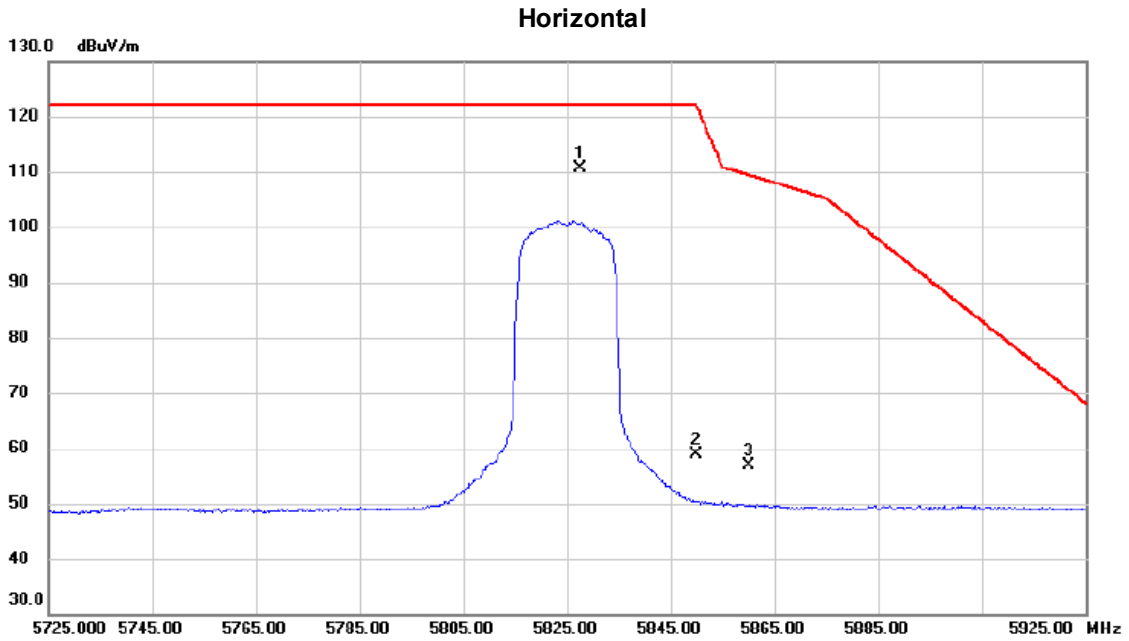

No.	Mk.	Freq. MHz	Reading Level dBuV	Correct Factor dB	Measure- ment dBuV/m	Limit dBuV/m	Margin dB	Detector	Comment
1	*	5827.600	90.71	19.82	110.53	122.20	-11.67	peak	No Limit
2		5850.000	38.87	19.89	58.76	122.20	-63.44	peak	
3		5860.000	36.98	19.92	56.90	109.40	-52.50	peak	

REMARKS:

- (1) Measurement Value = Reading Level + Correct Factor.
- (2) Margin Level = Measurement Value - Limit Value.

Orthogonal Axis	X
Test Mode	UNII-3_TX AC (VHT20) Mode 5825 MHz

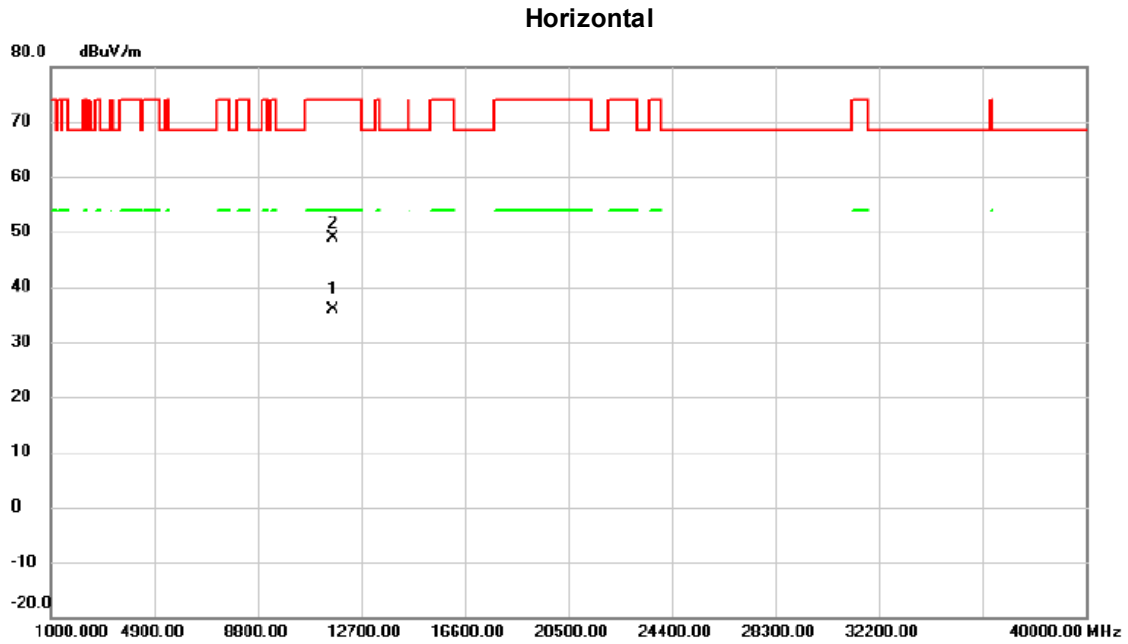

No.	Mk.	Freq. MHz	Reading Level dBuV	Correct Factor dB	Measure- ment dBuV/m	Limit dBuV/m	Margin dB	Detector	Comment
1	*	11649.50	18.90	16.93	35.83	54.00	-18.17	AVG	
2		11652.33	31.84	16.94	48.78	74.00	-25.22	peak	

REMARKS:

- (1) Measurement Value = Reading Level + Correct Factor.
- (2) Margin Level = Measurement Value - Limit Value.

Orthogonal Axis	X
Test Mode	UNII-3_TX AC (VHT40) Mode 5755 MHz

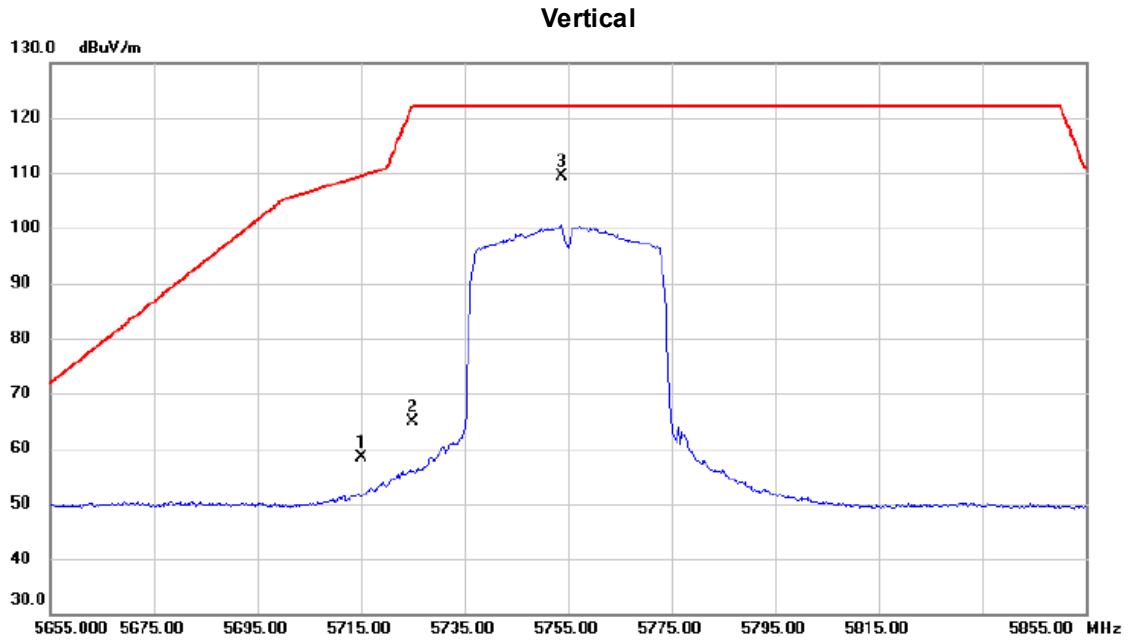

No. Mk.	Freq. MHz	Reading Level dBuV	Correct Factor dB	Measurement dBuV/m	Limit dBuV/m	Margin dB	Detector	Comment
1	5715.000	39.01	19.46	58.47	109.40	-50.93	peak	
2	5725.000	45.35	19.49	64.84	122.20	-57.36	peak	
3 *	5753.700	89.84	19.58	109.42	122.20	-12.78	peak	No Limit

REMARKS:

- (1) Measurement Value = Reading Level + Correct Factor.
- (2) Margin Level = Measurement Value - Limit Value.

Orthogonal Axis	X
Test Mode	UNII-3_TX AC (VHT40) Mode 5755 MHz

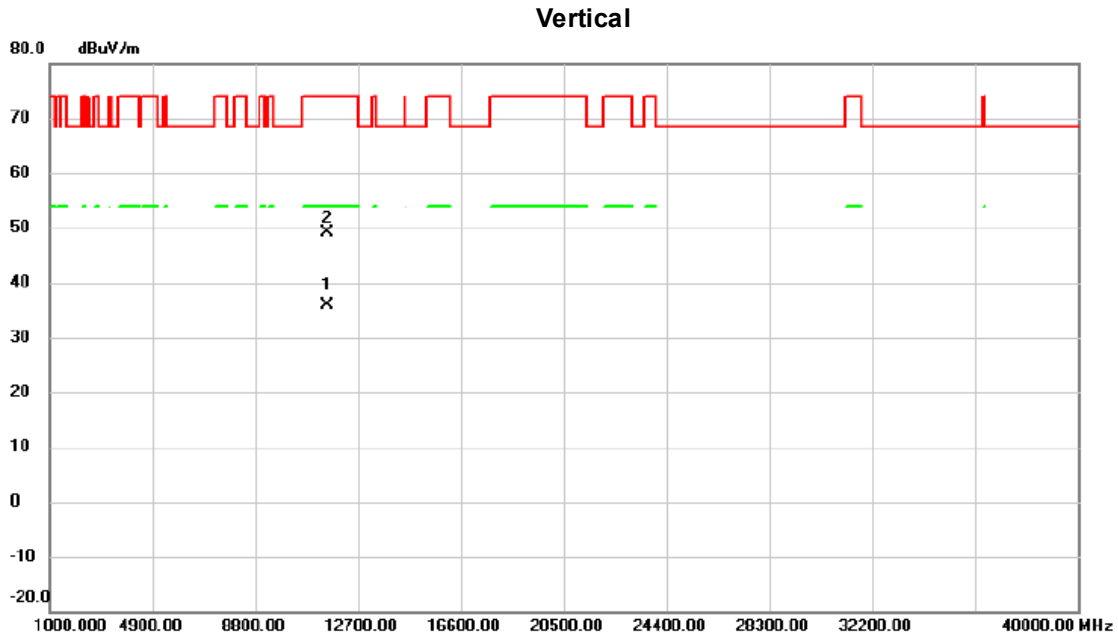

No.	Mk.	Freq. MHz	Reading Level dBuV	Correct Factor dB	Measure- ment dBuV/m	Limit dBuV/m	Margin dB	Detector	Comment
1	*	11507.86	18.94	16.98	35.92	54.00	-18.08	AVG	
2		11509.13	32.23	16.97	49.20	74.00	-24.80	peak	

REMARKS:

- (1) Measurement Value = Reading Level + Correct Factor.
- (2) Margin Level = Measurement Value - Limit Value.

Orthogonal Axis	X
Test Mode	UNII-3_TX AC (VHT40) Mode 5755 MHz

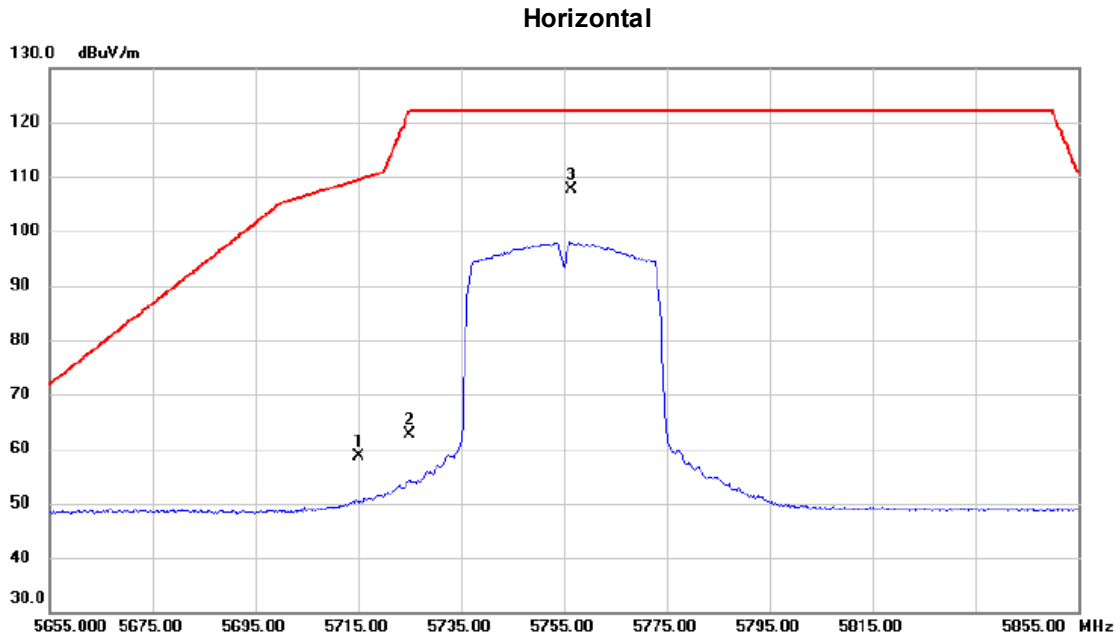

No.	Mk.	Freq. MHz	Reading Level dBuV	Correct Factor dB	Measure- ment dBuV/m	Limit dBuV/m	Margin dB	Detector	Comment
1		5715.000	39.05	19.46	58.51	109.40	-50.89	peak	
2		5725.000	43.04	19.49	62.53	122.20	-59.67	peak	
3	*	5756.500	87.98	19.60	107.58	122.20	-14.62	peak	No Limit

REMARKS:

- (1) Measurement Value = Reading Level + Correct Factor.
- (2) Margin Level = Measurement Value - Limit Value.

Orthogonal Axis	X
Test Mode	UNII-3_TX AC (VHT40) Mode 5755 MHz

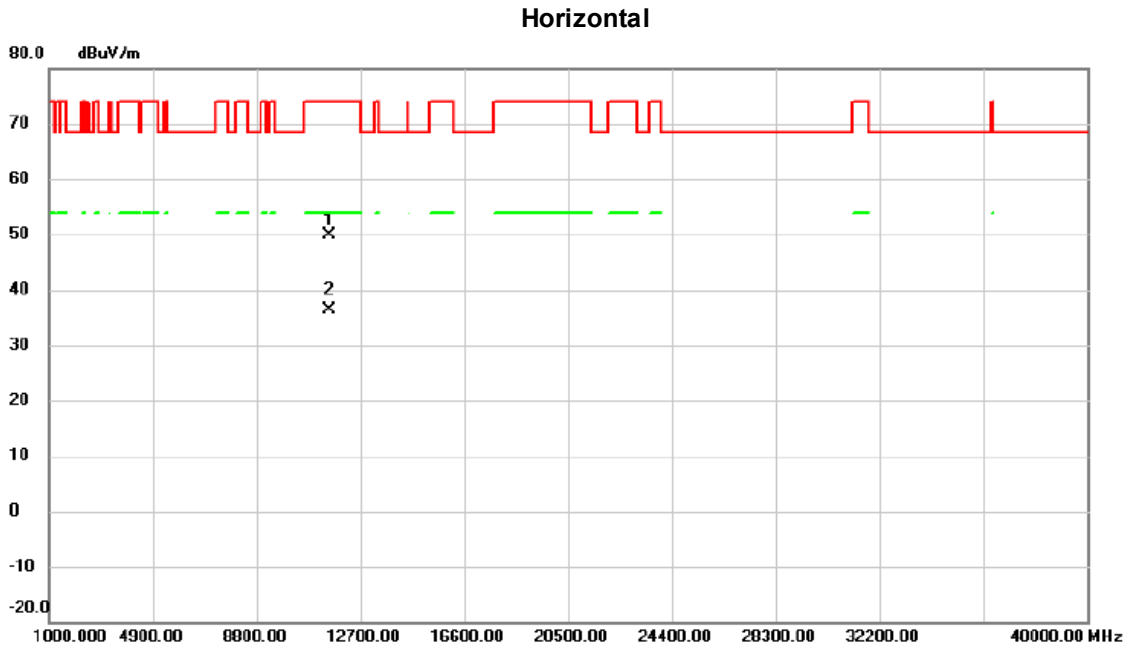

No.	Mk.	Freq.	Reading Level	Correct Factor	Measurement	Limit	Margin	Detector	Comment
		MHz	dBuV	dB	dBuV/m	dBuV/m	dB		
1		11509.55	32.95	16.97	49.92	74.00	-24.08	peak	
2	*	11510.14	19.37	16.97	36.34	54.00	-17.66	AVG	

REMARKS:

- (1) Measurement Value = Reading Level + Correct Factor.
- (2) Margin Level = Measurement Value - Limit Value.

Orthogonal Axis	X
Test Mode	UNII-3_TX AC (VHT40) Mode 5795 MHz

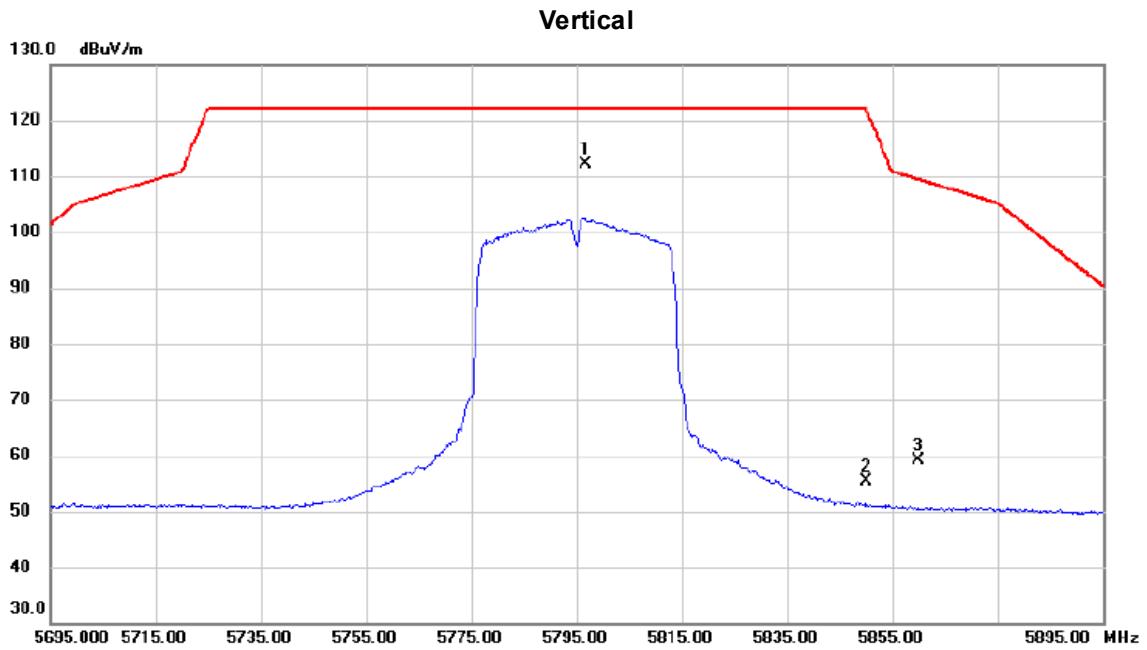

No.	Mk.	Freq.	Reading Level	Correct Factor	Measurement	Limit	Margin		
		MHz	dBuV	dB	dBuV/m	dBuV/m	dB	Detector	Comment
1	*	5796.800	92.45	19.72	112.17	122.20	-10.03	peak	No Limit
2		5850.000	35.61	19.89	55.50	122.20	-66.70	peak	
3		5860.000	39.21	19.92	59.13	109.40	-50.27	peak	

REMARKS:

- (1) Measurement Value = Reading Level + Correct Factor.
- (2) Margin Level = Measurement Value - Limit Value.

Orthogonal Axis	X
Test Mode	UNII-3_TX AC (VHT40) Mode 5795 MHz

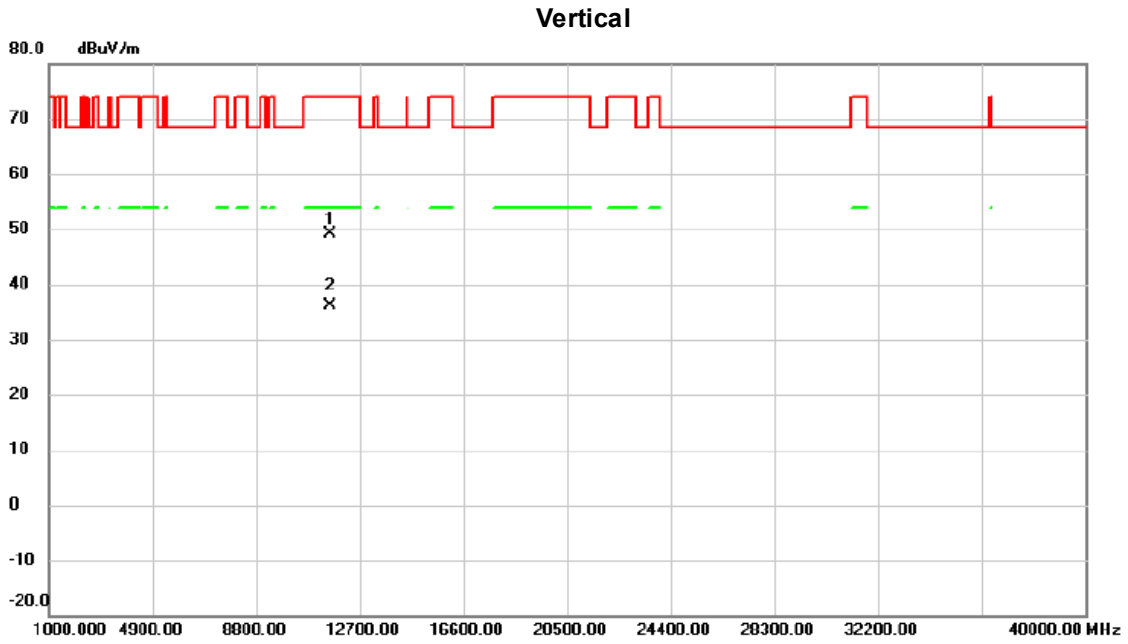

No.	Mk.	Freq. MHz	Reading Level dBuV	Correct Factor dB	Measure- ment dBuV/m	Limit dBuV/m	Margin dB	Detector	Comment
1		11588.86	32.26	16.96	49.22	74.00	-24.78	peak	
2	*	11589.43	19.06	16.96	36.02	54.00	-17.98	AVG	

REMARKS:

- (1) Measurement Value = Reading Level + Correct Factor.
- (2) Margin Level = Measurement Value - Limit Value.

Orthogonal Axis	X
Test Mode	UNII-3_TX AC (VHT40) Mode 5795 MHz

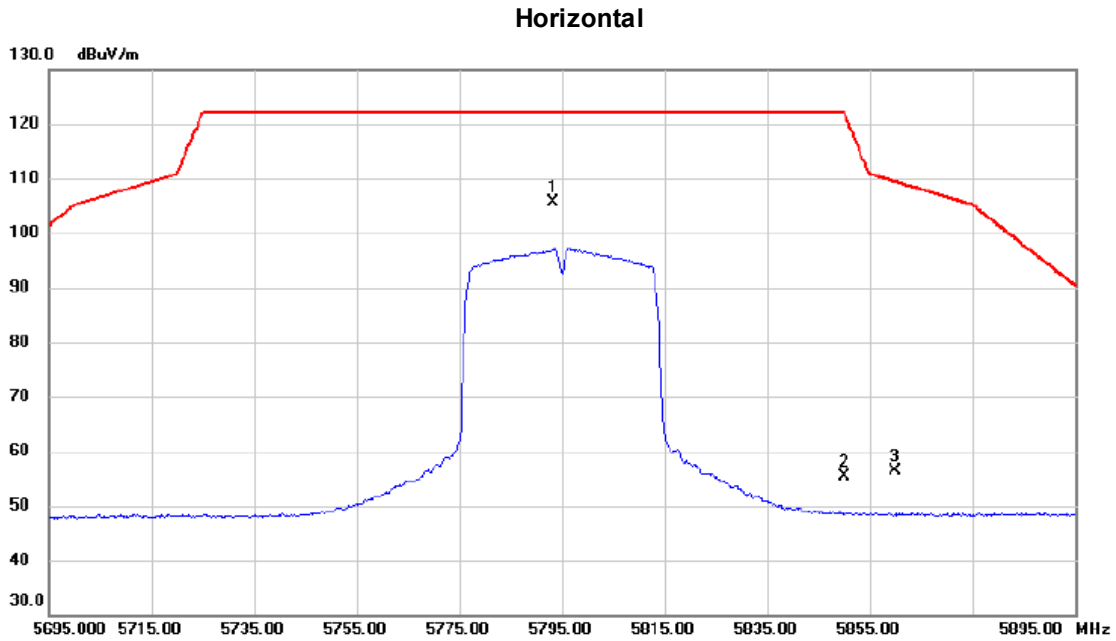

No.	Mk.	Freq. MHz	Reading Level dBuV	Correct Factor dB	Measure- ment dBuV/m	Limit dBuV/m	Margin dB	Detector	Comment
1	*	5793.200	86.03	19.70	105.73	122.20	-16.47	peak	No Limit
2		5850.000	35.40	19.89	55.29	122.20	-66.91	peak	
3		5860.000	36.39	19.92	56.31	109.40	-53.09	peak	

REMARKS:

- (1) Measurement Value = Reading Level + Correct Factor.
- (2) Margin Level = Measurement Value - Limit Value.

Orthogonal Axis	X
Test Mode	UNII-3_TX AC (VHT40) Mode 5795 MHz

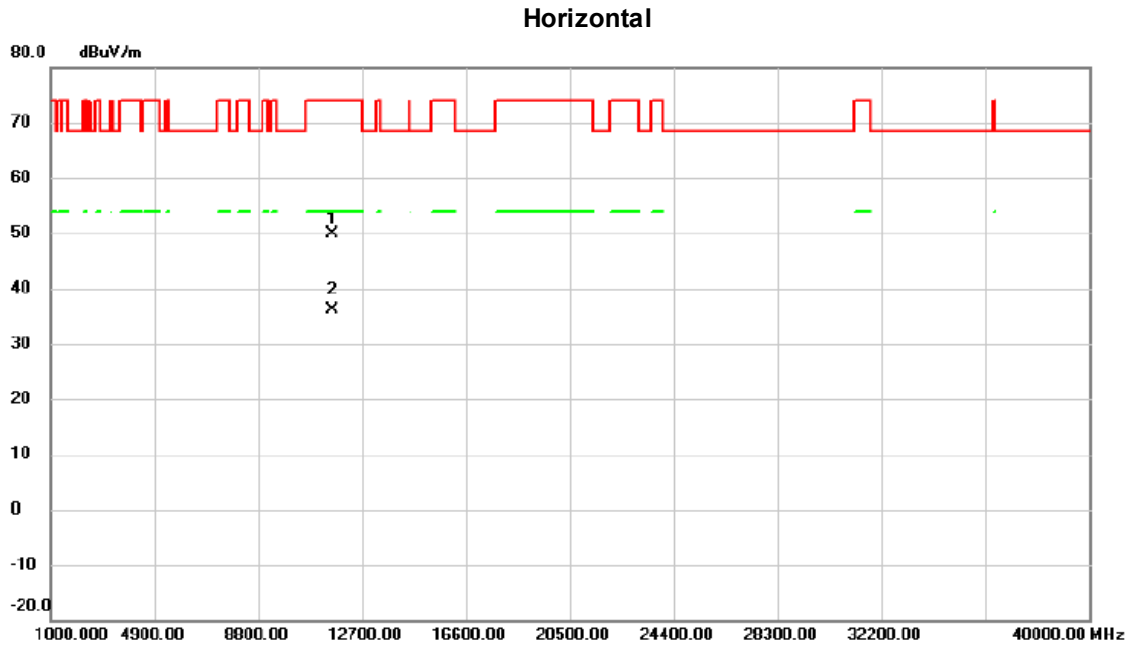

No.	Mk.	Freq. MHz	Reading Level dBuV	Correct Factor dB	Measure- ment dBuV/m	Limit dBuV/m	Margin dB	Detector	Comment
1		11588.66	32.80	16.96	49.76	74.00	-24.24	peak	
2	*	11590.54	19.20	16.96	36.16	54.00	-17.84	AVG	

REMARKS:

- (1) Measurement Value = Reading Level + Correct Factor.
- (2) Margin Level = Measurement Value - Limit Value.

Orthogonal Axis	X
Test Mode	UNII-3_TX AC (VHT80) Mode 5775 MHz

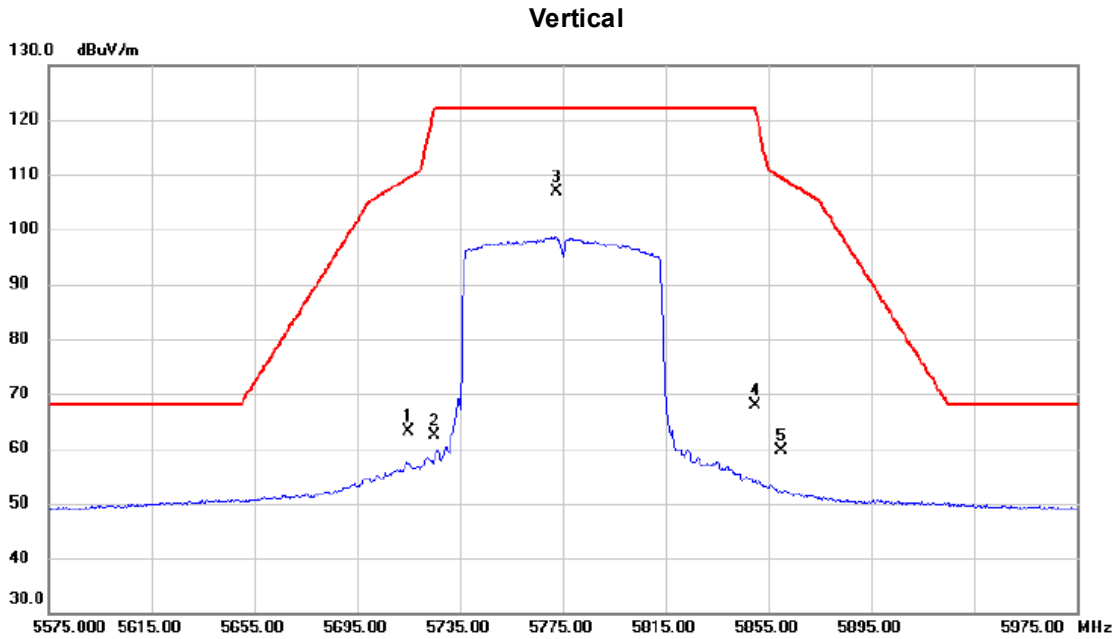

No.	Mk.	Freq. MHz	Reading Level dBuV	Correct Factor dB	Measure- ment dBuV/m	Limit dBuV/m	Margin dB	Detector	Comment
1		5715.000	43.64	19.46	63.10	109.40	-46.30	peak	
2		5725.000	42.82	19.49	62.31	122.20	-59.89	peak	
3	*	5772.800	87.12	19.64	106.76	122.20	-15.44	peak	No Limit
4		5850.000	48.11	19.89	68.00	122.20	-54.20	peak	
5		5860.000	39.61	19.92	59.53	109.40	-49.87	peak	

REMARKS:

- (1) Measurement Value = Reading Level + Correct Factor.
- (2) Margin Level = Measurement Value - Limit Value.

Orthogonal Axis	X
Test Mode	UNII-3_TX AC (VHT80) Mode 5775 MHz

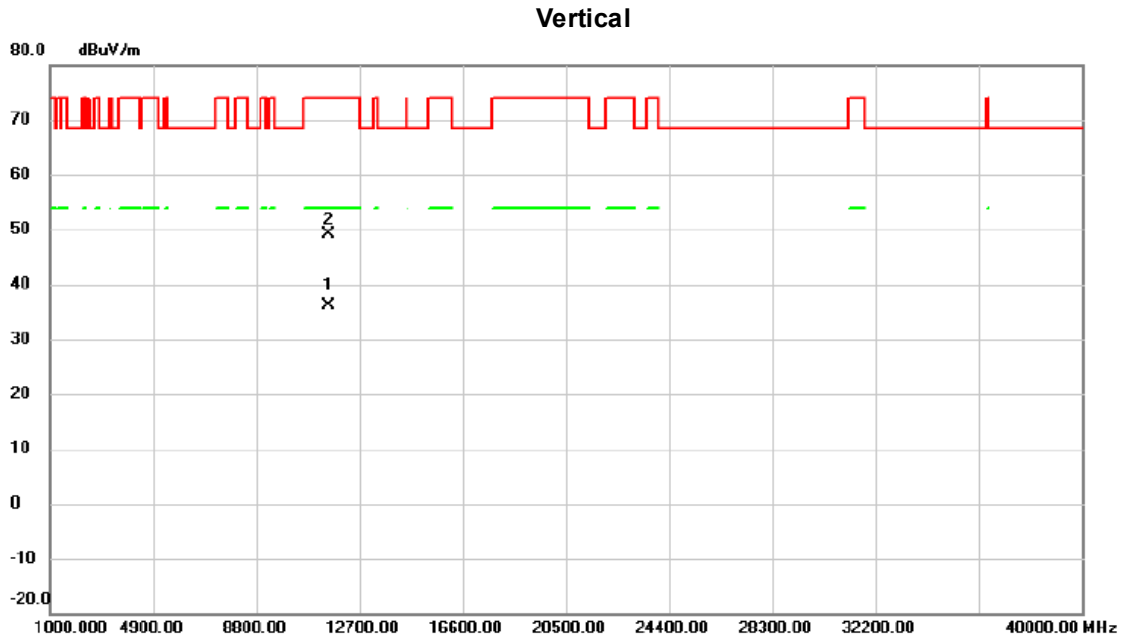

No.	Mk.	Freq. MHz	Reading Level dBuV	Correct Factor dB	Measure- ment dBuV/m	Limit dBuV/m	Margin dB	Detector	Comment
1	*	11548.13	19.17	16.96	36.13	54.00	-17.87	AVG	
2		11548.29	32.20	16.96	49.16	74.00	-24.84	peak	

REMARKS:

- (1) Measurement Value = Reading Level + Correct Factor.
- (2) Margin Level = Measurement Value - Limit Value.

Orthogonal Axis	X
Test Mode	UNII-3_TX AC (VHT80) Mode 5775 MHz

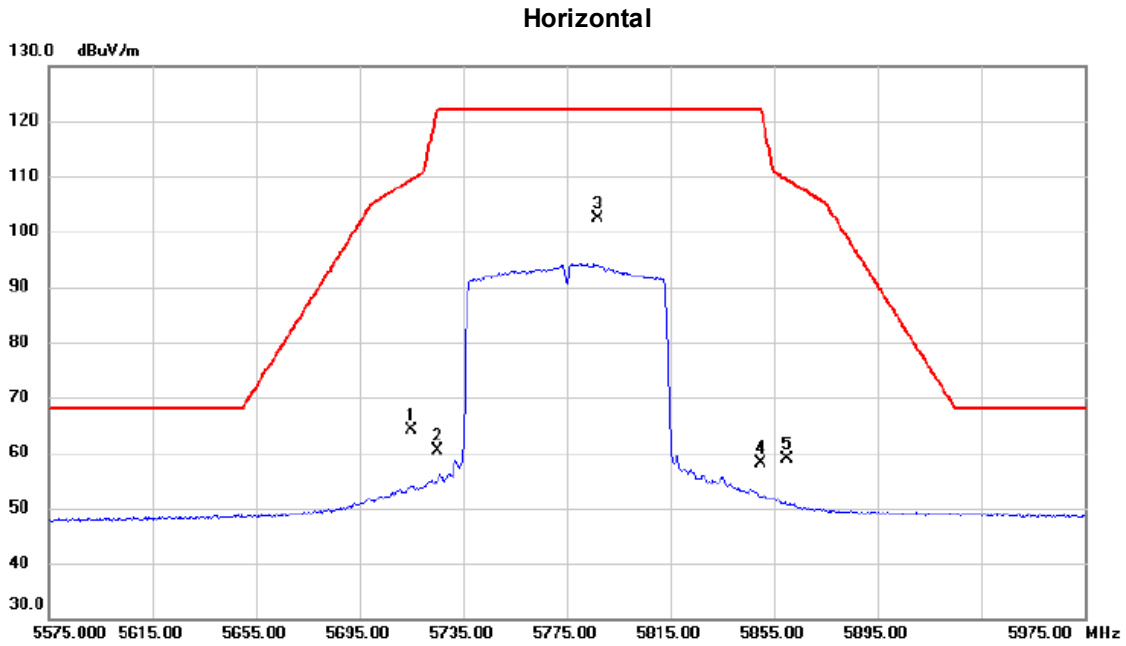

No.	Mk.	Freq. MHz	Reading Level dBuV	Correct Factor dB	Measure- ment dBuV/m	Limit dBuV/m	Margin dB	Detector	Comment
1		5715.000	44.74	19.46	64.20	109.40	-45.20	peak	
2		5725.000	40.88	19.49	60.37	122.20	-61.83	peak	
3	*	5787.000	82.69	19.69	102.38	122.20	-19.82	peak	No Limit
4		5850.000	38.20	19.89	58.09	122.20	-64.11	peak	
5		5860.000	38.99	19.92	58.91	109.40	-50.49	peak	

REMARKS:

- (1) Measurement Value = Reading Level + Correct Factor.
- (2) Margin Level = Measurement Value - Limit Value.

Orthogonal Axis	X
Test Mode	UNII-3_TX AC (VHT80) Mode 5775 MHz

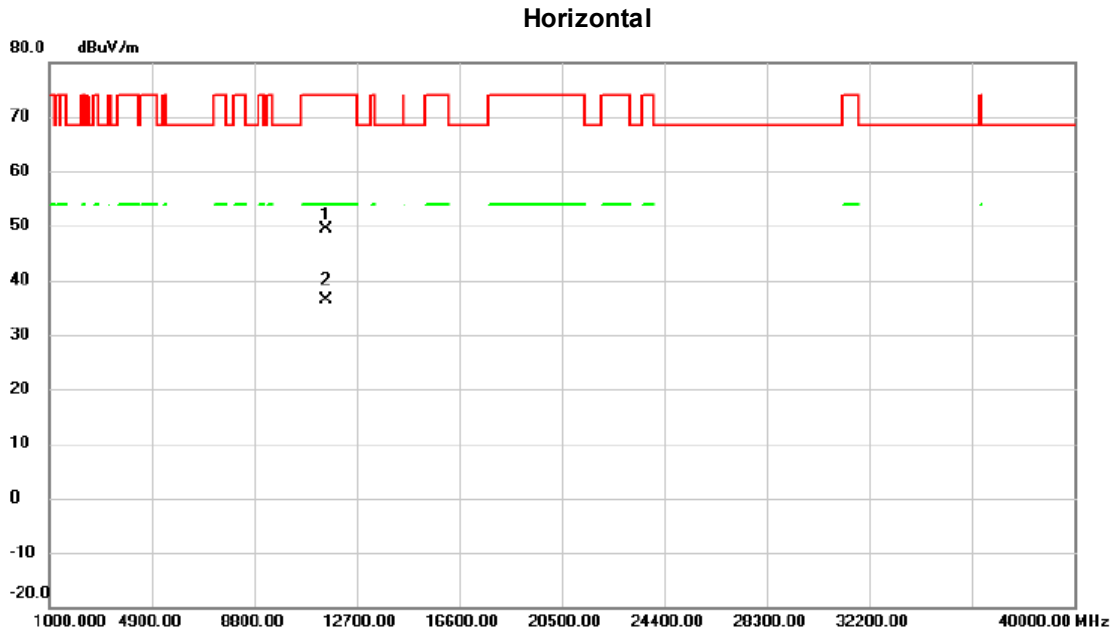

No.	Mk.	Freq. MHz	Reading Level dBuV	Correct Factor dB	Measure- ment dBuV/m	Limit dBuV/m	Margin dB	Detector	Comment
1		11549.68	32.34	16.96	49.30	74.00	-24.70	peak	
2	*	11550.45	19.42	16.97	36.39	54.00	-17.61	AVG	

REMARKS:

- (1) Measurement Value = Reading Level + Correct Factor.
- (2) Margin Level = Measurement Value - Limit Value.

APPENDIX E - BANDWIDTH

Test Mode UNII-1_TX A Mode

Channel	Frequency (MHz)	26 dB Bandwidth (MHz)	99 % Emission Bandwidth (MHz)
36	5180	20.01	16.60
40	5200	20.05	16.60
48	5240	20.01	16.60

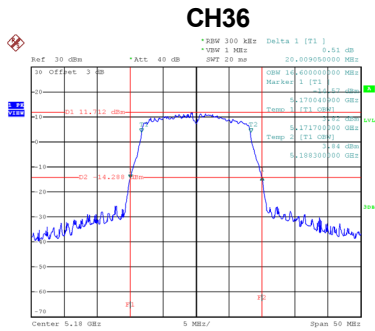

Date: 27.APR.2020 20:09:46

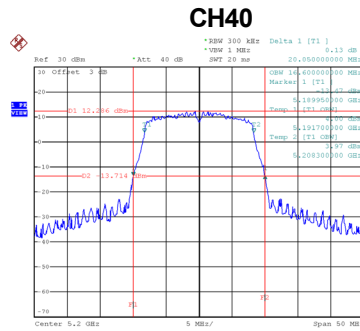

Date: 27.APR.2020 20:10:32

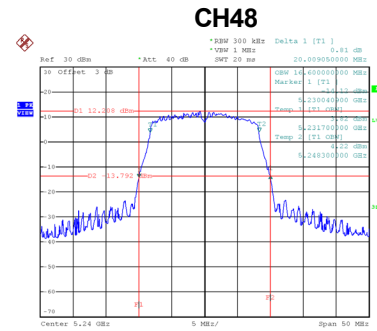

Date: 27.APR.2020 20:11:01

Test Mode UNII-3_TX A Mode

Channel	Frequency (MHz)	6 dB Bandwidth (MHz)	99 % Emission Bandwidth (MHz)	6 dB Bandwidth Min. Limit (kHz)	Result
149	5745	15.10	16.80	500	Complies
157	5785	16.10	16.80	500	Complies
165	5825	15.09	16.80	500	Complies

CH149

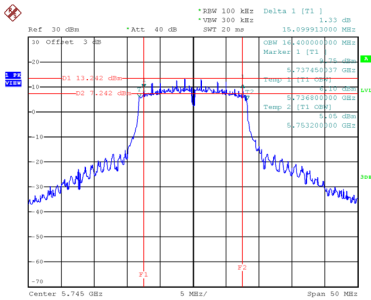

Date: 27_APR.2020 20:11:47

CH157

6 dB Bandwidth

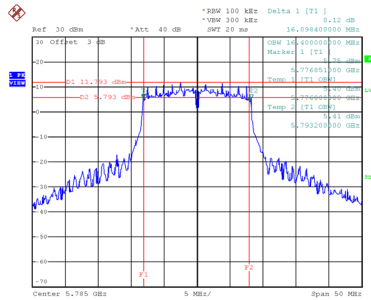

Date: 27_APR.2020 20:12:27

CH165

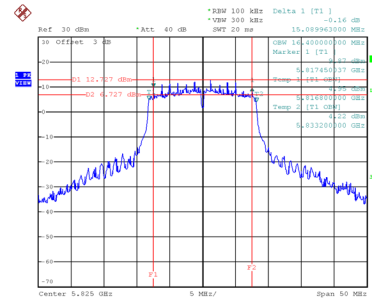

Date: 27_APR.2020 20:13:13

99 % Emission Bandwidth

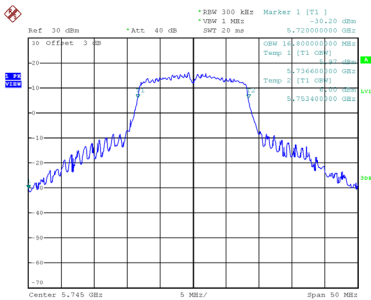

Date: 27_APR.2020 20:11:16

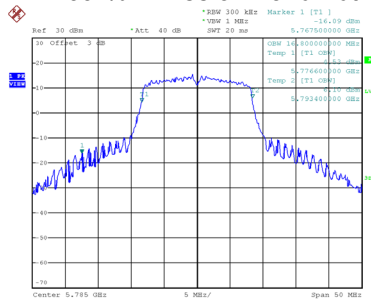

Date: 27_APR.2020 20:11:56

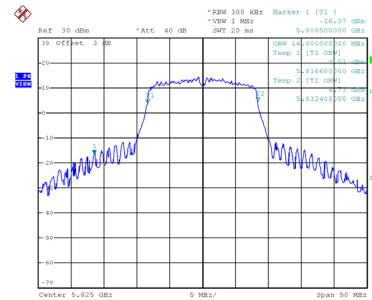

Date: 27_APR.2020 20:12:39

Test Mode	UNII-1_TX AC (VHT20) Mode
-----------	---------------------------

Channel	Frequency (MHz)	26 dB Bandwidth (MHz)	99 % Emission Bandwidth (MHz)
36	5180	20.45	17.70
40	5200	20.39	17.70
48	5240	20.36	17.60

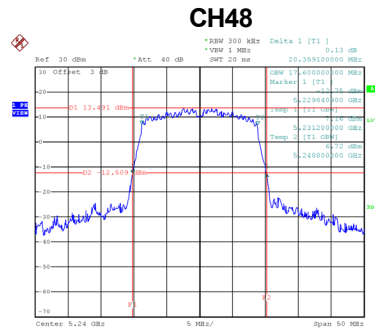
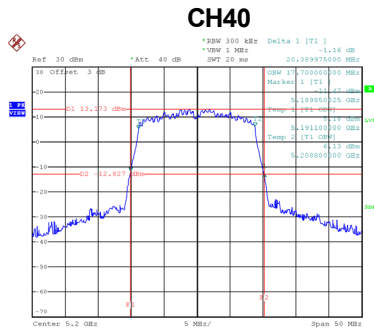
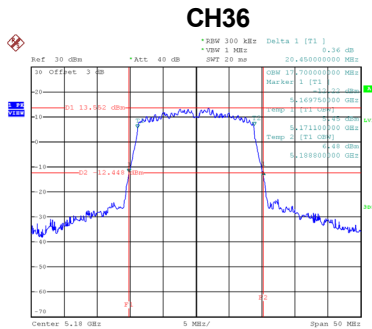

Test Mode	UNII-1_TX AC (VHT40) Mode
-----------	---------------------------

Channel	Frequency (MHz)	26 dB Bandwidth (MHz)	99 % Emission Bandwidth (MHz)
38	5190	40.01	36.20
46	5230	40.19	36.20

