

# SAILOR SP3550 UHF





# SP3550 UHF

**Document number:** TT 98-124308-B

**Release date:** October, 2007

**Copyright:** © 2007 Thrane & Thrane A/S. All rights reserved.

## Trademark Acknowledgements

- **SAILOR** is a registered trademark of Thrane & Thrane A/S.
- **Other product and company names** mentioned in this manual may be trademarks or trade names of their respective owners.

## Warranty limitation

IMPORTANT - The radio is a sealed waterproof unit. To create and maintain its waterproof integrity it was assembled in a controlled environment using special equipment. The radio is not a user maintainable unit, and under no circumstances should the unit be opened except by authorized personnel. Unauthorized opening of the unit will invalidate the warranty.

## Disclaimer

Any responsibility or liability for loss or damage in connection with the use of this product and the accompanying documentation is disclaimed by Thrane & Thrane. The information in this manual is provided for information purposes only, is subject to change without notice, may contain errors or inaccuracies, and represents no commitment whatsoever by Thrane & Thrane. This agreement is governed by the laws of Denmark.

Manuals issued by Thrane & Thrane are periodically revised and updated. Anyone relying on this information should satisfy himself/herself as to the most current version. Providers with access to Thrane & Thrane's Extranet may obtain current copies of manuals at: <http://extranet.thrane.com>.

Thrane & Thrane is not responsible for the content or accuracy of any translations or reproductions, in whole or in part, of this manual from any other source.

## Precautions

Avoid water and salt in the I/O connector and keep it clean frequently.

Only use original Thrane & Thrane battery packs. Make sure they are clean and dry before attaching the transceiver. Be careful not to damage any gaskets.

Only use the original Thrane & Thrane charger for the rechargeable battery.

Be very careful when handling the Lithium batteries. With correct use they are safe but any misuse might cause dangerous situations.

Never short circuit the battery terminals, never expose the transceiver and the batteries to extreme temperature or fire and never use any kind of violence.

Avoid close contact between the antenna and parts of the human body. The top of the antenna must never be closer than 2.5 cm to the body when transmitting.

Do not submerge the transceiver more than 1 m for 30 minutes.

Keep the transceiver at least 0.3 m away from the magnetic compass.

## Training information

SAILOR SP3550 UHF is designed for to be operated safely. It must be operated by licensed personnel only.

The SP3550 complies with the uncontrolled RF exposure limits.

- FCC OET Bulletin 65 Supplement C, evaluating compliance with FCC guidelines for human exposure to radio frequency electromagnetic fields.
- American National Standards Institute (C95.1) IEEE standard for safety levels with respect to human exposure to radio frequency electromagnetic fields, 3 kHz to 300 GHz.
- American National Standards Institute (C95.3) IEEE recommended practice for the measurement of potentially hazardous electromagnetic fields - RF and microwaves.



**Warning!** Your Thrane & Thrane UHF radio generates electromagnetic RF (radio frequency) energy when transmitting. To ensure that you are not exposed to excessive amounts of energy and thus to avoid health hazards from excessive exposure to RF energy, all persons must be at least 2.5 cm away from the antenna when the radio is transmitting.

## Correct use

For best performance, hold the radio vertically and 5 cm away from the head when talking into the microphone.



# Contents

---

## Chapter 1 Introduction

<b>Your UHF</b> .....	1
<b>Performance</b> .....	2
<b>Channels</b> .....	2

## Chapter 2 Operation

<b>Controls</b> .....	5
Keys and buttons .....	5
The display .....	7
<b>Using the UHF</b> .....	8
Basic functions .....	8
Other functions .....	11

## Chapter 3 Batteries

Battery level indication .....	13
Removing and inserting the battery pack .....	13
The battery chargers .....	14
Installing the charger .....	14
Recharging the battery .....	15

## Chapter 4 Configuring the radio

<b>Configuration mode</b> .....	17
Entering and using configuration mode .....	17
List of configuration settings .....	18

---

## Chapter 5 Equipment and accessories

<b>External equipment</b> .....	23
List of equipment .....	23
Connecting external equipment .....	23
Impact on radio operation .....	24
<b>Accessories</b> .....	25
List of accessories .....	25
Attaching and removing the belt clip .....	27
Attaching the lanyard .....	27

## Chapter 6 Troubleshooting

Displaying errors .....	29
-------------------------	----

## App. A Technical specifications

<b>Technical data SP3550</b> .....	31
General .....	31
Transmitter .....	32
Receiver .....	32
<b>Battery life guidelines</b> .....	34
<b>Dimensional drawing, transceiver</b> .....	35
<b>Dimensional drawing, chargers</b> .....	36
<b>Declaration of Conformity</b> .....	37

## App. B Attention

<b>Goretex Membran</b> .....	39
------------------------------	----



## Introduction

### Your UHF

The SP3550 UHF is designed for flexibility in daily use. It connects easily to external equipment like headsets and fist mikes, making the SP3550 suitable for any noisy environment.

Main features:

- Unique man machine interface, an excellent grip even with gloves, and large tactile buttons.
- Display with red adjustable backlight which makes the display visible even at night.
- Built-in “sleep” function, minimizing power consumption and improving battery lifetime.
- Selectable 12.5 kHz narrow band or 25 kHz wide band operation.
- Scrambling function for privacy calls.
- CTCSS function for selective opening of Squelch.
- A lanyard and belt clip included.

A huge accessory program comes with the SAILOR SP3500 series.

Please find the nearest SAILOR distributor on [www.thrane.com](http://www.thrane.com).



## Performance

For best performance of the transceiver keep the following in mind:

- Keep clear of metal environment.
- Hold the transceiver vertically and 5 cm from lips and push the PTT when transmitting.
- In receive mode carry the transceiver vertically with belt clips.
- To preserve battery power, adjust squelch to close the loudspeaker when there is no signal.
- If you are in a lifeboat keep the antenna as high as possible.

## Channels

This radio is not programmed with any channels for USA and Canada.

The user have to apply at the authorities for a licens.

For Europe this radio can be programmed according to the following tables:

Table 1: Single frequency simplex channels (25 kHz or 12.5 kHz use)

Channel designator	Frequency
Channel A	467.525 MHz
Channel B	467.550 MHz
Channel C	467.575 MHz
Channel D	457.525 MHz
Channel E	457.550 MHz
Channel F	457.575 MHz

Table 2: Additional channels for 12.5 kHz equipment

<b>Channel designator</b>	<b>Frequency</b>
Channel M	467.5375 MHz
Channel N	467.5625 MHz
Channel O	457.5375 MHz
Channel P	457.5625 MHz

Table 3: Two-frequency simplex channels for use with repeater only

<b>Channel designator</b>	<b>Repeater RX Frequency</b>	<b>Repeater TX Frequency</b>
Channel G	467.525 MHz	457.525 MHz
Channel H	467.550 MHz	457.550 MHz
Channel J	467.575 MHz	457.575 MHz
Channel K	467.5375 MHz	457.5375 MHz
Channel L	467.5625 MHz	457.5625 MHz



## Operation

### Controls





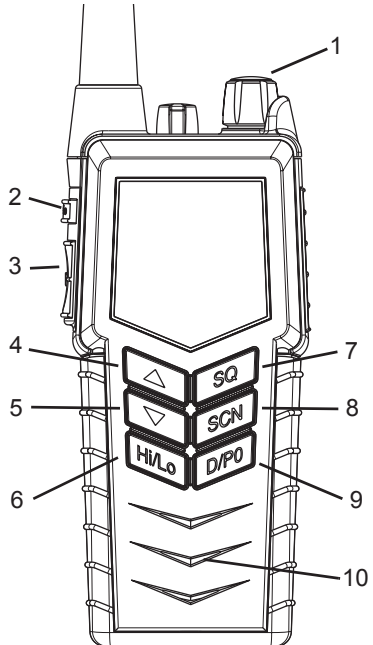

#### Keys and buttons

1. On/off/volume
2. Light/Lock
3. Push To Talk (PTT)
4. Up key
5. Down key
6. Hi/Lo output power
7. Squelch
8. Scan
9. D/P0 quick channel select
10. Loudspeaker/microphone



## Key presses

Pressing and holding certain keys gives access to additional functions, shown in the table below.

Key	Short press (1 beep)	Long press (2 beeps)	Extra long press (3 beeps)
 	<p>Show next available item in the list (up or down).</p> <p>Default: Channel selection</p>	<p>Run through available items, <b>or</b> select tagged channels P1 (▼) or P2 (▲).</p>	<p>Run through available items if an P1 or P2 channel is tagged</p>
	<p>Activate Squelch control (Adjust with up/down arrows).</p>	<p>Monitor function. Open Squelch completely. Set period of time in configuration mode.</p>	
	<p>1 press: Activate/terminate Dual watch.</p> <p>2 presses: Activate memory scan.</p>	<p>Add/Delete channel from memory scan.</p>	
	<p>Toggle between high and low transmitter power.</p>		
	<p>Select channel D.</p>	<p>Select preprogrammed channel P0.</p>	

## The display

The display holds various fields of information, explained below.

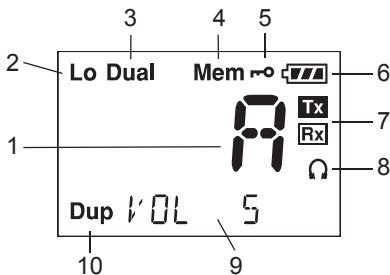

1. Current working channel.
2. “LO”: Reduced transmitter power.  
Full transmitter power is not shown in display.
3. Dual watch activated.
4. Current working channel is marked for scanning.
5. Keypad is locked.
6. Battery level indicator.
7. Transmitting (TX) /Receiving (RX).
8. Accessory is connected.
9. Service line for various purposes. In this example the volume level.
10. Semi-duplex channel.

## Using the UHF

### Basic functions

**Note** Before using the radio, mount the antenna at the top of the radio. The antenna is delivered with the radio.

#### *Switching the radio on and off*

- **To switch the radio on**, turn the knob at the top of the radio **clockwise**.  
The display lights up showing the last used channel and the battery level.
- **To switch the radio off**, Turn the knob back **counter-clockwise** until it clicks.



#### *Selecting the working channel*

- To select **channel D**, press the **D/P0** key.
- To select among **all available channels**, press ▲ or ▼ on the keypad. For fast selection, press and hold ▲ or ▼.

The display shows the currently selected channel. The bottom left corner of the display shows “Dup” if the channel is a semi-duplex channel.

**Note** Long press on ▲ or ▼ can also be used to select preferred channels. For information on how to program preferred channels, see *Configuring the radio* on page 17.



### Activating a call

To **activate a call** to the selected channel, press and hold the **PTT** button on the side of the radio.

The radio transmits as long as the PTT button is pressed. A small **Tx** sign next to the channel number indicates when the radio is in transmit mode.



### Adjusting the volume

- To **increase** the volume, turn the on/off knob at the top of the radio **clockwise**.
- To **decrease** the volume, turn the knob **counter-clockwise**.

The display shows the level of the volume, e.g. “VOL 5”, while it is adjusted.

### Using Squelch control

- To **activate** Squelch control, press the **SQ** key.
- To **set** the Squelch level, press ▲ (closing) or ▼ (opening). The display shows the Squelch level while it is adjusted, e.g. “SQ 5”.

### Adjusting the display backlight

- To **turn on** the backlight, press the **Light/Lock** button on the side of the radio.
- To **adjust** the backlight level, press ▲ or ▼ within 3 seconds after turning on the light. The display shows the level while it is adjusted, e.g. “DIM MED”.

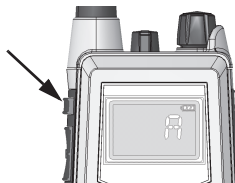

### ***Using Dual watch (requires priority channel is programmed)***

- **To activate** Dual watch, press the **SCN** key.  
The display shows “Dual” at the top and “D” at the bottom right. The radio toggles between the selected channel and channel D (if channel D is programmed as the priority channel).
- **To terminate** Dual watch, press **SCN** again.

### ***Scanning channels***

- **To activate** scanning memory, press 2 times **SCN** within 1/2 a second. During scanning, the display shows “SC” in the channel field. The radio toggles between channel D and each of the channels are marked for scanning (only if a priority channel, e.g. D was programmed).
- **To terminate** scanning, press **SCN** once.

### ***Changing the transmitter power***

**To change** the transmitter power, press the **Hi/Lo** key. The display shows “LO” when power is set to low. Otherwise maximum power is used.

### ***Locking the keypad***

- **To lock** the keypad, press and hold the **Light/Lock** button. The display shows a key symbol when the keypad is locked.
- **To unlock** the keypad, press and hold the **Light/Lock** button again.

---

## Other functions

### ***Programming the scanning memory***

**To add** a channel to the scanning memory, select the channel and then press and hold the **SCN** key until the display shows **MEM** at the top.

**To remove** a channel from the scanning memory, select the channel and then press and hold the **SCN** key until the **MEM** sign disappears from the display.

### ***Low power operation***

The radio can be operated in low power mode. In this mode battery life time is dramatically increased. Up to the first second of a received call might be lost if this mode is selected. Refer to *SLEEP* on page 18.

### ***Continuous Tone Coded Squelch System***

On channels where it is allowed, you can set up selective squelch opening by sub-tone detection (CTCSS), using the configuration mode (see *CTCSS* on page 21). Please note that if the radio is operating with CTCSS on a channel, it is impossible to receive a normal signal on that channel. For this reason, be very careful **not** to use CTCSS programmed channels in emergency situations. Channels programmed with CTCSS will have a clear identification in the service field, e.g. "CTCSS 22", while selected. Not all channels are allowed for CTCSS use.

For maritime channels CTCSS is automatically disabled when

- Product is turned off
- A new channel is selected

For private channels, the feature will remain until manually removed.

## **Scrambler**

On channels where it is allowed, you can set up voice scrambling, using configuration mode (see *SCRM* on page 22).

Please note that if the radio is operating with scrambling on a channel, it is impossible to communicate with other radios that are not programmed with the same scrambler code. For this reason, be very careful **not** to use scrambled channels in emergency situations. Scrambled channels will have a clear identification in the service field, e.g. "SCRM 3", while selected. Not all regions allow the use of voice scrambling.

For maritime channels scrambling is automatically disabled when

- Product is turned off
- A new channel is selected

For private channels, scrambling will remain until manually removed.

### **Note**

Prior to any initiation of scrambling, the operator must always identify the calling station in clear voice (unscrambled) on that channel. Use of scrambling may also be restricted by national laws.

## **Narrow band operation**

The radio is prepared for narrow band operation. (see *BAND* on page 22).

Narrow band configuration is indicated with an "n" next to the channel designator.

## Batteries

### Battery level indication

When the battery level is low, you should recharge the battery.

The radio display shows the battery status. When the battery symbol is empty and flashing, the battery should be recharged as soon as possible.

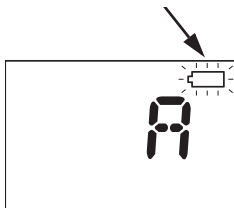

### Removing and inserting the battery pack

**To remove** the battery pack, do as follows:

1. Open the safety lock as shown.
2. Remove the battery.

**To insert** the battery pack, attach the battery and then close the safety lock.

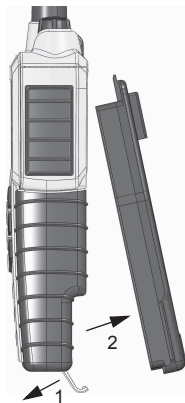

## The battery chargers

The chargers has two compartments.

### CH3507

- A rear compartment only for storing a spare battery. It does not have a charger function.
- A front compartment for recharging the battery alone or while attached to the radio.

### CH3508

- It is possible to charge a battery in rear compartment simultaneously with the radio/battery in front.

## Installing the charger

### *Mounting the charger*

There are several options for mounting one or more chargers on a table or a wall.

For information on dimensions and screw positions, refer to *Dimensional drawing, charger* on page 36.

When mounting the charger, make sure it is placed in a dry place and away from direct sunlight. The charger is not waterproof.

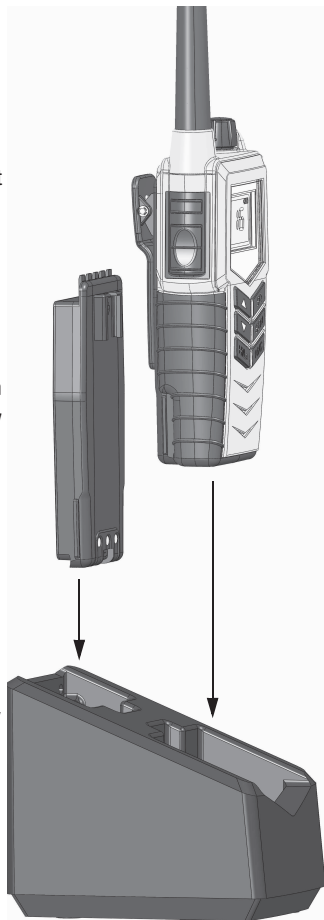

## Connecting to power

The charger can be supplied from DC or from AC using an AC/DC converter.

**DC:** Connect the 12-24VDC Connection Cable between the DC supply and the connector on the underside of the charger.

**AC:** Connect the AC/DC converter to the connector on the underside of the charger. Then connect the AC/DC converter to the AC outlet.

## Recharging the battery

To recharge the battery, place the radio<sup>1</sup> with battery or the battery alone in the front position of the charger cradle.

The light indicators on the charger cradle show the status as follows:

- Green light: Power is connected to the charger.
- Slow red flash: Charging in progress.
- Quick red flash (twice per second): Charging error, e.g. battery defect or temperature out of range.
- Steady red light: Charging completed. Trickle charge mode.

Charging time with empty battery: UHF off approx. 4 hours, UHF on: approx. 5 hours.

The battery indicator on the radio display indicates if the radio is placed in the charger while radio and charger are both powered.

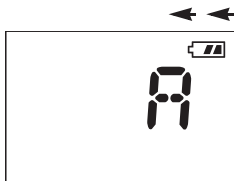

1. The radio may be left on or it may be switched off during the recharge process





## Configuring the radio

### Configuration mode

#### Entering and using configuration mode

**Note** | The radio is not operational in configuration mode.

- **To enter** configuration mode, press and hold the **Light/Lock** button while turning on the radio.  
The bottom line of the display shows the current menu item/setting.
- **To exit** configuration mode, turn off the radio or press any key except ▲, ▼ and the Light/Lock button.  
Using the PTT button or leaving the radio inactive for 10 seconds also causes the radio to exit configuration mode.
- **To change** a setting, press ▲ or ▼.
- **To confirm the current setting** and go to the next menu item, press the **Light/Lock** button.

## List of configuration settings

The following settings are available in configuration mode.

Name	Values	Description
LIGHT	MAN	Only <b>Light/Lock</b> button activates the backlight.
	KEY	All keys and buttons, except PTT and volume control, activate the backlight.
BEEP	MAX	Status click/beep sound on key press, long press (settings/programming saved) and battery alarm. Maximum level.
	MIN	Status click/beep sound on key press, long press (settings/programming saved) and battery alarm. Minimum level.
	OFF	All beeps off.
VER	X.XX.XX	Software version. Read-only.
BAT	X.XX	Battery voltage (V). Read-only.
TEMP	XX.X	Temperature (°C). Read-only.
SLEEP	ON	Enable sleep mode (to minimize power consumption).  Sleeps for periods of 1 second after 15 seconds of idle mode. Idle mode is: no signal detected and no operation of the radio.
	OFF	Disable sleep mode.

Name	Values	Description
CONTRST	1, 2, 3, 4, 5	Contrast. 1 = lowest and 5 = highest.
SHANG	OFF	Off. Resumes scanning when signal disappears.
	4, 6, 8, 10	Scan hang time (in seconds) on an active receiving working channel. The time is measured from signal detected - remains on channel even if signal disappears.
RESCN	OFF	Automatic resume deactivated.
	3, 6, 10, 15, 20, 25, 30	Scanning/watch can be automatically resumed after this time (seconds) if previously terminated with PTT.
SQ	TIME	A long press on SQ opens squelch. The squelch level resumes to setting 3 seconds after SQ is released.
	MAN	A long press on SQ opens squelch. The squelch level resumes to setting as soon SQ is released.
WORK	ON	If the default channel D is selected using the D/P0 key, any push on ▲ or ▼ will select the working channel active before D/P0 was pushed.
	OFF	If on a distress or call channel, any push on ▲ or ▼ will select the channel next to the displayed channel.

Name	Values	Description
P0	OFF	Remove tag “P0” for current working channel.
	ON	Tag current working channel with “P0”. If another channel was previously tagged “P0”, this is overruled. <ul style="list-style-type: none"> <li>• The working channel can now be selected with a long press on “D/P0”.</li> </ul>
P1	OFF	Remove tag “P1” for current working channel.
	ON	Tag current working channel with “P1”. If another channel was previously tagged “P1”, this is overruled. <ul style="list-style-type: none"> <li>• The working channel can now be selected with a long press on ▼.</li> </ul>
P2	OFF	Remove tag “B” for current working channel.
	ON	Tag current working channel with “P2”. If another channel was previously tagged “P2”, this is overruled. <ul style="list-style-type: none"> <li>• The working channel can now be selected with a long press on ▲.</li> </ul>

Name	Values	Description
SUBC	OFF	SUBC disabled. Squelch opens on all received signals.
	1, 2, ..., 38	<p>Sub-tone carrier ID.</p> <p>Squelch opens if the received signal contains the desired subtone. During transmission the sub-tone with the corresponding ID is generated.</p> <p>Two radios on the same channel and with the same sub-tone ID, can reduce unwanted incoming traffic from other users on the same channel.</p>
CTCSS	OFF	CTCSS disabled.
	ON	<p>Activate CTCSS on working channel. Two radios on the same channel and with SUBC enabled, can have a certain level of privacy.</p> <p>Note that if you choose this option, the radio immediately exits configuration mode and starts CTCSS on the working channel.</p>
GROUP	SEL	Selective Mode. Squelch opens only if the programmed sub-tone is received in the signal.
	ANY	Squelch opens on reception of any of the 38 sub-tones.

Name	Values	Description
SCODE	OFF	No scrambler code is assigned to the channel (selecting “ON” in the SCRM setting will have no effect).
	1, 2, 3, 4, 5, CC	A selection between 5 fixed sets of scrambler characteristics, and a custom code (CC), can be assigned to the channel.  Note that the custom code can be defined in the service interface.
SCRM	OFF	Scrambler disabled.
	ON	Activate scrambling on working channel. Two radios on the same channel and with scrambling enabled, can have a certain level of privacy.  Note that if you choose this option, the radio immediately exits configuration mode and starts scrambling on the working channel.
BAND	25.0	Wide band operation selected.
	12.5	Narrow band operation selected.

## Equipment and accessories

### External equipment

#### List of equipment

The following equipment can be connected to the radio:

- SAVOX 400E Push-To Talk unit
- SAVOX C500 Fist Mike
- SAVOX NC/400 Noise-com
- SAVOX HC-E Helmet-com
- SAVOX K53004 Helmet unit
- Peltor MT7H79 Headset

We recommend to remove all accessories during emergency use.

All accessories listed might be used when body worn.

#### Connecting external equipment

Connect the dedicated interface cable between the external equipment and the top connector on the radio.

Interface cable	Order number
For SAVOX 400E	403500-940
For SAVOX C500	403500-950
For Peltor FL5061	403500-951



When external equipment is connected to the radio, the right side of the display will show a headset.

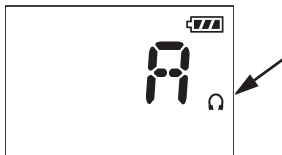

## Impact on radio operation

The external equipment can have a built-in PTT, speaker and microphone. Thus connecting it to the radio will have the following impact on the radio operation:

- If a microphone is built into the detected external equipment, the external equipment microphone is used, and the internal radio microphone is disabled.
- If a speaker or earpiece is built into the detected external equipment, the external equipment sound device is used, and the internal radio speaker is disabled.
- If a PTT or VOX is built into the detected external equipment, the external equipment PTT control is used, and the radio PTT button is disabled.

## Accessorie connector

- Pin 1. Loudspeaker,  
minimum 8 ohm impedance.
- Pin 2. Accessory power,  
5V maximum 0.03A.
- Pin 3. Microphone input,  
 $R_i = 2.2\text{kohm}$ , 3V phantom power.
- Pin 4. GND.

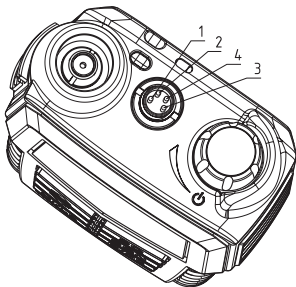



## Accessories

### List of accessories

The following accessories are delivered with your radio:

Accessory	Part number
Rechargeable battery, B3502	403502A
Charger, CH3507	403507A
AC/DC converter, length 150cm (100-240V~ /12VDC out)	88-125538
12-24VDC Connection cable, length 150cm	37-124381
Belt clip	62-124320
Antenna	88-125662
Lanyard	41-124375
SP3550 User Manual (this manual)	98-124308

**Batteries, charger, AC/DC Converter** and **12VDC Connection** are described in *Batteries* on page 13.

To mount the **antenna**, simply screw it into the threaded bush at the top of the radio.

Use of **lanyard** is only for hand held operation. Put it around the wrist to prevent dropping the radio.