



DT 750 DT 750 BLE



732.29.502 ZN 6.167.000.90b

Operating instructions - English.....2

Table of Contents

1. Special notes 3

1.1 Contents and target group type instructions 3

1.2 Obligations of the operator 3

1.3 Personnel qualifications 4

1.4 Exclusion of liability 5

2. Information about the product 5

2.1 Correct purpose of use 5

2.2 Incorrect purpose of use 6

2.3 Technical data 6

3. Safety 6

3.1 Safety notes and symbols in these instructions 6

3.2 Safety symbols 7

3.3 Environmental protection 8

3.4 Safety notes and dangers 8

4. Installation 9

5. Start-up 9

5.1 Initial start-up 9

6. Allocating locking authorizations 10

7. Clearing locking authorizations 11

7.1 Clearing the locking authorizations of individual keys 11

7.2 Procedure to follow if a user key is lost 11

8. Operation 11

8.1 Normal operation 11

8.2 Do not disturb function 11

9. Emergency opening 12

10. Troubleshooting 12

11. Cleaning / maintenance 12

11.1 Cleaning 12

11.2 Servicing / maintenance 13

732.29.502

HDE 01/2019

1. Special notes

1.1 Contents and target group type instructions

It is essential to pay attention to these operating instructions in order to operate the product successfully and safely. Please pay attention to all of the specified instructions and notes!

The operating instructions consist of two separate documents:

- **Operating instructions**
- **Installation and maintenance instructions**

The following groups must read and fully understand the specific instructions that are indicated on a per group listing on this bracket of instructions:

| Group types | Part of instructions to be read |
|---------------------------------------|---|
| Operator | Entire operating instructions Entire installation and maintenance instructions |
| Installation and start-up personnel | Entire operating instructions Entire installation and maintenance instructions |
| Personnel with locking authorizations | Chapter 6-9 of operating instructions |
| User | The operator must show the user how to operate the product safely and properly. |

1.2 Obligations of the operator

Operator is the person who operates the access control system for commercial or economic purposes or a allows a third party to use the access control system and thus bears the legal product responsibility for the protection of the user, the personnel, or third parties during operation.

Operator's obligations

The access control system is commonly used in the commercial sector. The operator of the access control system is therefore subject to statutory occupational safety obligations.

In addition to the safety notes in these instructions, safety, work safety, and environmental regulations valid for the area of application of the access control system must be followed.

Here, in particular:

- The operator must ensure that escape routes and emergency exit doors are accessible for all occupants in case of danger.
- The operator must be aware of the applicable occupational safety regulations and determine other hazards in a hazard assessment that may arise from the special working conditions at the place of use of the access control system. The safety regulations must be implemented for the operation of the access control system in the form of operating instructions.
- During the entire operating time of the access control system, the operator must verify that the operating instructions created correspond to the current state of the regulations and, if necessary, adapt them.
- The operator must clearly regulate and specify the responsibilities for installation, operation, troubleshooting, maintenance, and cleaning.
- The operator must ensure that all parties handling the access control system have read and fully understand these instructions. In addition, the operator must train their personnel at regular intervals and inform them about the risks.

Furthermore, the operator is responsible for ensuring that the access control system is always in perfect technical condition. The following therefore applies:

- The operator must ensure that the maintenance intervals specified in these instructions are followed.
- The operator must have all safety devices inspected regularly for function and completeness.

The operator has the following obligations:

- The operating instructions as well as the installation and maintenance instructions must always be readily available to all group types. Each group type must read the parts of the instructions that are relevant to them before using the product.
- Users of the locking systems that do not have access to the operating instructions (hotel guests, patients etc.) must be shown how to use the product properly by the operator.
- The instructions must be kept until the product is disposed of, and handed to the new operator in the event of a change of operator.
- Any abuse of the keys must be prevented.
- The programming and clearing keys must be kept in a safe place, since unauthorized persons can gain access to rooms with both keys.

1.3 Personnel qualifications

Essential requirements

Only those who are authorized as personnel can be expected to carry out their work reliably.

Persons whose ability to react is affected by, e.g., drugs, alcohol, or medication are not permitted to operate the system.

In the selection of personnel, observe appropriate training as well as the occupation-specific regulations applying at the place of use.

Installation and start-up personnel

Installation and initial start-up may only be carried out by trained experts. Knowledge of the following is a prerequisite:

- National accident prevention regulations
- National fire prevention regulations
- Expert electro-technical knowledge

If the installation and start-up personnel do not have these qualifications, a specialist installation company must be commissioned to do the work.

Persons who are under the influence of drugs, alcohol or medicines that affect reactions must not install or start up the equipment.

Personnel who are being trained may only install and start up the product under supervision or after being authorized to do so by someone with experience.

The operator and the installer are personally responsible for compliance with the VDE regulations (and the national electrotechnical and electronics regulations).

Operating personnel (personnel with locking authorization)

The operating personnel must be informed about the following:

- Safe and proper handling of the product
- The emergency opening facility
- Responsible use of locking authorization to rooms occupied by other persons

Service and maintenance personnel

Cleaning work on the product may be carried out by the operating personnel (after obtaining authorization from the operator).

The batteries must only be changed by trained experts that have been deployed by the owner. Other maintenance work is not permitted.

These instructions describe the qualifications listed below for the personnel for the various work areas:

Qualified electrician

Qualified electricians are capable of working on electrical systems and recognize potential hazards and avoid them due to their professional training, knowledge, experience as well as knowledge of pertinent standards and provisions.

Qualified electricians have been specifically trained for the working environment in which they operate and know the relevant standards and regulations.

Unauthorized persons**WARNING****Danger to life for unauthorized persons due to hazards in the danger zone and working area!**

Unauthorized persons who do not meet the requirements described herein will not be aware of the occupational hazards. Therefore, unauthorized persons are subject to risks of serious injury or death.

- Keep unauthorized persons away from the danger zone and working area.
- When in doubt, approach persons and have them clear the danger zone and working area.
- Interrupt the work until unauthorized persons have left the danger zone and working area.

1.4 Exclusion of liability

No liability is accepted for injuries or damage that is attributable to one or more of the following reasons:

- Failure to read and/or follow the instructions
- Abuse of the equipment
- Omission of the emergency opening facility
- Inadequately qualified/instructed personnel
- Failure to use original replacement parts
- Negligent handling of the product

2. Information about the product**2.1 Correct purpose of use**

The product is a batterie operated electronic door fitting for use in hotels, hospitals and other buildings with frequent changes of room occupant.

The operator must equip the relevant doors with a single profile cylinder for emergency opening in the event of faults or emergencies.

The product is intended for the following areas of application:

- Use on room doors inside buildings
- Use on doors that comply with the specified installation requirements (see chapter "**3. Installation requirements**" of the installation and maintenance instructions)

Correct purpose of use also includes adhering to the manufacturer's operating, service and maintenance conditions.

2.2 Incorrect purpose of use

Any use that is not mentioned in chapter 2.1 is considered to be improper. The operator is solely responsible for any resulting damage. It is particularly important to avoid the following:

- Use outdoors
- Use in potentially explosive or aggressive environments
- Use in damp environments
- Use in the vicinity of electromagnetically sensitive devices
- Omitting components during installation
- Changes to the installation order
- Use of defective or damaged components
- Use of non-original parts
- Use without emergency opening facility
- Modifications to the product
- Repairs to the product

2.3 Technical data

| | |
|--|---|
| Dimensions interior and exterior module | 22.5 mm x 70 mm x 265.5 mm |
| Voltage supply | 4x 1.5 V Mignon batteries AA (LR6) alkaline Type E91 Energizer industrial (Häfele Cat. No.: 910.54.980) |
| Temperature range | 0°C – +55°C |
| Humidity | 0 – 95%, not condensed |

3. Safety

3.1 Safety notes and symbols in these instructions

Safety notes

Safety notes in these instructions follow a uniform structure. They are introduced by a signal word that indicates the extent of the hazard. This is followed by the source of the danger and measures to avoid them.

The following risk levels are distinguished:

DANGER

This combination of symbol and signal word indicates an immediately dangerous situation causing death or serious injury if not avoided.

WARNING

This combination of symbol and signal word indicates a potentially dangerous situation that may cause death or serious injury if not avoided.

CAUTION

This combination of symbol and signal word indicates a potentially dangerous situation that may cause minor or light injury if not avoided.

NOTE

The note is used to point out dangerous situations which could lead to potential property damage/consequential damage to the product or damage to the environment. Notes are also used to provide important additional information.

Safety notes in handling indications

Safety notes may relate to certain individual handling indications. Such safety notes are incorporated into the handling indication as to not interrupt the flow of reading when carrying out the action. The signal words described above are used.

Examples



1. Loosen screws.
2. Mount cable.

| |
|--|
|  CAUTION |
| Risk of cables being trapped by the cover! |
| Watch the position of the cable. Close cover carefully. |

3. Tighten screws.

Special safety notes

To draw attention to special risks, the following symbols are used in the safety notes:

| Warning sign | Type of risk |
|--|---|
|  | Warning of dangerous electrical voltage |
|  | Warning of a hazardous area |



This symbol highlights useful tips and recommendations and information for efficient and problem-free operation.

Other markings

The following markings are used in these instructions to highlight action instructions, results, lists, references and other elements:

| | |
|---------------|--|
| 1.>, 2.>, 3.> | Step-by-step action instructions |
| ⇒ | Results of action steps |
| • | Lists without a defined order |
| [push button] | Controls (e.g. push buttons, switches), display elements (e.g. signal lamps) |
| “Display” | Screen elements (e.g. buttons, assignment of function keys) |

3.2 Safety symbols

The following stickers are located on one or more components of the access control system. They relate to the immediate environment of where they are located.

Crossed-out dustbin



This image indicates that the respective component must not be disposed of with residential waste.

3.3 Environmental protection

NOTE

Risk to the environment due to improper handling of environmentally hazardous substances!

Improper handling of environmentally hazardous substances, particularly improper disposal, can cause significant damage to the environment.

- Always follow the notes below for handling environmentally hazardous substances and their disposal.
- If environmentally hazardous substances are accidentally released into the environment, immediately take appropriate action. When in doubt, notify the appropriate local authority of the damage and check for appropriate measures to be taken.

The following environmentally hazardous substances are used:

Batteries

Batteries contain toxic heavy metals. They are subject to special waste treatment and must be handed into municipal collection points or disposed of by a specialist company.

Electric and electronic components

Electric and electronic components may contain toxic materials. These components must be collected separately and be deposited at municipal collection points or disposed of by a specialist company.

3.4 Safety notes and dangers

The product has been built in accordance with the latest state of technology and the recognized technical safety regulations. Nevertheless, danger to persons or damage to product or other property could occur during installation and use.

⚠ WARNING

Risk of fatality due to lack of emergency opening facility!

If the product is installed without an emergency opening facility, it may not be possible to open the door from the outside in the event of fault. If emergencies occur inside the room during the fault, rescue work will be hindered.

- > The operator must ensure that doors to which this product is fitted have an emergency opening facility in the event of faults.
- > Häfele is not liable for damage that is attributable to failure to install an emergency opening facility.

⚠ WARNING

Risk of fatality due to failures or faults in electromagnetically sensitive devices!

The electromagnetic radiation of the product can cause faults in sensitive parts (e.g. in medical equipment).

The functionality thereof will be adversely affected.

- > Do not place product close to electromagnetically sensitive devices.
- > Pay attention to the safety instructions for the electromagnetically sensitive devices.
- > If you have any doubts regarding compatibility, please contact the manufacturer.

WARNING**Danger in case of improper use!**

Improper use of the product can result in dangerous situations.

- > Never use the product in potentially explosive areas.
- > Never use the product under any other than the approved ambient conditions.

NOTE**Damage to product due to damaged wires!**

Damaged wires affect the functionality of the product.

- > Do not trap or damage wires during installation.
- > Never start up and use the product if any wires have been damaged.

4. Installation

The installation and maintenance instructions are a separate document and are enclosed with the product. They are exclusively intended for:

- The **operator**
- The **installation and start-up personnel**

5. Start-up

The product is supplied in so-called simple mode for stand-alone operation (SA). These instructions only describe how to start up in this mode.

- Details of use of the product with software applications can be found in the relevant software documentation.
- The “Stand-Alone” mode will be permanently shut off once the product is configured for the first time using the Dialock MDU. After that, reactivating this mode is only possible after a reset.

5.1 Initial start-up

The work operations only need to be carried out once during initial start-up.

NOTE**Malfunction due to outdated Dialock firmware.**

To ensure that the current Dialock firmware is running on the terminal, the device has to be flashed (programmed) using the mobile programming unit (MDU) during start-up. In case of questions concerning the firmware version or the procedure please contact Häfele.

The individual work operations must be carried out within a short time window. Therefore:

- First study every work operation and have the keys that are needed at the ready before commencing with initial start-up.
- Perform the work operations quickly and without interruptions.

For safety reasons, the initial start-up can only take place within 5 seconds after the battery was inserted.

If this time window is missed, the initial start-up can be started again by removing the battery and inserting it again.



For step-by-step instructions “Start-up” see illustrations starting on page 14.

6. Allocating locking authorizations

NOTE

Warning of abuse!

Unauthorized persons can gain access to rooms using the programming and clearing keys.

- > Only personnel who are authorized by the operator may allocate locking authorizations!
- > Take care when allocating locking authorizations to avoid overlapping or mistakes.
- > Keep programming and clearing keys in a safe place and protect from abuse.

Locking authorizations for user keys can be allocated in 3 different categories:

- **Normal user keys**

All doors to which the user key has locking authorization can be opened with these user keys. The locks lock again automatically after 3 seconds. Doors with the “Do not disturb” function activated cannot be opened.



For step-by-step instructions “Allocating locking authorizations - normal user keys” see illustrations starting on page 15.

- **Privileged user keys**

Privileged user keys have the same rights as normal user keys, but can also open doors with the “Do not disturb” function activated.



For step-by-step instructions “Allocating locking authorizations - privileged user keys” see illustrations starting on page 16.

- **User keys with toggle lock function**

User keys with the toggle lock function have the same rights as normal user keys, but can set doors to permanently open. Presenting any valid user key locks the lock.



For step-by-step instructions “Allocating locking authorizations - user keys toggle lock function” see illustrations starting on page 17.

NOTE

The “Do not disturb” function must be activated using the software configuration with the “MDU 110”.

7. Clearing locking authorizations

7.1 Clearing the locking authorizations of individual keys



For step-by-step instructions “*Clearing locking authorizations - individual key, normal key, privileged key or key with toggle lock function*” see illustrations starting on page 18.

7.2 Procedure to follow if a user key is lost

If a user key was lost, all user keys must be cleared at the affected door terminals.



For step-by-step instructions “*Clearing locking authorizations - all user keys (normal keys, privileged keys and keys with toggle lock function)*” see illustrations starting on page 19.

Then locking authorizations must be allocated to all of the required user keys again.



See chapter “6. Allocating locking authorizations” starting on page 10.

8. Operation

8.1 Normal operation

From the inside:

- Open door using lever handle.
The door can be opened from the inside at any time using the lever handle.

From the outside:

- An authorized user key is needed to open the door from the outside.



For step-by-step instructions “*Operation*” see illustrations starting on page 20.

BLE = Bluetooth Low Energy

Products that are equipped with BLE can also be operated via smartphone (Android/IOS) with a suitable app. In case of questions concerning smartphone applications please contact Häfele.

8.2 Do not disturb function

The “Do not disturb” function is used as follows:

- The guest turns the thumbturn on the inside of the fitting anticlockwise to 90° as far as it will go.
- The do not disturb function has been activated.
- The door can be opened from the inside by pushing the lever handle.
- If personnel with normal user keys attempt to open the door from the outside, the LED flashes three times in white. The door cannot be opened.
- If personnel with privileged user keys attempt to open the door from the outside, the LED flashes three times in white. The door can be opened in spite of this by holding the key until the flashing stops.

NOTE

The “Do not disturb” function must be activated using the software configuration with the “MDU 110”.

9. Emergency opening

In the event of power failures or malfunctions, emergency opening can take place via the single profile cylinder. This activity is logged in the event log. The locking cylinder may only be used for emergency opening!

NOTE

The product may be damaged if the single profile cylinder is used incorrectly!

- > Do not use the single profile cylinder for normal door locking / unlocking.
- > Keep key for single profile cylinder in a safe place.



For step-by-step instructions “Emergency opening” see illustrations starting on page 21.

10. Troubleshooting

| If an attempt is made to open a door with a user key | |
|--|---|
| Acoustic signal is heard twice. | User key is not authorized. |
| LEDs do not change from red to white. | Hold user key closer to control panel. or User key is not authorized. |
| LED flashes three times in white. | The guest has activated the do not disturb function. |
| When the electronics are activated (by presenting a key) | |
| Red and white LED flash three times alternately. | Low battery charge. Replace batteries. |

732.29.502

11. Cleaning / maintenance

11.1 Cleaning

NOTE

Damage to product due to incorrect cleaning!

- > Do not use cleaners containing alcohol, organic solvents or thinners.
- > Do not use abrasive materials.
- > Do not use pressure or steam cleaning devices.

If necessary, clean outer surfaces of product choosing one of the following options:

- Cleaning with a dry, soft cotton cloth
- Cleaning with a damp cloth and a little washing-up liquid or neutral cleaner

HDE 01/2019

11.2 Servicing / maintenance

The product is maintenance-free apart from having to change the batteries.

NOTE

Damage to product due to incorrect maintenance!

- > Do not use lubricants.
- > Do not carry out repairs.
- > Contact the manufacturer in the event of damage / malfunctions.
- > If parts have to be replaced, always use original spare parts from Häfele.

Battery change

If the battery charge is low, the red and white LED flash alternately three times when the electronics are switched on by presenting a key.

NOTE

Malfunction due to low battery charge!

Problem-free operation is only ensured if adequately charged batteries are used.

- > Replace weak batteries immediately as soon as the signal occurs!
- > Only use new AA (LR6) batteries of the following type:
4x 1.5 V Mignon batteries AA (LR6) alkaline
Type E91 Energizer industrial
(Häfele Cat. No.: 910.54.980)
- > Always replace all four batteries.
- > The use of rechargeable battery packs is not permitted.

NOTE

Please pay attention to the following when using lithium batteries:

The type-specific discharge behaviour of lithium batteries (considerable voltage drop at the end of the life time) may cause that a low battery is indicated at the terminal only for a short period or not at all.

This may cause a short-term malfunction of the terminal.

The clock continues to run for up to 5 minutes without batteries. In spite of this, the time should be checked and set if necessary using the "MDU 110" after a battery change.

The locking authorizations for the user keys are also retained after a battery change and do not have to be reset.



For step-by-step instructions "**Battery change**" see illustrations starting on page 22.

NOTE



- > Do not throw batteries in the residential waste!
- > Dispose of batteries in an environmentally friendly way, e.g. using a municipal collection point.

Start-up

|  |  Programming key |  Clearing key |
|---|---|--|
|  | <p>(1) Insert batteries (see p. 22), acoustic signal is heard. (2) White LED flashes for max. 5 sec. (3) Present programming key, acoustic signal is heard.</p> | |
|  | <p>(4) Remove programming key. (5) Red LED flashes for max. 5 sec.</p> | |
|  | <p>(6) Present erasing key within 5 sec. (7) Acoustic signal is heard. The white LED flashes briefly. System is in operation.</p> | |

732.29.502

HDE 01/2019

Allocating locking authorizations - normal user keys

Programming key

User key

1

(1) Present programming key.
 (2) Acoustic signal is heard. White LED flashes for max. 5 sec.

5 s

3

(3) Present user key within 5 sec.
 (4) Acoustic signal is heard. The white LED flashes briefly. Locking authorization has been allocated. White LED continues to flash for max. 5 sec.

5 s

5

(5) Present another user key within 5 sec.

732.29.502

HDE 01/2019

Allocating locking authorizations - privileged user keys





Programming key

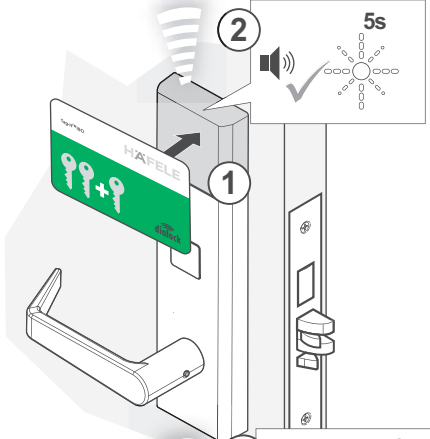
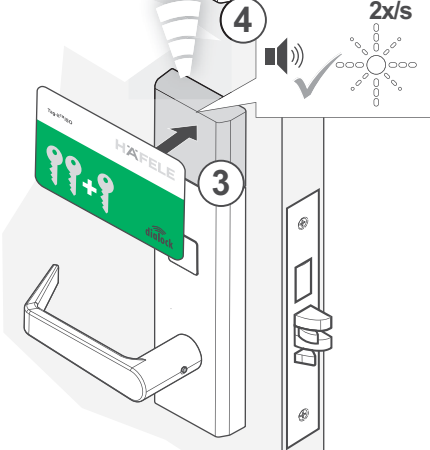
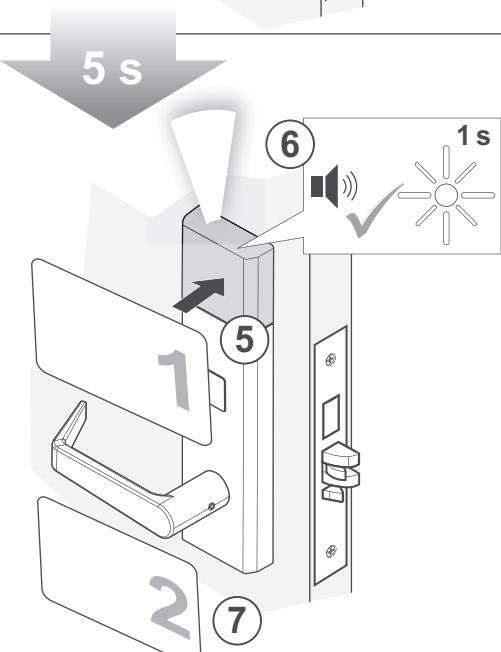

User key

(1) Present programming key.
 (2) Acoustic signal is heard. White LED flashes for max. 5 sec.

(3) Present programming key again.
 (4) Double acoustic signal is heard. White LED flashes 2x/sec.

(5) Present user key within 5 sec.
 (6) Acoustic signal is heard. The white LED flashes briefly. Locking authorization has been allocated. White LED continues to flash 2x/sec.

(7) Present another user key within 5 sec.

732.29.502

HDE 01/2019

Allocating locking authorizations - user keys toggle lock function

Programming key

User key

1

(1) Present programming key.

2

(2) Acoustic signal is heard. White LED flashes for max. 5 sec.

3

(3) Present programming key again.

4

(4) Double acoustic signal is heard. White LED flashes 2x/sec.

5

(5) Present programming key again.

6

(6) Double acoustic signal is heard, white LED flashes 1x/sec.

7

(7) Present user key within 5 sec.

8

(8) Acoustic signal is heard. The white LED flashes briefly. Locking authorization has been allocated. White LED continues to flash 1x/sec.

9

(9) Present another user key within 5 sec.

732.29.502

HDE 01/2019



Clearing locking authorizations - individual key, normal key, privileged key or key with toggle lock function

Clearing key

User key

(1) Present erasing key.
(2) Acoustic signal is heard. Red LED flashes for max. 5 sec.

(3) Present user key within 5 sec.
(4) Acoustic signal is heard. The red LED flashes briefly. Locking authorization has been cleared.

732.29.502

HDE 01/2019

Clearing locking authorizations - all user keys (normal keys, privileged keys and keys with toggle lock function)



Clearing key



Programming key

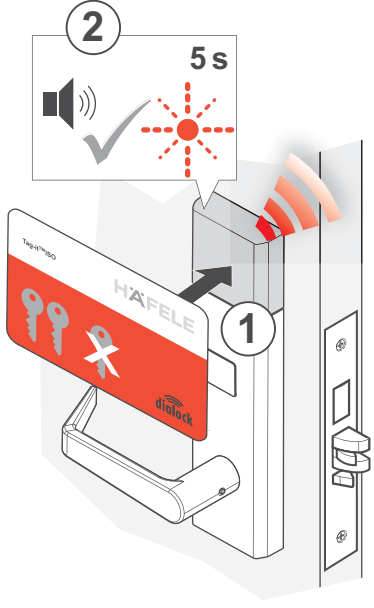

5 s

(1) Present erasing key.
 (2) Acoustic signal is heard. Red LED flashes for max. 5 sec.

↓

5 s

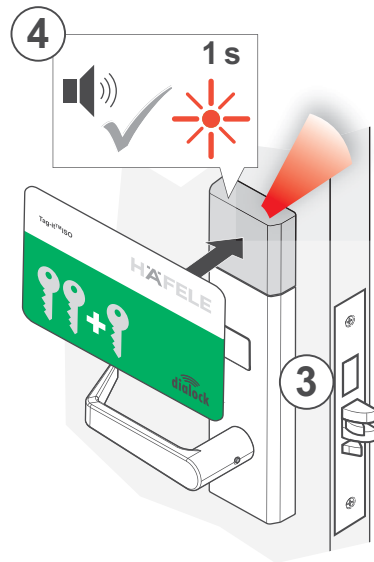

1 s

(3) Present programming key within 5 sec.
 (4) Acoustic signal is heard. The red LED flashes briefly.
 Locking authorizations for all user keys have been cleared.

732.29.502

HDE 01/2019

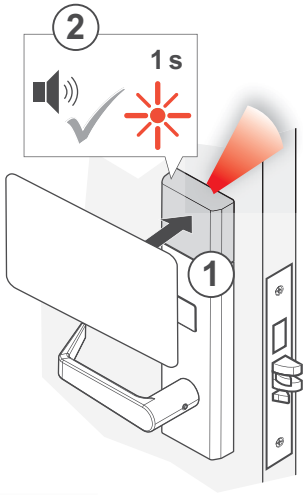
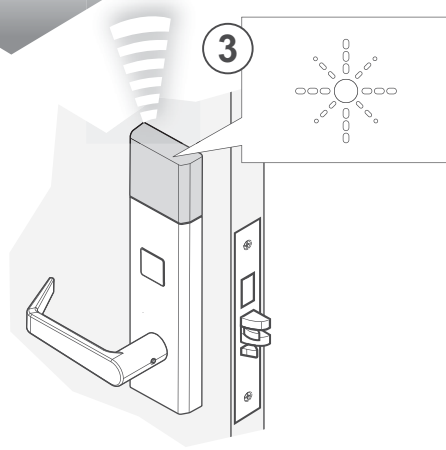
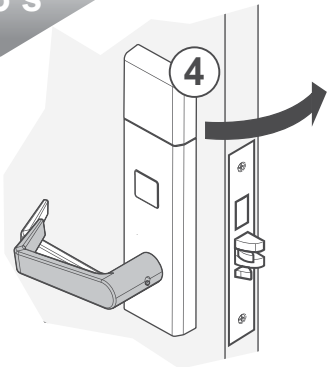

Operation

| | |
|---|---|
| |  User key |
|  | <p>(1) Present user key. (2) The red LED flashes briefly. Acoustic signal is heard.</p> |
|  | <p>(3) The white LED flashes.</p> |
|  | <p>(4) Door is ready for opening for approx. 3 sec.</p> |

732.29.502

HDE 01/2019

Emergency opening

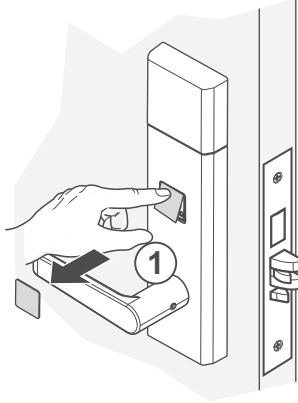

With activated DND function (see 8.2), the deadbolt is extended:

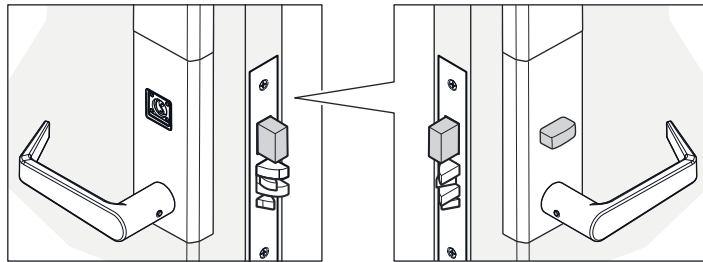

(1) Remove cover.

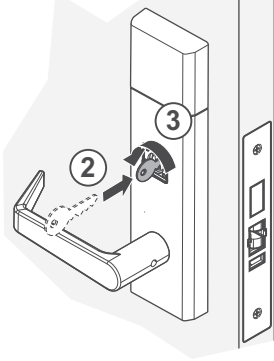

(2) Insert suitable key into locking cylinder.
 (3) Turn key in opening direction until the door is unlocked.

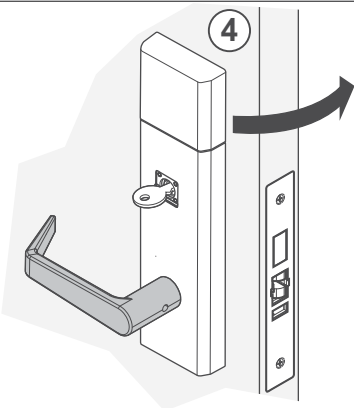

(4) Open door with lever handle.

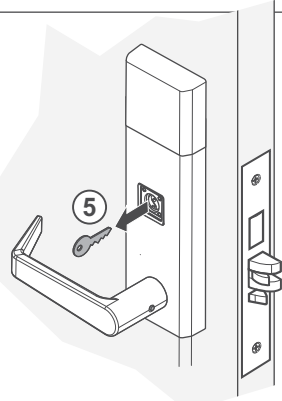

(5) Key must be removed after emergency opening!

732.29.502

HDE 01/2019

Battery change

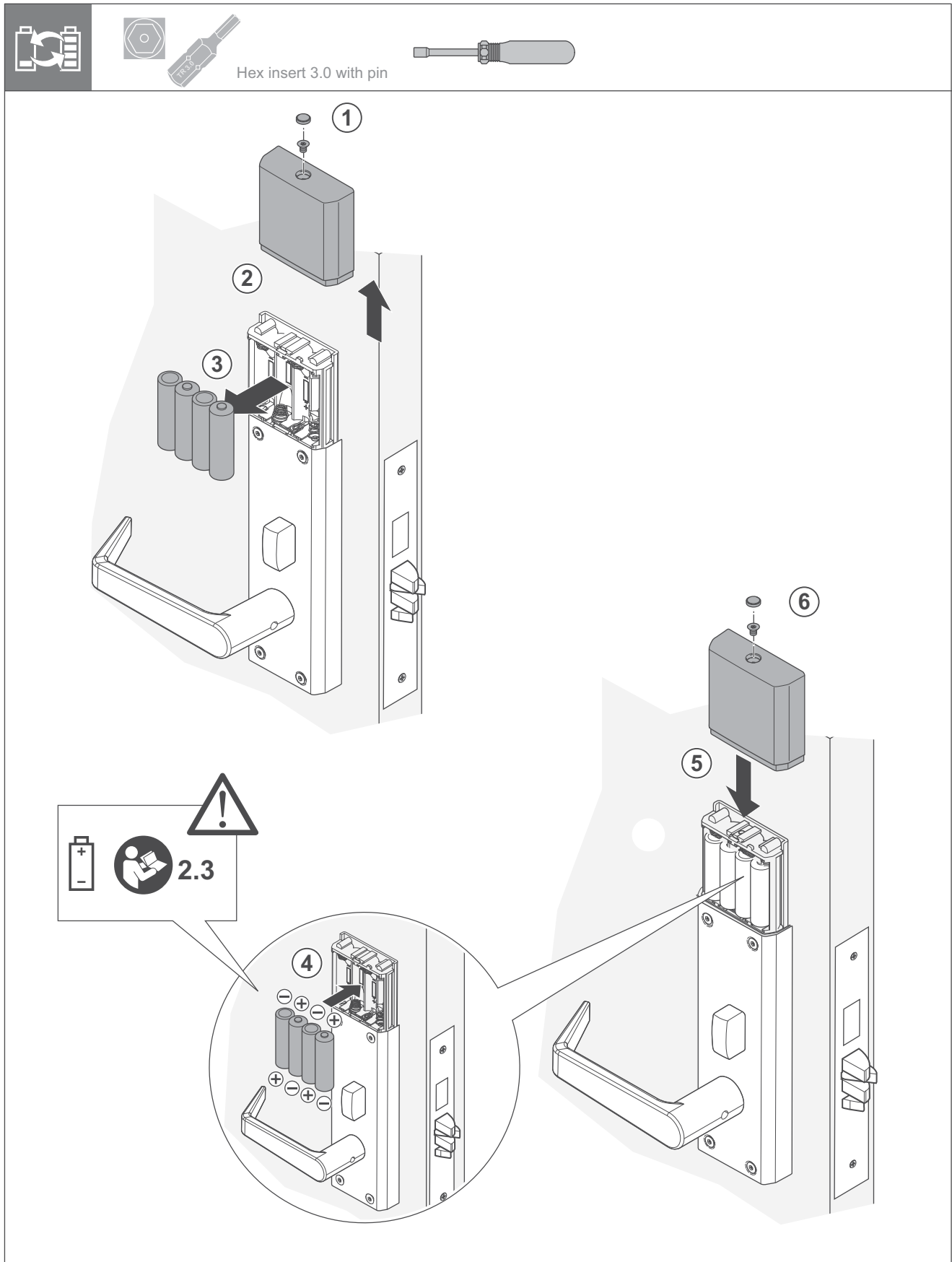

732.29.502

HDE 01/2019

732.29.502

HDE 01/2019

Copyright

All rights reserved. The texts, images and graphics in this document are subject to copyright and other protection laws. Reproduction, even in part, as well as imitation of the design are prohibited.

Exclusion of liability

Häfele GmbH & Co KG compiles the contents of this document with the utmost care and ensures that they are updated regularly. Häfele GmbH & Co KG does not accept any liability for the up-to-dateness, correctness or completeness of the information on these pages.

Häfele GmbH & Co KG
Adolf-Häfele-Str. 1
D-72202 Nagold
Germany

Tel.: +49 (0)74 52 / 95 - 0
Fax: +49 (0)74 52 / 95 - 2 00
E-mail: info@haefele.de

Subsidiaries of Häfele:

<https://www.hafele.com/com/en/info/locations/9749/>