

Dynamic Frequency Selection (DFS)

Test Report

Product Name : 802.11a/b/g/n WLAN Module

Model No. : 95.0209T02

FCC ID : TC2N1101

Applicant : RoKu

Address : 12980 Saratoga Avenue, Suite D, Saratoga, CA
95070 USA

Date of Receipt : 2009/09/17

Issued Date : 2009/11/10

Report No. : 099S059R-DFS-US-P08V01

Report Version : V1.0

The test results relate only to the samples tested.

The test report shall not be reproduced except in full without the written approval of Quietek Corporation.

This report must not be used to claim product endorsement by NVLAP any agency of the U.S. Government

DFS Test Report

Issued Date: 2009.11.10

Report No.: 099S059R-DFS-US-P08V01



Product Name : 802.11a/b/g/n WLAN Module

Applicant : Roku

Address : 12980 Saratoga Avenue, Suite D, Saratoga, CA 95070 USA

Manufacturer : Foxconn

Address : No 1925 , Nanle road, Songjiang Export Processing Zone ,
Shanghai , China 201613

Model No. : 95.0209T02

FCC ID : TC2N1101

EUT Voltage : DC 3.3V

Trade Name : Roku

Applicable Standard : FCC CFR Title 47 Part 15 Subpart E: 2008 – DFS
FCC-06-96A1 DFS Test Method

Test Result : Complied

Performed Location : SuZhou EMC laboratory
No.99 Hongye Rd., Suzhou Industrial Park Loufeng Hi-Tech
Development Zone., SuZhou, China
TEL: +86-512-6251-5088 / FAX: +86-512-6251-5098
FCC Registration Number: 800392

Documented By : Alice Ni
(Engineering ADM: Alice Ni)



Reviewed By : Marlin Chen
(Engineering Supervisor: Marlin Chen)

Approved By : Dream Cao
(Engineering Manager: Dream Cao)



TABLE OF CONTENTS

Description	Page
1. GENERAL INFORMATION	4
1.1. EUT Description	4
1.2. Standard Requirement	5
1.3. UNII Device Description	5
1.4. Test Equipment.....	6
1.5. Test Setup	6
1.6. Limits	7
1.7. Radar Waveform Calibration.....	10
1.8. Radar Waveform Calibration Result	11
2. Channel Move Time and Channel Closing Transmission Time.....	14
2.1. Test Procedure	14
2.2. Test Requirement	14
2.3. Uncertainty	14
2.4. Test Result of Channel Move Time and Channel Closing Transmission Time.....	15
3. Non-Occupancy Period	23
3.1. Test Procedur.....	23
3.2. Test Requirement	23
3.3. Uncertainty	23
4. Test Result of Non-Occupancy Period	24

1. GENERAL INFORMATION

1.1. EUT Description

Product Name	802.11a/b/g/n WLAN Module
Trade Name	Roku
FCC ID.	TC2N1101
Model No.	95.0209T02
DFS Frequency Range	5250-5350MHz, 5470-5725MHz
Number of Channels	802.11a/n-20MHz : 15 ; 802.11n-40MHz: 9
Data Rate	802.11a/n-20MHz: 6 - 135Mbps ; 802.11n-40MHz: up 270Mbps
Channel Control	Auto
Type of Modulation	802.11a/n: OFDM BPSK, QPSK, 16QAM, 64QAM
Antenna type	PIFA (Fixed)
Peak Antenna Gain	5.2dBi

Statement:

Information regarding the parameters of the detected Radar Waveforms is not available to the end user.

802.11a/n-20MHz Center Working Frequency of Each Channel:

Channel	Frequency	Channel	Frequency	Channel	Frequency	Channel	Frequency
Channel 52:	5260 MHz	Channel 56:	5280 MHz	Channel 60:	5300 MHz	Channel 64:	5320 MHz
Channel 100:	5500 MHz	Channel 104:	5520 MHz	Channel 108:	5540 MHz	Channel 112:	5560 MHz
Channel 116:	5580 MHz	Channel 120:	5600 MHz	Channel 124:	5620 MHz	Channel 128:	5640 MHz
Channel 132:	5660 MHz	Channel 136:	5680 MHz	Channel 140:	5700 MHz	N/A	N/A

802.11n-40MHz Center Working Frequency of Each Channel:

Channel	Frequency	Channel	Frequency	Channel	Frequency	Channel	Frequency
Channel 38:	5190 MHz	Channel 46:	5230 MHz	Channel 54:	5270 MHz	Channel 62:	5310 MHz
Channel 102:	5510 MHz	Channel 110:	5550 MHz	Channel 118:	5590 MHz	Channel 126:	5630 MHz
Channel 134:	5670 MHz						

Test Mode	Mode 1: Transmitter (802.11n-20BW) Mode 2: Transmitter (802.11n-40BW)
-----------	--

1.2. Standard Requirement

FCC Part 15.407:

U-NII devices operating in the 5.25-5.35 GHz band and the 5.47-5.725 GHz band shall employ a TPC mechanism. The U-NII device is required to have the capability to operate at least 6 dB below the mean EIRP value of 30dBm. A TPC mechanism is not required for systems with an E.I.R.P. of less than 500mW.

1.3. UNII Device Description

The UUT operates in the following band:

1. 5250-5350 MHz
2. 5470-5725 MHz

The UUT is a Client Device that does not have radar detection capability and ad-hoc function. The highest gain antenna assembly utilized with the EUT has a maximum gain of 5.2dBi in 5GHz frequency band. The 50-ohm Tx/Rx antenna port is connected to the test system to perform conducted tests. TPC is not required since the maximum EIRP is less than 500mW (27dBm).

The UUT utilizes 802.11a/b/g/n IP based architecture. Two nominal channel bandwidths, 20 MHz and 40MHz are implemented.

WLAN traffic is generated by streaming the video file "TestFile.mp2" from the Master device to the Slave device in full motion video mode using the "Nero Show Time 3" with the V3.0.1.3 Codec package.

The master device is a NETGEAR 802.11a/b/g/n Access Point. The NETGEAR Access Point FCC ID: PY308100078.

The UUT is a client device without radar detection therefore the interference threshold level is not required.

Statement: Information regarding the parameters of the detected Radar Waveforms is not available to the end user.

1.4. Test Equipment

Dynamic Frequency Selection (DFS) / AC-6

Instrument	Manufacturer	Type No.	Serial No	Cal. Date
Signal Analyzer	Agilent	N9010A	MY48030495	Apr, 23, 2009
Vector Signal Generator	Agilent	E4438C	MY49070137	Apr, 02, 2009

Instrument	Manufacturer	Type No.	Serial No
Splitter/Combiner (Qty: 2)	Mini-Circuits	ZFRSC-123-S+	SN331000910
ATT (Qty: 2)	Mini-Circuits	15542	30912
ATT (Qty: 2)	Mini-Circuits	15542	30909
Access Point	NETGEAR	WNDR3300	1SL2827U04C78
Notebook PC	Dell	M65	20503381024
Notebook PC	HP	HP541	CNU8476RVZ
RF Cable (Qty: 4)	GORE	C86	N/A

Software	Manufacturer	Function
Agilent Signal Studio for Pulse Building V1.3.13.0	Agilent	Radar Signal Generation Software
Agilent DFS_TEST V1.0.0.73	Agilent	Radar Signal Generation Software
Nero Show Time 3	Nero	Multimedia Player

1.5. Test Setup

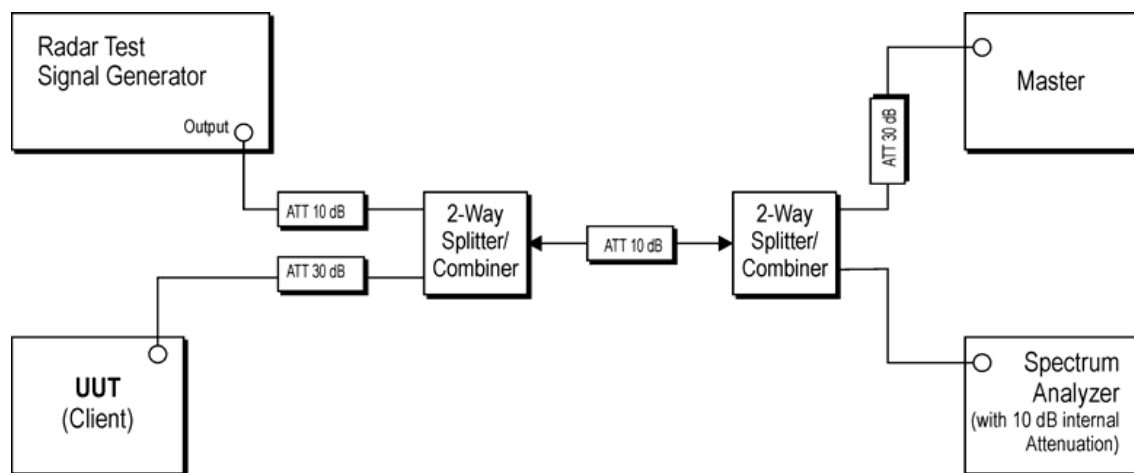

1.6. Limits

According to §15.407(h) and FCC 06-96 APPENDIX “COMPLIANCE MEASUREMENT PROCEDURES FOR UNLICENSED NATIONAL INFORMATION INFRASTRUCTURE DEVICES OPERATING IN THE 5250-5350 MHz AND 5470-5725MHz BANDS INCORPORATING DYNAMIC FREQUENCY SELECTION”.

Applicability of DFS requirements prior to use of a channel

Requirement	Operational Mode		
	Master	Client (with radar detection)	Client (without radar detection)
Non-Occupancy Period	Yes	Yes	Yes
DFS Detection Threshold	Yes	Yes	Not Required
Channel Availability Check Time	Yes	Not Required	Not Required
Uniform Spreading	Yes	Not Required	Not Required
U-NII Detection Bandwidth	Yes	Yes	Not Required

Applicability of DFS requirements during normal operation

Requirement	Operational Mode		
	Master	Client (with radar detection)	Client (without radar detection)
DFS Detection Threshold	Yes	Yes	Not Required
Channel Closing Transmission Time	Yes	Yes	Yes
Channel Move Time	Yes	Yes	Yes
U-NII Detection Bandwidth	Yes	Yes	Not required

Interference Threshold value, Master or Client incorporating In-Service Monitoring

Maximum Transmit Power	Value (see note)
≥ 200 milliwatt	-64 dBm
< 200 milliwatt	-62 dBm

Note 1: This is the level at the input of the receiver assuming a 0 dBi receive antenna.

Note 2: Throughout these test procedures an additional 1 dB has been added to the amplitude of the test transmission waveforms to account for variations in measurement equipment. This will ensure that the test signal is at or above the detection threshold level to trigger a DFS response.

DFS Response requirement values

Parameter	Value
Non-Occupancy Period	30 Minutes
Channel Availability Check Time	60 Seconds
Channel Move Time	10 Seconds
Channel Closing Transmission Time	200 milliseconds + approx. 60 milliseconds over remaining 10 seconds period (See Notes 1 and 2)

Note1: The instant that the Channel Move Time and the Channel Closing Transmission Time begins is as follows:

For the short pulse radar test signals this instant is the end of the burst.

For the frequency hopping radar test signal, this instant is the end of the last radar burst generated

For the long pulse radar test signal this instant is the end of the 12 seconds period defining the radar transmission.

Note 2: The channel closing transmission time is comprised of 200 milliseconds starting at the beginning of the channel move time plus any additional intermittent control signals required facilitating channel changes (an aggregate of approximately 60 milliseconds) during the remainder of the 10 seconds period. The aggregate duration of control signals will not count quiet periods in between transmissions.

Short Pulse Radar Test Waveforms

Radar Type	Pulse Width (μsec)	PRI (μsec)	Pulses	Minimum Percentage of Successful Detection	Minimum Trials
1	1	1428	18	60%	30
2	1-5	150-230	23-29	60%	30
3	6-10	200-500	16-18	60%	30
4	11-20	200-500	12-16	60%	30
Aggregate (radar types 1-4)				80%	120

A minimum of 30 unique waveforms is required for each of the short pulse radar type 2 through 4. For short pulse radar type 1, then same waveform is used a minimum of 30 times. If more than 30 waveforms are used for short pulse radar type 2 through 4, then each additional waveform must also be unique and not repeated from the previous waveforms. The aggregate is the average of the percentage of successful detections of short pulse radar type 1-4.

Long Pulse Radar Test Signal

Radar Waveform	Bursts	Pulses Per Burst	Pulse Width (μsec)	Chirp Width (MHz)	PRI (μsec)	Minimum Percentage of Successful Detection	Minimum Trials
5	8-20	1-3	50-100	5-20	1000-2000	80%	30

The parameters for this waveform are randomly chosen. Thirty unique waveforms are required for the long pulse radar test signal. If more than 30 waveforms are used for the long pulse radar test signal, then each additional waveform must also be unique and not repeated from the previous waveforms.

Frequency Hopping Radar Test Signal

Radar Waveform	Pulse Width (μsec)	PRI (μsec)	Hopping Sequence Length (msec)	Pulses Per Hop	Hopping Rate (kHz)	Minimum Percentage of Successful Detection	Minimum Trials
6	1	333	300	9	.333	70%	30

For the frequency hopping radar type, the same burst parameters are used for each waveform. The hopping sequence is different for each waveform and a 100-length segment is selected from the hopping sequence.

1.7. Radar Waveform Calibration

The following equipment setup was used to calibrate the conducted radar waveform. A spectrum analyzer was used to establish the test signal level for each radar type. During this process there were replace 50ohm terminal from master and client device and no transmissions by either the master or client device. The spectrum analyzer was switched to the zero span (time domain) at the frequency of the radar waveform generator. Peak detection was utilized. The spectrum analyzer resolution bandwidth (RBW) and video bandwidth (VBW) were set to 3MHz and 3 MHz.

The signal generator amplitude was set so that the power level measured at the spectrum analyzer was -61dBm due to the interference threshold level is not required.

Conducted Calibration Setup

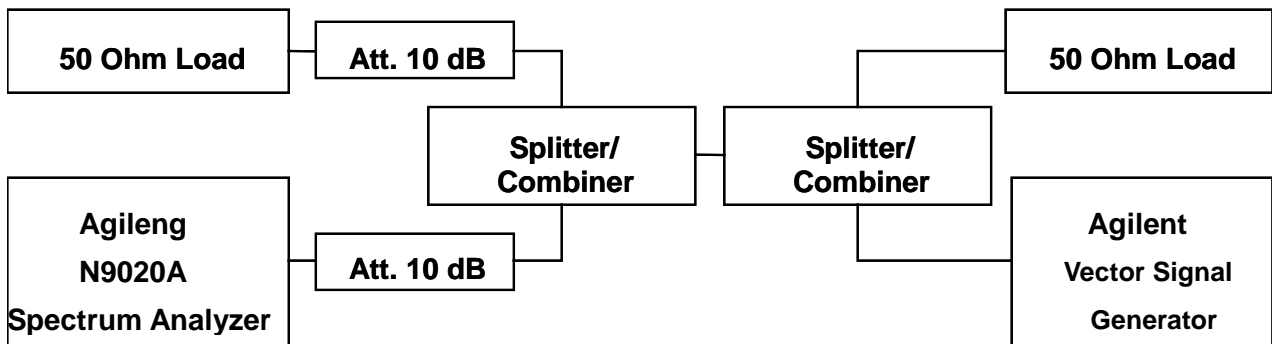

1.8. Radar Waveform Calibration Result

Radar Type 1 Calibration Plot at 5300MHz

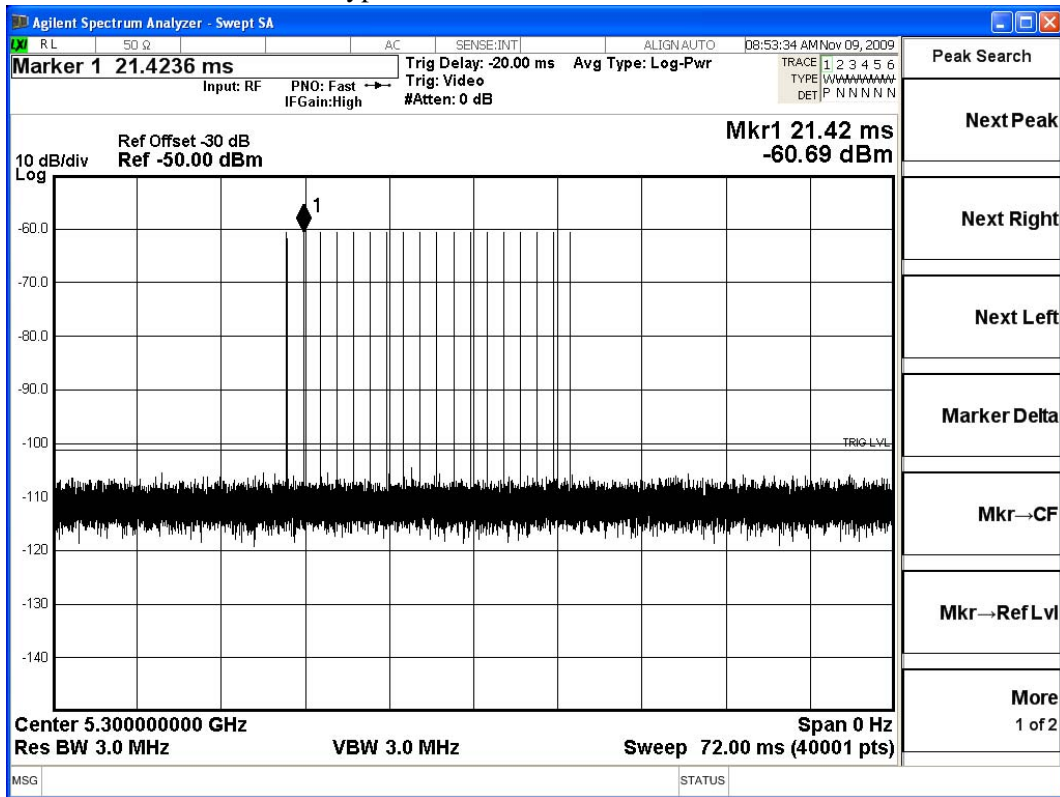

Radar Type 1 Calibration Plot 5500MHz

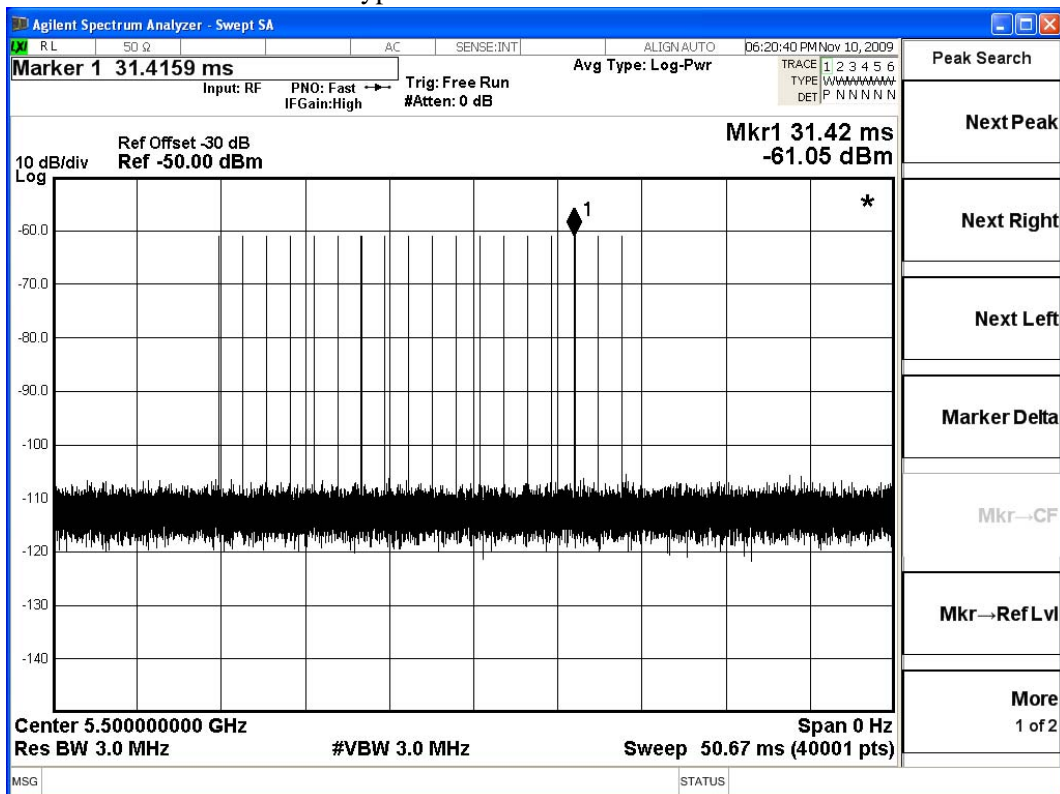

Plot of WLAN Traffic at 5300MHz-n20

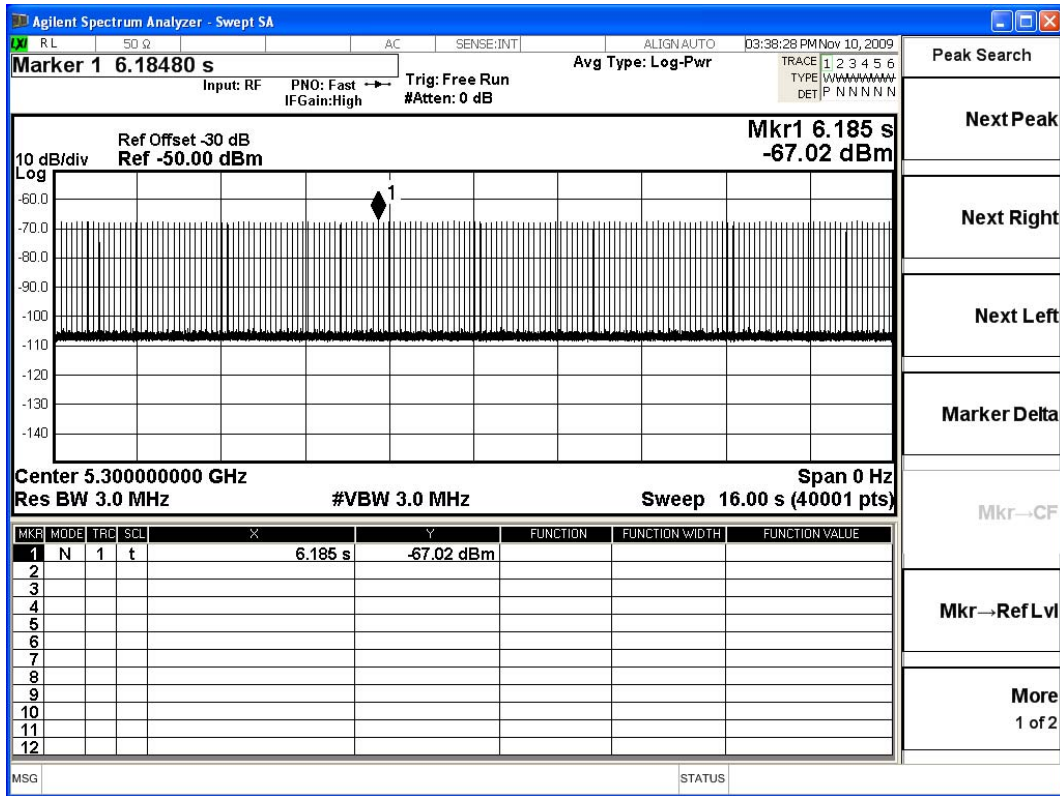

Plot of WLAN Traffic at 5500MHz-n20

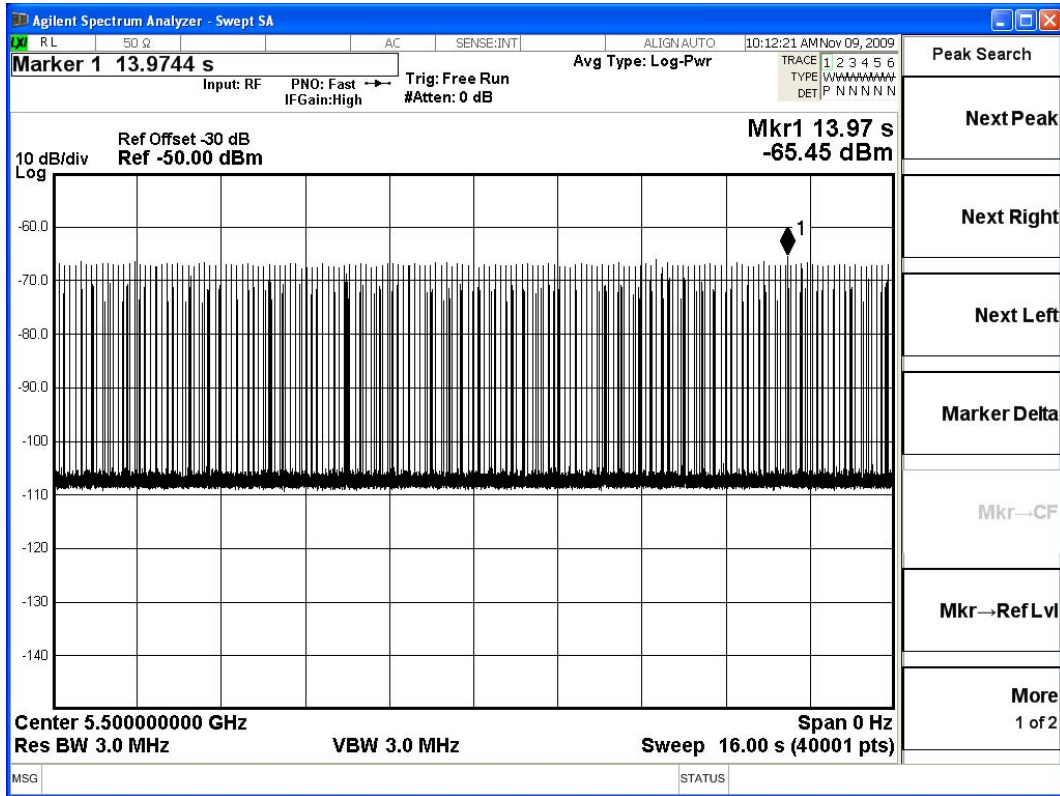

Plot of WLAN Traffic at 5310MHz-n40

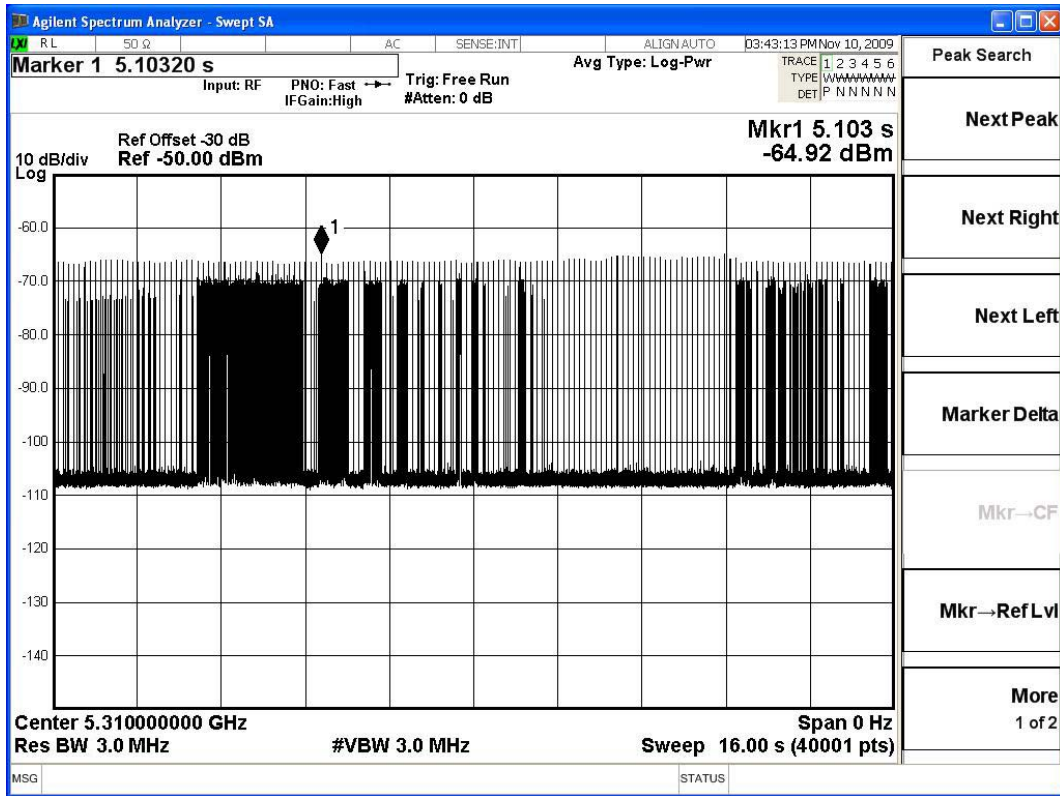

Plot of WLAN Traffic at 5510MHz-n40

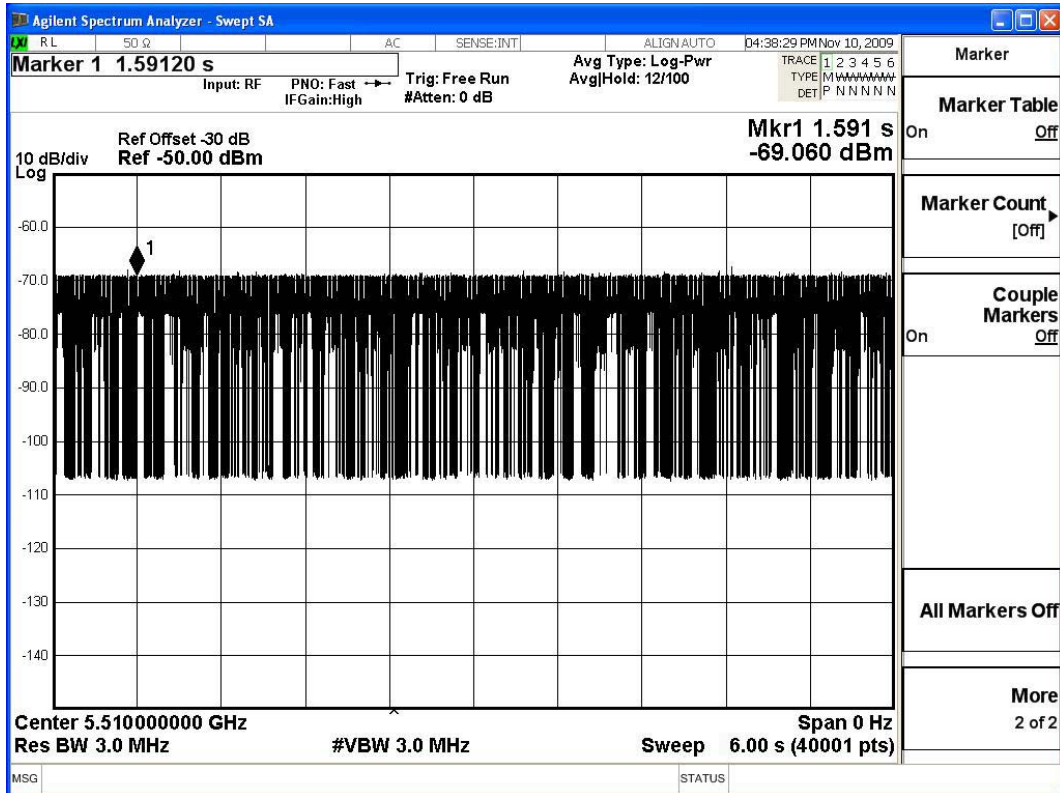

2. Channel Move Time and Channel Closing Transmission Time

2.1. Test Procedure

These tests define how the following DFS parameters are verified during In-Service Monitoring; Channel Closing Transmission Time and Channel Move Time.

The steps below define the procedure to determine the above mentioned parameters when a radar burst with a level -61dBm is generated on the operating channel of the U-NII device.

A U-NII device operating as a Client device will associate with the Master device at 5300MHz, 5660MHz.

During the in-service monitoring detection probability and channel moving tests the system was configured with a streaming video file from the master device (sourced by the PC connected to the master device via an Ethernet interface) to the client device. The streamed file was the "FCC" test file and the client device was using Media Player Classic as required by FCC Part 15 Subpart E.

Observe the transmissions of the EUT at the end of the radar burst on the operating channel for duration greater than 10 seconds. Measure and record the transmissions from the spectrum analyzer during the observation time (Channel Move Time). Compare the channel move time and channel closing transmission time results to the limits defined in the DFS Response requirement values table.

2.2. Test Requirement

Parameter	Value
Channel Move Time	10 Seconds
Channel Closing Transmission Time	200 milliseconds + approx. 60 milliseconds over remaining 10 seconds period

2.3. Uncertainty

± 1ms.

2.4. Test Result of Channel Move Time and Channel Closing Transmission Time

Product : 802.11a/b/g/n WLAN Module
 Test Item : Channel Move Time Test
 Radar Type : Type 1
 Test Mode : Mode 1: Transmitter (802.11n-20BW)

Channel Move Time for Radar Test Type 1 at 5300MHz

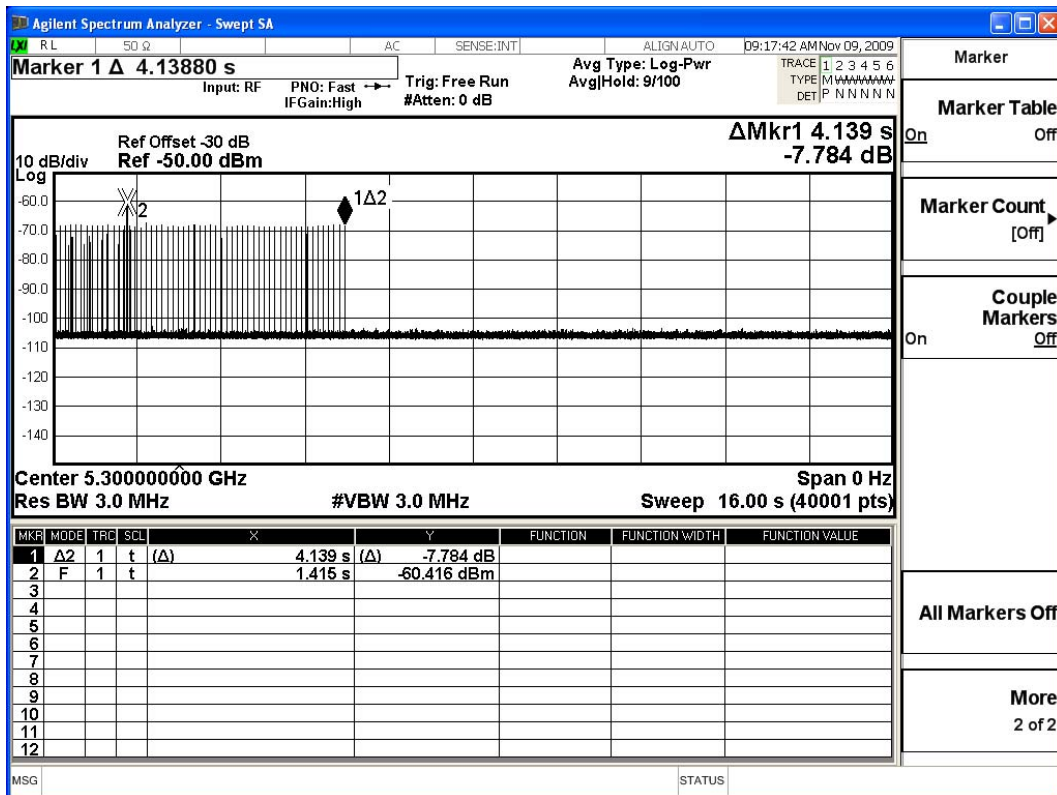

Test Item	Value (s)	Limit	Results
Channel Move Time	4.139	10 Seconds	Pass

The results showed that after radar signal injected the channel move time was less than 10 seconds.

Channel Move Time for Radar Test Type 1 at 5500MHz

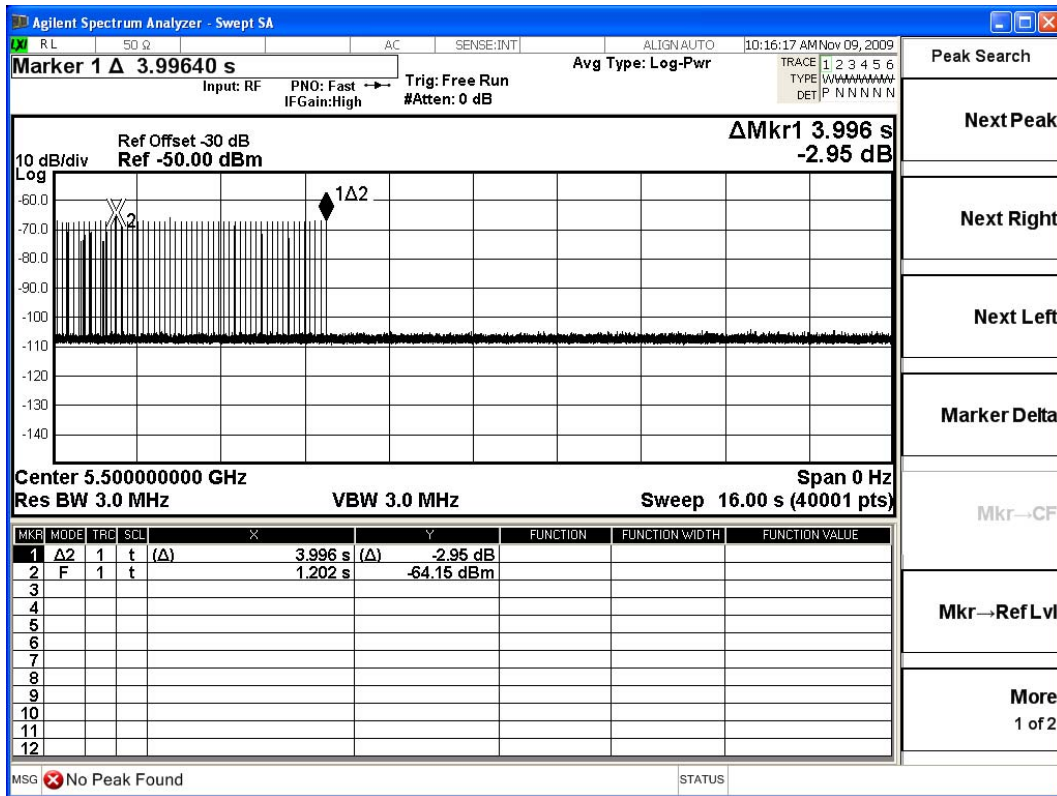

Test Item	Value (s)	Limit	Results
Channel Move Time	3.996	10 Seconds	Pass

The results showed that after radar signal injected the channel move time was less than 10 seconds.

Product : 802.11a/b/g/n WLAN Module
 Test Item : Channel Move Time Test
 Radar Type : Type 1
 Test Mode : Mode 2: Transmitter (802.11n-40BW)

Channel Move Time for Radar Test Type 1 at 5310MHz

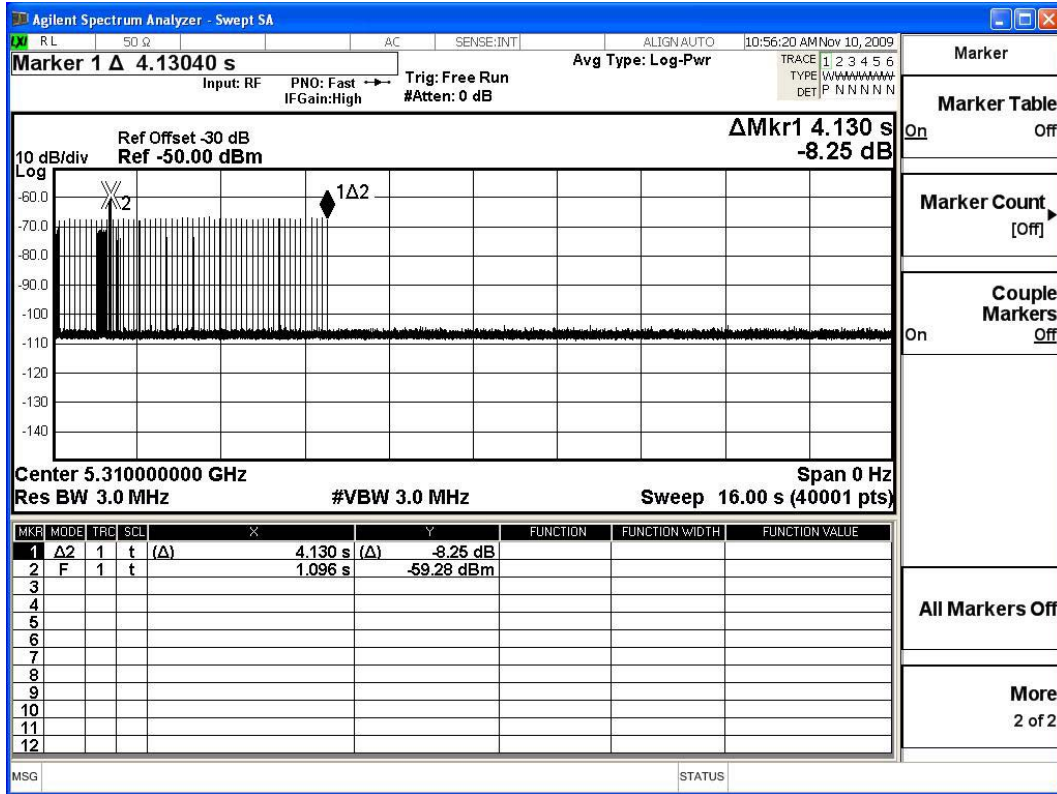

Test Item	Value (s)	Limit	Results
Channel Move Time	4.130	10 Seconds	Pass

The results showed that after radar signal injected the channel move time was less than 10 seconds.

Channel Move Time for Radar Test Type 1 at 5510MHz

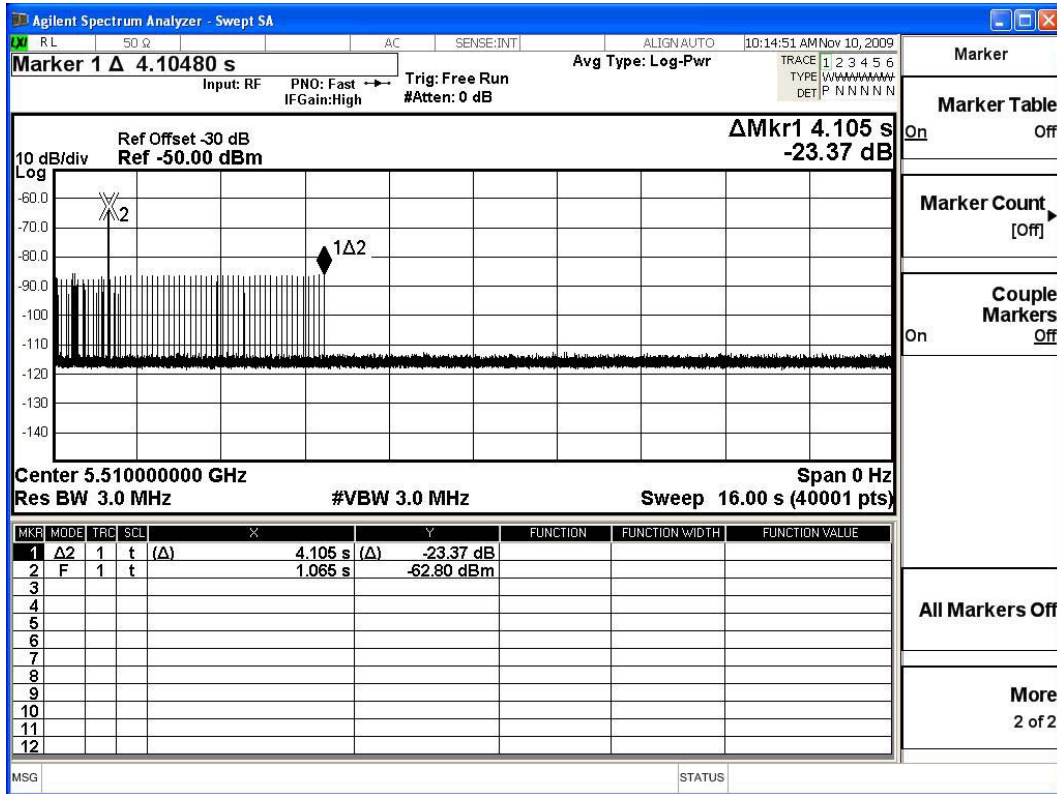

Test Item	Value (s)	Limit	Results
Channel Move Time	4.105	10 Seconds	Pass

The results showed that after radar signal injected the channel move time was less than 10 seconds.

Product : 802.11a/b/g/n WLAN Module
 Test Item : Channel Closing Transmission Time
 Radar Type : Type 1
 Test Mode : Mode 1: Transmitter (802.11n-20BW)

Channel Closing Transmission Time for Radar Test Type 1 at 5300 MHz

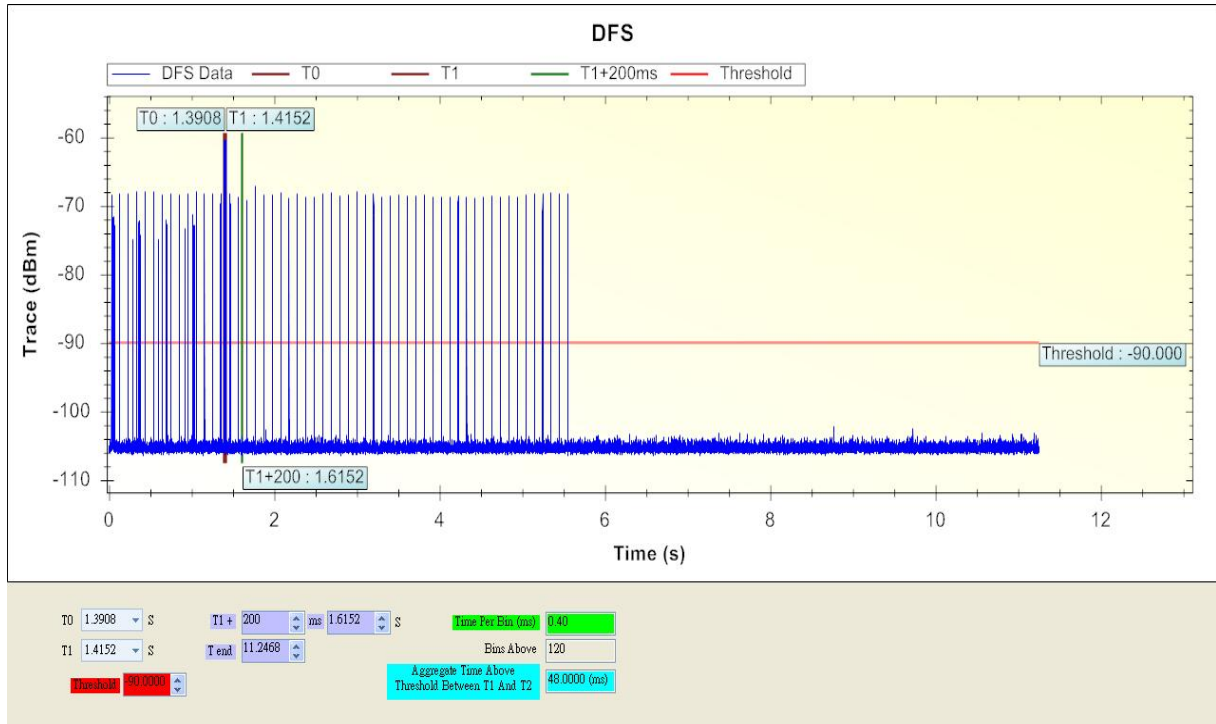

Test Item	Value (ms)	Limit	Results
Channel Closing Transmission	48	200 milliseconds + approx. 60 milliseconds over remaining 10 seconds period	Pass

The results showed that after radar signal injected the channel transmission closing time less than 200 milliseconds and an aggregate of no more than 60 milliseconds.

Channel Closing Transmission Time for Radar Test Type 1 at 5500 MHz

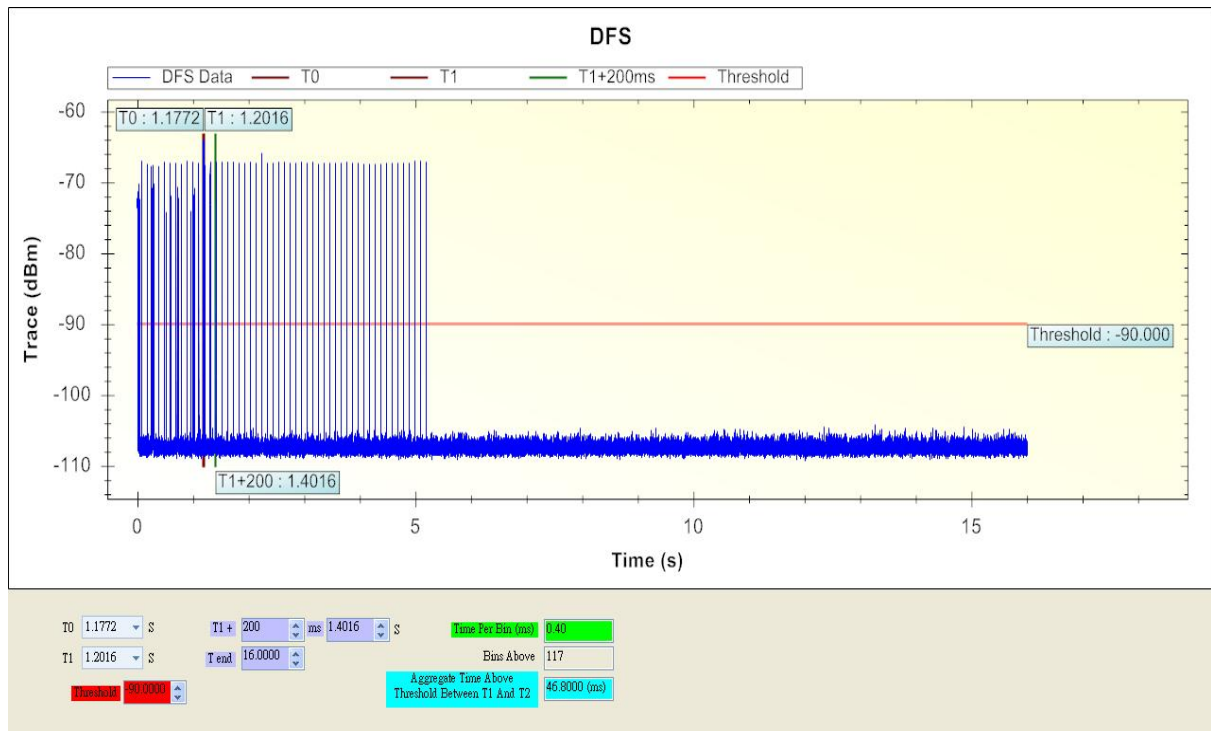

Test Item	Value (ms)	Limit	Results
Channel Closing Transmission	46.8	200 milliseconds + approx. 60 milliseconds over remaining 10 seconds period	Pass

The results showed that after radar signal injected the channel transmission closing time less than 200 milliseconds and an aggregate of no more than 60 milliseconds.

Product : 802.11a/b/g/n WLAN Module
 Test Item : Channel Closing Transmission Time
 Radar Type : Type 1
 Test Mode : Mode 2: Transmitter (802.11n-40BW)

Channel Closing Transmission Time for Radar Test Type 1 at 5310 MHz

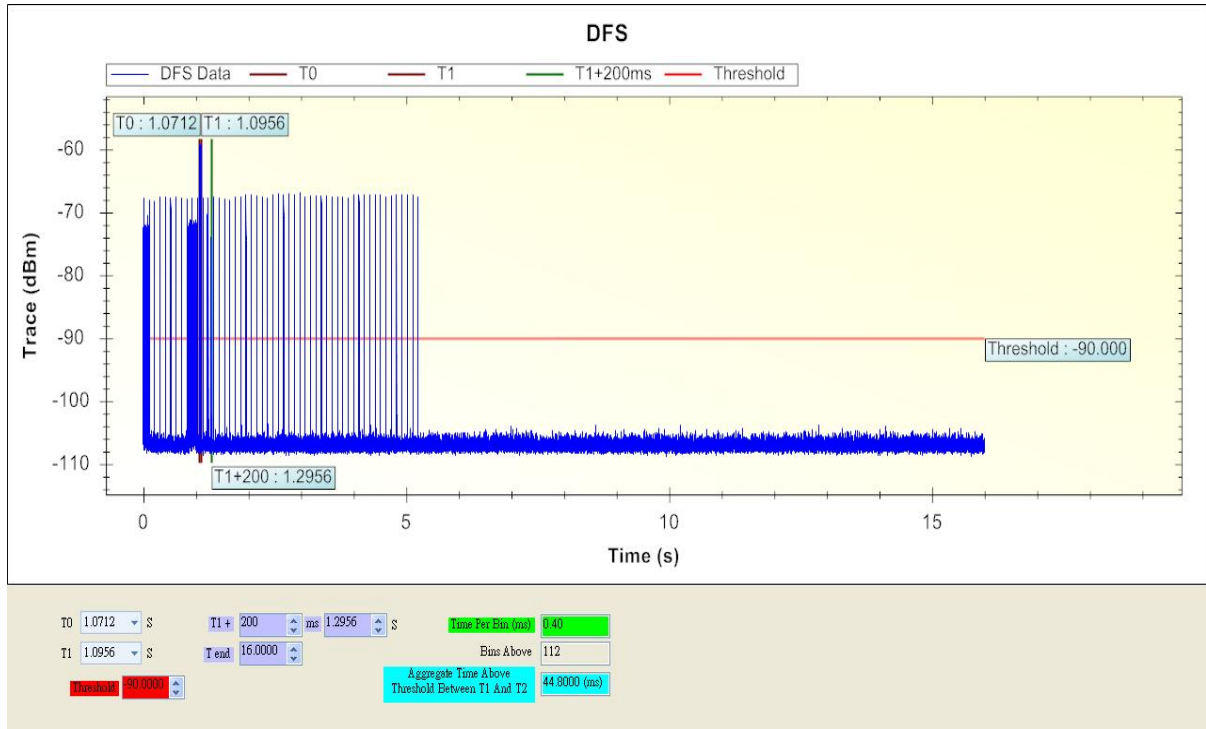

Test Item	Value (ms)	Limit	Results
Channel Closing Transmission	44.8	200 milliseconds + approx. 60 milliseconds over remaining 10 seconds period	Pass

The results showed that after radar signal injected the channel transmission closing time less than 200 milliseconds and an aggregate of no more than 60 milliseconds.

Channel Closing Transmission Time for Radar Test Type 1 at 5510 MHz

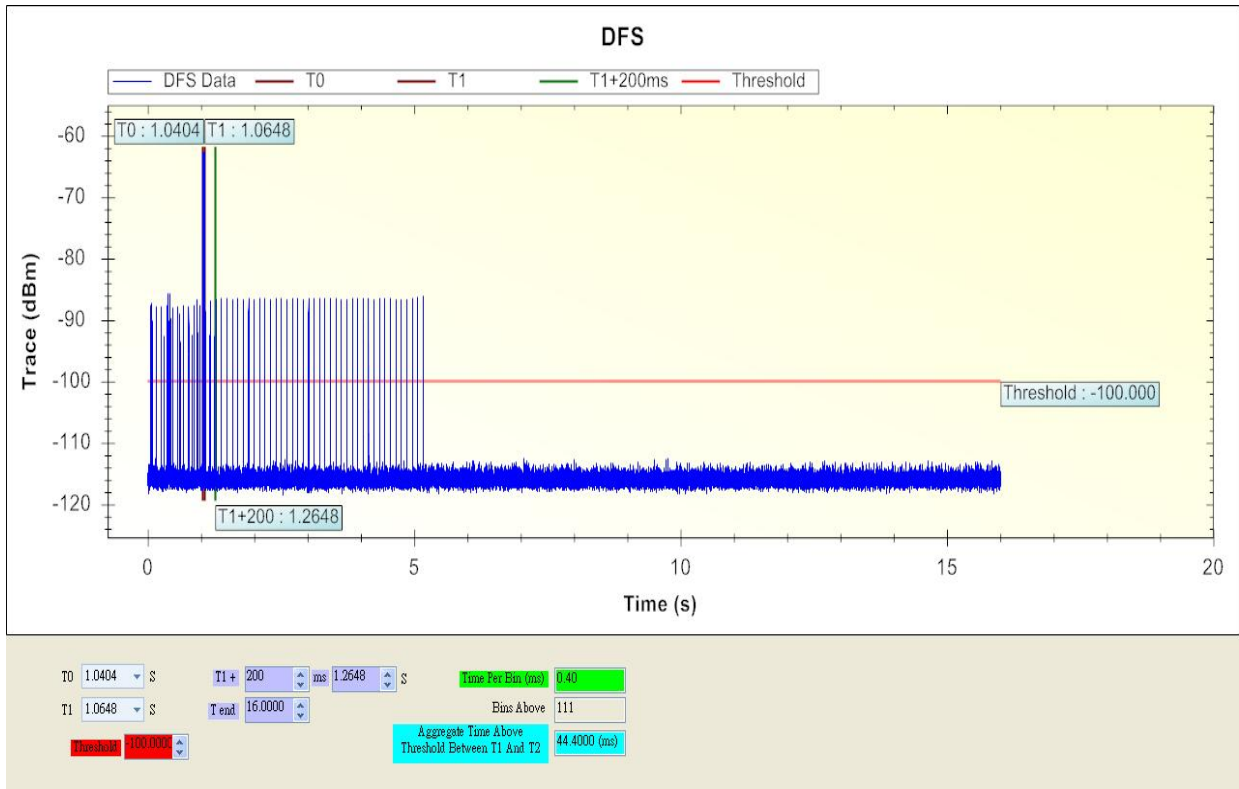

Test Item	Value (ms)	Limit	Results
Channel Closing Transmission	44.4	200 milliseconds + approx. 60 milliseconds over remaining 10 seconds period	Pass

The results showed that after radar signal injected the channel transmission closing time less than 200 milliseconds and an aggregate of no more than 60 milliseconds.

3. Non-Occupancy Period

3.1. Test Procedur

Measure the EUT for more than 30 minutes following the channel close/move time to verify that the UUT does not resume any transmissions on this channel.

3.2. Test Requirement

Parameter	Value
Non-Occupancy Period	30 Minutes

3.3. Uncertainty

± 1ms.

4. Test Result of Non-Occupancy Period

Product : 802.11a/b/g/n WLAN Module
 Test Item : Non-Occupancy Period
 Radar Type : Type 1
 Test Mode : Mode 1: Transmitter (802.11n-20BW)

30 Minute Non-Occupancy Period (Associated test) at 5300 MHz

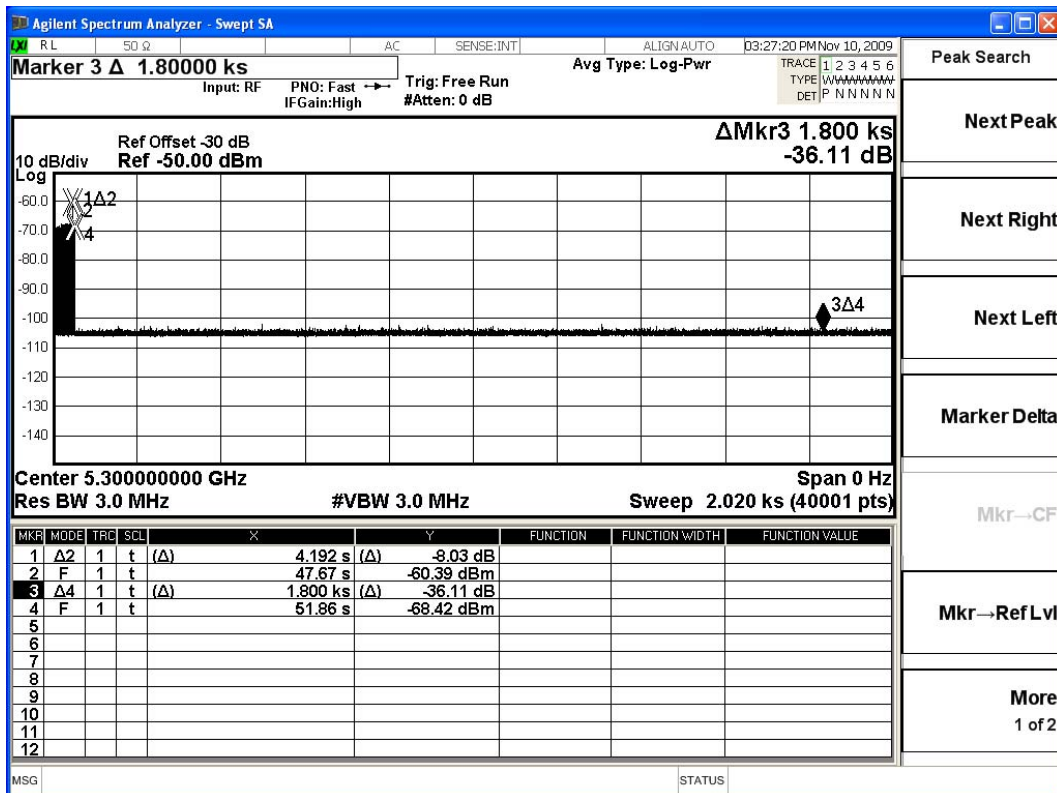

Test Item	Limit	Results
Non-Occupancy Period	30 Minutes	Pass

No EUT transmissions were observed on the test channel during 30 minutes observation time.

30 Minute Non-Occupancy Period (Associated test) at 5500 MHz

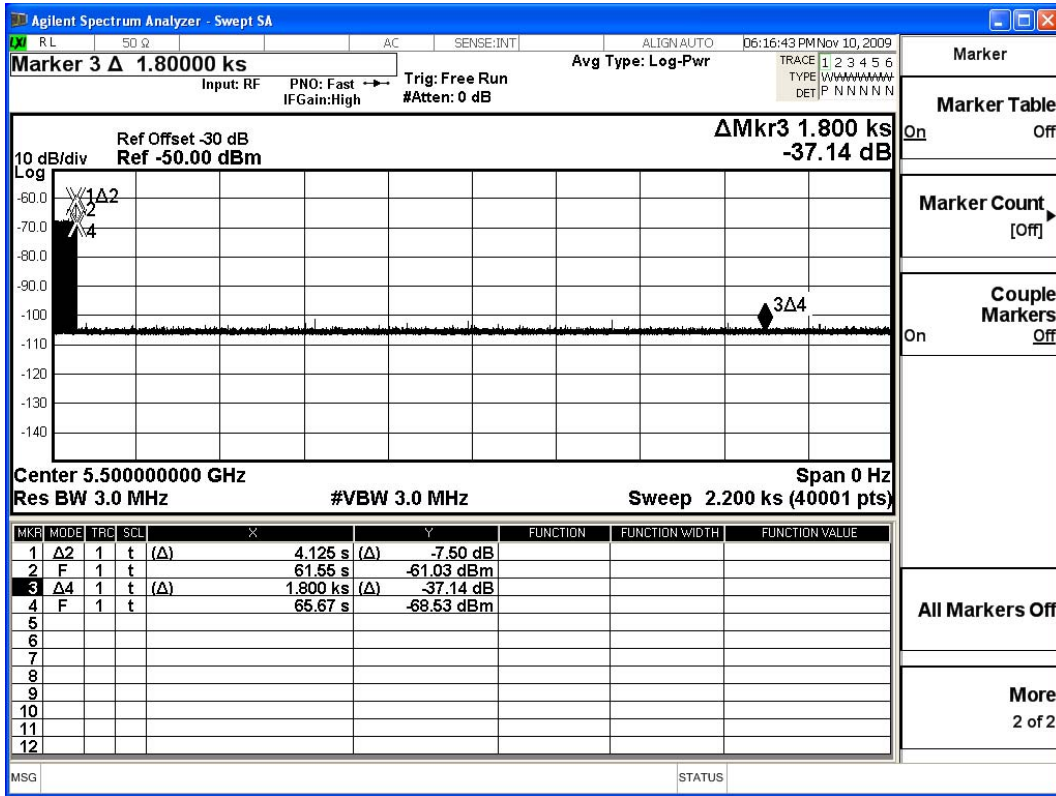

Test Item	Limit	Results
Non-Occupancy Period	30 Minutes	Pass

No EUT transmissions were observed on the test channel during 30 minutes observation time.

30 Minute Non-Occupancy Period (Non-associated test) at 5300 MHz

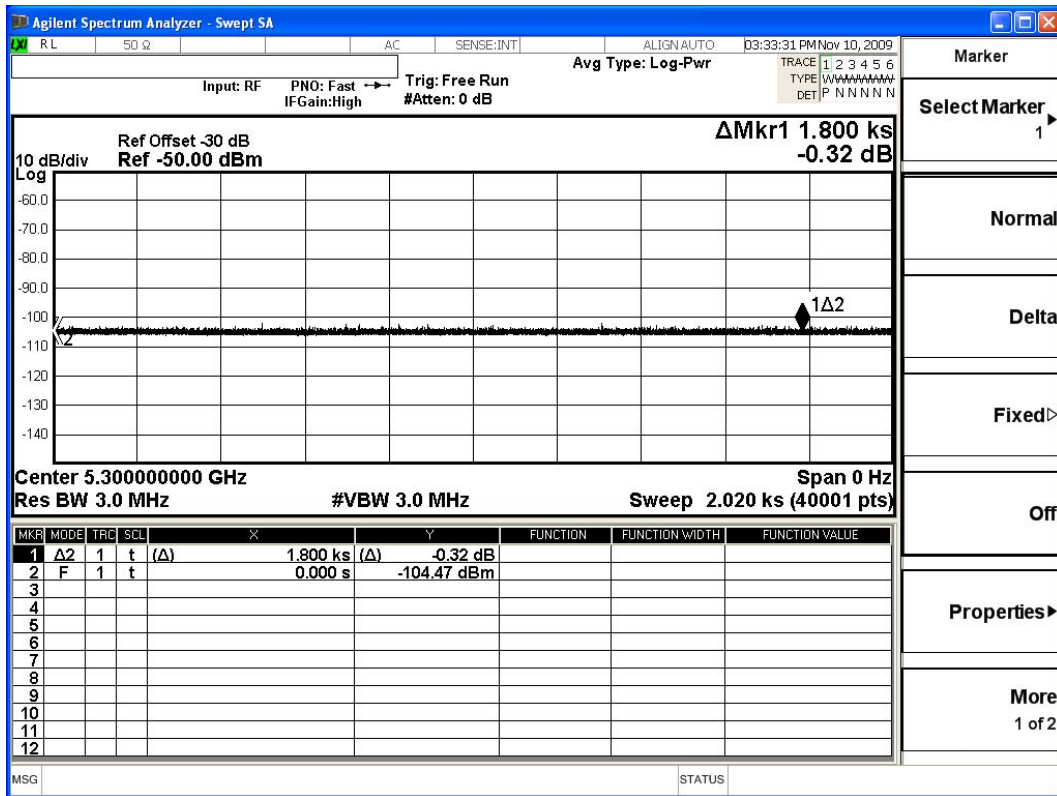

Test Item	Limit	Results
Non-Occupancy Period	30 Minutes	Pass

No EUT transmissions were observed on the test channel during 30 minutes observation time.

30 Minute Non-Occupancy Period (Non-associated test) at 5500 MHz

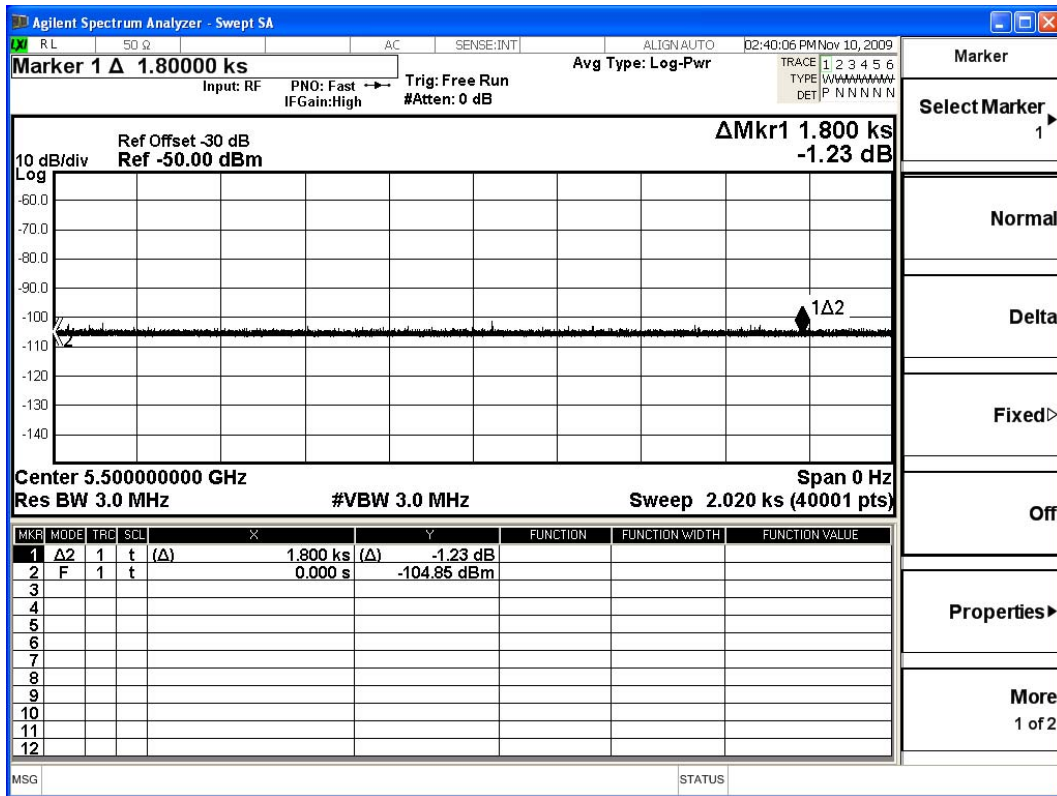

Test Item	Limit	Results
Non-Occupancy Period	30 Minutes	Pass

No EUT transmissions were observed on the test channel during 30 minutes observation time.

Product : 802.11a/b/g/n WLAN Module
 Test Item : Non-Occupancy Period
 Radar Type : Type 1
 Test Mode : Mode 2: Transmitter (802.11n-40BW)

30 Minute Non-Occupancy Period (Associated test) at 5310 MHz

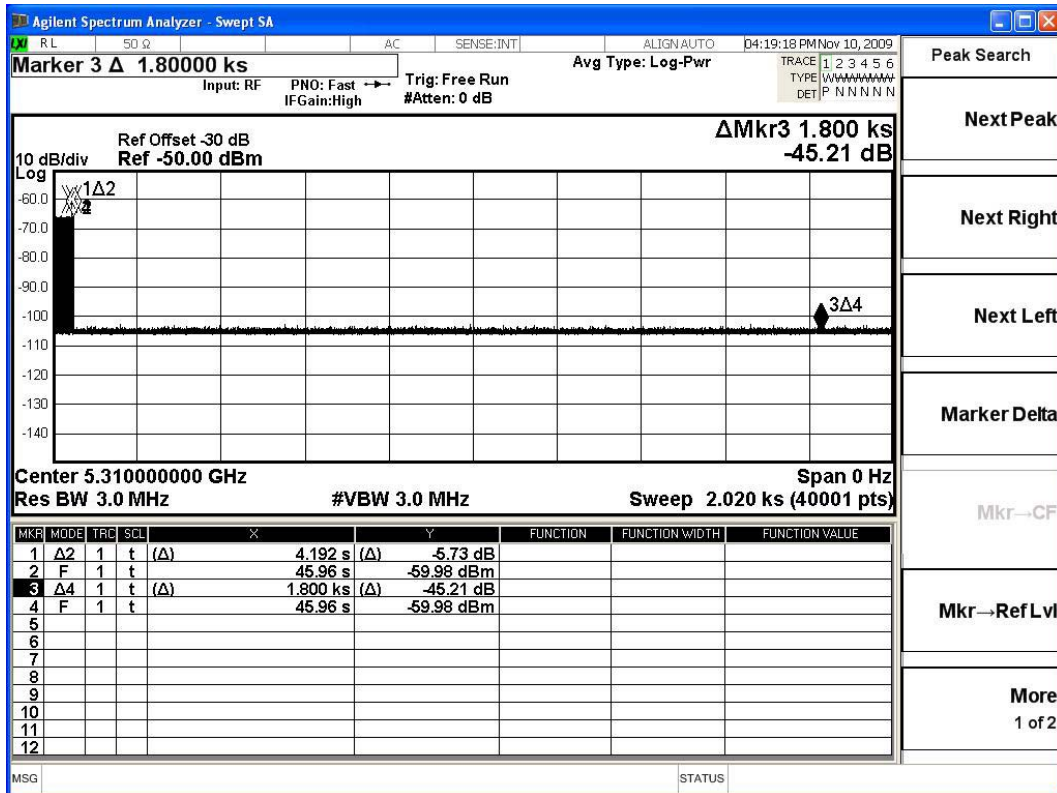

Test Item	Limit	Results
Non-Occupancy Period	30 Minutes	Pass

No EUT transmissions were observed on the test channel during 30 minutes observation time.

30 Minute Non-Occupancy Period (Associated test) at 5510 MHz

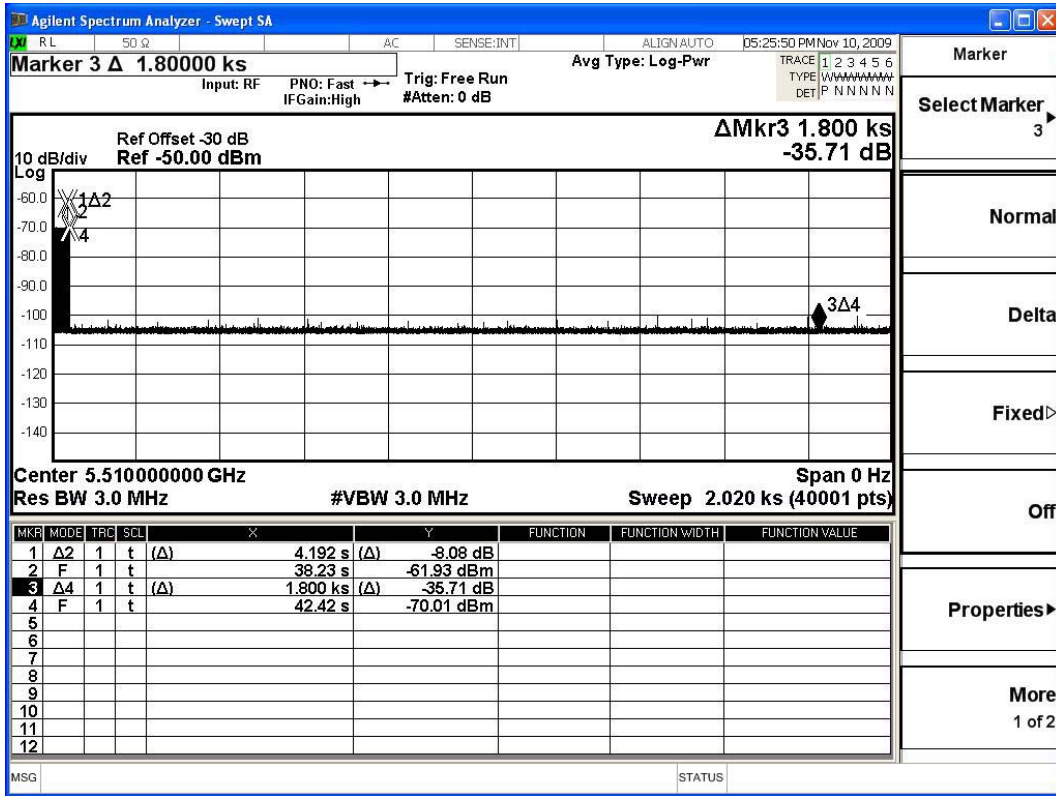

Test Item	Limit	Results
Non-Occupancy Period	30 Minutes	Pass

No EUT transmissions were observed on the test channel during 30 minutes observation time.

30 Minute Non-Occupancy Period (Non-associated test) at 5310 MHz

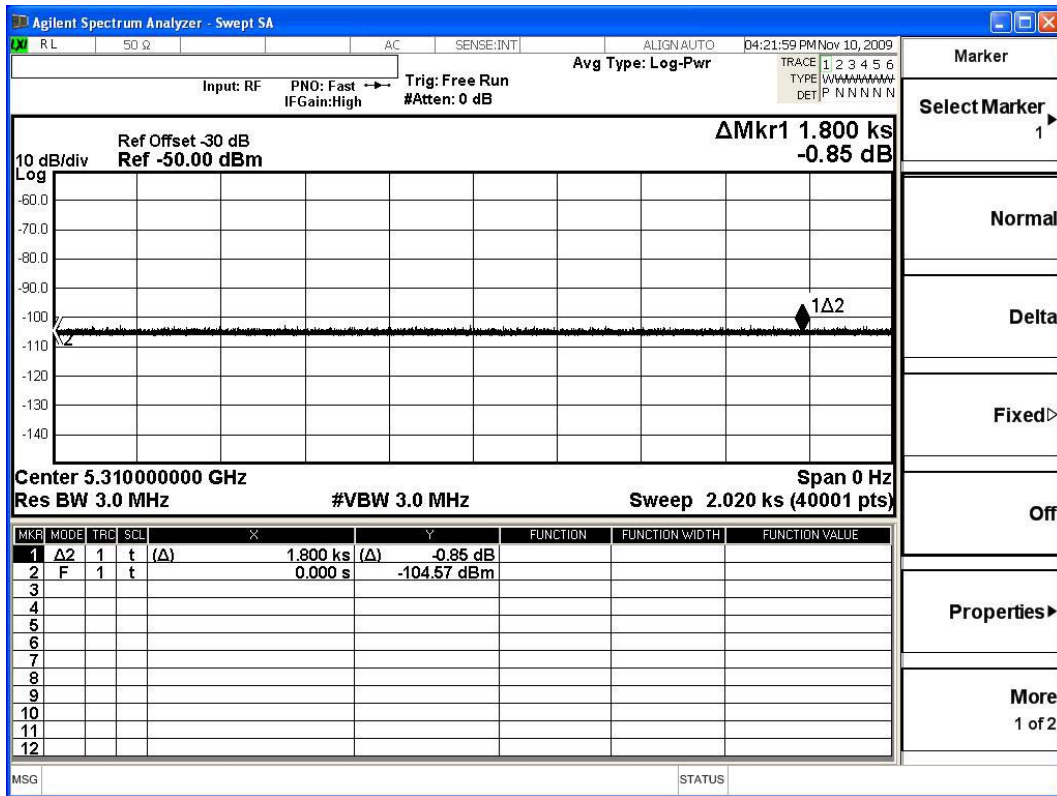

Test Item	Limit	Results
Non-Occupancy Period	30 Minutes	Pass

No EUT transmissions were observed on the test channel during 30 minutes observation time.

30 Minute Non-Occupancy Period (Non-associated test) at 5510 MHz

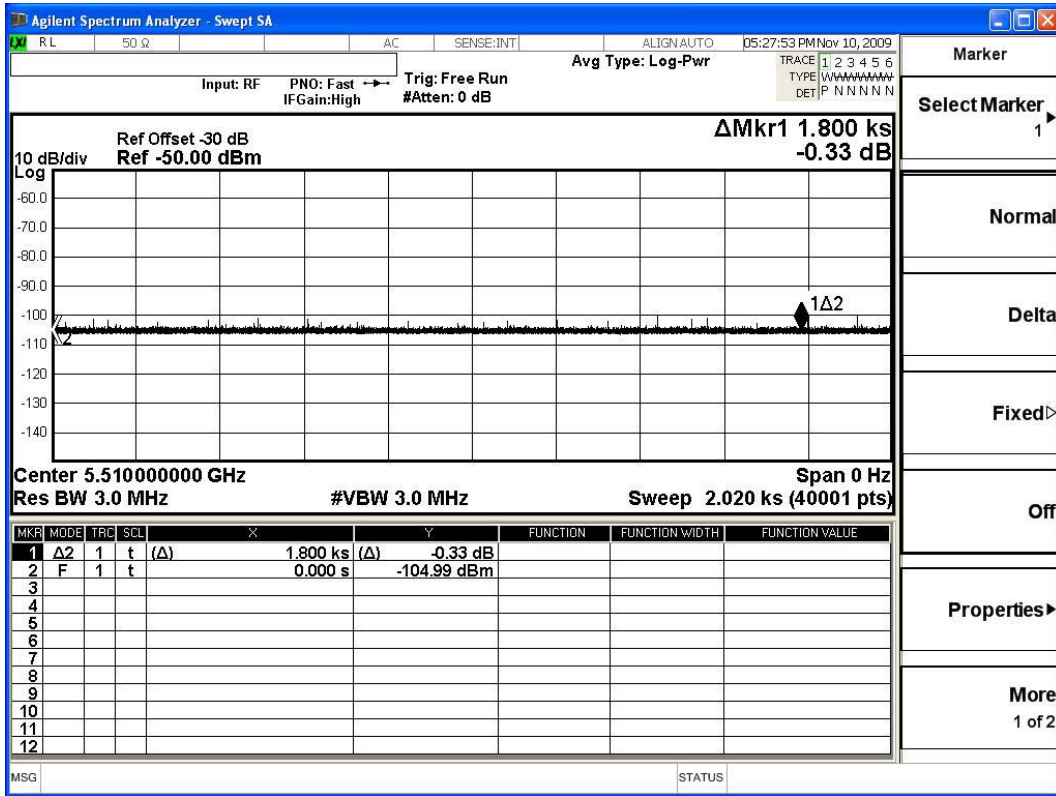

Test Item	Limit	Results
Non-Occupancy Period	30 Minutes	Pass

No EUT transmissions were observed on the test channel during 30 minutes observation time.