



MET Laboratories, Inc. *Safety Certification - EMI - Telecom Environmental Simulation*

914 WEST PATAPSCO AVENUE • BALTIMORE, MARYLAND 21230-3432 • PHONE (410) 354-3300 • FAX (410) 354-3313
33439 WESTERN AVENUE • UNION CITY, CALIFORNIA 94587 • PHONE (510) 489-6300 • FAX (510) 489-6372
3162 BELICK STREET • SANTA CLARA, CALIFORNIA 95054 • PHONE (408) 748-3585 • FAX (510) 489-6372
13501 MCCALLEN PASS • AUSTIN, TX 78753 • PHONE (512) 287-2500 • FAX (512) 287-2513

April 28, 2016

Roku
12980 Saratoga Ave.
Saratoga, CA 95070

Dear Joe Otsuka,

Enclosed is the EMC Wireless test report for compliance testing of the Roku, RC80 & RC81 as tested to the requirements of Title 47 of the CFR, Ch. 1 (10-1-06 ed.), Title 47 of the CFR, Part 15.407, Subpart E (UNII 3).

Thank you for using the services of MET Laboratories, Inc. If you have any questions regarding these results or if MET can be of further service to you, please feel free to contact me.

Sincerely yours,
MET LABORATORIES, INC.

Jennifer Warnell
Documentation Department

Reference: (\\Roku\ EMCS88334-FCC407 UNII 3 Rev. 1)

Certificates and reports shall not be reproduced except in full, without the written permission of MET Laboratories, Inc.



MET Laboratories, Inc. *Safety Certification - EMI - Telecom Environmental Simulation*

914 WEST PATAPSCO AVENUE • BALTIMORE, MARYLAND 21230-3432 • PHONE (410) 354-3300 • FAX (410) 354-3313

33439 WESTERN AVENUE • UNION CITY, CALIFORNIA 94587 • PHONE (510) 489-6300 • FAX (510) 489-6372

3162 BELICK STREET • SANTA CLARA, CALIFORNIA 95054 • PHONE (408) 748-3585 • FAX (510) 489-6372

13501 MCCALLEN PASS • AUSTIN, TX 78753 • PHONE (512) 287-2500 • FAX (512) 287-2513

**Electromagnetic Compatibility Criteria
Test Report**

for the

**Roku
Model RC80 & RC81**

Tested under
The FCC Certification Rules
contained in
Title 47 of the CFR
15.407 Subpart E

MET Report: EMCS88334-FCC407 UNII 3 Rev. 1

April 28, 2016

Prepared For:

**Roku
12980 Saratoga Ave.
Saratoga, CA 95070**

Prepared By:
MET Laboratories, Inc.
914 W. Patapsco Ave.
Baltimore, MD 21230

Electromagnetic Compatibility Criteria Test Report

for the

Roku
Model RC80 & RC81

Tested under
The FCC Certification Rules
contained in
Title 47 of the CFR
15.407 Subpart E



Ajaz Khan, Project Engineer
Electromagnetic Compatibility Lab



Jennifer Warnell
Documentation Department

Engineering Statement: The measurements shown in this report were made in accordance with the procedures indicated, and the emissions from this equipment were found to be within the limits applicable. I assume full responsibility for the accuracy and completeness of these measurements, and for the qualifications of all persons taking them. It is further stated that upon the basis of the measurements made, the equipment tested is capable of operation in accordance with the requirements of Parts 15B, 15.407, of the FCC Rules under normal use and maintenance.



Asad Bajwa,
Director, Electromagnetic Compatibility Lab

Report Status Sheet

Revision	Report Date	Reason for Revision
∅	April 5, 2016	Initial Issue.
1	April 28, 2016	Engineer corrections.

Table of Contents

I.	Executive Summary	1
	A. Purpose of Test	2
	B. Executive Summary	2
II.	Equipment Configuration	3
	A. Overview.....	4
	B. References.....	5
	C. Test Site	5
	D. Description of Test Sample.....	5
	E. Equipment Configuration.....	6
	F. Support Equipment	6
	G. Ports and Cabling Information.....	7
	H. Mode of Operation.....	7
	I. Method of Monitoring EUT Operation	7
	J. Modifications	7
	a) Modifications to EUT	7
	b) Modifications to Test Standard	7
	K. Disposition of EUT	7
III.	Electromagnetic Compatibility Criteria for Intentional Radiators.....	8
	§ 15.203 Antenna Requirement.....	9
	§ 15.403(i) 26 dB Bandwidth	10
	§ 15.407(a)(3) Maximum Conducted Output Power	12
	§ 15.407(a)(3) Maximum Power Spectral Density	14
	§ 15.407(b)(4) & (6 - 7) Undesirable Emissions	16
	§ 15.407(b)(6) Conducted Emissions	22
	§ 15.407(e) 6 dB Bandwidth.....	23
	§ 15.247(i) Maximum Permissible Exposure	25
IV.	Test Equipment	26
V.	Certification & User's Manual Information.....	28
	A. Certification Information	29
	B. Label and User's Manual Information	33

List of Tables

Table 1. Executive Summary of EMC Part 15.407 Compliance Testing	2
Table 2. EUT Summary.....	4
Table 3. References	5
Table 4. Equipment Configuration	6
Table 5. Support Equipment.....	6
Table 6. Ports and Cabling Information	7
Table 7. Conducted Limits for Intentional Radiators from FCC Part 15 § 15.207(a)	22
Table 8. Test Equipment List	27

List of Figures

Figure 1. Block Diagram of Test Configuration.....	6
--	---

List of Plots

Plot 1. Occupied Bandwidth, 802.11a, Low Channel.....	11
Plot 2. Occupied Bandwidth, 802.11a, Mid Channel	11
Plot 3. Occupied Bandwidth, 802.11a, High Channel	11
Plot 4. Maximum Conducted Output Power, 802.11a, Low Channel	13
Plot 5. Maximum Conducted Output Power, 802.11a, Mid Channel.....	13
Plot 6. Maximum Conducted Output Power, 802.11a, High Channel.....	13
Plot 7. Maximum Power Spectral Density, 802.11a, Low Channel	15
Plot 8. Maximum Power Spectral Density, 802.11a, Mid Channel	15
Plot 9. Maximum Power Spectral Density, 802.11a, High Channel.....	15
Plot 10. Radiated Spurious Emissions, 802.11a, Low Channel, 30 MHz – 1 GHz	17
Plot 11. Radiated Spurious Emissions, 802.11a, Low Channel, 1 GHz – 7 GHz, Peak	17
Plot 12. Radiated Spurious Emissions, 802.11a, Low Channel, 7 GHz – 18 GHz, Peak	17
Plot 13. Radiated Spurious Emissions, 802.11a, Mid Channel, 30 MHz – 1 GHz.....	18
Plot 14. Radiated Spurious Emissions, 802.11a, Mid Channel, 1 GHz – 7 GHz, Peak.....	18
Plot 15. Radiated Spurious Emissions, 802.11a, Mid Channel, 7 GHz – 18 GHz, Peak.....	18
Plot 16. Radiated Spurious Emissions, 802.11a, High Channel, 30 MHz – 1 GHz	19
Plot 17. Radiated Spurious Emissions, 802.11a, High Channel, 1 GHz – 7 GHz, Peak	19
Plot 18. Radiated Spurious Emissions, 802.11a, High Channel, 7 GHz – 18 GHz, Peak	19
Plot 19. Radiated Band Edge, 802.11a, Low Channel, Average	20
Plot 20. Radiated Band Edge, 802.11a, Low Channel, Peak	20
Plot 21. Radiated Band Edge, 802.11a, High Channel, Average	21
Plot 22. Radiated Band Edge, 802.11a, High Channel, Peak	21
Plot 23. 6 dB Bandwidth, 802.11a, Low Channel	24
Plot 24. 6 dB Bandwidth, 802.11a, Mid Channel.....	24
Plot 25. 6 dB Bandwidth, 802.11a, High Channel.....	24

List of Terms and Abbreviations

AC	Alternating Current
ACF	Antenna Correction Factor
Cal	Calibration
<i>d</i>	Measurement Distance
dB	Decibels
dBμA	Decibels above one microamp
dBμV	Decibels above one microvolt
dBμA/m	Decibels above one microamp per meter
dBμV/m	Decibels above one microvolt per meter
DC	Direct Current
E	Electric Field
DSL	Digital Subscriber Line
ESD	Electrostatic Discharge
EUT	Equipment Under Test
<i>f</i>	Frequency
FCC	Federal Communications Commission
GRP	Ground Reference Plane
H	Magnetic Field
HCP	Horizontal Coupling Plane
Hz	Hertz
IEC	International Electrotechnical Commission
kHz	Kilohertz
kPa	Kilopascal
kV	Kilovolt
LISN	Line Impedance Stabilization Network
MHz	Megahertz
μH	Microhenry
μ	Microfarad
μs	Microseconds
PRF	Pulse Repetition Frequency
RF	Radio Frequency
RMS	Root-Mean-Square
TWT	Traveling Wave Tube
V/m	Volts per meter
VCP	Vertical Coupling Plane

I. Executive Summary

A. Purpose of Test

An EMC evaluation was performed to determine compliance of the Roku RC80 & RC81, with the requirements of Part 15, §15.407. All references are to the most current version of Title 47 of the Code of Federal Regulations in effect. In accordance with §2.1033, the following data is presented in support of the Certification of the RC80 & RC81. Roku should retain a copy of this document which should be kept on file for at least two years after the manufacturing of the RC80 & RC81, has been **permanently** discontinued.

B. Executive Summary

The following tests were conducted on a sample of the equipment for the purpose of demonstrating compliance with Part 15, §15.407, in accordance with Roku, purchase order number FC-23677. All tests were conducted using measurement procedure ANSI C63.4-2014.

FCC Reference	Description	Results
§15.203	Antenna Requirement	Compliant
§15.403(i)	26 dB Bandwidth	Compliant
§15.407 (a)(3)	Maximum Conducted Output Power	Compliant
§15.407 (a)(3)	Maximum Power Spectral Density	Compliant
§15.407 (b)(4)& (6 - 7)	Undesirable Emissions	Compliant
§15.407(b)(6)	Conducted Emission Limits	Not Applicable
§15.407(e)	6 dB Bandwidth	Compliant
§15.407(f)	RF Exposure	Compliant

Table 1. Executive Summary of EMC Part 15.407 Compliance Testing

II. Equipment Configuration

A. Overview

MET Laboratories, Inc. was contracted by Roku to perform testing on the RC80 & RC81, under Roku's purchase order number FC-23677.

This document describes the test setups, test methods, required test equipment, and the test limit criteria used to perform compliance testing of the Roku RC80 & RC81.

The results obtained relate only to the item(s) tested.

Model(s) Tested:	RC80 & RC81	
Model(s) Covered:	RC80 & RC81	
EUT Specifications:	Primary Power: 3.0 VDC	
	FCC ID: TC2-RCB9	
	Type of Modulations:	OFDM, BPSK, QPSK, CCK, DSSS
	Equipment Code:	NII
	Max. RF Output Power:	-1.33 dBm
	EUT Frequency Ranges:	5745 MHz to 5825 MHz
Analysis:	The results obtained relate only to the item(s) tested.	
Environmental Test Conditions:	Temperature: 15-35° C	
	Relative Humidity: 30-60%	
	Barometric Pressure: 860-1060 mbar	
Evaluated by:	Ajaz Khan	
Report Date(s):	April 28, 2016	

Table 2. EUT Summary

B. References

CFR 47, Part 15, Subpart E	Unlicensed National Information Infrastructure Devices (UNII)
ANSI C63.4:2014	Methods and Measurements of Radio-Noise Emissions from Low-Voltage Electrical And Electronic Equipment in the Range of 9 kHz to 40 GHz
ISO/IEC 17025:2005	General Requirements for the Competence of Testing and Calibration Laboratories
ANSI C63.10-2013	American National Standard for Testing Unlicensed Wireless Devices

Table 3. References

C. Test Site

All testing was performed at MET Laboratories, Inc., 3162 Belick St., Santa Clara, CA 95054. All equipment used in making physical determinations is accurate and bears recent traceability to the National Institute of Standards and Technology.

Radiated Emissions measurements were performed in a 3 meter semi-anechoic chamber (equivalent to an Open Area Test Site). In accordance with §2.948(a)(3), a complete site description is contained at MET Laboratories.

D. Description of Test Sample

The Roku RC80 & RC81, Equipment Under Test (EUT), is a Remote Control. It will work with Roku Streaming Stick. It supports wifi 802.11a/b/g Channel 1 through 11 and Channel 36 -48 and Channel 149 through 165. The remote shall operate from 2 x AAA Alkaline batteries. Power requirements shall be a maximum operating voltage of 3.3 Volts. The power will not be regulated.

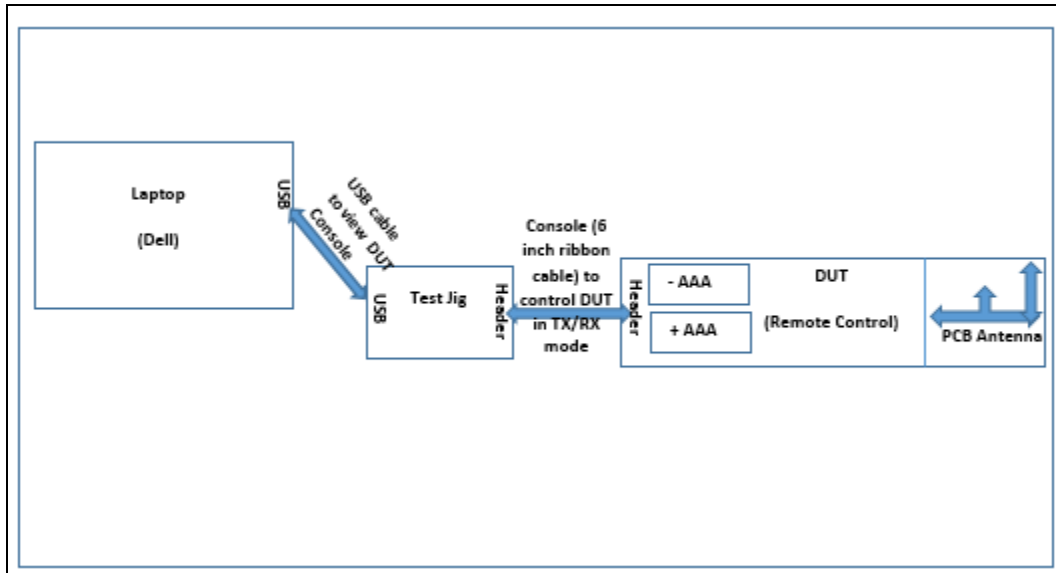

Figure 1. Block Diagram of Test Configuration

Equipment Configuration

The EUT was set up as outlined in Figure 1, Block Diagram of Test Setup. All cards, racks, etc., incorporated as part of the EUT is included in the following list.

Ref. ID	Name / Description	Model Number	Part Number	Serial Number	Revision
1	Roku WiFi Remote Control	RC80 & RC81	--	--	--
2	Roku WiFi Remote Control	RC80 & RC81	--	--	--

Table 4. Equipment Configuration

E. Support Equipment

Support equipment necessary for the operation and testing of the EUT is included in the following list.

Ref. ID	Name / Description	Manufacturer	Model Number
1	Test Jig	Atmel	210920-10
2	Dell Lap top	Dell	Latitude E6410
3	Ribbon Cable	Atmel	N/A

Table 5. Support Equipment

F. Ports and Cabling Information

Ref. ID	Port Name on EUT	Cable Description	Qty.	Length (m)	Shielded (Y/N)	Termination Point
1	Micro USB-to-USB	Computer Cable	1	1	No	N/A
2	Lap top Charger	Dell AC Adapter	1	1	No	(AC 100 -240 V/50 – 60 Hz)

Table 6. Ports and Cabling Information

G. Mode of Operation

FW is running on the DUT (Remote Control) and through console we can configure DUT into different wifi channels.

H. Method of Monitoring EUT Operation

LED is blinking when Battery is first inserted and Remote is in pairing mode. Once it pairs up with Roku RSS LED will turn ON, and turn off when goes into sleep mode.

I. Modifications

a) Modifications to EUT

No modifications were made to the EUT.

b) Modifications to Test Standard

No modifications were made to the test standard.

J. Disposition of EUT

The test sample including all support equipment submitted to the Electro-Magnetic Compatibility Lab for testing was returned to Roku upon completion of testing.

III. Electromagnetic Compatibility Criteria for Intentional Radiators

Electromagnetic Compatibility Criteria for Intentional Radiators

§ 15.203 Antenna Requirement

Test Requirement: § 15.203: An intentional radiator shall be designed to ensure that no antenna other than that furnished by the responsible party shall be used with the device. The use of a permanently attached antenna or of an antenna that uses a unique coupling to the intentional radiator shall be considered sufficient to comply with the provisions of this section. The manufacturer may design the unit so that a broken antenna can be replaced by the user, but the use of a standard antenna jack or electrical connector is prohibited.

The structure and application of the EUT were analyzed to determine compliance with Section 15.203 of the Rules. Section 15.203 states that the subject device must meet at least one of the following criteria:

- a.) Antenna must be permanently attached to the unit.
- b.) Antenna must use a unique type of connector to attach to the EUT.
- c.) Unit must be professionally installed. Installer shall be responsible for verifying that the correct antenna is employed with the unit.

Results: The EUT as tested is compliant the criteria of §15.203. The unit employs an integrated antenna.

Test Engineer(s): Ajaz Khan

Test Date(s): 01/06/16

Electromagnetic Compatibility Criteria for Intentional Radiators

§ 15.403(i) 26 dB Bandwidth

Test Requirements: § 15.403(i): For purposes of this subpart the emission bandwidth shall be determined by measuring the width of the signal between two points, one below the carrier center frequency and one above the carrier center frequency, that are 26 dB down relative to the maximum level of the modulated carrier. Determination of the emissions bandwidth is based on the use of measurement instrumentation employing a peak detector function with an instrument resolution bandwidth approximately equal to 1.0 percent of the emission bandwidth of the device under measurement.

Test Procedure: The transmitter was set to low, mid, and high operating frequencies at the highest output power and connected to the spectrum analyzer through an attenuator. The bandwidth of the fundamental frequency was measured with the spectrum analyzer using a RBW approximately equal to 1% of the total emission bandwidth, VBW > RBW. The 26 dB Bandwidth was measured and recorded.

Test Results The 26 dB Bandwidth was compliant with the requirements of this section.

Test Engineer(s): Ajaz Khan

Test Date(s): 01/06/16

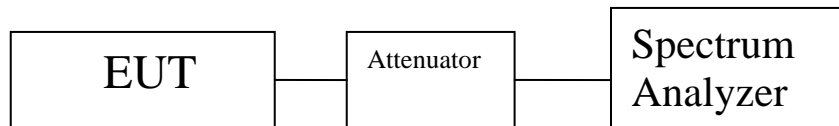

Occupied Bandwidth, 802.11a

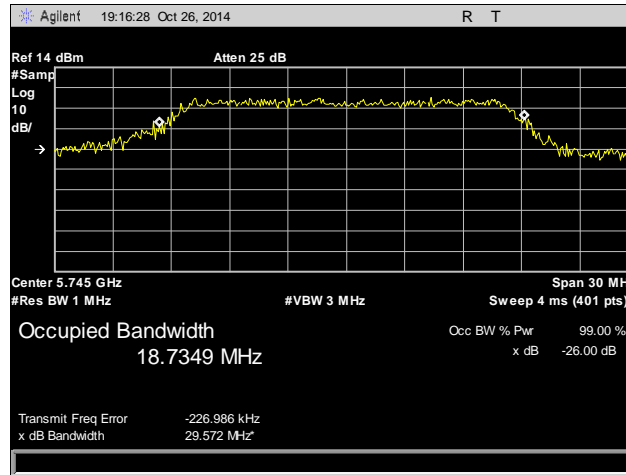

Plot 1. Occupied Bandwidth, 802.11a, Low Channel

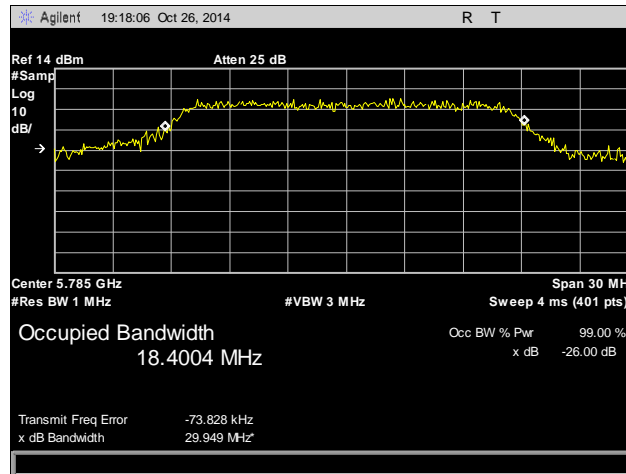

Plot 2. Occupied Bandwidth, 802.11a, Mid Channel

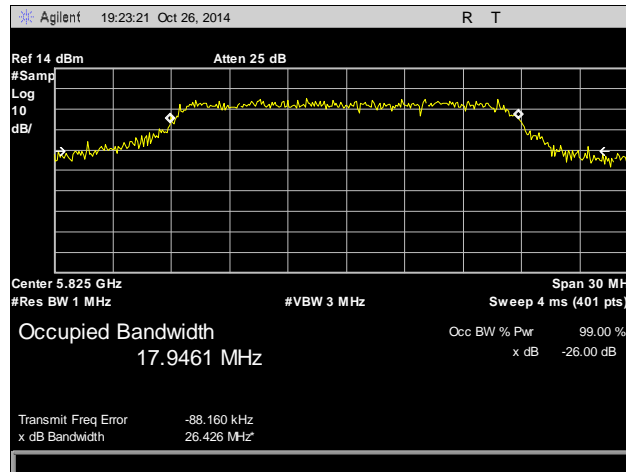

Plot 3. Occupied Bandwidth, 802.11a, High Channel

Electromagnetic Compatibility Criteria for Intentional Radiators

§15.407(a)(3) Maximum Conducted Output Power

Test Requirements: §15.407(a)(3): For the band 5.725-5.85 GHz, the maximum conducted output power over the frequency band of operation shall not exceed 1 W.

If transmitting antennas of directional gain greater than 6 dBi are used, both the maximum conducted output power and the maximum power spectral density shall be reduced by the amount in dB that the directional gain of the antenna exceeds 6 dBi. However, fixed point-to-point U-NII devices operating in this band may employ transmitting antennas with directional gain greater than 6 dBi without any corresponding reduction in transmitter conducted power.

Test Procedure: The EUT was connected to a spectrum analyzer through a cable and attenuator. Measurements were taken with the EUT set to transmit continuously on its low, mid, and high channels. Its power was measured according to measurement method SA-1, as described in 789033 D02 General UNII Test Procedures v01.

Test Results: The EUT as tested is compliant with the requirements of this section.

Test Engineer(s): Ajaz Khan

Test Date(s): 02/03/16

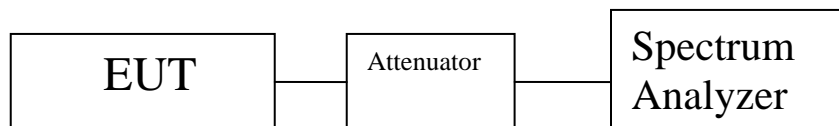

Maximum Conducted Output Power, 802.11a

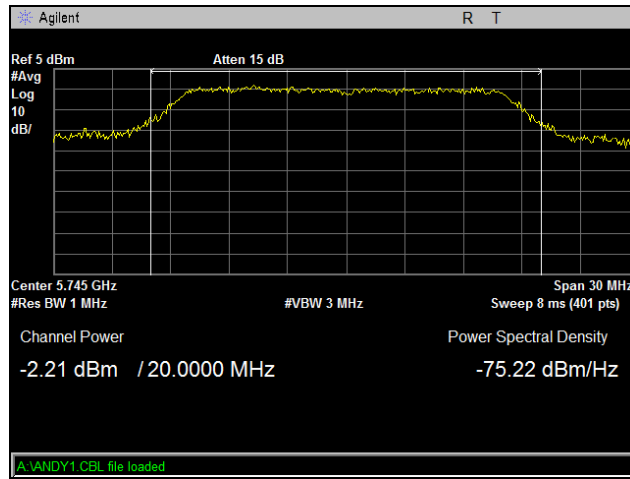

Plot 4. Maximum Conducted Output Power, 802.11a, Low Channel

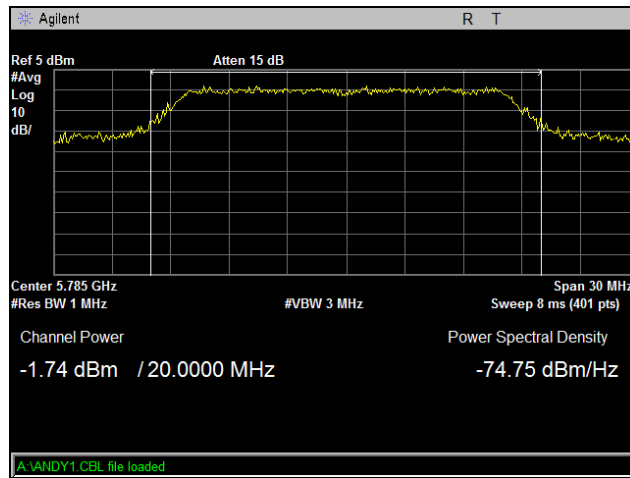

Plot 5. Maximum Conducted Output Power, 802.11a, Mid Channel

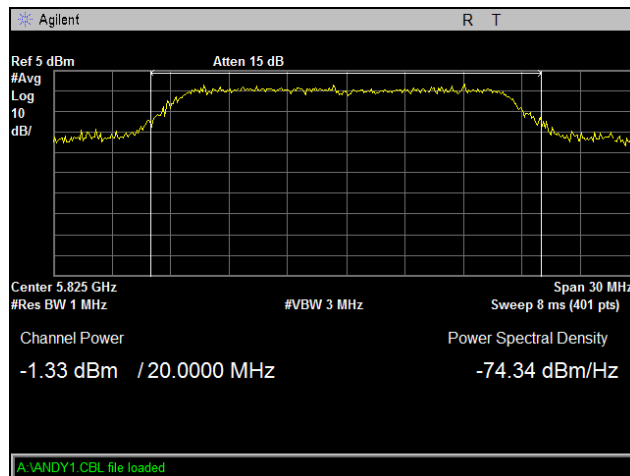

Plot 6. Maximum Conducted Output Power, 802.11a, High Channel

Electromagnetic Compatibility Criteria for Intentional Radiators

§15.407(a)(3) Maximum Power Spectral Density

Test Requirements: §15.407(a)(3): In addition, the maximum power spectral density shall not exceed 30 dBm in any 500-kHz band.

If transmitting antennas of directional gain greater than 6 dBi are used, both the maximum conducted output power and the maximum power spectral density shall be reduced by the amount in dB that the directional gain of the antenna exceeds 6 dBi. However, fixed point-to-point U-NII devices operating in this band may employ transmitting antennas with directional gain greater than 6 dBi without any corresponding reduction in transmitter conducted power.

Test Procedure: The EUT was connected to a spectrum analyzer through a cable and attenuator. Measurements were taken with the EUT set to transmit continuously on its low, mid, and high channels. Its power was measured according KDB 789033 D02 General UNII Test Procedures v01. A 1 MHz RBW was used during testing, as this provides a worst-case scenario.

Test Results: The EUT as tested is compliant with the requirements of this section.

Test Engineer(s): Ajaz Khan

Test Date(s): 02/03/16

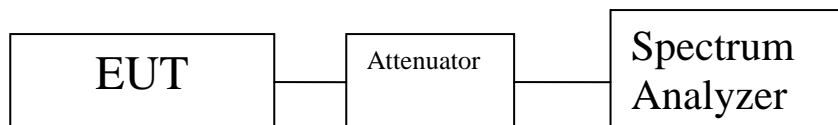

Maximum Power Spectral Density, 802.11a

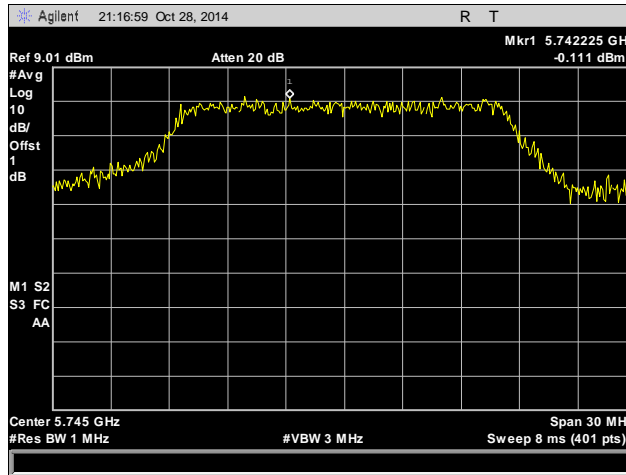

Plot 7. Maximum Power Spectral Density, 802.11a, Low Channel

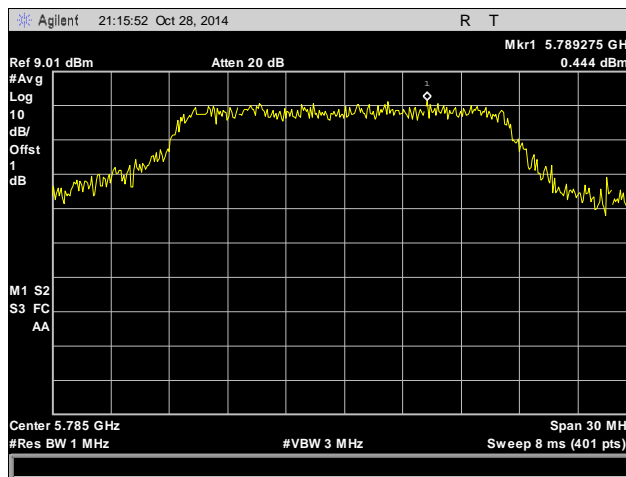

Plot 8. Maximum Power Spectral Density, 802.11a, Mid Channel

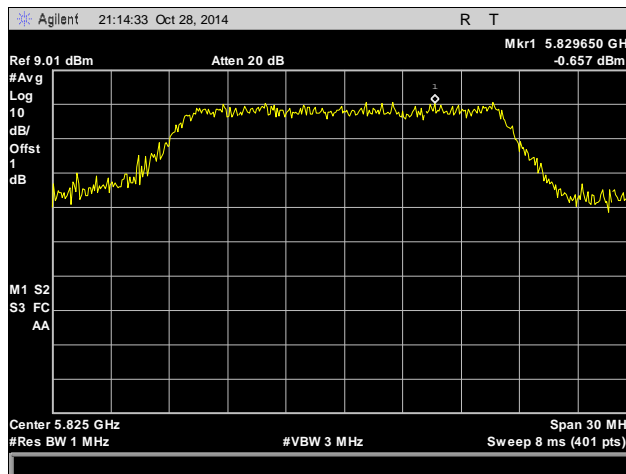

Plot 9. Maximum Power Spectral Density, 802.11a, High Channel

Electromagnetic Compatibility Criteria for Intentional Radiators

§15.407(b)(4) & (6 – 7) Undesirable Emissions

Test Requirements: § 15.407(b)(4): For transmitters operating in the 5.725-5.85 GHz band: All emissions within the frequency range from the band edge to 10 MHz above or below the band edge shall not exceed an e.i.r.p. of -17 dBm/MHz; for frequencies 10 MHz or greater above or below the band edge, emissions shall not exceed an e.i.r.p. of -27 dBm/MHz.

§ 15.407(b)(6): Unwanted emissions below 1 GHz must comply with the general field strength limits set forth in Section 15.209. Further, any U-NII devices using an AC power line are required to comply also with the conducted limits set forth in Section 15.207.

§ 15.407(b)(7): The provisions of Section 15.205 of this part apply to intentional radiators operating under this section.

Test Procedure: The EUT was placed on a non-conducting stand on a turntable in a chamber. To find the maximum emission the EUT was set to transmit on low, mid, and high channels. Additionally, the turntable was rotated 360 degrees, the EUT was oriented through its three orthogonal axes, and the receive antenna height was varied in order to maximize emissions.

For frequencies from 30 MHz to 1 GHz, measurements were first made using a peak detector with a 100 kHz resolution bandwidth. Emissions which exceeded the limits were re-measured using a quasi-peak detector with a 120 kHz resolution bandwidth.

Above 1 GHz, measurements were made pursuant the method described in FCC KDB 789033 D02 General UNII Test Procedure New Rules v01. The equation, $EIRP = E + 20 \log D - 104.8$ was used to convert field strength to EIRP (E = field strength (dB μ V/m) and D = Reference measurement distance). The fundamental frequency was notched out using a notch filter.

For emissions above 1 GHz and in restricted bands, measurements of the field strength were made with a peak detector and an average detector and compared with the limits of 15.209.

As an alternative, according to FCC KDB 789033 D02 General UNII Test Procedure New Rules v01, all emissions above 1 GHz that comply with the peak and average limits of 15.209 satisfy the requirements of unwanted emissions in 15.407.

Test Results: For below 1 GHz, the EUT was compliant with the requirements of this section.

For above 1 GHz, the EUT was compliant with the requirements of this section.

Test Engineer(s): Ajaz Khan

Test Date(s): 02/03/16

Radiated Spurious Emissions, 802.11a

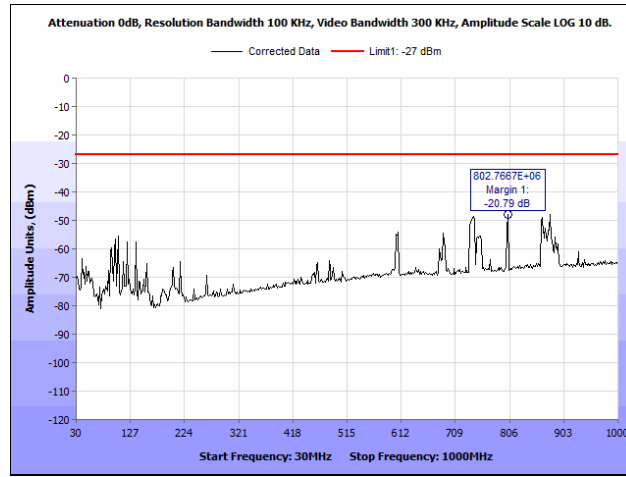

Plot 10. Radiated Spurious Emissions, 802.11a, Low Channel, 30 MHz – 1 GHz

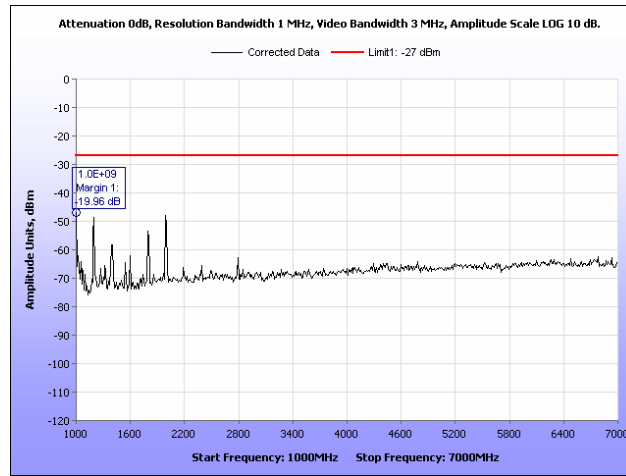

Plot 11. Radiated Spurious Emissions, 802.11a, Low Channel, 1 GHz – 7 GHz, Peak

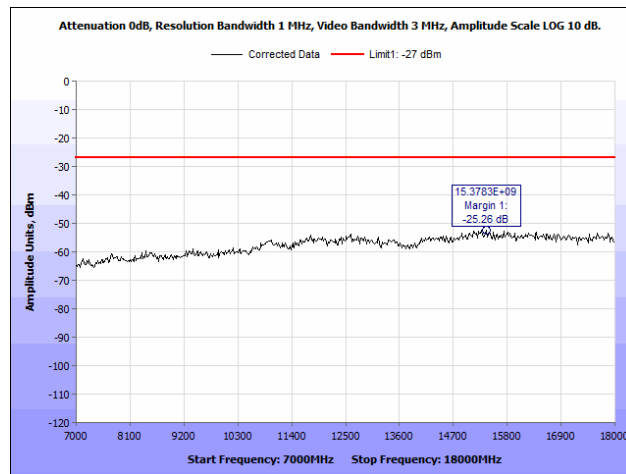

Plot 12. Radiated Spurious Emissions, 802.11a, Low Channel, 7 GHz – 18 GHz, Peak

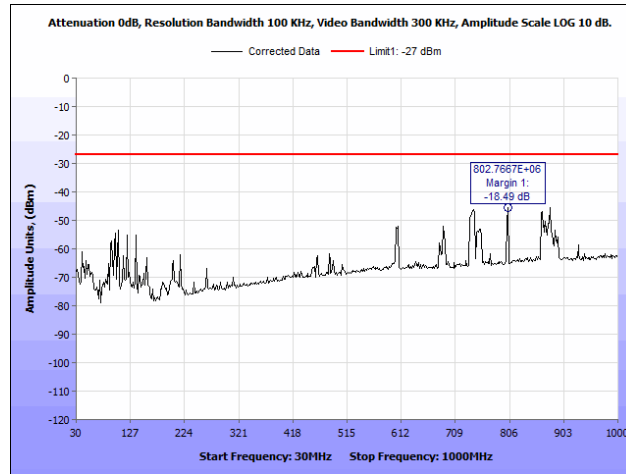

Plot 13. Radiated Spurious Emissions, 802.11a, Mid Channel, 30 MHz – 1 GHz

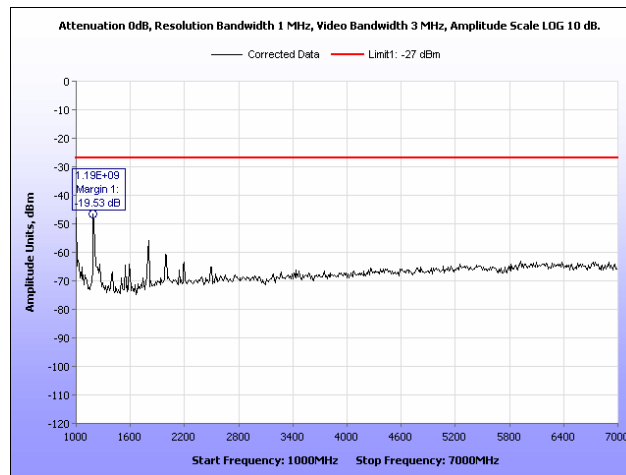

Plot 14. Radiated Spurious Emissions, 802.11a, Mid Channel, 1 GHz – 7 GHz, Peak

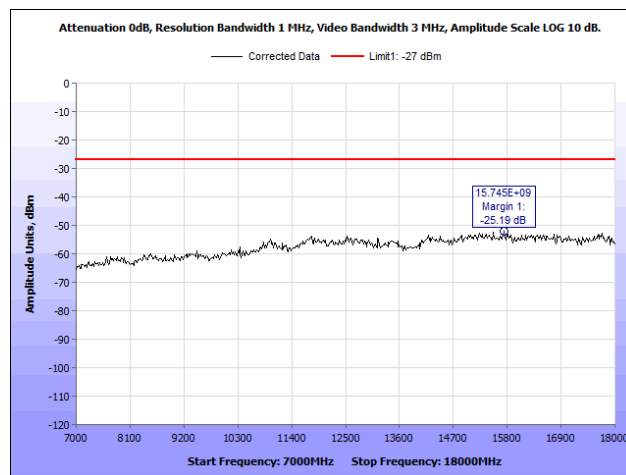

Plot 15. Radiated Spurious Emissions, 802.11a, Mid Channel, 7 GHz – 18 GHz, Peak

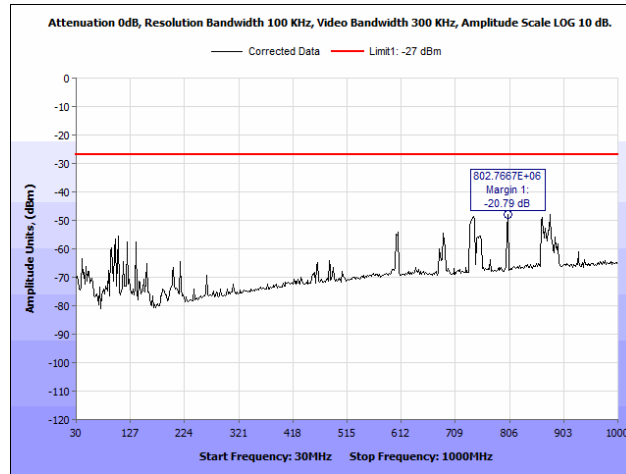

Plot 16. Radiated Spurious Emissions, 802.11a, High Channel, 30 MHz – 1 GHz

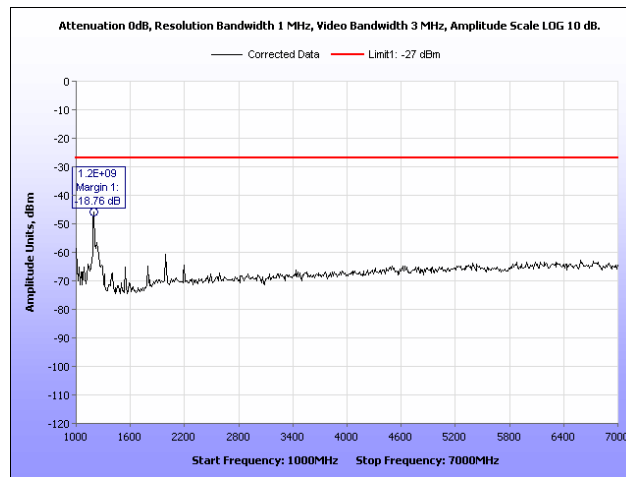

Plot 17. Radiated Spurious Emissions, 802.11a, High Channel, 1 GHz – 7 GHz, Peak

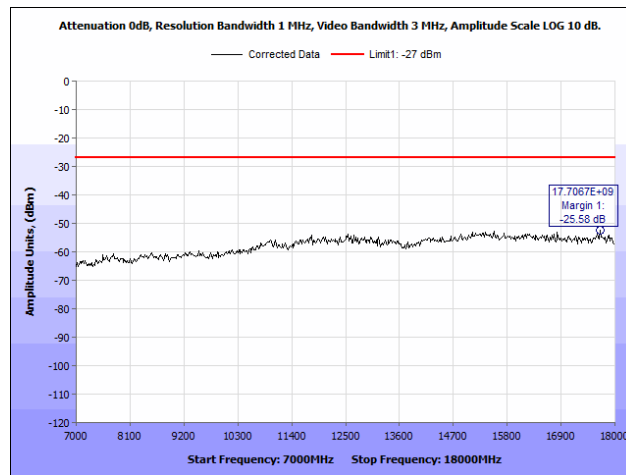

Plot 18. Radiated Spurious Emissions, 802.11a, High Channel, 7 GHz – 18 GHz, Peak

Radiated Band Edge, 802.11a

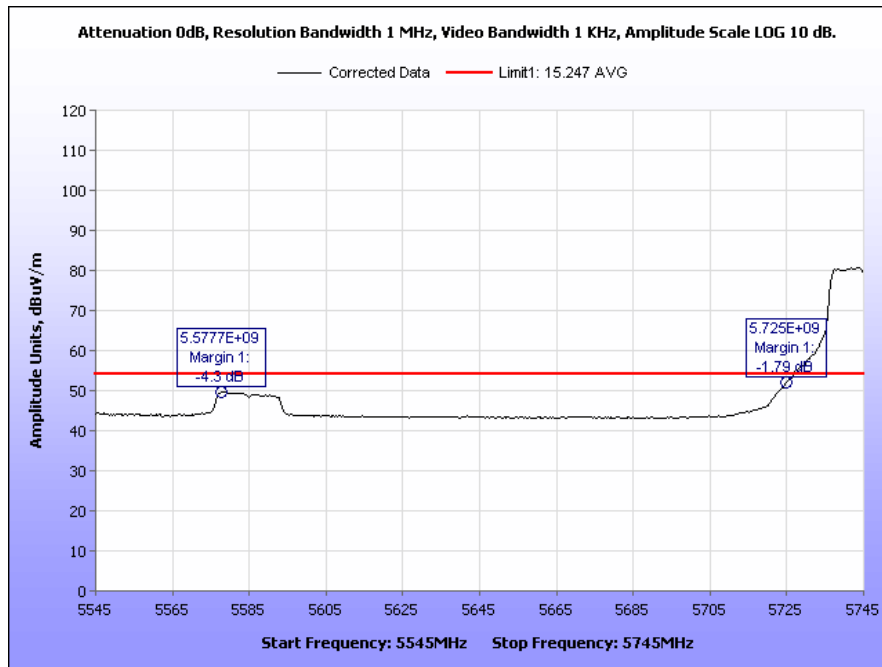

Plot 19. Radiated Band Edge, 802.11a, Low Channel, Average

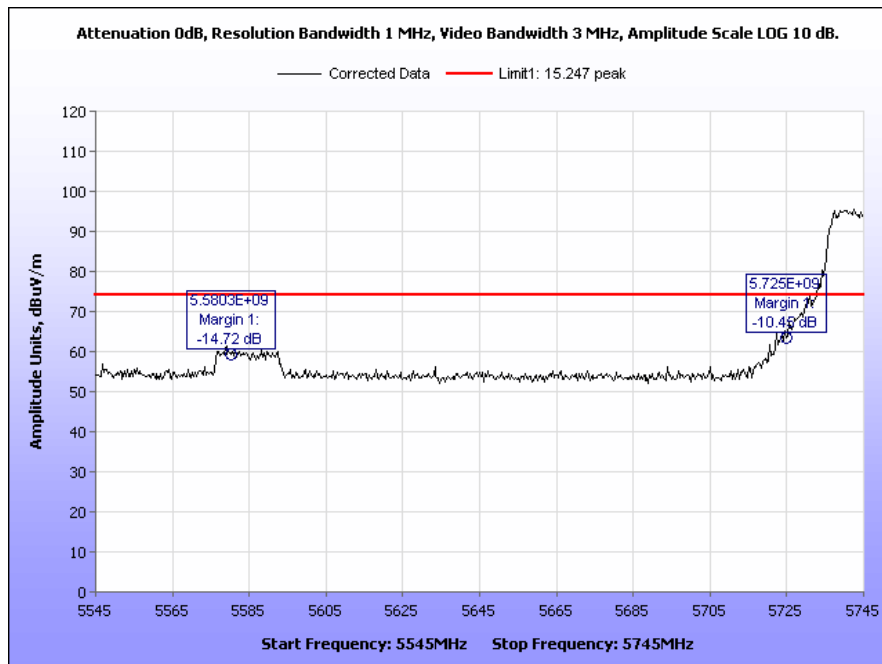

Plot 20. Radiated Band Edge, 802.11a, Low Channel, Peak

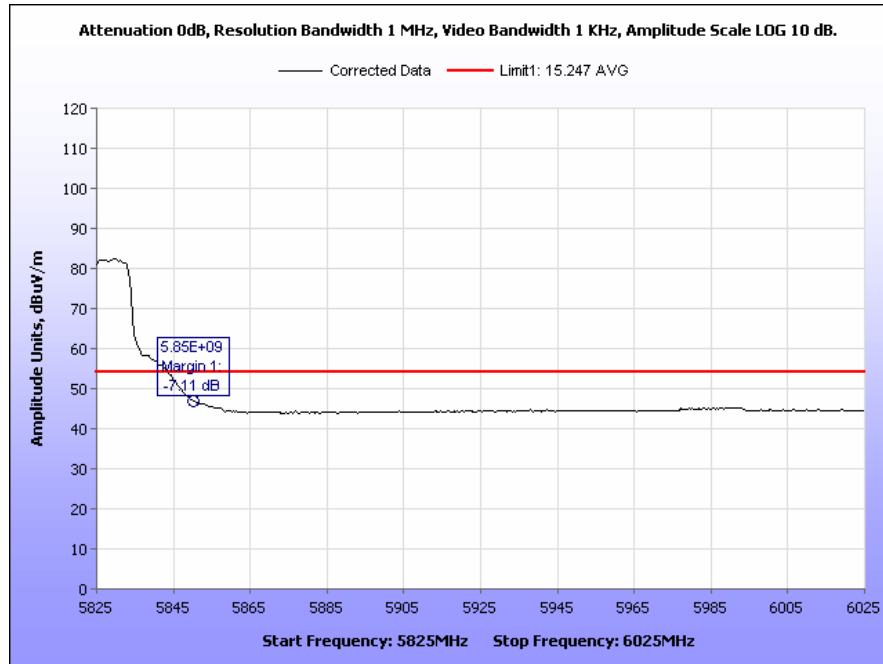

Plot 21. Radiated Band Edge, 802.11a, High Channel, Average

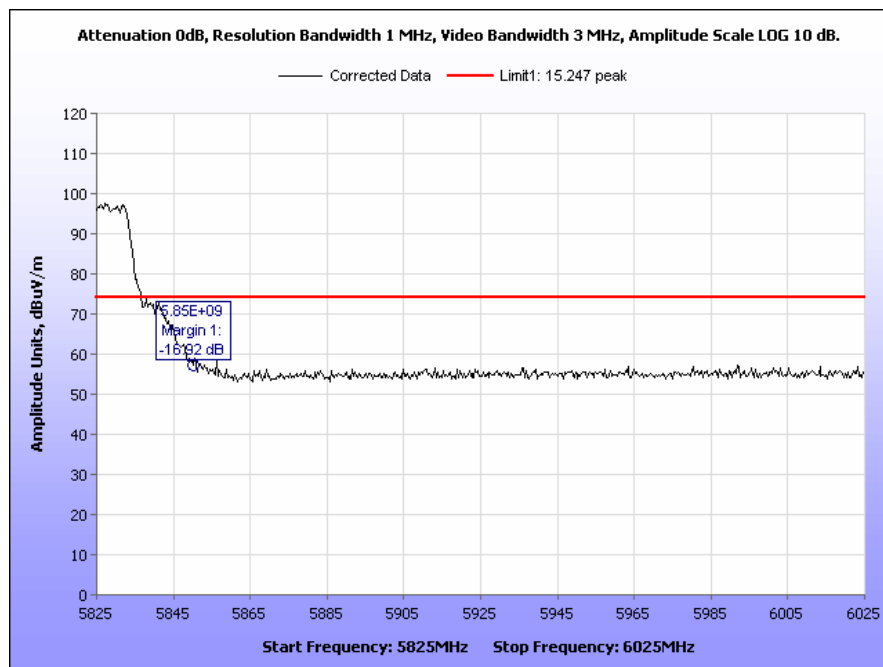

Plot 22. Radiated Band Edge, 802.11a, High Channel, Peak

Electromagnetic Compatibility Criteria for Intentional Radiators

§ 15.407(b)(6) Conducted Emissions

Test Requirement(s): § 15.407 (b)(6): Any U-NII devices using an AC power line are required to comply also with the conducted limits set forth in §15.207.

§ 15.207 (a): For an intentional radiator that is designed to be connected to the public utility (AC) power line, the radio frequency voltage that is conducted back onto the AC power line on any frequency or frequencies, within the band 150 kHz to 30MHz, shall not exceed the limits in the following table, as measured using a 50 μ H/50 Σ line impedance stabilization network (LISN). Compliance with the provisions of this paragraph shall be based on the measurement of the radio frequency voltage between each power line and ground at the power terminal. The lower limit applies at the boundary between the frequency ranges.

Frequency range (MHz)	§ 15.207(a), Conducted Limit (dB μ V)	
	Quasi-Peak	Average
* 0.15- 0.45	66 – 56	56 - 46
0.45 - 0.5	56	46
0.5 - 30	60	50

Table 7. Conducted Limits for Intentional Radiators from FCC Part 15 § 15.207(a)

Test Results: The EUT was not applicable with requirements of this section. The device is battery operated.

Electromagnetic Compatibility Criteria for Intentional Radiators

§ 15.407(e) 6 dB Bandwidth

Test Requirements: § 15.407(e): Within the 5.725-5.85 GHz band, the minimum 6 dB bandwidth of U-NII devices shall be at least 500 kHz.

Test Procedure: The transmitter was set to low, mid, and high operating frequencies at the highest output power and connected to the spectrum analyzer through an attenuator. The bandwidth of the fundamental frequency was measured with the spectrum analyzer using a RBW approximately equal to 1% of the total emission bandwidth, VBW > RBW. The 6 dB Bandwidth was measured and recorded.

Test Results The 6 dB Bandwidth was compliant with the requirements of this section.

Test Engineer(s): Ajaz Khan

Test Date(s): 02/03/16

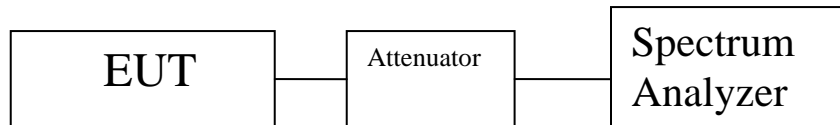

6 dB Bandwidth, 802.11a

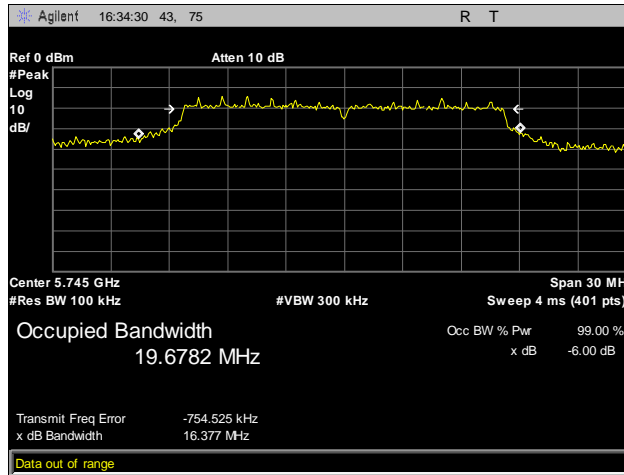

Plot 23. 6 dB Bandwidth, 802.11a, Low Channel

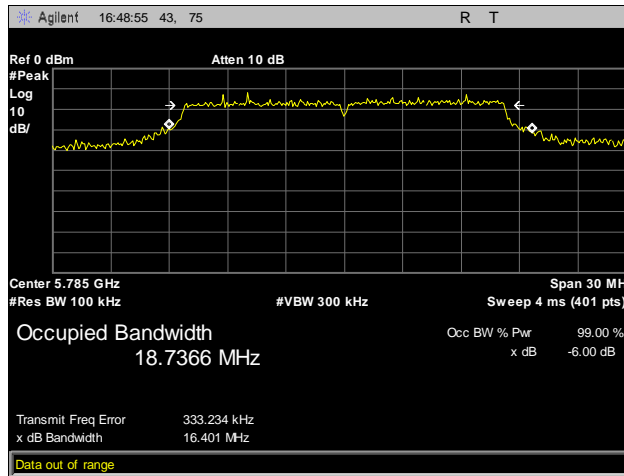

Plot 24. 6 dB Bandwidth, 802.11a, Mid Channel

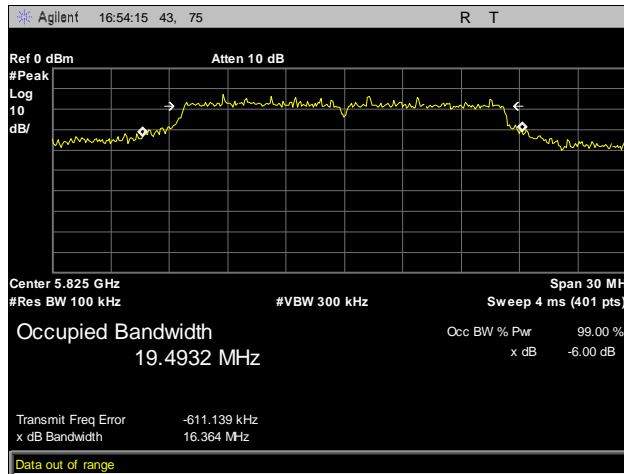

Plot 25. 6 dB Bandwidth, 802.11a, High Channel

Electromagnetic Compatibility Criteria for Intentional Radiators

§ 15.407(f) Maximum Permissible Exposure

- Test Requirement(s):** §15.407(f): U-NII devices are subject to the radio frequency radiation exposure requirements specified in §1.1307(b), §2.1091 and §2.1093 of this chapter, as appropriate. All equipment shall be considered to operate in a “general population/uncontrolled” environment.
- RF Exposure Requirements:** §1.1307(b)(1) and §1.1307(b)(2): Systems operating under the provisions of this section shall be operated in a manner that ensures that the public is not exposed to radio frequency energy levels in excess of the Commission’s guidelines.
- RF Radiation Exposure Limit:** §1.1310: As specified in this section, the Maximum Permissible Exposure (MPE) Limit shall be used to evaluate the environmental impact of human exposure to radiofrequency (RF) radiation as specified in Sec. 1.1307(b), except in the case of portable devices which shall be evaluated according to the provisions of Sec. 2.1093 of this chapter.
- SAR Exclusion:** **KDB 447498 4.3.1(a):** For 100 MHz to 6 GHz and test separation distances ≤ 50 mm, the 1-g and 10-g SAR test exclusion thresholds are determined by the following: $[(\text{max. power of channel, including tune-up tolerance, mW}) / (\text{min. test separation distance, mm})] \cdot [\sqrt{f(\text{GHz})}] \leq 3.0$ for 1-g SAR, and ≤ 7.5 for 10-g extremity SAR, where $f(\text{GHz})$ is the RF channel transmit frequency in GHz. The test exclusions are applicable only when the minimum test separation distance is ≤ 50 mm, and for transmission frequencies between 100 MHz and 6 GHz. When the minimum test separation distance is < 5 mm, a distance of 5 mm according to 4.1 f) is applied to determine SAR test exclusion.
- Test Results:** Since the device is a handheld device, the SAR exclusion criteria was evaluated.

EUT’s operating frequencies @ 5725 - 5850 MHz;
Equation from page 12 of KDB 447498 4.3.1(a) in order for the device to be exempt from SAR,

$$(\text{Max. Power (mW)} / \text{Min. Test separation distance (mm)}) * \sqrt{\text{Frequency (GHz)}} \leq 3$$

Max Output Power was -1.33 dBm (0.736 mW) at 5.825 GHz.

$$(0.736 \text{ mW} / 5 \text{ mm}) * \sqrt{5.825 \text{ GHz}} \leq 3$$

$$0.355 \leq 3$$

Based on this calculation the device is exempt from SAR testing.

IV. Test Equipment

Test Equipment

Calibrated test equipment utilized during testing was maintained in a current state of calibration per the requirements of ISO/IEC 17025:2005.

MET Asset #	Equipment	Manufacturer	Model	Last Cal Date	Cal Due Date
1S2399	TURNTABLE CONTROLLER	SUNOL SCIENCE	SC99V	NOT REQUIRED	
1S2421	EMI TEST RECEIVER	ROHDE & SCHWARZ	ESIB7	12/31/2015	12/31/2016
1S2482	5 METER CHAMBER	PANASHIELD	5 METER SEMI-ANECHOIC CHAMBER	3/12/2015	9/12/2016
1S3826	DRG HORN ANTENNA	ETS-LINDGREN	3117	4/22/2015	4/22/2017
1S2600	BILOG ANTENNA	TESEQ	CBL6112D	10/5/2015	10/5/2016
1S3835	PSA SPECTRUM ANALYZER	AGILENT TECHNOLOGIES	E4448A	11/20/2015	11/20/2017
1S2607	SPECTRUM ANALYZER ESA-E	AGILENT/HEWLETT PACKARD	E4407B	9/11/2014	3/11/2016
1S2121	PRE-AMPLIFIER	HEWLETT PACKARD	8449B	SEE NOTE	

Table 8. Test Equipment List

Note: Functionally tested equipment is verified using calibrated instrumentation at the time of testing.

V. Certification & User's Manual Information

Certification & User's Manual Information

K. Certification Information

The following is extracted from Title 47 of the Code of Federal Regulations, Part 2, Subpart I — Marketing of Radio frequency devices:

§ 2.801 Radio-frequency device defined.

As used in this part, a radio-frequency device is any device which in its operation is capable of Emitting radio-frequency energy by radiation, conduction, or other means. Radio- frequency devices include, but are not limited to:

- (a) The various types of radio communication transmitting devices described throughout this chapter.
- (b) *The incidental, unintentional and intentional radiators defined in Part 15 of this chapter.*
- (c) The industrial, scientific, and medical equipment described in Part 18 of this chapter.
- (d) Any part or component thereof which in use emits radio-frequency energy by radiation, conduction, or other means.

§ 2.803 Marketing of radio frequency devices prior to equipment authorization.

- (a) Except as provided elsewhere in this chapter, no person shall sell or lease, or offer for sale or lease (including advertising for sale or lease), or import, ship or distribute for the purpose of selling or leasing or offering for sale or lease, any radio frequency device unless:
 - (1) In the case of a device subject to certification, such device has been authorized by the Commission in accordance with the rules in this chapter and is properly identified and labeled as required by §2.925 and other relevant sections in this chapter; or
 - (2) In the case of a device that is not required to have a grant of equipment authorization issued by the Commission, but which must comply with the specified technical standards prior to use, such device also complies with all applicable administrative (including verification of the equipment or authorization under a Declaration of Conformity, where required), technical, labeling and identification requirements specified in this chapter.
- (d) Notwithstanding the provisions of paragraph (a) of this section, the offer for sale solely to business, commercial, industrial, scientific or medical users (but not an offer for sale to other parties or to end users located in a residential environment) of a radio frequency device that is in the conceptual, developmental, design or pre-production stage is permitted prior to equipment authorization or, for devices not subject to the equipment authorization requirements, prior to a determination of compliance with the applicable technical requirements *provided* that the prospective buyer is advised in writing at the time of the offer for sale that the equipment is subject to the FCC rules and that the equipment will comply with the appropriate rules before delivery to the buyer or to centers of distribution.

- (e)(1) Notwithstanding the provisions of paragraph (a) of this section, prior to equipment authorization or determination of compliance with the applicable technical requirements any radio frequency device may be operated, but not marketed, for the following purposes and under the following conditions:
- (i) *Compliance testing;*
 - (ii) Demonstrations at a trade show provided the notice contained in paragraph (c) of this section is displayed in a conspicuous location on, or immediately adjacent to, the device;
 - (iii) Demonstrations at an exhibition conducted at a business, commercial, industrial, scientific or medical location, but excluding locations in a residential environment, provided the notice contained in paragraphs (c) or (d) of this section, as appropriate, is displayed in a conspicuous location on, or immediately adjacent to, the device;
 - (iv) Evaluation of product performance and determination of customer acceptability, provided such operation takes place at the manufacturer's facilities during developmental, design or pre-production states; or
 - (v) Evaluation of product performance and determination of customer acceptability where customer acceptability of a radio frequency device cannot be determined at the manufacturer's facilities because of size or unique capability of the device, provided the device is operated at a business, commercial, industrial, scientific or medical user's site, but not at a residential site, during the development, design or pre-production stages.
- (e)(2) For the purpose of paragraphs (e)(1)(iv) and (e)(1)(v) of this section, the term *manufacturer's facilities* includes the facilities of the party responsible for compliance with the regulations and the manufacturer's premises, as well as the facilities of other entities working under the authorization of the responsible party in connection with the development and manufacture, but not the marketing, of the equipment.
- (f) For radio frequency devices subject to verification and sold solely to business, commercial, industrial, scientific and medical users (excluding products sold to other parties or for operation in a residential environment), parties responsible for verification of the devices shall have the option of ensuring compliance with the applicable technical specifications of this chapter at each end user's location after installation, provided that the purchase or lease agreement includes a proviso that such a determination of compliance be made and is the responsibility of the party responsible for verification of the equipment.

Certification & User's Manual Information

The following is extracted from Title 47 of the Code of Federal Regulations, Part 2, Subpart J — Equipment Authorization Procedures:

§ 2.901 Basis and Purpose

- (a) In order to carry out its responsibilities under the Communications Act and the various treaties and international regulations, and in order to promote efficient use of the radio spectrum, the Commission has developed technical standards for radio frequency equipment and parts or components thereof. The technical standards applicable to individual types of equipment are found in that part of the rules governing the service wherein the equipment is to be operated.¹ *In addition to the technical standards provided, the rules governing the service may require that such equipment be verified by the manufacturer or importer, be authorized under a Declaration of Conformity, or receive an equipment authorization from the Commission by one of the following procedures: certification or registration.*
- (b) The following sections describe the verification procedure, the procedure for a Declaration of Conformity, and the procedures to be followed in obtaining certification from the Commission and the conditions attendant to such a grant.

§ 2.907 Certification.

- (a) Certification is an equipment authorization issued by the Commission, based on representation and test data submitted by the applicant.
- (b) Certification attaches to all units subsequently marketed by the grantee which are identical (see Section 2.908) to the sample tested except for permissive changes or other variations authorized by the Commission pursuant to Section 2.1043.

¹ In this case, the equipment is subject to the rules of Part 15. More specifically, the equipment falls under Subpart B (of Part 15), which deals with unintentional radiators.

Certification & User's Manual Information

§ 2.948 Description of measurement facilities.

- (a) Each party making measurements of equipment that is subject to an equipment authorization under Part 15 or Part 18 of this chapter, regardless of whether the measurements are filed with the Commission or kept on file by the party responsible for compliance of equipment marketed within the U.S. or its possessions, shall compile a description of the measurement facilities employed.
- (1) If the measured equipment is subject to the verification procedure, the description of the measurement facilities shall be retained by the party responsible for verification of the equipment.
- (i) *If the equipment is verified through measurements performed by an independent laboratory, it is acceptable for the party responsible for verification of the equipment to rely upon the description of the measurement facilities retained by or placed on file with the Commission by that laboratory. In this situation, the party responsible for the verification of the equipment is not required to retain a duplicate copy of the description of the measurement facilities.*
- (ii) If the equipment is verified based on measurements performed at the installation site of the equipment, no specific site calibration data is required. It is acceptable to retain the description of the measurement facilities at the site at which the measurements were performed.
- (2) If the equipment is to be authorized by the Commission under the certification procedure, the description of the measurement facilities shall be filed with the Commission's Laboratory in Columbia, Maryland. The data describing the measurement facilities need only be filed once but must be updated as changes are made to the measurement facilities or as otherwise described in this section. At least every three years, the organization responsible for filing the data with the Commission shall certify that the data on file is current.

Certification & User's Manual Information

Label and User's Manual Information

The following is extracted from Title 47 of the Code of Federal Regulations, Part 15, Subpart A — General:

§ 15.19 Labeling requirements.

(a) *In addition to the requirements in Part 2 of this chapter, a device subject to certification or verification shall be labeled as follows:*

- (1) Receivers associated with the operation of a licensed radio service, e.g., FM broadcast under Part 73 of this chapter, land mobile operation under Part 90, etc., shall bear the following statement in a conspicuous location on the device:

This device complies with Part 15 of the FCC Rules. Operation is subject to the condition that this device does not cause harmful interference.

- (2) A stand-alone cable input selector switch, shall bear the following statement in a conspicuous location on the device:

This device is verified to comply with Part 15 of the FCC Rules for use with cable television service.

- (3) All other devices shall bear the following statement in a conspicuous location on the device:

This device complies with Part 15 of the FCC Rules. Operation is subject to the following two conditions: (1) This device may not cause harmful interference, and (2) this device must accept any interference received, including interference that may cause undesired operation.

- (4) Where a device is constructed in two or more sections connected by wires and marketed together, the statement specified under paragraph (a) of this section is required to be affixed only to the main control unit.

- (5) When the device is so small or for such use that it is not practicable to place the statement specified under paragraph (a) of this section on it, the information required by this paragraph shall be placed in a prominent location in the instruction manual or pamphlet supplied to the user or, alternatively, shall be placed on the container in which the device is marketed. However, the FCC identifier or the unique identifier, as appropriate, must be displayed on the device.

§ 15.21 Information to user.

The users manual or instruction manual for an intentional or unintentional radiator shall caution the user that changes or modifications not expressly approved by the party responsible for compliance could void the user's authority to operate the equipment.

Verification & User's Manual Information

The following is extracted from Title 47 of the Code of Federal Regulations, Part 15, Subpart B — Unintentional Radiators:

§ 15.105 Information to the user.

- (a) For a Class A digital device or peripheral, the instructions furnished the user shall include the following or similar statement, placed in a prominent location in the text of the manual:

Note: This equipment has been tested and found to comply with the limits for a Class A digital device, pursuant to Part 15 of the FCC Rules. These limits are designed to provide reasonable protection against harmful interference when the equipment is operated in a commercial environment. This equipment generates, uses, and can radiate radio frequency energy and, if not installed and used in accordance with the instruction manual, may cause harmful interference to radio communications. Operation of this equipment in a residential area is likely to cause harmful interference in which case the user will be required to correct the interference at own expense.

- (b) For a Class B digital device or peripheral, the instructions furnished the user shall include the following or similar statement, placed in a prominent location in the text of the manual:

Note: This equipment has been tested and found to comply with the limits for a Class B digital device, pursuant to Part 15 of the FCC Rules. These limits are designed to provide reasonable protection against harmful interference when the equipment is operated in a residential environment. This equipment generates, uses, and can radiate radio frequency energy and, if not installed and used in accordance with the instruction manual, may cause harmful interference to radio communications. However, there is no guarantee that interference will not occur in a particular installation. If this equipment does cause harmful interference to radio or television reception, which can be determined by turning the equipment off and on, the user is encouraged to try to correct the interference by one or more of the following measures:

- Reorient or relocate the receiving antenna.
- Increase the separation between the equipment and receiver.
- Connect the equipment into an outlet on a circuit different from that to which the receiver is connected.
- Consult the dealer or an experienced radio/TV technician for help.

End of Report