



MET Laboratories, Inc. *Safety Certification - EMI - Telecom Environmental Simulation*

914 WEST PATAPSCO AVENUE • BALTIMORE, MARYLAND 21230-3432 • PHONE (410) 354-3300 • FAX (410) 354-3313
33439 WESTERN AVENUE • UNION CITY, CALIFORNIA 94587 • PHONE (510) 489-6300 • FAX (510) 489-6372
3162 BELICK STREET • SANTA CLARA, CALIFORNIA 95054 • PHONE (408) 748-3585 • FAX (510) 489-6372
13501 MCCALLEN PASS • AUSTIN, TX 78753 • PHONE (512) 287-2500 • FAX (512) 287-2513

September 28, 2016

SMK Electronics Corporation, Japan
5-5, Togoshi 6-chome
Shinagawa-ku, Tokyo 142-8511

Dear Paul Coffey,

Enclosed is the EMC Wireless test report for compliance testing of the SMK Electronics Corporation, Japan, RC-GR4 as tested to the requirements of Title 47 of the CFR, Ch. 1 (10-1-06 ed.), Title 47 of the CFR, Part 15.407, Subpart E (UNII 3).

Thank you for using the services of MET Laboratories, Inc. If you have any questions regarding these results or if MET can be of further service to you, please feel free to contact me.

Sincerely yours,
MET LABORATORIES, INC.

Jennifer Warnell
Documentation Department

Reference: (\SMK Electronics Corporation, Japan\EMCS91178B-FCC407 UNII 3 Rev. 2)

Certificates and reports shall not be reproduced except in full, without the written permission of MET Laboratories, Inc.



MET Laboratories, Inc. *Safety Certification - EMI - Telecom Environmental Simulation*

914 WEST PATAPSCO AVENUE • BALTIMORE, MARYLAND 21230-3432 • PHONE (410) 354-3300 • FAX (410) 354-3313

33439 WESTERN AVENUE • UNION CITY, CALIFORNIA 94587 • PHONE (510) 489-6300 • FAX (510) 489-6372

3162 BELICK STREET • SANTA CLARA, CALIFORNIA 95054 • PHONE (408) 748-3585 • FAX (510) 489-6372

13501 MCCALLEN PASS • AUSTIN, TX 78753 • PHONE (512) 287-2500 • FAX (512) 287-2513

**Electromagnetic Compatibility Criteria
Test Report**

for the

**SMK Electronics Corporation, Japan
Model RC-GR4**

Tested under
The FCC Certification Rules
contained in
Title 47 of the CFR
15.407 Subpart E

MET Report: EMCS91178B-FCC407 UNII 3 Rev. 2

September 28, 2016

Prepared For:

**SMK Electronics Corporation, Japan
5-5, Togoshi 6-chome
Shinagawa-ku, Tokyo 142-8511**

Prepared By:
MET Laboratories, Inc.
914 W. Patapsco Ave.
Baltimore, MD 21230

Electromagnetic Compatibility Criteria Test Report

for the

**SMK Electronics Corporation, Japan
Model RC-GR4**

Tested under

The FCC Certification Rules
contained in
Title 47 of the CFR
15.407 Subpart E



Kaushani Dasgupta
Project Engineer, Electromagnetic Compatibility Lab



Jennifer Warnell
Documentation Department

Engineering Statement: The measurements shown in this report were made in accordance with the procedures indicated, and the emissions from this equipment were found to be within the limits applicable. I assume full responsibility for the accuracy and completeness of these measurements, and for the qualifications of all persons taking them. It is further stated that upon the basis of the measurements made, the equipment tested is capable of operation in accordance with the requirements of Parts 15B, 15.407, of the FCC Rules under normal use and maintenance.



Asad Bajwa,
Director, Electromagnetic Compatibility Lab

Report Status Sheet

Revision	Report Date	Reason for Revision
∅	July 5, 2016	Initial Issue.
1	August 23, 2016	Editorial corrections.
2	September 28, 2016	Engineer corrections.

Table of Contents

I.	Executive Summary	1
	A. Purpose of Test	2
	B. Executive Summary	2
II.	Equipment Configuration	3
	A. Overview.....	4
	B. References.....	5
	C. Test Site	5
	D. Description of Test Sample.....	5
	E. Equipment Configuration.....	6
	F. Support Equipment	6
	G. Mode of Operation.....	6
	H. Method of Monitoring EUT Operation	6
	I. Modifications	6
	a) Modifications to EUT	6
	b) Modifications to Test Standard	6
	J. Disposition of EUT	6
III.	Electromagnetic Compatibility Criteria for Intentional Radiators.....	7
	§ 15.203 Antenna Requirement	8
	§ 15.403(i) 26 dB Bandwidth	9
	§ 15.407(a)(3) Maximum Conducted Output Power	11
	§ 15.407(a)(3) Maximum Power Spectral Density	13
	§ 15.407(b)(4) & (6 - 7) Undesirable Emissions	15
	§ 15.407(b)(6) Conducted Emissions	22
	§ 15.407(f) RF Exposure	23
	§ 15.407(g) Frequency Stability	24
IV.	Test Equipment	29
V.	Certification & User's Manual Information.....	31
	A. Certification Information	32
	B. Label and User's Manual Information	36

List of Tables

Table 1.	Executive Summary of EMC Part 15.407 Compliance Testing	2
Table 2.	EUT Summary.....	4
Table 3.	References	5
Table 4.	Equipment Configuration	6
Table 5.	Support Equipment.....	6
Table 5.	Conducted Limits for Intentional Radiators from FCC Part 15 § 15.207(a)	22
Table 6.	Test Equipment List	30

List of Plots

Plot 1. Occupied Bandwidth, Low Channel, 5745 MHz, 802.11a.....	10
Plot 2. Occupied Bandwidth, Mid Channel, 5785 MHz, 802.11a	10
Plot 3. Occupied Bandwidth, High Channel, 5825 MHz, 802.11a.....	10
Plot 4. Peak Power Output, Low Channel, 5745 MHz, 802.11a	12
Plot 5. Peak Power Output, Mid Channel, 5785 MHz, 802.11a	12
Plot 6. Peak Power Output, High Channel, 5825 MHz, 802.11a.....	12
Plot 7. Peak Power Spectral Density, Low Channel, 5745 MHz, 802.11a.....	14
Plot 8. Peak Power Spectral Density, Mid Channel, 5785 MHz, 802.11a.....	14
Plot 9. Peak Power Spectral Density, High Channel, 5825 MHz, 802.11a	14
Plot 10. Radiated Spurious Emissions, Low Channel, 5745 MHz, 802.11a, 30 MHz – 1 GHz, Average.....	16
Plot 11. Radiated Spurious Emissions, Low Channel, 5745 MHz, 802.11a, 1 GHz – 7 GHz, Peak under Avg. Limit	16
Plot 12. Radiated Spurious Emissions, Low Channel, 5745 MHz, 802.11a, 7 GHz – 18 GHz, Average	16
Plot 13. Radiated Spurious Emissions, Low Channel, 5745 MHz, 802.11a, 7 GHz – 18 GHz, Peak	17
Plot 14. Radiated Spurious Emissions, Mid Channel, 5785 MHz, 802.11a, 30 MHz – 1 GHz, Average	17
Plot 15. Radiated Spurious Emissions, Mid Channel, 5785 MHz, 802.11a, 30 MHz – 1 GHz, Peak	17
Plot 16. Radiated Spurious Emissions, Mid Channel, 5785 MHz, 802.11a, 1 GHz – 7 GHz, Peak under Avg. Limit	18
Plot 17. Radiated Spurious Emissions, Mid Channel, 5785 MHz, 802.11a, 7 GHz – 18 GHz, Peak.....	18
Plot 18. Radiated Spurious Emissions, High Channel, 5825 MHz, 802.11a, 30 MHz – 1 GHz, Average	18
Plot 19. Radiated Spurious Emissions, High Channel, 5825 MHz, 802.11a, 1 GHz – 7 GHz, Peak under Avg. Limit.....	19
Plot 20. Radiated Spurious Emissions, High Channel, 5825 MHz, 802.11a, 7 GHz – 18 GHz, Average.....	19
Plot 21. Radiated Spurious Emissions, High Channel, 5825 MHz, 802.11a, 7 GHz – 18 GHz, Peak	19
Plot 22. Radiated Band Edge, 802.11a, 5745 MHz, Low Channel, Average @ 5725 & 5715	20
Plot 23. Radiated Band Edge, 802.11a, 5745 MHz, Low Channel, Average @ Band Edge 5725 MHz & 5715 MHz.....	20
Plot 24. Radiated Band Edge, 802.11a, 5745 MHz, Low Channel, Peak @ Band Edge 5725 MHz & 5715 MHz	21
Plot 25. Radiated Band Edge, 802.11a, 5825 MHz, High Channel, Average @ Band Edge 5835 MHz	21
Plot 26. Radiated Band Edge, 802.11a, 5825 MHz, High Channel, Peak @ Band Edge 5835 MHz	21
Plot 27. Frequency Stability, 5725-5850 MHz, -30°C, 120°C	25
Plot 28. Frequency Stability, 5725-5850 MHz, -20°C, 120°C	25
Plot 29. Frequency Stability, 5725-5850 MHz, -10°C, 120°C	25
Plot 30. Frequency Stability, 5725-5850 MHz, 0°C, 120°C	26
Plot 31. Frequency Stability, 5725-5850 MHz, 10°C, 120°C	26
Plot 32. Frequency Stability, 5725-5850 MHz, 20°C, 120°C	26
Plot 33. Frequency Stability, 5725-5850 MHz, 30°C, 120°C	27
Plot 34. Frequency Stability, 5725-5850 MHz, 40°C, 120°C	27
Plot 35. Frequency Stability, 5725-5850 MHz, 50°C, 120°C	27
Plot 36. Frequency Stability, 5725-5850 MHz, 55°C, 120°C	28

List of Terms and Abbreviations

AC	Alternating Current
ACF	Antenna Correction Factor
Cal	Calibration
<i>d</i>	Measurement Distance
dB	Decibels
dB μ A	Decibels above one microamp
dB μ V	Decibels above one microvolt
dB μ A/m	Decibels above one microamp per meter
dB μ V/m	Decibels above one microvolt per meter
DC	Direct Current
E	Electric Field
DSL	Digital Subscriber Line
ESD	Electrostatic Discharge
EUT	Equipment Under Test
<i>f</i>	Frequency
FCC	Federal Communications Commission
GRP	Ground Reference Plane
H	Magnetic Field
HCP	Horizontal Coupling Plane
Hz	Hertz
IEC	International Electrotechnical Commission
kHz	Kilohertz
kPa	Kilopascal
kV	Kilovolt
LISN	Line Impedance Stabilization Network
MHz	Megahertz
μ H	Microhenry
μ	Microfarad
μ s	Microseconds
PRF	Pulse Repetition Frequency
RF	Radio Frequency
RMS	Root-Mean-Square
TWT	Traveling Wave Tube
V/m	Volts per meter
VCP	Vertical Coupling Plane

I. Executive Summary

A. Purpose of Test

An EMC evaluation was performed to determine compliance of the SMK Electronics Corporation, Japan RC-GR4, with the requirements of Part 15, §15.407. All references are to the most current version of Title 47 of the Code of Federal Regulations in effect. In accordance with §2.1033, the following data is presented in support of the Certification of the RC-GR4. SMK Electronics Corporation, Japan should retain a copy of this document which should be kept on file for at least two years after the manufacturing of the RC-GR4, has been **permanently** discontinued.

B. Executive Summary

The following tests were conducted on a sample of the equipment for the purpose of demonstrating compliance with Part 15, §15.407, in accordance with SMK Electronics Corporation, Japan, purchase order number FC-24724. All tests were conducted using measurement procedure ANSI C63.4-2014.

FCC Reference	Description	Results
§15.203	Antenna Requirement	Compliant
§15.403(i)	26 dB Bandwidth	Compliant
§15.407 (a)(3)	Maximum Conducted Output Power	Compliant
§15.407 (a)(3)	Maximum Power Spectral Density	Compliant
§15.407 (b)(4)& (6 - 7)	Undesirable Emissions	Compliant
§15.407(b)(6)	Conducted Emission Limits	Not Applicable
§15.407(f)	RF Exposure	Compliant
§15.407(g)	Frequency Stability	Compliant

Table 1. Executive Summary of EMC Part 15.407 Compliance Testing

II. Equipment Configuration

A. Overview

MET Laboratories, Inc. was contracted by SMK Electronics Corporation, Japan to perform testing on the RC-GR4, under SMK Electronics Corporation, Japan's purchase order number FC-24724.

This document describes the test setups, test methods, required test equipment, and the test limit criteria used to perform compliance testing of the SMK Electronics Corporation, Japan RC-GR4.

The results obtained relate only to the item(s) tested.

Model(s) Tested:	RC-GR4	
Model(s) Covered:	RC-GR4	
EUT Specifications:	Primary Power: 3 VDC	
	FCC ID: TC2-RCB12	
	Type of Modulations:	OFDM
	Equipment Code:	NII
	Max. RF Output Power:	-2.72 dBm
	EUT Frequency Ranges:	5745 MHz to 5825 MHz
Analysis:	The results obtained relate only to the item(s) tested.	
Environmental Test Conditions:	Temperature: 15-35° C	
	Relative Humidity: 30-60%	
	Barometric Pressure: 860-1060 mbar	
Evaluated by:	Kaushani Dasgupta	
Report Date(s):	September 28, 2016	

Table 2. EUT Summary

B. References

CFR 47, Part 15, Subpart E	Unlicensed National Information Infrastructure Devices (UNII)
ANSI C63.4:2014	Methods and Measurements of Radio-Noise Emissions from Low-Voltage Electrical And Electronic Equipment in the Range of 9 kHz to 40 GHz
ISO/IEC 17025:2005	General Requirements for the Competence of Testing and Calibration Laboratories
ANSI C63.10-2013	American National Standard for Testing Unlicensed Wireless Devices

Table 3. References

C. Test Site

All testing was performed at MET Laboratories, Inc., 3162 Belick St., Santa Clara, CA 95054. All equipment used in making physical determinations is accurate and bears recent traceability to the National Institute of Standards and Technology.

Radiated Emissions measurements were performed in a 10 meter semi-anechoic chamber (equivalent to an Open Area Test Site). In accordance with §2.948(a)(3), a complete site description is contained at MET Laboratories.

D. Description of Test Sample

The RC-GR4, Equipment Under Test (EUT), is a Remote Control. It will work with Roku set top box. It supports wifi 802.11a/b/g Channel 1 through 11 and Channel 36 -48 and Channel 149 through 165. The remote shall operate from 2 x AA Alkaline batteries. Power requirements shall be a maximum operating voltage of 3.3 Volts. The power will not be regulated.

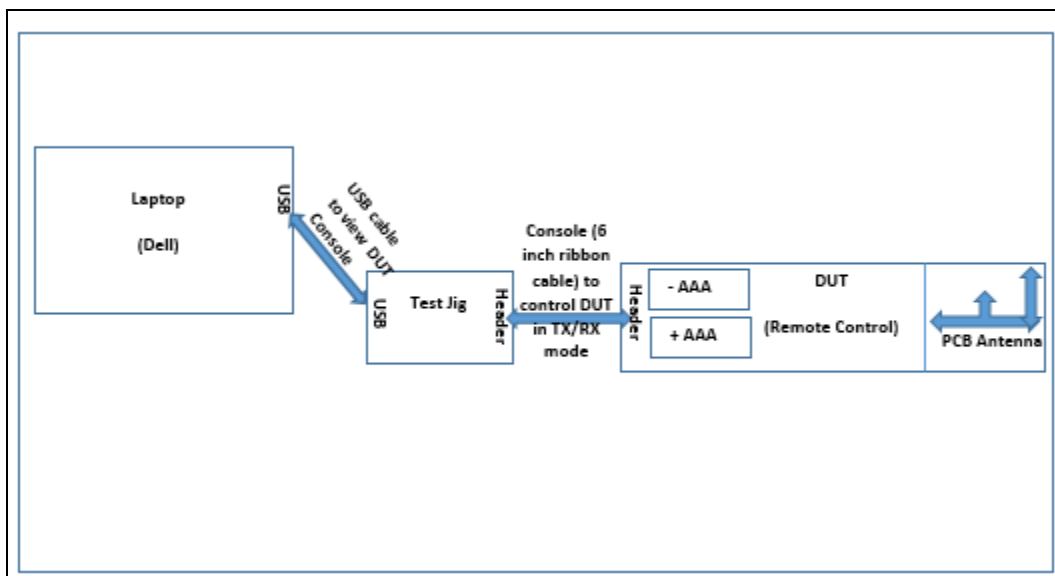

Figure 1. Block Diagram of Test Configuration

Equipment Configuration

Ref. ID	Name / Description	Model Number	Part Number	Serial Number	Revision
1	Roku WiFi Remote Control	RC88	--	--	N/A

Table 4. Equipment Configuration

E. Support Equipment

Support equipment necessary for the operation and testing of the EUT is included in the following list.

Ref. ID	Name / Description	Manufacturer	Model Number
1	Test Jig	--	--
2	Lap top	--	--
3	Ribbon Cable	--	--

Table 5. Support Equipment

F. Mode of Operation

FW is running on the DUT (Remote Control) and through console we can configure DUT into different wifi channels.

G. Method of Monitoring EUT Operation

LED is blinking when Battery is first inserted and Remote is in pairing mode. Once it pairs up with Roku RSS LED will turn ON, and turn off when goes into sleep mode.

H. Modifications

a) Modifications to EUT

No modifications were made to the EUT.

b) Modifications to Test Standard

No modifications were made to the test standard.

I. Disposition of EUT

The test sample including all support equipment submitted to the Electro-Magnetic Compatibility Lab for testing was returned to SMK Electronics Corporation, Japan upon completion of testing.

III. Electromagnetic Compatibility Criteria for Intentional Radiators

Electromagnetic Compatibility Criteria for Intentional Radiators

§ 15.203 Antenna Requirement

Test Requirement: § 15.203: An intentional radiator shall be designed to ensure that no antenna other than that furnished by the responsible party shall be used with the device. The use of a permanently attached antenna or of an antenna that uses a unique coupling to the intentional radiator shall be considered sufficient to comply with the provisions of this section. The manufacturer may design the unit so that a broken antenna can be replaced by the user, but the use of a standard antenna jack or electrical connector is prohibited.

The structure and application of the EUT were analyzed to determine compliance with Section 15.203 of the Rules. Section 15.203 states that the subject device must meet at least one of the following criteria:

- a.) Antenna must be permanently attached to the unit.
- b.) Antenna must use a unique type of connector to attach to the EUT.
- c.) Unit must be professionally installed. Installer shall be responsible for verifying that the correct antenna is employed with the unit.

Results: The EUT as tested is compliant the criteria of §15.203.

Test Engineer(s): Andy Shen

Test Date(s): 10/27/14

Electromagnetic Compatibility Criteria for Intentional Radiators

§ 15.403(i) 26 dB Bandwidth

Test Requirements: § 15.403(i): For purposes of this subpart the emission bandwidth shall be determined by measuring the width of the signal between two points, one below the carrier center frequency and one above the carrier center frequency, that are 26 dB down relative to the maximum level of the modulated carrier. Determination of the emissions bandwidth is based on the use of measurement instrumentation employing a peak detector function with an instrument resolution bandwidth approximately equal to 1.0 percent of the emission bandwidth of the device under measurement.

Test Procedure: The transmitter was set to both operating frequencies at the highest output power and connected to the spectrum analyzer through an attenuator. The bandwidth of the fundamental frequency was measured with the spectrum analyzer using a RBW approximately equal to 1% of the total emission bandwidth, VBW > RBW. The 26 dB Bandwidth was measured and recorded.

Test Results The 26 dB Bandwidth was compliant with the requirements of this section and was determined from the plots on the following pages.

Test Engineer(s): Andy Shen

Test Date(s): 10/28/14

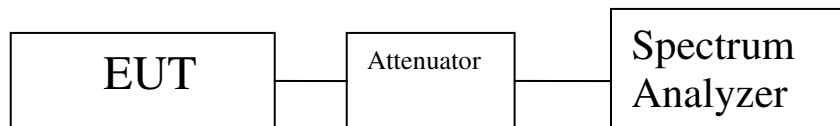

Occupied Bandwidth Test Results, 802.11a

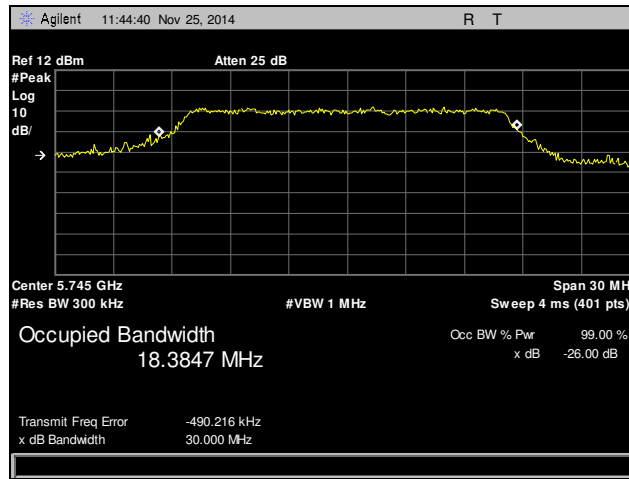

Plot 1. Occupied Bandwidth, Low Channel, 5745 MHz, 802.11a

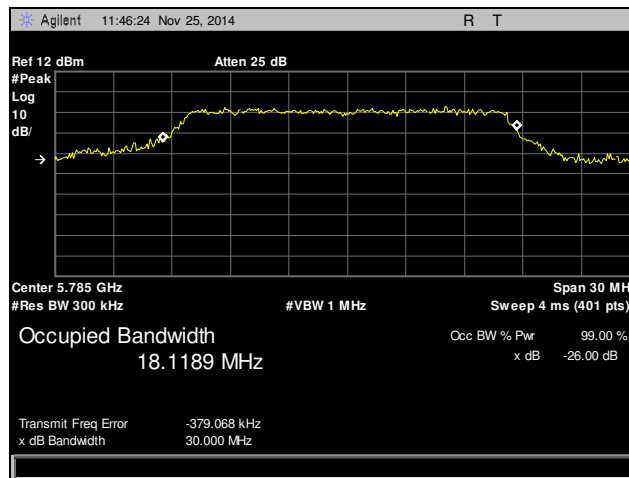

Plot 2. Occupied Bandwidth, Mid Channel, 5785 MHz, 802.11a

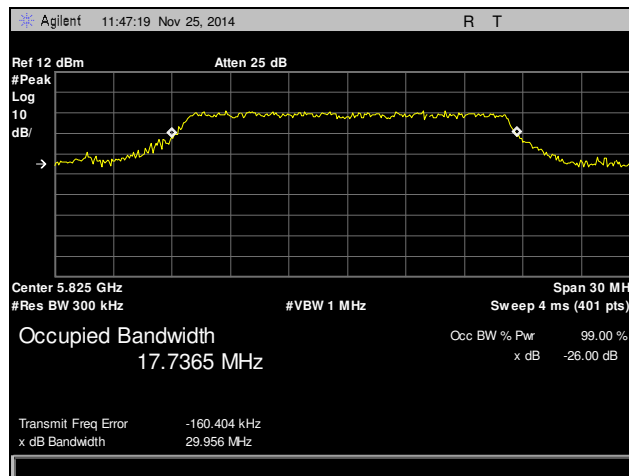

Plot 3. Occupied Bandwidth, High Channel, 5825 MHz, 802.11a

Electromagnetic Compatibility Criteria for Intentional Radiators

§15.407(a)(3) Maximum Conducted Output Power

- Test Requirements:** §15.407(a)(3): For the band 5.725-5.85 GHz, the maximum conducted output power over the frequency band of operation shall not exceed 1 W.
If transmitting antennas of directional gain greater than 6 dBi are used, both the maximum conducted output power and the maximum power spectral density shall be reduced by the amount in dB that the directional gain of the antenna exceeds 6 dBi. However, fixed point-to-point U-NII devices operating in this band may employ transmitting antennas with directional gain greater than 6 dBi without any corresponding reduction in transmitter conducted power.
- Test Procedure:** The EUT was connected to a spectrum analyzer through a cable and attenuator. Measurements were taken with the EUT set to transmit continuously on its low, mid, and high channels. Its power was measured according to measurement method SA-1, as described in 789033 D02 General UNII Test Procedures v01.
- Test Procedure:** The EUT was connected to a spectrum analyzer through a attenuator and set to transmit continuously on the low, mid, and high channels. Its power was measured according to measurement method SA-1, as described in 789033 D01 General UNII Test Procedures v01r02. Plots were corrected for attenuator and cable loss.
- Test Results:** Equipment was compliant with the Peak Power Output limits of § 15.407(a)(1).
- Test Engineer(s):** Andy Shen
- Test Date(s):** 10/28/14

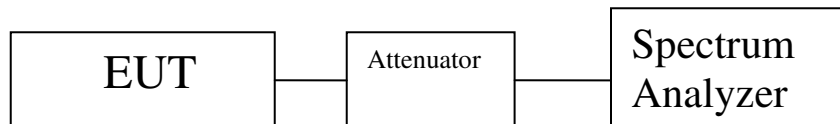

Peak Power Output Test Results, 802.11a

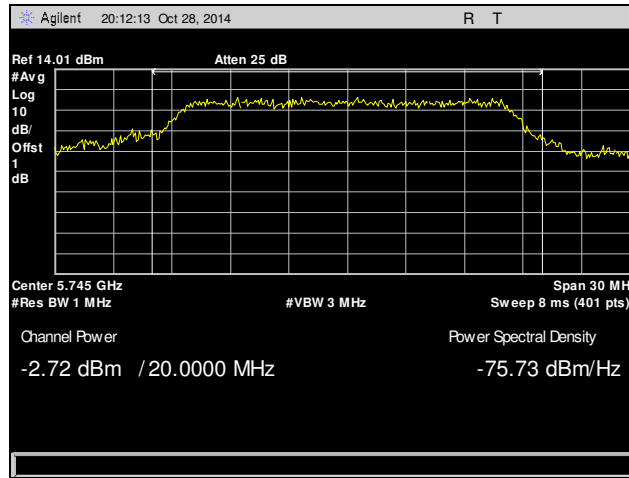

Plot 4. Peak Power Output, Low Channel, 5745 MHz, 802.11a

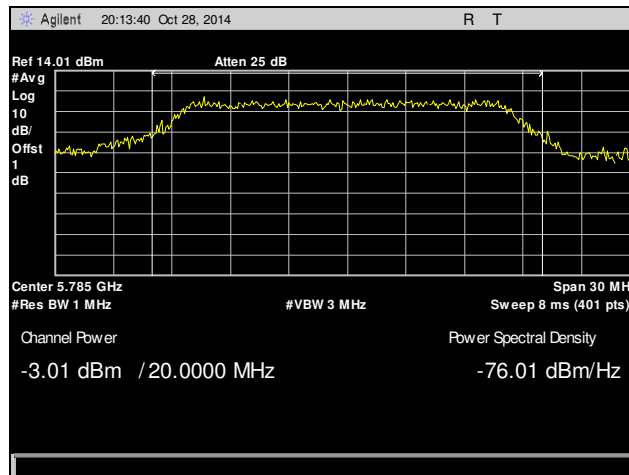

Plot 5. Peak Power Output, Mid Channel, 5785 MHz, 802.11a

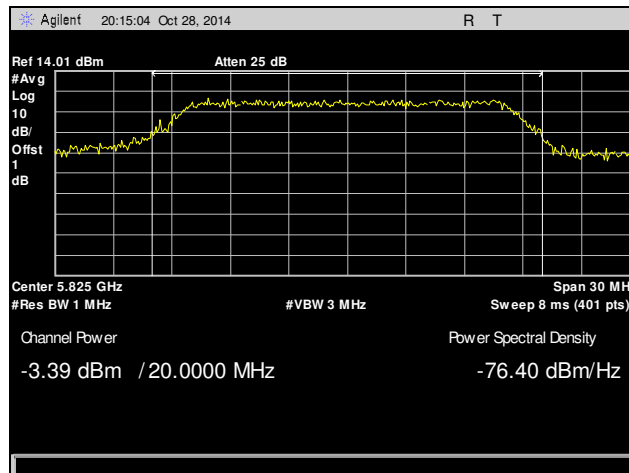

Plot 6. Peak Power Output, High Channel, 5825 MHz, 802.11a

Electromagnetic Compatibility Criteria for Intentional Radiators

§15.407(a)(3) Maximum Power Spectral Density

Test Requirements: §15.407(a)(3): In addition, the maximum power spectral density shall not exceed 30 dBm in any 500-kHz band.

If transmitting antennas of directional gain greater than 6 dBi are used, both the maximum conducted output power and the maximum power spectral density shall be reduced by the amount in dB that the directional gain of the antenna exceeds 6 dBi. However, fixed point-to-point U-NII devices operating in this band may employ transmitting antennas with directional gain greater than 6 dBi without any corresponding reduction in transmitter conducted power.

Test Procedure: The transmitter was connected directly to a Spectrum Analyzer through an attenuator. The power level was set to the maximum level on the EUT. The RBW was set to 1MHz and the VBW was set to 3MHz. The method of measurement used was method SA-1 from 789033 D01 General UNII Test Procedures v01r02. Plots are correct for attenuators and cable loss.

Test Results: Equipment was compliant with the peak power spectral density limits of § 15.407 (a)(1). The peak power spectral density was determined from plots on the following page(s). A 1MHz RBW was used so the corrected PSD after adding the BW correction factor, to factor in the 500kHz vs 1Mhz RBW are given below:
RBW CF= $10\log(1\text{Mhz}/500\text{kHz}) = 3.01$
PSD at 5745MHz = $-0.111 + 3.01 = 3.12 \text{ dBm}$
PSD at 5785MHz = $0.444 + 3.01 = 3.45 \text{ dBm}$
PSD at 5825MHz = $-0.657 + 3.01 = 2.35 \text{ dBm}$

Test Engineer(s): Andy Shen

Test Date(s): 10/30/14

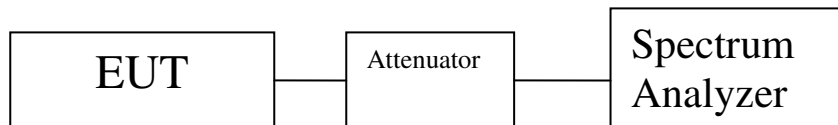

Peak Power Spectral Density, 802.11a

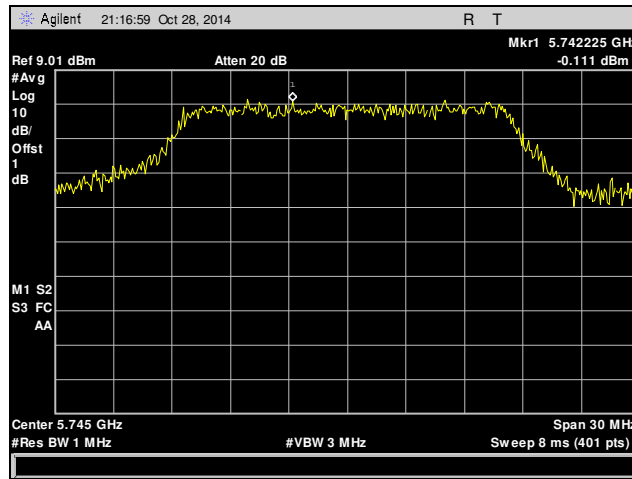

Plot 7. Peak Power Spectral Density, Low Channel, 5745 MHz, 802.11a

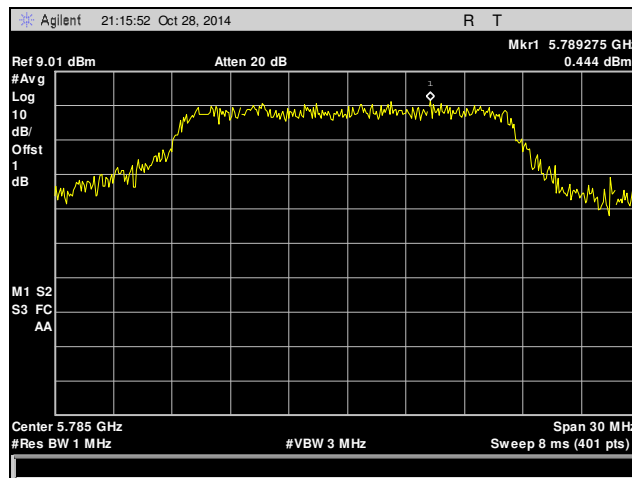

Plot 8. Peak Power Spectral Density, Mid Channel, 5785 MHz, 802.11a

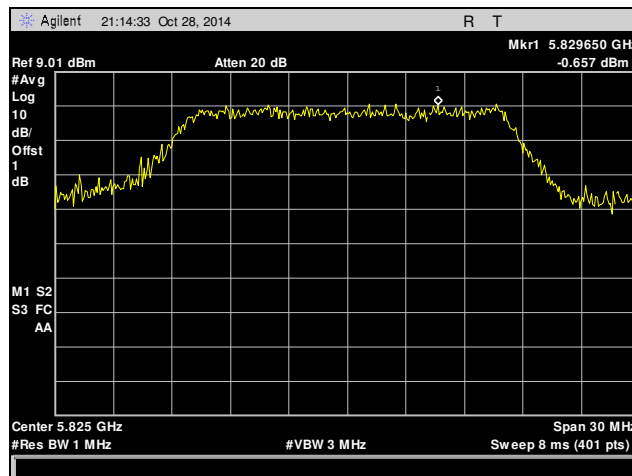

Plot 9. Peak Power Spectral Density, High Channel, 5825 MHz, 802.11a

Electromagnetic Compatibility Criteria for Intentional Radiators

§15.407(b)(4) & (6 – 7) Undesirable Emissions

Test Requirements: § 15.407(b)(4): For transmitters operating in the 5.725-5.85 GHz band: All emissions within the frequency range from the band edge to 10 MHz above or below the band edge shall not exceed an e.i.r.p. of -17 dBm/MHz; for frequencies 10 MHz or greater above or below the band edge, emissions shall not exceed an e.i.r.p. of -27 dBm/MHz.

§ 15.407(b)(6): Unwanted emissions below 1 GHz must comply with the general field strength limits set forth in Section 15.209. Further, any U-NII devices using an AC power line are required to comply also with the conducted limits set forth in Section 15.207.

§ 15.407(b)(7): The provisions of Section 15.205 of this part apply to intentional radiators operating under this section.

Test Procedure: The transmitter was placed on an 80cm wooden table inside in a semi-anechoic chamber. Measurements were performed with the EUT rotated 360 degrees and varying the adjustable antenna mast height to determine worst case orientation for maximum emissions. A preamp was used in the range from 7-18GHz to improve noise floor. Plots were corrected for cable loss, antenna, and preamp gain.

For frequencies from 30 MHz to 1 GHz, measurements were made using a quasi-peak detector with a 120 kHz bandwidth. The procedure was used for average.

For measurements above 1 GHz, measurements were made with a Peak detector with 1 MHz resolution bandwidth. A notch filter was use to filter out the transmitting channel. Where the spurious emissions fell into a restricted band, measurements were also made with an average detector to make sure they complied with 15.209 limits. Only noise floor was seen above 18 GHz hence it was not reported. Worst case emissions shown by antenna. The emissions below 30MHz were 20dB below the limit hence they were not reported.

Test Results: The EUT was compliant with the Radiated Emission limits for Intentional Radiators. See following pages for detailed test results.

Test Engineer(s): Andy Shen

Test Date(s): 10/30/14

Radiated Spurious Emissions Test Results, 802.11a

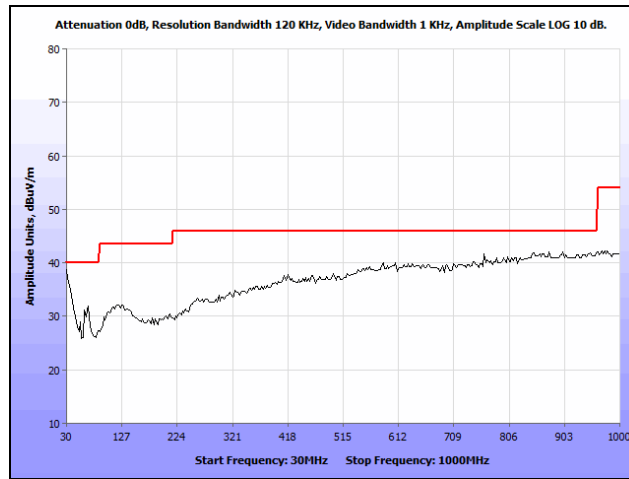

Plot 10. Radiated Spurious Emissions, Low Channel, 5745 MHz, 802.11a, 30 MHz – 1 GHz, Average

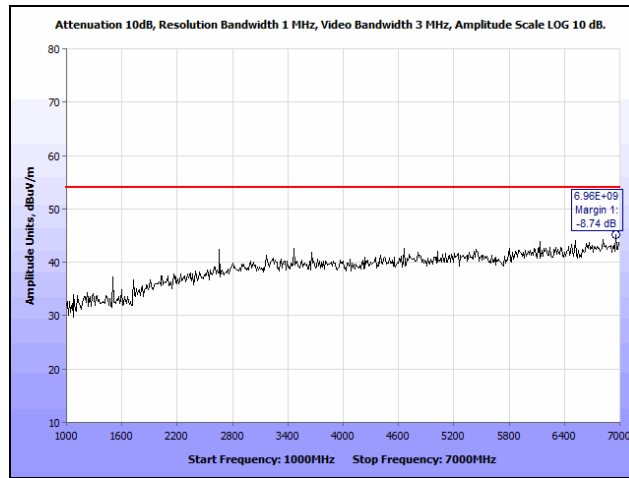

Plot 11. Radiated Spurious Emissions, Low Channel, 5745 MHz, 802.11a, 1 GHz – 7 GHz, Peak under Avg. Limit

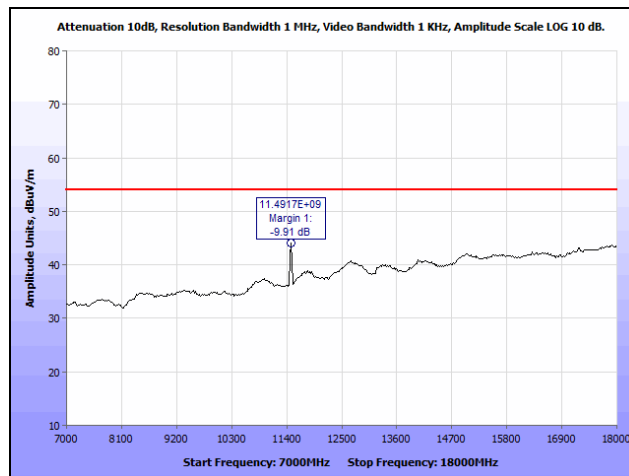

Plot 12. Radiated Spurious Emissions, Low Channel, 5745 MHz, 802.11a, 7 GHz – 18 GHz, Average

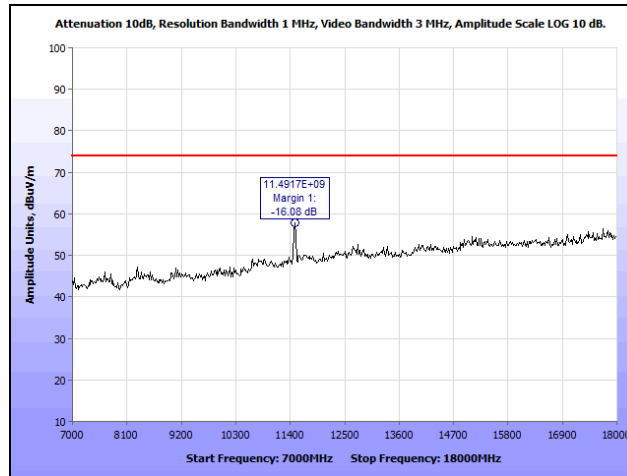

Plot 13. Radiated Spurious Emissions, Low Channel, 5745 MHz, 802.11a, 7 GHz – 18 GHz, Peak

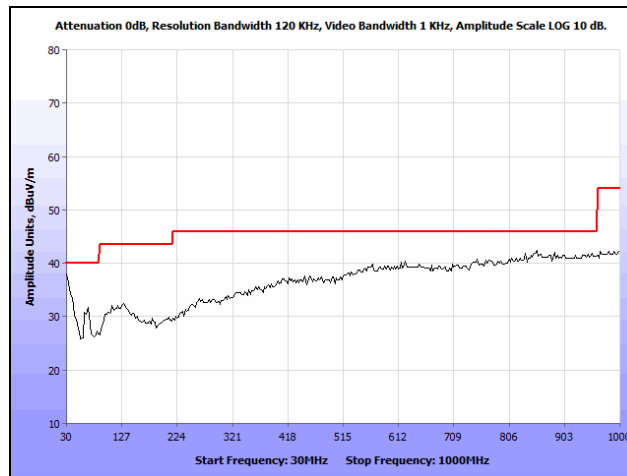

Plot 14. Radiated Spurious Emissions, Mid Channel, 5785 MHz, 802.11a, 30 MHz – 1 GHz, Average

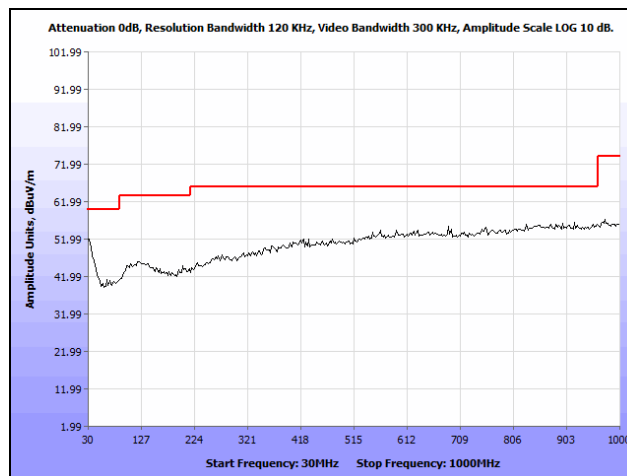

Plot 15. Radiated Spurious Emissions, Mid Channel, 5785 MHz, 802.11a, 30 MHz – 1 GHz, Peak

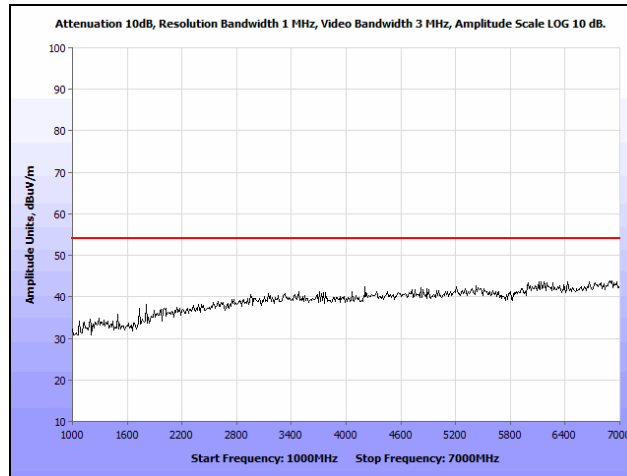

Plot 16. Radiated Spurious Emissions, Mid Channel, 5785 MHz, 802.11a, 1 GHz – 7 GHz, Peak under Avg. Limit

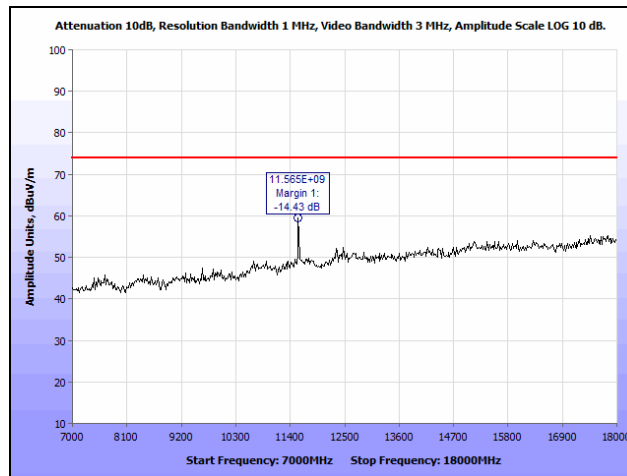

Plot 17. Radiated Spurious Emissions, Mid Channel, 5785 MHz, 802.11a, 7 GHz – 18 GHz, Peak

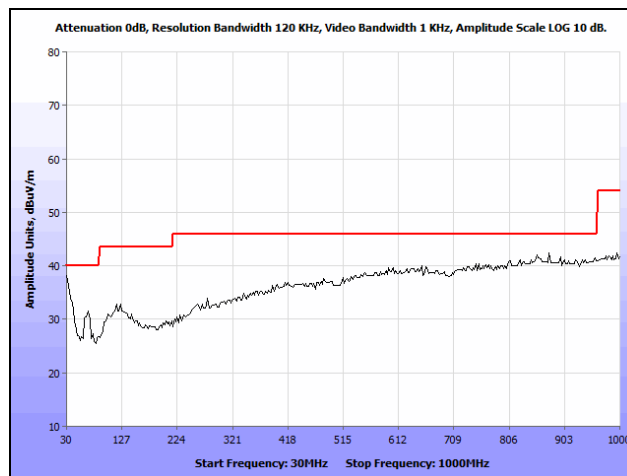

Plot 18. Radiated Spurious Emissions, High Channel, 5825 MHz, 802.11a, 30 MHz – 1 GHz, Average

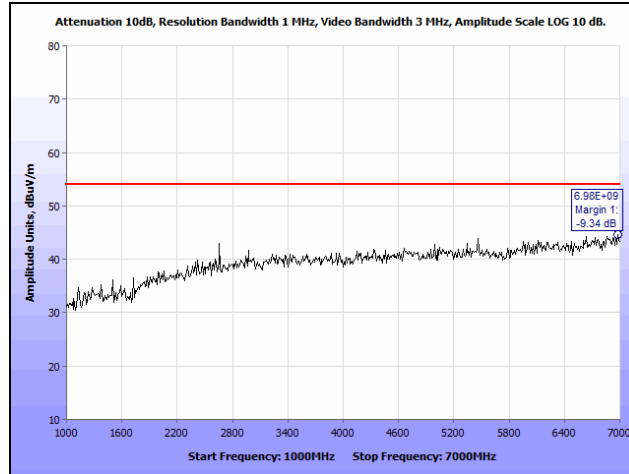

Plot 19. Radiated Spurious Emissions, High Channel, 5825 MHz, 802.11a, 1 GHz – 7 GHz, Peak under Avg. Limit

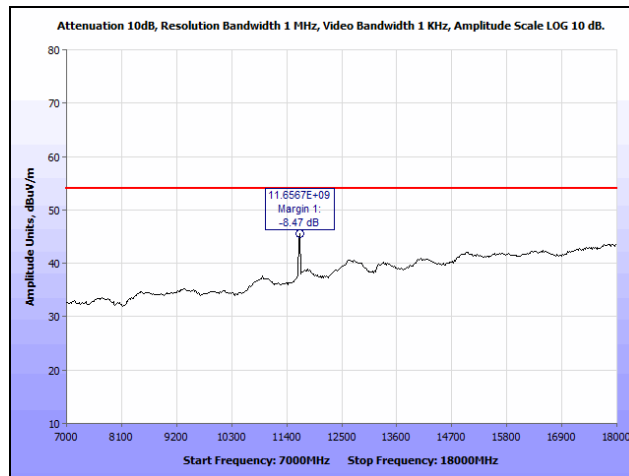

Plot 20. Radiated Spurious Emissions, High Channel, 5825 MHz, 802.11a, 7 GHz – 18 GHz, Average

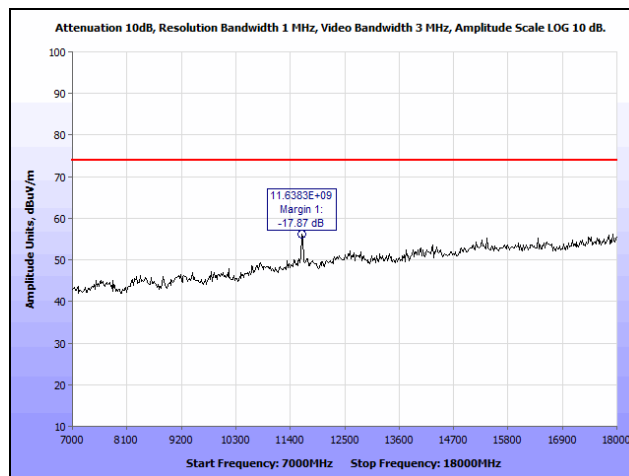

Plot 21. Radiated Spurious Emissions, High Channel, 5825 MHz, 802.11a, 7 GHz – 18 GHz, Peak

Radiated Band Edge Measurements

Test Procedures: The transmitter was turned on. Measurements were performed of the low, mid and high Channels. The EUT was rotated orthogonally through all three axes. Plots shown are corrected for both antenna correction factor and distance and compared to a 3 m limit line.

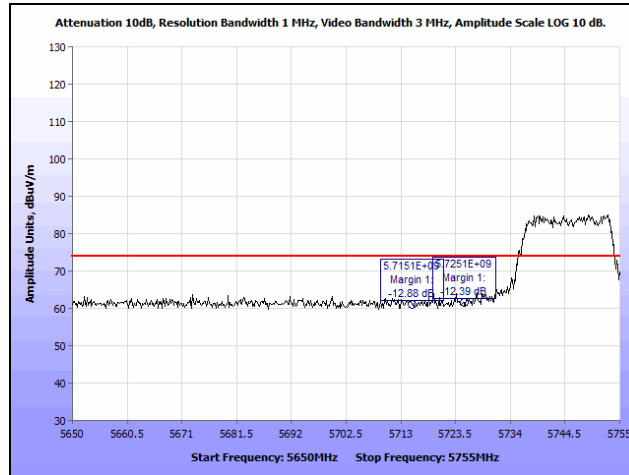

Plot 22. Radiated Band Edge, 802.11a, 5745 MHz, Low Channel, Average @ 5725 & 5715

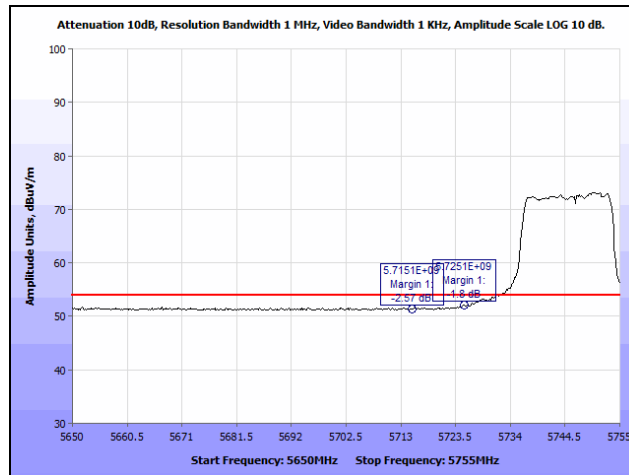

Plot 23. Radiated Band Edge, 802.11a, 5745 MHz, Low Channel, Average @ Band Edge 5725 MHz & 5715 MHz

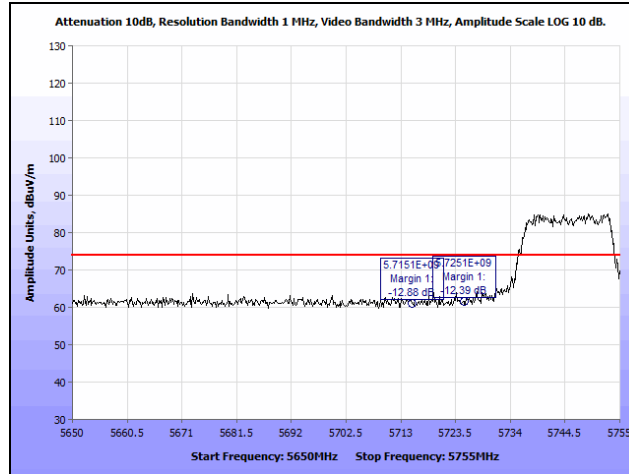

Plot 24. Radiated Band Edge, 802.11a, 5745 MHz, Low Channel, Peak @ Band Edge 5725 MHz & 5715 MHz

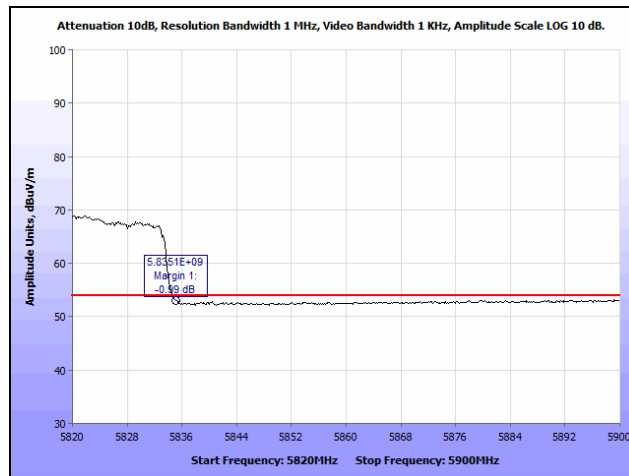

Plot 25. Radiated Band Edge, 802.11a, 5825 MHz, High Channel, Average @ Band Edge 5835 MHz

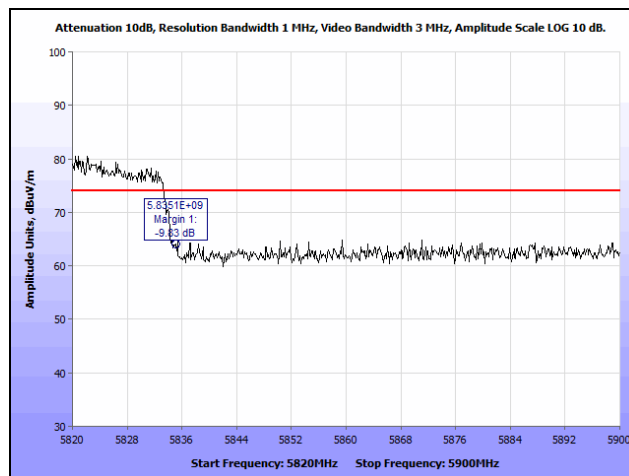

Plot 26. Radiated Band Edge, 802.11a, 5825 MHz, High Channel, Peak @ Band Edge 5835 MHz

Electromagnetic Compatibility Criteria for Intentional Radiators

§ 15.407(b)(6) Conducted Emissions

Test Requirement(s): § 15.407 (b)(6): Any U-NII devices using an AC power line are required to comply also with the conducted limits set forth in §15.207.

§ 15.207 (a): For an intentional radiator that is designed to be connected to the public utility (AC) power line, the radio frequency voltage that is conducted back onto the AC power line on any frequency or frequencies, within the band 150 kHz to 30MHz, shall not exceed the limits in the following table, as measured using a 50 μ H/50 Σ line impedance stabilization network (LISN). Compliance with the provisions of this paragraph shall be based on the measurement of the radio frequency voltage between each power line and ground at the power terminal. The lower limit applies at the boundary between the frequency ranges.

Frequency range (MHz)	§ 15.207(a), Conducted Limit (dB μ V)	
	Quasi-Peak	Average
* 0.15- 0.45	66 – 56	56 - 46
0.45 - 0.5	56	46
0.5 - 30	60	50

Table 6. Conducted Limits for Intentional Radiators from FCC Part 15 § 15.207(a)

Test Results: The EUT was not applicable with this requirement.

Electromagnetic Compatibility Criteria for Intentional Radiators

§ 15.407(f) RF Exposure

Test Requirement(s): §15.407(f): U-NII devices are subject to the radio frequency radiation exposure requirements specified in §1.1307(b), §2.1091 and §2.1093 of this chapter, as appropriate. All equipment shall be considered to operate in a “general population/uncontrolled” environment.

RF Exposure Requirements: §1.1307(b)(1) and §1.1307(b)(2): Systems operating under the provisions of this section shall be operated in a manner that ensures that the public is not exposed to radio frequency energy levels in excess of the Commission’s guidelines.

RF Radiation Exposure Limit: §1.1310: As specified in this section, the Maximum Permissible Exposure (MPE) Limit shall be used to evaluate the environmental impact of human exposure to radiofrequency (RF) radiation as specified in Sec. 1.1307(b), except in the case of portable devices which shall be evaluated according to the provisions of Sec. 2.1093 of this chapter.

This is a handheld remote. Per KDB 447498 D01, the SAR exclusion threshold is given by the following formula:

$$\frac{[(\text{max. power of channel, including tune-up tolerance, mW})/(\text{min. test separation distance, mm})] \cdot [\sqrt{f(\text{GHz})}]}{\text{extremity SAR}} \leq 3 \text{ for 1-g}$$

$$\frac{[(\text{max. power of channel, including tune-up tolerance, mW})/(\text{min. test separation distance, mm})] \cdot [\sqrt{f(\text{GHz})}]}{(0.53/5) \cdot \sqrt{5.825}} = 0.26, \text{ which is less than 3.}$$

Therefore, SAR is not required.

Electromagnetic Compatibility Criteria for Intentional Radiators

§ 15.407(g) Frequency Stability

Test Requirements: Manufacturers of U-NII devices are responsible for ensuring frequency stability such that an emission is maintained within the band of operation under all conditions of normal operation as specified in the user's manual.

Test Procedure: The EUT was connected directly to a spectrum analyzer through an attenuator. The resolution band width of the spectrum analyzer was set to 1 MHz. The Low and High channels were transmitted and viewed from the 5150MHz and 5350MHz edge.

Test Results: The EUT was compliant with the requirements of §15.407(g).

Test Engineer(s): Andy Shen

Test Date(s): 11/03/14

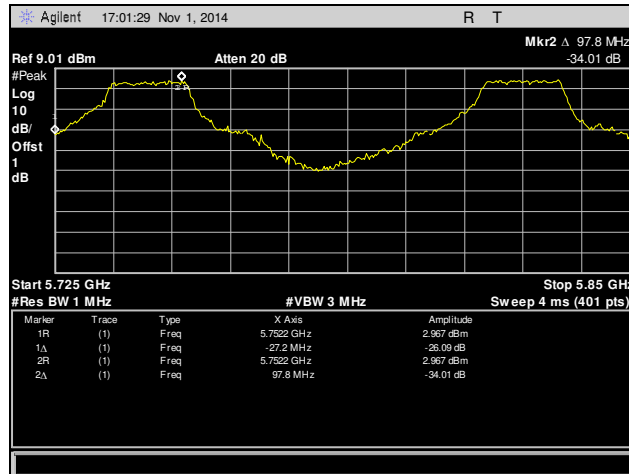

Plot 27. Frequency Stability, 5725-5850 MHz, -30°C, 120°C

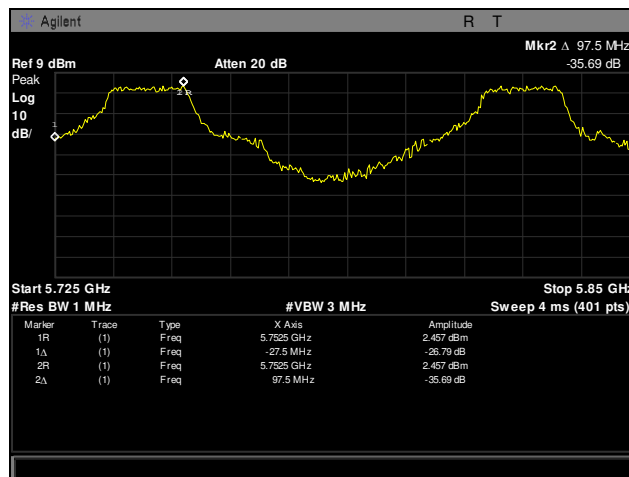

Plot 28. Frequency Stability, 5725-5850 MHz, -20°C, 120°C

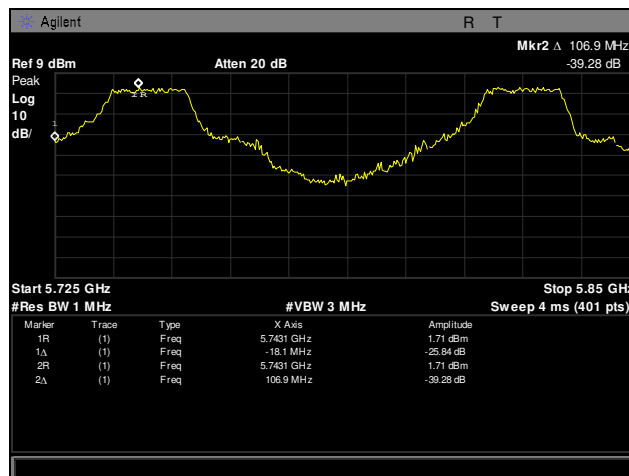

Plot 29. Frequency Stability, 5725-5850 MHz, -10°C, 120°C

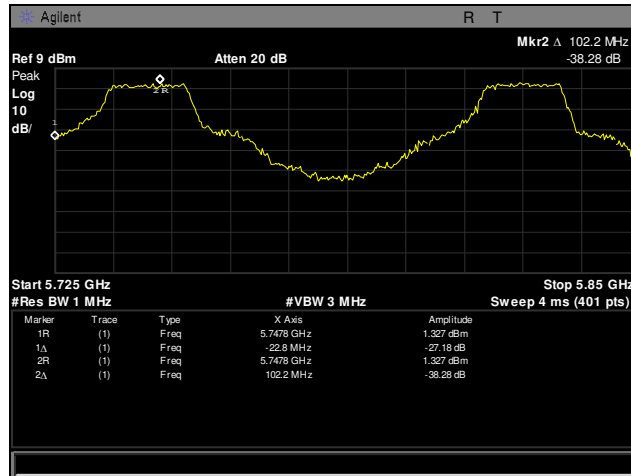

Plot 30. Frequency Stability, 5725-5850 MHz, 0°C, 120°C

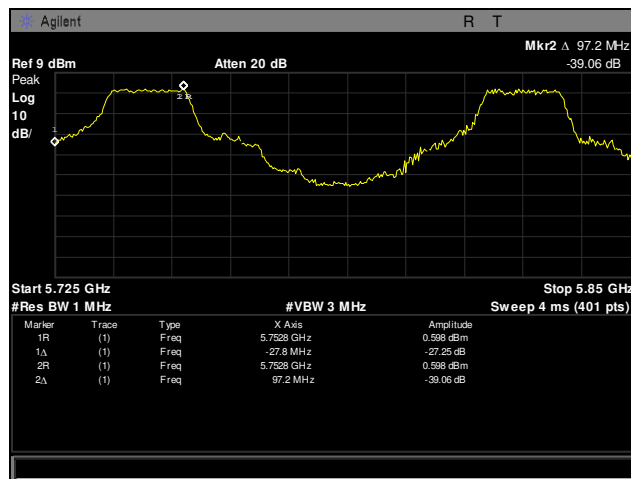

Plot 31. Frequency Stability, 5725-5850 MHz, 10°C, 120°C

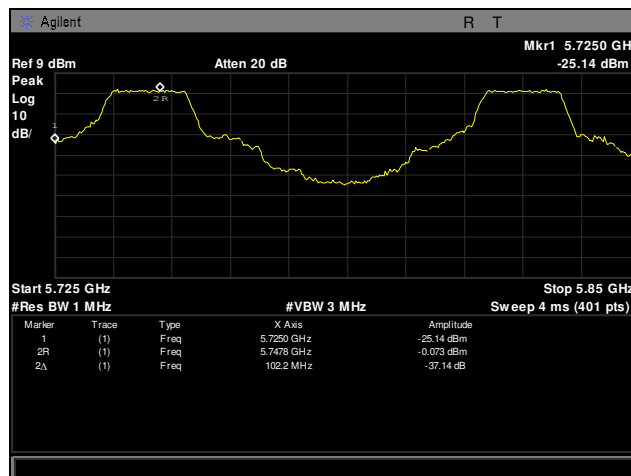

Plot 32. Frequency Stability, 5725-5850 MHz, 20°C, 120°C

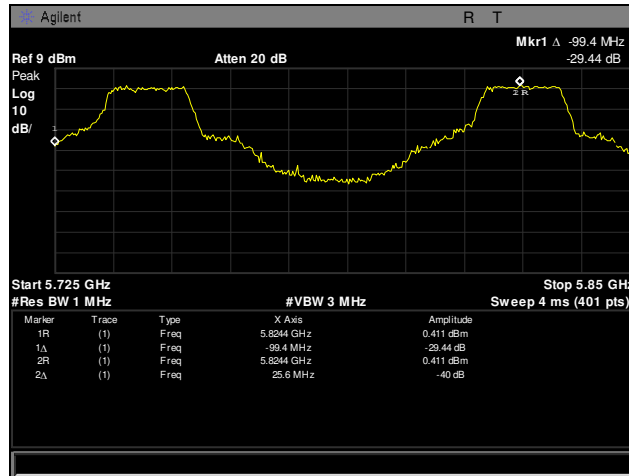

Plot 33. Frequency Stability, 5725-5850 MHz, 30°C, 120°C

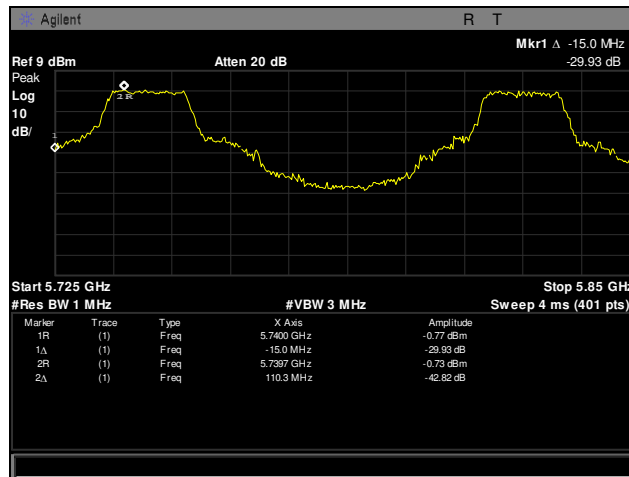

Plot 34. Frequency Stability, 5725-5850 MHz, 40°C, 120°C

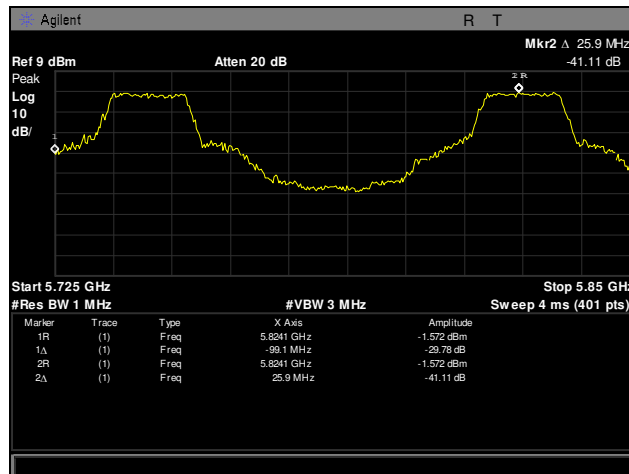

Plot 35. Frequency Stability, 5725-5850 MHz, 50°C, 120°C

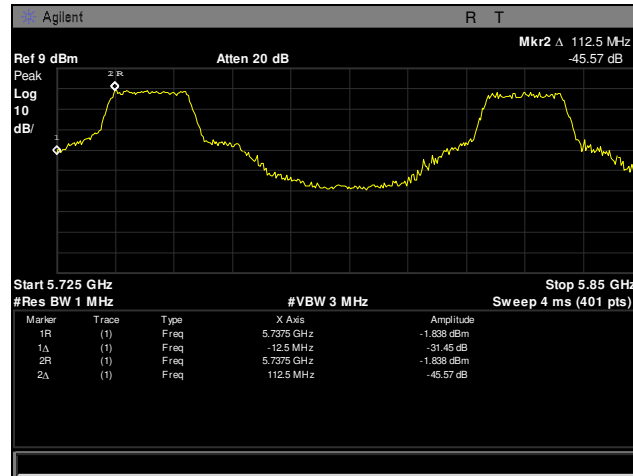

Plot 36. Frequency Stability, 5725-5850 MHz, 55°C, 120°C

IV. Test Equipment

Test Equipment

Calibrated test equipment utilized during testing was maintained in a current state of calibration per the requirements of ISO/IEC 17025:2005.

MET ASSET #	EQUIPMENT	MANUFACTURER	MODEL	LAST CAL DATE	CAL DUE DATE
1S2460	1-26GHZ SPECTRUM ANALYZER	AGILENT TECHNOLOGIES	E4407B	SEE NOTE	
1S2460	1-26GHZ SPECTRUM ANALYZER	AGILENT TECHNOLOGIES	E4407B	2/27/2014	8/27/2015
1S2229	TEMPERATURE CHAMBER	TENNY ENGINEERING	T63C	9/18/2013	3/18/2015
1S2421	EMI TEST RECEIVER	ROHDE & SCHWARZ	ESIB7	9/10/2014	9/10/2015
1S3853	DIGITAL DC POWER SUPPLY	EXTECH INSTRUMENTS	382200	SEE NOTE	
1S2482	5 METER CHAMBER (NSA)	PANASHIELD	5 METER SEMI-ANECHOIC CHAMBER	8/12/2013	2/12/2015
1S2600	BILOG ANTENNA	TESEQ	CBL6112D	8/29/2013	8/29/2015
1S2603	DOUBLE RIDGED WAVEGUIDE HORN	ETS-LINDGREN	3117	4/24/2013	4/24/2015
1S2421	EMI TEST RECEIVER	ROHDE & SCHWARZ	ESIB7	9/10/2014	9/10/2015
1S3835	PSA SPECTRUM ANALYZER	AGILENT	E4448A	9/24/2014	9/24/2015
1S2460	1-26GHZ SPECTRUM ANALYZER	AGILENT TECHNOLOGIES	E4407B	2/27/2014	8/27/2015
1S3853	DIGITAL DC POWER SUPPLY	EXTECH INSTRUMENTS	382200	SEE NOTE	
1S2399	TURNTABLE CONTROLLER	SUNOL SCIENCE	SC99V	NOT REQUIRED	
1S2121	PRE-AMPLIFIER	HEWLETT PACKARD	8449B	SEE NOTE	

Table 7. Test Equipment List

Note: Functionally tested equipment is verified using calibrated instrumentation at the time of testing.



V. Certification & User's Manual Information

Certification & User's Manual Information

J. Certification Information

The following is extracted from Title 47 of the Code of Federal Regulations, Part 2, Subpart I — Marketing of Radio frequency devices:

§ 2.801 Radio-frequency device defined.

As used in this part, a radio-frequency device is any device which in its operation is capable of Emitting radio-frequency energy by radiation, conduction, or other means. Radio- frequency devices include, but are not limited to:

- (a) The various types of radio communication transmitting devices described throughout this chapter.
- (b) *The incidental, unintentional and intentional radiators defined in Part 15 of this chapter.*
- (c) The industrial, scientific, and medical equipment described in Part 18 of this chapter.
- (d) Any part or component thereof which in use emits radio-frequency energy by radiation, conduction, or other means.

§ 2.803 Marketing of radio frequency devices prior to equipment authorization.

- (a) Except as provided elsewhere in this chapter, no person shall sell or lease, or offer for sale or lease (including advertising for sale or lease), or import, ship or distribute for the purpose of selling or leasing or offering for sale or lease, any radio frequency device unless:
 - (1) In the case of a device subject to certification, such device has been authorized by the Commission in accordance with the rules in this chapter and is properly identified and labeled as required by §2.925 and other relevant sections in this chapter; or
 - (2) In the case of a device that is not required to have a grant of equipment authorization issued by the Commission, but which must comply with the specified technical standards prior to use, such device also complies with all applicable administrative (including verification of the equipment or authorization under a Declaration of Conformity, where required), technical, labeling and identification requirements specified in this chapter.
- (d) Notwithstanding the provisions of paragraph (a) of this section, the offer for sale solely to business, commercial, industrial, scientific or medical users (but not an offer for sale to other parties or to end users located in a residential environment) of a radio frequency device that is in the conceptual, developmental, design or pre-production stage is permitted prior to equipment authorization or, for devices not subject to the equipment authorization requirements, prior to a determination of compliance with the applicable technical requirements *provided* that the prospective buyer is advised in writing at the time of the offer for sale that the equipment is subject to the FCC rules and that the equipment will comply with the appropriate rules before delivery to the buyer or to centers of distribution.

- (e)(1) Notwithstanding the provisions of paragraph (a) of this section, prior to equipment authorization or determination of compliance with the applicable technical requirements any radio frequency device may be operated, but not marketed, for the following purposes and under the following conditions:
- (i) *Compliance testing;*
 - (ii) Demonstrations at a trade show provided the notice contained in paragraph (c) of this section is displayed in a conspicuous location on, or immediately adjacent to, the device;
 - (iii) Demonstrations at an exhibition conducted at a business, commercial, industrial, scientific or medical location, but excluding locations in a residential environment, provided the notice contained in paragraphs (c) or (d) of this section, as appropriate, is displayed in a conspicuous location on, or immediately adjacent to, the device;
 - (iv) Evaluation of product performance and determination of customer acceptability, provided such operation takes place at the manufacturer's facilities during developmental, design or pre-production states; or
 - (v) Evaluation of product performance and determination of customer acceptability where customer acceptability of a radio frequency device cannot be determined at the manufacturer's facilities because of size or unique capability of the device, provided the device is operated at a business, commercial, industrial, scientific or medical user's site, but not at a residential site, during the development, design or pre-production stages.
- (e)(2) For the purpose of paragraphs (e)(1)(iv) and (e)(1)(v) of this section, the term *manufacturer's facilities* includes the facilities of the party responsible for compliance with the regulations and the manufacturer's premises, as well as the facilities of other entities working under the authorization of the responsible party in connection with the development and manufacture, but not the marketing, of the equipment.
- (f) For radio frequency devices subject to verification and sold solely to business, commercial, industrial, scientific and medical users (excluding products sold to other parties or for operation in a residential environment), parties responsible for verification of the devices shall have the option of ensuring compliance with the applicable technical specifications of this chapter at each end user's location after installation, provided that the purchase or lease agreement includes a proviso that such a determination of compliance be made and is the responsibility of the party responsible for verification of the equipment.



Certification & User's Manual Information

The following is extracted from Title 47 of the Code of Federal Regulations, Part 2, Subpart J — Equipment Authorization Procedures:

§ 2.901 Basis and Purpose

- (a) In order to carry out its responsibilities under the Communications Act and the various treaties and international regulations, and in order to promote efficient use of the radio spectrum, the Commission has developed technical standards for radio frequency equipment and parts or components thereof. The technical standards applicable to individual types of equipment are found in that part of the rules governing the service wherein the equipment is to be operated.¹ *In addition to the technical standards provided, the rules governing the service may require that such equipment be verified by the manufacturer or importer, be authorized under a Declaration of Conformity, or receive an equipment authorization from the Commission by one of the following procedures: certification or registration.*
- (b) The following sections describe the verification procedure, the procedure for a Declaration of Conformity, and the procedures to be followed in obtaining certification from the Commission and the conditions attendant to such a grant.

§ 2.907 Certification.

- (a) Certification is an equipment authorization issued by the Commission, based on representation and test data submitted by the applicant.
- (b) Certification attaches to all units subsequently marketed by the grantee which are identical (see Section 2.908) to the sample tested except for permissive changes or other variations authorized by the Commission pursuant to Section 2.1043.

¹ In this case, the equipment is subject to the rules of Part 15. More specifically, the equipment falls under Subpart B (of Part 15), which deals with unintentional radiators.



Certification & User's Manual Information

§ 2.948 Description of measurement facilities.

- (a) Each party making measurements of equipment that is subject to an equipment authorization under Part 15 or Part 18 of this chapter, regardless of whether the measurements are filed with the Commission or kept on file by the party responsible for compliance of equipment marketed within the U.S. or its possessions, shall compile a description of the measurement facilities employed.
 - (1) If the measured equipment is subject to the verification procedure, the description of the measurement facilities shall be retained by the party responsible for verification of the equipment.
 - (i) *If the equipment is verified through measurements performed by an independent laboratory, it is acceptable for the party responsible for verification of the equipment to rely upon the description of the measurement facilities retained by or placed on file with the Commission by that laboratory. In this situation, the party responsible for the verification of the equipment is not required to retain a duplicate copy of the description of the measurement facilities.*
 - (ii) If the equipment is verified based on measurements performed at the installation site of the equipment, no specific site calibration data is required. It is acceptable to retain the description of the measurement facilities at the site at which the measurements were performed.
 - (2) If the equipment is to be authorized by the Commission under the certification procedure, the description of the measurement facilities shall be filed with the Commission's Laboratory in Columbia, Maryland. The data describing the measurement facilities need only be filed once but must be updated as changes are made to the measurement facilities or as otherwise described in this section. At least every three years, the organization responsible for filing the data with the Commission shall certify that the data on file is current.



Certification & User's Manual Information

Label and User's Manual Information

The following is extracted from Title 47 of the Code of Federal Regulations, Part 15, Subpart A — General:

§ 15.19 Labeling requirements.

(a) *In addition to the requirements in Part 2 of this chapter, a device subject to certification or verification shall be labeled as follows:*

- (1) Receivers associated with the operation of a licensed radio service, e.g., FM broadcast under Part 73 of this chapter, land mobile operation under Part 90, etc., shall bear the following statement in a conspicuous location on the device:

This device complies with Part 15 of the FCC Rules. Operation is subject to the condition that this device does not cause harmful interference.

- (2) A stand-alone cable input selector switch, shall bear the following statement in a conspicuous location on the device:

This device is verified to comply with Part 15 of the FCC Rules for use with cable television service.

- (3) All other devices shall bear the following statement in a conspicuous location on the device:

This device complies with Part 15 of the FCC Rules. Operation is subject to the following two conditions: (1) This device may not cause harmful interference, and (2) this device must accept any interference received, including interference that may cause undesired operation.

- (4) Where a device is constructed in two or more sections connected by wires and marketed together, the statement specified under paragraph (a) of this section is required to be affixed only to the main control unit.

- (5) When the device is so small or for such use that it is not practicable to place the statement specified under paragraph (a) of this section on it, the information required by this paragraph shall be placed in a prominent location in the instruction manual or pamphlet supplied to the user or, alternatively, shall be placed on the container in which the device is marketed. However, the FCC identifier or the unique identifier, as appropriate, must be displayed on the device.

§ 15.21 Information to user.

The users manual or instruction manual for an intentional or unintentional radiator shall caution the user that changes or modifications not expressly approved by the party responsible for compliance could void the user's authority to operate the equipment.



Verification & User's Manual Information

The following is extracted from Title 47 of the Code of Federal Regulations, Part 15, Subpart B — Unintentional Radiators:

§ 15.105 Information to the user.

- (a) For a Class A digital device or peripheral, the instructions furnished the user shall include the following or similar statement, placed in a prominent location in the text of the manual:

Note: This equipment has been tested and found to comply with the limits for a Class A digital device, pursuant to Part 15 of the FCC Rules. These limits are designed to provide reasonable protection against harmful interference when the equipment is operated in a commercial environment. This equipment generates, uses, and can radiate radio frequency energy and, if not installed and used in accordance with the instruction manual, may cause harmful interference to radio communications. Operation of this equipment in a residential area is likely to cause harmful interference in which case the user will be required to correct the interference at own expense.

- (b) For a Class B digital device or peripheral, the instructions furnished the user shall include the following or similar statement, placed in a prominent location in the text of the manual:

Note: This equipment has been tested and found to comply with the limits for a Class B digital device, pursuant to Part 15 of the FCC Rules. These limits are designed to provide reasonable protection against harmful interference when the equipment is operated in a residential environment. This equipment generates, uses, and can radiate radio frequency energy and, if not installed and used in accordance with the instruction manual, may cause harmful interference to radio communications. However, there is no guarantee that interference will not occur in a particular installation. If this equipment does cause harmful interference to radio or television reception, which can be determined by turning the equipment off and on, the user is encouraged to try to correct the interference by one or more of the following measures:

- Reorient or relocate the receiving antenna.
- Increase the separation between the equipment and receiver.
- Connect the equipment into an outlet on a circuit different from that to which the receiver is connected.
- Consult the dealer or an experienced radio/TV technician for help.



End of Report