



TDK Antenna Measurement Report

- ANT016008LCD2442MA1

Systems Acoustics Waves BG
TDK Corporation
Apr,2016

TDK Setup & Tuning results

Cable Setup



Tuning results(Same as Gary4)

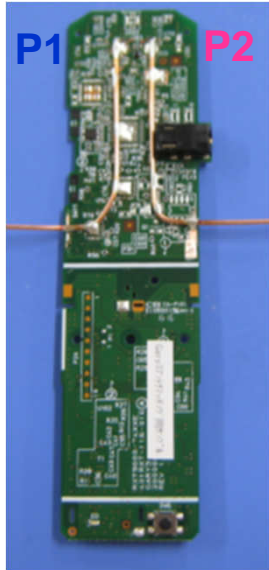
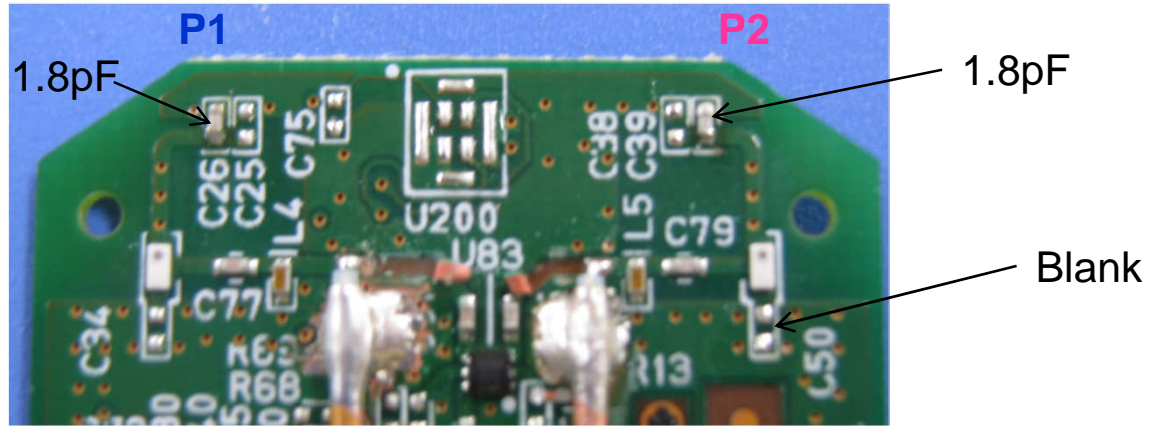

TDK Measurement results vsWR, Efficiency & Max Gain

2.4GHz band

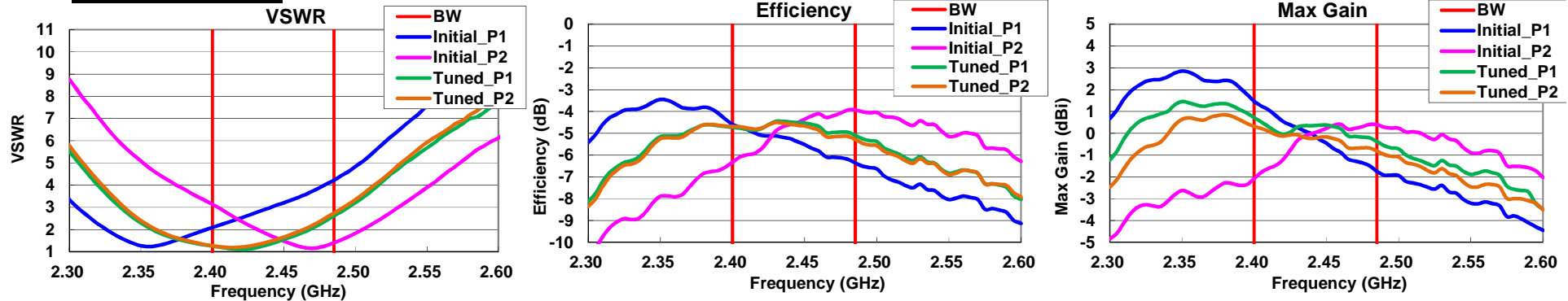

Frequency[GHz]	Initial_P1			Initial_P2			Tuned_P1			Tuned_P2		
	2.4	2.442	2.485	2.4	2.442	2.485	2.4	2.442	2.485	2.4	2.442	2.485
VSWR	2.09	3.03	4.22	3.13	1.69	1.40	1.25	1.38	2.61	1.26	1.49	2.74
Total Efficiency[dB]	-4.59	-5.30	-6.36	-6.32	-4.56	-3.92	-4.73	-4.49	-5.09	-4.69	-4.60	-5.28
Max Gain [dBi]	1.47	-0.12	-1.74	-2.07	0.03	0.40	0.72	0.36	-0.38	0.32	-0.22	-0.81

5 GHz band

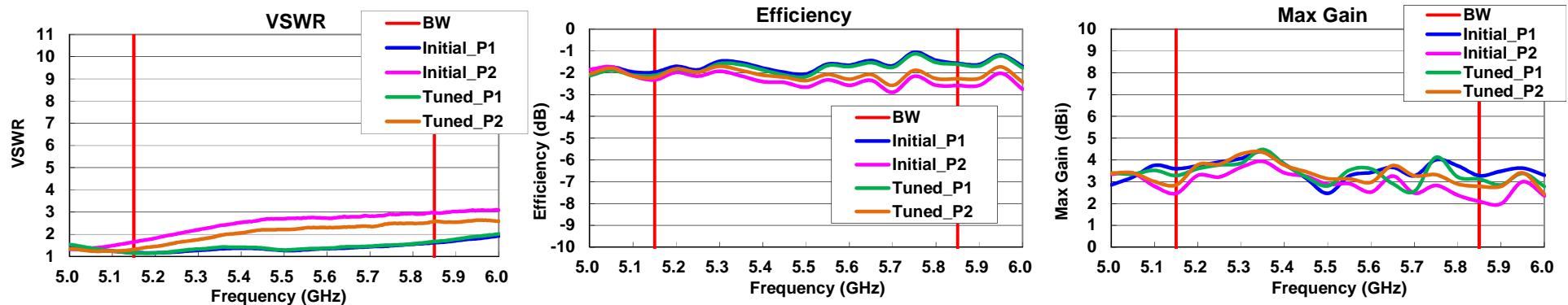

Frequency[GHz]	Initial_P1			Initial_P2			Tuned_P1			Tuned_P2		
	5.15	5.5	5.85	5.15	5.5	5.85	5.15	5.5	5.85	5.15	5.5	5.85
VSWR	1.17	1.27	1.62	1.66	2.70	2.96	1.15	1.29	1.67	1.32	2.21	2.58
Total Efficiency[dB]	-1.97	-2.06	-1.56	-2.32	-2.66	-2.58	-2.12	-2.18	-1.61	-2.21	-2.36	-2.27
Max Gain [dBi]	3.60	2.47	3.28	2.47	2.89	2.10	3.29	2.81	3.12	2.86	3.15	2.79

TDK Measurement results Isolation

2.4GHz band

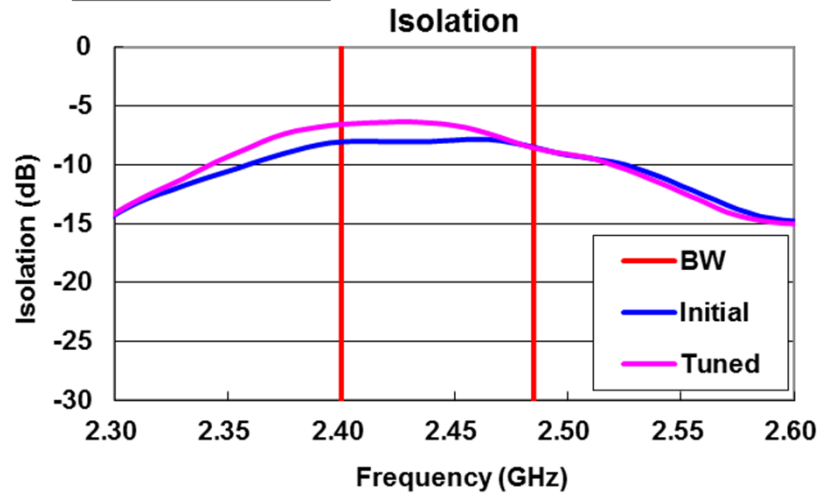

5 GHz band

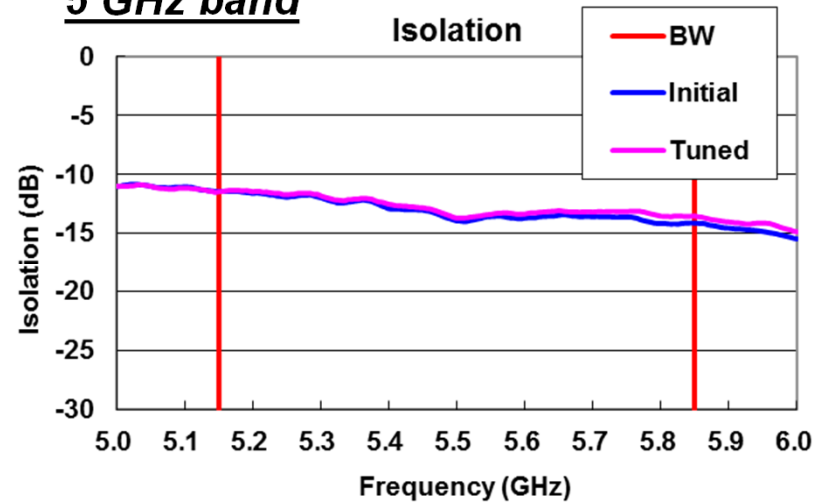

Summary

- Measured the performance in Initial condition and Tuned condition.
- Tuning value are same as Gary4.

Radiation Pattern

Initial

TDK Radiation pattern 2.4GHz band V&H Polarization

Initial

P1

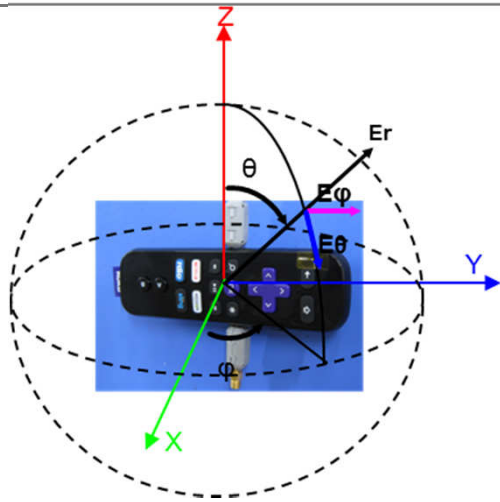

XY plane

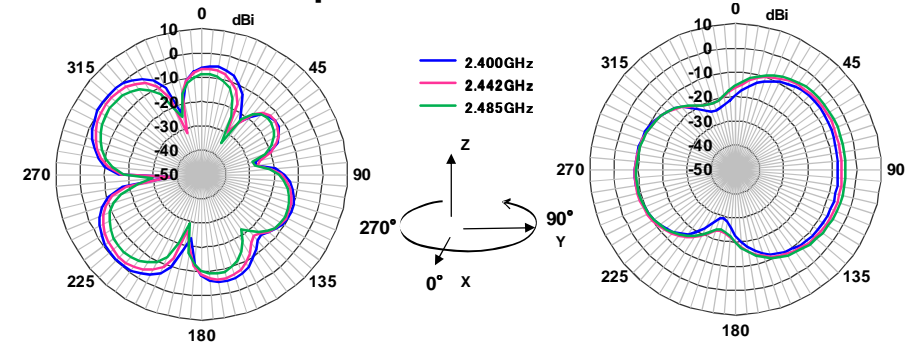

Horizontal Polarization

Frequency(GHz)	2.4	2.442	2.485
Average[dBi]	-5.6	-7.2	-9.8
Maximum[dBi]	0.5	-1.0	-3.5
Minimum[dBi]	-37.3	-36.7	-34.6

Vertical Polarization

Frequency(GHz)	2.4	2.442	2.485
Average[dBi]	-10.3	-9.2	-8.5
Maximum[dBi]	-6.9	-5.6	-4.5
Minimum[dBi]	-29.3	-24.0	-24.7

ZX plane

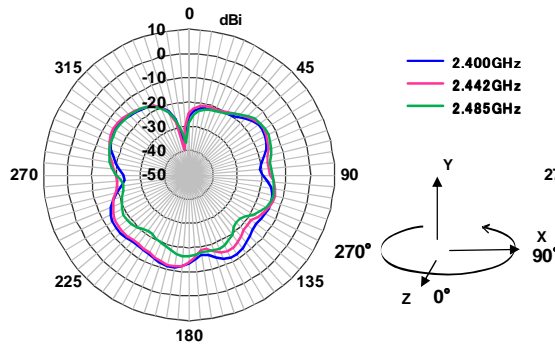

Horizontal Polarization

Frequency(GHz)	2.4	2.442	2.485
Average[dBi]	-15.5	-15.8	-17.4
Maximum[dBi]	-11.3	-11.7	-13.1
Minimum[dBi]	-35.7	-39.6	-36.4

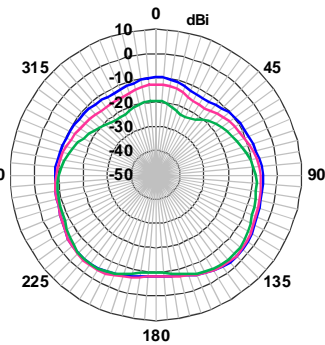

Vertical Polarization

Frequency(GHz)	2.4	2.442	2.485
Average[dBi]	-7.09	-7.55	-8.99
Maximum[dBi]	-2.57	-2.79	-3.96
Minimum[dBi]	-13.10	-16.07	-23.13

ZY plane

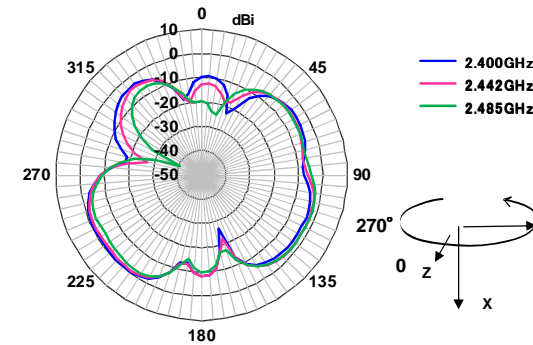

Horizontal Polarization

Frequency(GHz)	2.4	2.442	2.485
Average[dBi]	-5.1	-5.3	-6.1
Maximum[dBi]	-0.1	-0.9	-2.0
Minimum[dBi]	-26.6	-26.8	-40.2

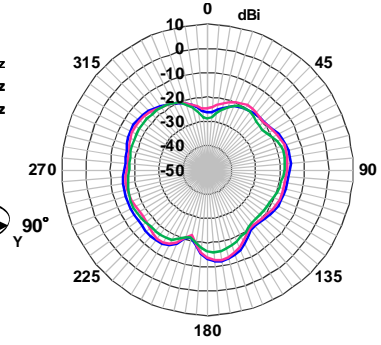

Vertical Polarization

Frequency(GHz)	2.4	2.442	2.485
Average[dBi]	-16.4	-17.2	-18.6
Maximum[dBi]	-11.7	-12.4	-15.8
Minimum[dBi]	-26.2	-24.8	-29.0



Radiation pattern 5GHz band V&H Polarization

Initial

P1

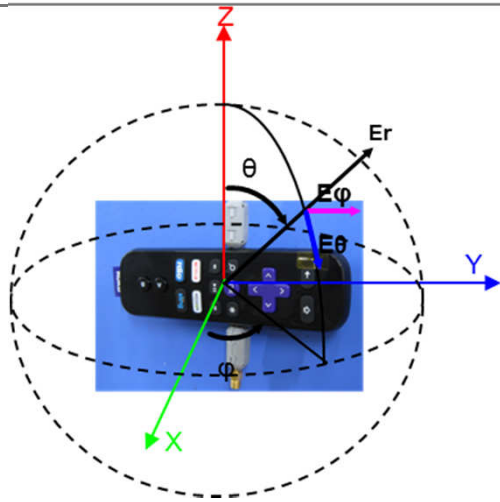

XY plane

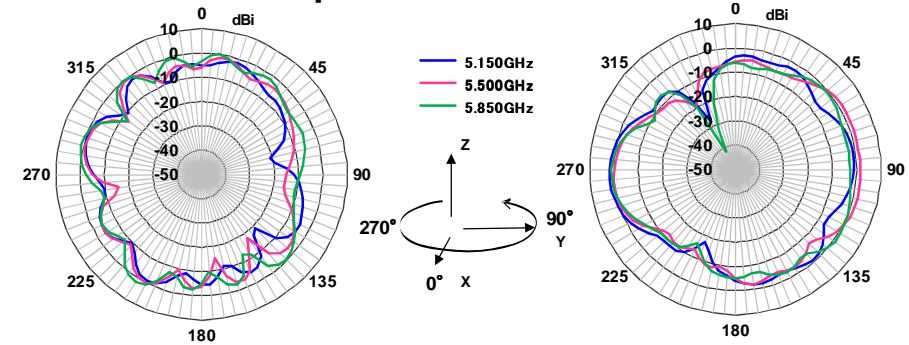

Horizontal Polarization

Frequency(GHz)	5.15	5.5	5.85
Average[dBi]	-5.1	-4.7	-3.2
Maximum[dBi]	-0.5	0.2	1.9
Minimum[dBi]	-20.8	-17.6	-12.8

Vertical Polarization

Frequency(GHz)	5.15	5.5	5.85
Average[dBi]	-3.1	-2.6	-3.5
Maximum[dBi]	1.9	1.9	1.1
Minimum[dBi]	-27.7	-19.5	-41.8

ZX plane

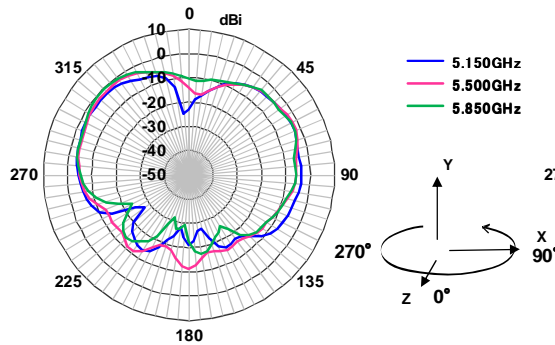

Horizontal Polarization

Frequency(GHz)	5.15	5.5	5.85
Average[dBi]	-6.5	-6.4	-6.3
Maximum[dBi]	-2.2	-1.4	-0.2
Minimum[dBi]	-28.1	-19.1	-31.6

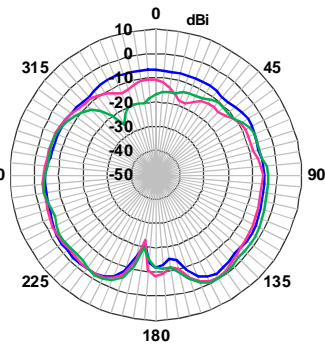

Vertical Polarization

Frequency(GHz)	5.15	5.5	5.85
Average[dBi]	-5.23	-5.70	-5.35
Maximum[dBi]	-1.93	-0.54	-0.07
Minimum[dBi]	-21.41	-22.56	-25.52

ZY plane

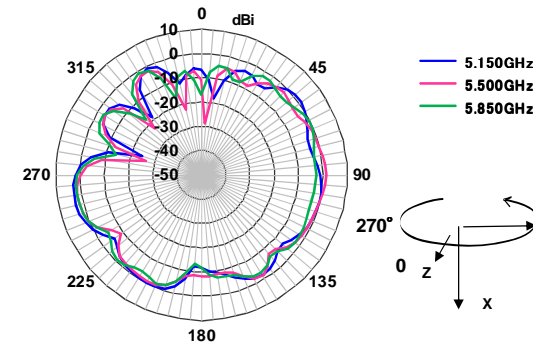

Horizontal Polarization

Frequency(GHz)	5.15	5.5	5.85
Average[dBi]	-2.2	-2.8	-3.1
Maximum[dBi]	3.2	1.9	2.1
Minimum[dBi]	-24.4	-28.9	-17.5

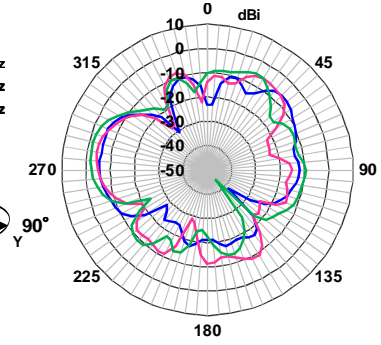

Vertical Polarization

Frequency(GHz)	5.15	5.5	5.85
Average[dBi]	-11.4	-10.6	-9.0
Maximum[dBi]	-5.2	-4.1	-1.7
Minimum[dBi]	-38.4	-28.9	-44.9



Radiation pattern 2.4GHz band Total power

Initial

P1

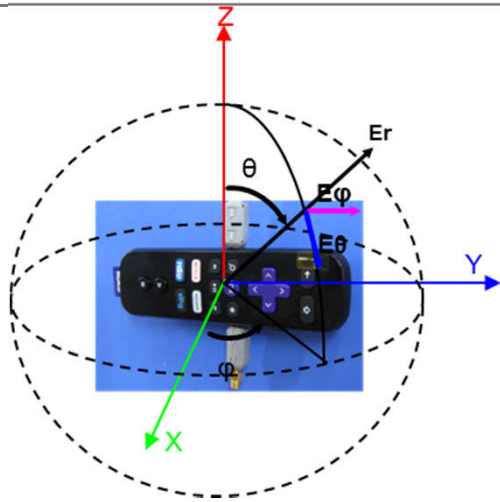

XY plane

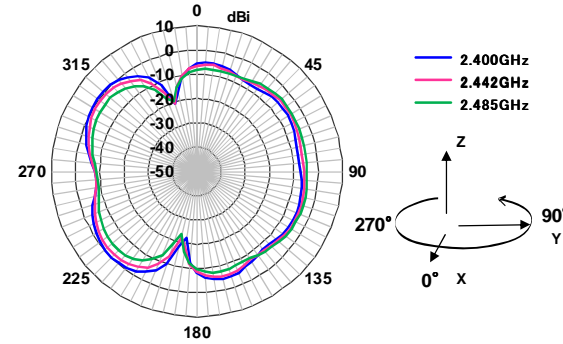

Total power

Frequency(GHz)	2.4	2.442	2.485
Average[dBi]	-4.3	-5.1	-6.0
Maximum[dBi]	0.7	-0.7	-2.9
Minimum[dBi]	-22.1	-21.9	-23.4

ZX plane

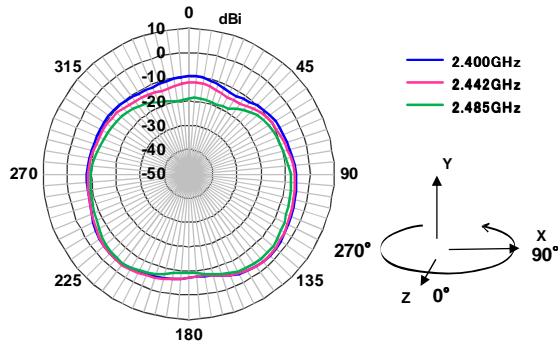

Total Power

Frequency(GHz)	2.4	2.442	2.485
Average[dBi]	-6.5	-6.9	-8.4
Maximum[dBi]	-2.3	-2.7	-3.9
Minimum[dBi]	-12.3	-14.5	-19.5

ZY plane

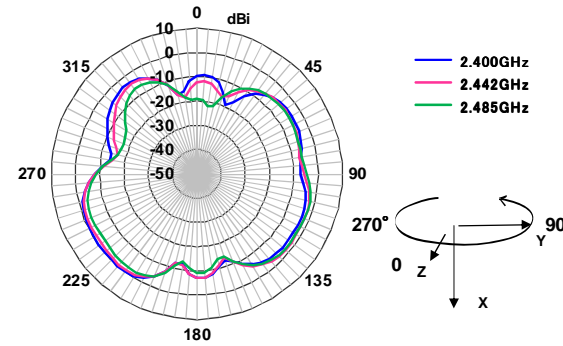

Total power

Frequency(GHz)	2.4	2.442	2.485
Average[dBi]	-4.8	-5.0	-5.8
Maximum[dBi]	0.1	-0.8	-1.9
Minimum[dBi]	-19.1	-18.2	-21.6

TDK Radiation pattern 5GHz band Total power

Initial

P1

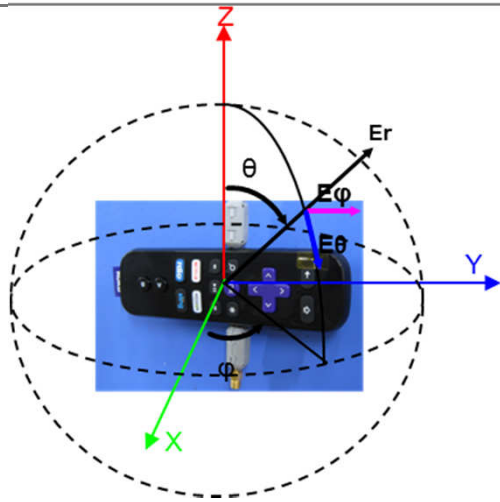

XY plane

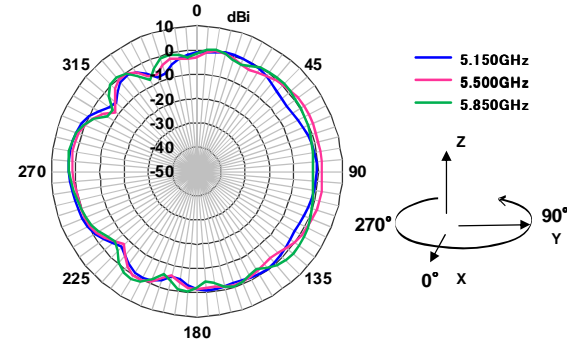

Total power

Frequency(GHz)	5.15	5.5	5.85
Average[dBi]	-1.0	-0.5	-0.3
Maximum[dBi]	2.9	2.0	3.2
Minimum[dBi]	-8.1	-8.5	-7.6

ZX plane

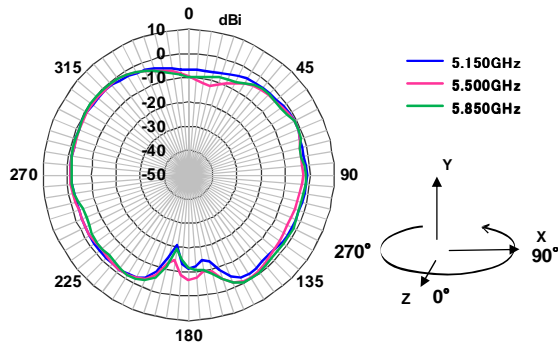

Total Power

Frequency(GHz)	5.15	5.5	5.85
Average[dBi]	-2.8	-3.0	-2.8
Maximum[dBi]	-0.8	-0.4	0.1
Minimum[dBi]	-20.6	-14.4	-19.2

ZY plane

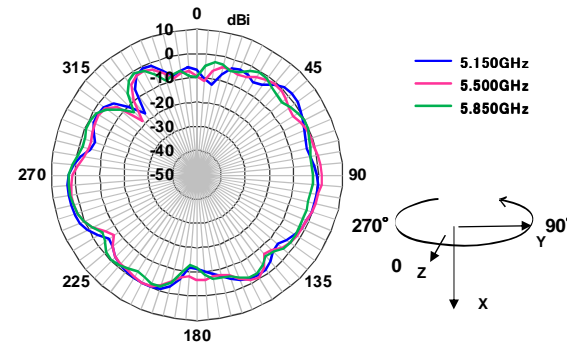

Total power

Frequency(GHz)	5.15	5.5	5.85
Average[dBi]	-1.7	-2.1	-2.1
Maximum[dBi]	3.6	2.4	3.2
Minimum[dBi]	-16.9	-18.2	-13.1



Radiation pattern 2.4GHz band V&H Polarization

Initial

P2

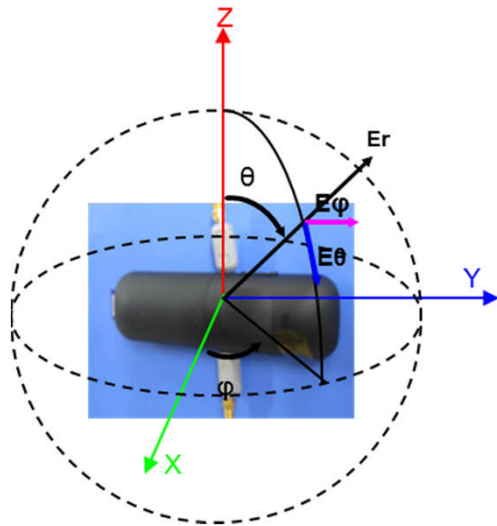

XY plane

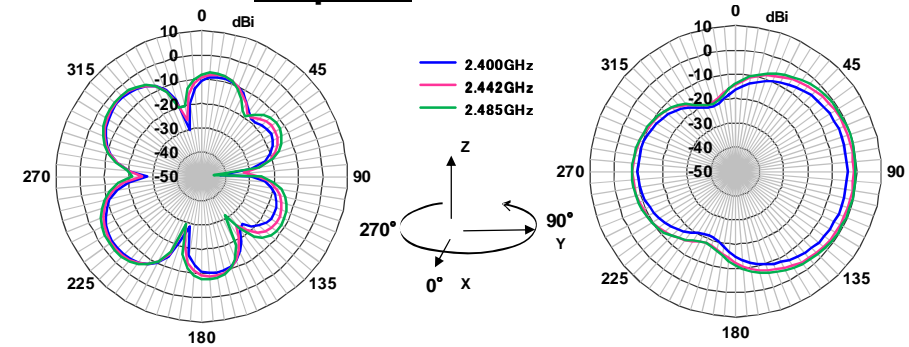

Horizontal Polarization

Frequency(GHz)	2.4	2.442	2.485
Average[dBi]	-10.0	-9.2	-8.6
Maximum[dBi]	-3.9	-3.3	-2.9
Minimum[dBi]	-42.2	-32.4	-44.7

Vertical Polarization

Frequency(GHz)	2.4	2.442	2.485
Average[dBi]	-8.3	-5.7	-4.8
Maximum[dBi]	-3.9	-1.2	-0.3
Minimum[dBi]	-21.7	-20.1	-20.7

ZX plane

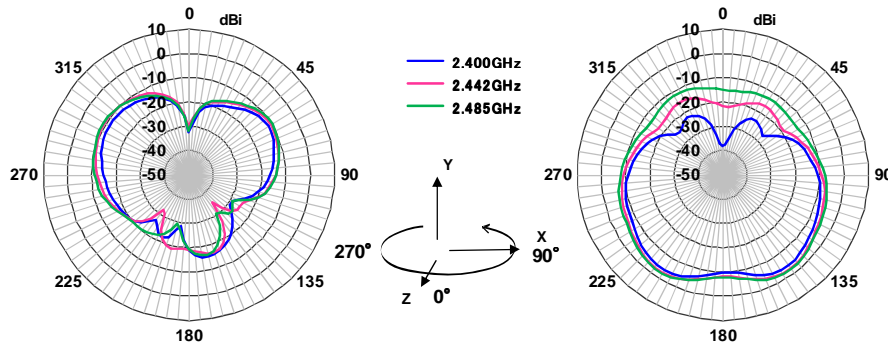

Horizontal Polarization

Frequency(GHz)	2.4	2.442	2.485
Average[dBi]	-16.0	-14.3	-14.0
Maximum[dBi]	-11.5	-9.2	-8.9
Minimum[dBi]	-32.5	-35.4	-31.7

Vertical Polarization

Frequency(GHz)	2.4	2.442	2.485
Average[dBi]	-9.21	-7.56	-6.74
Maximum[dBi]	-3.84	-2.31	-1.86
Minimum[dBi]	-37.84	-21.86	-15.05

ZY plane

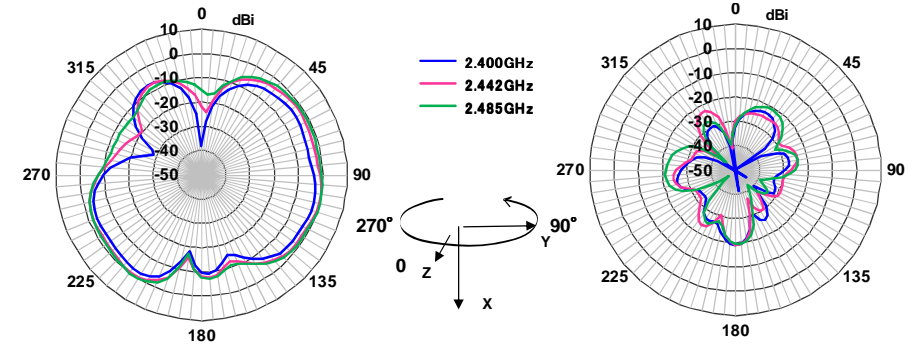

Horizontal Polarization

Frequency(GHz)	2.4	2.442	2.485
Average[dBi]	-6.2	-4.2	-3.5
Maximum[dBi]	-2.1	0.0	0.4
Minimum[dBi]	-37.8	-24.0	-16.9

Vertical Polarization

Frequency(GHz)	2.4	2.442	2.485
Average[dBi]	-27.3	-26.3	-25.5
Maximum[dBi]	-18.9	-19.2	-19.3
Minimum[dBi]	-58.6	-41.4	-46.4

TDK Radiation pattern 5GHz band V&H Polarization

Initial

P2

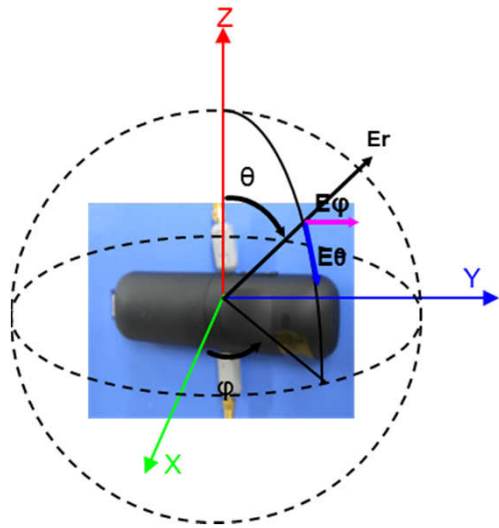

XY plane

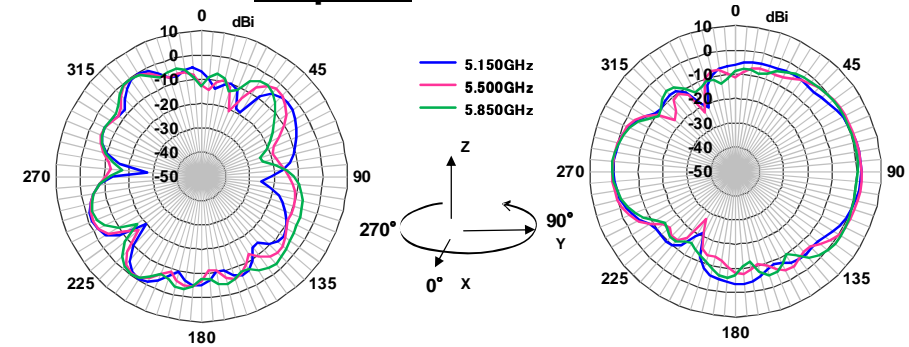

Horizontal Polarization

Frequency (GHz)	5.15	5.5	5.85
Average[dBi]	-6.1	-6.0	-5.5
Maximum[dBi]	-0.6	-0.1	-0.2
Minimum[dBi]	-27.6	-20.9	-24.6

Vertical Polarization

Frequency (GHz)	5.15	5.5	5.85
Average[dBi]	-3.1	-2.7	-3.0
Maximum[dBi]	2.0	2.1	0.9
Minimum[dBi]	-21.7	-27.1	-15.5

ZX plane

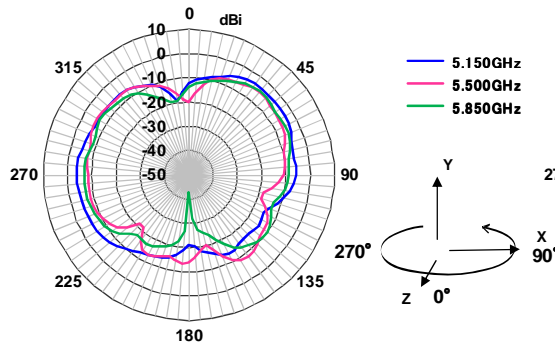

Horizontal Polarization

Frequency (GHz)	5.15	5.5	5.85
Average[dBi]	-7.2	-9.4	-9.4
Maximum[dBi]	-3.2	-5.0	-4.6
Minimum[dBi]	-21.0	-21.6	-42.6

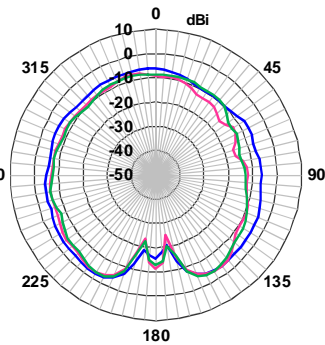

Vertical Polarization

Frequency (GHz)	5.15	5.5	5.85
Average[dBi]	-5.75	-7.91	-7.93
Maximum[dBi]	-2.01	-2.90	-2.82
Minimum[dBi]	-20.65	-24.97	-22.39

ZY plane

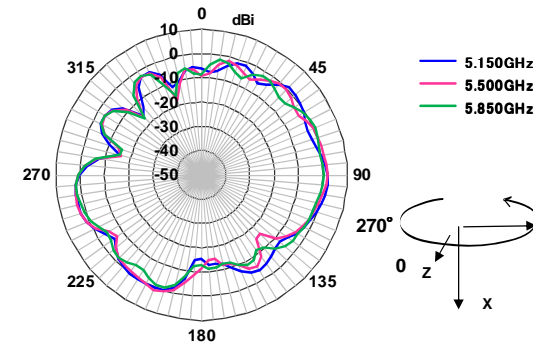

Horizontal Polarization

Frequency (GHz)	5.15	5.5	5.85
Average[dBi]	-2.1	-2.4	-3.0
Maximum[dBi]	2.4	2.7	1.9
Minimum[dBi]	-15.9	-17.5	-17.3

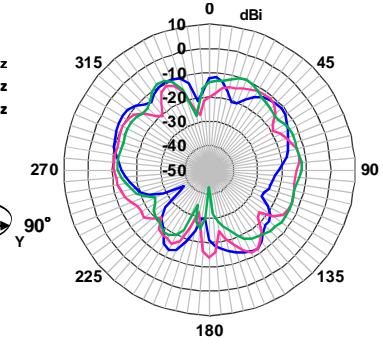

Vertical Polarization

Frequency (GHz)	5.15	5.5	5.85
Average[dBi]	-13.8	-14.2	-14.1
Maximum[dBi]	-7.8	-10.0	-8.6
Minimum[dBi]	-37.6	-31.7	-42.6

TDK Radiation pattern 2.4GHz band Total power

Initial

P2

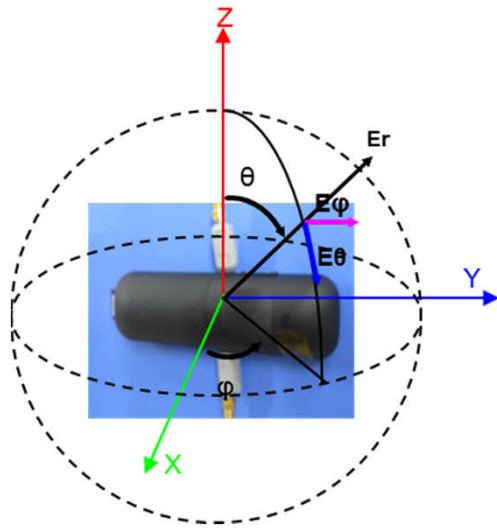

ZX plane

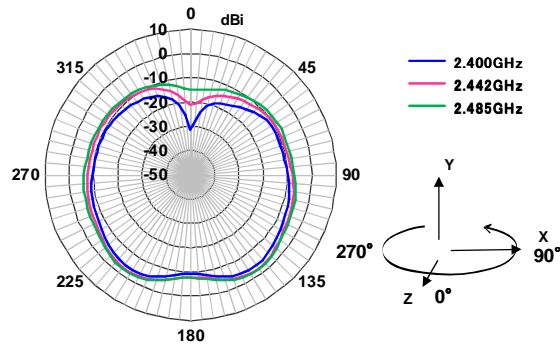

Total Power

Frequency(GHz)	2.4	2.442	2.485
Average[dBi]	-8.4	-6.7	-6.0
Maximum[dBi]	-3.7	-2.3	-1.9
Minimum[dBi]	-31.4	-21.0	-14.7

XY plane

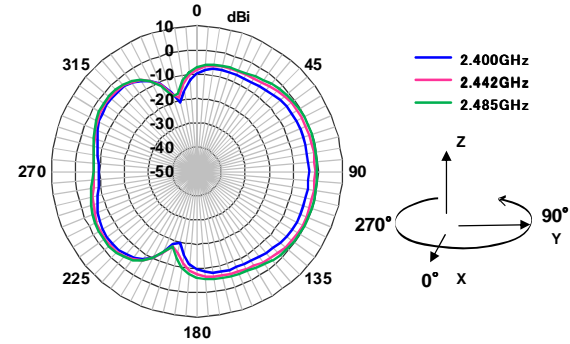

Total power

Frequency(GHz)	2.4	2.442	2.485
Average[dBi]	-6.0	-4.1	-3.3
Maximum[dBi]	-3.5	-1.0	-0.2
Minimum[dBi]	-20.5	-18.4	-17.4

ZY plane

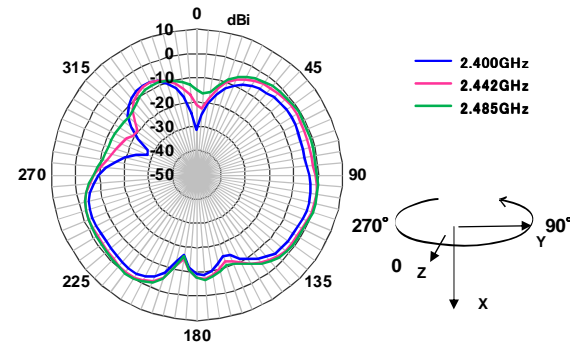

Total power

Frequency(GHz)	2.4	2.442	2.485
Average[dBi]	-6.2	-4.2	-3.5
Maximum[dBi]	-2.1	0.0	0.4
Minimum[dBi]	-31.4	-22.5	-16.5

TDK Radiation pattern 5GHz band Total power

Initial

P2

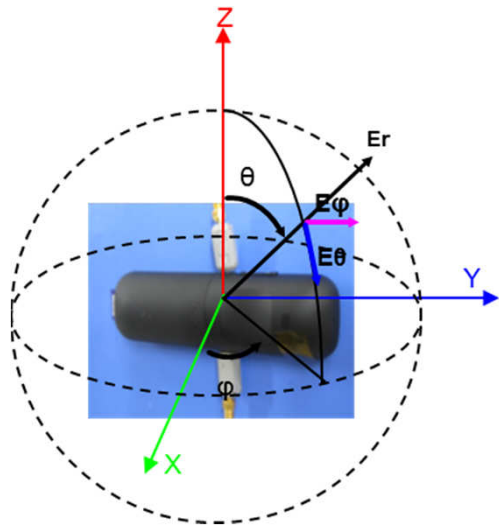

ZX plane

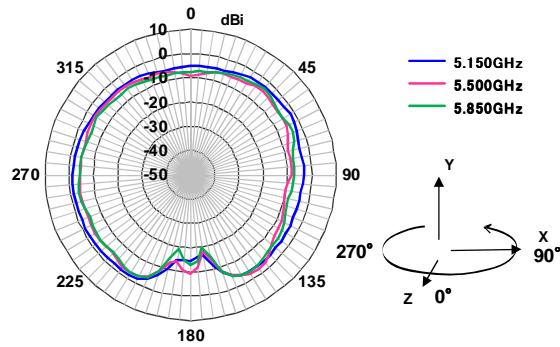

Total Power

Frequency(GHz)	5.15	5.5	5.85
Average[dBi]	-3.4	-5.6	-5.6
Maximum[dBi]	-1.1	-2.1	-2.6
Minimum[dBi]	-16.3	-17.9	-19.4

XY plane

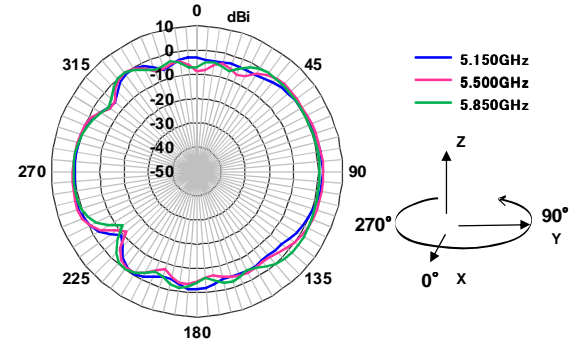

Total power

Frequency(GHz)	5.15	5.5	5.85
Average[dBi]	-1.3	-1.1	-1.0
Maximum[dBi]	2.0	2.2	1.8
Minimum[dBi]	-9.4	-12.0	-12.4

ZY plane

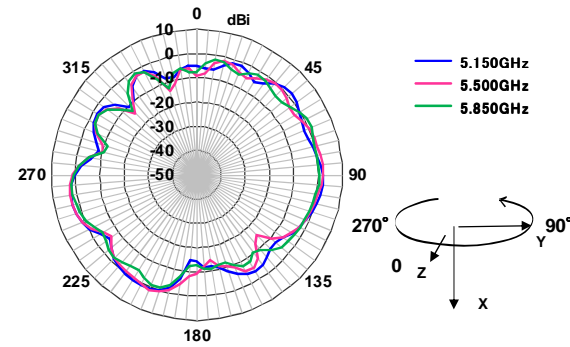

Total power

Frequency(GHz)	5.15	5.5	5.85
Average[dBi]	-1.9	-2.1	-2.7
Maximum[dBi]	2.5	2.8	1.9
Minimum[dBi]	-14.9	-14.9	-12.9

Radiation Pattern

Tuned

TDK Radiation pattern 2.4GHz band V&H Polarization

Tuned

P1

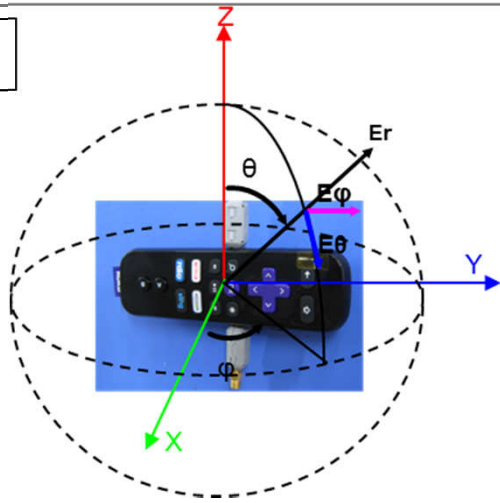

XY plane

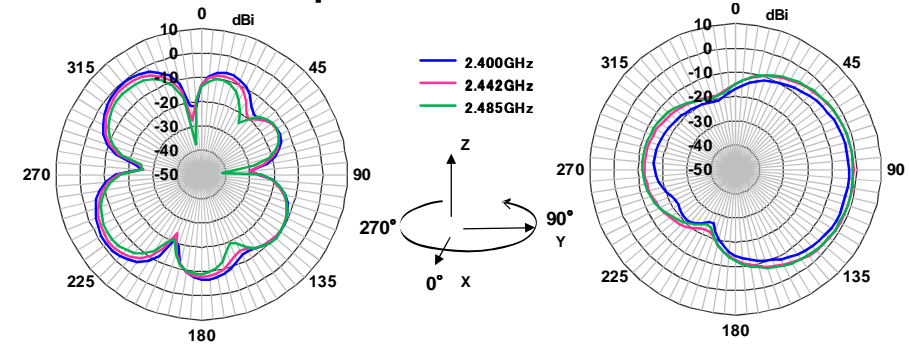

Horizontal Polarization

Frequency(GHz)	2.4	2.442	2.485
Average[dBi]	-6.9	-8.1	-9.6
Maximum[dBi]	-0.5	-1.8	-3.4
Minimum[dBi]	-29.9	-30.0	-41.4

Vertical Polarization

Frequency(GHz)	2.4	2.442	2.485
Average[dBi]	-8.7	-6.5	-6.5
Maximum[dBi]	-3.1	-1.2	-1.4
Minimum[dBi]	-26.2	-22.5	-24.4

ZX plane

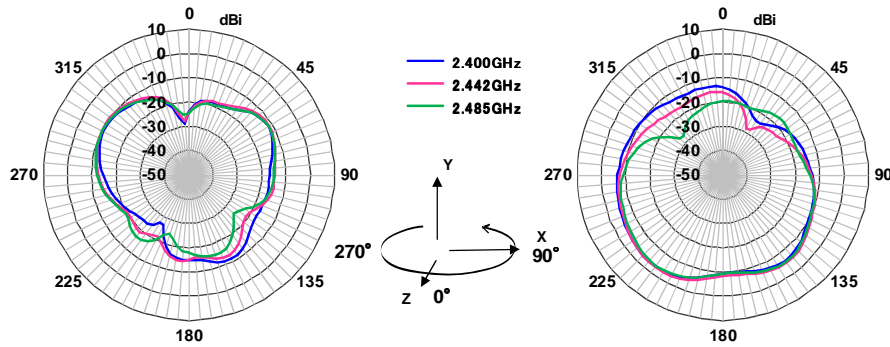

Horizontal Polarization

Frequency(GHz)	2.4	2.442	2.485
Average[dBi]	-14.8	-14.3	-14.9
Maximum[dBi]	-10.5	-9.7	-10.0
Minimum[dBi]	-28.5	-27.8	-25.4

Vertical Polarization

Frequency(GHz)	2.4	2.442	2.485
Average[dBi]	-8.37	-8.41	-9.32
Maximum[dBi]	-3.16	-2.77	-3.64
Minimum[dBi]	-23.87	-28.39	-27.45

ZY plane

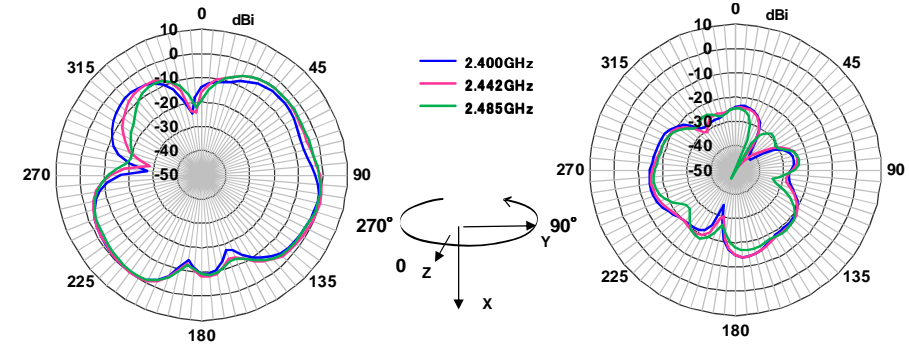

Horizontal Polarization

Frequency(GHz)	2.4	2.442	2.485
Average[dBi]	-5.1	-4.3	-4.8
Maximum[dBi]	-0.1	0.3	-0.4
Minimum[dBi]	-27.5	-28.2	-21.8

Vertical Polarization

Frequency(GHz)	2.4	2.442	2.485
Average[dBi]	-19.5	-19.7	-20.9
Maximum[dBi]	-13.8	-13.8	-16.1
Minimum[dBi]	-42.7	-48.7	-54.2

TDK Radiation pattern 5GHz band V&H Polarization

Tuned

P1

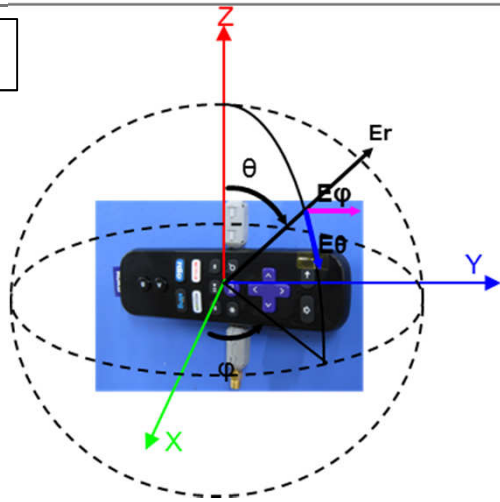

XY plane

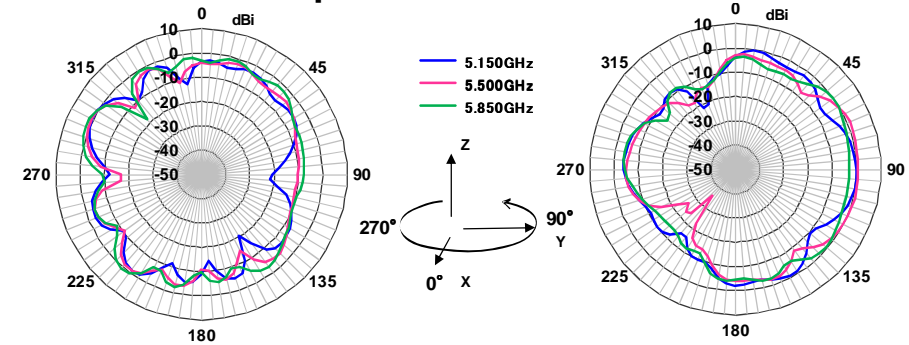

Horizontal Polarization

Frequency(GHz)	5.15	5.5	5.85
Average[dBi]	-5.2	-4.8	-3.5
Maximum[dBi]	0.3	0.8	1.8
Minimum[dBi]	-21.6	-17.0	-18.2

Vertical Polarization

Frequency(GHz)	5.15	5.5	5.85
Average[dBi]	-4.3	-3.9	-4.6
Maximum[dBi]	0.0	1.1	-0.1
Minimum[dBi]	-21.6	-35.6	-15.4

ZX plane

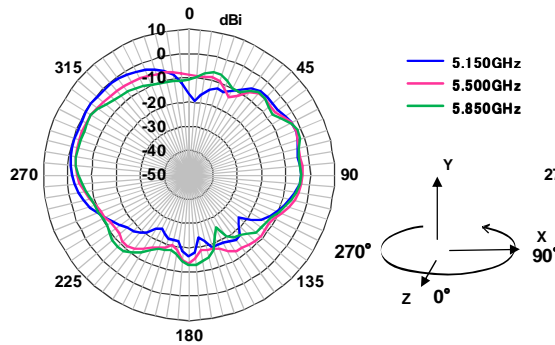

Horizontal Polarization

Frequency(GHz)	5.15	5.5	5.85
Average[dBi]	-5.5	-6.6	-7.1
Maximum[dBi]	-0.3	-2.1	-1.5
Minimum[dBi]	-25.3	-20.4	-25.6

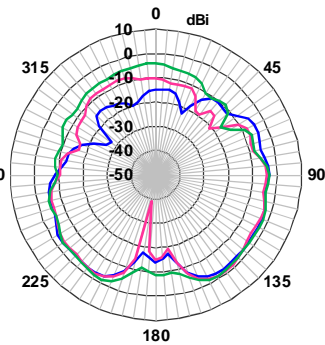

Vertical Polarization

Frequency(GHz)	5.15	5.5	5.85
Average[dBi]	-6.31	-6.39	-4.87
Maximum[dBi]	-2.20	-0.97	-1.07
Minimum[dBi]	-27.40	-38.82	-16.83

ZY plane

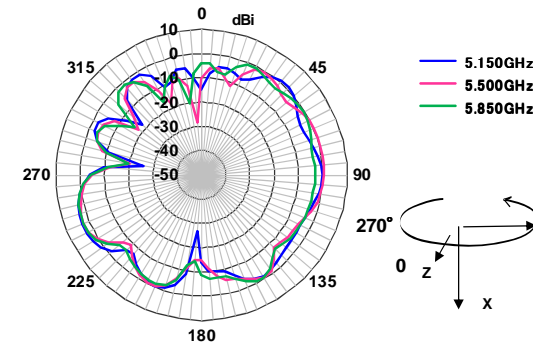

Horizontal Polarization

Frequency(GHz)	5.15	5.5	5.85
Average[dBi]	-2.5	-2.8	-3.0
Maximum[dBi]	3.1	2.7	2.7
Minimum[dBi]	-26.6	-28.1	-20.1

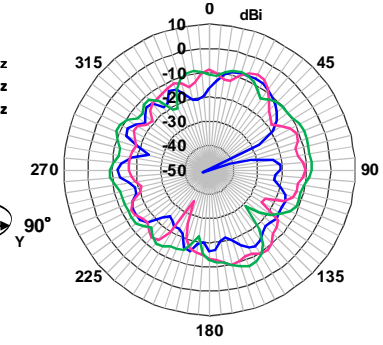

Vertical Polarization

Frequency(GHz)	5.15	5.5	5.85
Average[dBi]	-14.7	-12.7	-10.8
Maximum[dBi]	-7.8	-6.0	-7.1
Minimum[dBi]	-52.7	-35.6	-29.2



Radiation pattern 2.4GHz band Total power

Tuned

P1

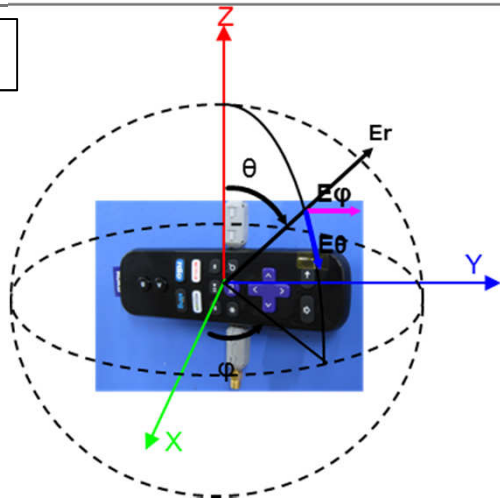

XY plane

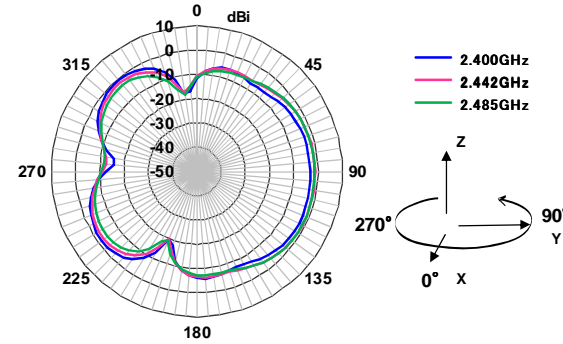

Total power

Frequency(GHz)	2.4	2.442	2.485
Average[dBi]	-4.7	-4.2	-4.8
Maximum[dBi]	-0.5	-1.0	-1.2
Minimum[dBi]	-19.9	-20.0	-19.1

ZX plane

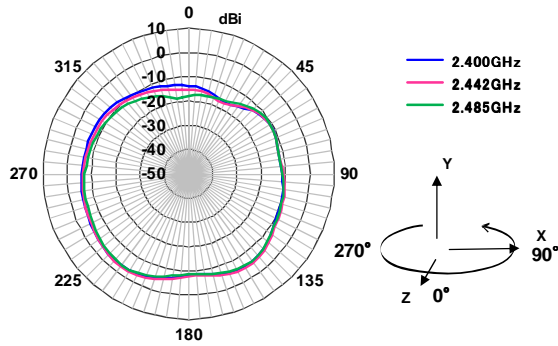

Total Power

Frequency(GHz)	2.4	2.442	2.485
Average[dBi]	-7.5	-7.4	-8.3
Maximum[dBi]	-3.1	-2.7	-3.4
Minimum[dBi]	-17.0	-17.3	-18.6

ZY plane

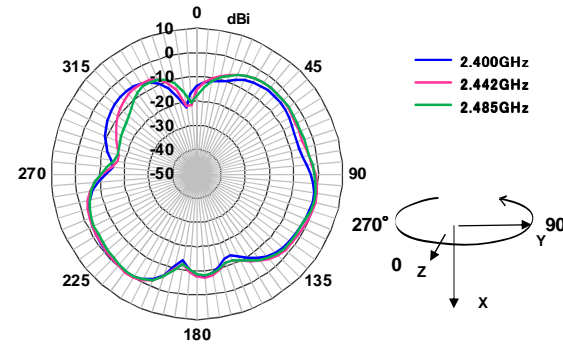

Total power

Frequency(GHz)	2.4	2.442	2.485
Average[dBi]	-5.0	-4.2	-4.7
Maximum[dBi]	-0.1	0.3	-0.4
Minimum[dBi]	-22.2	-21.5	-20.2

TDK Radiation pattern 5GHz band Total power

Tuned

P1

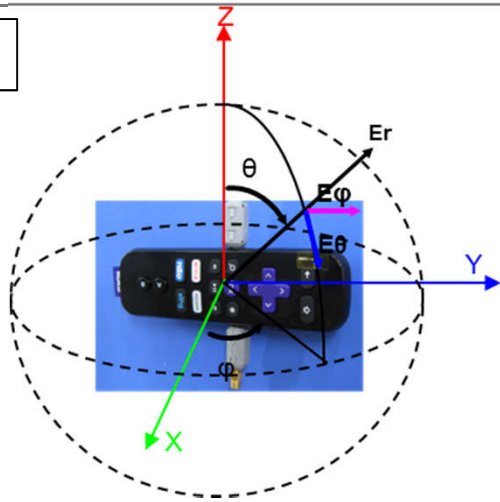

XY plane

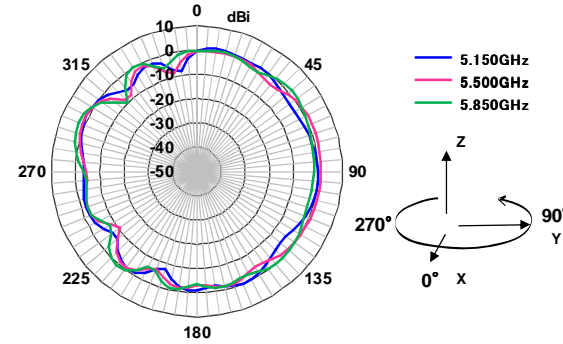

Total power

Frequency(GHz)	5.15	5.5	5.85
Average[dBi]	-1.7	-1.3	-1.0
Maximum[dBi]	1.2	1.6	2.4
Minimum[dBi]	-8.0	-10.7	-9.8

ZX plane

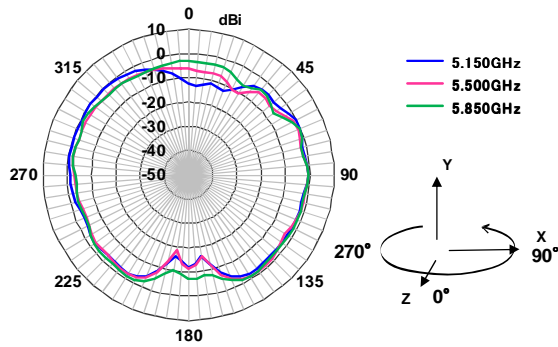

Total Power

Frequency(GHz)	5.15	5.5	5.85
Average[dBi]	-2.9	-3.5	-2.8
Maximum[dBi]	-0.1	-0.5	-0.4
Minimum[dBi]	-16.3	-18.4	-10.4

ZY plane

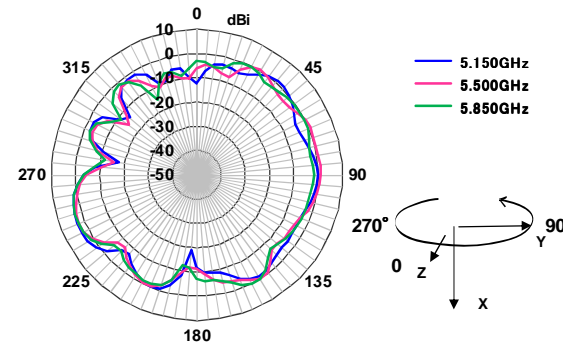

Total power

Frequency(GHz)	5.15	5.5	5.85
Average[dBi]	-2.3	-2.4	-2.3
Maximum[dBi]	3.1	2.8	2.9
Minimum[dBi]	-19.1	-15.3	-15.0

TDK Radiation pattern 2.4GHz band V&H Polarization

Tuned

P2

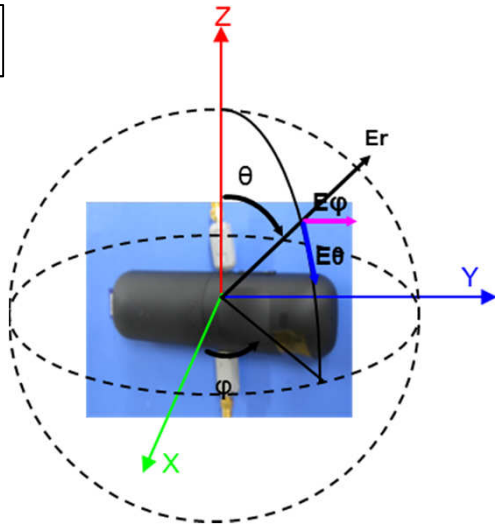

XY plane

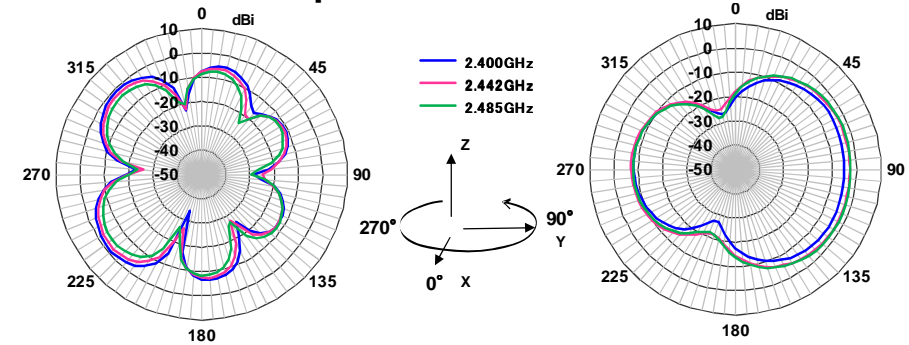

Horizontal Polarization

Frequency(GHz)	2.4	2.442	2.485
Average[dBi]	-6.7	-8.0	-9.6
Maximum[dBi]	-0.9	-2.3	-4.0
Minimum[dBi]	-34.3	-27.9	-29.3

Vertical Polarization

Frequency(GHz)	2.4	2.442	2.485
Average[dBi]	-8.5	-6.6	-6.4
Maximum[dBi]	-4.7	-2.4	-2.3
Minimum[dBi]	-27.3	-24.4	-27.7

ZX plane

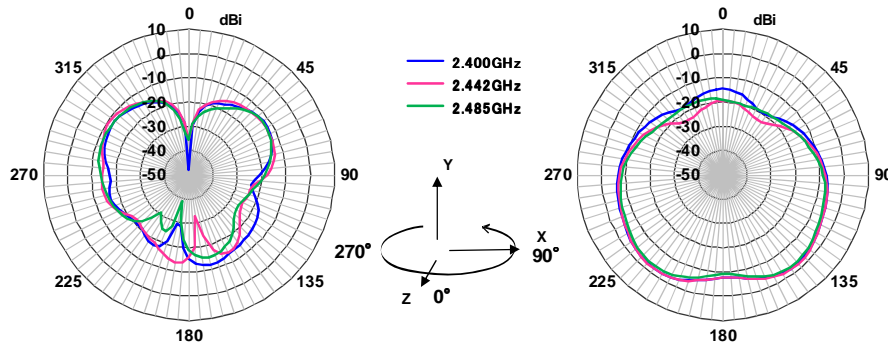

Horizontal Polarization

Frequency(GHz)	2.4	2.442	2.485
Average[dBi]	-15.8	-15.5	-16.4
Maximum[dBi]	-11.9	-10.7	-11.8
Minimum[dBi]	-47.8	-35.4	-38.6

Vertical Polarization

Frequency(GHz)	2.4	2.442	2.485
Average[dBi]	-6.67	-6.77	-7.79
Maximum[dBi]	-2.11	-1.80	-2.83
Minimum[dBi]	-19.56	-23.36	-19.84

ZY plane

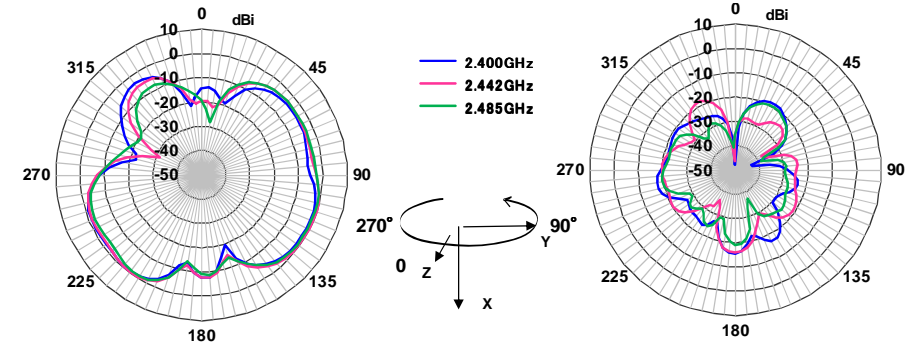

Horizontal Polarization

Frequency(GHz)	2.4	2.442	2.485
Average[dBi]	-4.8	-4.2	-4.8
Maximum[dBi]	-0.6	-0.3	-0.8
Minimum[dBi]	-22.2	-31.3	-27.8

Vertical Polarization

Frequency(GHz)	2.4	2.442	2.485
Average[dBi]	-21.6	-22.4	-24.3
Maximum[dBi]	-15.3	-15.7	-19.0
Minimum[dBi]	-47.8	-46.2	-40.5



Radiation pattern 5GHz band V&H Polarization

Tuned

P2

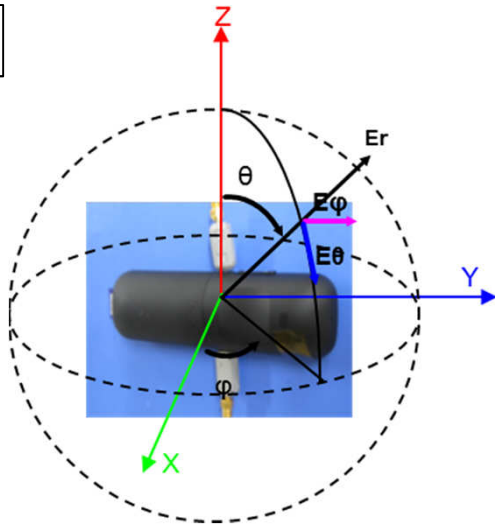

XY plane

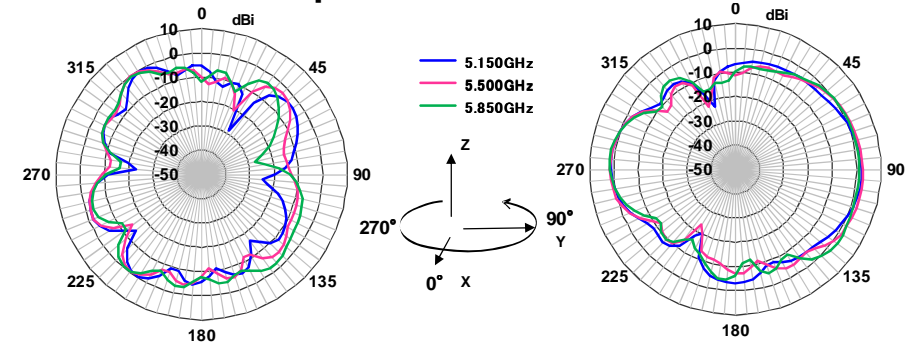

Horizontal Polarization

Frequency(GHz)	5.15	5.5	5.85
Average[dBi]	-6.1	-5.7	-5.3
Maximum[dBi]	-0.3	0.0	-0.3
Minimum[dBi]	-28.8	-20.5	-27.4

Vertical Polarization

Frequency(GHz)	5.15	5.5	5.85
Average[dBi]	-2.6	-2.1	-2.3
Maximum[dBi]	2.2	2.8	1.9
Minimum[dBi]	-23.0	-23.3	-15.8

ZX plane

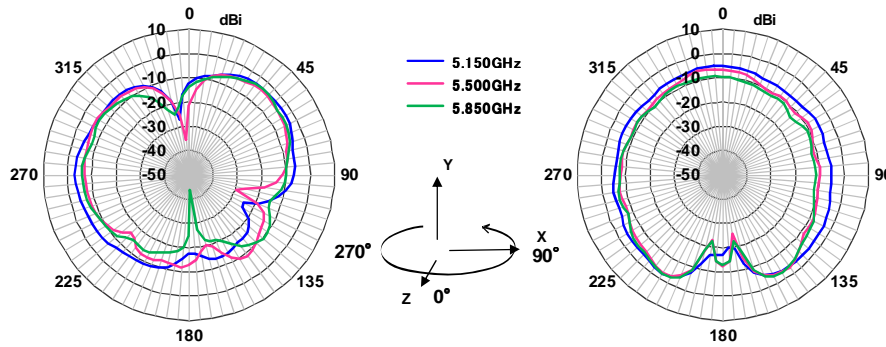

Horizontal Polarization

Frequency(GHz)	5.15	5.5	5.85
Average[dBi]	-6.9	-8.8	-8.9
Maximum[dBi]	-2.9	-3.7	-3.3
Minimum[dBi]	-26.9	-35.4	-43.6

Vertical Polarization

Frequency(GHz)	5.15	5.5	5.85
Average[dBi]	-5.30	-7.53	-7.84
Maximum[dBi]	-2.34	-2.74	-2.22
Minimum[dBi]	-20.20	-25.42	-22.20

ZY plane

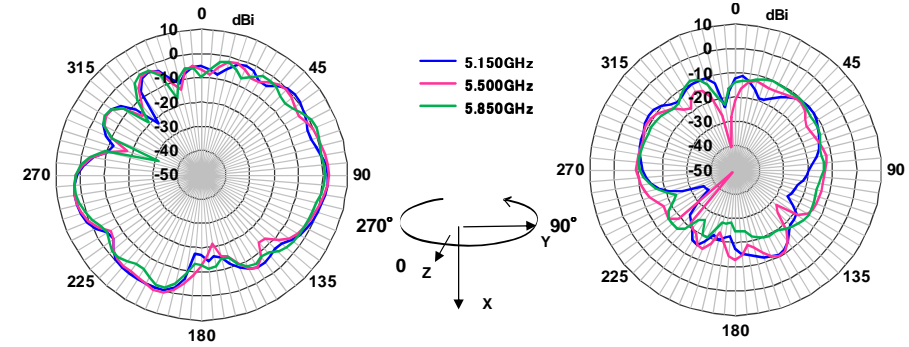

Horizontal Polarization

Frequency(GHz)	5.15	5.5	5.85
Average[dBi]	-2.0	-2.1	-2.7
Maximum[dBi]	2.8	3.0	2.4
Minimum[dBi]	-22.4	-21.4	-31.6

Vertical Polarization

Frequency(GHz)	5.15	5.5	5.85
Average[dBi]	-13.5	-13.5	-13.7
Maximum[dBi]	-7.8	-8.9	-9.0
Minimum[dBi]	-36.2	-48.6	-28.2

TDK Radiation pattern 2.4GHz band Total power

Tuned

P2

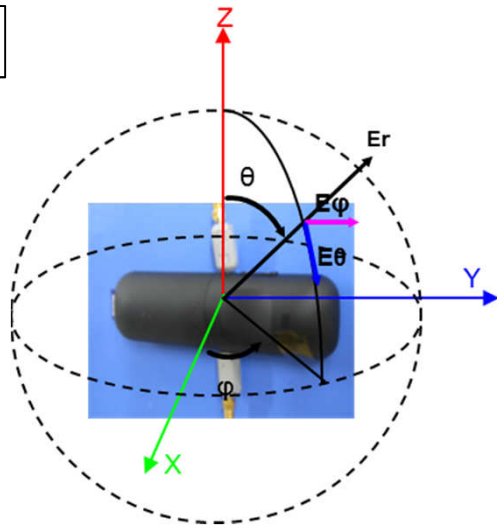

ZX plane

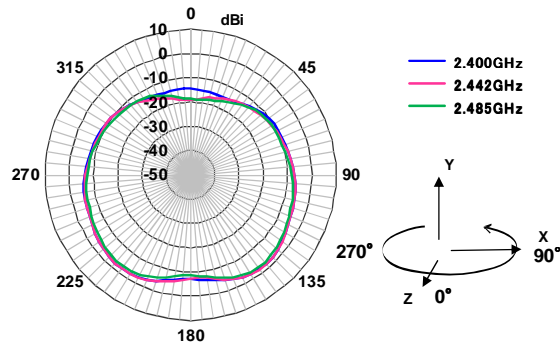

Total Power

Frequency(GHz)	2.4	2.442	2.485
Average[dBi]	-6.2	-6.2	-7.2
Maximum[dBi]	-1.9	-1.7	-2.8
Minimum[dBi]	-15.2	-19.2	-18.7

XY plane

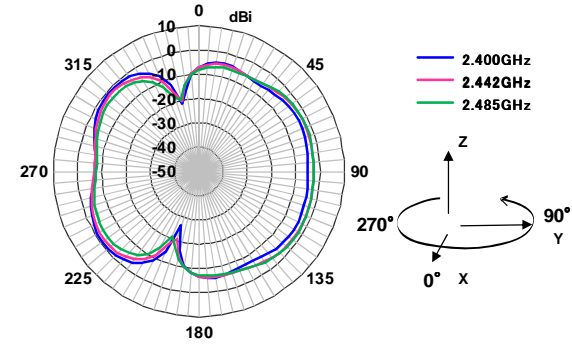

Total power

Frequency(GHz)	2.4	2.442	2.485
Average[dBi]	-4.5	-4.2	-4.7
Maximum[dBi]	-0.7	-1.8	-1.9
Minimum[dBi]	-26.5	-20.6	-20.8

ZY plane

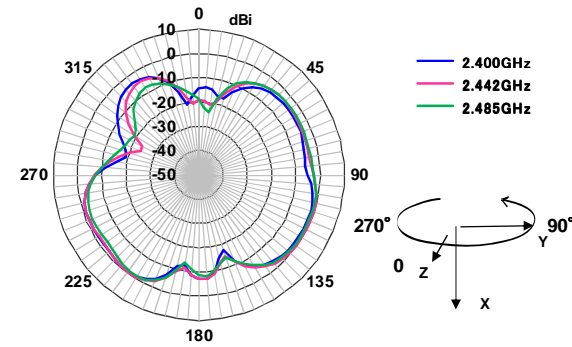

Total power

Frequency(GHz)	2.4	2.442	2.485
Average[dBi]	-4.7	-4.2	-4.8
Maximum[dBi]	-0.5	-0.2	-0.8
Minimum[dBi]	-20.7	-24.0	-24.0

TDK Radiation pattern 5GHz band Total power

Tuned

P2

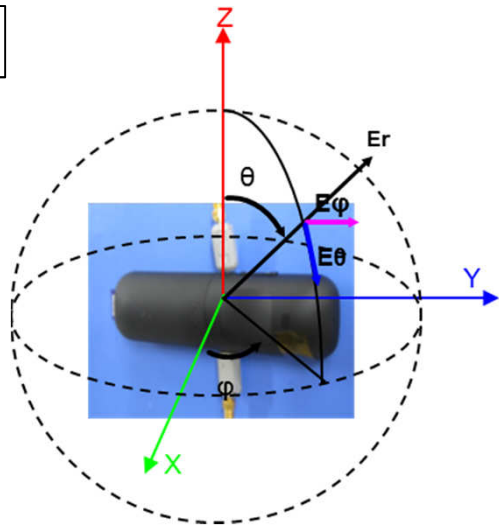

ZX plane

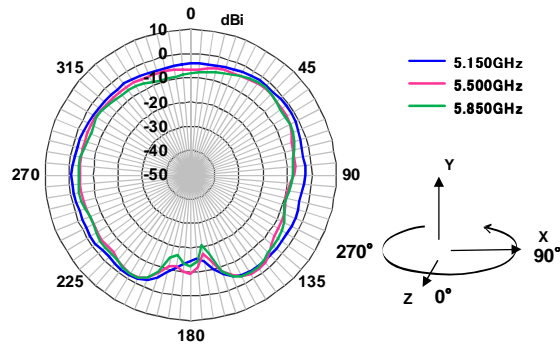

Total Power

Frequency(GHz)	5.15	5.5	5.85
Average[dBi]	-3.0	-5.1	-5.3
Maximum[dBi]	-0.9	-2.0	-1.9
Minimum[dBi]	-15.6	-17.3	-20.9

XY plane

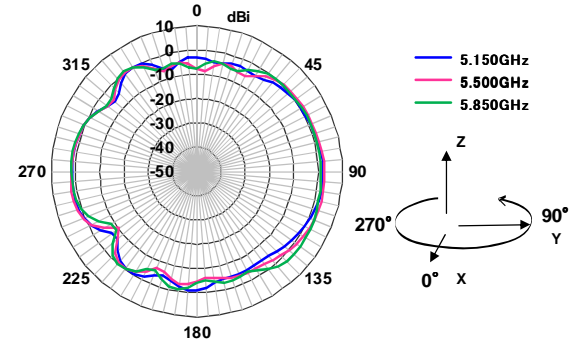

Total power

Frequency(GHz)	5.15	5.5	5.85
Average[dBi]	-1.0	-0.5	-0.5
Maximum[dBi]	2.2	3.0	2.8
Minimum[dBi]	-7.3	-10.1	-8.7

ZY plane

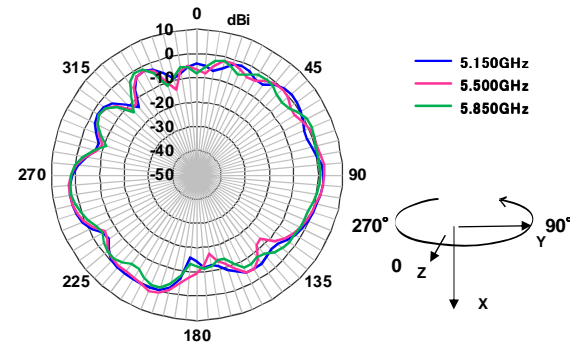

Total power

Frequency(GHz)	5.15	5.5	5.85
Average[dBi]	-1.7	-1.8	-2.4
Maximum[dBi]	2.9	3.1	2.5
Minimum[dBi]	-16.1	-16.8	-13.7



www.tdk.co.jp • www.epcos.com