



**FCC 47 CFR PART 15 SUBPART C &
INDUSTRY CANADA RSS-210**

TEST REPORT

For

IP-STB

Model: 2700X, 2710X

Trade Name: Roku

Issued to

Roku, Inc.

12980 Saratoga Avenue Suite #D Saratoga California United States 95070

Issued by

Compliance Certification Services Inc.

**No.11, Wugong 6th Rd., Wugu Dist.,
New Taipei City 24891, Taiwan. (R.O.C.)**

<http://www.ccsrf.com>

service@ccsrf.com

Issued Date: August 02, 2013



Note: This report shall not be reproduced except in full, without the written approval of Compliance Certification Services Inc. This document may be altered or revised by Compliance Certification Services Inc. personnel only, and shall be noted in the revision section of the document.



Revision History

Rev.	Issue Date	Revisions	Effect Page	Revised By
00	August 02, 2013	Initial Issue	ALL	Kelly Cheng



TABLE OF CONTENTS

1. TEST RESULT CERTIFICATION.....	4
2. EUT DESCRIPTION	5
3. TEST METHODOLOGY	6
3.1 EUT CONFIGURATION	6
3.2 EUT EXERCISE.....	6
3.3 GENERAL TEST PROCEDURES.....	6
3.4 FCC PART 15.205 RESTRICTED BANDS OF OPERATIONS.....	7
3.5 DESCRIPTION OF TEST MODES	8
4. INSTRUMENT CALIBRATION.....	9
4.1 MEASURING INSTRUMENT CALIBRATION	9
4.2 MEASUREMENT EQUIPMENT USED	9
4.3 MEASUREMENT UNCERTAINTY	10
5. FACILITIES AND ACCREDITATIONS	11
5.1 FACILITIES	11
5.2 EQUIPMENT.....	11
5.3 LABORATORY ACCREDITATIONS AND LISTING.....	11
5.4 TABLE OF ACCREDITATIONS AND LISTINGS.....	12
6. SETUP OF EQUIPMENT UNDER TEST	13
6.1 SETUP CONFIGURATION OF EUT.....	13
6.2 SUPPORT EQUIPMENT	13
7. APPLICABLE RULES FOR INDUSTRY CANADA RSS-210	14
8. FCC PART 15.247 REQUIREMENTS & RSS-210 REQUIREMENTS.....	23
8.1 99% BANDWIDTH	23
8.2 6DB BANDWIDTH.....	30
8.3 PEAK POWER.....	41
8.4 AVERAGE POWER	43
8.5 BAND EDGES MEASUREMENT	45
8.6 PEAK POWER SPECTRAL DENSITY.....	65
8.7 SPURIOUS EMISSIONS.....	76
8.8 RADIATED EMISSIONS	86
8.9 POWERLINE CONDUCTED EMISSIONS.....	100
APPENDIX II PHOTOGRAPHS OF TEST SETUP	103
APPENDIX 1 - PHOTOGRAPHS OF EUT	



1. TEST RESULT CERTIFICATION

Applicant: Roku, Inc.
 12980 Saratoga Avenue Suite #D Saratoga California United States
 95070

Manufacturer: DONG GUAN G-COM COMPUTER CO., LTD

Equipment Under Test: IP-STB

Trade Name: Roku

Model: 2700X, 2710X

Date of Test: May 15 ~ July 27, 2013

APPLICABLE STANDARDS	
STANDARD	TEST RESULT
FCC 47 CFR Part 15 Subpart C & Industry Canada RSS-210 Issue 8 December, 2010	No non-compliance noted

We hereby certify that:

The above equipment was tested by Compliance Certification Services Inc. The test data, data evaluation, test procedures, and equipment configurations shown in this report were made in accordance with the procedures given in ANSI C63.4: 2009 and the energy emitted by the sample EUT tested as described in this report is in compliance with the requirements of FCC Rules Part 15.207, 15.209, 15.247 and Industry Canada RSS-210.

The test results of this report relate only to the tested sample EUT identified in this report.

Approved by:

Reviewed by:

Miller Lee
 Section Manager
 Compliance Certification Services Inc.

Gina Lo
 Section Manager
 Compliance Certification Services Inc.



2. EUT DESCRIPTION

Product	IP-STB			
Trade Name	Roku			
Model Number	2700X, 2710X			
Model Discrepancy	The EUT comes with two color appearances but the internal structure is the same; please refer to the external photos for reference.			
Received Date	May 15, 2013			
Power Supply	1. Roku / Model: WA-06A12FU I/P: 100V-120V, 50Hz, 0.3A Max O/P: 12V, 0.5A 2. Roku / Model: FA-1200500SUA I/P: 120VAC, 60Hz, 0.3A O/P: 12V, 0.5A			
Frequency Range	2412 ~ 2462 MHz			
Transmit Power	Mode	Frequency Range	Output Power (dBm)	Output Power (mW)
	802.11b	2412 - 2462	18.22	66.3743
	802.11g	2412 - 2462	24.89	308.3188
	802.11n Standard-20 MHz	2412 - 2462	25.14	326.5878
Modulation Technique	IEEE 802.11b mode: DSSS (CCK,DQPSK,DBPSK) (1, 2, 5.5 and 11 Mbps) IEEE 802.11g mode: OFDM (CCK,DQPSK,DBPSK) (6, 9, 12, 18, 24, 36, 48 and 54 Mbps) IEEE 802.11n HT 20 MHz mode Channel mode: OFDM (6.5, 7.2, 13, 14.4, 14.44, 19.5, 21.7, 26, 28.89, 28.9, 39, 43.3, 43.33 52, 57.78, 57.8, 58.5, 65.0Mbps)			
Number of Channels	IEEE 802.11b/g mode: 11 Channels IEEE 802.11n HT 20 MHz mode Channel mode: 11 Channels			
Antenna Specification	For P/N: MSA-0419-2G4C1-A1: Gain: 3.88 dBi For P/N: MSA-0519-2G4C1-A2: Gain: 3.51 dBi			

Remark:

1. The sample selected for test was engineering sample that approximated to production product and was provided by manufacturer.



3. TEST METHODOLOGY

The tests documented in this report were performed in accordance with ANSI C63.4: 2009 and FCC CFR 47 Part 15.207, 15.209, 15.247, KDB558074.

The tests documented in this report were performed in accordance with IC RSS-210, IC RSS-Gen, IC RSS-102, IC RSS-212, and ANSI C63.4.

This submittal(s) (test report) is intended for IC Certification with Industry Canada RSS-210.

3.1 EUT CONFIGURATION

The EUT configuration for testing is installed on RF field strength measurement to meet the Commissions requirement and operating in a manner that intends to maximize its emission characteristics in a continuous normal application.

3.2 EUT EXERCISE

The EUT was operated in the engineering mode to fix the TX frequency that was for the purpose of the measurements.

According to its specifications, the EUT must comply with the requirements of the Section 15.207, 15.209 and 15.247 under the FCC Rules Part 15 Subpart C.

The tests documented in this report were performed in accordance with IC RSS-210, IC RSS-Gen, IC RSS-102, and ANSI C63.4.

3.3 GENERAL TEST PROCEDURES

Conducted Emissions

The EUT is placed on the turntable, which is 0.8 m above ground plane. According to the requirements in Section 13.1.4.1 of ANSI C63.4 Conducted emissions from the EUT measured in the frequency range between 0.15 MHz and 30MHz using CISPR Quasi-peak and average detector modes.

Radiated Emissions

The EUT is placed on a turn table, which is 0.8 m above ground plane. The turntable shall rotate 360 degrees to determine the position of maximum emission level. EUT is set 3m away from the receiving antenna, which varied from 1m to 4m to find out the highest emission. And also, each emission was to be maximized by changing the polarization of receiving antenna both horizontal and vertical. In order to find out the maximum emissions, exploratory radiated emission measurements were made according to the requirements in Section 13.1.4.1 of ANSI C63.4.



3.4 FCC PART 15.205 RESTRICTED BANDS OF OPERATIONS

(a) Except as shown in paragraph (d) of this section, only spurious emissions are permitted in any of the frequency bands listed below:

MHz	MHz	MHz	GHz
0.090 - 0.110	16.42 - 16.423	399.9 - 410	4.5 - 5.15
¹ 0.495 - 0.505	16.69475 - 16.69525	608 - 614	5.35 - 5.46
2.1735 - 2.1905	16.80425 - 16.80475	960 - 1240	7.25 - 7.75
4.125 - 4.128	25.5 - 25.67	1300 - 1427	8.025 - 8.5
4.17725 - 4.17775	37.5 - 38.25	1435 - 1626.5	9.0 - 9.2
4.20725 - 4.20775	73 - 74.6	1645.5 - 1646.5	9.3 - 9.5
6.215 - 6.218	74.8 - 75.2	1660 - 1710	10.6 - 12.7
6.26775 - 6.26825	108 - 121.94	1718.8 - 1722.2	13.25 - 13.4
6.31175 - 6.31225	123 - 138	2200 - 2300	14.47 - 14.5
8.291 - 8.294	149.9 - 150.05	2310 - 2390	15.35 - 16.2
8.362 - 8.366	156.52475 -	2483.5 - 2500	17.7 - 21.4
8.37625 - 8.38675	156.52525	2655 - 2900	22.01 - 23.12
8.41425 - 8.41475	156.7 - 156.9	3260 - 3267	23.6 - 24.0
12.29 - 12.293	162.0125 - 167.17	3332 - 3339	31.2 - 31.8
12.51975 - 12.52025	167.72 - 173.2	3345.8 - 3358	36.43 - 36.5
12.57675 - 12.57725	240 - 285	3600 - 4400	(²)
13.36 - 13.41	322 - 335.4		

¹ Until February 1, 1999, this restricted band shall be 0.490-0.510 MHz.

² Above 38.6

(b) Except as provided in paragraphs (d) and (e), the field strength of emissions appearing within these frequency bands shall not exceed the limits shown in Section 15.209. At frequencies equal to or less than 1000 MHz, compliance with the limits in Section 15.209 shall be demonstrated using measurement instrumentation employing a CISPR quasi-peak detector. Above 1000 MHz, compliance with the emission limits in Section 15.209 shall be demonstrated based on the average value of the measured emissions. The provisions in Section 15.35 apply to these measurements.



3.5 DESCRIPTION OF TEST MODES

The EUT (model: 2700X) comes with two types of power adapter (FA-1200500SUA & WA-06A12FU) for sale. After the preliminary test, the EUT with power adapter (Model: FA-1200500SUA) was found to emit the worst emissions and therefore had been tested under operating condition.

Software used to control the EUT for staying in continuous transmitting mode was programmed.

After verification, all tests were carried out with the worst case test modes as shown below except radiated spurious emission below 1GHz and power line conducted emissions below 30MHz, which worst case was in normal link mode only.

There are two antennas and one is for chain0(Transmitter) and another is for chain1(Receiver).

IEEE 802.11b mode:

Channel Low (2412MHz), Channel Mid (2437MHz) and Channel High (2462MHz) with 1Mbps data rate were chosen for full testing.

IEEE 802.11g mode:

Channel Low (2412MHz), Channel Mid (2437MHz) and Channel High (2462MHz) with 6Mbps data rate were chosen for full testing.

IEEE 802.11n HT 20 MHz mode:

Channel Low (2412MHz), Channel Mid (2437MHz) and Channel High (2462MHz) with 6.5Mbps data rate were chosen for full testing.



4. INSTRUMENT CALIBRATION

4.1 MEASURING INSTRUMENT CALIBRATION

The measuring equipment, which was utilized in performing the tests documented herein, has been calibrated in accordance with the manufacturer's recommendations for utilizing calibration equipment, which is traceable to recognized national standards.

4.2 MEASUREMENT EQUIPMENT USED

Equipment Used for Emissions Measurement

Remark: Each piece of equipment is scheduled for calibration once a year and Loop Antenna is scheduled for calibration once three years.

Conducted Emissions Test Site				
Name of Equipment	Manufacturer	Model	Serial Number	Calibration Due
Spectrum Analyzer	Agilent	E4446A	MY43360131	03/20/2014
Power Meter	Anritsu	ML2495A	1012009	04/25/2014
Power Sensor	Anritsu	MA2411B	0917072	04/25/2014

Wugu 966 Chamber A				
Name of Equipment	Manufacturer	Model	Serial Number	Calibration Due
Spectrum Analyzer	Agilent	E4446A	US42510252	11/01/2013
EMI Test Receiver	R&S	ESCI	100064	02/15/2014
Pre-Amplifier	Mini-Circuits	ZFL-1000LN	SF350700823	01/11/2014
Pre-Amplifier	MITEQ	AFS44-00102650-42-10P-44	1415367	11/18/2013
Bilog Antenna	Sunol Sciences	JB3	A030105	10/02/2013
Horn Antenna	EMCO	3117	00055165	01/10/2014
Horn Antenna	EMCO	3116	00026370	10/11/2013
Loop Antenna	EMCO	6502	8905/2356	06/09/2014
Turn Table	CCS	CC-T-1F	N/A	N.C.R
Antenna Tower	CCS	CC-A-1F	N/A	N.C.R
Controller	CCS	CC-C-1F	N/A	N.C.R
Site NSA	CCS	N/A	N/A	12/24/2013
Test S/W	EZ-EMC (CCS-3A1RE)			

Conducted Emission room # A				
Name of Equipment	Manufacturer	Model	Serial Number	Calibration Due
Test RECEIVER	R&S	ESCI	101201	09/10/2013
LISN (EUT)	SCHWARZBECK	NSLK 8127	8127527	12/11/2013
LISN	SCHWARZBECK	NSLK 8127	8127526	12/11/2013
BNC CABLE	EMCI	5Dr	BNC A6	12/11/2013
Pulse Limiter	R&S	ESH3-Z2	C3010026-2	09/07/2013
THERMO-HYGRO METER	WISEWIND	201A	No.02	05/14/2014
Test S/W	CCS-3A1-CE			



4.3 MEASUREMENT UNCERTAINTY

PARAMETER	UNCERTAINTY
Powerline Conducted Emission	+/- 1.2575
3M Semi Anechoic Chamber / < 200M	+/- 4.0138
3M Semi Anechoic Chamber / 200M~1000M	+/- 3.9483
3M Semi Anechoic Chamber / 1G~8G	+/- 2.5975
3M Semi Anechoic Chamber / 8G~18G	+/- 2.6112
3M Semi Anechoic Chamber / 18G~26G	+/- 2.7389
3M Semi Anechoic Chamber / 26G~40G	+/- 2.9683

Remark: This uncertainty represents an expanded uncertainty expressed at approximately the 95% confidence level using a coverage factor of $k=2$.



5. FACILITIES AND ACCREDITATIONS

5.1 FACILITIES

All measurement facilities used to collect the measurement data are located at

No.199, Chunghsen Road, Hsintien City, Taipei Hsien, Taiwan, R.O.C.

Tel: 886-2-2217-0894 / Fax: 886-2-2217-1029

Remark: The conducted emissions test items was tested at Compliance Certification Services Inc. (Hsinchu Lab.) The test equipments were listed in page 9 and the test data, please refer page 101-102.

No.11, Wugong 6th Rd., Wugu Dist., New Taipei City 24891, Taiwan. (R.O.C.)

Tel: 886-2-2299-9720 / Fax: 886-2-2298-4045

No.81-1, Lane 210, Bade 2nd Rd., Lujhu Township, Taoyuan County 33841, TAIWAN, R.O.C.

Tel: 886-3-324-0332 / Fax: 886-3-324-5235

The sites are constructed in conformance with the requirements of ANSI C63.7, ANSI C63.4 and CISPR Publication 22.

5.2 EQUIPMENT

Radiated emissions are measured with one or more of the following types of linearly polarized antennas: tuned dipole, biconical, log periodic, bi-log, and/or ridged waveguide, horn. Spectrum analyzers with pre-selectors and quasi-peak detectors are used to perform radiated measurements.

Conducted emissions are measured with Line Impedance Stabilization Networks and EMI Test Receivers.

Calibrated wideband preamplifiers, coaxial cables, and coaxial attenuators are also used for making measurements.



All receiving equipment conforms to CISPR Publication 16-1, "Radio Interference Measuring Apparatus and Measurement Methods."

5.3 LABORATORY ACCREDITATIONS AND LISTING

The test facilities used to perform radiated and conducted emissions tests are accredited by American Association for Laboratory Accreditation Program for the specific scope accreditation under Lab Code: 0824-01 to perform Electromagnetic Interference tests according to FCC Part 15 and CISPR 22 requirements. In addition, the test facilities are listed with Industry Canada, Certification and Engineering Bureau, IC 2324G-1 for 3M Semi Anechoic Chamber A, 2324G-2 for 3M Semi Anechoic Chamber B.



5.4 TABLE OF ACCREDITATIONS AND LISTINGS

Country	Agency	Scope of Accreditation	Logo
USA	FCC	3M Semi Anechoic Chamber (FCC MRA: TW1039) to perform FCC Part 15 measurements	 FCC MRA: TW1039
Taiwan	TAF	LP0002, RTTE01, FCC Method-47 CFR Part 15 Subpart C, D, E, RSS-210, RSS-310 IDA TS SRD, AS/NZS 4268, AS/NZS 4771, TS 12.1 & 12.2, ETSI EN 300 440-1, ETSI EN 300 440-2, ETSI EN 300 328, ETSI EN 300 220-1, ETSI EN 300 220-2, ETSI EN 301 893, ETSI EN 301 489-1/3/7/17 FCC OET Bulletin 65 + Supplement C, EN 50360, EN 50361, EN 50371, RSS 102, EN 50383, EN 50385, EN 50392, IEC 62209, CNS 14958-1, CNS 14959 FCC Method -47 CFR Part 15 Subpart B IEC / EN 61000-3-2, IEC / EN 61000-3-3, IEC / EN 61000-4-2/3/4/5/6/8/11	 Testing Laboratory 1309
Canada	Industry Canada	3M Semi Anechoic Chamber (IC 2324G-1 / IC 2324G-2) to perform	 IC 2324G-1 IC 2324G-2

* No part of this report may be used to claim or imply product endorsement by A2LA or any agency of the US Government.



6. SETUP OF EQUIPMENT UNDER TEST

6.1 SETUP CONFIGURATION OF EUT

See test photographs attached in Appendix II for the actual connections between EUT and support equipment.

The EUT exercise program used during conducted testing was designed to exercise the EUT in a manner similar to a typical use. The exercise sequence is listed as below :

1. Turn on the power of all equipments.
2. Execute the test program
3. Choose the test mode and setup the parameter.
4. Test it.
5. Repeat the above steps.

Note: Let the EUT operating in the RF Test mode must be performed Software by notebook to control Fixture(hardware)

6.2 SUPPORT EQUIPMENT

No	Equipment	Brand	Model	Series No.	FCC ID	Data Cable	Power Cord
1.	Notebook PC	IBM	7663 (T61)	L3E9812	E2K5HCKT	N/A	AC I/P: Unshielded, 1.8m DC O/P: Unshielded, 1.8m with a core

Remark:

1. All the equipment/cables were placed in the worst-case configuration to maximize the emission during the test.
2. Grounding was established in accordance with the manufacturer's requirements and conditions for the intended use.



7. APPLICABLE RULES FOR INDUSTRY CANADA RSS-210

RSS-210 §2 General Certification Requirements and Specifications

RSS-210 §2.1 RSS-Gen Compliance

In addition to RSS-210, the requirements in RSS-Gen, *General Requirements and Information for the Certification of Radio Apparatus*, must be met.

RSS-210 §2.2 Emissions Falling Within Restricted Frequency Bands

Category I licence-exempt equipment is required to comply with the provisions in RSS-Gen with respect to emissions falling within restricted frequency bands. These restricted frequency bands are listed in RSS-Gen.

RSS-210 §2.3 Receivers

Category I equipment receivers for use with transmitters subject to RSS-210 must comply with the applicable requirements set out in RSS-Gen and be certified under RSS-210. Category II equipment receivers for use with transmitters subject to RSS-210 are exempt from certification, but are subject to compliance with RSS-Gen and RSS-310.

RSS-210 §2.5 General Field Strength Limits

RSS-Gen includes the general field strength limits of unwanted emissions, where applicable, for transmitters and receivers operating in accordance with the provisions specified in this standard. Unwanted emissions of transmitters and receivers are permitted to fall within the restricted bands listed in RSS-Gen, and including the TV bands, but fundamental emissions are prohibited in the restricted bands.

RSS-210 §2.5.1 Transmitters with Wanted Emissions that are Within the General Field Strength Limits

Whether or not their operation is addressed by published RSS standards, transmitters whose wanted and unwanted emissions are within the general field strength limits shown in RSS-Gen, they may operate in any of the frequency bands, other than the restricted bands listed in RSS-Gen and including the TV bands, and shall be certified under RSS-210. Under no conditions may the level of any unwanted emissions exceed the level of the fundamental emission.

Note: Devices operating below 490 kHz in which all emissions are at least 40 dB below the limit listed in RSS-Gen (*General Field Strength Limits for Transmitters at Frequencies below 30 MHz*) are Category II devices and are subject to RSS-310.



RSS-210 §2.7 Tables

RSS-210 §Annex A2.9: Frequency Hopping and Digital Modulation Systems Operating in the 902-928 MHz, 2400-2483.5 MHz, and 5725-5850 MHz Bands

This section applies to systems that employ frequency hopping (FH) and digital modulation technology in the 902-928 MHz, 2400-2483.5 MHz and 5725-5850 MHz bands. Systems in these bands may employ frequency hopping, digital modulation and or a combination (hybrid) of both techniques.

A frequency hopping system that synchronizes with another or several other systems (to avoid frequency collision among them) via off-air sensing or via connecting cables is not hopping randomly and therefore is not in compliance with RSS-210.

RSS-210 §A8.1 Frequency Hopping Systems

Frequency hopping systems are spread spectrum systems in which the carrier is modulated with coded information in a conventional manner causing a conventional spreading of the RF energy about the carrier frequency. The frequency of the carrier is not fixed but changes at fixed intervals under the direction of a coded sequence.

Frequency hopping systems are not required to employ all available hopping frequencies during each transmission. However, the system, consisting of both the transmitter and the receiver, must be designed to comply with all of the regulations in this section should the transmitter be presented with a continuous data (or information) stream.

Incorporation of intelligence into a frequency hopping system that enables it to recognize other users of the band and to avoid occupied frequencies is permitted, provided that the frequency hopping system does it individually, and independently chooses or adapts its hopset. The coordination of frequency hopping systems in any other manner for the express purpose of avoiding the simultaneous occupancy of individual hopping frequencies by multiple transmitters is not permitted.

The following applies to frequency hopping systems in each of the three bands.

(a) The bandwidth of a frequency hopping channel is the 20 dB emission bandwidth, measured with the hopping stopped. The system RF bandwidth is equal to the channel bandwidth multiplied by the number of channels in the hopset. The hopset shall be such that the near term distribution of frequencies appears random, with sequential hops randomly distributed in both direction and magnitude of change in the hopset while the long term distribution appears evenly distributed.



(b) Frequency hopping systems shall have hopping channel carrier frequencies separated by a minimum of 25 kHz or the 20 dB bandwidth of the hopping channel, whichever is greater. Alternatively, frequency hopping systems operating in the 2400-2483.5 MHz band may have hopping channel carrier frequencies that are separated by 25 kHz or two-thirds of the 20 dB bandwidth of the hopping channel, whichever is greater, provided the systems operate with an output power no greater than 0.125 W. The system receivers shall have input bandwidths that match the hopping channel bandwidths of their corresponding transmitters and shall shift frequencies in synchronization with the transmitted signals.

(d) Frequency hopping systems operating in the 2400-2483.5 MHz band shall use at least 15 hopping channels. The average time of occupancy on any channel shall not be greater than 0.4 seconds within a period of 0.4 seconds multiplied by the number of hopping channels employed. Transmissions on particular hopping frequencies may be avoided or suppressed provided that a minimum of 15 hopping channels are used.

RSS-210 §A8.2 Digital Modulation Systems

These include systems employing digital modulation techniques resulting in spectral characteristics similar to direct sequence systems. The following applies to all three bands.

RSS-210 §A8.4 Transmitter Output Power and e.i.r.p. Requirements

(4) For systems employing digital modulation techniques operating in the 902-928 MHz, 2400-2483.5 MHz and 5725-5850 MHz bands, the maximum peak conducted power shall not exceed 1 W. Except as provided in Section A8.4(5), the e.i.r.p. shall not exceed 4 W.

As an alternative to a peak power measurement, compliance can be based on a measurement of the maximum conducted output power (see RSS-Gen)

(5) Point-to-point systems in the bands 2400-2483.5 MHz and 5725-5850 MHz are permitted to have an e.i.r.p. higher than 4 W, provided that the higher e.i.r.p. is achieved by employing higher gain directional antennas and not higher transmitter output powers. Point-to-multipoint systems, omni-directional applications and multiple co-located transmitters transmitting the same information are prohibited from exceeding 4 W e.i.r.p. However, remote stations of point-to-multipoint systems shall be allowed to operate at greater than 4 W e.i.r.p. under the same conditions as for point-to-point systems.

Note: "Fixed, point-to-point operation", excludes point-to-multipoint systems, omnidirectional applications and multiple co-located transmitters transmitting the same information.



RSS-210 §A8.5 Out-of-band Emissions

In any 100 kHz bandwidth outside the frequency band in which the spread spectrum or digitally modulated device is operating, the radio frequency power that is produced shall be at least 20 dB below that in the 100 kHz bandwidth within the band that contains the highest level of the desired power, based on either an RF conducted or a radiated measurement, provided the transmitter demonstrates compliance with the peak conducted power limits. If the transmitter complies with the conducted power limits based on the use of RMS averaging over a time interval, as permitted under section A8.4(4), the attenuation required shall be 30 dB instead of 20 dB. Attenuation below the general limits specified in Tables 2 and 3 is not required.

RSS-Gen §2 General Information

RSS-Gen §2.1.2 Category II Equipment

Category II equipment comprises radio devices where a standard has been prescribed but for which a TAC is not required, that is, equipment certification by Industry Canada or a Certification Body (CB) is not required (certification exempt), pursuant to subsection 4(3) of the Radiocommunication Act. The manufacturer or importer shall nevertheless ensure that the standards are complied with. A test report shall be available on request and the device shall be properly labelled.

RSS-Gen §2.2 Receivers

Receivers that are used for radiocommunication other than broadcasting are defined as Category I equipment or Category II equipment, subject to compliance with applicable Industry Canada standards.

Receivers shall be capable of operation only with transmitters for which RSSs are published. Receivers are classified as described in sections 2.2.1 and 2.2.2.

RSS-Gen §2.2.1 Category I Equipment Receivers

A receiver is classified as Category I equipment if it meets one of the following conditions:

- (a) a stand-alone receiver (see Note 1, below), which operates on any frequency in the band 30-960 MHz, and is used for the reception of signals in that frequency band from a transmitter classified as Category I equipment;
- (b) a Citizen's Band (CB) receiver (26.96-27.410 MHz);
- (c) a scanner receiver.

Note 1: A *stand-alone receiver* is defined as any receiver that is not permanently combined together with a transmitter in a single case (transceiver), in which it functions as the receiver component of the transceiver.

Receivers classified as Category I equipment shall comply with the limits for receiver spurious emissions set out in RSS-Gen; however, equipment certification is granted under the applicable RSS standard along with the associated transmitter classified as Category I equipment. Scanner receivers are covered under their own specific RSS.

RSS-Gen §2.2.2 Category II Equipment Receivers

A receiver is classified as Category II equipment if it does not meet any of the conditions of Section 2.2.1.

Category II receivers shall comply with the applicable testing, labelling and user manual requirements in RSS-310.



RSS-Gen §5.6 Exposure of Humans to RF Fields

Category I and Category II equipment shall comply with the applicable requirements of RSS-102.

RSS-Gen §6 Receiver Spurious Emission Standard

Receivers shall comply with the limits of spurious emissions set out in this section, measured over the frequency range determined in accordance with Section 4.10.

RSS-Gen §6.1 Radiated Limits

Radiated spurious emission measurements shall be performed with the receiver antenna connected to the receiver antenna terminals.

Spurious emissions from receivers shall not exceed the radiated limits shown in the table below:

RSS-Gen Table 2 - Spurious Emission Limits for Receivers

Frequency (MHz)	Field Strength microvolts/m at 3 metres
30-88	100
88-216	150
216-960	200
Above 960	500

*Measurements for compliance with limits in the above table may be performed at distances other than 3 metres, in accordance with Section 7.2.7.



RSS- Gen Table 3: Restricted Frequency Bands ^(Note)

MHz	MHz	MHz	MHz	GHz
0.090-0.110	8.37625-8.38675	--	1718.8-1722.2	9.0-9.2
--	8.41425-8.41475	156.52475-156.52525	2200-2300	9.3-9.5
2.1735-2.1905	12.29-12.293	156.7-156.9	2310-2390	10.6-12.7
3.020-3.026	12.51975-12.52025	--	--	13.25-13.4
4.125-4.128	12.57675-12.57725	--	2655-2900	14.47-14.5
4.17725-4.17775	13.36-13.41	240-285	3260-3267	15.35-16.2
4.20725-4.20775	16.42-16.423	322-335.4	3332-3339	17.7-21.4
5.677-5.683	16.69475-16.69525	399.9-410	3345.8-3358	22.01-23.12
6.215-6.218	16.80425-16.80475	608-614	3500-4400	23.6-24.0
6.26775-6.26825	25.5-25.67	960-1427	4500-5150	31.2-31.8
6.31175-6.31225	37.5-38.25	1435-1626.5	5350-5460	36.43-36.5
8.291-8.294	73-74.6; 74.8-75.2	1645.5-1646.5	7250-7750	Above 38.6
8.362-8.366	108-138	1660-1710	8025-8500	

Note: Certain frequency bands listed in Table 2 and above 38.6 GHz are designated for low-power licence-exempt applications. These frequency bands and the requirements that apply to the devices are set out in this Standard as well as RSS-310.

RSS- Gen Table 5: General Field Strength Limits for Transmitters at Frequencies Above 30 MHz

Frequency (MHz)	Field Strength (microvolt/m at 3 metres)
30-88	100
88-216	150
216-960	200
Above 960	500

Note: Transmitting devices are not permitted in Table 1 bands or, unless stated otherwise, in TV bands(54-72 MHz, 76-88 MHz, 174-216 MHz, 470-608 MHz and 614-806 MHz).



RSS- Gen Table 6: General Field Strength Limits for Transmitters at Frequencies Below 30 MHz (Transmit)

Frequency (fundamental or spurious)	Field Strength (microvolts/m)	Magnetic H-Field (microamperes/m)	Measurement Distance (metres)
9-490 kHz	2,400/F (F in kHz)	2,400/377F (F in Hz)	300
490-1.705 kHz	24,000/F (F in kHz)	24,000/377F (F in kHz)	30
1.705-30 MHz	30	N/A	30

Note: The emission limits for the bands 9-90 kHz and 110-490 kHz are based on measurements employing an average detector.



RSS-Gen §7.1.2 Transmitter Antenna

A transmitter can only be sold or operated with antennas with which it was approved. Transmitter may be approved with multiple antenna types. An antenna type comprises antennas having similar in-band and out-of-band radiation patterns. Testing shall be performed using the highest gain antenna of each combination of transmitter and antenna type for which approval is being sought, with the transmitter output power set at the maximum level. Any antenna of the same type having equal or lesser gain as an antenna that had been successfully tested with the transmitter, will also be considered approved with the transmitter, and may be used and marketed with the transmitter. For Category I transmitters, the manufacturer shall include with the application for certification a list of acceptable antenna types to be used with the transmitter.

When a measurement at the antenna connector is used to determine RF output power, the effective gain of the device's antenna shall be stated, based on measurement or on data from the antenna manufacturer.

For transmitters of RF output power of 10 milliwatts or less, only the portion of the antenna gain that is in excess of 6 dBi (6 dB above isotropic gain) shall be added to the measured RF output power to demonstrate compliance with the radiated power limits specified in the applicable standard. For transmitters of output power greater than 10 milliwatts, the total antenna gain shall be added to the measured RF output power to demonstrate compliance to the specified radiated power limits. User manuals for transmitters shall display the following notice in a conspicuous location:

Under Industry Canada regulations, this radio transmitter may only operate using an antenna of a type and maximum (or lesser) gain approved for the transmitter by Industry Canada. To reduce potential radio interference to other users, the antenna type and its gain should be so chosen that the equivalent isotropically radiated power (e.i.r.p.) is not more than that necessary for successful communication.

The above notice may be affixed to the device instead of displayed in the user manual.

User manuals for transmitters equipped with detachable antennas shall also contain the following notice in a conspicuous location:

This radio transmitter (identify the device by certification number, or model number if Category II) has been approved by Industry Canada to operate with the antenna types listed below with the maximum permissible gain and required antenna impedance for each antenna type indicated. Antenna types not included in this list, having a gain greater than the maximum gain indicated for that type, are strictly prohibited for use with this device.

Immediately following the above notice, the manufacturer shall provide a list of all antenna types approved for use with the transmitter, indicating the maximum permissible antenna gain (in dBi) and required impedance for each.



RSS-Gen §7.2.4 Transmitter and Receiver AC Power Lines Conducted Emission Limits

Except when the requirements applicable to a given device state otherwise, for any radio apparatus equipped to operate from the public utility AC power supply, either directly or indirectly (such as with a battery charger), the radio frequency voltage of emissions conducted back onto the AC power lines in the frequency range of 0.15 MHz to 30 MHz shall not exceed the limits shown in the table below. The more stringent limit applies at the frequency range boundaries.

The conducted emissions shall be measured with a 50 ohm/50 microhenry line impedance stabilization network (LISN).

RSS-Gen Table 4 – AC Power Line Conducted Emission Limits

Frequency Range (MHz)	Conducted limit (dBµV)	
	Quasi-peak	Average
0.15 to 0.5	66 to 56*	56 to 46*
0.5 to 5	56	46
5 to 30	60	50

**Decreases with the logarithm of the frequency.*



8. FCC PART 15.247 REQUIREMENTS & RSS-210 REQUIREMENTS

8.1 99% BANDWIDTH

Test Configuration

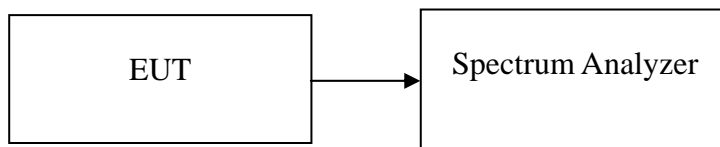

TEST PROCEDURE

The resolution bandwidth shall be set to as close to 1% of the selected span as is possible without being below 1%. The video bandwidth shall be set to 3 times the resolution bandwidth. Video averaging is not permitted. Where practical, a sampling detector shall be used since a peak or peak hold.



Test Data

Test mode: IEEE 802.11b mode

Channel	Frequency (MHz)	99% Bandwidth (MHz)
Low	2412	13.6592
Mid	2437	12.6758
High	2462	13.6901

Test mode: IEEE 802.11g mode

Channel	Frequency (MHz)	99% Bandwidth (MHz)
Low	2412	16.3532
Mid	2437	16.3500
High	2462	16.3371

Test mode: IEEE 802.11n HT 20 MHz mode Channel mode

Channel	Frequency (MHz)	99% Bandwidth (MHz)
Low	2412	17.4244
Mid	2437	17.4122
High	2462	17.3996



Test Plot

**IEEE 802.11b mode
99% Bandwidth (CH Low)**

Agilent

R T

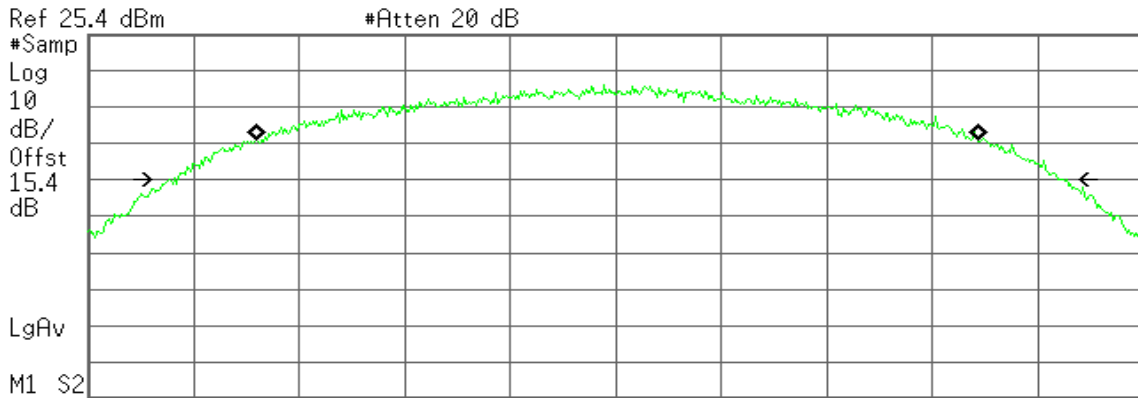

Occupied Bandwidth
13.6592 MHz

Occ BW % Pwr 99.00 %
x dB -26.00 dB

Transmit Freq Error 32.071 kHz
x dB Bandwidth 16.921 MHz*

99% Bandwidth (CH Mid)

Agilent

R T

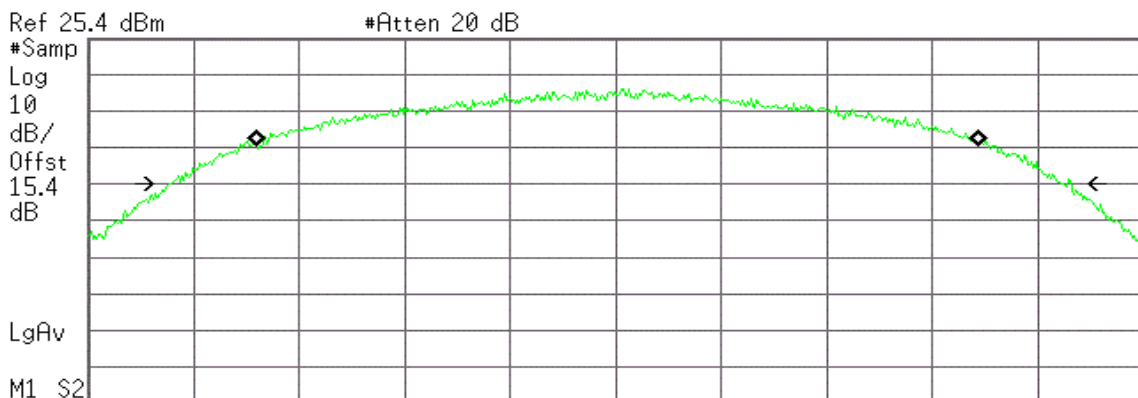

Occupied Bandwidth
13.6758 MHz

Occ BW % Pwr 99.00 %
x dB -26.00 dB

Transmit Freq Error 40.170 kHz
x dB Bandwidth 17.075 MHz*



99% Bandwidth (CH High)

Agilent

R T

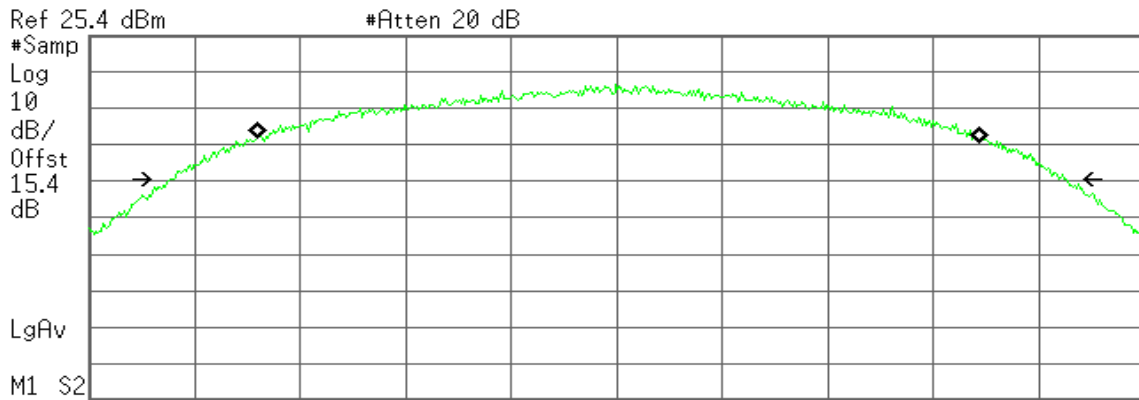

Ref 25.4 dBm #Atten 20 dB
 #Samp Log 10
 dB/ Offst 15.4 dB
 LgAv
 M1 S2
 Center 2.462 00 GHz Span 20 MHz
 #Res BW 200 kHz #VBW 620 kHz Sweep 1.52 ms (601 pts)

Occupied Bandwidth
13.6901 MHz

Occ BW % Pwr 99.00 %
x dB -26.00 dB

Transmit Freq Error 31.319 kHz
x dB Bandwidth 17.032 MHz*

IEEE 802.11g mode

99% Bandwidth (CH Low)

Agilent

R T

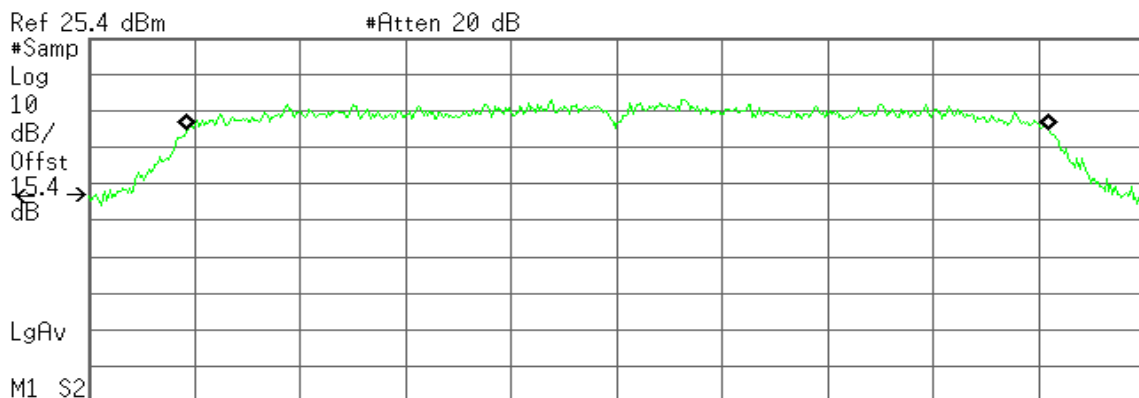

Ref 25.4 dBm #Atten 20 dB
 #Samp Log 10
 dB/ Offst 15.4 dB
 LgAv
 M1 S2
 Center 2.412 00 GHz Span 20 MHz
 #Res BW 200 kHz #VBW 620 kHz Sweep 1.52 ms (601 pts)

Occupied Bandwidth
16.3532 MHz

Occ BW % Pwr 99.00 %
x dB -26.00 dB

Transmit Freq Error 24.020 kHz
x dB Bandwidth 19.509 MHz*



99% Bandwidth (CH Mid)

Agilent

R T

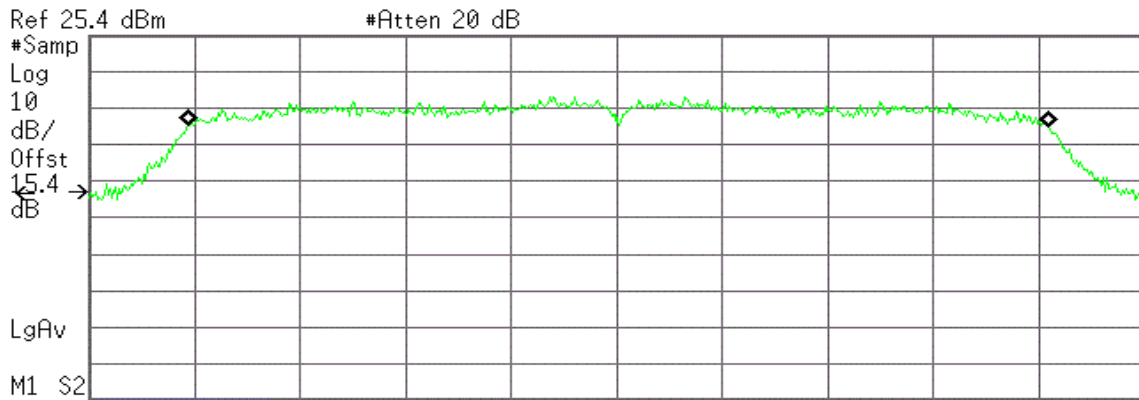

Ref 25.4 dBm #Atten 20 dB
 #Samp 10
 Log
 dB/
 Offst
 15.4
 dB
 LgAv
 M1 S2
 Center 2.437 00 GHz Span 20 MHz
 #Res BW 200 kHz #VBW 620 kHz Sweep 1.52 ms (601 pts)

Occupied Bandwidth
16.3500 MHz

Occ BW % Pwr 99.00 %
x dB -26.00 dB

Transmit Freq Error 31.350 kHz
x dB Bandwidth 19.494 MHz*

99% Bandwidth (CH High)

Agilent

R T

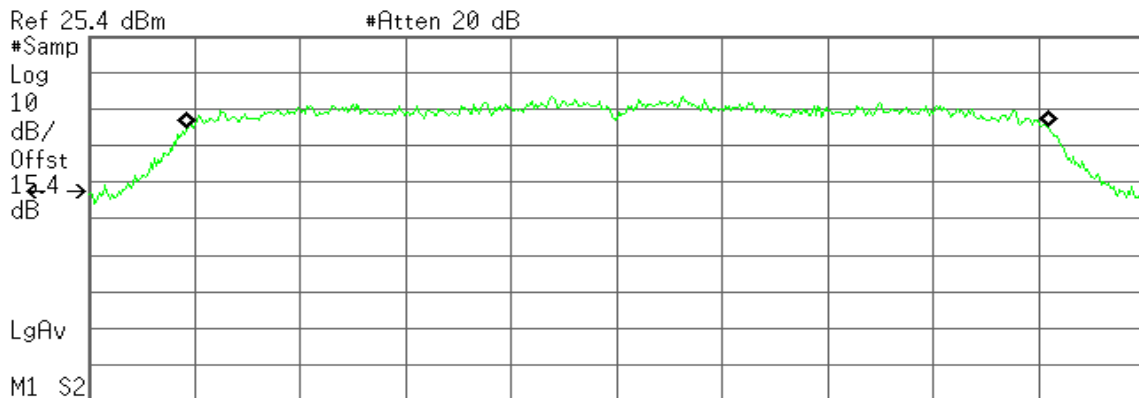

Ref 25.4 dBm #Atten 20 dB
 #Samp 10
 Log
 dB/
 Offst
 15.4
 dB
 LgAv
 M1 S2
 Center 2.462 00 GHz Span 20 MHz
 #Res BW 200 kHz #VBW 620 kHz Sweep 1.52 ms (601 pts)

Occupied Bandwidth
16.3371 MHz

Occ BW % Pwr 99.00 %
x dB -26.00 dB

Transmit Freq Error 17.916 kHz
x dB Bandwidth 19.727 MHz*



IEEE 802.11n HT 20 MHz mode Channel mode

99% Bandwidth (CH Low)

Agilent

R T

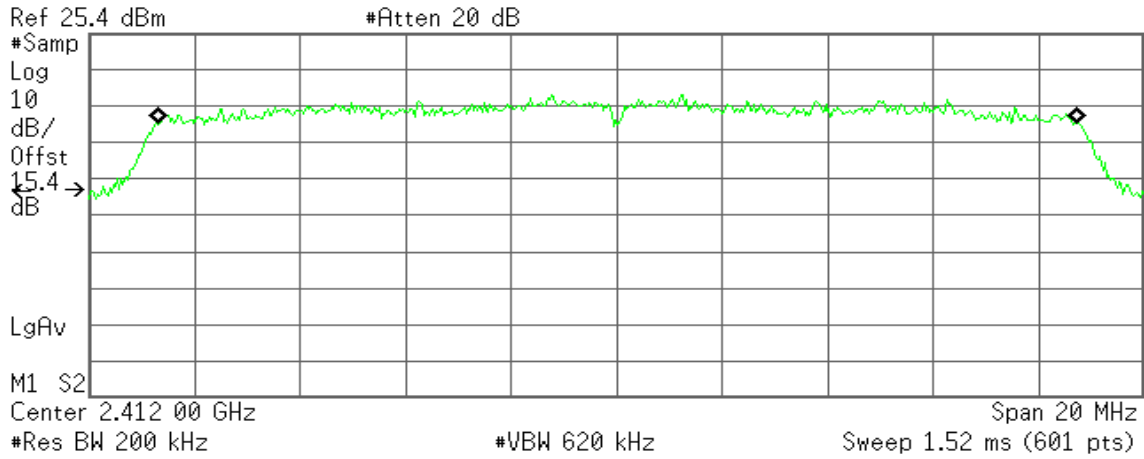

Occupied Bandwidth
17.4244 MHz

Occ BW % Pwr 99.00 %
x dB -26.00 dB

Transmit Freq Error 25.116 kHz
x dB Bandwidth 19.479 MHz*

99% Bandwidth (CH Mid)

Agilent

R T

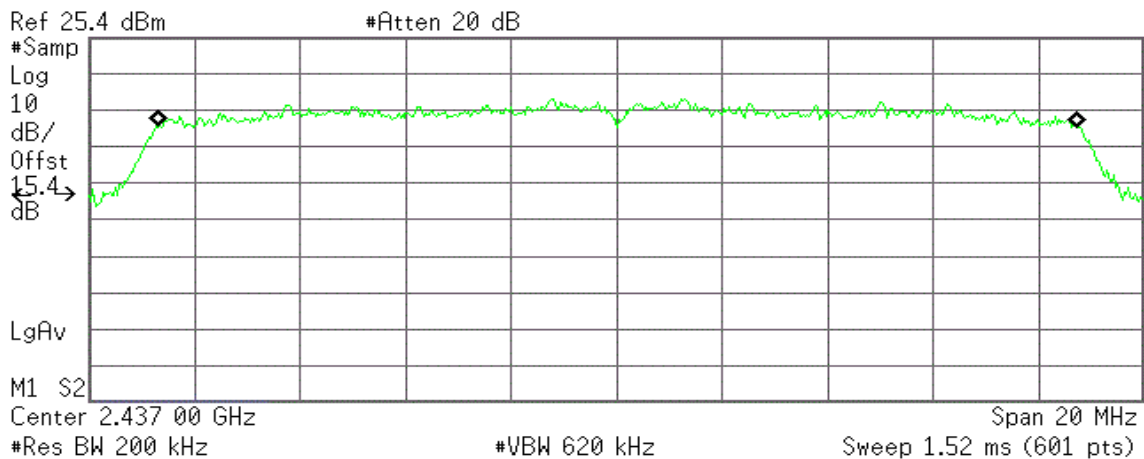

Occupied Bandwidth
17.4122 MHz

Occ BW % Pwr 99.00 %
x dB -26.00 dB

Transmit Freq Error 21.710 kHz
x dB Bandwidth 19.672 MHz*



99% Bandwidth (CH High)

Agilent

R T

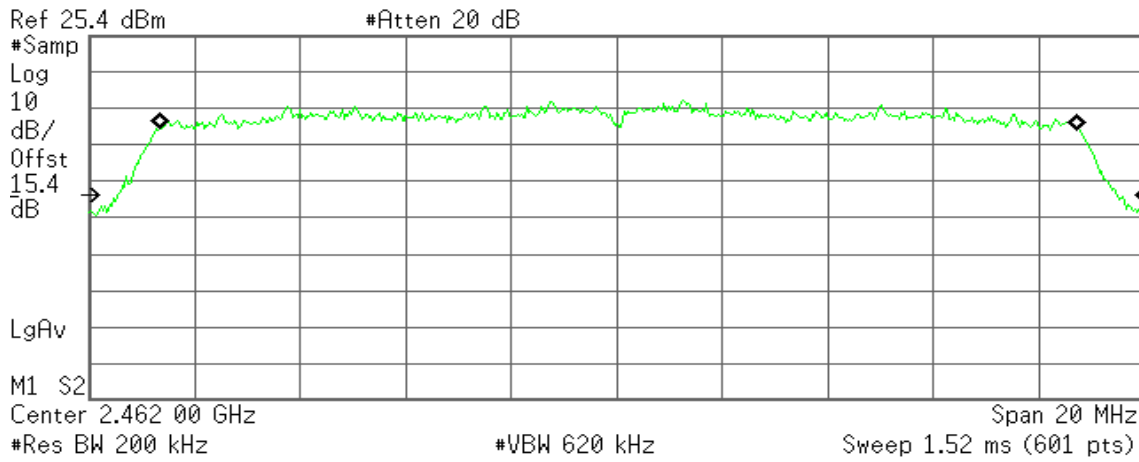

Occupied Bandwidth
17.3996 MHz

Occ BW % Pwr 99.00 %
x dB -26.00 dB

Transmit Freq Error 18.726 kHz
x dB Bandwidth 18.959 MHz*



8.2 6DB BANDWIDTH

LIMIT

According to §15.247(a)(2) & RSS-210 §A8.2(a), systems using digital modulation techniques may operate in the 902 - 928 MHz, 2400 - 2483.5 MHz, and 5725 - 5850 MHz bands. The minimum 6dB bandwidth shall be at least 500 kHz.

Test Configuration

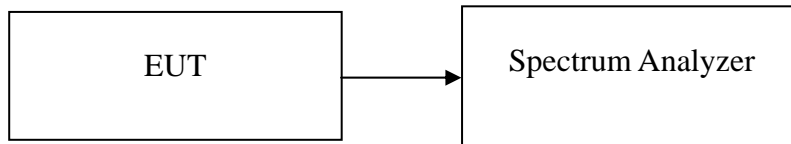

TEST PROCEDURE

1. Place the EUT on the table and set it in the transmitting mode.
2. Remove the antenna from the EUT and then connect a low loss RF cable from the antenna port to the spectrum analyzer.
3. Set the spectrum analyzer as RBW = 100 kHz, VBW = RBW, Span = 50 MHz, Sweep = auto.
4. Mark the peak frequency and -6dB (upper and lower) frequency.
5. Repeat until all the rest channels are investigated.

TEST RESULTS

No non-compliance noted



Test Data

Test mode: IEEE 802.11b mode

Channel	Frequency (MHz)	6dB Bandwidth (MHz)	Limit (kHz)	Result
Low	2412	8.25	>500	PASS
Mid	2437	8.25		PASS
High	2462	8.25		PASS

Test mode: IEEE 802.11g mode

Channel	Frequency (MHz)	6dB Bandwidth (kHz)	Limit (kHz)	Result
Low	2412	16	>500	PASS
Mid	2437	16.0834		PASS
High	2462	16.25		PASS

Test mode: IEEE 802.11n HT 20 MHz mode Channel mode

Channel	Frequency (MHz)	6dB Bandwidth (MHz)	Limit (kHz)	Result
Low	2412	17.5	>500	PASS
Mid	2437	17.5833		PASS
High	2462	17.3333		PASS



Test Plot

IEEE 802.11b mode

6dB Bandwidth (CH Low)

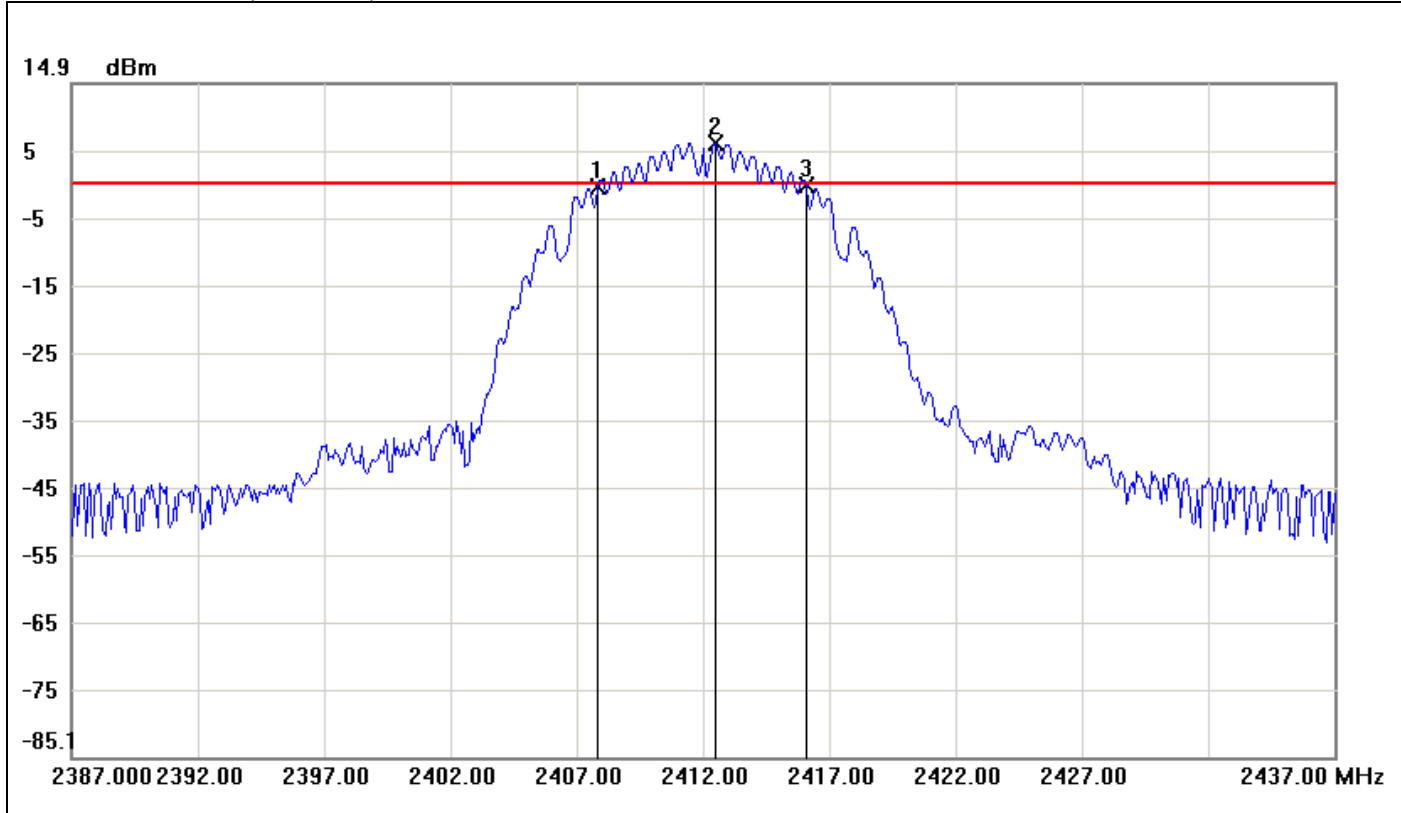

No.	Frequency(MHz)	Result(dBm)	Limit(dBm)	Margin(dBm)
1	2407.8333	-0.59	0.00	-0.59
2	2412.5000	6.00	0.00	6.00
3	2416.0833	-0.17	0.00	-0.17

No.		Δ Frequency(MHz)	Δ Level(dB)
1	mk3-mk1	8.25	0.42



6dB Bandwidth (CH Mid)

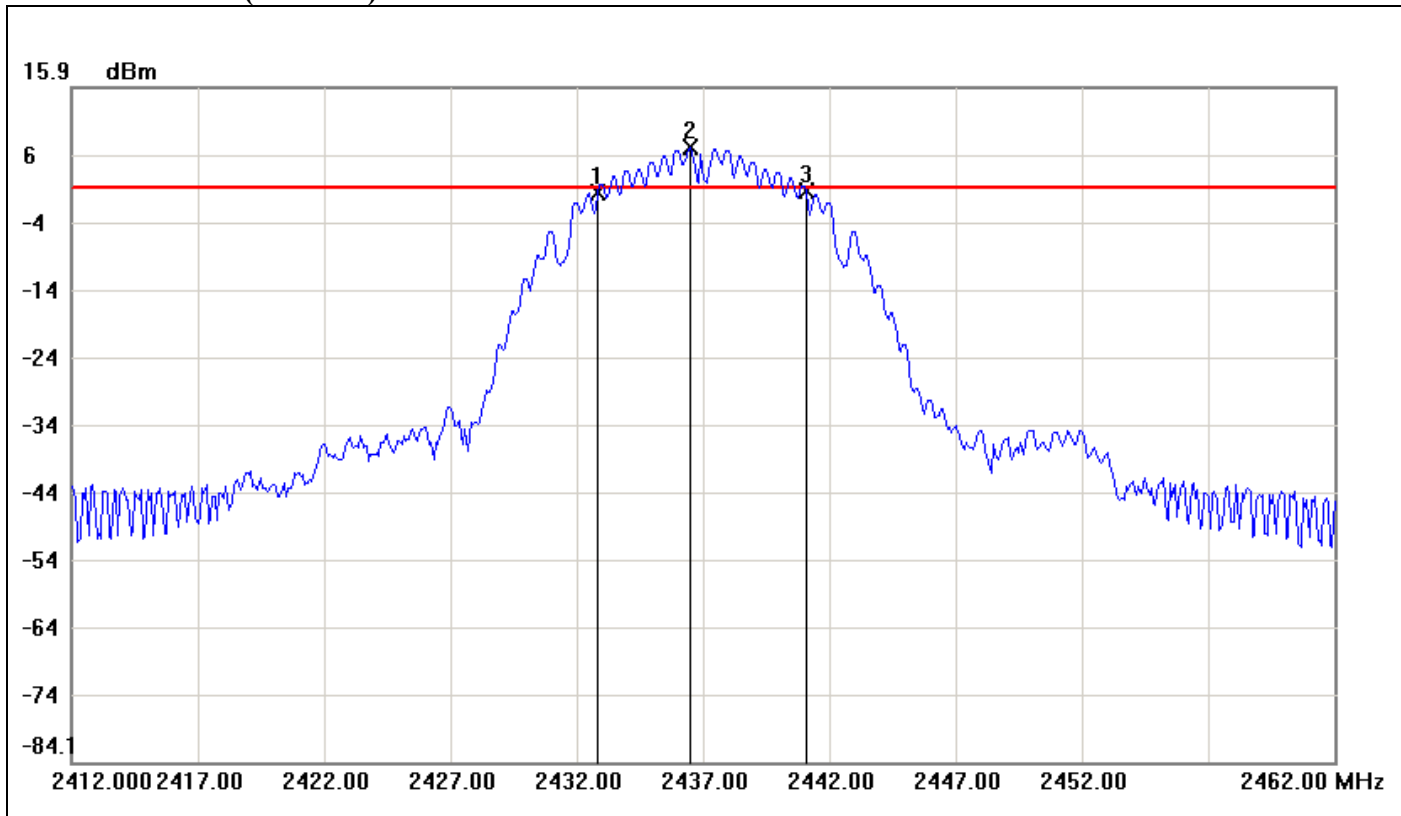

No.	Frequency(MHz)	Result(dBm)	Limit(dBm)	Margin(dBm)
1	2432.8333	0.38	0.91	-0.53
2	2436.5000	6.91	0.91	6.00
3	2441.0833	0.59	0.91	-0.32

No.		Δ Frequency(MHz)	Δ Level(dB)
1	mk3-mk1	8.25	0.21



6dB Bandwidth (CH High)

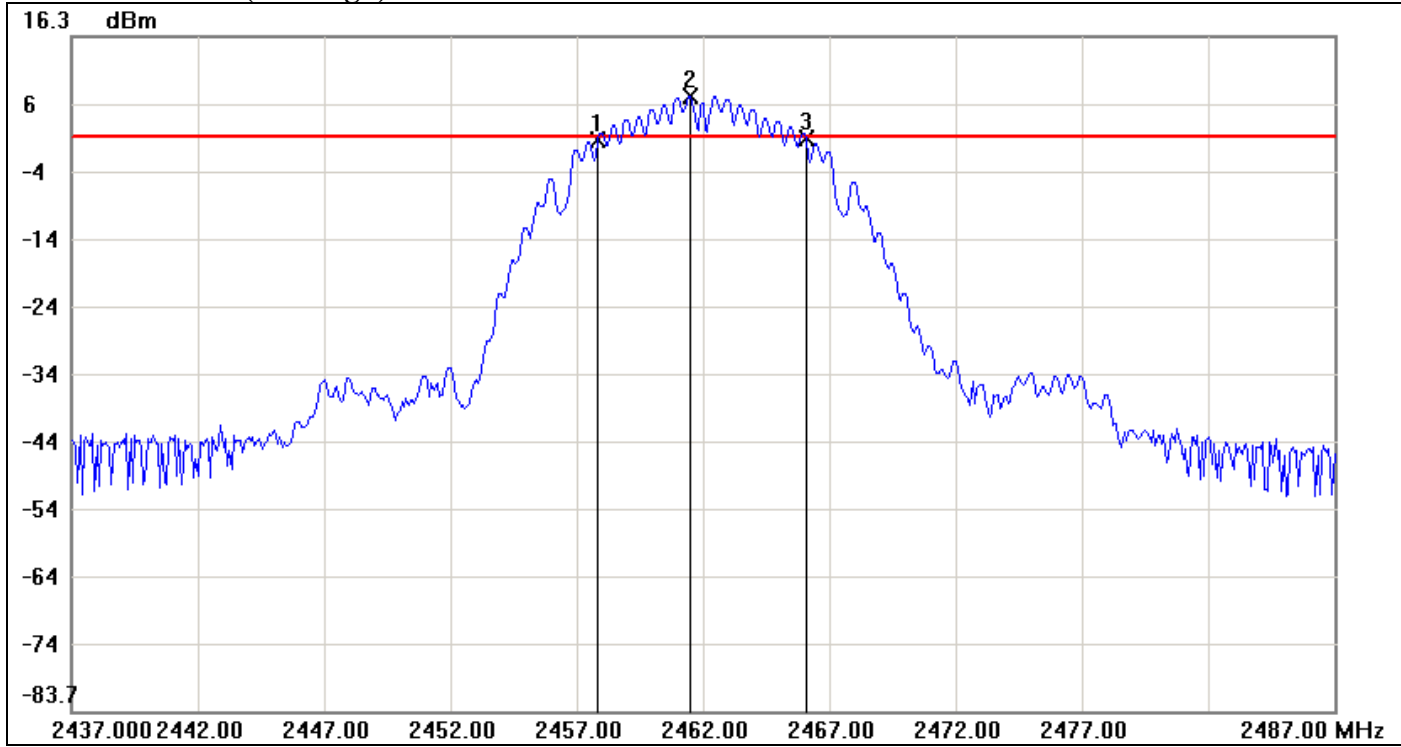

No.	Frequency(MHz)	Result(dBm)	Limit(dBm)	Margin(dBm)
1	2457.8333	0.90	1.45	-0.55
2	2461.5000	7.45	1.45	6.00
3	2466.0833	1.09	1.45	-0.36

No.		Δ Frequency(MHz)	Δ Level(dB)
1	mk3-mk1	8.25	0.19



IEEE 802.11g mode

6dB Bandwidth (CH Low)

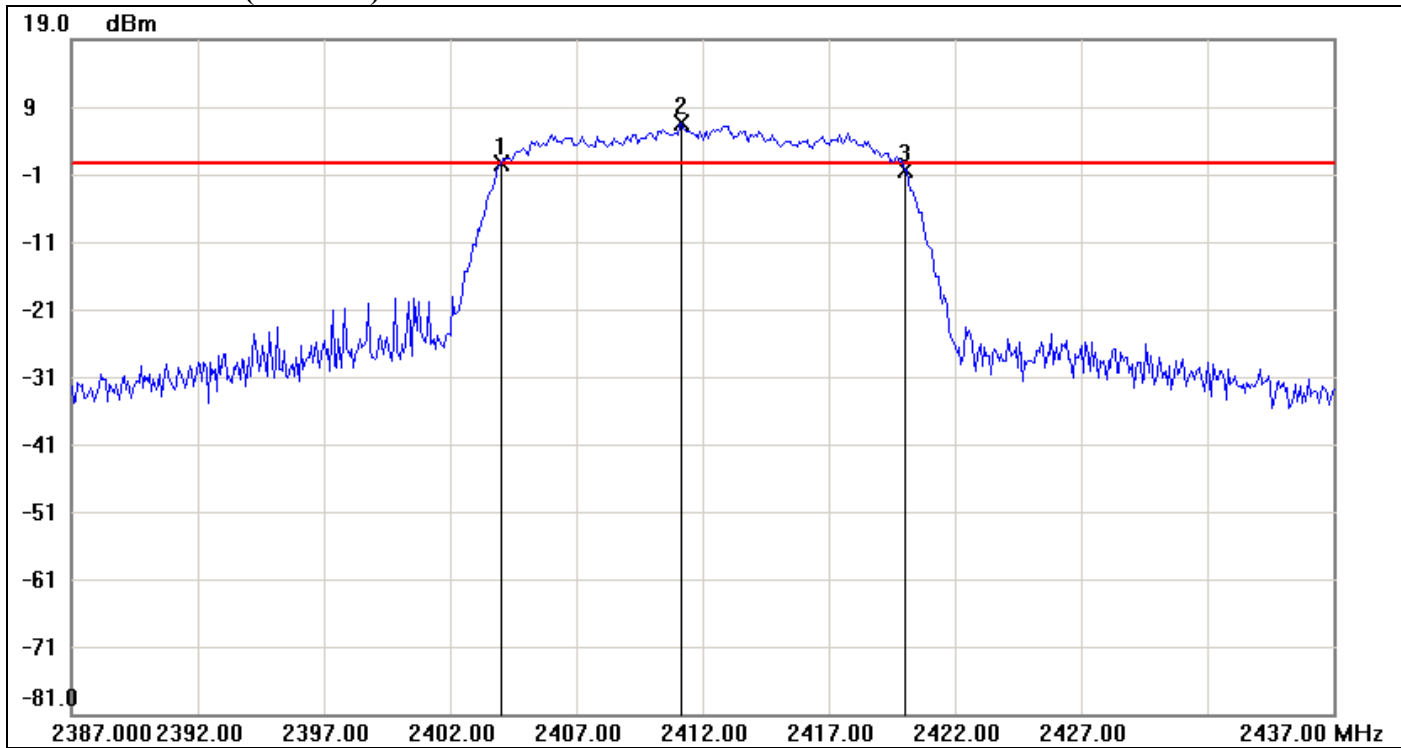

No.	Frequency(MHz)	Result(dBm)	Limit(dBm)	Margin(dBm)
1	2404.0000	0.53	0.62	-0.09
2	2411.6667	6.62	0.62	6.00
3	2420.0000	-0.27	0.62	-0.89

No.		Δ Frequency(MHz)	Δ Level(dB)
1	mk3-mk1	16	-0.8



6dB Bandwidth (CH Mid)

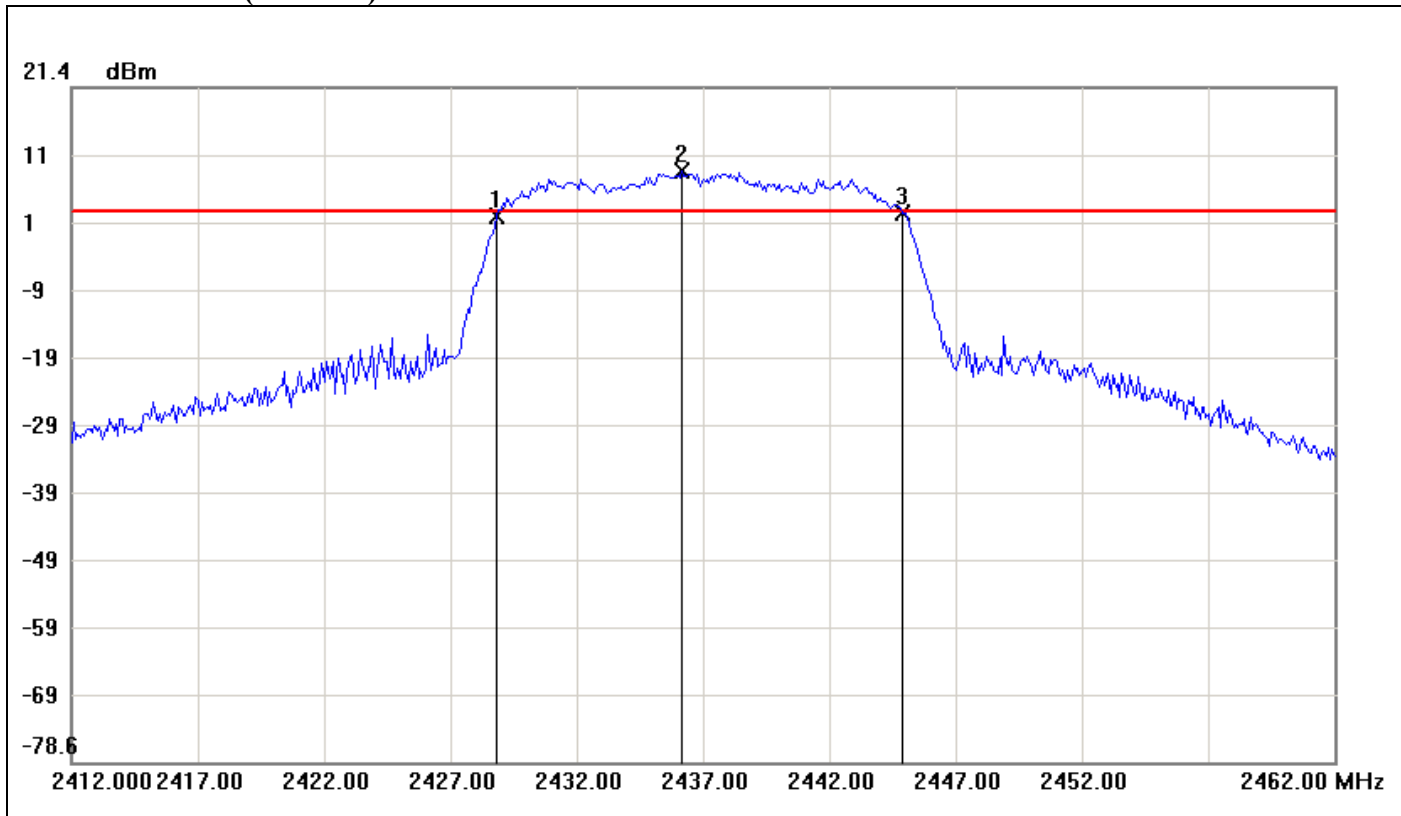

No.	Frequency(MHz)	Result(dBm)	Limit(dBm)	Margin(dBm)
1	2428.8333	2.32	2.97	-0.65
2	2436.1667	8.97	2.97	6.00
3	2444.9167	2.90	2.97	-0.07

No.		Δ Frequency(MHz)	Δ Level(dB)
1	mk3-mk1	16.0834	0.58



6dB Bandwidth (CH High)

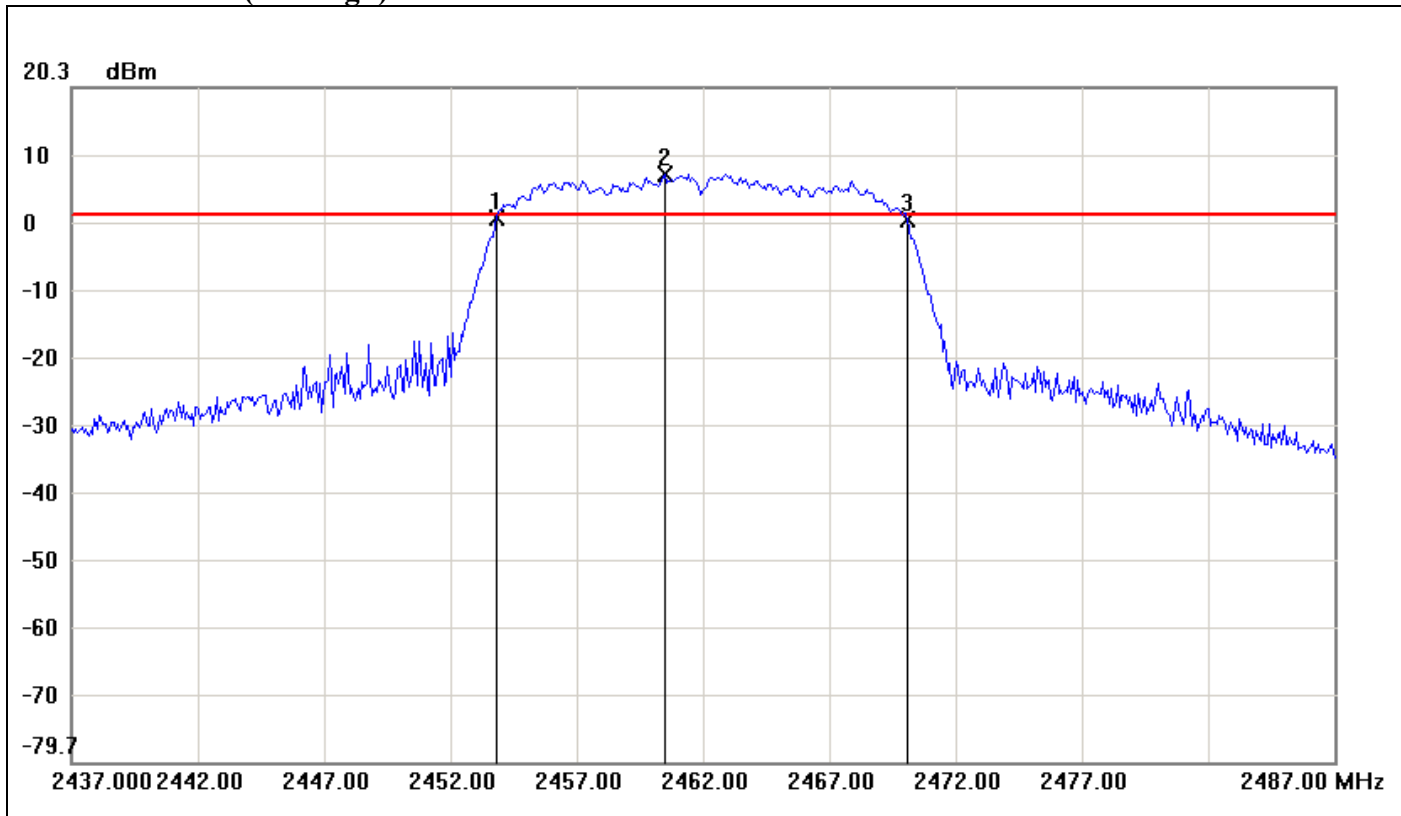

No.	Frequency(MHz)	Result(dBm)	Limit(dBm)	Margin(dBm)
1	2453.8333	0.96	1.57	-0.61
2	2460.5000	7.57	1.57	6.00
3	2470.0833	0.62	1.57	-0.95

No.		Δ Frequency(MHz)	Δ Level(dB)
1	mk3-mk1	16.25	-0.34



IEEE 802.11n HT 20 MHz mode Channel mode

6dB Bandwidth (CH Low)

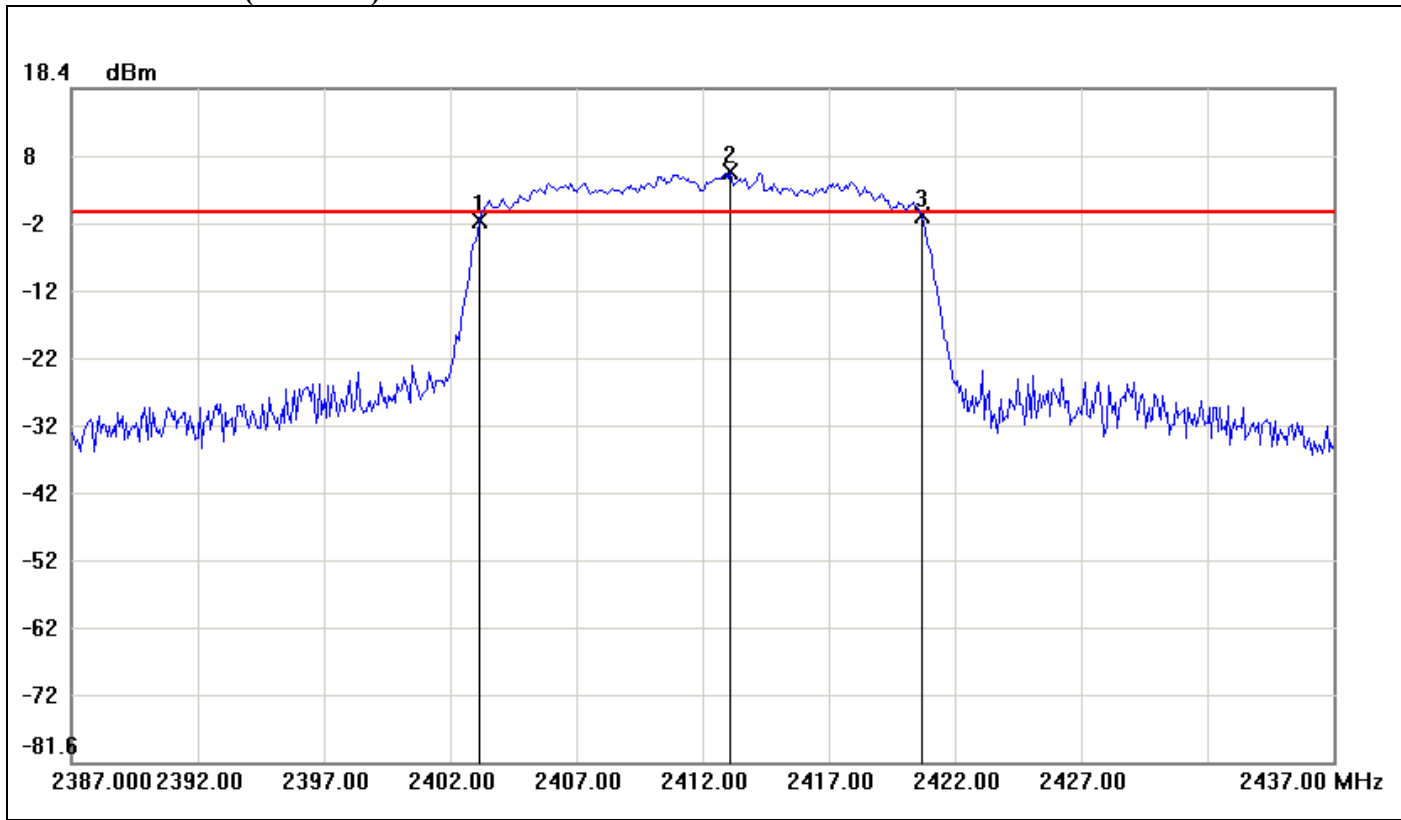

No.	Frequency(MHz)	Result(dBm)	Limit(dBm)	Margin(dBm)
1	2403.1667	-1.32	-0.06	-1.26
2	2413.0833	5.94	-0.06	6.00
3	2420.6667	-0.53	-0.06	-0.47

No.		Δ Frequency(MHz)	Δ Level(dB)
1	mk3-mk1	17.5	0.79



6dB Bandwidth (CH Mid)

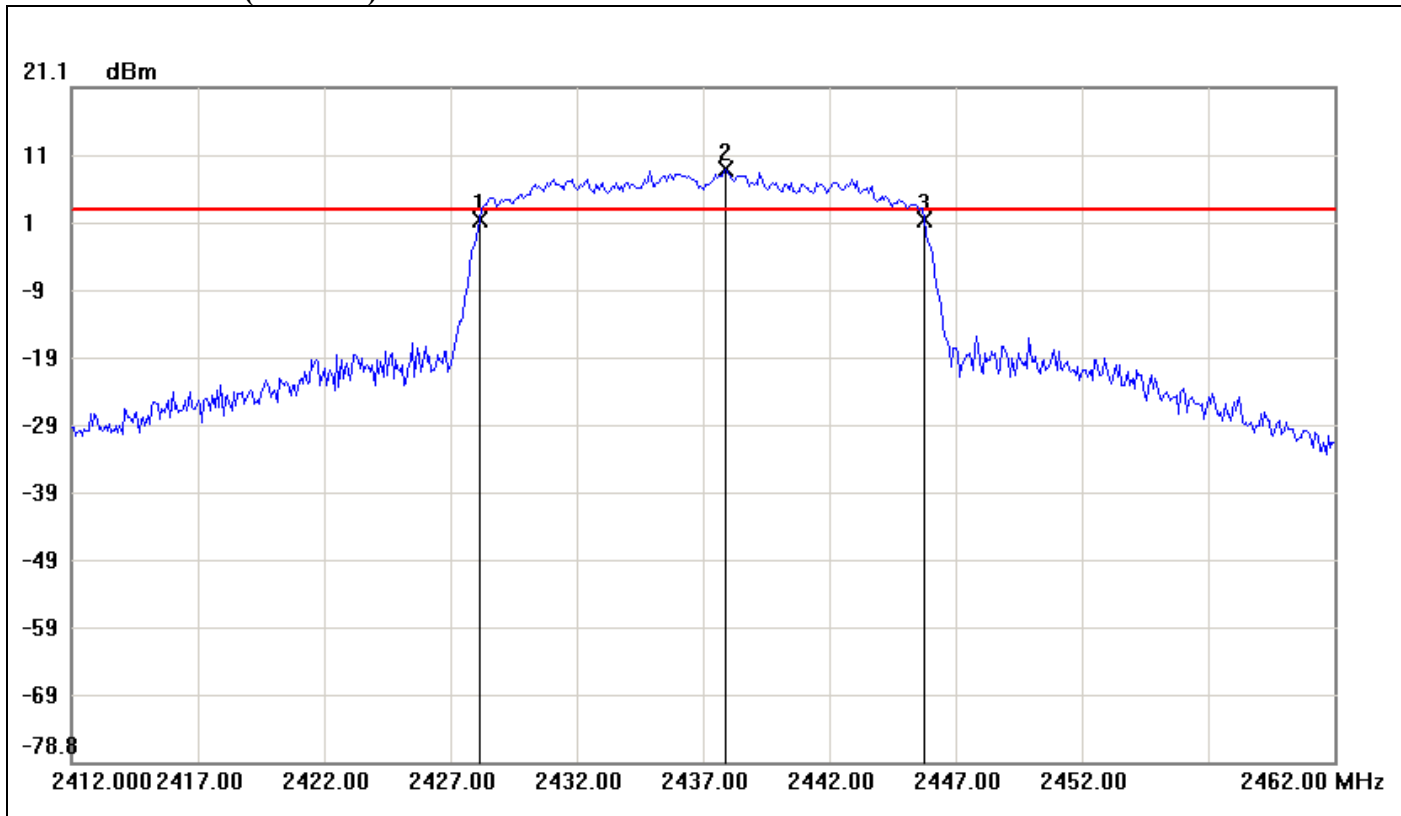

No.	Frequency(MHz)	Result(dBm)	Limit(dBm)	Margin(dBm)
1	2428.1667	1.62	3.14	-1.52
2	2437.9167	9.14	3.14	6.00
3	2445.7500	1.45	3.14	-1.69

No.		Δ Frequency(MHz)	Δ Level(dB)
1	mk3-mk1	17.5833	-0.17



6dB Bandwidth (CH High)

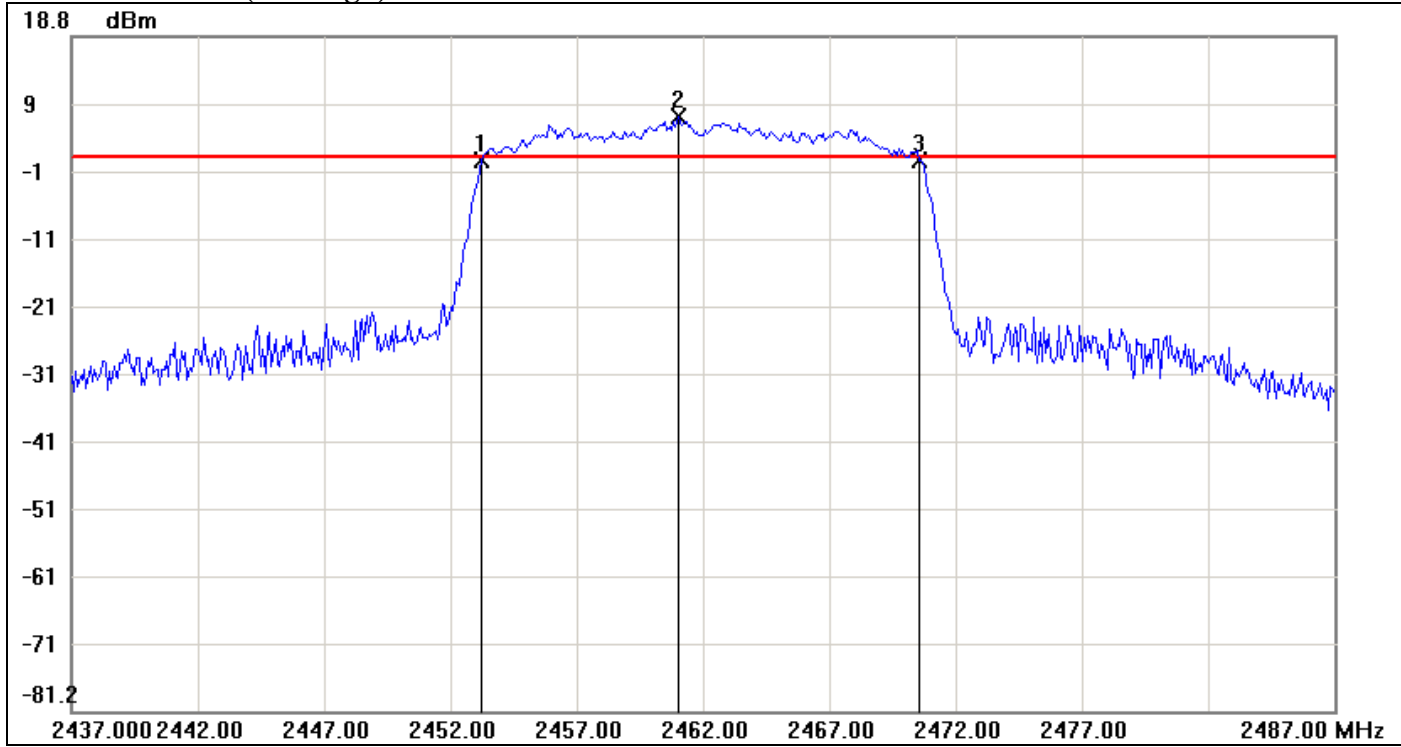

No.	Frequency(MHz)	Result(dBm)	Limit(dBm)	Margin(dBm)
1	2453.2500	0.51	0.89	-0.38
2	2461.0000	6.89	0.89	6.00
3	2470.5833	0.40	0.89	-0.49

No.		Δ Frequency(MHz)	Δ Level(dB)
1	mk3-mk1	17.3333	-0.11



8.3 PEAK POWER

LIMIT

The maximum peak output power of the intentional radiator shall not exceed the following:

1. According to §15.247(b)(3), for systems using digital modulation in the bands of 902-928 MHz, 2400-2483.5 MHz, and 5725-5850 MHz: 1 Watt.
2. According to §15.247(b)(4), the conducted output power limit specified in paragraph (b) of this section is based on the use of antennas with directional gains that do not exceed 6 dBi. Except as shown in paragraph (c) of this section, if transmitting antennas of directional gain greater than 6 dBi are used, the conducted output power from the intentional radiator shall be reduced below the stated values in paragraphs (b)(1), (b)(2), and (b)(3) of this section, as appropriate, by the amount in dB that the directional gain of the antenna exceeds 6 dBi.
3. According to RSS-210 §A8.4(4), for systems employing digital modulation techniques operating in the bands 902-928 MHz, 2400-2483.5 MHz and 5725-5850 MHz, the maximum peak conducted output power shall not exceed 1 W.

Test Configuration

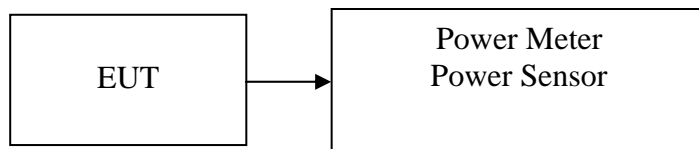

TEST PROCEDURE

The transmitter output is connected to the Power Meter. The Power Meter is set to the peak power detection.

TEST RESULTS

No non-compliance noted



Test Data

Test mode: IEEE 802.11b mode

Channel	Frequency (MHz)	Output Power (dBm)	Output Power (W)	Limit (W)	Result
Low	2412	16.8	0.0479	1.00	PASS
Mid	2437	17.78	0.0600		PASS
High	2462	*18.22	0.0664		PASS

Test mode: IEEE 802.11g mode

Channel	Frequency (MHz)	Output Power (dBm)	Output Power (W)	Limit (W)	Result
Low	2412	24.11	0.2576	1.00	PASS
Mid	2437	*24.89	0.3083		PASS
High	2462	24.8	0.3020		PASS

Test mode: IEEE 802.11n HT 20 MHz mode Channel mode

Channel	Frequency (MHz)	Output Power (dBm)	Output Power (W)	Limit (W)	Result
Low	2412	23.91	0.2460	1.00	PASS
Mid	2437	*25.14	0.3266		PASS
High	2462	24.31	0.2698		PASS



8.4 AVERAGE POWER

LIMIT

None; for reporting purposes only.

Test Configuration

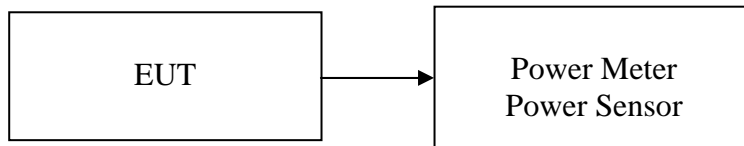

TEST PROCEDURE

The transmitter output is connected to the Power Meter. The Power Meter is set to the average power detection.

TEST RESULTS

No non-compliance noted



Test Data

Test mode: IEEE 802.11b mode

Channel	Frequency (MHz)	Output Power (dBm)	Output Power (W)
Low	2412	13.82	0.0241
Mid	2437	14.6	0.0288
High	2462	15.17	0.0329

Test mode: IEEE 802.11g mode

Channel	Frequency (MHz)	Output Power (dBm)	Output Power (W)
Low	2412	13.7	0.0234
Mid	2437	16.45	0.0442
High	2462	15.1	0.0324

Test mode: IEEE 802.11n HT 20 MHz mode Channel mode

Channel	Frequency (MHz)	Output Power (dBm)	Output Power (W)
Low	2412	13.56	0.0227
Mid	2437	16.29	0.0426
High	2462	14.08	0.0256



8.5 BAND EDGES MEASUREMENT

LIMIT

According to §15.247(d) & RSS-210 §A8.5, in any 100 kHz bandwidth outside the frequency bands in which the spread spectrum intentional radiator is operating, the radio frequency power that is produced by the intentional radiator shall be at least 20 dB below that in the 100 kHz bandwidth within the band that contains the highest level of the desired power, based on either an RF conducted or a radiated measurement, provided the transmitter demonstrates compliance with the peak conducted power limits. In addition, radiated emissions which fall in the restricted bands, as defined in §15.205(a), must also comply with the radiated emission limits specified in 15.209(a) (see Section 15.205(c)).

Test Configuration

For Radiated

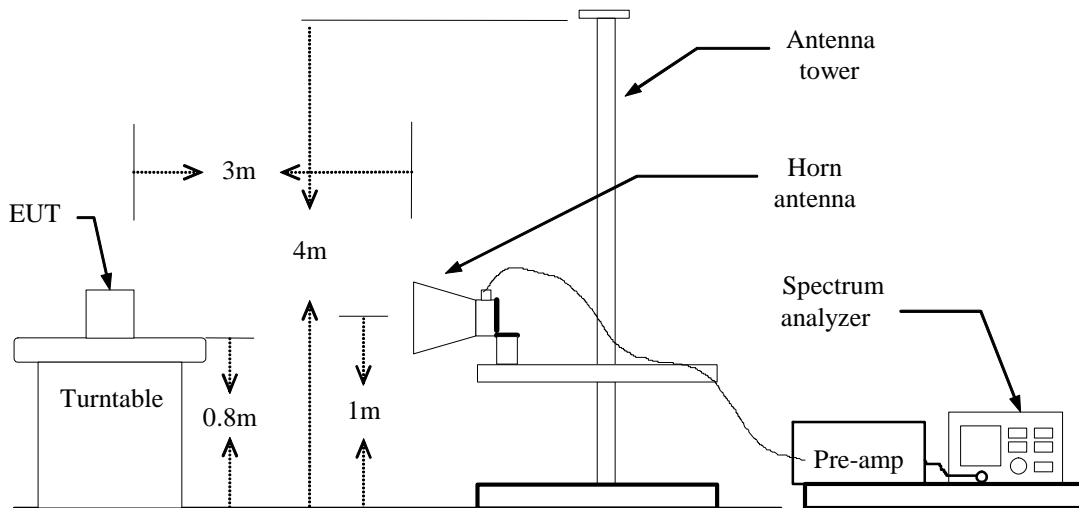

For Conducted

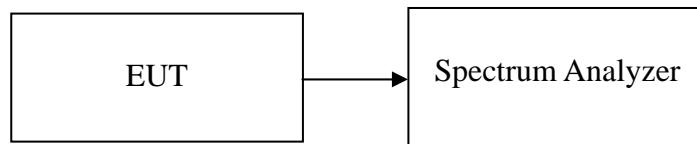



TEST PROCEDURE

For Radiated

1. The EUT is placed on a turntable, which is 0.8m above the ground plane.
2. The turntable shall be rotated for 360 degrees to determine the position of maximum emission level.
3. EUT is set 3m away from the receiving antenna, which is varied from 1m to 4m to find out the highest emission.
4. Set the spectrum analyzer in the following setting in order to capture the lower and upper band-edges of the emission:
 - (a) PEAK: RBW=VBW=1MHz / Sweep=AUTO
 - (b) AVERAGE: RBW=1MHz / VBW= 300Hz / Sweep=AUTO
5. Repeat the procedures until all the PEAK and AVERAGE versus POLARIZATION are measured.

For Conducted

Conducted RF measurements of the transmitter output were made to confirm that the EUT antenna port conducted emissions meet the specified limit and to identify any spurious signals that require further investigation or measurements on the radiated emissions site.

The transmitter output is connected to the spectrum analyzer. The resolution bandwidth is set to 100 kHz. The video bandwidth is set to 100 kHz.

TEST RESULTS

Refer to attach spectrum analyzer data chart.



Band Edges (IEEE 802.11b mode / CH Low)

Detector mode: Peak

Polarity: Vertical

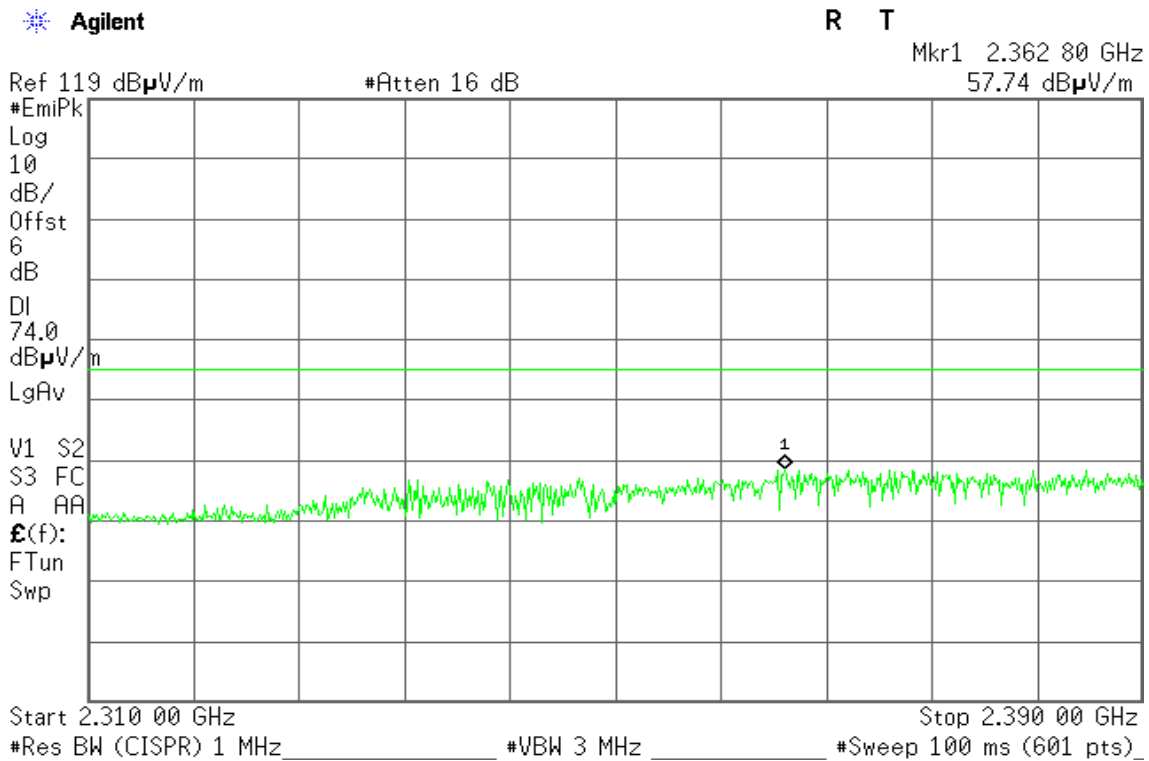

Detector mode: Average

Polarity: Vertical

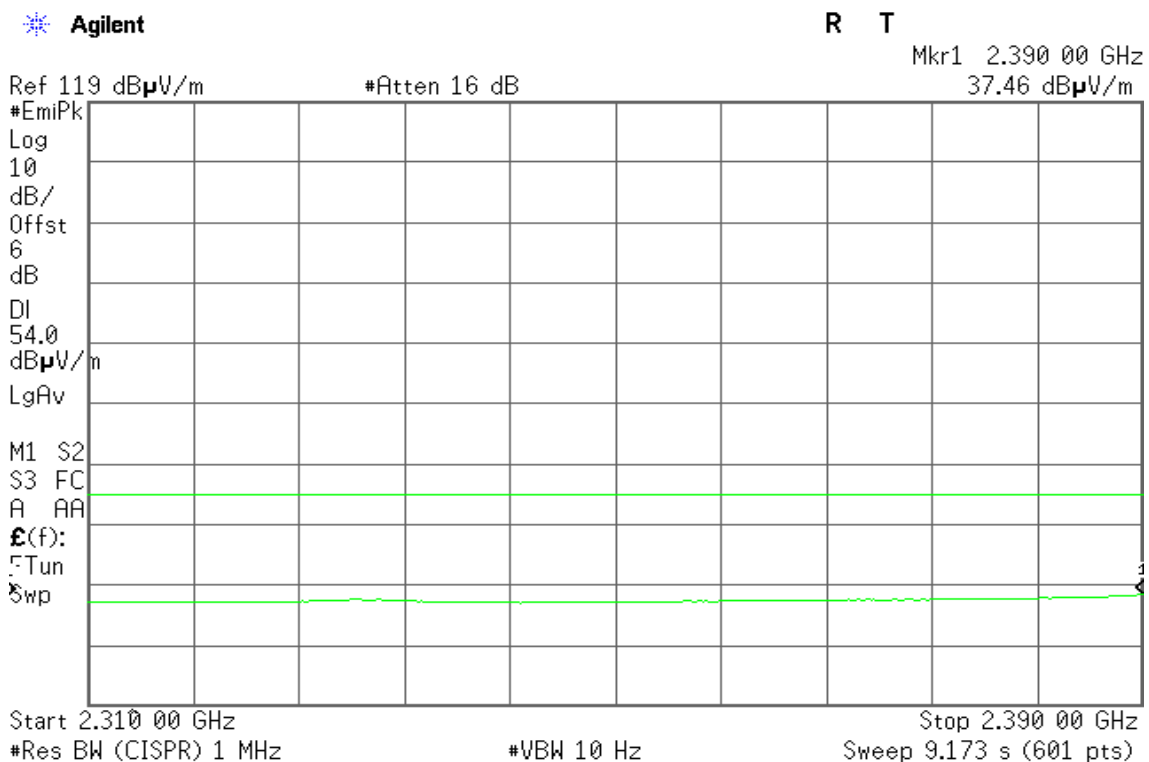



Detector mode: Peak

Polarity: Horizontal

Agilent

R T

Mkr1 2.360 67 GHz
59.72 dBμV/m

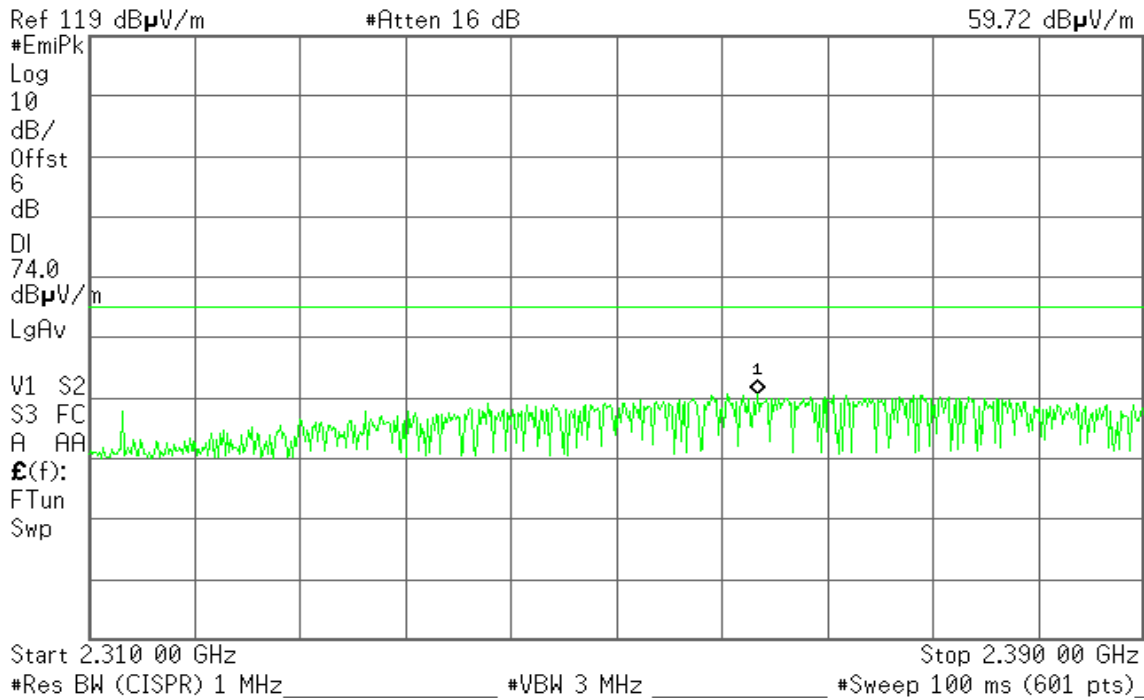

Detector mode: Average

Polarity: Horizontal

Agilent

R T

Mkr1 2.390 00 GHz
38.32 dBμV/m

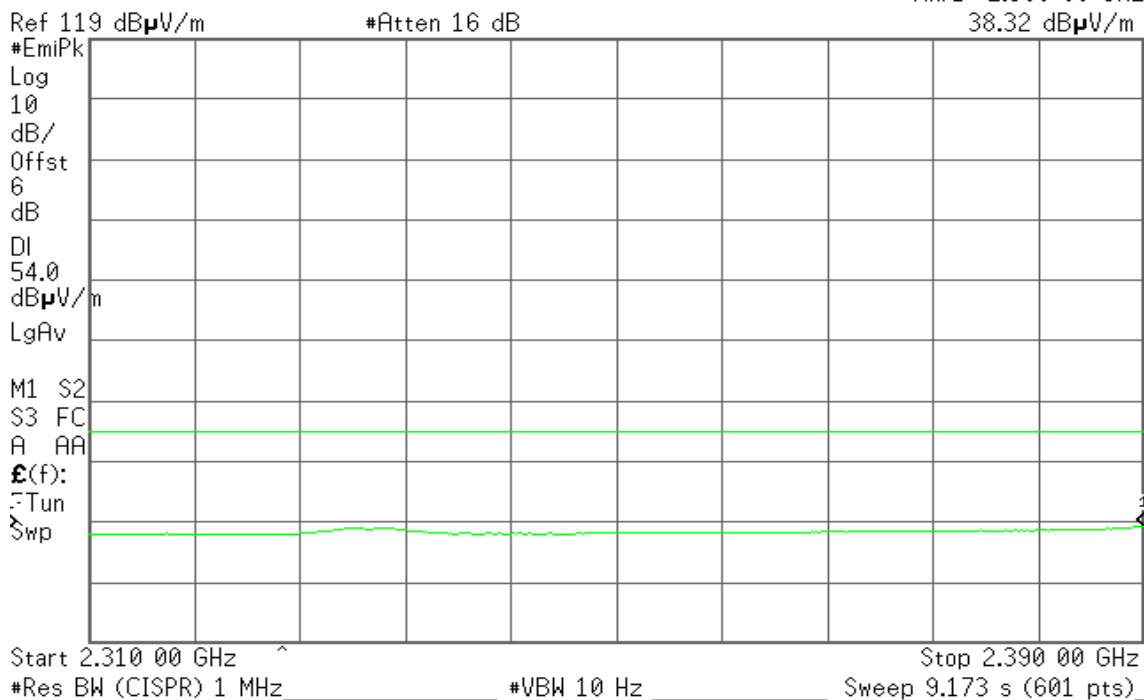



Band Edges (IEEE 802.11b mode / CH High)

Detector mode: Peak

Polarity: Vertical

Agilent

R T

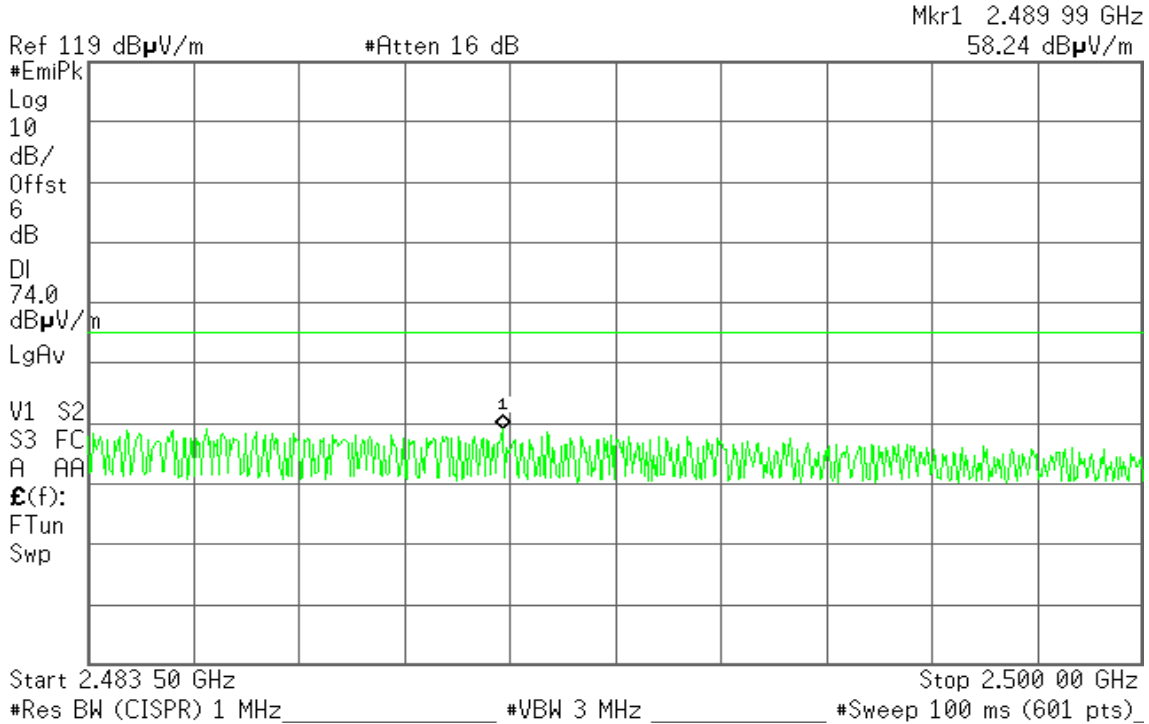

Detector mode: Average

Polarity: Vertical

Agilent

R T

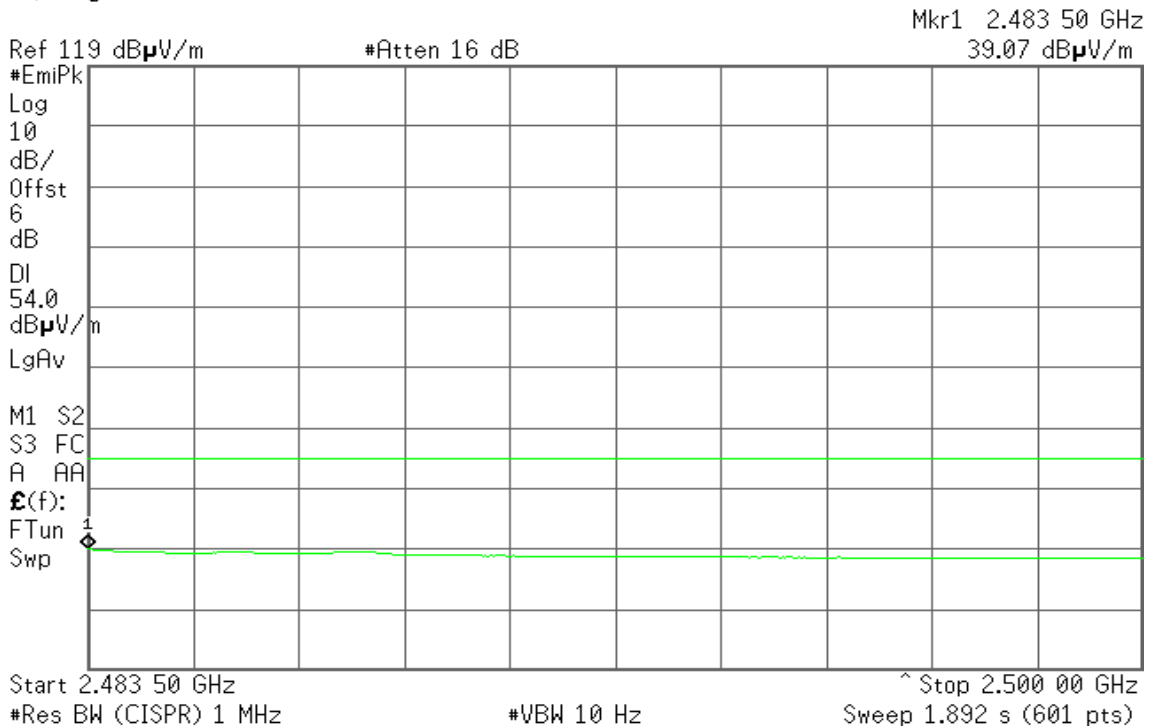



Detector mode: Peak

Polarity: Horizontal

Agilent

R T

Mkr1 2.483 64 GHz
58.91 dBµV/m

Ref 119 dBµV/m

#Atten 16 dB

#EmiPk
Log
10
dB/
Offst
6
dB
DI
74.0
dBµV/m
LgAv
V1 S2
S3 FC
A AA
£(f):
FTun
Swp

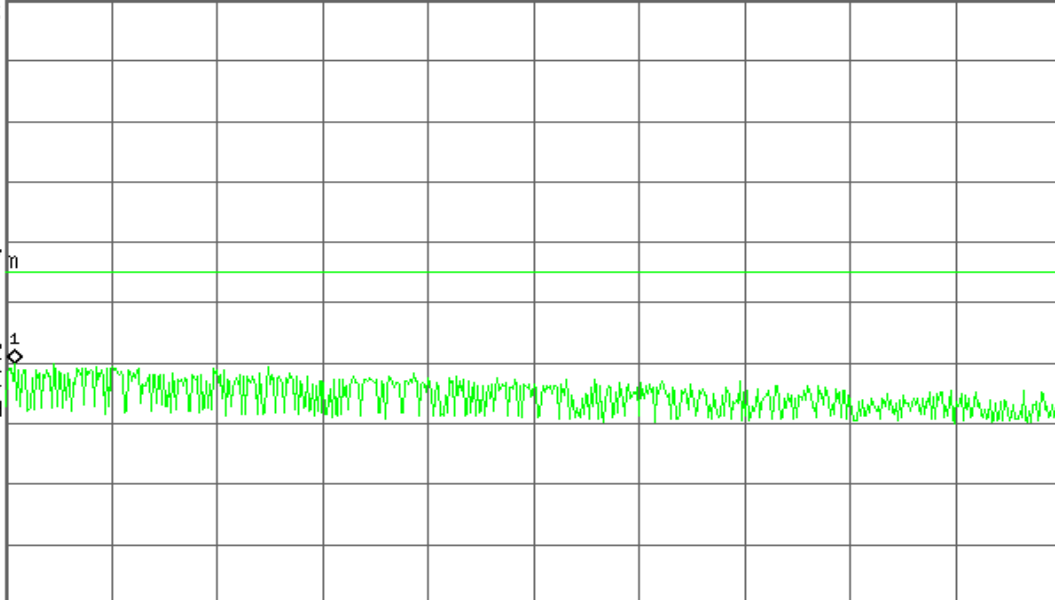

Start 2.483 50 GHz

Stop 2.500 00 GHz

#Res BW (CISPR) 1 MHz

#VBW 3 MHz

#Sweep 100 ms (601 pts)

Detector mode: Average

Polarity: Horizontal

Agilent

R T

Mkr1 2.483 50 GHz
39.88 dBµV/m

Ref 119 dBµV/m

#Atten 16 dB

#EmiPk
Log
10
dB/
Offst
6
dB
DI
54.0
dBµV/m
LgAv
M1 S2
S3 FC
A AA
£(f):
FTun
Swp

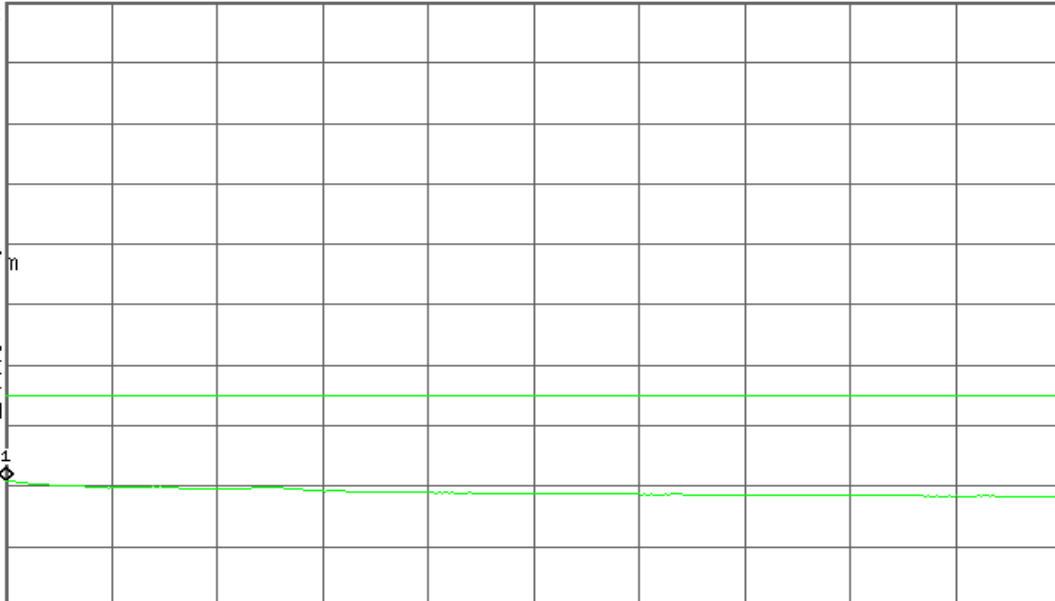

Start 2.483 50 GHz

Stop 2.500 00 GHz

#Res BW (CISPR) 1 MHz

#VBW 10 Hz

Sweep 1.892 s (601 pts)



Band Edges (IEEE 802.11g mode / CH Low)

Detector mode: Peak

Polarity: Vertical

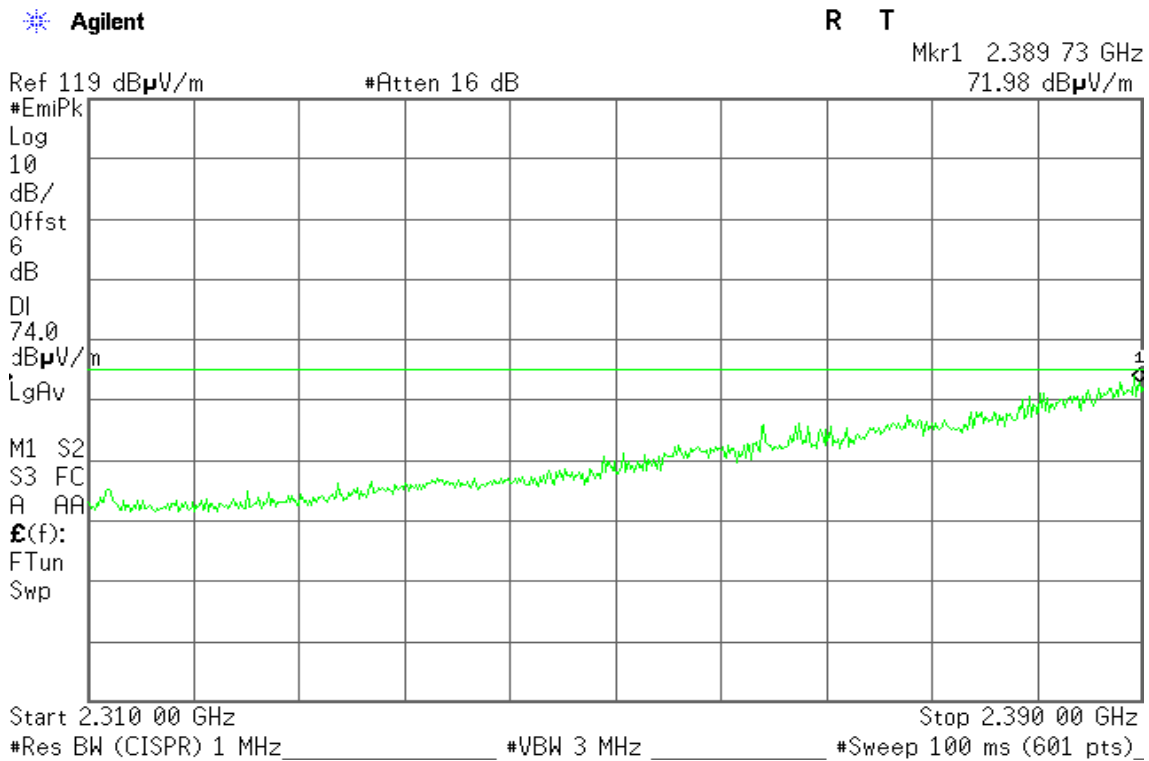

Detector mode: Average

Polarity: Vertical

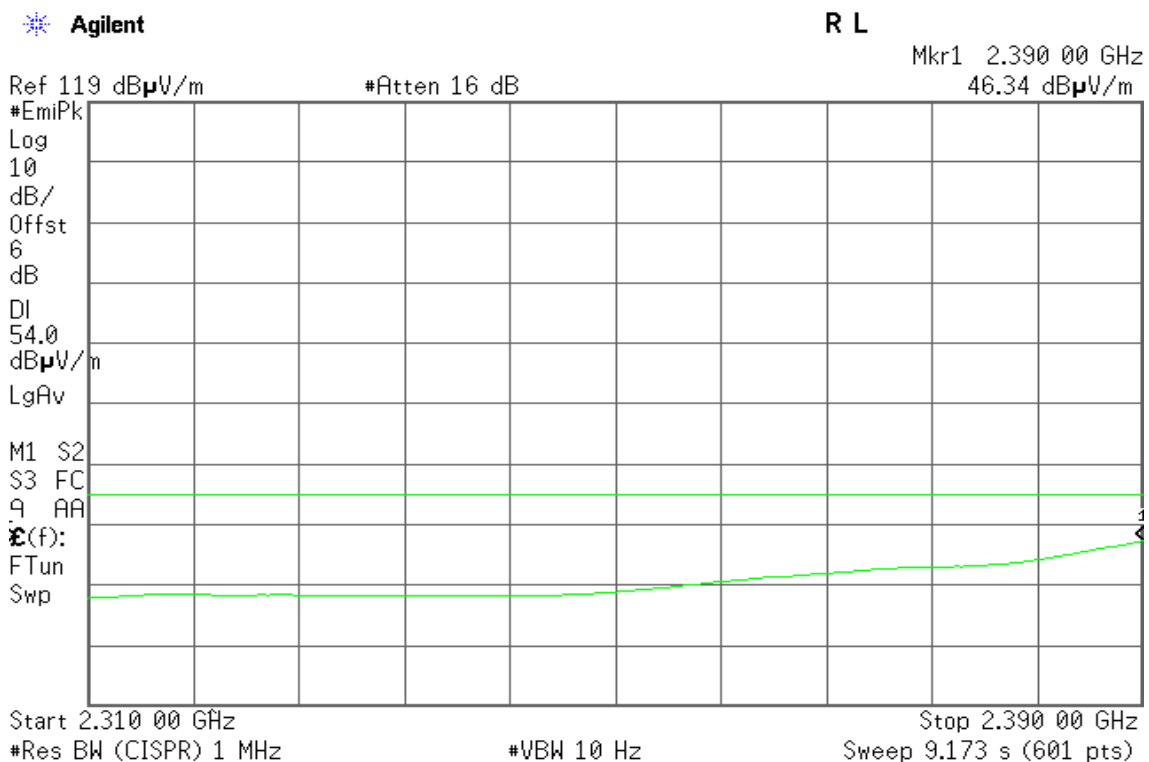



Detector mode: Peak

Polarity: Horizontal

Agilent

R T

Mkr1 2.389 60 GHz
73.08 dBµV/m

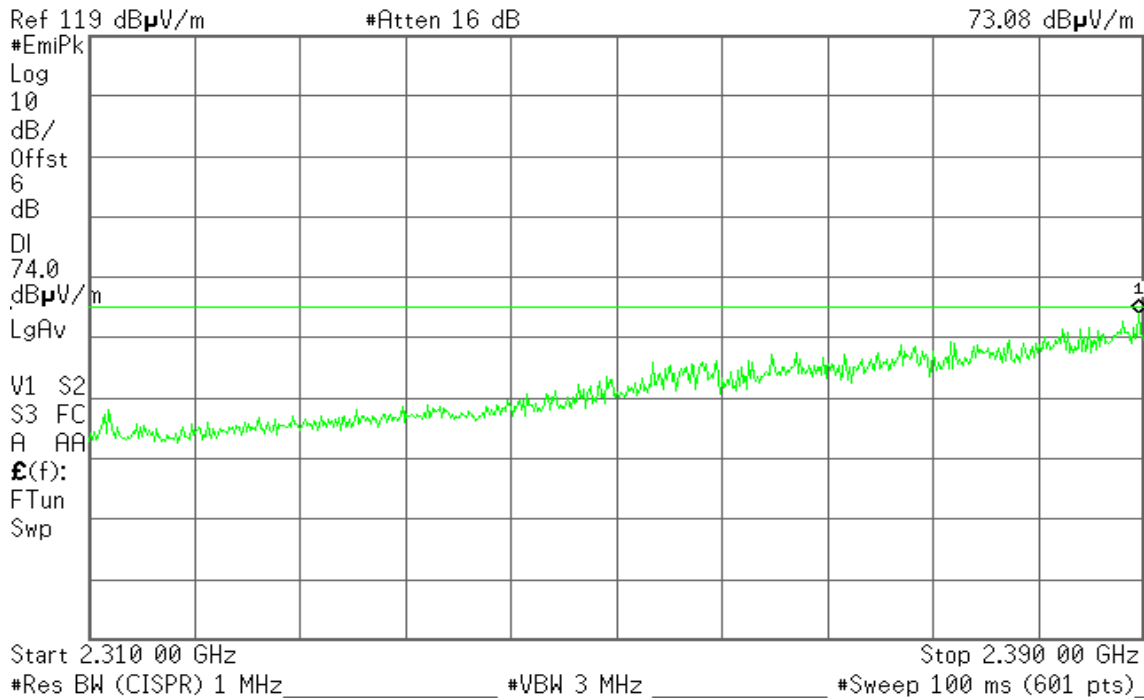

Detector mode: Average

Polarity: Horizontal

Agilent

R T

Mkr1 2.390 00 GHz
46.12 dBµV/m

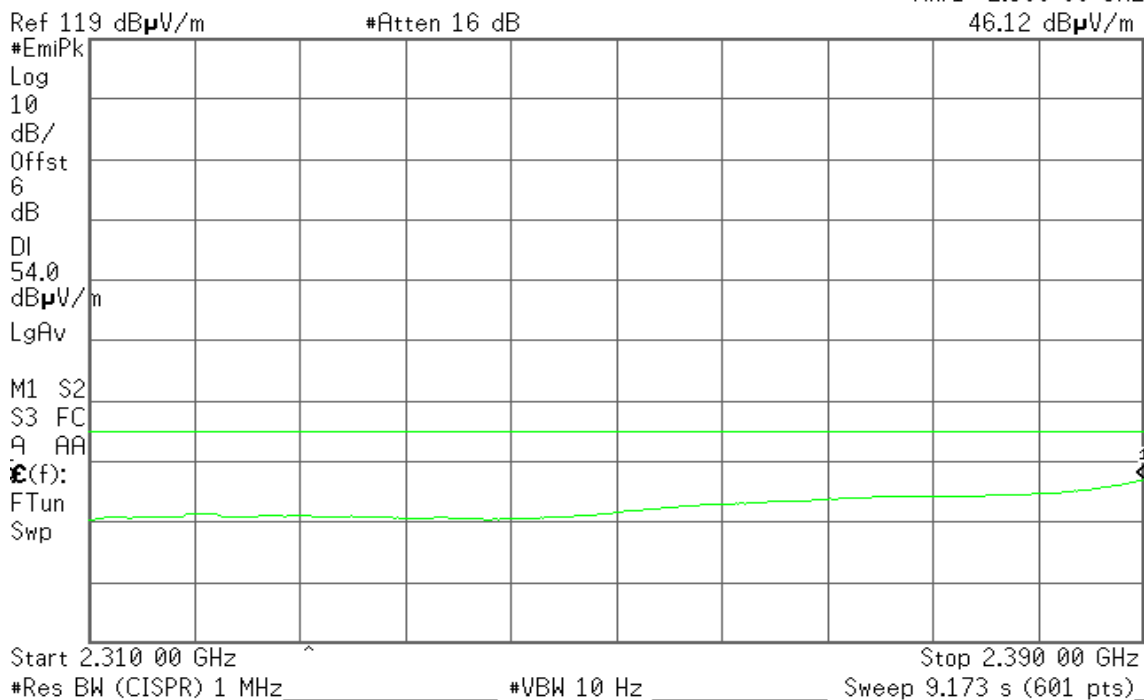



Band Edges (IEEE 802.11g mode / CH High)

Detector mode: Peak

Polarity: Vertical

Agilent

R T

Mkr1 2.483 56 GHz
73.61 dB μ V/m

Ref 119 dB μ V/m

#Atten 16 dB

#EmiPk
Log
10
dB/
Offst
6
dB
DI
74.0
dB μ V/m
LgAv
V1 S2
S3 FC
A AA
E(f):
FTun
Swp

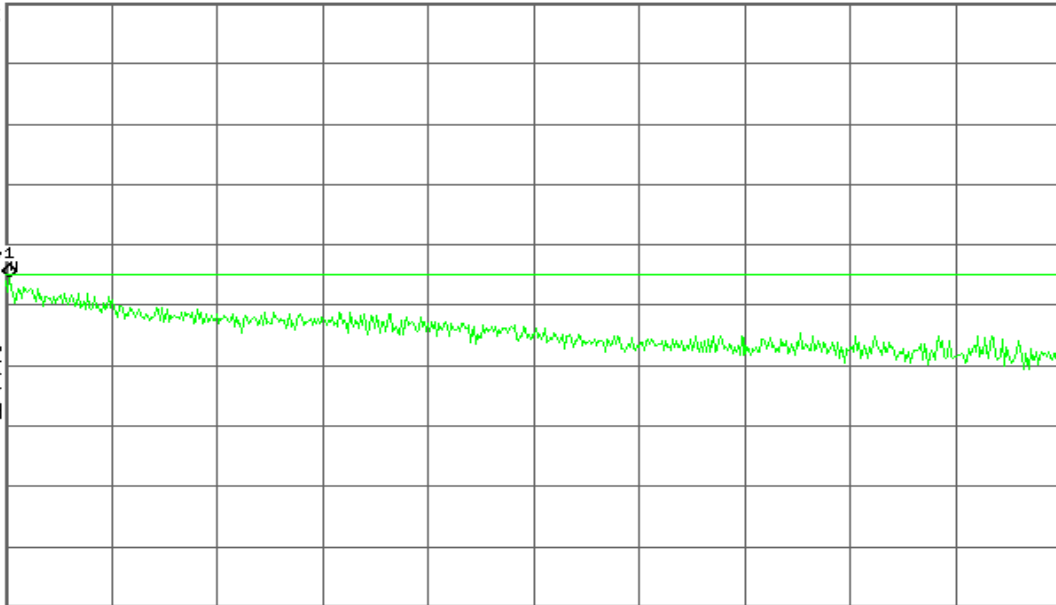

Start 2.483 50 GHz

Stop 2.500 00 GHz

#Res BW (CISPR) 1 MHz

#VBW 3 MHz

#Sweep 100 ms (601 pts)

Detector mode: Average

Polarity: Vertical

Agilent

R T

Mkr1 2.483 53 GHz
46.02 dB μ V/m

Ref 119 dB μ V/m

#Atten 16 dB

#EmiPk
Log
10
dB/
Offst
6
dB
DI
54.0
dB μ V/m
LgAv
M1 S2
S3 FC
A AA
E(f):
FTun
Swp

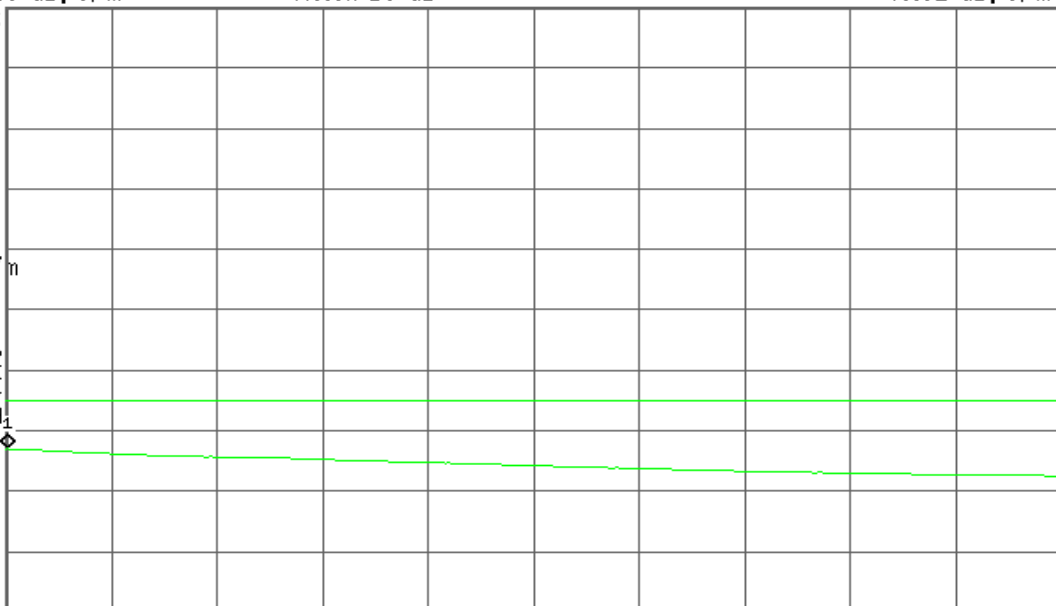

Start 2.483 50 GHz

Stop 2.500 00 GHz

#Res BW (CISPR) 1 MHz

#VBW 10 Hz

Sweep 1.892 s (601 pts)



Detector mode: Peak

Polarity: Horizontal

Agilent

R T

Mkr1 2.483 56 GHz
73.39 dBµV/m

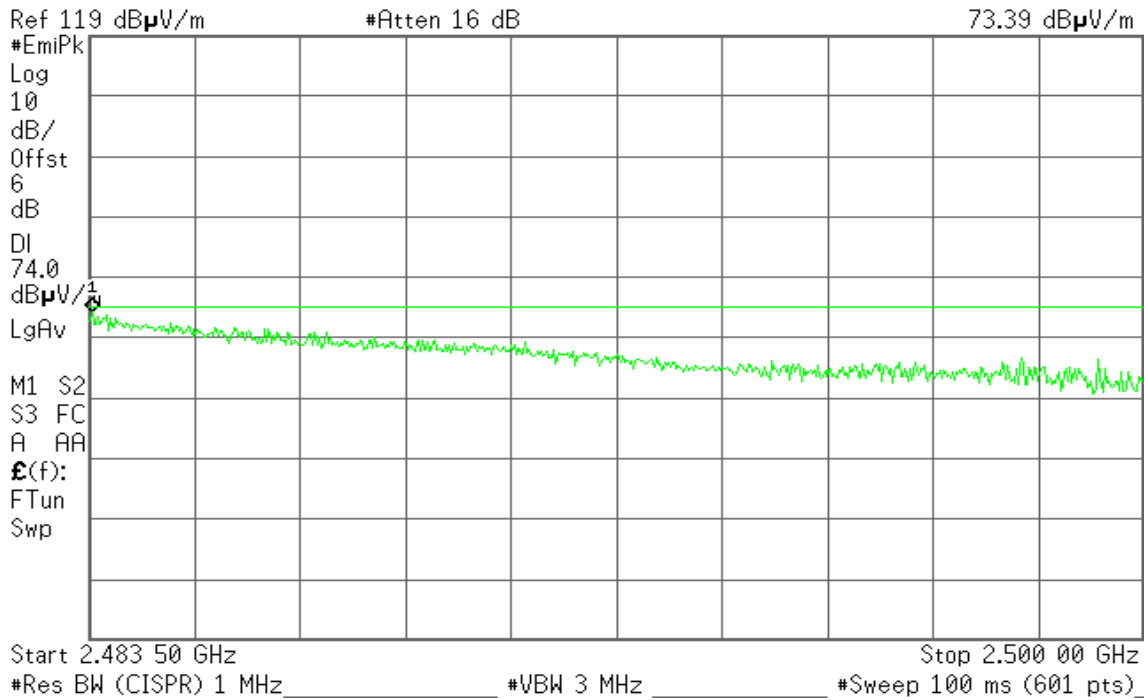

Detector mode: Average

Polarity: Horizontal

Agilent

R T

Mkr1 2.483 53 GHz
45.75 dBµV/m

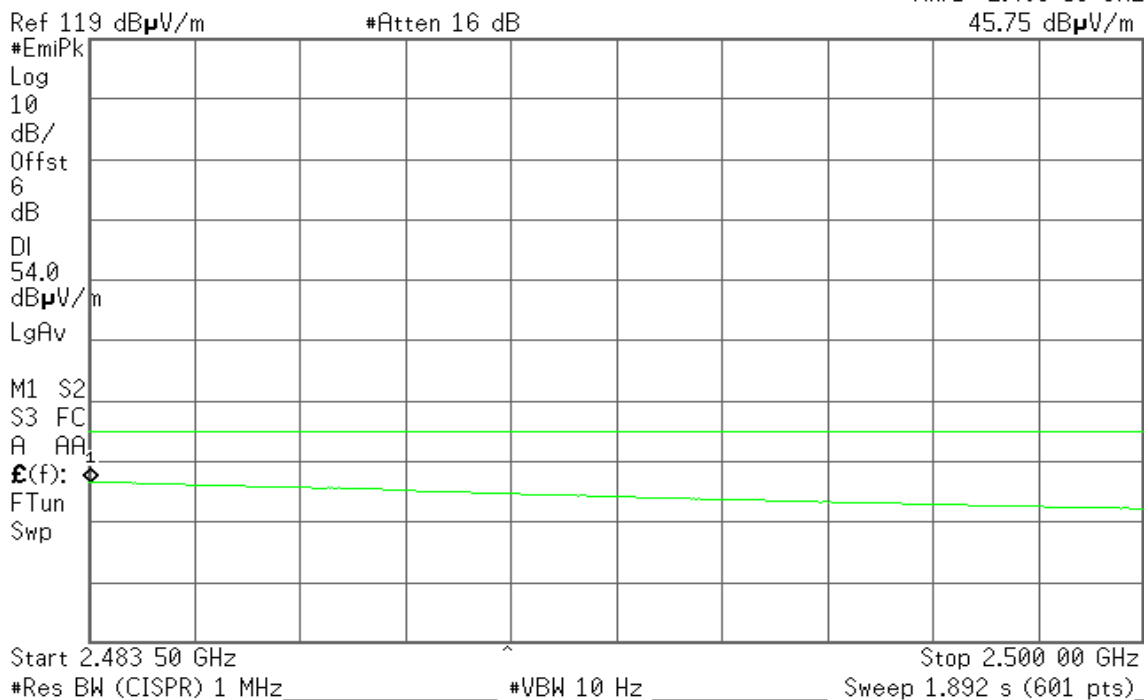



Band Edges (IEEE 802.11n HT 20 MHz mode / CH Low)

Detector mode: Peak

Polarity: Vertical

Agilent

R T

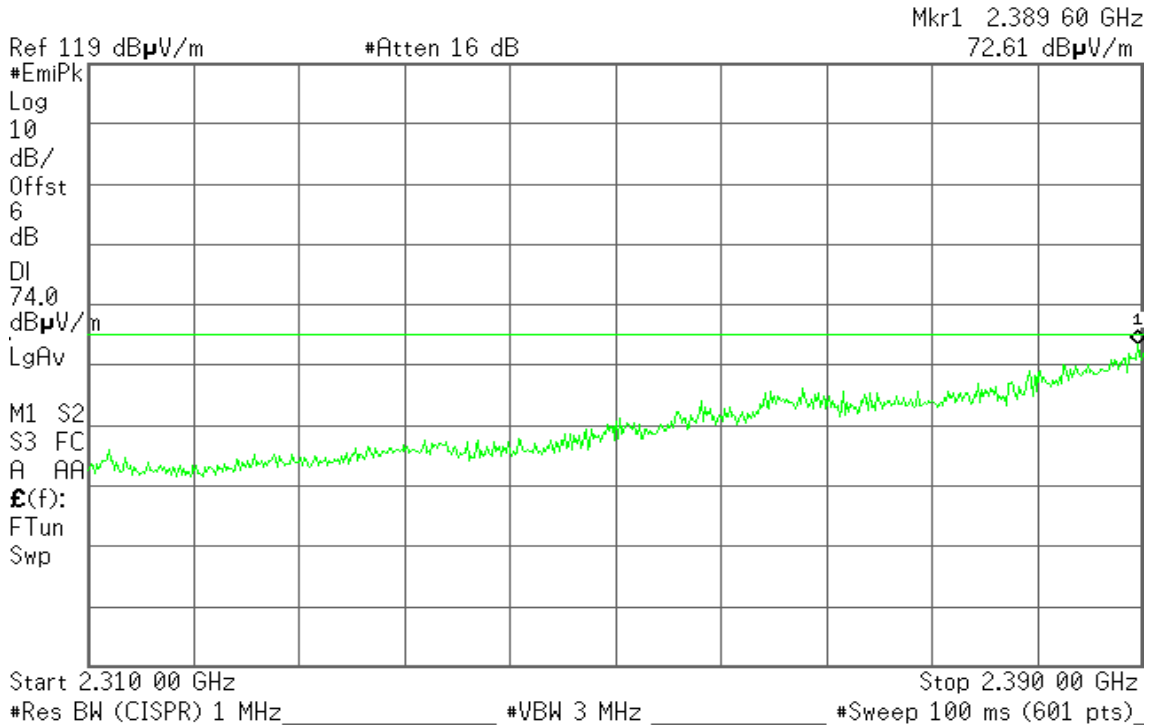

Detector mode: Average

Polarity: Vertical

Agilent

R T

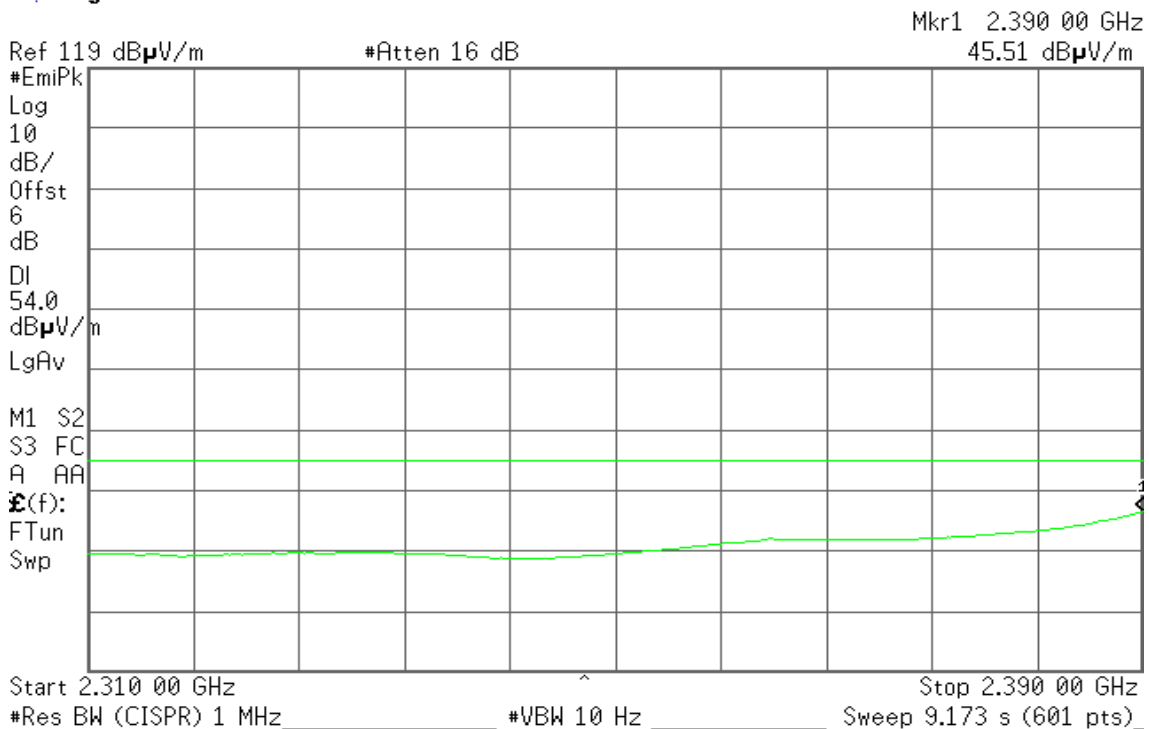



Detector mode: Peak

Polarity: Horizontal

Agilent

R T

Mkr1 2.390 00 GHz
73.41 dBµV/m

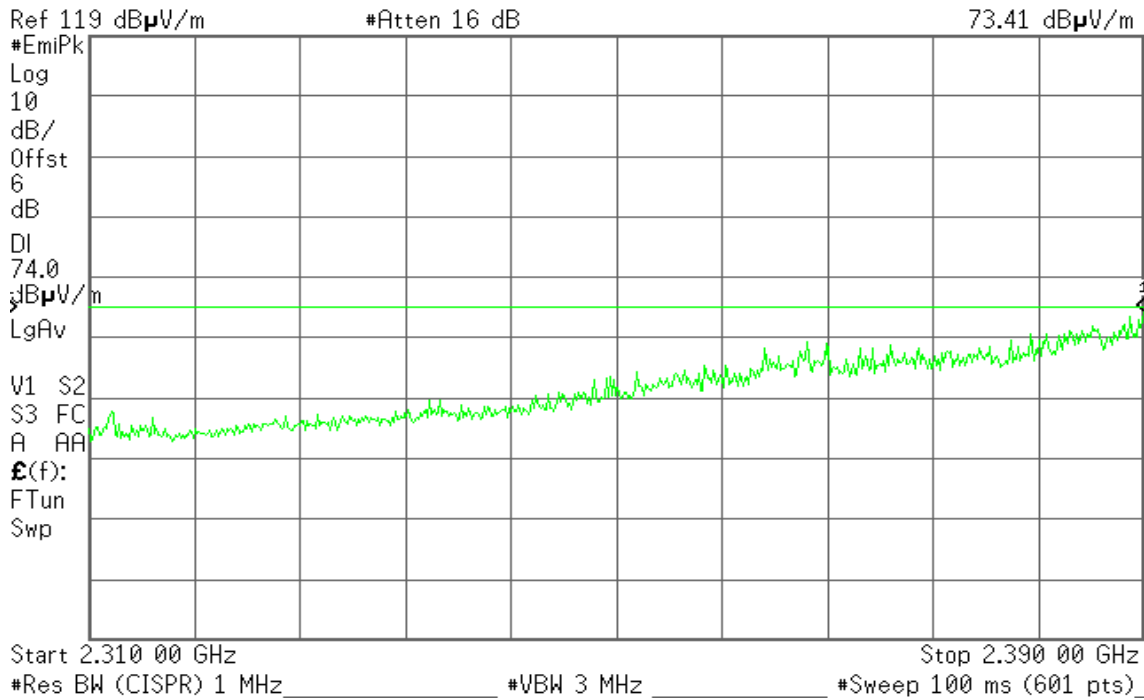

Detector mode: Average

Polarity: Horizontal

Agilent

R T

Mkr1 2.390 00 GHz
46.51 dBµV/m

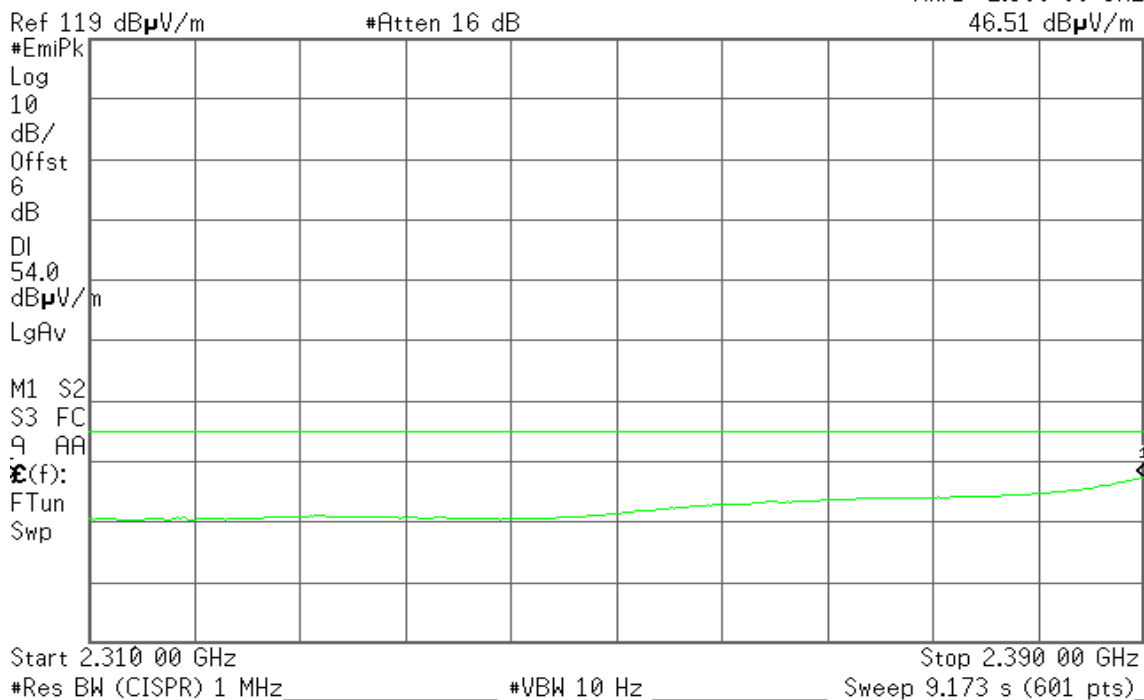



Band Edges (IEEE 802.11n HT 20 MHz mode / CH High)

Detector mode: Peak

Polarity: Vertical

Agilent

R T

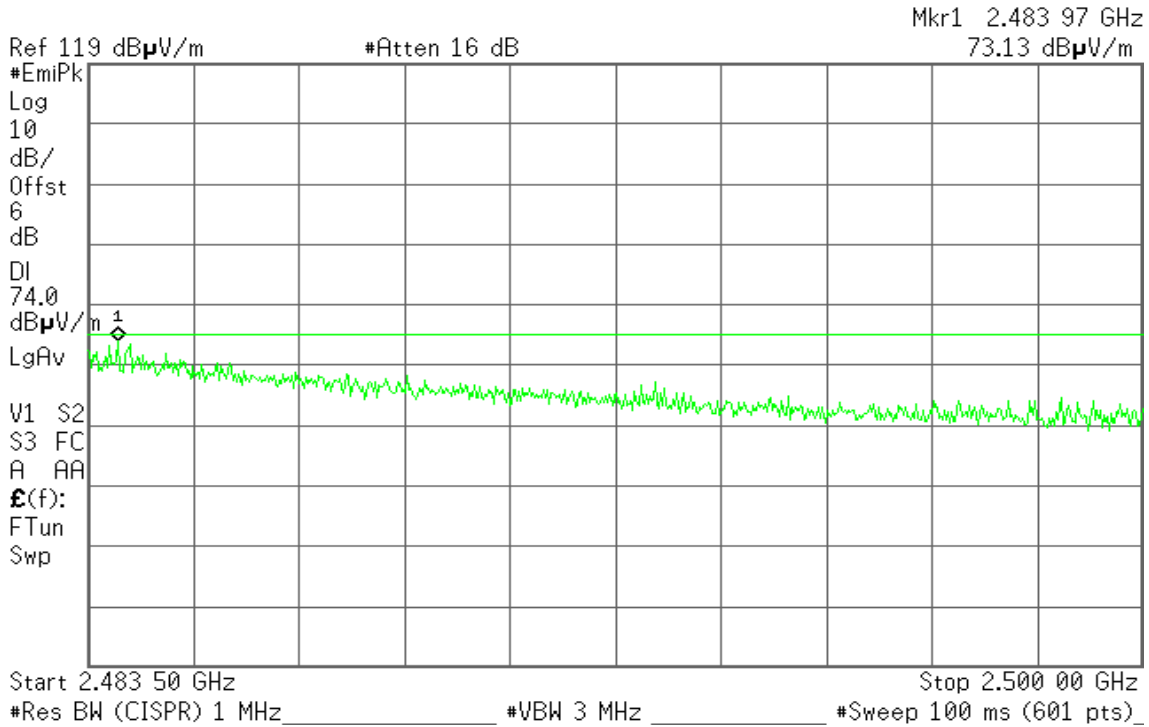

Detector mode: Average

Polarity: Vertical

Agilent

R T

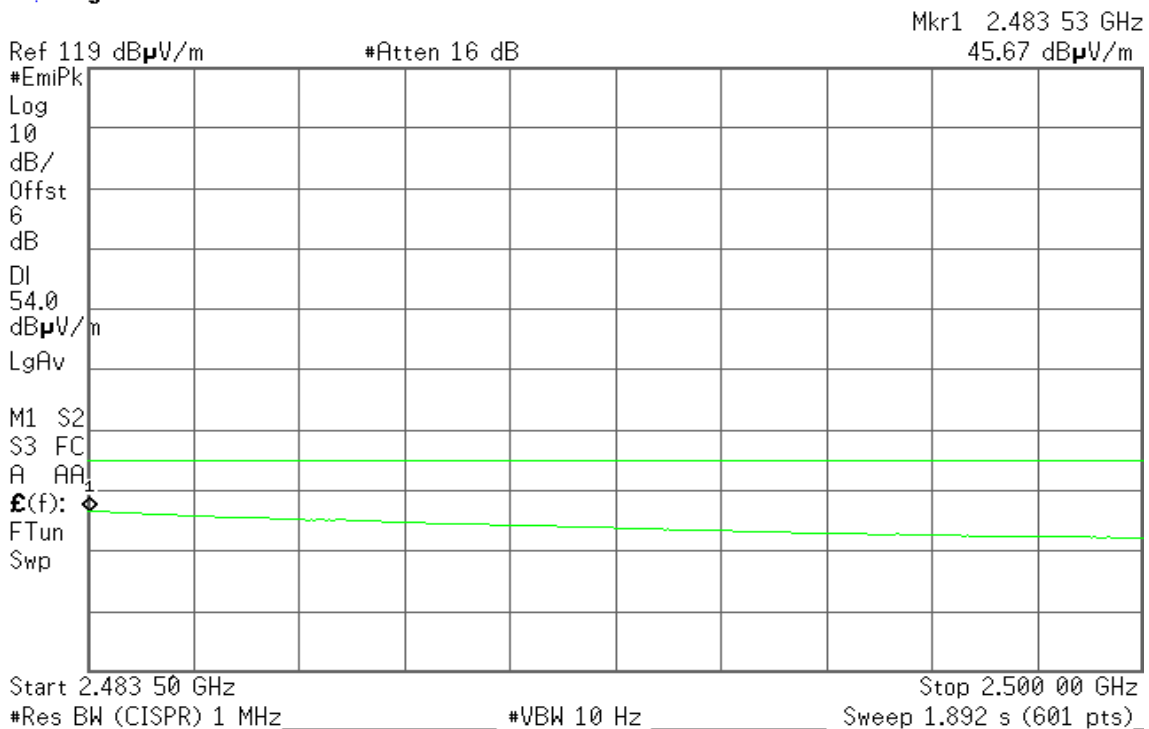



Detector mode: Peak

Polarity: Horizontal

Agilent

R T

Mkr1 2.483 75 GHz
73.62 dBµV/m

Ref 119 dBµV/m

#Atten 16 dB

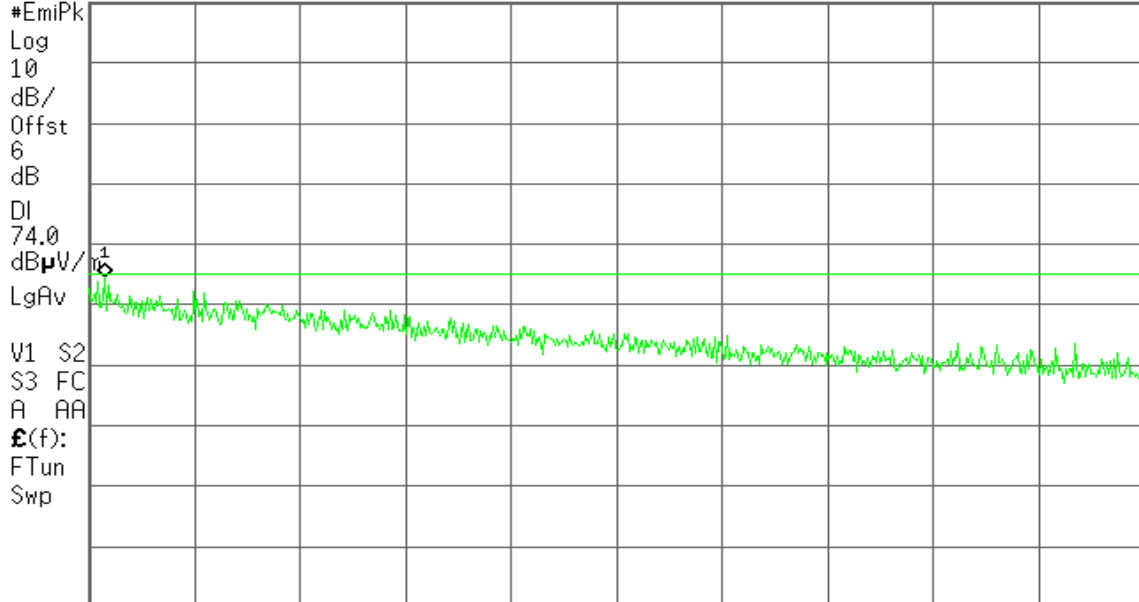

Start 2.483 50 GHz

Stop 2.500 00 GHz

#Res BW (CISPR) 1 MHz

#VBW 3 MHz

#Sweep 100 ms (601 pts)

Detector mode: Average

Polarity: Horizontal

Agilent

R T

Mkr1 2.483 50 GHz
45.89 dBµV/m

Ref 119 dBµV/m

#Atten 16 dB

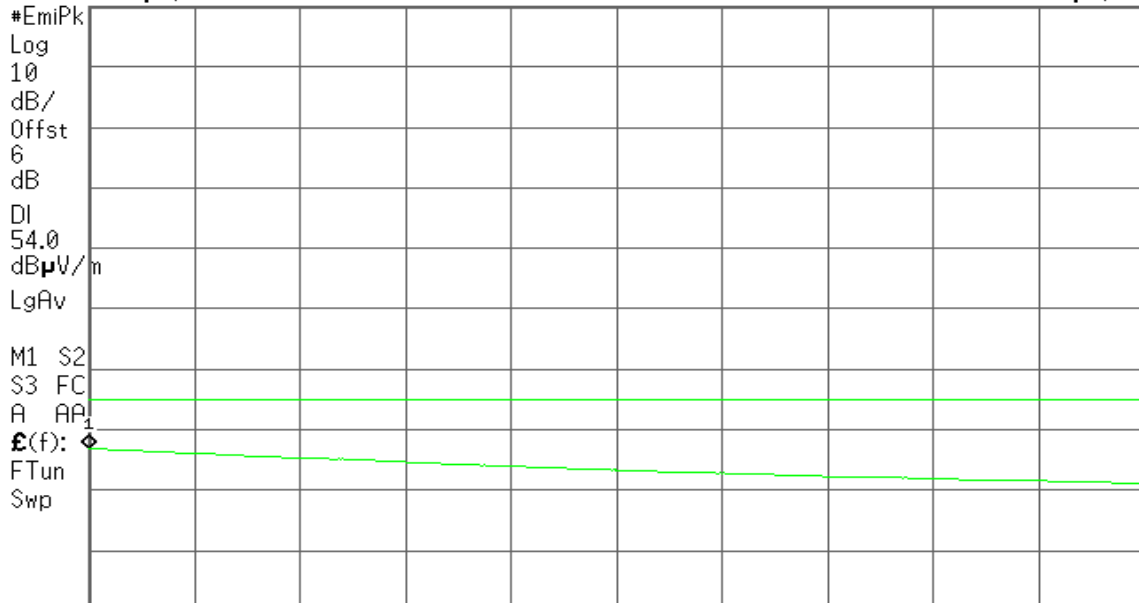

Start 2.483 50 GHz

Stop 2.500 00 GHz

#Res BW (CISPR) 1 MHz

#VBW 10 Hz

Sweep 1.892 s (601 pts)



Test Plot

Conducted Band Edges (IEEE 802.11b mode / CH Low)

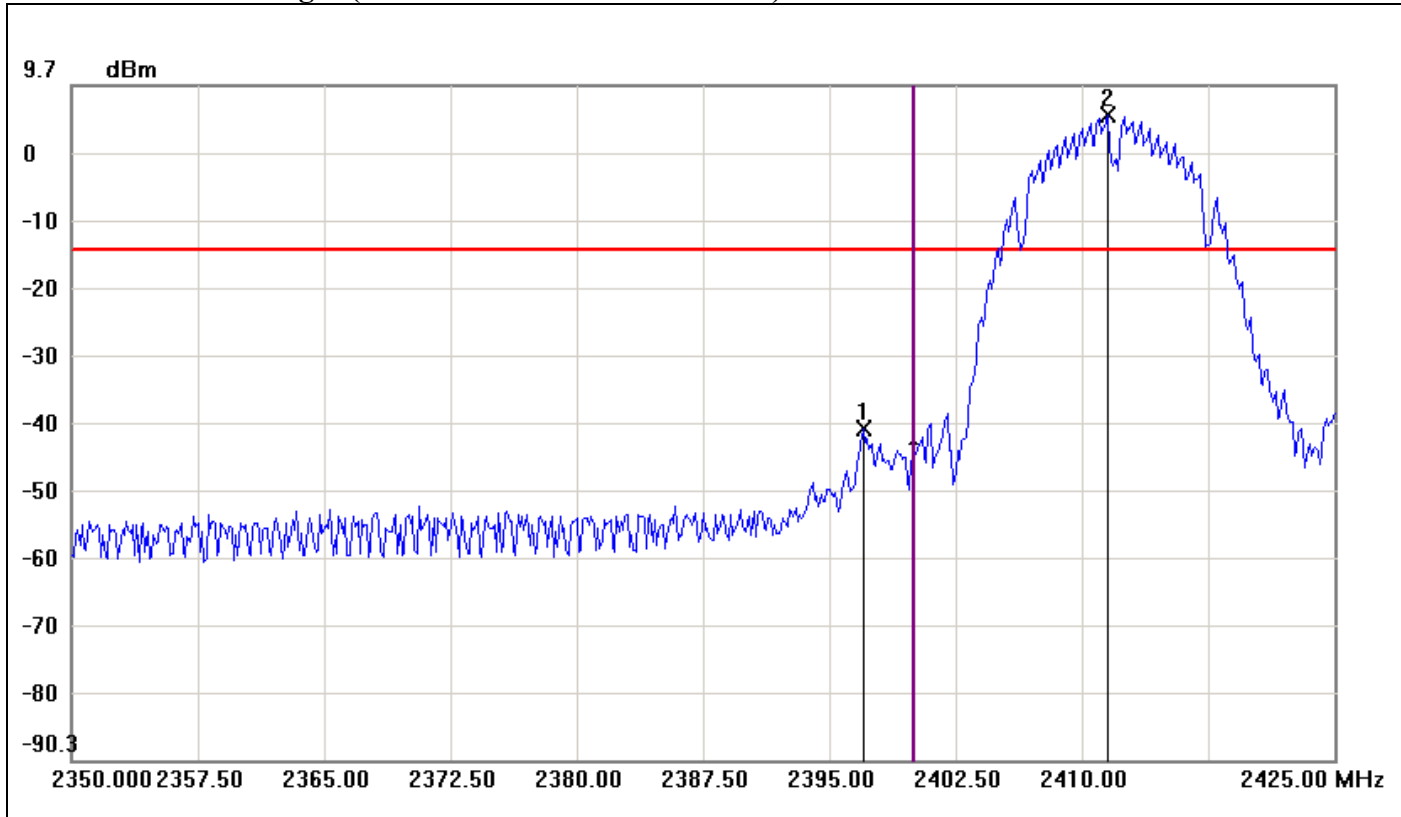

No.	Frequency(MHz)	Result(dBm)	Limit(dBm)	Margin(dBm)
1	2397.0000	-41.23	-14.62	-26.61
2	2411.5000	5.38	-14.62	20.00



Conducted Band Edges (IEEE 802.11b mode / CH High)

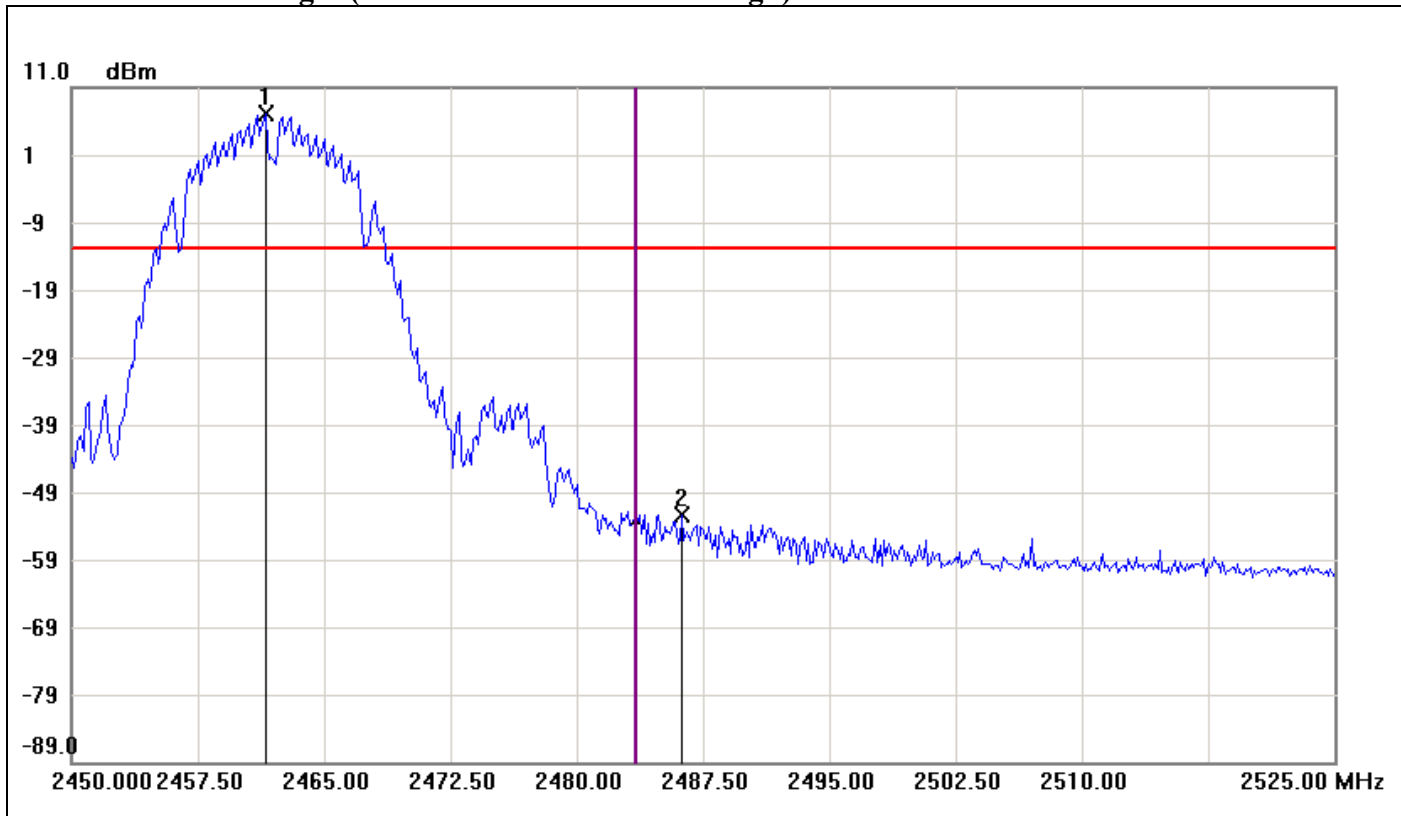

No.	Frequency(MHz)	Result(dBm)	Limit(dBm)	Margin(dBm)
1	2461.5000	7.09	-12.91	20.00
2	2486.2500	-52.27	-12.91	-39.36



Conducted Band Edges (IEEE 802.11g mode / CH Low)

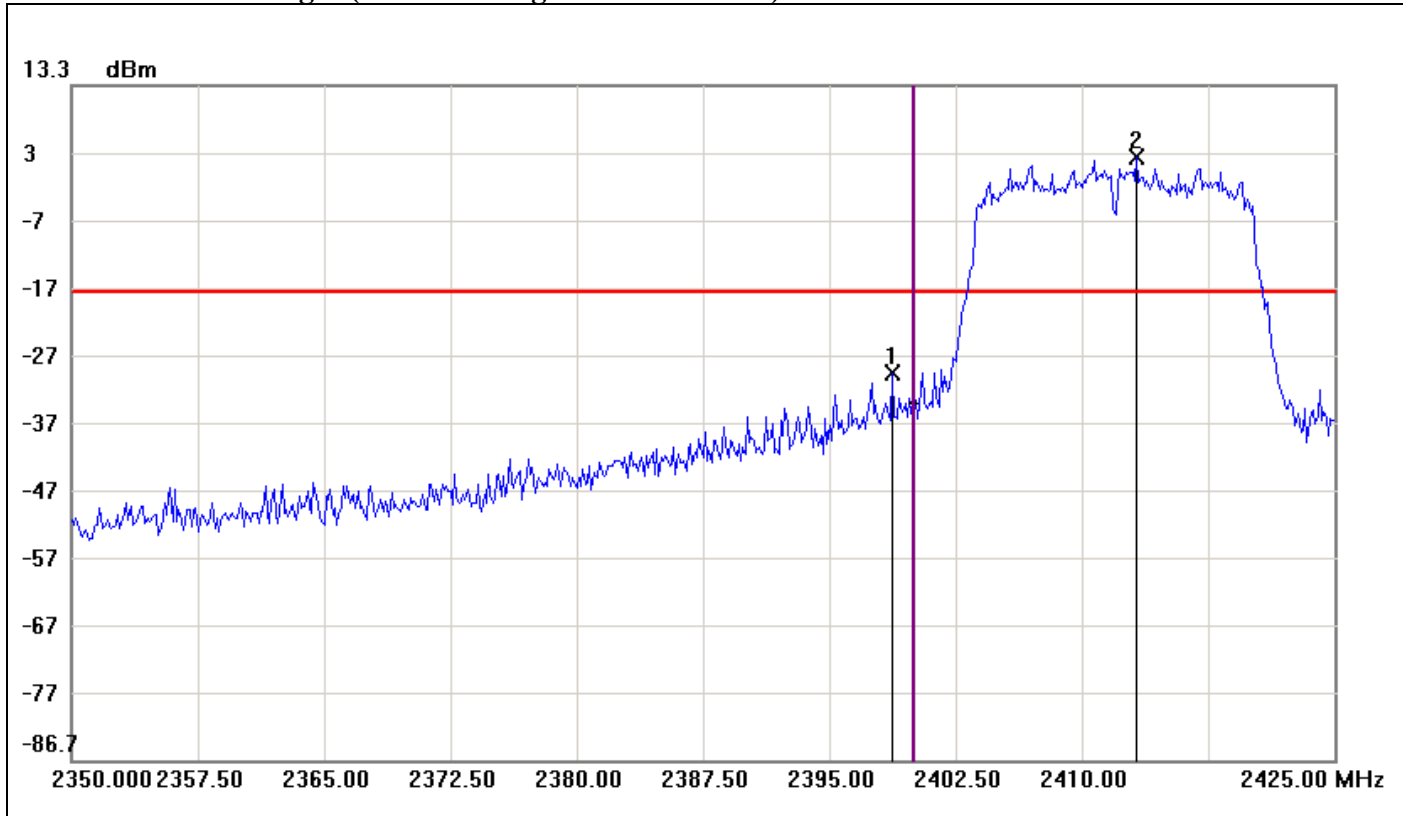

No.	Frequency(MHz)	Result(dBm)	Limit(dBm)	Margin(dBm)
1	2398.7500	-29.35	-17.29	-12.06
2	2413.2500	2.71	-17.29	20.00



Conducted Band Edges (IEEE 802.11g mode / CH High)

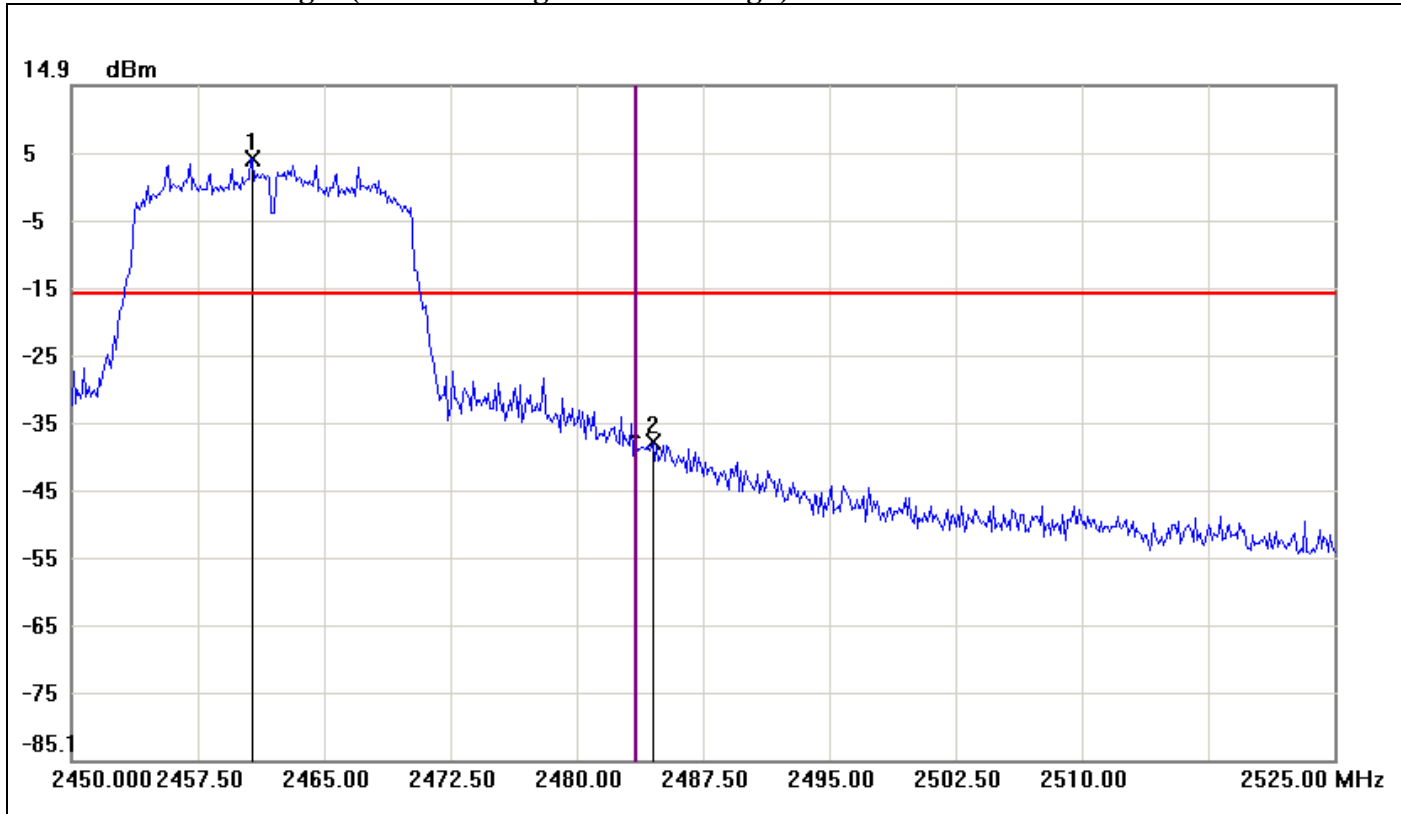

No.	Frequency(MHz)	Result(dBm)	Limit(dBm)	Margin(dBm)
1	2460.7500	3.95	-16.05	20.00
2	2484.5000	-38.05	-16.05	-22.00



Conducted Band Edges (IEEE 802.11n HT 20 MHz mode / CH Low)

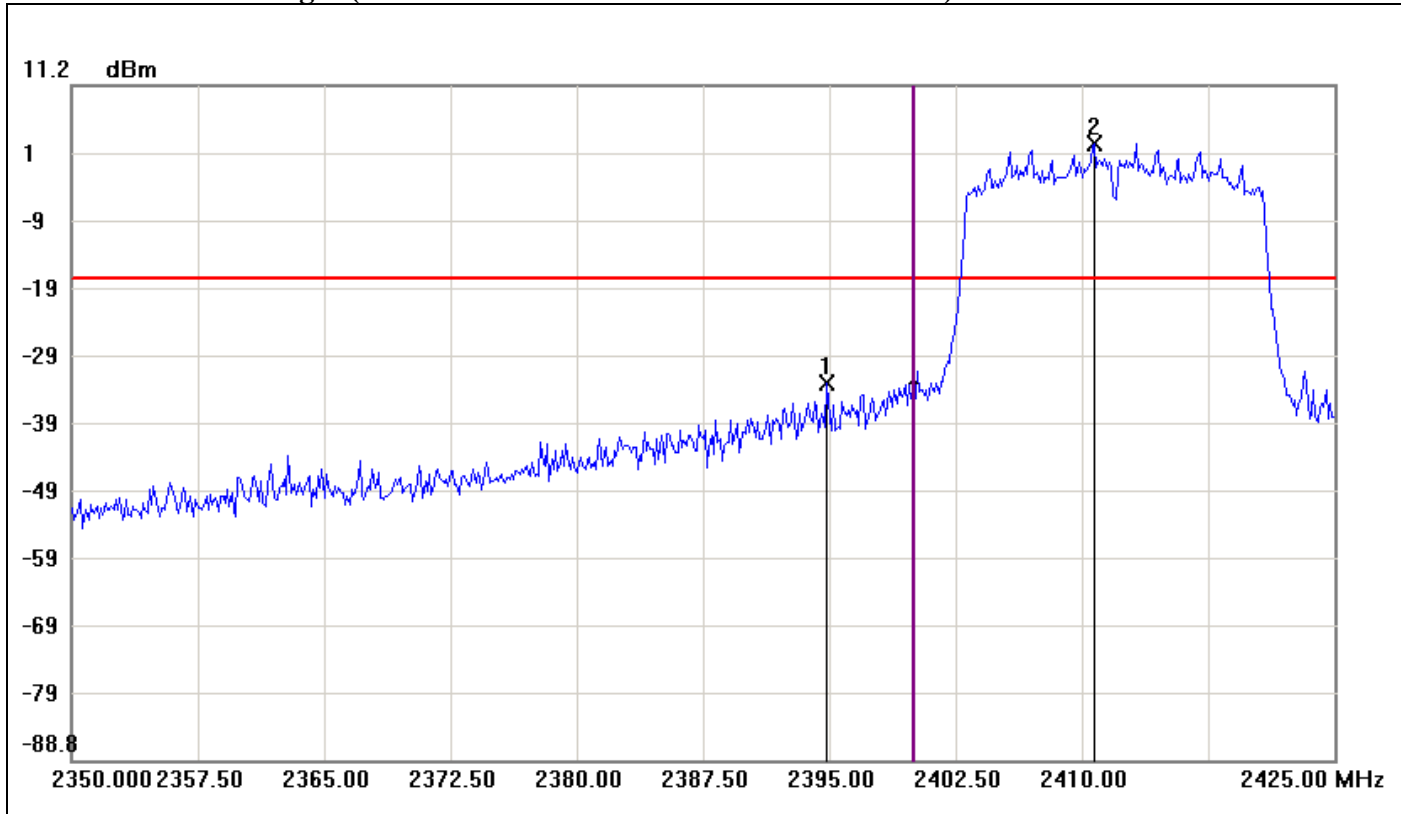

No.	Frequency(MHz)	Result(dBm)	Limit(dBm)	Margin(dBm)
1	2394.8750	-32.84	-17.39	-15.45
2	2410.7500	2.61	-17.39	20.00



Conducted Band Edges (IEEE 802.11n HT 20 MHz mode / CH High)

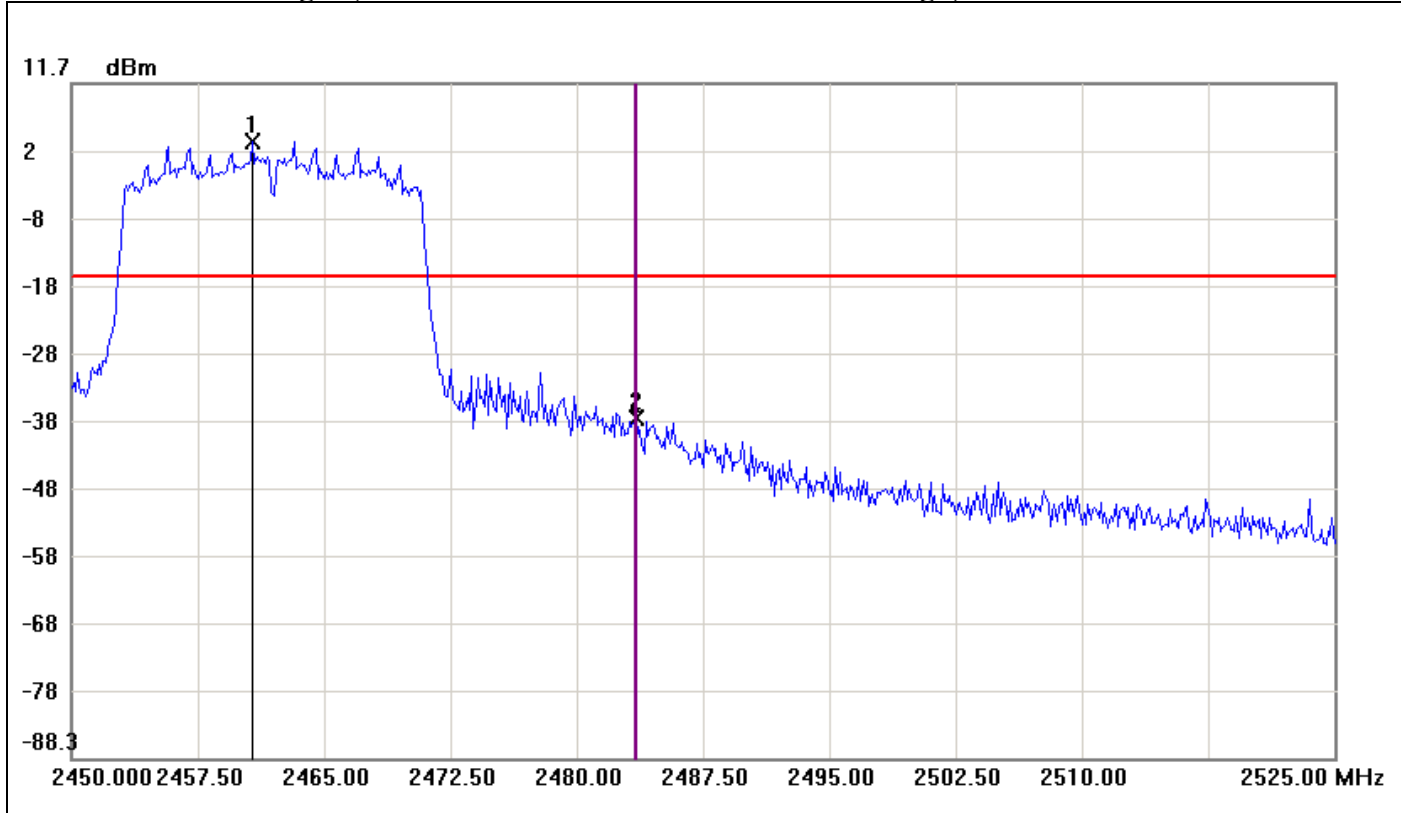

No.	Frequency(MHz)	Result(dBm)	Limit(dBm)	Margin(dBm)
1	2460.7500	3.12	-16.88	20.00
2	2483.5000	-38.00	-16.88	-21.12



8.6 PEAK POWER SPECTRAL DENSITY

LIMIT

1. According to §15.247(e) & RSS-210 §A8.2, for digitally modulated systems, the power spectral density conducted from the intentional radiator to the antenna shall not be greater than 8 dBm in any 3 kHz band during any time interval of continuous transmission.
2. According to §15.247(f) & RSS-210 §A8.3, the digital modulation operation of the hybrid system, with the frequency hopping turned off, shall comply with the power density requirements of paragraph (d) of this section.

Test Configuration

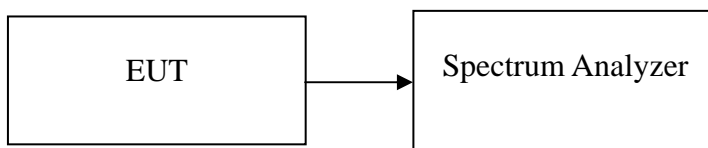

TEST PROCEDURE

1. Place the EUT on the table and set it in transmitting mode.
Remove the antenna from the EUT and then connect a low loss RF cable from the antenna port to the spectrum analyzer.
2. Set the spectrum analyzer as RBW = 10 kHz, VBW = 100 kHz, Span = 1.5 times the DTS bandwidth, Sweep time = 138.48ms
3. Record the max reading.
4. Repeat the above procedure until the measurements for all frequencies are completed.

TEST RESULTS

No non-compliance noted



Test Data

Test mode: IEEE 802.11b mode

Channel	Frequency (MHz)	PPSD (dBm)	Limit (dBm)	Result
Low	2412	-3.17	8.00	PASS
Mid	2437	-1.93		PASS
High	2462	-1.14		PASS

Test mode: IEEE 802.11g mode

Channel	Frequency (MHz)	PPSD (dBm)	Limit (dBm)	Result
Low	2412	-4.93	8.00	PASS
Mid	2437	-2.00		PASS
High	2462	-3.65		PASS

Test mode: IEEE 802.11n HT 20 MHz mode Channel mode

Channel	Frequency (MHz)	PPSD (dBm)	Limit (dBm)	Result
Low	2412	-5.59	8.00	PASS
Mid	2437	-2.46		PASS
High	2462	-4.33		PASS



Test Plot

IEEE 802.11b mode

PPSD (CH Low)

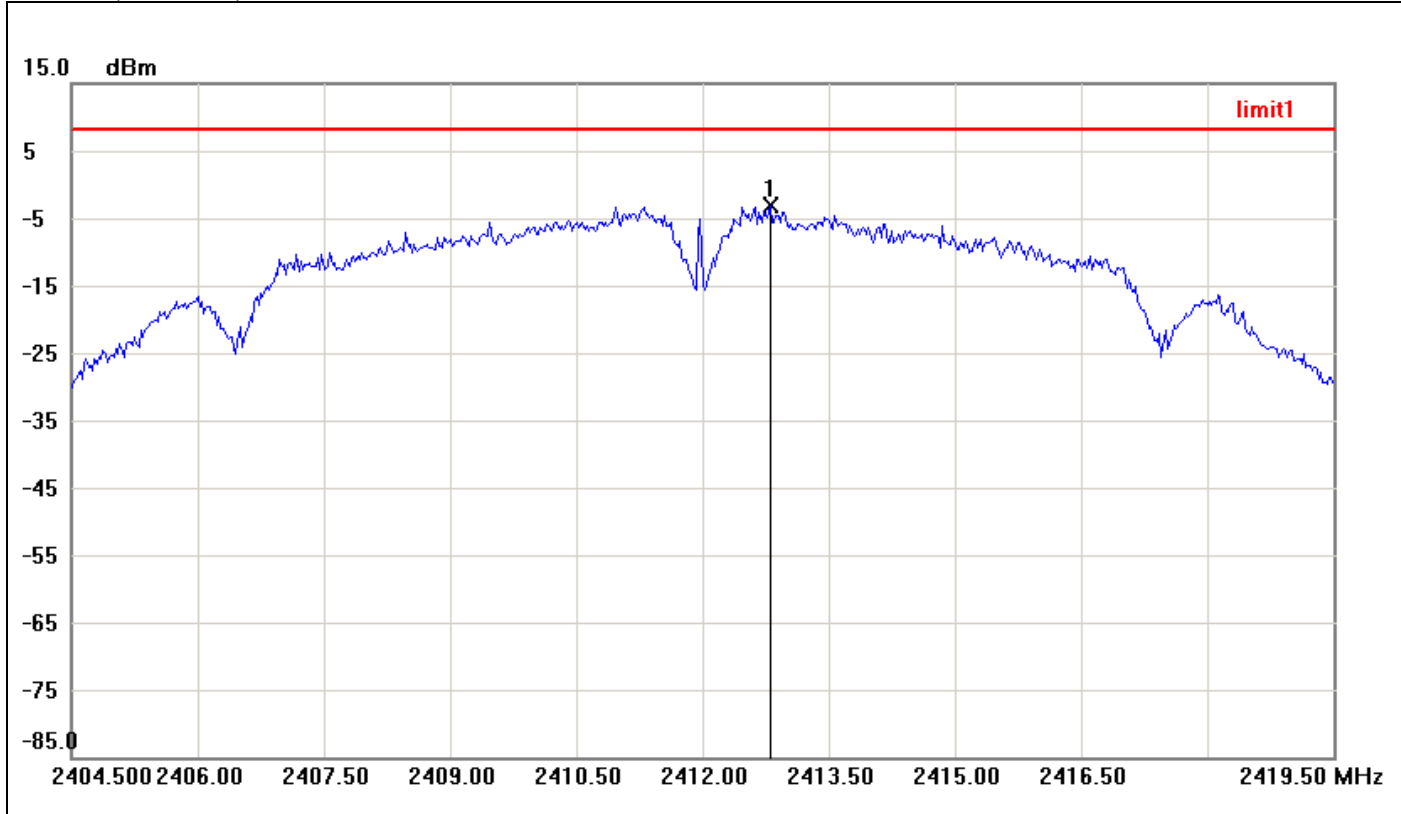

No.	Frequency(MHz)	Result(dBm)	Limit(dBm)	Margin(dBm)
1	2412.8000	-3.17	8.00	-11.17



PPSD (CH Mid)

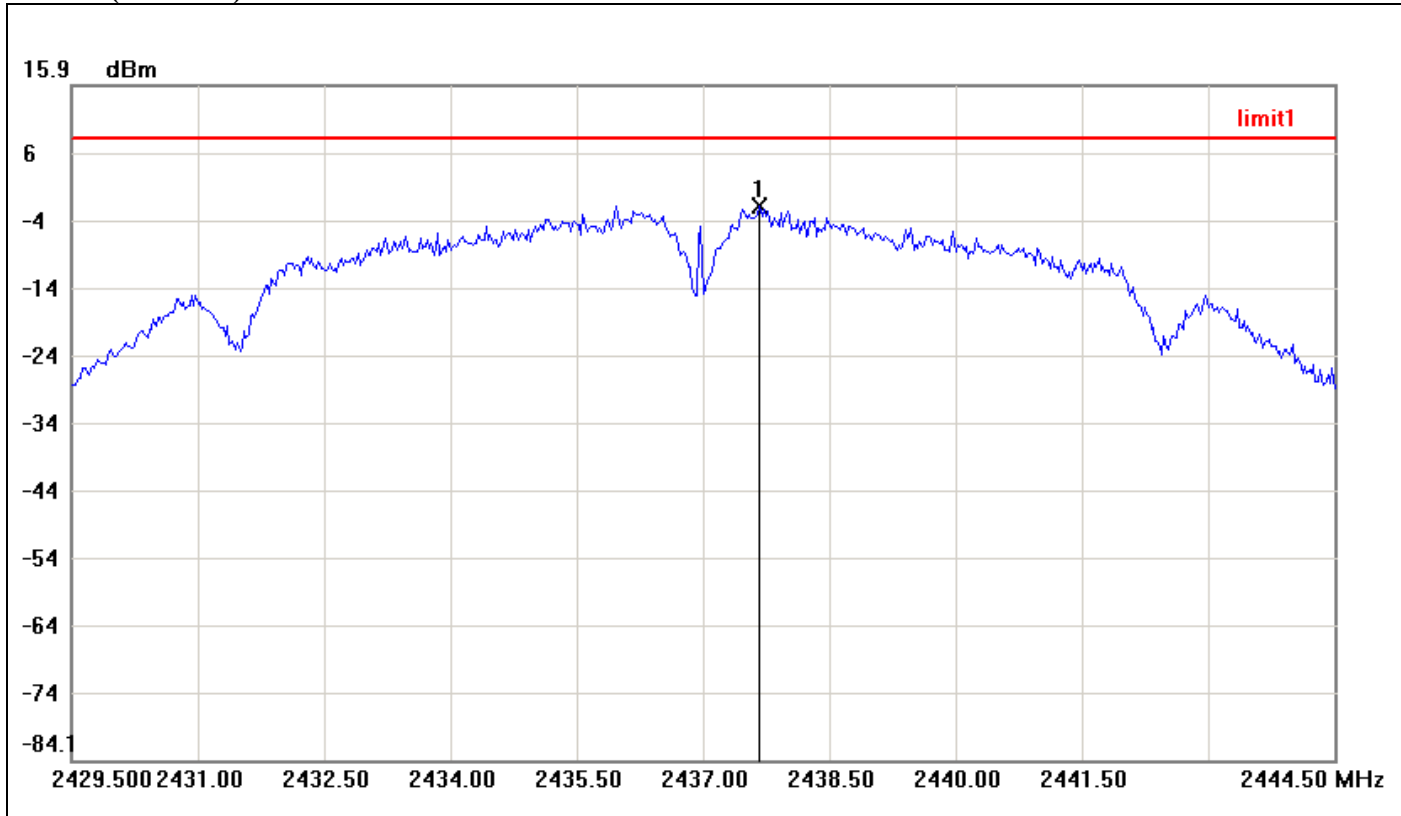

No.	Frequency(MHz)	Result(dBm)	Limit(dBm)	Margin(dBm)
1	2437.6750	-1.93	8.00	-9.93



PPSD (CH High)

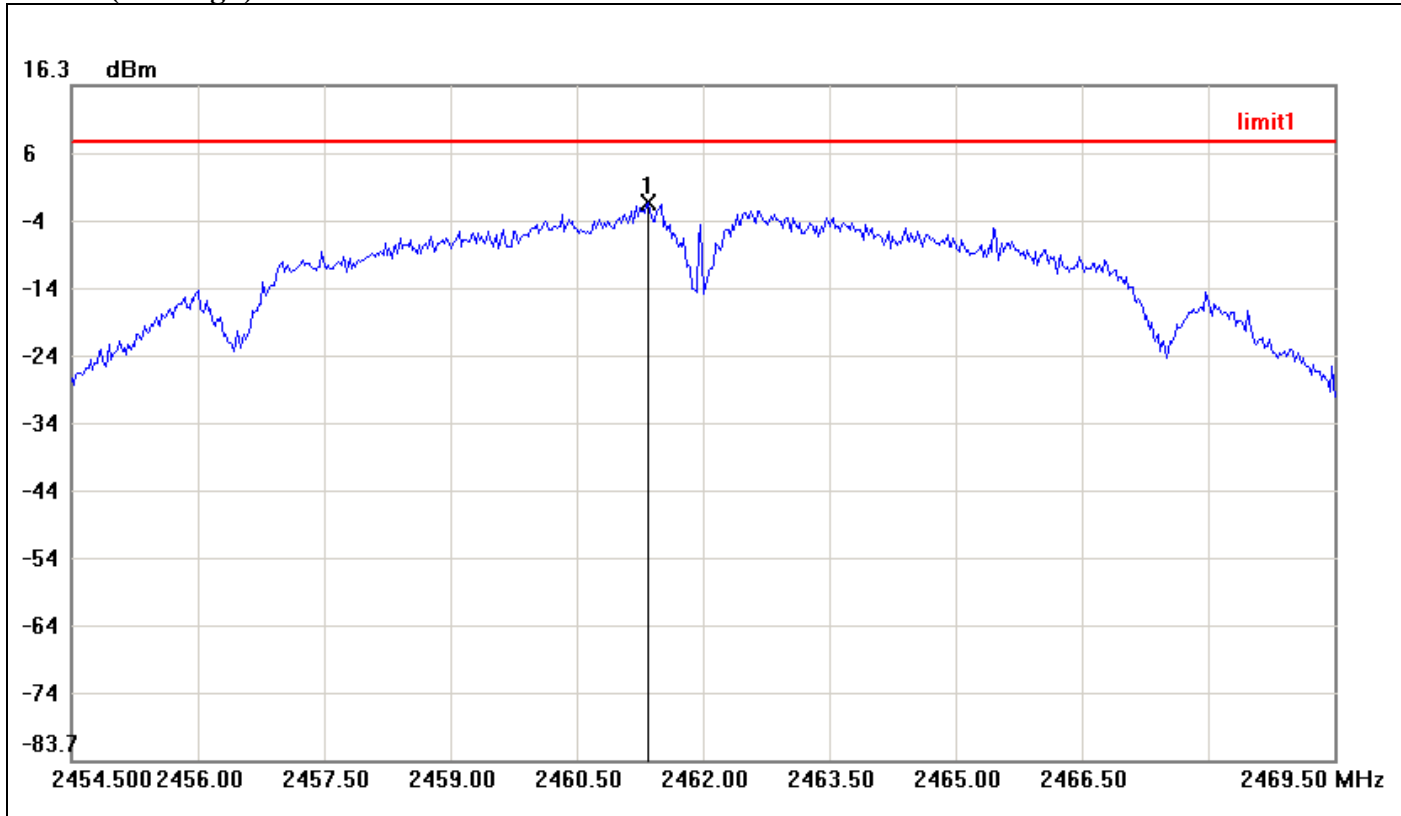

No.	Frequency(MHz)	Result(dBm)	Limit(dBm)	Margin(dBm)
1	2461.3500	-1.14	8.00	-9.14



IEEE 802.11g mode

PPSD (CH Low)

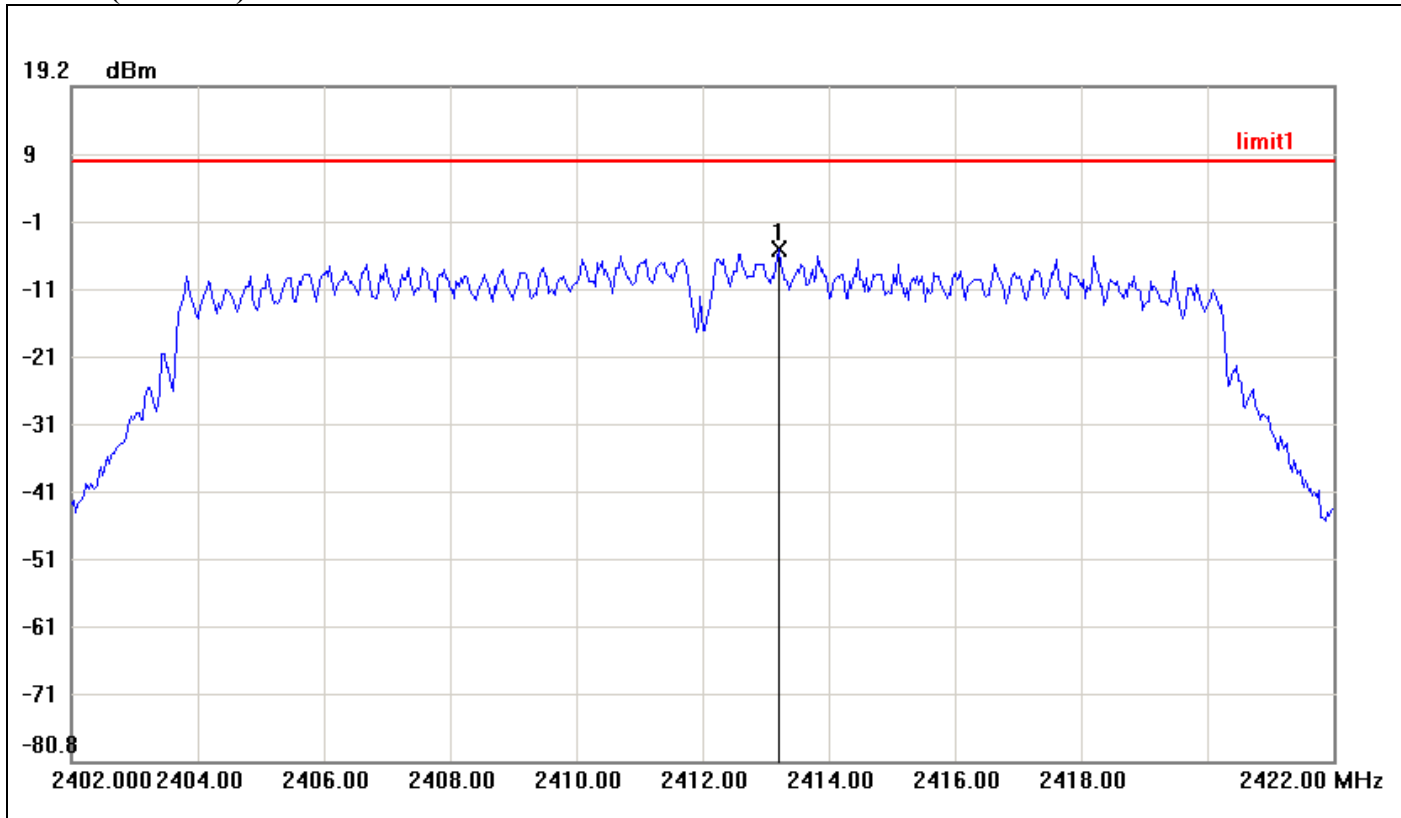

No.	Frequency(MHz)	Result(dBm)	Limit(dBm)	Margin(dBm)
1	2413.2000	-4.93	8.00	-12.93



PPSD (CH Mid)

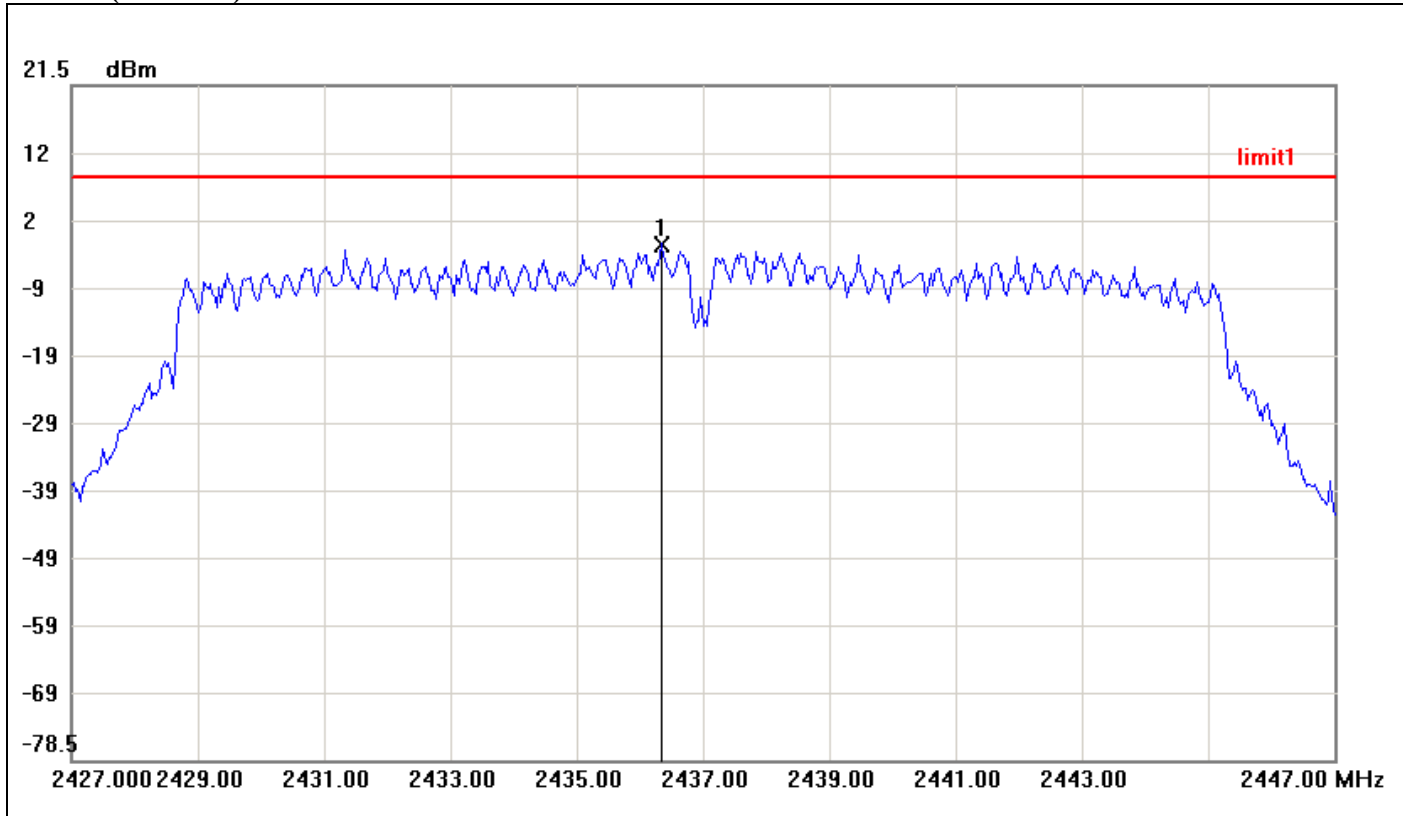

No.	Frequency(MHz)	Result(dBm)	Limit(dBm)	Margin(dBm)
1	2436.3333	-2.00	8.00	-10.00



PPSD (CH High)

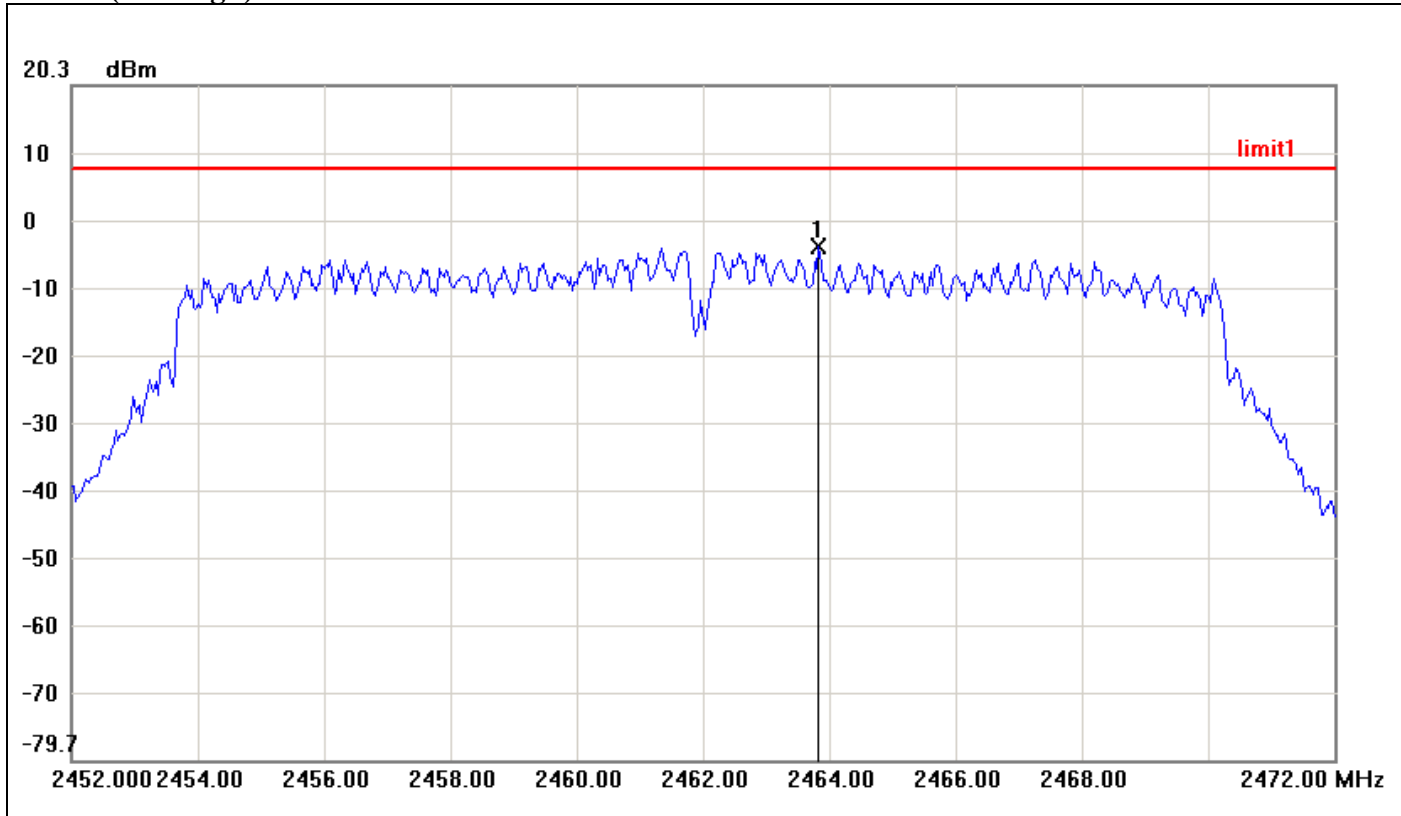

No.	Frequency(MHz)	Result(dBm)	Limit(dBm)	Margin(dBm)
1	2463.8333	-3.65	8.00	-11.65



IEEE 802.11n HT 20 MHz mode Channel mode

PPSD (CH Low)

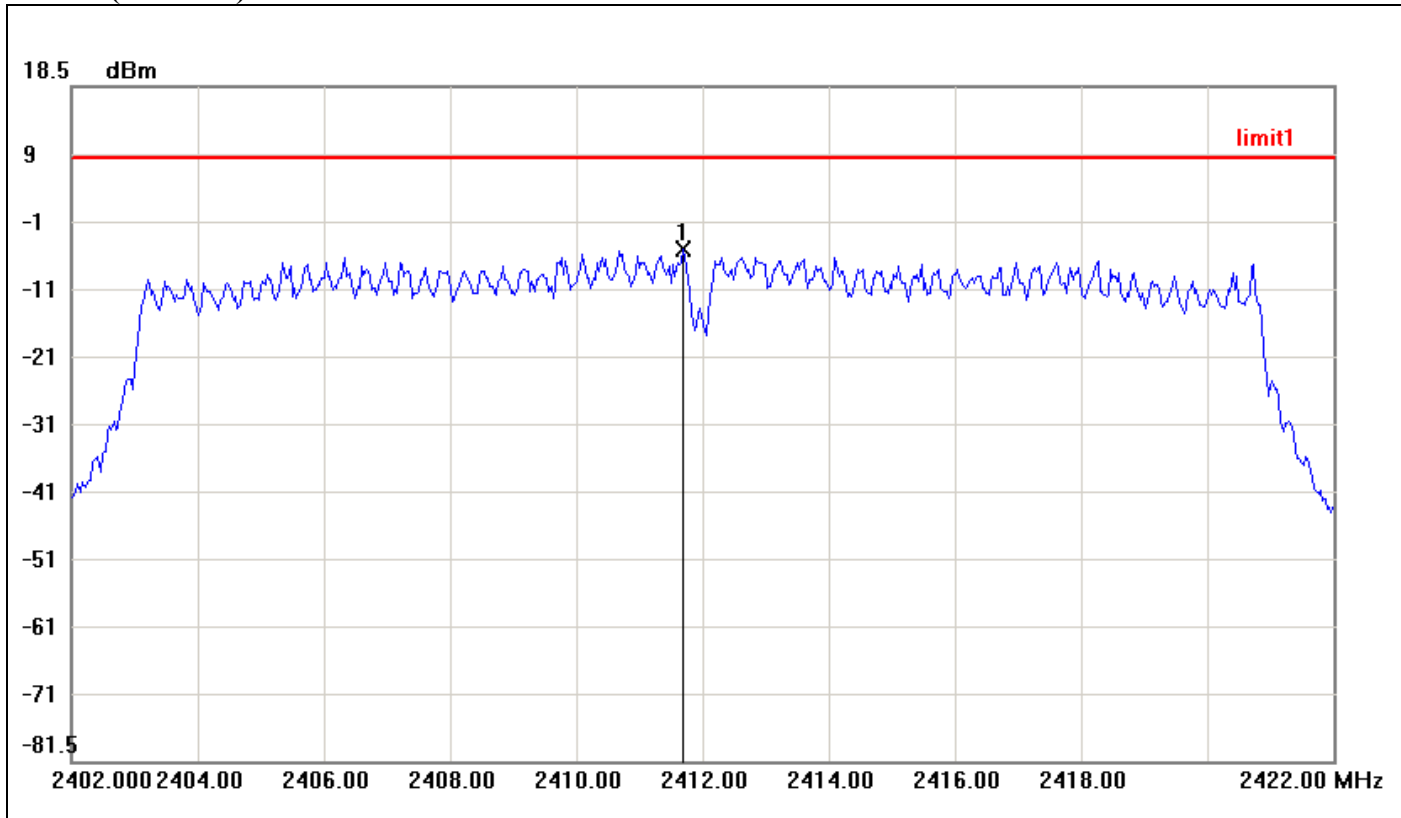

No.	Frequency(MHz)	Result(dBm)	Limit(dBm)	Margin(dBm)
1	2411.7000	-5.59	8.00	-13.59



PPSD (CH Mid)

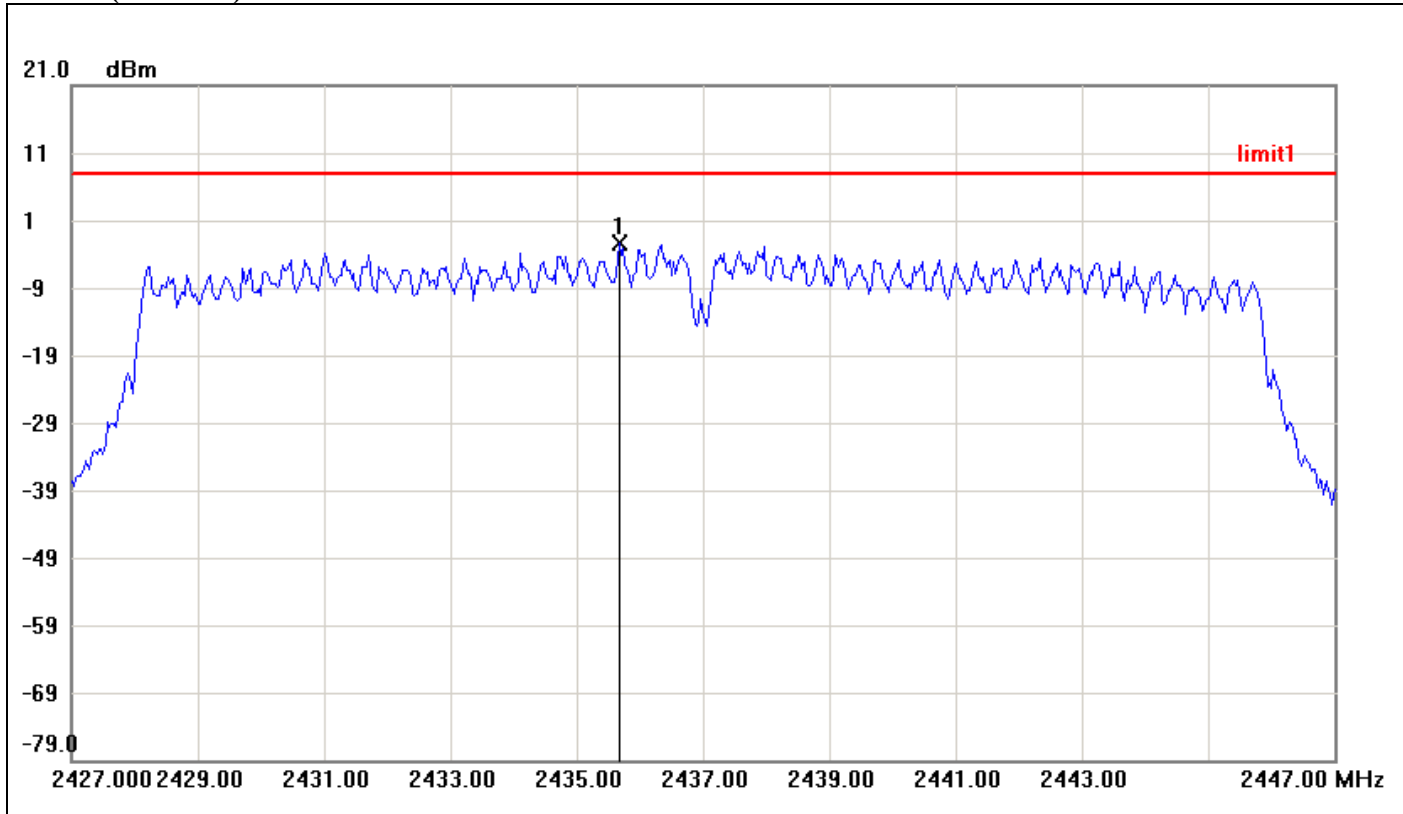

No.	Frequency(MHz)	Result(dBm)	Limit(dBm)	Margin(dBm)
1	2435.6667	-2.46	8.00	-10.46



PPSD (CH High)

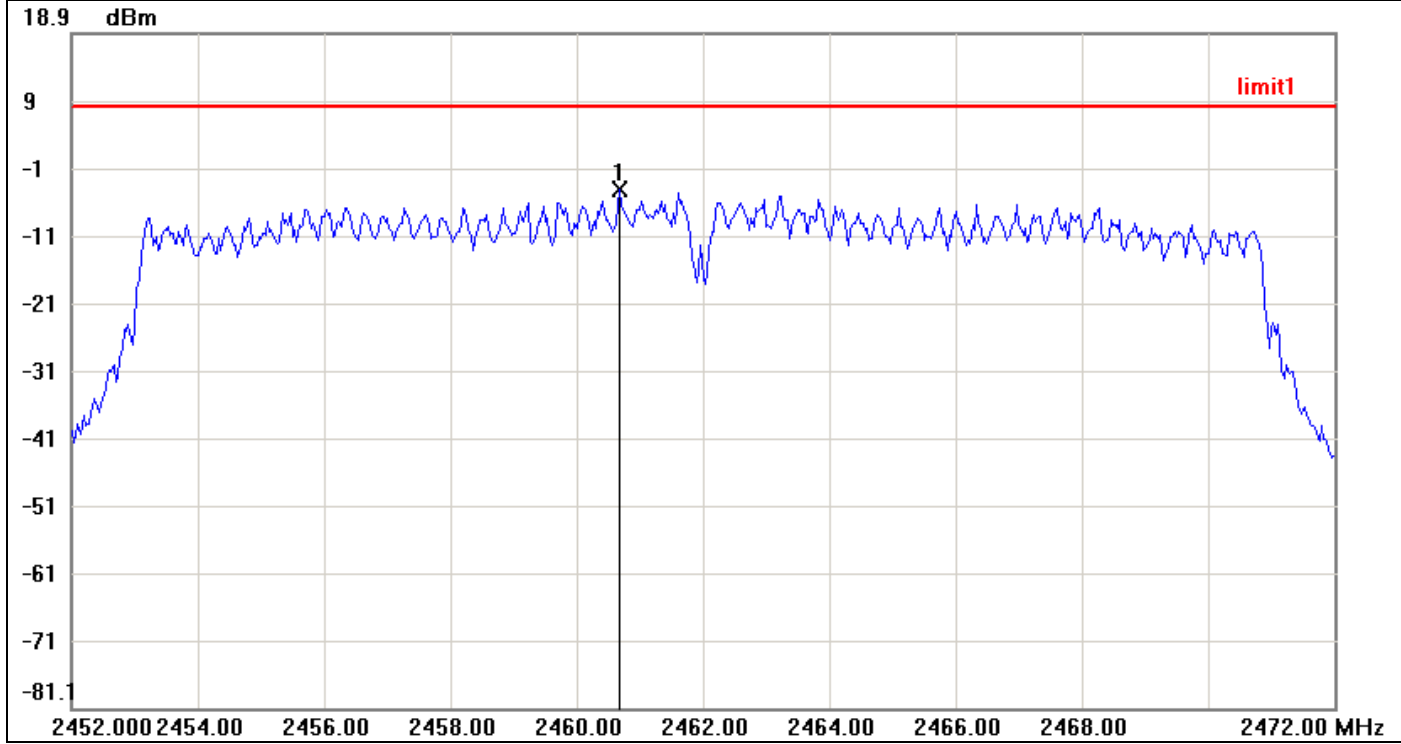

No.	Frequency(MHz)	Result(dBm)	Limit(dBm)	Margin(dBm)
1	2460.6667	-4.33	8.00	-12.33



8.7 SPURIOUS EMISSIONS

8.7.1 Conducted Measurement

LIMIT

According to §15.247(d) & RSS-210 §A8.5, in any 100 kHz bandwidth outside the frequency bands in which the spread spectrum intentional radiator is operating, the radio frequency power that is produced by the intentional radiator shall be at least 20 dB below that in the 100 kHz bandwidth within the band that contains the highest level of the desired power, based on either an RF conducted or a radiated measurement, provided the transmitter demonstrates compliance with the peak conducted power limits. In addition, radiated emissions which fall in the restricted bands, as defined in §15.205(a), must also comply with the radiated emission limits specified in 15.209(a) (see Section 15.205(c)).

Test Configuration

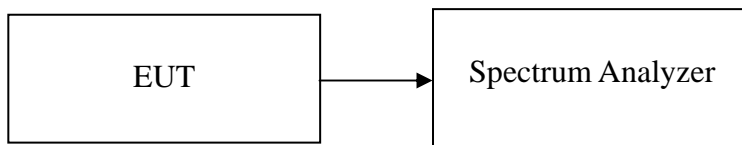

TEST PROCEDURE

Conducted RF measurements of the transmitter output were made to confirm that the EUT antenna port conducted emissions meet the specified limit and to identify any spurious signals that require further investigation or measurements on the radiated emissions site.

The transmitter output is connected to the spectrum analyzer. The resolution bandwidth is set to 100 kHz. The video bandwidth is set to 100 kHz.

Measurements are made over the 30MHz to 26GHz range with the transmitter set to the lowest, middle, and highest channels.

TEST RESULTS

No non-compliance noted



Test Plot

IEEE 802.11b mode

CH Low

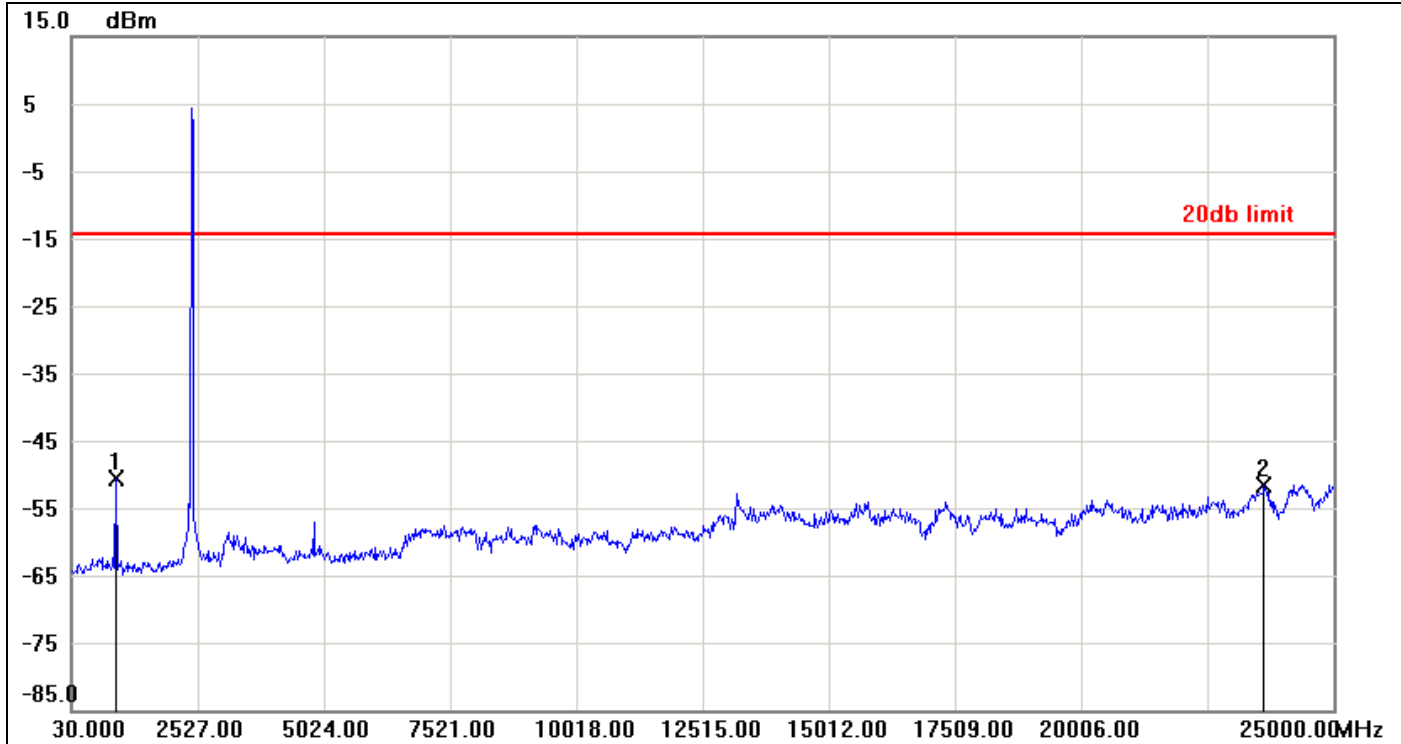

No.	Frequency(MHz)	Result(dBm)	Limit(dBm)	Margin(dBm)
1	903.9500	-50.75	-14.28	-36.47
2	23626.6500	-51.63	-14.28	-37.35



CH Mid

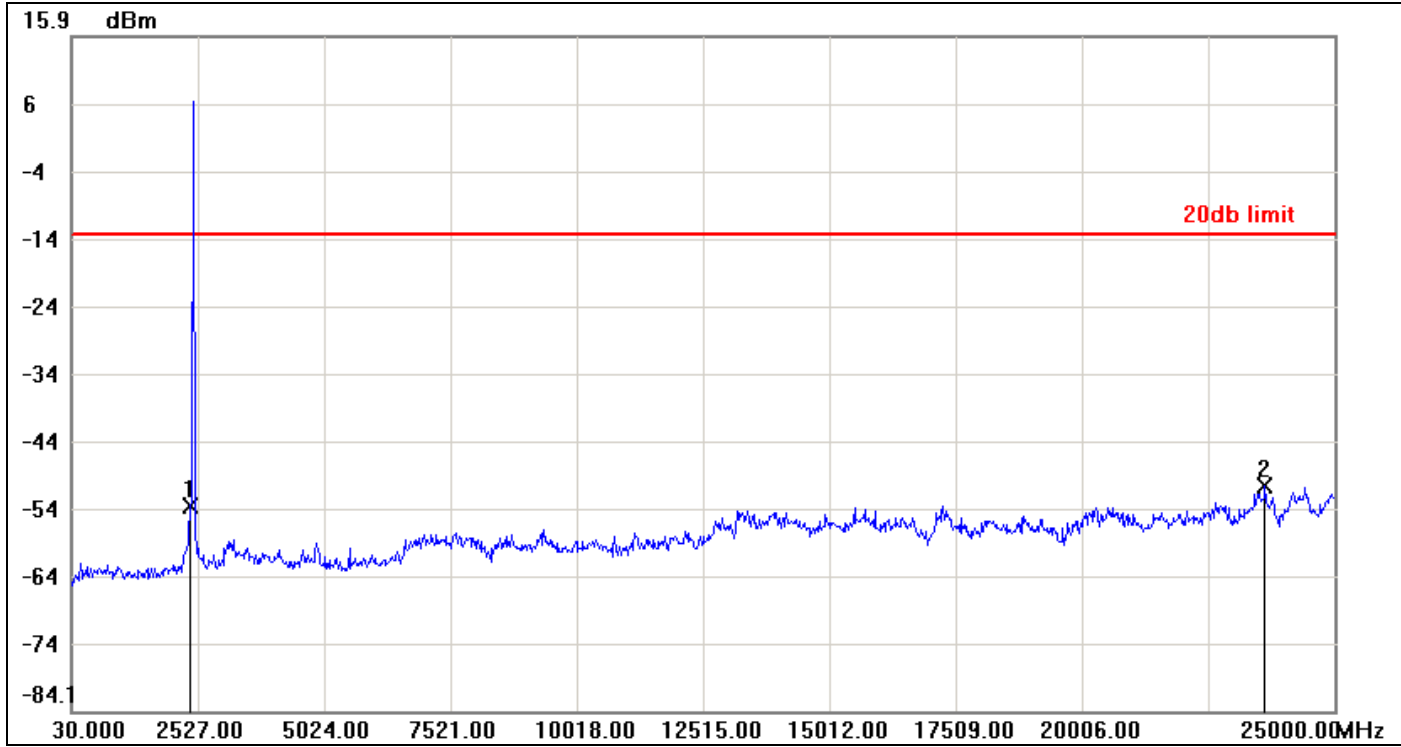

No.	Frequency(MHz)	Result(dBm)	Limit(dBm)	Margin(dBm)
1	2377.1800	-53.80	-13.50	-40.30
2	23626.6500	-50.76	-13.50	-37.26



CH High



No.	Frequency(MHz)	Result(dBm)	Limit(dBm)	Margin(dBm)
1	903.9500	-39.18	-12.88	-26.30
2	24400.7200	-51.10	-12.88	-38.22



IEEE 802.11g mode

CH Low

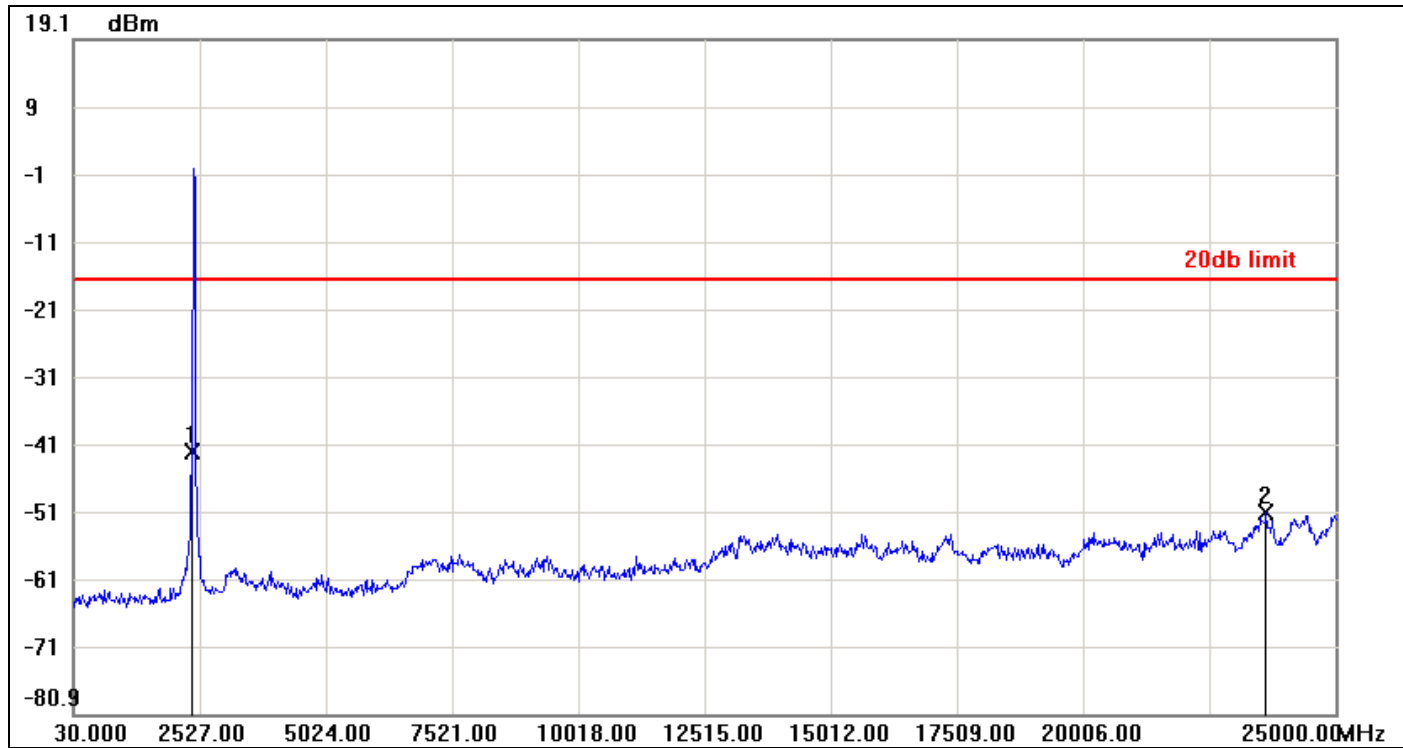

No.	Frequency(MHz)	Result(dBm)	Limit(dBm)	Margin(dBm)
1	2377.1800	-42.04	-16.58	-25.46
2	23626.6500	-51.12	-16.58	-34.54



CH Mid

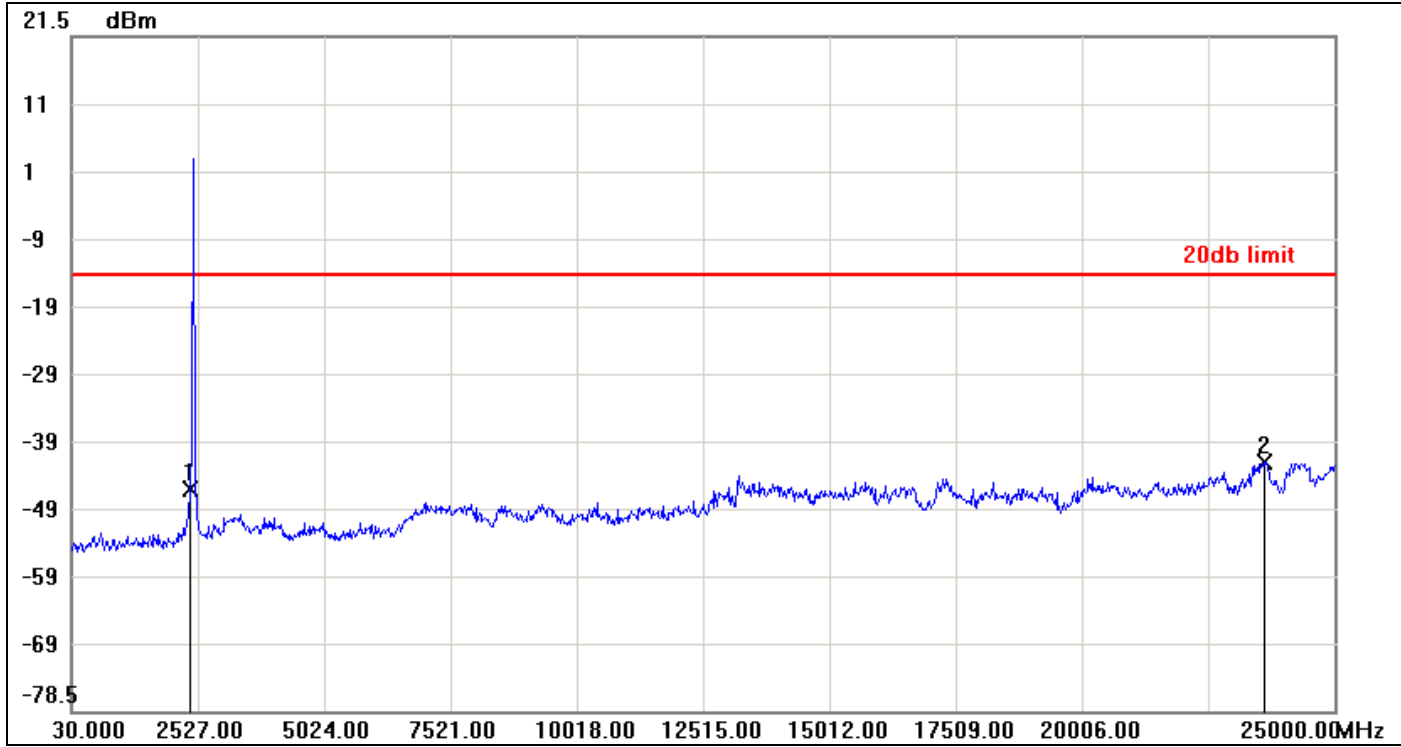

No.	Frequency(MHz)	Result(dBm)	Limit(dBm)	Margin(dBm)
1	2377.1800	-45.59	-13.92	-31.67
2	23601.6800	-41.58	-13.92	-27.66



CH High

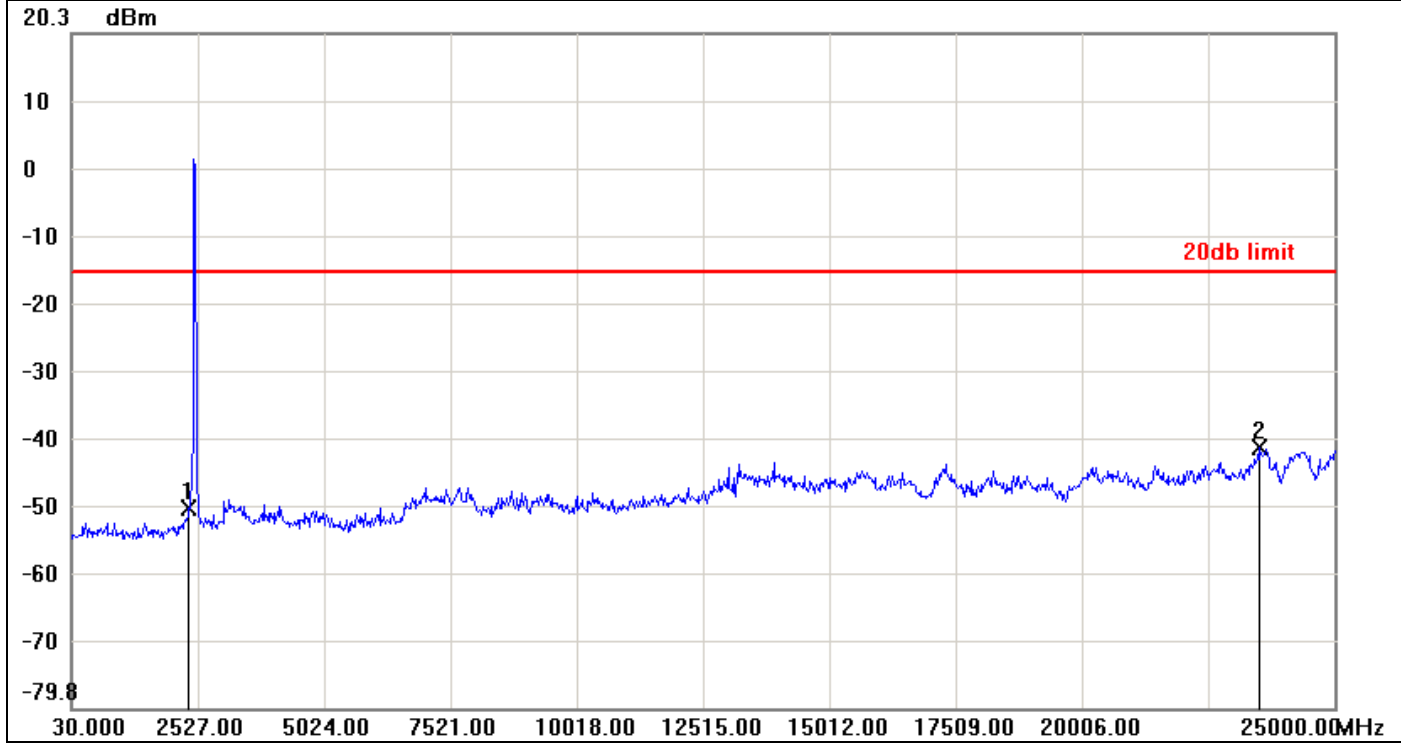

No.	Frequency(MHz)	Result(dBm)	Limit(dBm)	Margin(dBm)
1	2352.2100	-50.04	-15.20	-34.84
2	23501.8000	-41.17	-15.20	-25.97



IEEE 802.11n HT 20 MHz mode Channel mode

CH Low

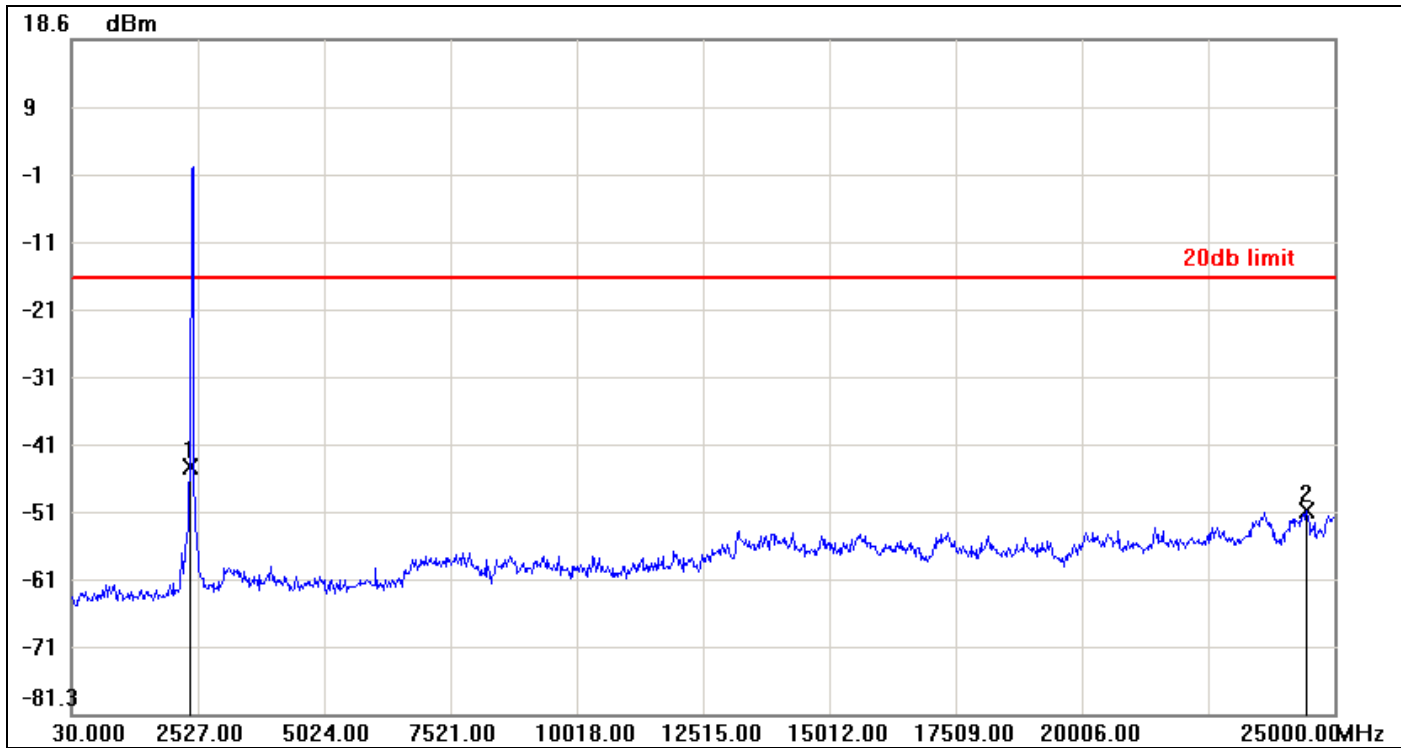

No.	Frequency(MHz)	Result(dBm)	Limit(dBm)	Margin(dBm)
1	2377.1800	-44.84	-16.75	-28.09
2	24450.6600	-51.29	-16.75	-34.54



CH Mid

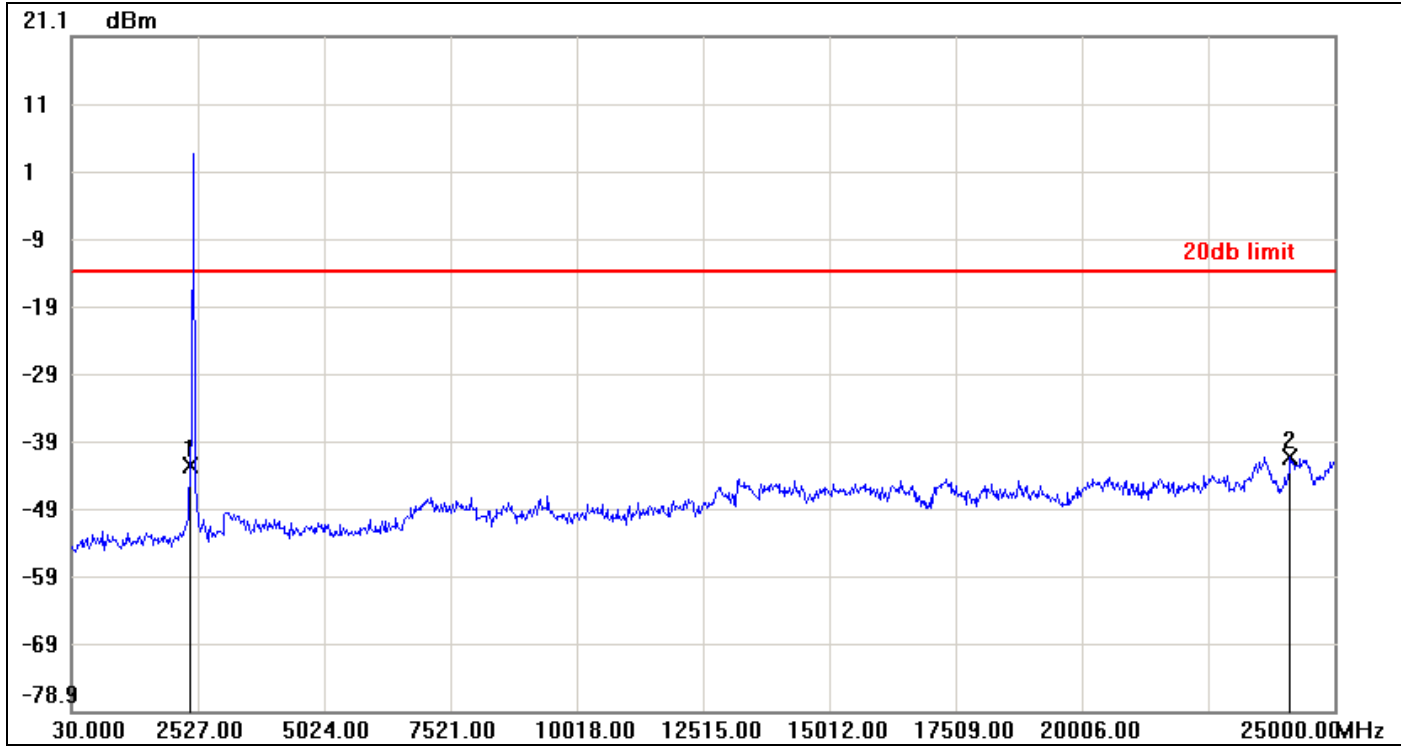

No.	Frequency(MHz)	Result(dBm)	Limit(dBm)	Margin(dBm)
1	2377.1800	-42.38	-13.67	-28.71
2	24126.0500	-41.14	-13.67	-27.47



CH High

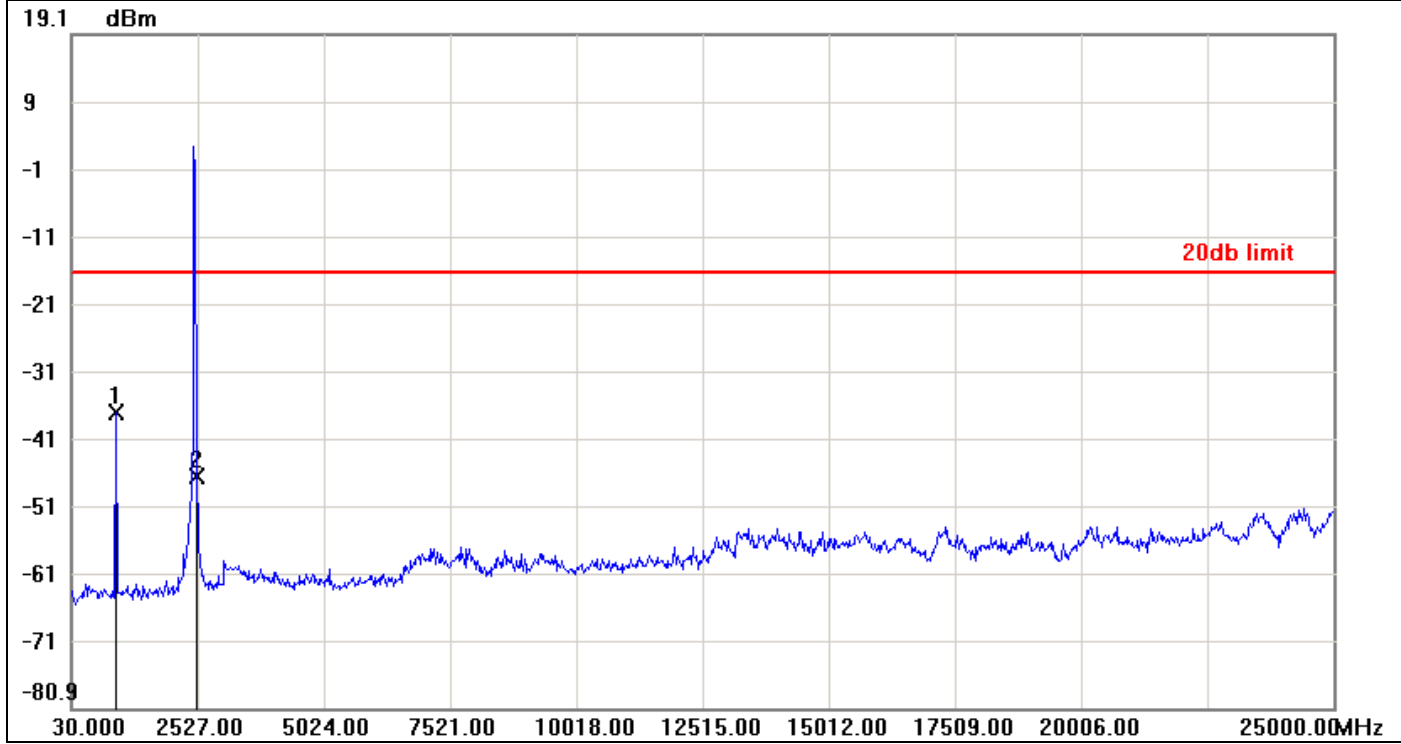

No.	Frequency(MHz)	Result(dBm)	Limit(dBm)	Margin(dBm)
1	903.9500	-37.10	-16.23	-20.87
2	2502.0300	-46.46	-16.23	-30.23



8.8 RADIATED EMISSIONS

LIMIT

All spurious emissions shall comply with the limits of §15.209(a) and RSS-Gen Table 2 & Table 5.

RSS-Gen Table 2 & Table 5: General Field Strength Limits for Transmitters and Receivers at Frequencies Above 30 MHz ^(Note)

Frequency (MHz)	Field Strength microvolts/m at 3 metres (watts, e.i.r.p.)	
	Transmitters	Receivers
30-88	100 (3 nW)	100 (3 nW)
88-216	150 (6.8 nW)	150 (6.8 nW)
216-960	200 (12 nW)	200 (12 nW)
Above 960	500 (75 nW)	500 (75 nW)

Note: *Measurements for compliance with limits in the above table may be performed at distances other than 3 metres, in accordance with Section 7.2.7.

Transmitting devices are not permitted in Table 1 bands or, unless stated otherwise, in TV bands (54-72 MHz, 76-88 MHz, 174-216 MHz, 470-608 MHz and 614-806 MHz).

RSS-Gen Table 6: General Field Strength Limits for Transmitters at Frequencies Below 30 MHz (Transmit)

Frequency	Field Strength (microvolts/m)	Magnetic H-Field (microamperes/m)	Measurement Distance (metres)
9-490 kHz	2,400/F (F in kHz)	2,400/377F (F in kHz)	3000
490-1,705 kHz	24,000/F (F in kHz)	24,000/377F (F in kHz)	30
1.705-30 MHz	30	N/A	30

Note: The emission limits for the bands 9-90 kHz and 110-490 kHz are based on measurements employing an average detector.



Test Configuration

9kHz ~ 30MHz

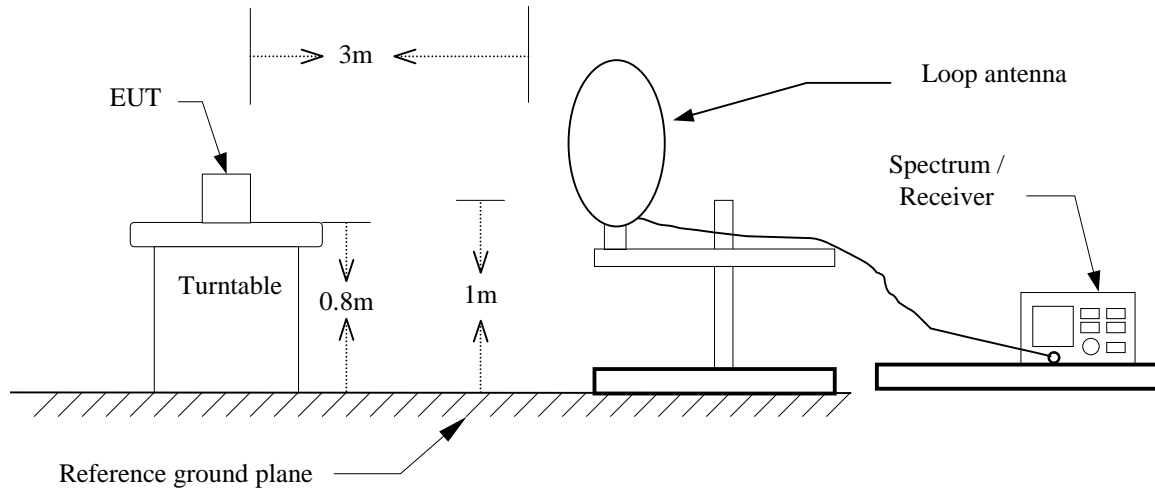

30MHz ~ 1GHz

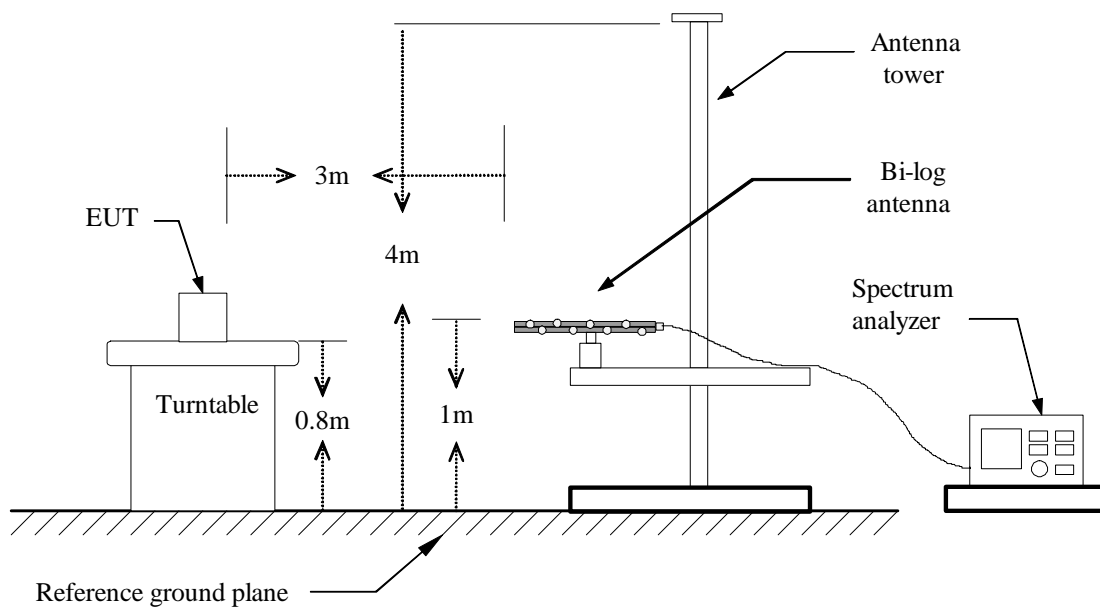



Above 1 GHz

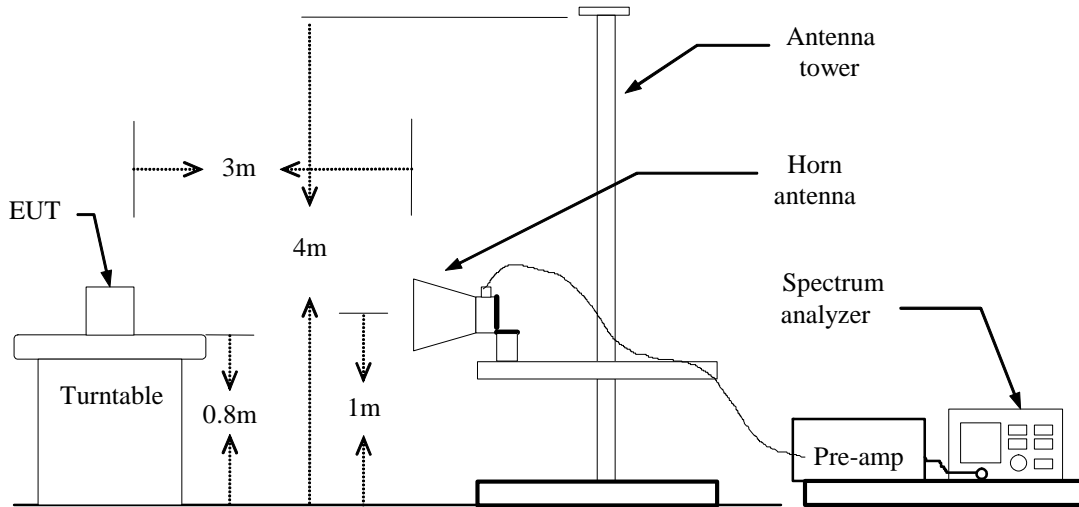



TEST PROCEDURE

1. The EUT is placed on a turntable, which is 0.8m above ground plane.
2. The turntable shall be rotated for 360 degrees to determine the position of maximum emission level.
3. EUT is set 3m away from the receiving antenna, which is varied from 1m to 4m to find out the highest emissions.
4. Maximum procedure was performed on the six highest emissions to ensure EUT compliance.
5. And also, each emission was to be maximized by changing the polarization of receiving antenna both horizontal and vertical.
6. Set the spectrum analyzer in the following setting as:
Below 1GHz:
RBW=100kHz / VBW=300kHz / Sweep=AUTO
Above 1GHz:
(a) PEAK: RBW=VBW=1MHz / Sweep=AUTO
(b) AVERAGE: RBW=1MHz / VBW=10Hz / Sweep=AUTO
7. Repeat above procedures until the measurements for all frequencies are complete.

**Below 1GHz****Operation Mode:** Normal Link**Test Date:** July 27, 2013**Temperature:** 27°C**Tested by:** Shawn Wu**Humidity:** 53% RH**Polarity:** Ver. / Hor.

Frequency (MHz)	Reading (dBuV)	Correction Factor (dB/m)	Result (dBuV/m)	Limit (dBuV/m)	Margin (dB)	Remark	Ant. Pol. (H/V)
31.6167	56.44	-21.64	34.80	40.00	-5.20	peak	V
93.0500	66.18	-33.41	32.77	43.50	-10.73	peak	V
146.4000	66.43	-28.82	37.61	43.50	-5.89	peak	V
190.0500	59.22	-29.51	29.71	43.50	-13.79	peak	V
233.7000	58.94	-29.92	29.02	46.00	-16.98	peak	V
799.5333	45.76	-19.04	26.72	46.00	-19.28	peak	V
148.0167	58.57	-28.88	29.69	43.50	-13.81	peak	H
183.5833	62.40	-30.06	32.34	43.50	-11.16	peak	H
282.2000	56.80	-28.01	28.79	46.00	-17.21	peak	H
369.5000	53.73	-26.16	27.57	46.00	-18.43	peak	H
458.4167	51.54	-24.08	27.46	46.00	-18.54	peak	H
791.4500	49.63	-19.12	30.51	46.00	-15.49	peak	H

Remark:

1. No emission found between lowest internal used/generated frequency to 30MHz (9kHz~30MHz)..
2. Radiated emissions measured in frequency range from 30 MHz to 1000MHz were made with an instrument using peak/quasi-peak detector mode.
3. Quasi-peak test would be performed if the peak result were greater than the quasi-peak limit or as required by the applicant.
4. Measurements above show only up to 6 maximum emissions noted, or would be lesser, with " N/A " remark, if no specific emissions from the EUT are recorded (ie: margin>20dB from the applicable limit) and considered that's already beyond the background noise floor.
5. Margin (dB) = Result (dBuV/m) – Limit (dBuV/m).



Above 1 GHz

Operation Mode: TX / IEEE 802.11b / CH Low

Test Date: July 27, 2013

Temperature: 27°C

Tested by: Shawn Wu

Humidity: 53 % RH

Polarity: Ver. / Hor.

Frequency (MHz)	Reading (dBuV)	Correction Factor (dB/m)	Result (dBuV/m)	Limit (dBuV/m)	Margin (dB)	Remark	Ant. Pol. (H/V)
2176.667	51.44	-1.09	50.35	74.00	-23.65	peak	V
4825.000	48.92	6.12	55.04	74.00	-18.96	peak	V
4825.000	47.83	6.12	53.95	54.00	-0.05	AVG	V
N/A							
2216.667	52.23	-1.01	51.22	74.00	-22.78	peak	H
4825.000	47.37	6.12	53.49	74.00	-20.51	peak	H
4825.000	46.16	6.12	52.28	54.00	-1.72	AVG	H
N/A							

Remark:

1. Measuring frequencies from 1 GHz to the 10th harmonic of highest fundamental frequency.
2. Radiated emissions measured in frequency above 1000MHz were made with an instrument using peak/average detector mode.
3. Average test would be performed if the peak result were greater than the average limit or as required by the applicant.
4. Data of measurement within this frequency range shown “ --- ” in the table above means the reading of emissions are attenuated more than 20dB below the permissible limits or the field strength is too small to be measured.
5. Measurements above show only up to 6 maximum emissions noted, or would be lesser; with “ N/A ” remark, if no specific emissions from the EUT are recorded (ie: margin>20dB from the applicable limit) and considered that's already beyond the background noise floor.
6. Margin (dB) = Remark result (dBuV/m) – Average limit (dBuV/m).



Operation Mode: TX / IEEE 802.11b / CH Mid

Test Date: July 27, 2013

Temperature: 27°C

Tested by: Shawn Wu

Humidity: 53 % RH

Polarity: Ver. / Hor.

Frequency (MHz)	Reading (dBuV)	Correction Factor (dB/m)	Result (dBuV/m)	Limit (dBuV/m)	Margin (dB)	Remark	Ant. Pol. (H/V)
2233.333	52.64	-0.98	51.66	74.00	-22.34	peak	V
4875.000	47.73	6.24	53.97	74.00	-20.03	peak	V
4875.000	47.33	6.24	53.57	54.00	-0.43	AVG	V
N/A							
2096.667	52.15	-1.24	50.91	74.00	-23.09	peak	H
4875.000	46.79	6.24	53.03	74.00	-20.97	peak	H
4875.000	44.72	6.24	50.96	54.00	-3.04	AVG	H
N/A							

Remark:

1. Measuring frequencies from 1 GHz to the 10th harmonic of highest fundamental frequency.
2. Radiated emissions measured in frequency above 1000MHz were made with an instrument using peak/average detector mode.
3. Average test would be performed if the peak result were greater than the average limit or as required by the applicant.
4. Data of measurement within this frequency range shown " --- " in the table above means the reading of emissions are attenuated more than 20dB below the permissible limits or the field strength is too small to be measured.
5. Measurements above show only up to 6 maximum emissions noted, or would be lesser, with " N/A " remark, if no specific emissions from the EUT are recorded (ie: margin > 20dB from the applicable limit) and considered that's already beyond the background noise floor.
6. Margin (dB) = Remark result (dBuV/m) – Average limit (dBuV/m).



Operation Mode: TX / IEEE 802.11b / CH High

Test Date: July 27, 2013

Temperature: 27°C

Tested by: Shawn Wu

Humidity: 53 % RH

Polarity: Ver. / Hor.

Frequency (MHz)	Reading (dBuV)	Correction Factor (dB/m)	Result (dBuV/m)	Limit (dBuV/m)	Margin (dB)	Remark	Ant. Pol. (H/V)
2270.000	52.83	-0.91	51.92	74.00	-22.08	peak	V
4925.000	47.58	6.37	53.95	74.00	-20.05	peak	V
4925.000	46.87	6.37	53.24	54.00	-0.76	AVG	V
N/A							
2256.667	52.16	-0.93	51.23	74.00	-22.77	peak	H
4925.000	45.13	6.37	51.50	74.00	-22.50	peak	H
N/A							

Remark:

1. Measuring frequencies from 1 GHz to the 10th harmonic of highest fundamental frequency.
2. Radiated emissions measured in frequency above 1000MHz were made with an instrument using peak/average detector mode.
3. Average test would be performed if the peak result were greater than the average limit or as required by the applicant.
4. Data of measurement within this frequency range shown " --- " in the table above means the reading of emissions are attenuated more than 20dB below the permissible limits or the field strength is too small to be measured.
5. Measurements above show only up to 6 maximum emissions noted, or would be lesser, with " N/A " remark, if no specific emissions from the EUT are recorded (ie: margin > 20dB from the applicable limit) and considered that's already beyond the background noise floor.
6. Margin (dB) = Remark result (dBuV/m) – Average limit (dBuV/m).



Operation Mode: TX / IEEE 802.11g / CH Low

Test Date: July 27, 2013

Temperature: 27°C

Tested by: Shawn Wu

Humidity: 53 % RH

Polarity: Ver. / Hor.

Frequency (MHz)	Reading (dBuV)	Correction Factor (dB/m)	Result (dBuV/m)	Limit (dBuV/m)	Margin (dB)	Remark	Ant. Pol. (H/V)
2190.000	51.95	-1.06	50.89	74.00	-23.11	peak	V
4825.000	48.43	6.12	54.55	74.00	-19.45	peak	V
4825.000	38.81	6.12	44.93	54.00	-9.07	AVG	V
N/A							
2206.667	52.23	-1.03	51.20	74.00	-22.80	peak	H
4816.667	45.87	6.10	51.97	74.00	-22.03	peak	H
N/A							

Remark:

1. Measuring frequencies from 1 GHz to the 10th harmonic of highest fundamental frequency.
2. Radiated emissions measured in frequency above 1000MHz were made with an instrument using peak/average detector mode.
3. Average test would be performed if the peak result were greater than the average limit or as required by the applicant.
4. Data of measurement within this frequency range shown " --- " in the table above means the reading of emissions are attenuated more than 20dB below the permissible limits or the field strength is too small to be measured.
5. Measurements above show only up to 6 maximum emissions noted, or would be lesser, with " N/A " remark, if no specific emissions from the EUT are recorded (ie: margin > 20dB from the applicable limit) and considered that's already beyond the background noise floor.
6. Margin (dB) = Remark result (dBuV/m) – Average limit (dBuV/m).



Operation Mode: TX / IEEE 802.11g / CH Mid

Test Date: July 27, 2013

Temperature: 27°C

Tested by: Shawn Wu

Humidity: 53 % RH

Polarity: Ver. / Hor.

Frequency (MHz)	Reading (dBuV)	Correction Factor (dB/m)	Result (dBuV/m)	Limit (dBuV/m)	Margin (dB)	Remark	Ant. Pol. (H/V)
2333.333	59.51	-0.73	58.78	74.00	-15.22	peak	V
2333.333	47.57	-0.73	46.84	54.00	-7.16	AVG	V
4875.000	47.89	6.24	54.13	74.00	-19.87	peak	V
4875.000	41.74	6.24	47.98	54.00	-6.02	AVG	V
N/A							
2386.667	63.52	-0.54	62.98	74.00	-11.02	peak	H
2386.667	51.51	-0.54	50.97	54.00	-3.03	AVG	H
2500.000	64.12	-0.10	64.02	74.00	-9.98	peak	H
2500.000	51.38	-0.10	51.28	54.00	-2.72	AVG	H
4875.000	46.56	6.24	52.80	74.00	-21.20	peak	H
4875.000	37.36	6.24	43.60	54.00	-10.40	AVG	H

Remark:

1. Measuring frequencies from 1 GHz to the 10th harmonic of highest fundamental frequency.
2. Radiated emissions measured in frequency above 1000MHz were made with an instrument using peak/average detector mode.
3. Average test would be performed if the peak result were greater than the average limit or as required by the applicant.
4. Data of measurement within this frequency range shown " --- " in the table above means the reading of emissions are attenuated more than 20dB below the permissible limits or the field strength is too small to be measured.
5. Measurements above show only up to 6 maximum emissions noted, or would be lesser, with " N/A " remark, if no specific emissions from the EUT are recorded (ie: margin > 20dB from the applicable limit) and considered that's already beyond the background noise floor.
6. Margin (dB) = Remark result (dBuV/m) – Average limit (dBuV/m).



Operation Mode: TX / IEEE 802.11g / CH High

Test Date: July 27, 2013

Temperature: 27°C

Tested by: Shawn Wu

Humidity: 53 % RH

Polarity: Ver. / Hor.

Frequency (MHz)	Reading (dBuV)	Correction Factor (dB/m)	Result (dBuV/m)	Limit (dBuV/m)	Margin (dB)	Remark	Ant. Pol. (H/V)
2373.333	57.94	-0.59	57.35	74.00	-16.65	peak	V
2373.333	46.07	-0.59	45.48	54.00	-8.52	AVG	V
2533.333	56.20	-0.01	56.19	74.00	-17.81	peak	V
2533.333	48.95	-0.01	48.94	54.00	-5.06	AVG	V
4925.000	46.56	6.37	52.93	74.00	-21.07	peak	V
4925.000	37.94	6.37	44.31	54.00	-9.69	AVG	V
2510.000	63.05	-0.07	62.98	74.00	-11.02	peak	H
2510.000	50.73	-0.07	50.66	54.00	-3.34	AVG	H
4916.667	44.52	6.35	50.87	74.00	-23.13	peak	H
N/A							

Remark:

1. Measuring frequencies from 1 GHz to the 10th harmonic of highest fundamental frequency.
2. Radiated emissions measured in frequency above 1000MHz were made with an instrument using peak/average detector mode.
3. Average test would be performed if the peak result were greater than the average limit or as required by the applicant.
4. Data of measurement within this frequency range shown " --- " in the table above means the reading of emissions are attenuated more than 20dB below the permissible limits or the field strength is too small to be measured.
5. Measurements above show only up to 6 maximum emissions noted, or would be lesser, with " N/A " remark, if no specific emissions from the EUT are recorded (ie: margin > 20dB from the applicable limit) and considered that's already beyond the background noise floor.
6. Margin (dB) = Remark result (dBuV/m) – Average limit (dBuV/m).



Operation Mode: TX / IEEE 802.11n HT 20 MHz mode Channel mode / CH Low

Test Date: July 27, 2013

Temperature: 27°C

Tested by: Shawn Wu

Humidity: 53 % RH

Polarity: Ver. / Hor.

Frequency (MHz)	Reading (dBuV)	Correction Factor (dB/m)	Result (dBuV/m)	Limit (dBuV/m)	Margin (dB)	Remark	Ant. Pol. (H/V)
2336.667	59.87	-0.72	59.15	74.00	-14.85	peak	V
2336.667	47.66	-0.72	46.94	54.00	-7.06	AVG	V
4825.000	45.88	6.12	52.00	74.00	-22.00	peak	V
4825.000	38.22	6.12	44.34	54.00	-9.66	AVG	V
N/A							
2323.333	55.75	-0.77	54.98	74.00	-19.02	peak	H
2323.333	45.40	-0.77	44.63	54.00	-9.37	AVG	H
4825.000	45.39	6.12	51.51	74.00	-22.49	peak	H
N/A							

Remark:

1. Measuring frequencies from 1 GHz to the 10th harmonic of highest fundamental frequency.
2. Radiated emissions measured in frequency above 1000MHz were made with an instrument using peak/average detector mode.
3. Average test would be performed if the peak result were greater than the average limit or as required by the applicant.
4. Data of measurement within this frequency range shown " --- " in the table above means the reading of emissions are attenuated more than 20dB below the permissible limits or the field strength is too small to be measured.
5. Measurements above show only up to 6 maximum emissions noted, or would be lesser, with " N/A " remark, if no specific emissions from the EUT are recorded (ie: margin > 20dB from the applicable limit) and considered that's already beyond the background noise floor.
6. Margin (dB) = Remark result (dBuV/m) – Average limit (dBuV/m).



Operation Mode: TX / IEEE 802.11n HT 20 MHz mode Channel mode / CH Mid

Test Date: July 27, 2013

Temperature: 27°C

Tested by: Shawn Wu

Humidity: 53 % RH

Polarity: Ver. / Hor.

Frequency (MHz)	Reading (dBuV)	Correction Factor (dB/m)	Result (dBuV/m)	Limit (dBuV/m)	Margin (dB)	Remark	Ant. Pol. (H/V)
2363.333	58.64	-0.62	58.02	74.00	-15.98	peak	V
2363.333	49.11	-0.62	48.49	54.00	-5.51	AVG	V
2493.333	59.25	-0.13	59.12	74.00	-14.88	peak	V
2493.333	51.11	-0.13	50.98	54.00	-3.02	AVG	V
4875.000	47.62	6.24	53.86	74.00	-20.14	peak	V
4875.000	38.50	6.24	44.74	54.00	-9.26	AVG	V
2380.000	60.72	-0.56	60.16	74.00	-13.84	peak	H
2380.000	49.05	-0.56	48.49	54.00	-5.51	AVG	H
4875.000	45.80	6.24	52.04	74.00	-21.96	peak	H
4875.000	38.05	6.24	44.29	54.00	-9.71	AVG	H
N/A							

Remark:

1. Measuring frequencies from 1 GHz to the 10th harmonic of highest fundamental frequency.
2. Radiated emissions measured in frequency above 1000MHz were made with an instrument using peak/average detector mode.
3. Average test would be performed if the peak result were greater than the average limit or as required by the applicant.
4. Data of measurement within this frequency range shown " --- " in the table above means the reading of emissions are attenuated more than 20dB below the permissible limits or the field strength is too small to be measured.
5. Measurements above show only up to 6 maximum emissions noted, or would be lesser, with " N/A " remark, if no specific emissions from the EUT are recorded (ie: margin > 20dB from the applicable limit) and considered that's already beyond the background noise floor.
6. Margin (dB) = Remark result (dBuV/m) – Average limit (dBuV/m).



Operation Mode: TX / IEEE 802.11n HT 20 MHz mode Channel mode / CH High

Test Date: July 27, 2013

Temperature: 27°C

Tested by: Shawn Wu

Humidity: 53 % RH

Polarity: Ver. / Hor.

Frequency (MHz)	Reading (dBuV)	Correction Factor (dB/m)	Result (dBuV/m)	Limit (dBuV/m)	Margin (dB)	Remark	Ant. Pol. (H/V)
2363.333	58.80	-0.62	58.18	74.00	-15.82	peak	V
2363.333	46.84	-0.62	46.22	54.00	-7.78	AVG	V
4925.000	44.32	6.37	50.69	74.00	-23.31	peak	V
N/A							
2383.333	55.77	-0.55	55.22	74.00	-18.78	peak	H
2383.333	46.65	-0.55	46.10	54.00	-7.90	AVG	H
2510.000	65.46	-0.07	65.39	74.00	-8.61	peak	H
2510.000	50.30	-0.07	50.23	54.00	-3.77	AVG	H
4916.667	43.73	6.35	50.08	74.00	-23.92	peak	H
N/A							

Remark:

1. Measuring frequencies from 1 GHz to the 10th harmonic of highest fundamental frequency.
2. Radiated emissions measured in frequency above 1000MHz were made with an instrument using peak/average detector mode.
3. Average test would be performed if the peak result were greater than the average limit or as required by the applicant.
4. Data of measurement within this frequency range shown " --- " in the table above means the reading of emissions are attenuated more than 20dB below the permissible limits or the field strength is too small to be measured.
5. Measurements above show only up to 6 maximum emissions noted, or would be lesser, with " N/A " remark, if no specific emissions from the EUT are recorded (ie: margin > 20dB from the applicable limit) and considered that's already beyond the background noise floor.
6. Margin (dB) = Remark result (dBuV/m) – Average limit (dBuV/m).



8.9 POWERLINE CONDUCTED EMISSIONS

LIMIT

According to §15.207(a) & RSS-Gen §7.2.4, except as shown in paragraphs (b) and (c) of this section, for an intentional radiator that is designed to be connected to the public utility (AC) power line, the radio frequency voltage that is conducted back onto the AC power line on any frequency or frequencies within the band 150 kHz to 30 MHz shall not exceed the limits in the following table, as measured using a 50 μ H/50 ohms line impedance stabilization network (LISN). Compliance with the provisions of this paragraph shall be based on the measurement of the radio frequency voltage between each power line and ground at the power terminal. The lower limit applies at the boundary between the frequency ranges.

Frequency Range (MHz)	Limits (dB μ V)	
	Quasi-peak	Average
0.15 to 0.50	66 to 56*	56 to 46*
0.50 to 5	56	46
5 to 30	60	50

* Decreases with the logarithm of the frequency.

Test Configuration

See test photographs attached in Appendix II for the actual connections between EUT and support equipment.

TEST PROCEDURE

1. The EUT was placed on a table, which is 0.8m above ground plane.
2. Maximum procedure was performed on the six highest emissions to ensure EUT compliance.
3. Repeat above procedures until all frequency measured were complete.



TEST RESULTS

The initial step in collecting conducted data is a spectrum analyzer peak scan of the measurement range. Significant peaks are then marked as shown on the following data page, and these signals are then quasi-peaked.

Test Data

Operation Mode: Normal Link **Test Date:** July 11, 2013
Temperature: 23°C **Tested by:** Leon Yu
Humidity: 57% RH

No.	Frequency (MHz)	Reading (dBuV)	Factor (dB)	Result (dBuV)	Limit (dBuV)	Margin (dB)	Detector	Note
1	0.1500	47.43	10.17	57.60	65.99	-8.39	peak	L1
2	0.1500	33.69	10.17	43.86	55.99	-12.13	AVG	L1
3	0.2020	42.24	10.06	52.30	63.52	-11.22	peak	L1
4	0.6580	37.80	9.98	47.78	56.00	-8.22	peak	L1
5	0.6580	25.56	9.98	35.54	46.00	-10.46	AVG	L1
6	2.5940	33.94	10.08	44.02	56.00	-11.98	peak	L1
7	3.1140	34.89	10.09	44.98	56.00	-11.02	peak	L1
8	11.4860	30.78	10.21	40.99	60.00	-19.01	peak	L1

No.	Frequency (MHz)	Reading (dBuV)	Factor (dB)	Result (dBuV)	Limit (dBuV)	Margin (dB)	Detector	Note
1	0.1500	45.76	10.09	55.85	65.99	-10.14	peak	L2
2	0.1660	44.32	10.06	54.38	65.15	-10.77	peak	L2
3	0.2500	35.02	9.98	45.00	61.75	-16.75	peak	L2
4	0.6580	36.07	9.95	46.02	56.00	-9.98	peak	L2
5	0.6580	22.67	9.95	32.62	46.00	-13.38	AVG	L2
6	3.2420	35.83	10.09	45.92	56.00	-10.08	peak	L2
7	12.7299	31.32	10.25	41.57	60.00	-18.43	peak	L2

Remark:

1. Measuring frequencies from 0.15 MHz to 30MHz.
2. The emissions measured in frequency range from 0.15 MHz to 30MHz were made with an instrument using Quasi-peak detector and average detector.
3. The IF bandwidth of SPA between 0.15MHz and 30MHz was 10 kHz; the IF bandwidth of Test Receiver between 0.15MHz and 30MHz was 9 kHz;
4. L1 = Line One (Live Line) / L2 = Line Two (Neutral Line)



Test Plots

Conducted emissions (Line 1)

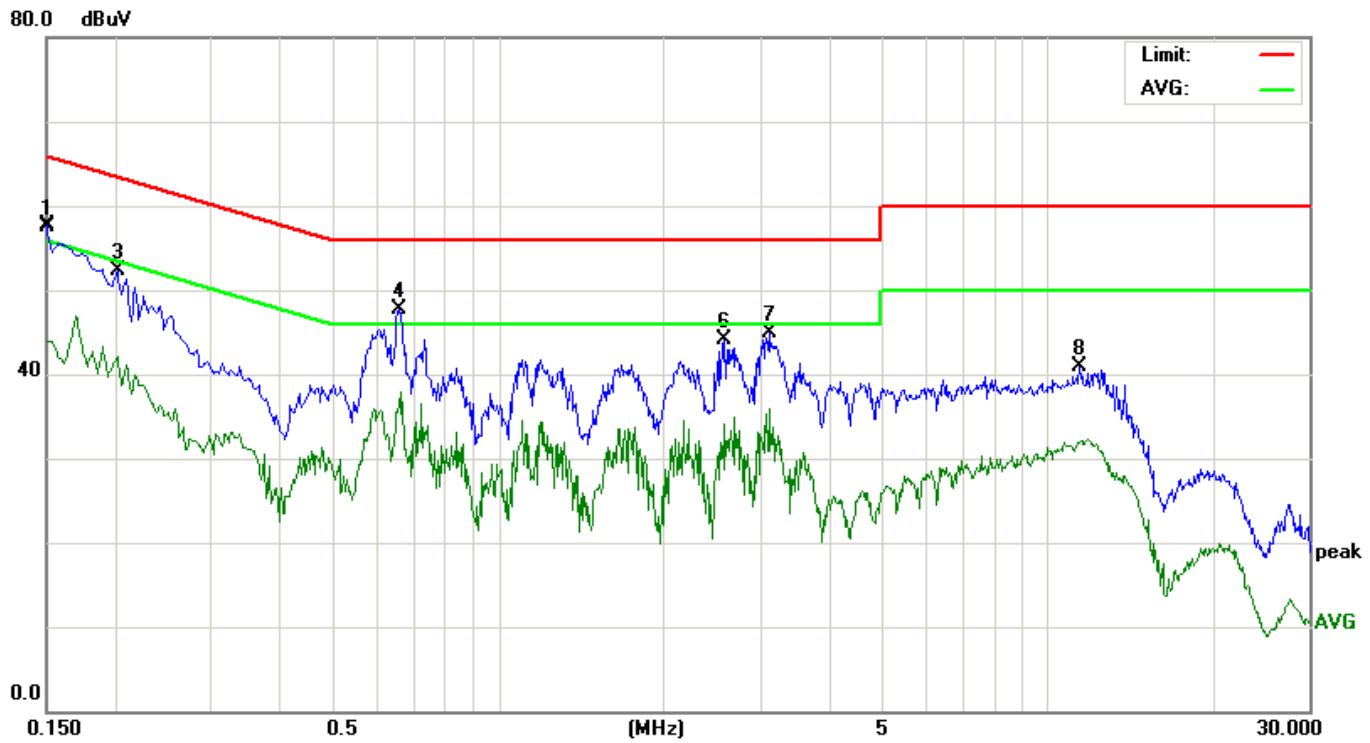

Conducted emissions (Line 2)

