

Hi!
Let's get started.

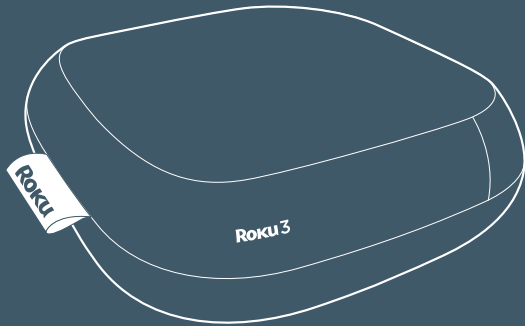

ROKU



What's in the **box**

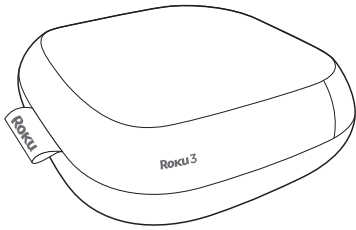

Roku player

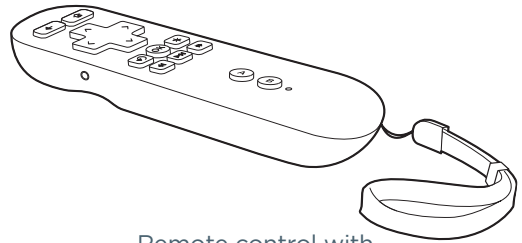

Remote control with
in-ear headphone jack

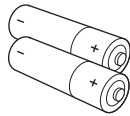

2 x AA Alkaline
batteries

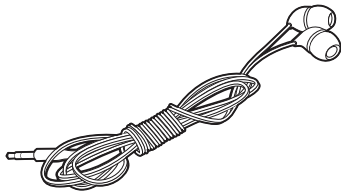

In-ear headphones

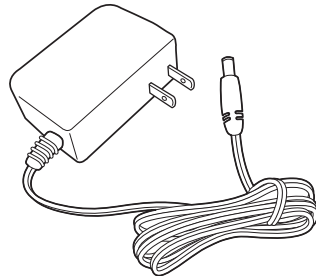

Power adapter

Get to know your Roku

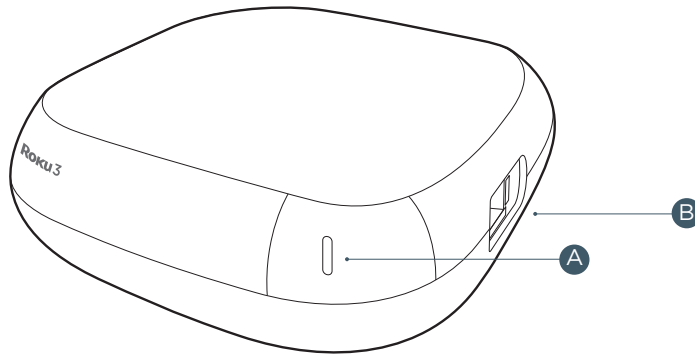

Front view

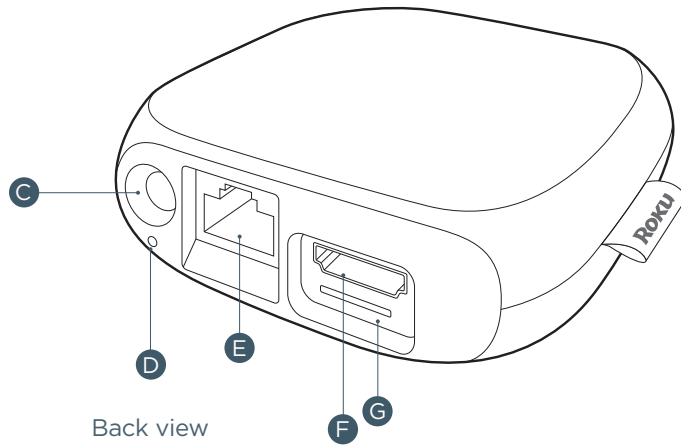

Back view

- A** Status light – Flashes slowly when the Roku player starts up. Glows when it's on. Flashes once with each press of the remote control.
- B** USB port – Plays your home videos, movies, music and photos from supported USB drives. For supported file types, visit roku.com/usb.
- C** Power port – Connects your Roku player to a 120V AC power source with the included power adapter.
- D** Reset button – Resets your Roku player to its original factory settings when pressed and held for 10 seconds (a feature you'll rarely, if ever, use).
- E** Ethernet port – Connects your Roku player to a wired network with an Ethernet cable (not included).
- F** HDMI port – Connects your Roku player to an HDTV with an HDMI cable (not included).
- G** Storage expansion slot – Lets you increase your storage capacity for Roku channels and games with a microSD card (optional, not included).

Did you notice? Your Roku player has no on/off switch. It's simpler that way and draws very little power—less than a nightlight! Keep it plugged in so that it can download the latest software updates automatically.

What you **need**

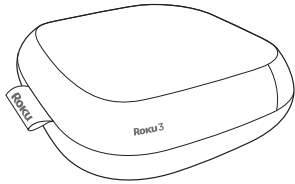

Roku player

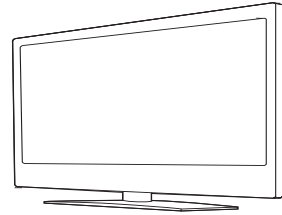

HDTV

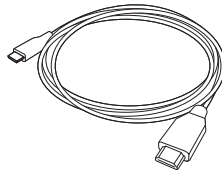

HDMI cable
(sold separately)

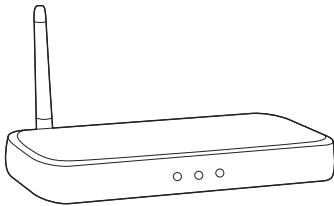

Router

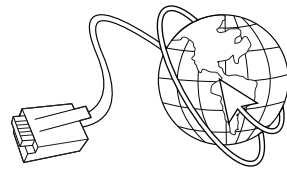

High-speed Internet connection
(DSL or cable modem)

Pssst! Your router can be wireless (any Wi-Fi) or wired. For wired networks, you'll also need an Ethernet cable (not included).

What to do **Step 1**

Ready for the step-by-step? We've only got four...

Connect your player

Use an HDMI cable (not included) to make the connection depicted in the diagram below:

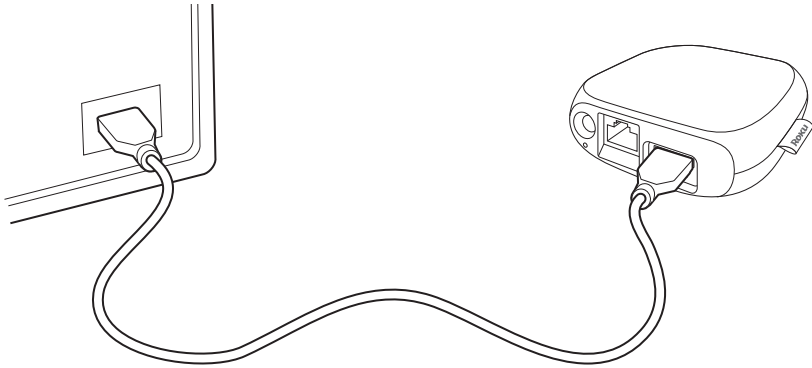

- Connect one end to the HDMI port on the back of your Roku player.
- Connect the other end to an open HDMI port on your TV.

Did you know? Because HDMI outputs digital video and audio, you don't need a separate audio cable. HDMI also supports up to 7.1 surround sound (where available). **Got a receiver?** You can also use HDMI to route video and audio directly through your receiver if it supports HDMI video pass-through.

What to do **Step 2**

Power up key components

In this step, we'll make sure all systems are GO!

First, power your Roku remote by inserting the included batteries:

- Turn the remote control over and locate the rectangular battery door on the rear of the unit.
- Press the latch at the top of the battery door down while simultaneously removing the battery door.
- Insert the batteries into their slots, making sure to match the positive (+) and negative (-) signs.
- Place the battery door back over the compartment and press it gently down until the latch snaps securely into place.

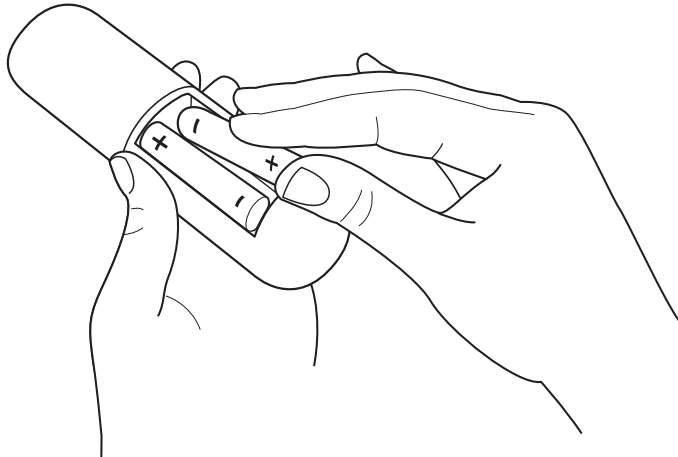

What to do **Step 2** (continued)

Next, power on your Roku player by connecting it to a wall outlet using the included power adapter, like this:

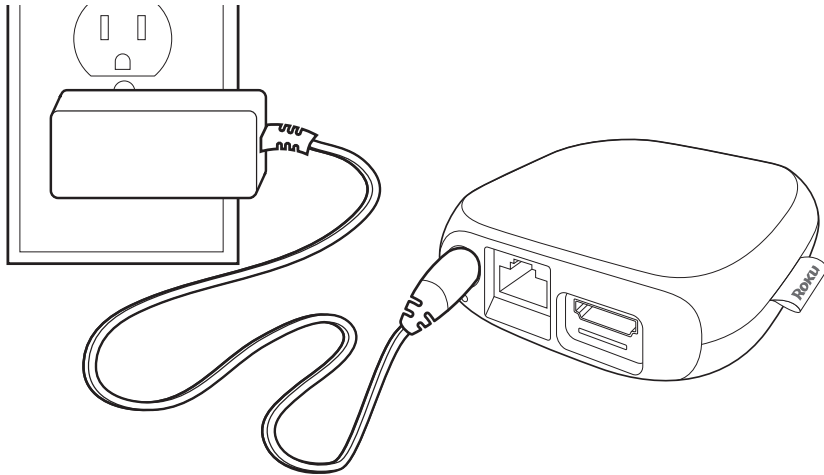

Finally, power on your TV and look for a Roku message to fill the screen.

Blank screen? If your TV does not display a Roku screen, make sure your TV input matches the physical connection used to connect your Roku player. Press the Input button (sometimes called Source) on your TV or TV remote to cycle through the various video inputs available until you see a Roku screen.

What to do **Step 3**

Configure your network

Step 3 establishes your network connection and brings out your inner geek. You can do it! Just choose either wireless or wired and read on for instructions:

Wireless: If you use a wireless network, you can grab that Roku remote and jump right into Guided Setup. When prompted, select “Wireless” as your network connection and have your network name and password ready. Then:

- Select your network from the list of available networks.
- Enter your network password, if you use one. Remember, network passwords are case sensitive.

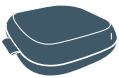

Dos and don'ts on where to place your Roku player:

- DO place your player within range of your wireless network.
- DON'T place your player in an enclosed cabinet; it may interfere with the wireless signal.
- DON'T place your player beneath anything; it may cause the player to overheat. Eeeeks.

What to do **Step 3** (continued)

Wired: If you use a wired network, this step is a snap. Simply make the two connections depicted in the diagram below, and then use your Roku remote to select “Wired” from the on-screen network options.

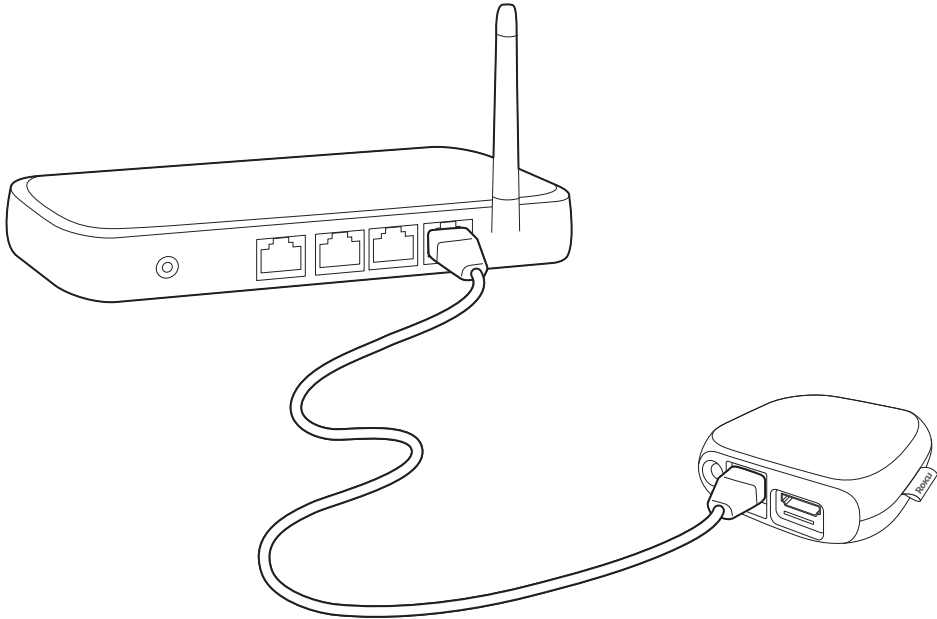

- Connect one end to the Ethernet port on the back of your Roku player.
- Connect the other end to an open Ethernet port on your router.

What to do **Step 4**

Complete Guided Setup

It's the final stretch and hooray—it's a breeze! Continue following the on-screen instructions and you'll:

- Get the latest software.
- Select the video output resolution.
- Link the Roku player to your Roku account on your computer.

And setup is done...congratulations! Continue using that Roku remote, which you can learn more about on the following pages, to personalize your channel line-up, stream movies or play games. The fun part has just begun, we promise.



Your Roku account: During Guided Setup, you'll be prompted to create your Roku account online at roku.com/link. Your Roku player will generate a unique code that links your player to your new account. Roku accounts are free and secure. And while a valid credit card number is required to create your account, rest assured you will only be charged if you authorize purchases of apps and games from the Roku Channel Store.

Get to **know your remote!**

First a couple of fun-facts about your Roku enhanced remote.

- It can hush your TV. When you plug headphones into the headphone jack, the TV is automatically muted. Use the Volume UP and DOWN buttons on the side of your remote to control the volume of your headphones to your liking.
- It's sensitive and smart. The Roku 3 remote incorporates motion-sensing technology, allowing more precise and detailed control of gameplay.
- It comes with an adjustable wrist strap—for good reason. Since some games make you sweat, sporting the wrist strap is a very good idea. You don't want to crack the screen of your beautiful TV—or harm anyone or anything around you.

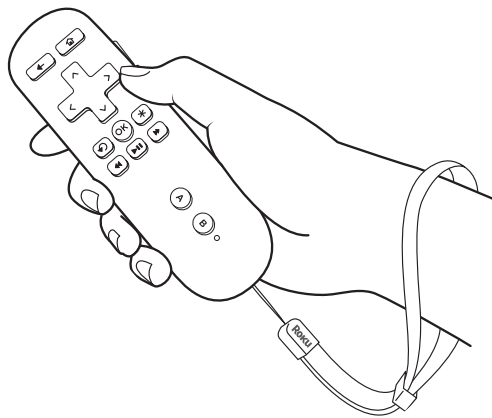

Buckle up: Open the lever on the strap lock and place your hand through the wrist strap. Hold the remote firmly in your hand. Slide the strap lock up so that the strap will not fall off your wrist. Do not over-tighten the strap lock so that it's uncomfortable. It should just be tight enough to hold the wrist strap in place. Close the lever to hold the strap lock in place.

Get to **know your remote!** (continued)

The Roku remote should feel right at home in your hand. We designed it to be incredibly intuitive for watching TV and great for gaming, too! Plus, this one includes a headphone jack for the included in-ear headphones!

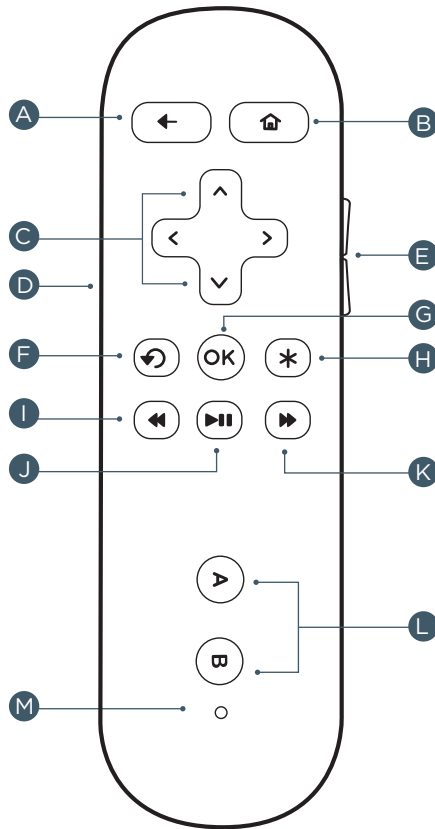

- A **[BACK]** Return to previous screen
- B **[HOME]** Return to Roku home screen
- C **[UP]** or **[DOWN]** Move up or down; **[LEFT]** or **[RIGHT]** Move left or right
- D **[IN-EAR HEADPHONES JACK]** Plug in your in-ear headphones here
- E **[VOLUME +/-]** Increase/Decrease the volume of your headphones
- F **[INSTANT REPLAY]** Replay last 7 seconds of video
- G **[OK]** Select an option from a menu
- H **[OPTIONS]** View more options
- I **[REV SCAN]** Rewind, scroll left one page at a time
- J **[PLAY/PAUSE]** Start or pause playback
- K **[FWD SCAN]** Fast forward, scroll right one page at a time
- L **[A & B]** Action buttons for gaming
- M **[STATUS LED]** Displays remote usage information

Cool: Because your enhanced remote uses radio frequency instead of infrared, you don't need to have a direct line of sight to your Roku player!

Get your **free Roku app!**

Got a smart phone or tablet? With the free Roku app, you can turn your iOS or Android device into a control center for your Roku streaming player. Launch channels, use your phone as a remote and find new channels to watch. Plus, you can even stream music and photos saved on your device right to your TV!

Additional features include:

- Launch or rate any channel with a tap of your finger.
- Use a simple touch and swipe based remote control. Includes instant replay, back and options buttons.
- Easily browse hundreds of channels in the Roku Channel Store.
- Quickly add and remove channels to/from your Roku player.
- Control and switch between multiple Roku players.



iOS



Android

Troubleshooting

Having trouble completing Guided Setup? Don't worry: It's usually an easy fix.

If you cannot see a picture on your TV:

- Make sure your TV is turned on. (This tip could save you some embarrassment.)
- Make sure the connectors on the cables between your Roku player and your TV or home theater receiver are pushed in all the way.
- Make sure the video input on your TV or home theater receiver is set to match the output (usually HDMI or composite video) used with the Roku player. Most TVs have an Input button on the remote control to change video inputs.
- Make sure the power cable for the Roku player is connected snugly to the Roku player on one end and to a working power source on the other end. If the Roku player is powered, the status light on the front of the unit will be on.
- If you are using HDMI with a home theater receiver, make sure the HDMI cable from your Roku player is connected to an HDMI-in port on your receiver and the HDMI cable from an HDMI-out port on your receiver is connected to your TV.

If you cannot connect to your wireless home network during guided setup:

- If you are not getting 3 or more signal-strength bars above your wireless network, adjust the location of your Roku player and/or wireless router. (See tips on DOs and DON'Ts regarding Roku placement in Step 3.)
- Make sure there are no obstructions, like cement walls, between your Roku player and your wireless router.
- Make sure you select "Wireless" and not "Wired" on the "Network connection selection" screen.

Troubleshooting (continued)

- Make sure you select the correct wireless router name on the “Choose wireless network” screen.
- Make sure you input the correct password, if your network is security-enabled (password is case sensitive).
- If you have turned off SSID broadcasting on your wireless router, you can add your network by selecting “My network is not shown” from the “Select wireless network” screen.

If you can't hear sound:

- Make sure the connectors on the cables between your Roku player and your TV or home theater receiver are pushed in all the way.
- Make sure the volume on your TV or home theater receiver is turned up and isn't on mute.
- If you connected your Roku player to a home theater receiver, make sure you receiver is turned on.
- Make sure the input on your TV or home theater receiver matches the output (HDMI or analog audio) used with your Roku player.

If the Roku remote control isn't functioning:

- Try moving closer to your Roku player.
- Make sure the batteries are working and inserted properly (see Step 2).
- Make sure your remote is paired (see next section) with the Roku player.
- If the status light on the front of your Roku player flashes once each time you press a remote button, the problem is not with the remote.

Pairing your remote control:

The Roku remote should automatically pair with your Roku player at the beginning of Guided Setup. If you are not able to use the remote to navigate through Guided Setup, you can manually pair the Roku remote by following these steps:

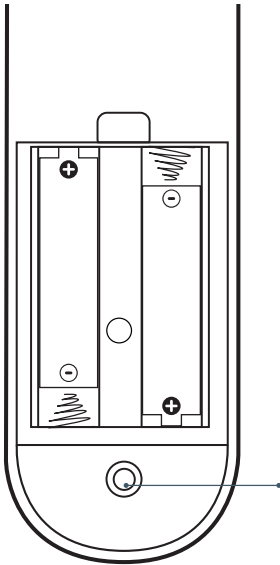

- 1 Prepare your Roku player to pair by unplugging the power adapter and plugging it back in.
 - 2 Open the Roku remote battery compartment using the instructions in Step 2.
 - 3 Place the Roku remote in close proximity with your Roku player.
 - 4 Press and hold the pairing button inside the battery compartment for 3 seconds.
 - 5 Wait about 10 seconds for the remote LED to stop flashing.
 - 6 Try using the Roku remote again.
- Pairing button
(in battery compartment)

If you couldn't find what you need:

Visit roku.com/support for more help.

Need more **help?**

roku.com/support

Get the most out of your Roku player.

Check out our FAQs, instructional videos and user forums.

Roku[®]



© 2009-2012 by Roku, Inc. All rights reserved. Roku and the Roku logo are registered trademarks of Roku, Inc. Other brand and product names are trademarks or registered trademarks of their respective holders.



Roku Player

Important Product Information

The License Agreement

The Roku and third-party software license terms can be found at: www.roku.com/license. Use of the Roku player constitutes acceptance of as well as agreement to those license terms.

Ninety (90) Day Limited Hardware Warranty

Subject to the additional terms and conditions set forth below, Roku provides this Limited Warranty:

- Only to the person or entity that originally purchased the Player from Roku or from one of its authorized resellers or distributors;
- and
- Only for Players purchased and delivered to the end user within the United States and Canada.

Limited Warranty

Roku warrants the Roku Player (“**Player**”) hardware against defects in materials and workmanship under normal use for a period of ninety (90) days from the date of purchase (“**Warranty Period**”). If Roku determines that the Player’s hardware is defective, Roku will either repair the unit or replace the unit with either a new or rebuilt Player, at its option. If the Warranty Period has expired or is otherwise not applicable (see **Scope and Limitation on Warranty** below), we will return the Player to you. More information about this warranty can be found at www.roku.com/support. THE FOREGOING SETS FORTH ROKU’S SOLE OBLIGATION AND YOUR EXCLUSIVE REMEDY IN THE EVENT OF ANY BREACH OF THIS LIMITED WARRANTY.

Return and Warranty Service Process

Please access and review the online help resources at www.roku.com/support before seeking warranty service. To return or obtain warranty service for a Player, you must first obtain a Return Merchandise Authorization (RMA) number from a Customer Support Representative (CSR) at Roku. Customer Support contact information can be found by visiting www.roku.com/support. RMA numbers expire thirty days from issuance. Roku may attempt to troubleshoot a warranty-related problem prior to issuing a RMA number. Please be prepared to provide additional information upon request. Once a RMA number is obtained, you must ship your Player, freight prepaid, together with proof of purchase and all accessories, in either the original packaging or packaging affording an equal degree of protection, to the Roku authorized distribution facility identified by the CSR. Failure to return any of the accessories could result in a delay and/or result in an invoice to you or credit to Roku for the missing accessories.

Important: When emailing for a RMA number, please provide the following information with your request: (a) model number, (b) serial number, (c) problem description, (d) software version (located in the System Configuration menu), (e) date of purchase, (f) place of purchase (reseller or online place of purchase), and (g) return shipping address (P.O. boxes are not accepted).

Scope of and Limitation on Warranty

The warranty on the Player is limited to the repair or replacement of defective units as described in the **Limited Warranty** section above. This warranty does not cover customer training or education, installation, set up adjustments, or signal reception problems. This warranty also does not cover any issue related to the service provided by your Service Provider, including but not limited to service disruption, changes in service terms, changes in offerings, changes in format, or technical problems. This warranty does not cover damage due to acts of God, accident, misuse, abuse, negligence, commercial use or modification of, or to any part of, your Player. This warranty does not cover damage due to improper operation or maintenance, connection to improper voltage supply or attempted repair by anyone other than a facility authorized by Roku to service your Player. This warranty does not cover consumables (such as fuses and batteries).

Legal Notices

Federal Communication Commission Interference Statement

This equipment has been tested and found to comply with the limits for a Class B digital device, pursuant to Part 15 of the FCC Rules. These limits are designed to provide reasonable protection against harmful interference in a residential installation. This equipment generates, uses and can radiate radio frequency energy and, if not installed and used in accordance with the instructions, may cause harmful interference to radio communications. However, there is no guarantee that interference will not occur in a particular installation. If this equipment does cause harmful interference to radio or television reception, which can be determined by turning the equipment off and on, the user is encouraged to try to correct the interference by one of the following measures:

- Reorient or relocate the receiving antenna.
- Increase the separation between the equipment and receiver.
- Connect the equipment into an outlet on a circuit different from that to which the receiver is connected.
- Consult the dealer or an experienced radio/TV technician for help.

This device complies with Part 15 of the FCC Rules. Operation is subject to the following two conditions: (1) This device may not cause harmful interference, and (2) this device must accept any interference received, including interference that may cause undesired operation.

FCC Caution: Any changes or modifications not expressly approved by the party responsible for compliance could void the user's authority to operate this equipment.

IEEE 802.11b or 802.11g operation of this product in the U.S.A. is firmware-limited to channels 1 through 11.

Wireless Radio Use:

This device is restricted to indoor use when operating in the 5.15 to 5.25 GHz frequency band.

IMPORTANT NOTE:

FCC Radiation Exposure Statement:

This equipment complies with FCC radiation exposure limits set forth for an uncontrolled environment. This equipment should be installed and operated with minimum distance 20cm between the radiator and your body.

This transmitter must not be co-located or operating in conjunction with any other antenna or transmitter.

Note to US model owner:

To comply with US FCC regulation, the country selection function has been completely removed from all US models.

The availability of some specific channels and/or operational frequency bands are country dependent and are firmware programmed at the factory to match the intended destination. The firmware setting is not accessible by the end user.

Industry Canada statement

This device complies with RSS-210 of the Industry Canada Rules. Operation is subject to the following two conditions: (1) this device may not cause harmful interference, and (2) this device must accept any interference received, including interference that may cause undesired operation.

French translation:

Ce dispositif est conforme à la norme CNR-210 d'Industrie Canada applicable aux appareils radio exempts de licence. Son fonctionnement est sujet aux deux conditions suivantes: (1) le dispositif ne doit pas produire de brouillage préjudiciable, et (2) ce dispositif doit accepter tout brouillage reçu, y compris un brouillage susceptible de provoquer un fonctionnement indésirable.

Safety Precautions

This product has been designed with the highest concern for safety. However, any electrical device, if used improperly, has the potential for causing fire, electrical shock or personal injury. To help ensure accident-free operation, follow these guidelines:

- Observe all warnings, precautions and instructions.
- Regularly inspect the AC power adapter for damage.
- Stop use, unplug the AC power adapter from the electrical outlet and disconnect any other cables immediately if the Player functions in an abnormal manner, produces unusual sounds or smells or becomes too hot to touch.
- For more information on product safety and troubleshooting, please go to www.roku.com/support.

CAUTION:

Risk of explosion if battery is replaced by an incorrect type. Dispose of used batteries according to the instructions

Use and Handling

- When playing video games, use in a well-lit area and stand or sit as far away from the television screen as possible.
- Take a 10-15 minute break every hour if playing video games and avoid prolonged use of the remote.
- Stop using the Player immediately if you begin to feel tired or if you experience discomfort or pain in your hands or arms while operating the wireless remote; if the condition persists, consult a doctor.
- If you experience any of the following health problems, discontinue use of the Player immediately:
 - Dizziness, nausea, fatigue or symptoms similar to motion sickness.
 - Discomfort or pain in a part of the body, such as eyes, ears, hands, or arms.

If symptoms persist, consult your physician.

- Keep the Player and accessories, including cable ties and fasteners, out of the reach of small children.
- Do not touch the Player or connected cables during an electrical storm.
- Do not allow liquid, small particles or other foreign objects to get into the Player or accessories.
- Do not expose the Player to smoke or steam.
- Do not expose the Player or accessories to high temperatures, high humidity or direct sunlight.
- Do not place the Player or the remote on the floor or in a place where they may cause someone to trip or stumble.

www.roku.com

