

## MC 9060<sup>ex</sup>-K

### Quick Start Guide

See Product Reference Guide for more information

POST IN WORK AREA

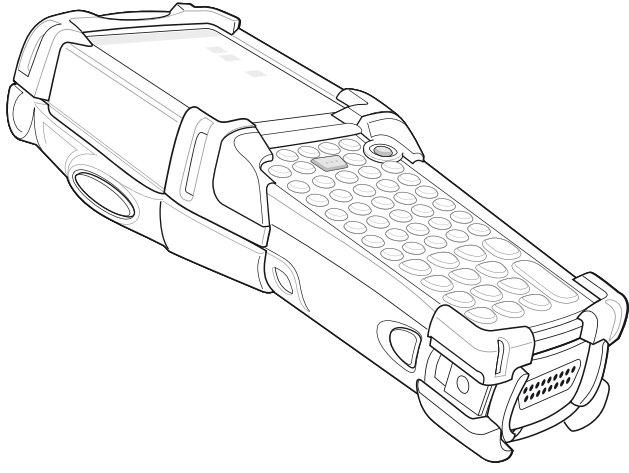

### Battery Insertion

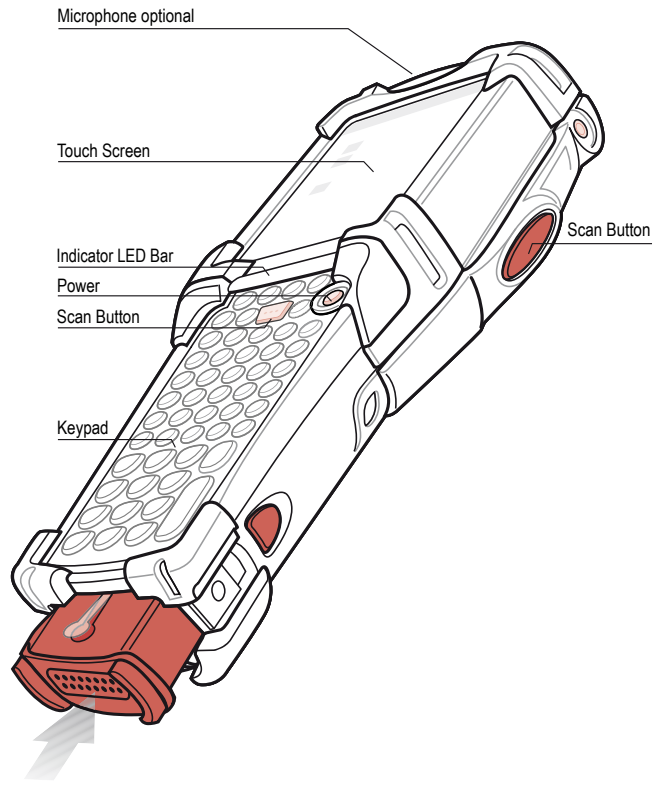

Use only I-Safe Battery, type 17-A1Z0-0002

### Battery Removal

It is allowed to replace the battery in hazardous areas.



To charge the battery in hazardous areas is strictly prohibited.

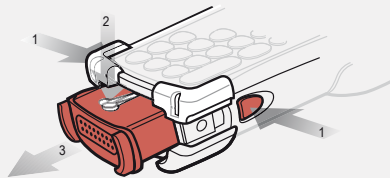

### Back View

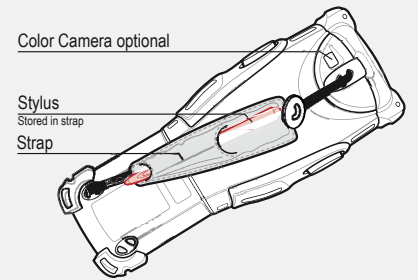

### Accessories for safe area

#### Charging Instructions

Slow Flash = Normal Charge

Solid Amber = Full Charge

Fast Flash = Charging Error

● = LED Indicator Location

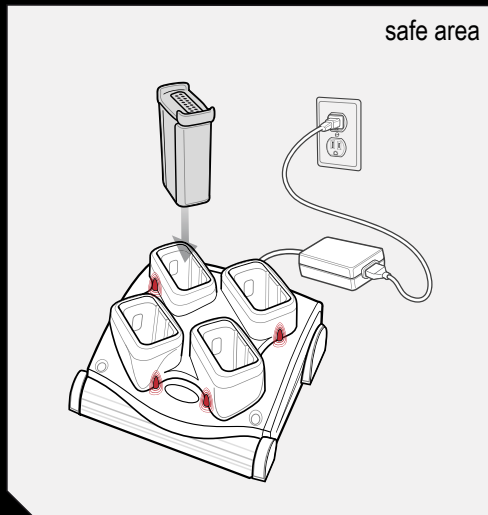

Four Slot Spare Battery Charger



Single Slot Serial/USB Cradle

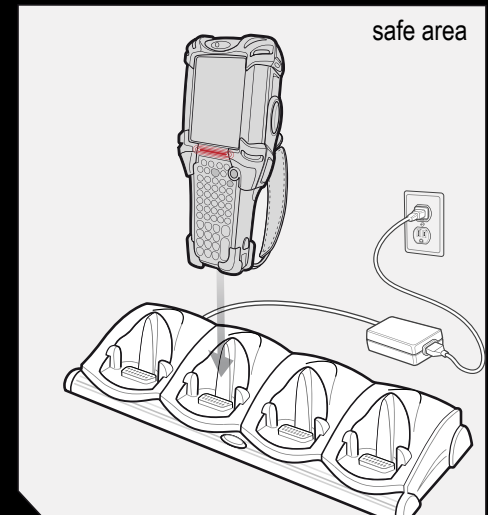

Four Slot Cradles

Charge-Only Cradle and Ethernet Cradle

Optimum Imaging and Scanning Positions

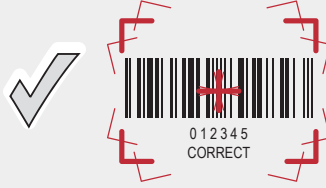
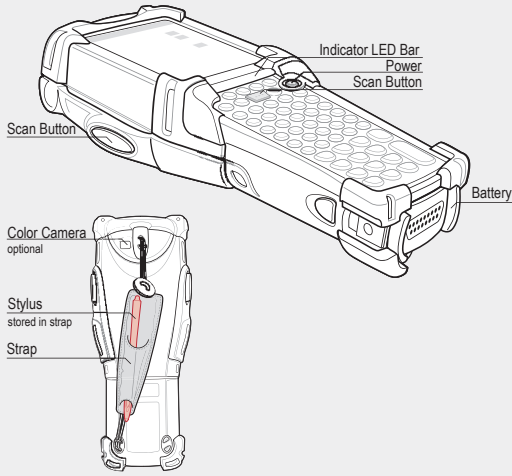

Camera Use

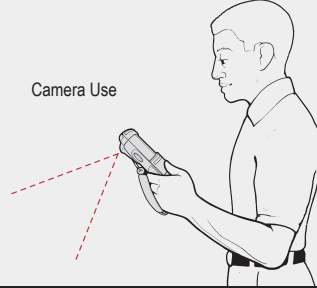

Scanning/Imaging

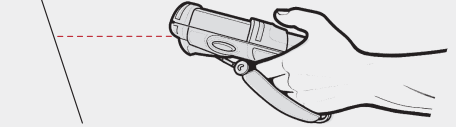

Optimum Upright Body Posture

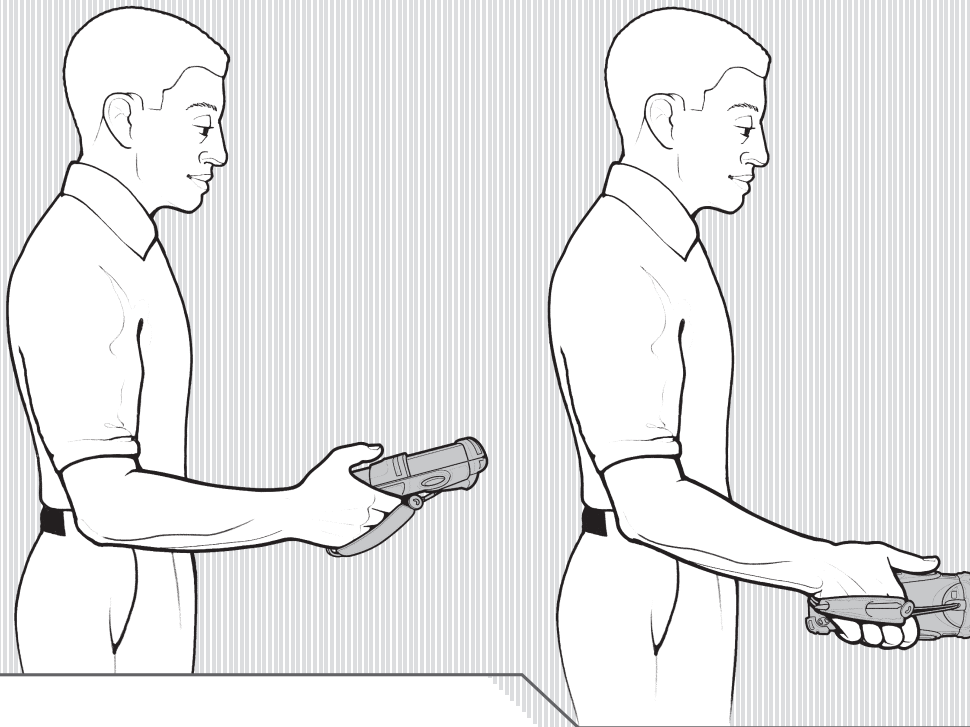

Avoid Extreme Wrist Angles

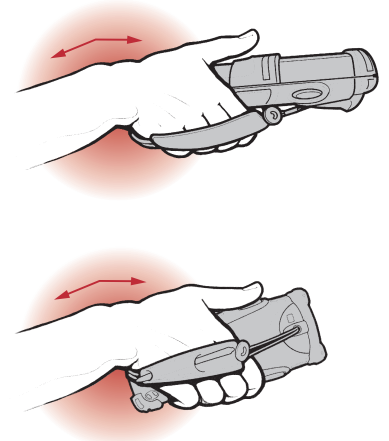

Optimum Body Posture for Low Scanning

ALTERNATE LEFT AND RIGHT KNEES

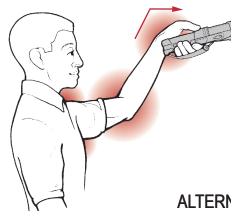

ALTERNATE LEFT AND RIGHT HANDS

POST IN WORK AREA