



# FCC SAR TEST REPORT

Report No.: STS2112357H01

Issued for

BARTEC

Max-Eyth-Str. 16 97980 Bad Mergentheim Germany

<b>Product Name:</b>	Pixavi Cam
<b>Brand Name:</b>	BARTEC GmbH
<b>Model Name:</b>	Pixavi Cam
<b>Series Model:</b>	17-S13*-10*1/***** ( Where * can be A-Z,a-z,0-9,"-",Blank or Slash )
<b>FCC ID:</b>	TBU-X8KPC
<b>Test Standard:</b>	ANSI/IEEE Std. C95.1
	FCC 47 CFR Part 2 ( 2.1093)
	IEEE 1528: 2013
<b>Max. Report SAR (1g):</b>	Head: 0.571W/kg
	Body: 0.148 W/kg

Any reproduction of this document must be done in full. No single part of this document may be reproduced without permission from STS, All Test Data Presented in this report is only applicable to presented Test sample.

ShenZhen STS Test Services Co.,Ltd.

A 1/F, Building B, Zhuoke Science Park, No.190 Chongqing Road, HepingShequ, Fuyong Sub-District, Bao'an District, Shenzhen, Guang Dong, China

TEL: +86-755 3688 6288 FAX: +86-755 3688 6277 E-mail:sts@stsapp.com

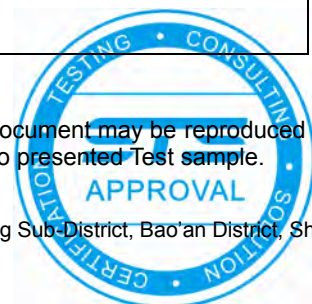



### Test Report Certification

**Applicant's name** ..... : BARTEC  
 Address ..... : Max-Eyth-Str. 16 97980 Bad Mergentheim Germany  
**Manufacturer's Name** ..... : BARTEC GmbH  
 Address ..... : Max-Eyth-Str. 16 97980 Bad Mergentheim Germany

#### Product description

Product name ..... : Pixavi Cam  
 Brand name ..... : BARTEC GmbH  
 Model name ..... : Pixavi Cam  
 Series Model..... : 17-S13\*-10\*1/\*\*\*\*\* ( Where \* can be A-Z,a-z,0-9,"-",Blank or Slash )  
 Standards ..... : ANSI/IEEE Std. C95.1-1992  
 FCC 47 CFR Part 2 ( 2.1093)  
 IEEE 1528: 2013

The device was tested by Shenzhen STS Test Services Co., Ltd. in accordance with the measurement methods and procedures specified in KDB 865664 The test results in this report apply only to the tested sample of the stated device/equipment. Other similar device/equipment will not necessarily produce the same results due to production tolerance and measurement uncertainties.

**Date of Test** ..... :  
 Date (s) of performance of tests..... : 11 Apr. 2022 ~ 14 Apr. 2022  
 Date of Issue..... : 19 Apr. 2022  
 Test Result..... : **Pass**

Testing Engineer : Shi fan-long  
 (Shifan. Long)

Technical Manager : Sean she  
 (Sean she)

Authorized Signatory : Bovey Yang  
 (Bovey Yang)





## Table of Contents

<b>1. General Information</b>	<b>5</b>
1.1 EUT Description	5
1.2 Test Environment	6
1.3 Test Factory	6
<b>2. Test Standards and Limits</b>	<b>7</b>
<b>3. SAR Measurement System</b>	<b>7</b>
3.1 Definition of Specific Absorption Rate (SAR)	7
3.2 SAR System	8
<b>4. Tissue Simulating Liquids</b>	<b>11</b>
4.1 Simulating Liquids Parameter Check	11
<b>5. SAR System Validation</b>	<b>13</b>
5.1 Validation System	13
5.2 Validation Result	14
<b>6. SAR Evaluation Procedures</b>	<b>15</b>
<b>7. EUT Antenna Location Sketch</b>	<b>16</b>
7.1 SAR test exclusion consider table	17
<b>8. EUT Test Position</b>	<b>20</b>
8.1 Define Two Imaginary Lines on the Handset	20
8.2 Hotspot mode exposure position condition	21
<b>9. Uncertainty</b>	<b>22</b>
9.1 Measurement Uncertainty	22
<b>10. Conducted Power Measur</b>	<b>23</b>
<b>11. EUT and Test Setup Photo</b>	<b>26</b>
11.1 EUT Photo	26
11.2 Setup Photo	29
<b>12. SAR Result Summary</b>	<b>35</b>
12.1 Head SAR	35
12.2 Body-worn and Hotspot SAR	36
<b>13. Equipment List</b>	<b>37</b>
<b>Appendix A. System Validation Plots</b>	<b>38</b>
<b>Appendix B. SAR Test Plots</b>	<b>46</b>
<b>Appendix C. Probe Calibration and Dipole Calibration Report</b>	<b>56</b>



**Revision History**

Rev.	Issue Date	Report No.	Effect Page	Contents
00	19 Apr. 2022	STS2112357H01	ALL	Initial Issue





# 1. General Information

Environmental evaluation measurements of specific absorption rate (SAR) distributions in emulated human head and body tissues exposed to radio frequency (RF) radiation from wireless portable devices for compliance with the rules and regulations of the U.S. Federal Communications Commission (FCC).

## 1.1 EUT Description

Product Name	Pixavi Cam			
Brand Name	BARTEC GmbH			
Model Name	Pixavi Cam			
Series Model	17-S13*-10*1/***** (Where * can be A-Z,a-z,0-9,"-",Blank or Slash)			
Model Difference	Models are named differently for different regions.			
Battery	Rated Voltage: 3.8 V (Nominal) Charge Limit Voltage: 4.35 V Capacity: 3200mAh			
Device Category	Portable			
Product stage	Production unit			
RF Exposure Environment	General Population / Uncontrolled			
Hardware Version	X8K_Main_Board RevC			
Software Version	PWG1.200910.756			
Frequency Range	WLAN802.11b/g/n20: 2412 MHz ~ 2462 MHz WLAN 802.11n40: 2422 MHz ~ 2452 MHz WLAN 802.11a/n20/n40/ac20/ac40/ac80: 5150 ~ 5250 MHz WLAN 802.11a/n20/n40/ac20/ac40/ac80: 5250 ~ 5350 MHz WLAN 802.11a/n20/n40/ac20/ac40/ac80: 5470 ~ 5725 MHz Bluetooth: 2402 MHz to 2480 MHz NFC: 13.56MHz			
Max. Reported SAR(1g): (Limit:1.6W/kg)	Band	Mode	Head (W/kg)	Body Worn and Hotspot(W/kg)
	DTS	2.4G WLAN	0.119	0.055
	NII	5.2G WLAN	0.571	0.148
	NII	5.3G WLAN	0.551	0.122
	NII	5.6G WLAN	0.292	0.081
	DSS	BT	0.029	0.012
FCC Equipment Class	Part 15 Spread Spectrum Transmitter (DSS) Digital Transmission System (DTS) Unlicensed National Information Infrastructure TX(NII)			
Operating Mode:	2.4G WLAN : 802.11b(DSSS):CCK,DQPSK,DBPSK 802.11g(OFDM):BPSK,QPSK,16-QAM,64-QAM 802.11n(OFDM):BPSK,QPSK,16-QAM,64-QAM 5G WLAN: 802.11a(OFDM):BPSK,QPSK,16-QAM,64-QAM 802.11n(OFDM):BPSK,QPSK,16-QAM,64-QAM 802.11ac(OFDM):BPSK,QPSK,16-QAM,64-QAM,256-QAM Bluetooth: GFSK + $\pi$ /4DQPSK+8DPSK BLE: GFSK NFC: FSK			
Antenna Specification:	Bluetooth: PIFA Antenna WLAN: PIFA Antenna NFC: Coil Antenna			
Hotspot Mode	Support			



DTM Mode	Not Support
Note: 1. The EUT battery must be fully charged and checked periodically during the test to ascertain uniform power	

## 1.2 Test Environment

Ambient conditions in the SAR laboratory:

Items	Required
Temperature (°C)	18-25
Humidity (%RH)	30-70

## 1.3 Test Factory

ShenZhen STS Test Services Co.,Ltd.

A 1/F, Building B, Zhuoke Science Park, No.190 Chongqing Road, HepingShequ, Fuyong Sub-District, Bao'an District, Shenzhen, Guang Dong, China

FCC test Firm Registration No.: 625569

IC Registration No.: 12108A

A2LA Certificate No.: 4338.01



## 2. Test Standards and Limits

No.	Identity	Document Title
1	47 CFR Part 2	Frequency Allocations and Radio Treaty Matters; General Rules and Regulations
2	ANSI/IEEE Std. C95.1-1992	IEEE Standard for Safety Levels with Respect to Human Exposure to Radio Frequency Electromagnetic Fields, 3 kHz to 300 GHz
3	IEEE Std. 1528-2013	Recommended Practice for Determining the Peak Spatial-Average Specific Absorption Rate (SAR) in the Human Head from Wireless Communications Devices: Measurement Techniques
4	FCC KDB 447498 D04 v01	RF Exposure Procedures and Equipment Authorization Policies for Mobile and Portable Devices
5	FCC KDB 865664 D01 v01r04	SAR Measurement 100 MHz to 6 GHz
6	FCC KDB 865664 D02 v01r02	RF Exposure Reporting
7	FCC KDB 941225 D06 v02r01	Hotspot Mode SAR
8	FCC KDB 648474 D04 v01r03	SAR Evaluation Considerations for Wireless Handsets
9	FCC KDB 248227 D01 Wi-Fi SAR v02r02	SAR Considerations for 802.11 Devices

### (A). Limits for Occupational/Controlled Exposure (W/kg)

Whole-Body	Partial-Body	Hands, Wrists, Feet and Ankles
0.4	8.0	20.0

### (B). Limits for General Population/Uncontrolled Exposure (W/kg)

Whole-Body	Partial-Body	Hands, Wrists, Feet and Ankles
0.08	1.6	4.0

NOTE: Whole-Body SAR is averaged over the entire body, partial-body SAR is averaged over any 1 gram of tissue defined as a tissue volume in the shape of a cube. SAR for hands, wrists, feet and ankles is averaged over any 10 grams of tissue defined as a tissue volume in the shape of a cube.

#### **Population/Uncontrolled Environments:**

Are defined as locations where there is the exposure of individuals who have no knowledge or control of their exposure.

#### **Occupational/Controlled Environments:**

Are defined as locations where there is exposure that may be incurred by people who are aware of the potential for exposure, (i.e. as a result of employment or occupation).

<p><b>NOTE</b></p> <p><b>GENERAL POPULATION/UNCONTROLLED EXPOSURE</b></p> <p><b>PARTIAL BODY LIMIT</b></p> <p><b>1.6 W/kg</b></p>
---

## 3. SAR Measurement System

### 3.1 Definition of Specific Absorption Rate (SAR)

SAR is related to the rate at which energy is absorbed per unit mass in an object exposed to a radio field. The SAR distribution in a biological body is complicated and is usually carried out by experimental

techniques or numerical modeling. The standard recommends limits for two tiers of groups, occupational/controlled and general population/uncontrolled, based on a person's awareness and ability to exercise control over his or her exposure. In general, occupational/controlled exposure limits are higher than the limits for general population/uncontrolled.

The SAR definition is the time derivative (rate) of the incremental energy (dW) absorbed by (dissipated in) an incremental mass (dm) contained in a volume element (dv) of a given density (ρ). The equation description is as below:

$$SAR = \frac{d}{dt} \left( \frac{dW}{dm} \right) = \frac{d}{dt} \left( \frac{dW}{\rho dv} \right)$$

SAR is expressed in units of Watts per kilogram (W/kg) SAR measurement can be related to the electrical field in the tissue by

$$SAR = \frac{\sigma E^2}{\rho}$$

Where: σ is the conductivity of the tissue,  
ρ is the mass density of the tissue and E is the RMS electrical field strength.

### 3.2 SAR System

MVG SAR System Diagram:

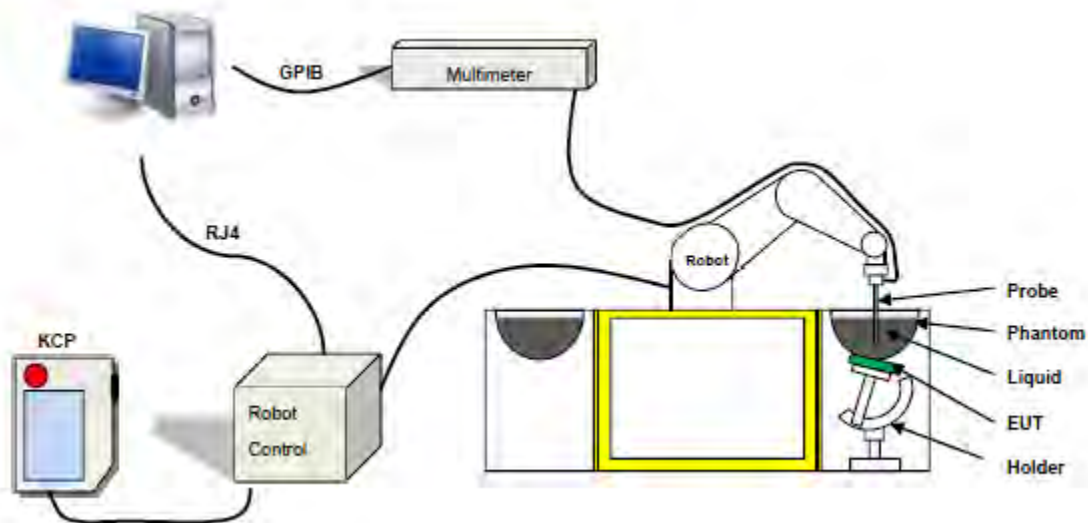

COMOSAR is a system that is able to determine the SAR distribution inside a phantom of human being according to different standards. The COMOSAR system consists of the following items:

- Main computer to control all the system
- 6 axis robot
- Data acquisition system
- Miniature E-field probe
- Phone holder
- Head simulating tissue



The following figure shows the system.



The EUT under test operating at the maximum power level is placed in the phone holder, under the phantom, which is filled with head simulating liquid. The E-Field probe measures the electric field inside the phantom. The Open SAR software computes the results to give a SAR value in a 1g or 10g mass.

### 3.2.1 Probe

For the measurements the Specific Dosimetric E-Field Probe SN 07/21 EPGO352 with following specifications is used

- Probe Length: 330 mm
- Length of Individual Dipoles: 2 mm
- Maximum external diameter: 8 mm
- Probe Tip External Diameter: 2.5 mm
- Distance between dipole/probe extremity: 1 mm
- Dynamic range: 0.01-100 W/kg
- Probe linearity: 3%
- Axial Isotropy: < 0.10 dB
- Spherical Isotropy: < 0.10 dB
- Calibration range: 150 MHz to 6 GHz for head & body simulating liquid.
- Angle between probe axis (evaluation axis) and surface normal line: less than 30°



Figure 1-MVG COMOSAR Dosimetric E field Dipole

### 3.2.2 Phantom

For the measurements the Specific Anthropomorphic Mannequin (SAM) defined by the IEEE SCC-34/SC2 group is used. The phantom is a polyurethane shell integrated in a wooden table. The thickness of the phantom amounts to 2mm +/- 0.2mm. It enables the dosimetric evaluation of left and right phone usage and includes an additional flat phantom part for the simplified performance check. The phantom set-up includes a cover, which prevents the evaporation of the liquid.

SN 32/14 SAM115



SN 32/14 SAM116



### 3.2.3 Device Holder

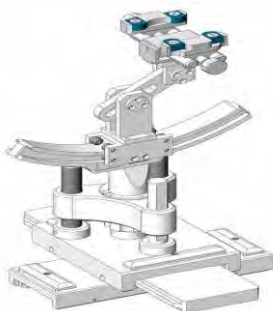

The SAR in the phantom is approximately inversely proportional to the square of the distance between the source and the liquid surface. For a source at 5 mm distance, a positioning uncertainty of  $\pm 0.5$  mm would produce a SAR uncertainty of  $\pm 20$  %. Accurate device positioning is therefore crucial for accurate and repeatable measurements. The positions in which the devices must be measured are defined by the standards.

#### 4. Tissue Simulating Liquids



## 4. Tissue Simulating Liquids

### 4.1 Simulating Liquids Parameter Check

The head tissue dielectric parameters recommended by the IEEE SCC-34/SC-2 in P1528 have been incorporated in the following table. These head parameters are derived from planar layer models simulating the highest expected SAR for the dielectric properties and tissue thickness variations in a human head. Other head and body tissue parameters that have not been specified in P1528 are derived from the tissue dielectric parameters computed from the 4-Cole-Cole equations described in Reference [12] and extrapolated according to the head parameters specified in P1528.

#### Head Tissue

Frequency (MHz)	cellulose	DGBE	HEC	NaCl	Preventol	Sugar	X100	Water	Conductivity	Permittivity
	%	%	%	%	%	%	%	%	$\sigma$	$\epsilon_r$
750	0.2	/	/	1.4	0.2	57.0	/	41.1	0.89	41.9
835	0.2	/	/	1.4	0.2	57.9	/	40.3	0.90	41.5
900	0.2	/	/	1.4	0.2	57.9	/	40.3	0.97	41.5
1800	/	44.5	/	0.3	/	/	30.45	55.2	1.4	40.0
1900	/	44.5	/	0.3	/	/	30.45	55.2	1.4	40.0
2000	/	44.5	/	0.3	/	/	/	55.2	1.4	40.0
2450	/	44.9	/	0.1	/	/	/	55.0	1.80	39.2
2600	/	45.0	/	0.1	/	/	/	54.9	1.96	39.0

#### Body Tissue

Frequency (MHz)	cellulose	DGBE	HEC	NaCl	Preventol	Sugar	X100	Water	Conductivity	Permittivity
	%	%	%	%	%	%	%	%	$\sigma$	$\epsilon_r$
750	0.2	/	/	0.9	0.1	47.2	/	51.7	0.96	55.5
835	0.2	/	/	0.9	0.1	48.2	/	50.8	0.97	55.2
900	0.2	/	/	0.9	0.1	48.2	/	50.8	1.05	55.0
1800	/	29.4	/	0.4	/	/	30.45	70.2	1.52	53.3
1900	/	29.4	/	0.4	/	/	30.45	70.2	1.52	53.3
2000	/	29.4	/	0.4	/	/	/	70.2	1.52	53.3
2450	/	31.3	/	0.1	/	/	/	68.6	1.95	52.7
2600	/	31.7	/	0.1	/	/	/	68.2	2.16	52.3

Tissue dielectric parameters for head and body phantoms				
Frequency	$\epsilon_r$		$\sigma$ S/m	
	Head	Body	Head	Body
	300	45.3	58.2	0.87
450	43.5	56.7	0.87	0.94
900	41.5	55.0	0.97	1.05
1450	40.5	54.0	1.20	1.30
1800	40.0	53.3	1.40	1.52
2450	39.2	52.7	1.80	1.95
3000	38.5	52.0	2.40	2.73
5800	35.3	48.2	5.27	6.00



**LIQUID MEASUREMENT RESULTS**

Date	Ambient		Simulating Liquid		Parameters	Target	Measured	Deviation %	Limited %
	Temp. [°C]	Humidity %	Frequency	Temp. [°C]					
2022-04-11	21.0	58	2437 MHz	20.8	Permittivity	39.2	38.53	-1.71	±5
					Conductivity	1.78	1.74	-2.25	±5
2022-04-11	22.4	41	2480 MHz	22.1	Permittivity	39.15	39.15	0.00	±5
					Conductivity	1.83	1.75	-4.37	±5
2022-04-11	20.6	56	2450 MHz	20.3	Permittivity	39.2	39.46	0.66	±5
					Conductivity	1.8	1.82	1.11	±5
2022-04-12	22.5	42	5190 MHz	22.2	Permittivity	36.01	35.78	-0.64	±5
					Conductivity	4.65	4.63	-0.43	±5
2022-04-12	23.4	43	5200 MHz	23.1	Permittivity	36	34.57	-3.97	±5
					Conductivity	4.66	4.62	-0.86	±5
2022-04-12	21.9	54	5230 MHz	21.6	Permittivity	35.97	35.53	-1.22	±5
					Conductivity	4.69	4.64	-1.07	±5
2022-04-13	20.3	57	5270 MHz	20.0	Permittivity	35.93	36.04	0.31	±5
					Conductivity	4.73	4.67	-1.27	±5
2022-04-13	22.7	46	5300 MHz	22.3	Permittivity	35.9	34.79	-3.09	±5
					Conductivity	4.76	4.79	0.63	±5
2022-04-14	22.7	54	5600 MHz	22.4	Permittivity	35.55	36.26	2.00	±5
					Conductivity	5.07	5.09	0.39	±5
2022-04-14	21.6	57	5700 MHz	21.4	Permittivity	35.43	36.38	2.68	±5
					Conductivity	5.17	5.20	0.58	±5

## 5. SAR System Validation

### 5.1 Validation System

Each MVG system is equipped with one or more system validation kits. These units, together with the predefined measurement procedures within the MVG software, enable the user to conduct the system performance check and system validation. System kit includes a dipole, and dipole device holder.

The system check verifies that the system operates within its specifications. It's performed daily or before every SAR measurement. The system check uses normal SAR measurement in the flat section of the phantom with a matched dipole at a specified distance. The system validation setup is shown as below.

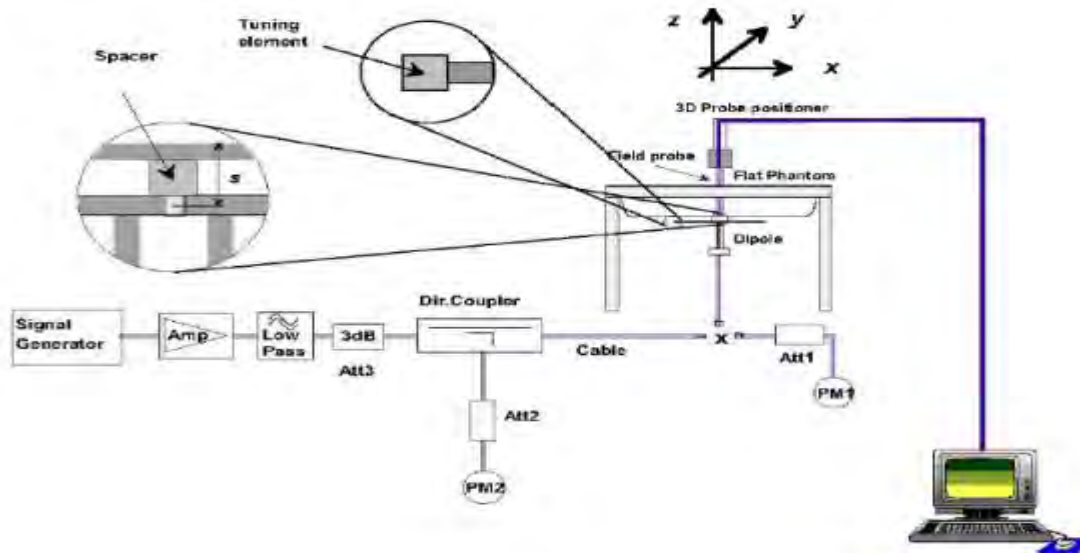



## 5.2 Validation Result

Comparing to the original SAR value provided by MVG, the validation data should be within its specification of 10 %.

Date	Freq.	Power	Tested Value	Normalized SAR	Target SAR	Tolerance	Limit
	(MHz)	(mW)	(W/Kg)	(W/kg)	1g(W/kg)	(%)	(%)
2022-04-11	2450	100	5.449	54.49	54.70	-0.38	10
2022-04-12	5200	100	15.843	158.43	158.49	-0.04	10
2022-04-13	5300	100	16.718	167.18	167.20	-0.01	10
2022-04-14	5600	100	17.561	175.61	175.65	-0.03	10

**Note:**

1. The tolerance limit of System validation  $\pm 10\%$ .
2. The dipole input power (forward power) was 100 mW.
3. The results are normalized to 1 W input power.





## 6. SAR Evaluation Procedures

The procedure for assessing the average SAR value consists of the following steps:

The following steps are used for each test position

- Establish a call with the maximum output power with a base station simulator. The connection between the mobile and the base station simulator is established via air interface
- Measurement of the local E-field value at a fixed location. This value serves as a reference value for calculating a possible power drift.
- Measurement of the SAR distribution with a grid of 8 to 16mm \* 8 to 16 mm and a constant distance to the inner surface of the phantom. Since the sensors cannot directly measure at the inner phantom surface, the values between the sensors and the inner phantom surface are extrapolated. With these values the area of the maximum SAR is calculated by an interpolation scheme.
- Around this point, a cube of 30 \* 30 \* 30 mm or 32 \* 32 \* 32 mm is assessed by measuring 5 or 8 \* 5 or 8\*4 or 5 mm. With these data, the peak spatial-average SAR value can be calculated.

### ➤ Area Scan & Zoom Scan

First Area Scan is used to locate the approximate location(s) of the local peak SAR value(s). The measurement grid within an Area Scan is defined by the grid extent, grid step size and grid offset. Next, in order to determine the EM field distribution in a three-dimensional spatial extension, Zoom Scan is required. The Zoom Scan is performed around the highest E-field value to determine the averaged SAR-distribution over 10 g. Area scan and zoom scan resolution setting follows KDB 865664 D01 quoted below. When the 1-g SAR of the highest peak is within 2 dB of the SAR limit, additional zoom scans are required for other peaks within 2 dB of the highest peak that have not been included in any zoom scan to ensure there is no increase in SAR.

## 7. EUT Antenna Location Sketch

It is a Pixavi Cam, support WLAN/BT mode.

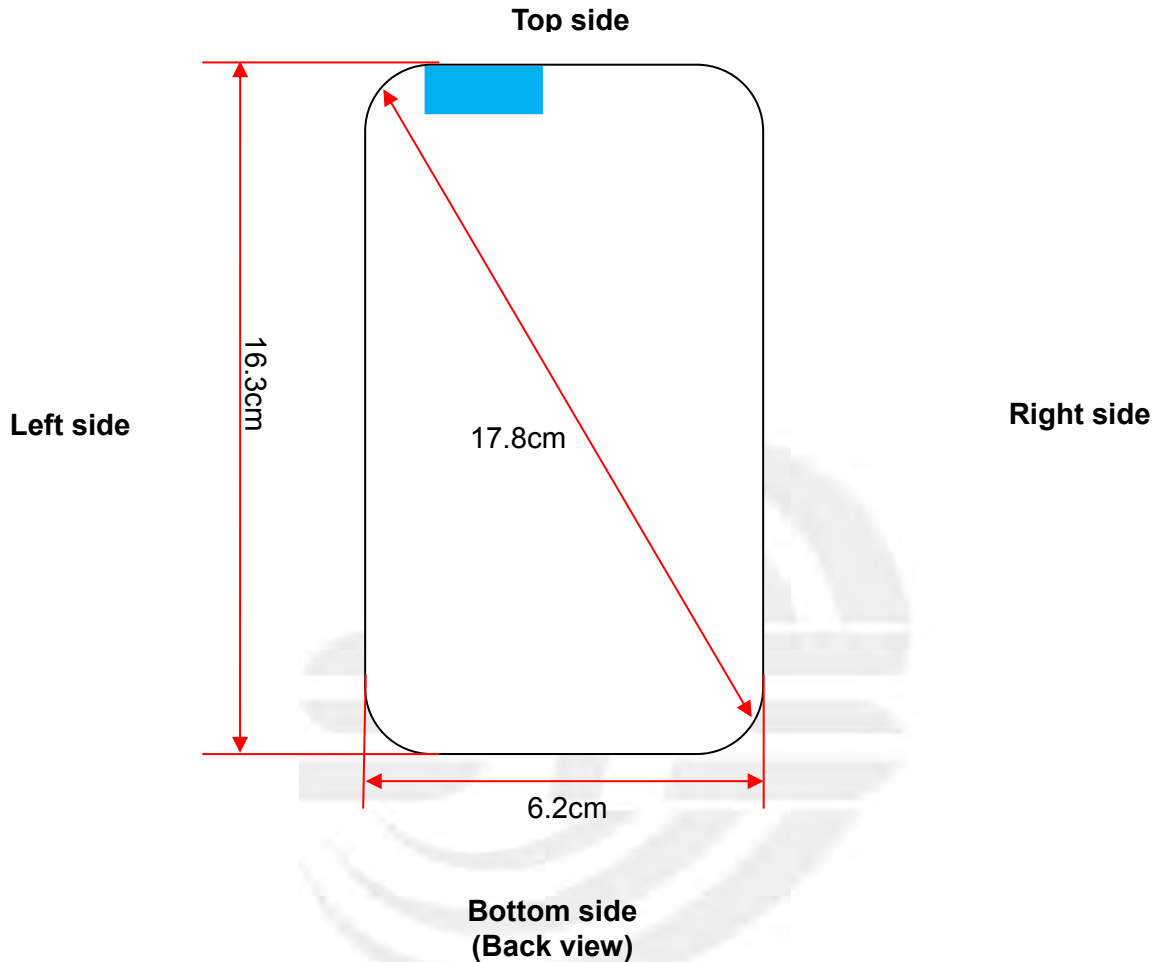

Antenna Separation Distance(cm)						
ANT	Back Side	Front Side	Left Edge	Right Side	Top Edge	Bottom Edge
WLAN/BT	≤0.5	≤0.5	2.3	5.2	≤0.5	14.6

 WLAN/BT Antenna

Note 1: The antenna information refer the manufacturer provide report, applicable only to the tested sample identified in the report.





**7.1 SAR test exclusion consider table**

The WLAN/BT SAR evaluation of Maximum power (dBm) summing tolerance.

Exposure Position	Wireless Interface	BT	2.4G WLAN	5.2G WLAN	5.3G WLAN	5.6G WLAN
	Calculated Frequency(GHz)	2.48	2.437	5.19	5.27	5.7
	Maximum Turn-up power (dBm)	3.5	9	12	12	13
	Maximum rated power(mW)	2.24	7.94	15.85	15.85	19.95
Back Side	Separation distance (cm)	≤0.5	≤0.5	≤0.5	≤0.5	≤0.5
	exclusion threshold(mW)	2.72	2.76	1.50	1.49	1.40
	Testing required?	NO	YES	YES	YES	YES
Front Side	Separation distance (cm)	≤0.5	≤0.5	≤0.5	≤0.5	≤0.5
	exclusion threshold(mW)	2.72	2.76	1.50	1.49	1.40
	Testing required?	NO	YES	YES	YES	YES
Left Edge	Separation distance (cm)	2.3	2.3	2.3	2.3	2.3
	exclusion threshold(mW)	49.72	50.13	35.15	34.90	33.64
	Testing required?	NO	NO	NO	NO	NO
Right Edge	Separation distance (cm)	5.2	5.2	5.2	5.2	5.2
	exclusion threshold(mW)	235.16	236.37	189.47	188.63	184.35
	Testing required?	NO	NO	NO	NO	NO
Top Edge	Separation distance (cm)	≤0.5	≤0.5	≤0.5	≤0.5	≤0.5
	exclusion threshold(mW)	2.72	2.76	1.50	1.49	1.40
	Testing required?	NO	YES	YES	YES	YES
Bottom Edge	Separation distance (cm)	14.6	14.6	14.6	14.6	14.6
	exclusion threshold(mW)	1680.27	1682.28	1597.58	1595.91	1587.38
	Testing required?	NO	NO	NO	NO	NO

**Note:**

1. maximum power is the source-based time-average power and represents the maximum RF output power among production units.
2. Per KDB 447498 D04, for larger devices, the test separation distance of adjacent edge configuration is determined by the closest separation between the antenna and the user.



3. Per KDB 447498 D04, if the maximum time-averaged power available does not exceed 1 mW. This stand-alone SAR exemption test.
4. Per KDB 447498 D04, the available maximum time-averaged power or effective radiated power (ERP), whichever is greater, is less than or equal to the threshold P<sub>th</sub> (mW) described in the following formula. This method shall only be used at separation distances (cm) from 0.5 centimeters to 40 centimeters and at frequencies from 0.3 GHz to 6 GHz (inclusive). P<sub>th</sub> is given by:

$$P_{th} \text{ (mW)} = \begin{cases} ERP_{20 \text{ cm}} (d/20 \text{ cm})^x & d \leq 20 \text{ cm} \\ ERP_{20 \text{ cm}} & 20 \text{ cm} < d \leq 40 \text{ cm} \end{cases}$$

Where

$$x = -\log_{10} \left( \frac{60}{ERP_{20 \text{ cm}} \sqrt{f}} \right) \text{ and } f \text{ is in GHz;}$$

and

$$ERP_{20 \text{ cm}} \text{ (mW)} = \begin{cases} 2040f & 0.3 \text{ GHz} \leq f < 1.5 \text{ GHz} \\ 3060 & 1.5 \text{ GHz} \leq f \leq 6 \text{ GHz} \end{cases}$$

*d* = the separation distance (cm);

5. Per KDB 447498 D04, An alternative to the SAR-based exemption is using below table and the minimum separation distance (R in meters) from the body of a nearby person for the frequency (f in MHz) at which the source operates, the ERP (watts) is no more than the calculated value prescribed for that frequency. For the exemption in below table to apply, R must be at least  $\lambda/2\pi$ , where  $\lambda$  is the free-space operating wavelength in meters. If the ERP of a single RF source is not easily obtained, then the available maximum time-averaged power may be used in lieu of ERP if the physical dimensions of the radiating structure(s) do not exceed the electrical length of  $\lambda/4$  or if the antenna gain is less than that of a half-wave dipole (1.64 linear value).

RF Source frequency (MHz)	Threshold ERP(watts)
0.3-1.34	1,920 R <sup>2</sup> .
1.34-30	3,450 R <sup>2</sup> /f <sup>2</sup> .
30-300	3.83 R <sup>2</sup> .
300-1,500	0.0128 R <sup>2</sup> f.
1,500-100,000	19.2R <sup>2</sup> .



6. Per KDB 248227 D01, choose the highest output power channel to test SAR and determine further SAR exclusion 8. for each frequency band, testing at higher data rates and higher order modulations is not required when the maximum average output power for each of each of these configurations is less than 1/4db higher than those measured at the lower data rate than 11b mode, thus the SAR can be excluded.
7. Per KDB 616217 D04, SAR evaluation for the front surface of tablet display screens are generally not necessary.



## 8. EUT Test Position

This EUT was tested in Right Cheek, Right Titled, Left Cheek, Left Titled, Front Face and Rear Face.

### 8.1 Define Two Imaginary Lines on the Handset

- (1) The vertical centerline passes through two points on the front side of the handset: the midpoint of the width  $w_t$  of the handset at the level of the acoustic output, and the midpoint of the width  $w_b$  of the handset.
- (2) The horizontal line is perpendicular to the vertical centerline and passes through the center of the acoustic output. The horizontal line is also tangential to the face of the handset at point A.
- (3) The two lines intersect at point A. Note that for many handsets, point A coincides with the center of the acoustic output; however, the acoustic output may be located elsewhere on the horizontal line. Also note that the vertical centerline is not necessarily to the front face of the handset, especially for clamshell handsets, handsets with flip covers, and other irregularly shaped handsets.

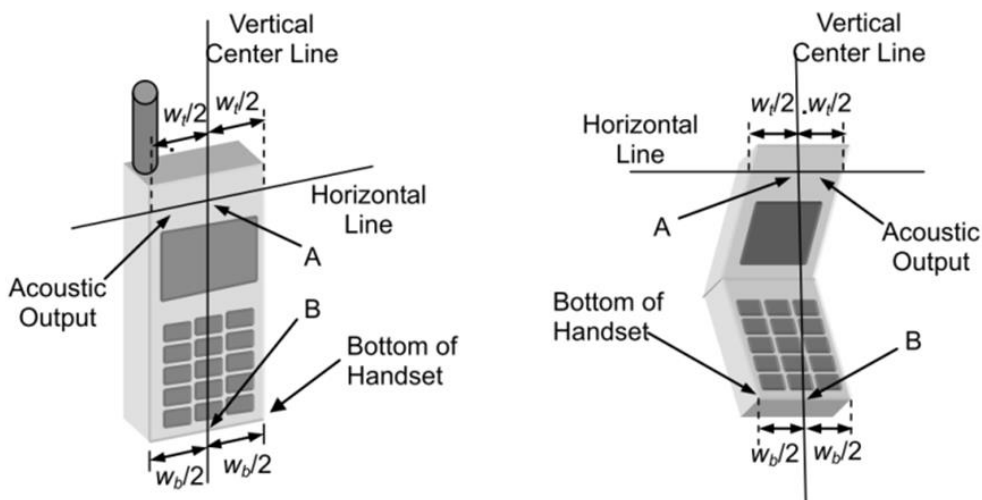

#### Cheek Position

- 1) To position the device with the vertical center line of the body of the device and the horizontal line crossing the center piece in a plane parallel to the sagittal plane of the phantom. While maintaining the device in this plane, align the vertical center line with the reference plane containing the ear and mouth reference point (M: Mouth, RE: Right Ear, and LE: Left Ear) and align the center of the ear piece with the line RE-LE.
- 2) To move the device towards the phantom with the ear piece aligned with the line LE-RE until the phone touched the ear. While maintaining the device in the reference plane and maintaining the phone contact with ear, move the bottom of the phone until any point on the front side is in contact with the cheek of the phantom or until contact with the ear is lost.

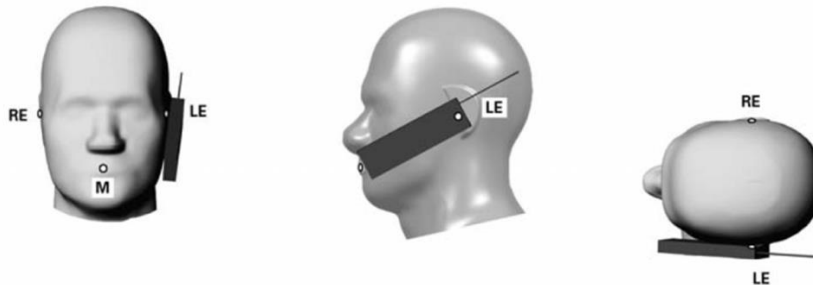

Title Position

- (1) To position the device in the “cheek” position described above.
- (2) While maintaining the device in the reference plane described above and pivoting against the ear, moves it outward away from the mouth by an angle of 15 degrees or until with the ear is lost.

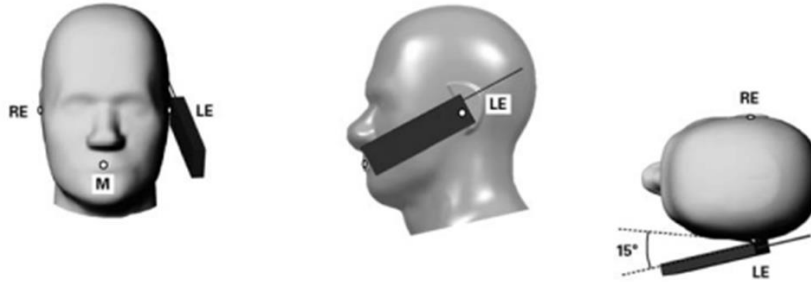

Body-worn Position Conditions:

Body-worn accessory exposure is typically related to voice mode operations when handsets are carried in body-worn accessories. The body-worn accessory procedures in KDB Publication 447498 D01 should be used to test for body-worn accessory SAR compliance, without a headset connected to it. When the same wireless transmission configuration is used for testing body-worn accessory and hotspot mode SAR, respectively, in voice and data mode, SAR results for the most conservative *test separation distance* configuration may be used to support both SAR conditions. When the *reported SAR* for a body-worn accessory, measured without a headset connected to the handset, is  $> 1.2 \text{ W/kg}$ , the highest *reported SAR* configuration for that wireless mode and frequency band should be repeated for the body-worn accessory with a headset attached to the handset.

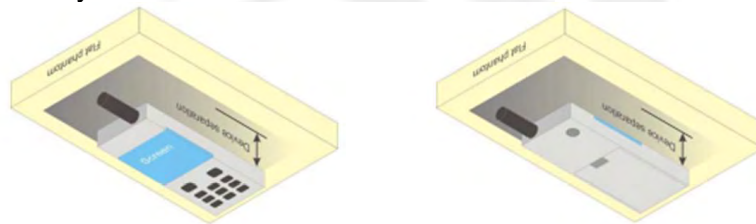

## 8.2 Hotspot mode exposure position condition

For handsets that support hotspot mode operations, with wireless router capabilities and various web browsing function, the relevant hand and body exposure condition are tested according to the hotspot SAR procedures in KDB 941225. A test separation distance of 10 mm is required between the phantom and all surface and edges with a transmitting antenna located within 25 mm from that surface or edge. When form factor of a handset is smaller than 9cm x 5cm, a test separation distance of 5mm (instead of 10mm) is required for testing hotspot mode. When the separate distance required for body-worn accessory testing is larger than or equal to that tested for hotspot mode, in the same wireless mode and for the same surface of the phone, the hotspot mode SAR data may be used to support body-worn accessory SAR compliance for that particular configuration (surface).

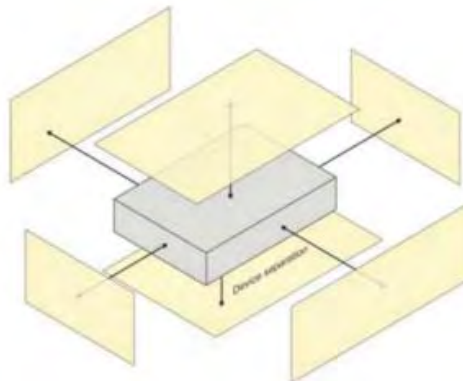



## 9. Uncertainty

### 9.1 Measurement Uncertainty

The following measurement uncertainty levels have been estimated for tests performed on the EUT as specified in IEEE 1528: 2013. This uncertainty represents an expanded uncertainty expressed at approximately the 95% confidence level using a coverage factor of k=2.

Uncertainty Component	Tol (+-%)	Prob. Dist.	Div.	Ci (1g)	Ci (10g)	1g Ui (+-%)	10g Ui (+-%)	vi
<b>Measurement System</b>								
Probe calibration	5.86	N	1	1	1	5.86	5.86	∞
Axial Isotropy	0.16	R	$\sqrt{3}$	$\sqrt{0.5}$	$\sqrt{0.5}$	0.07	0.07	∞
Hemispherical Isotropy	1.06	R	$\sqrt{3}$	$\sqrt{0.5}$	$\sqrt{0.5}$	0.43	0.43	∞
Boundary effect	1	R	$\sqrt{3}$	1	1	0.58	0.58	∞
Linearity	1.27	R	$\sqrt{3}$	1	1	0.73	0.73	∞
System detection limits	1.23	R	$\sqrt{3}$	1	1	0.71	0.71	∞
Modulation response	3.6	R	$\sqrt{3}$	1	1	3.60	3.60	∞
Readout Electronics	0.28	N	1	1	1	0.28	0.28	∞
Response Time	0.19	R	$\sqrt{3}$	1	1	0.11	0.11	∞
Integration Time	1.47	R	$\sqrt{3}$	1	1	0.85	0.85	∞
RF ambient conditions-Noise	3.5	R	$\sqrt{3}$	1	1	2.02	2.02	∞
RF ambient conditions-reflections	3.2	R	$\sqrt{3}$	1	1	1.85	1.85	∞
Probe positioner mechanical tolerance	1.4	R	$\sqrt{3}$	1	1	0.81	0.81	∞
Probe positioning with respect to phantom shell	1.4	R	$\sqrt{3}$	1	1	0.81	0.81	∞
Post-processing	2.3	R	$\sqrt{3}$	1	1	1.33	1.33	∞
<b>Test sample Related</b>								
Test sample positioning	3.1	N	1	1	1	3.10	3.10	∞
Device holder uncertainty	3.8	N	1	1	1	3.80	3.80	∞
SAR drift measurement	4.8	R	$\sqrt{3}$	1	1	2.77	2.77	∞
SAR scaling	2	R	$\sqrt{3}$	1	1	1.15	1.15	∞
<b>Phantom and tissue parameters</b>								
Phantom uncertainty (shape and thickness uncertainty)	4	R	$\sqrt{3}$	1	1	2.31	2.31	∞
Uncertainty in SAR correction for deviations in permittivity and conductivity	2	N	1	1	0.84	2.00	1.68	∞
Liquid conductivity (temperature uncertainty)	2.5	R	$\sqrt{3}$	0.78	0.71	1.95	1.78	∞
Liquid conductivity (measured)	4	N	1	0.78	0.71	0.92	1.04	M
Liquid permittivity (temperature uncertainty)	2.5	R	$\sqrt{3}$	0.23	0.26	1.95	1.78	∞
Liquid permittivity (measured)	5	N	1	0.23	0.26	1.15	1.30	M
Combined Standard Uncertainty		RSS				10.60	10.51	
Expanded Uncertainty (95% Confidence interval)		K=2				21.21	21.03	



## 10. Conducted Power Measur

### 2.4G WLAN

2.4GWIFI				
Mode	Channel Number	Frequency (MHz)	Average Power (dBm)	Output Power (mW)
802.11b	1	2412	8.54	7.14
	7	2437	8.55	7.16
	11	2462	8.21	6.62
802.11g	1	2412	7.93	6.21
	7	2437	7.90	6.17
	11	2462	7.58	5.73
802.11 n-HT20	1	2412	7.79	6.01
	7	2437	7.70	5.89
	11	2462	7.50	5.62
802.11 n-HT40	3	2422	8.06	6.40
	6	2437	8.10	6.46
	9	2452	7.74	5.94

### Bluetooth

BT				
Mode	Channel Number	Frequency (MHz)	Average Power (dBm)	Output Power (mW)
GFSK(1Mbps)	0	2402	2.18	1.65
	39	2441	2.05	1.60
	78	2480	3.38	2.18
$\pi/4$ -QPSK(2Mbps)	0	2402	-1.97	0.64
	39	2441	-1.67	0.68
	78	2480	0.36	1.09
8DPSK(3Mbps)	0	2402	-1.00	0.79
	39	2441	-1.74	0.67
	78	2480	0.37	1.09

**BLE**

BLE				
Mode	Channel Number	Frequency (MHz)	Average Power (dBm)	Output Power (mW)
GFSK(1Mbps)	0	2402	0.65	1.16
	19	2440	0.32	1.08
	39	2480	0.75	1.19
GFSK(2Mbps)	0	2402	0.37	1.09
	19	2440	0.01	1.00
	39	2480	0.48	1.12

**WLAN (5.2Gband)**

5.2G WLAN				
Mode	Channel Number	Frequency (MHz)	Output Power (dBm)	Output Power (mW)
802.11a20	36	5180	11.51	14.16
	40	5200	11.21	13.21
	48	5240	11.16	13.06
802.11 n-HT20	36	5180	11.33	13.58
	40	5200	11.24	13.30
	48	5240	10.99	12.56
802.11 n-HT40	38	5190	11.55	14.29
	46	5230	11.06	12.76
802.11ac-VHT20	36	5180	11.31	13.52
	40	5200	11.31	13.52
	48	5240	10.94	12.42
802.11ac-VHT40	38	5190	11.55	14.29
	46	5230	11.04	12.71
802.11ac-VHT80	42	5210	8.87	7.71



**WLAN (5.3Gband)**

5.3G WLAN				
Mode	Channel Number	Frequency (MHz)	Output Power (dBm)	Output Power (mW)
802.11a20	52	5260	11.48	14.06
	60	5300	11.04	12.71
	64	5320	10.86	12.19
802.11 n-HT20	52	5260	11.25	13.34
	60	5300	10.89	12.27
	64	5320	10.80	12.02
802.11 n-HT40	54	5270	11.49	14.09
	62	5310	11.00	12.59
802.11ac-VHT20	52	5260	11.23	13.27
	60	5300	10.93	12.39
	64	5320	10.76	11.91
802.11ac-VHT40	54	5270	11.50	14.13
	62	5310	11.03	12.68
802.11ac-VHT80	58	5290	8.46	7.01

**WLAN (5.6Gband)**

5.6G WLAN				
Mode	Channel Number	Frequency (MHz)	Output Power (dBm)	Output Power (mW)
802.11a20	100	5500	10.83	12.11
	116	5580	10.96	12.47
	140	5700	12.73	18.75
802.11 n-HT20	100	5500	10.67	11.67
	116	5580	10.82	12.08
	140	5700	12.52	17.86
802.11 n-HT40	102	5510	10.97	12.50
	110	5550	10.63	11.56
	134	5670	12.55	17.99
802.11ac-VHT20	100	5500	10.64	11.59
	116	5580	10.81	12.05
	140	5700	12.55	17.99
802.11ac-VHT40	102	5510	10.92	12.36
	110	5550	10.56	11.38
	134	5670	12.56	18.03
802.11ac-VHT80	106	5530	6.21	4.18
	122	5610	4.93	3.11

## 11. EUT and Test Setup Photo

### 11.1 EUT Photo

Front side



Back side





Top side



Bottom side



Left side

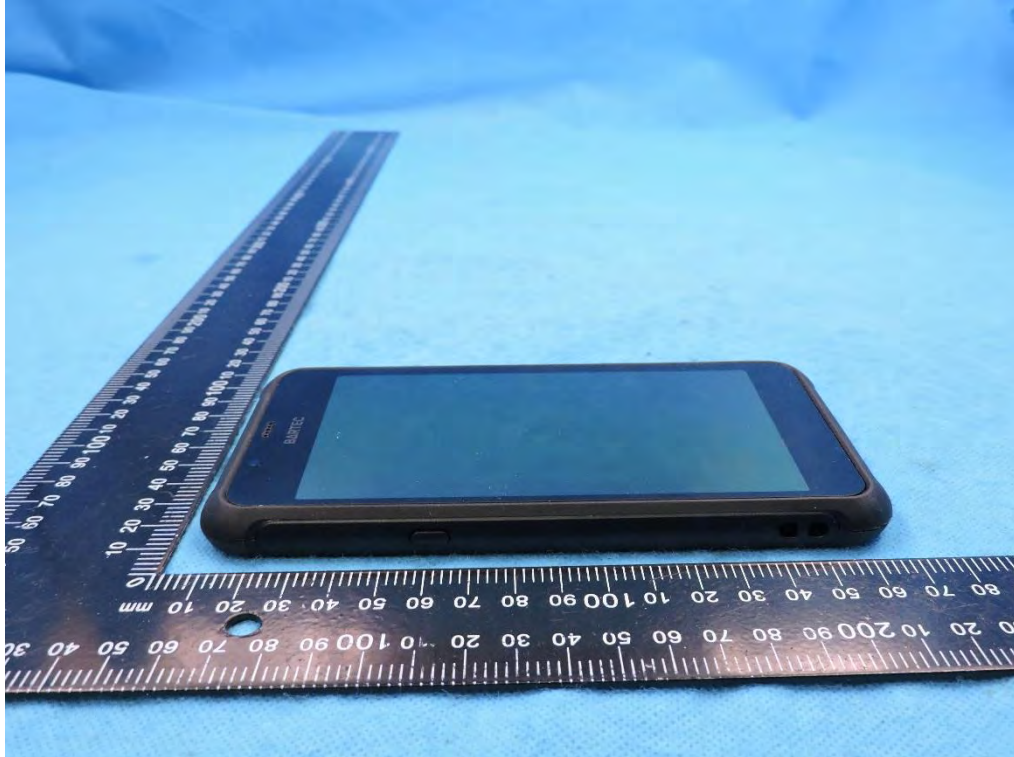

Right side

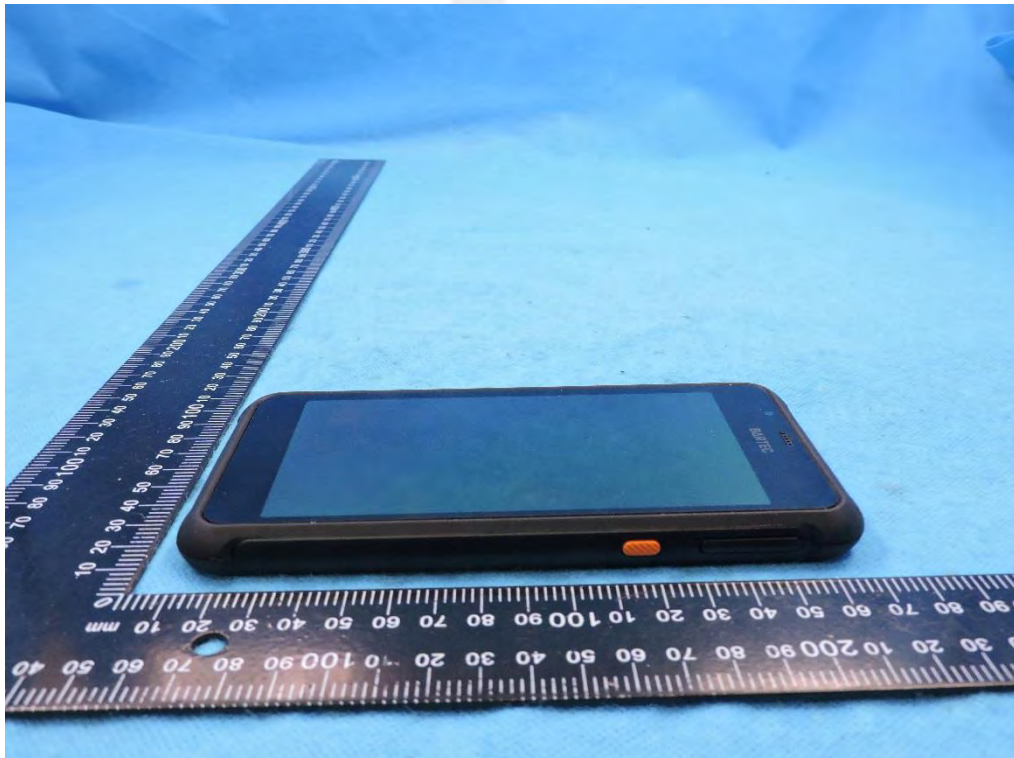

## 11.2 Setup Photo

Right Touch

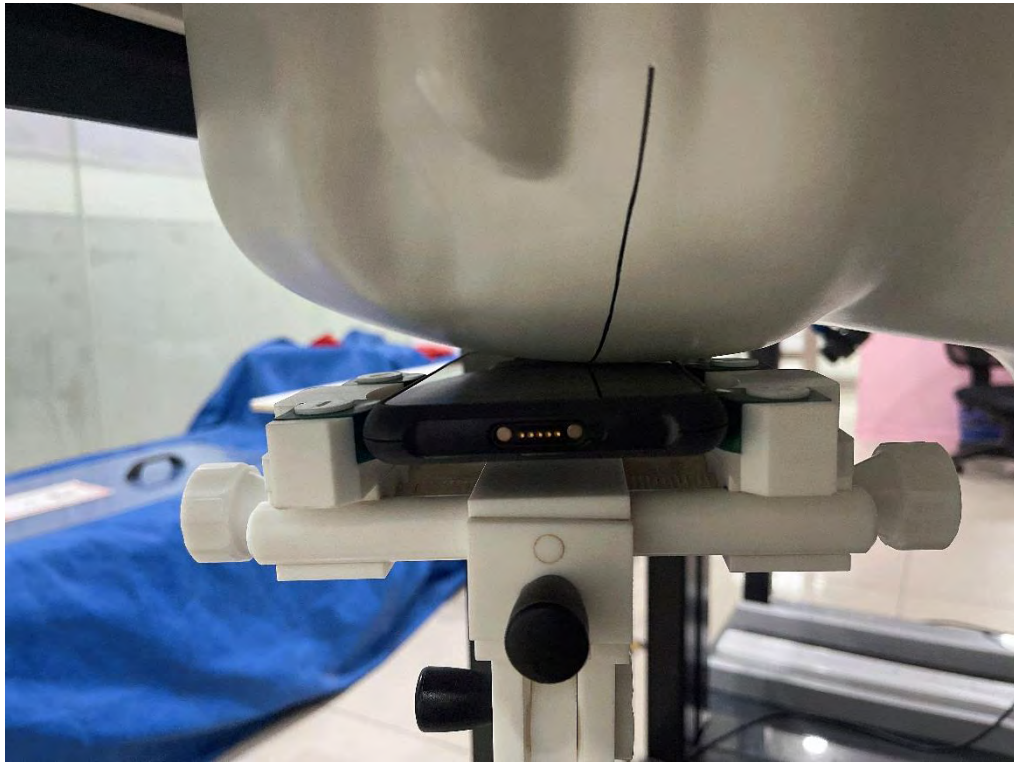

Right Tilt

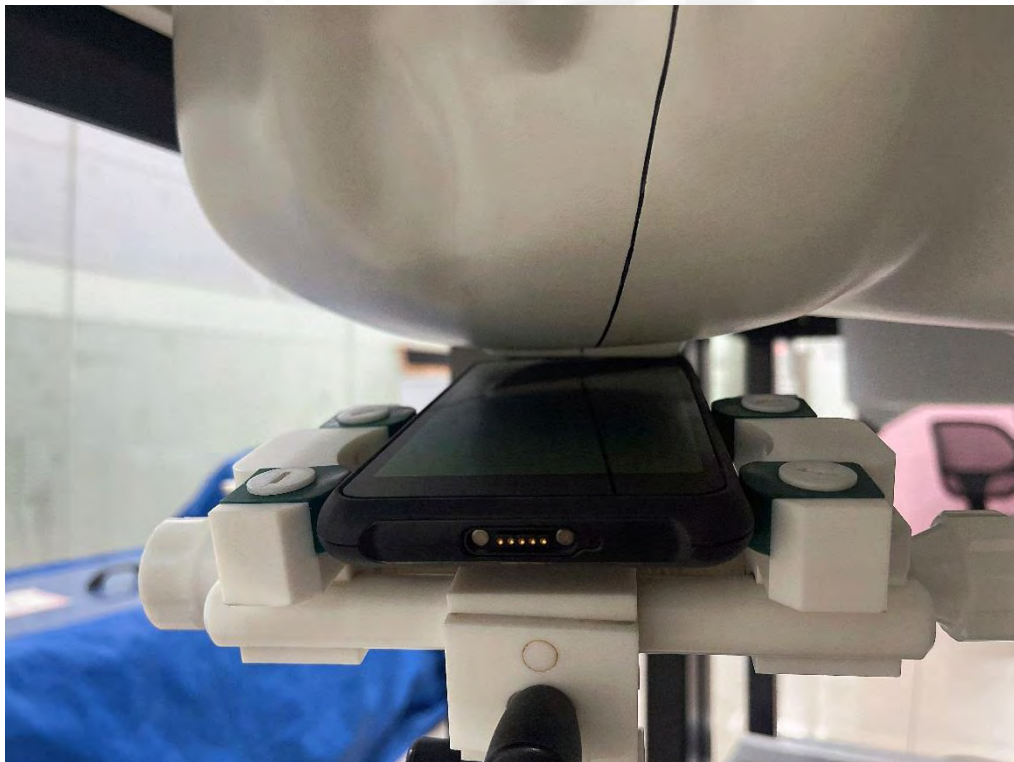

Left Touch

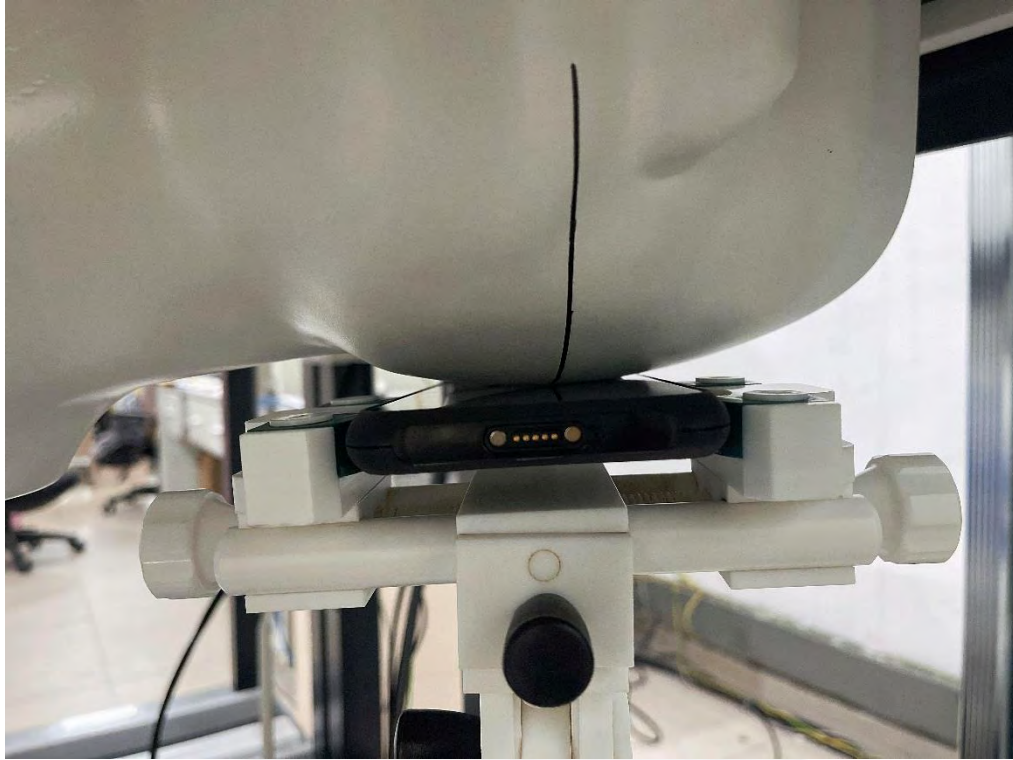

Left Tilt

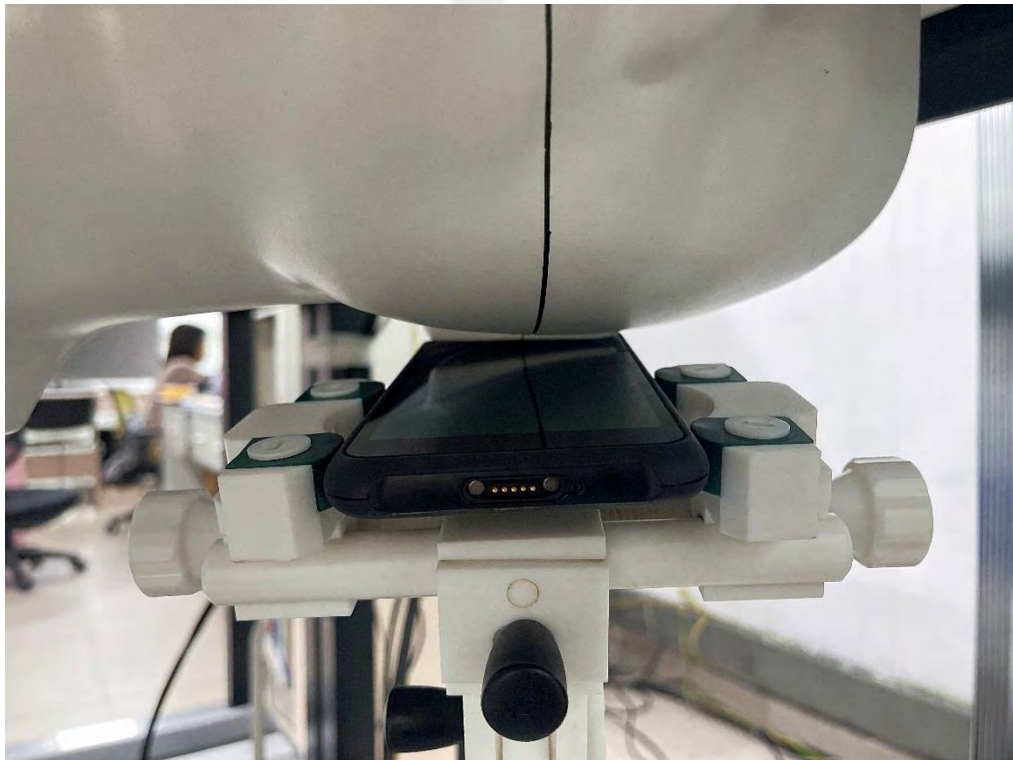

Body Front side(separation distance is 10mm)



Body Back side(separation distance is 10mm)



Body Left side(separation distance is 10mm)



Body Right side(separation distance is 10mm)





Body Bottom side(separation distance is 10mm)



Body Top side(separation distance is 10mm)



Liquid depth (15 cm)

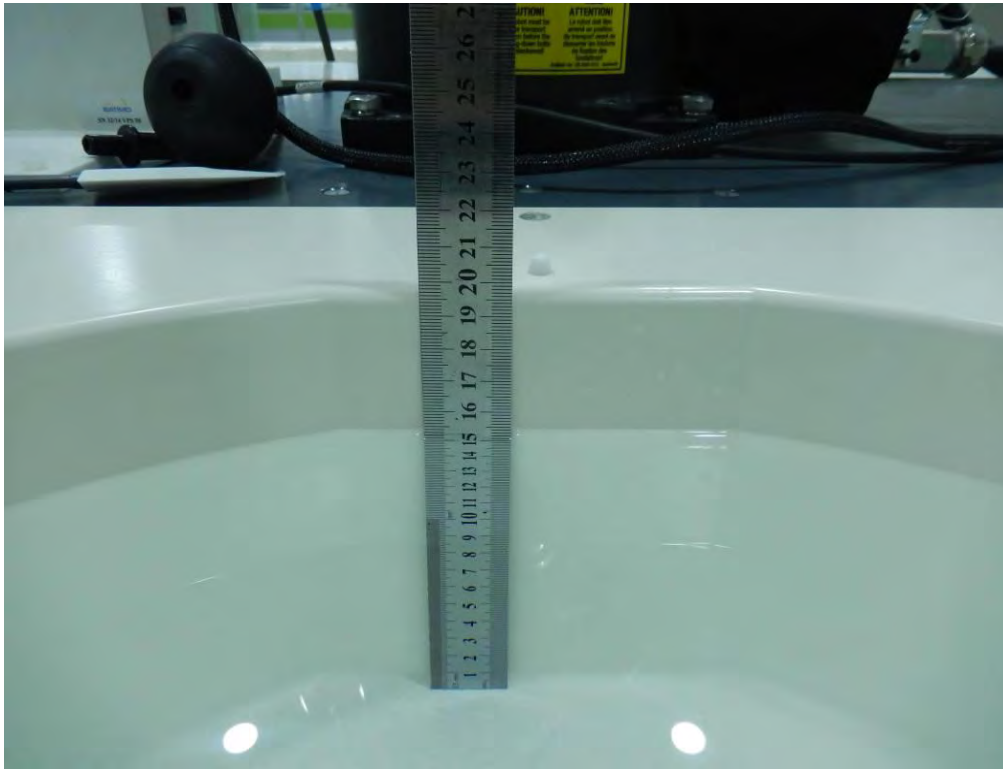



## 12. SAR Result Summary

### 12.1 Head SAR

Band	Model	Test Position	Freq.	SAR (1g) (W/kg)	Power Drift(%)	Max.Turn-up Power(dBm)	Meas.Output Power(dBm)	Scaled SAR (W/Kg)	Meas.No.
2.4G WLAN	802.11b	Right Cheek	2437	0.051	2.56	9.00	8.55	0.057	/
		Right Tilt	2437	0.107	-1.07	9.00	8.55	<b>0.119</b>	<b>1</b>
		Left Cheek	2437	0.066	-3.49	9.00	8.55	0.073	/
		Left Tilt	2437	0.076	0.80	9.00	8.55	0.084	/
5.2G WLAN	802.11ac-VHT40	Right Cheek	5190	0.421	-3.31	12.00	11.55	0.467	/
		Right Tilt	5190	0.515	-3.51	12.00	11.55	<b>0.571</b>	<b>3</b>
		Right Tilt	5230	0.454	3.92	12.00	11.04	0.566	/
		Left Cheek	5190	0.412	2.65	12.00	11.55	0.457	/
		Left Tilt	5190	0.495	-1.88	12.00	11.55	0.549	/
5.3G WLAN	802.11ac-VHT40	Right Cheek	5270	0.412	0.27	12.00	11.50	0.462	/
		Right Tilt	5270	0.491	-3.21	12.00	11.50	<b>0.551</b>	<b>5</b>
		Left Cheek	5270	0.399	-3.53	12.00	11.50	0.448	/
		Left Tilt	5270	0.484	-0.62	12.00	11.50	0.543	/
5.6G WLAN	802.11a20	Right Cheek	5700	0.241	-1.30	13.00	12.73	0.256	/
		Right Tilt	5700	0.274	-0.54	13.00	12.73	<b>0.292</b>	<b>7</b>
		Left Cheek	5700	0.231	0.40	13.00	12.73	0.246	/
		Left Tilt	5700	0.155	-1.74	13.00	12.73	0.165	/
BT	GFSK	Right Cheek	2480	0.022	2.03	3.50	3.38	0.023	/
		Right Tilt	2480	0.028	0.45	3.50	3.38	<b>0.029</b>	<b>9</b>
		Left Cheek	2480	0.021	-2.76	3.50	3.38	0.022	/
		Left Tilt	2480	0.025	1.97	3.50	3.38	0.026	/

**Note:**

1. Per KDB 447498 D04, the reported SAR is the measured SAR value adjusted for maximum tune-up tolerance.
  - a. Tune-up scaling Factor = tune-up limit power (mW) / EUT RF power (mW), where tune-up limit is the maximum rated power among all production units.
  - b. Scaled SAR(W/kg)= Measured SAR(W/kg)\*Tune-up Scaling Factor
2. Per KDB 248227- When the highest reported SAR for DSSS is adjusted by the ratio of OFDM to DSSS specified maximum output power and the adjusted SAR is  $\leq 1.2$  W/kg. (The highest reported SAR for DSSS is adjusted by the ratio of OFDM to DSSS specified maximum output power was **0.093** W/Kg for Head)
3. Per KDB 865664 D01, Repeated measurement is not required when the original highest measured SAR is <0.80 W/kg



**12.2 Body-worn and Hotspot SAR**

Band	Model	Test Position	Freq.	SAR (1g) (W/kg)	Power Drift(%)	Max.Turn-up Power(dBm)	Meas.Output Power(dBm)	Scaled SAR (W/Kg)	Meas.No.
2.4GHz WLAN	802.11b	Front Side	2437	0.014	3.88	9.00	8.55	0.016	/
		Back Side	2437	0.05	-1.41	9.00	8.55	<b>0.055</b>	<b>2</b>
		Top Edge	2437	0.022	0.18	9.00	8.55	0.024	/
5.2GHz WLAN	802.11ac-VHT40	Front Side	5190	0.099	-2.63	12.00	11.55	0.110	/
		Back Side	5190	0.133	-0.40	12.00	11.55	<b>0.148</b>	<b>4</b>
		Back Side	5230	0.102	-1.06	12.00	11.04	0.127	/
		Top Edge	5190	0.098	-3.33	12.00	11.55	0.109	/
5.3GHz WLAN	802.11ac-VHT40	Front Side	5270	0.088	-0.17	12.00	11.50	0.099	/
		Back Side	5270	0.109	-3.74	12.00	11.50	<b>0.122</b>	<b>6</b>
		Top Edge	5270	0.075	1.48	12.00	11.50	0.084	/
5.6GHz WLAN	802.11a20	Front Side	5700	0.045	2.77	13.00	12.73	0.048	/
		Back Side	5700	0.076	2.40	13.00	12.73	<b>0.081</b>	<b>8</b>
		Top Edge	5700	0.042	3.88	13.00	12.73	0.045	/
BT	GFSK	Front Side	2480	0.009	-1.14	3.50	3.38	0.009	/
		Back Side	2480	0.012	1.22	3.50	3.38	<b>0.012</b>	<b>10</b>
		Top Edge	2480	0.008	0.36	3.50	3.38	0.008	/

Note:

- The test separation of all above table is 10mm.
- Per KDB 447498 D04, the reported SAR is the measured SAR value adjusted for maximum tune-up tolerance.
  - Tune-up scaling Factor = tune-up limit power (mW) / EUT RF power (mW), where tune-up limit is the maximum rated power among all production units.
  - Scaled SAR(W/kg)= Measured SAR(W/kg)\*Tune-up Scaling Factor
- Per KDB 248227- When the highest reported SAR for DSSS is adjusted by the ratio of OFDM to DSSS specified maximum output power and the adjusted SAR is  $\leq 1.2$  W/kg. (The highest reported SAR for DSSS is adjusted by the ratio of OFDM to DSSS specified maximum output power was **0.043W/Kg** for Body)
- When the user enables the personal Wireless router functions for the handsets, actual operations include simultaneous transmission of both the Wi-Fi transmitting frequency and thus cannot be evaluated for SAR under actual use conditions. The "Portable Hotspot" feature on the handset was NOT activated, to ensure the SAR measurements were evaluated for a single transmission frequency RF signal.



### 13. Equipment List

Kind of Equipment	Manufacturer	Type No.	Serial No.	Last Calibration	Calibrated Until
2450MHzDipole	MVG	SID2450	SN 30/14 DIP2G450-335	2020.07.14	2023.07.13
Waveguide	MVG	SWG5500	SN 13/14 WGA32	2020.07.14	2023.07.13
E-Field Probe	MVG	SSE2	SN 07/21 EPMO352	2022.02.28	2023.02.27
Dielectric Probe Kit	MVG	SCLMP	SN 32/14 OCPG67	2021.11.23	2022.11.22
Antenna	MVG	ANTA3	SN 07/13 ZNTA52	N/A	N/A
Phantom1	MVG	SAM	SN 32/14 SAM115	N/A	N/A
Phantom2	MVG	SAM	SN 32/14 SAM116	N/A	N/A
Phone holder	MVG	N/A	SN 32/14 MSH97	N/A	N/A
Laptop holder	MVG	N/A	SN 32/14 LSH29	N/A	N/A
Attenuator	Agilent	99899	DC-18GHz	N/A	N/A
Directional coupler	Narda	4226-20	3305	N/A	N/A
Network Analyzer	Agilent	8753ES	US38432810	2021.09.29	2022.09.28
Multi Meter	Keithley	Multi Meter 2000	4050073	2021.10.08	2022.10.07
Signal Generator	Agilent	N5182A	MY50140530	2021.09.30	2022.09.29
Wireless Communication Test Set	Agilent	8960-E5515C	MY48360751	2021.09.30	2022.09.29
Wireless Communication Test Set	R&S	CMW500	117239	2021.09.30	2022.09.29
Power Amplifier	DESAY	ZHL-42W	9638	2021.10.09	2022.10.08
Power Meter	R&S	NRP	100510	2021.09.29	2022.09.28
Power Sensor	R&S	NRP-Z11	101919	2021.09.29	2022.09.28
Temperature hygrometer	SuWei	SW-108	N/A	2021.10.09	2022.10.08
Thermograph	Elitech	RC-4	S/N EF7176501537	2021.10.09	2022.10.08

Note:

Per KDB 865664 D01, Dipole SAR Validation Verification, STS LAB has adopted 3 years calibration intervals. On annual basis, every measurement dipole has been evaluated and is in compliance with the following criteria:

1. There is no physical damage on the dipole
2. System validation with specific dipole is within 10% of calibrated value Return-loss in within 20% of calibrated measurement

## Appendix A. System Validation Plots

### System Performance Check Data (2450MHz)

Type: Phone measurement (Complete)  
 Area scan resolution: dx=8mm, dy=8mm  
 Zoom scan resolution: dx=8mm, dy=8mm, dz=5mm  
 Date of measurement: 2022-04-11

#### Experimental conditions.

Device Position	Validation plane
Band	2450 MHz
Channels	-
Signal	CW
Frequency (MHz)	2450
Relative permittivity	39.46
Conductivity (S/m)	1.82
Probe	SN 07/21 EPGO352
ConvF	1.75
Crest factor:	1:1

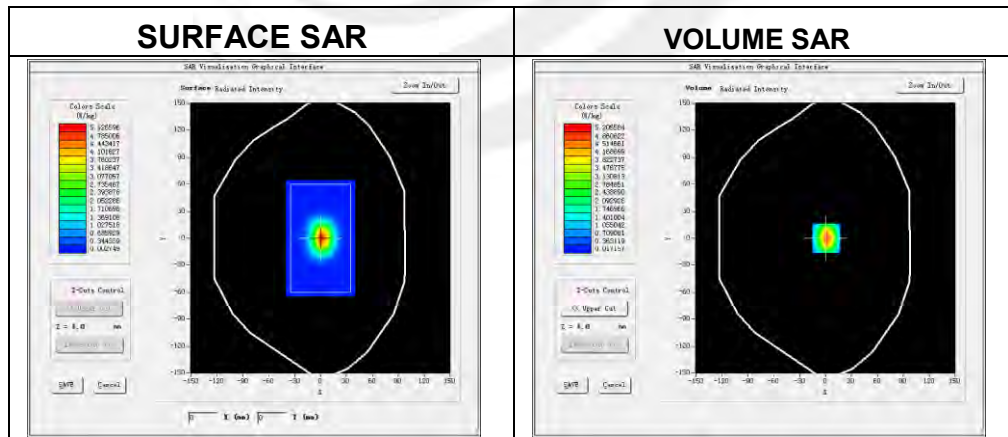

Maximum location: X=1.00, Y=0.00

SAR 10g (W/Kg)	2.390567
SAR 1g (W/Kg)	5.449394

### Z Axis Scan

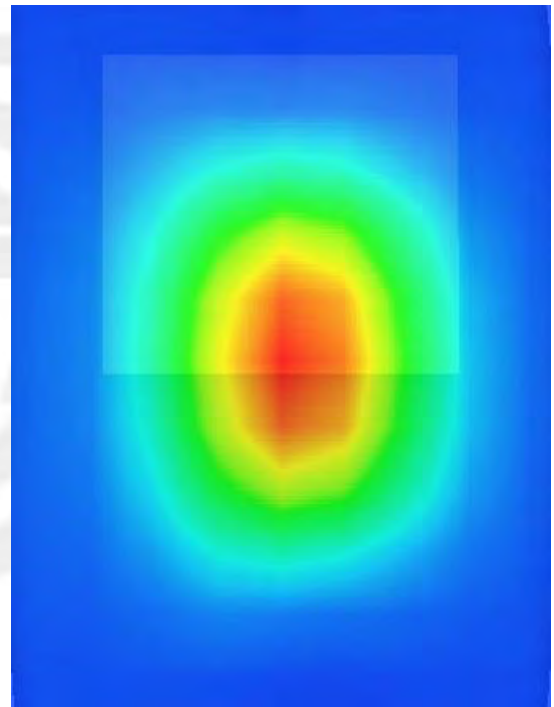
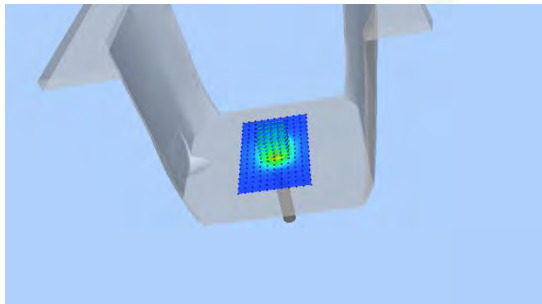
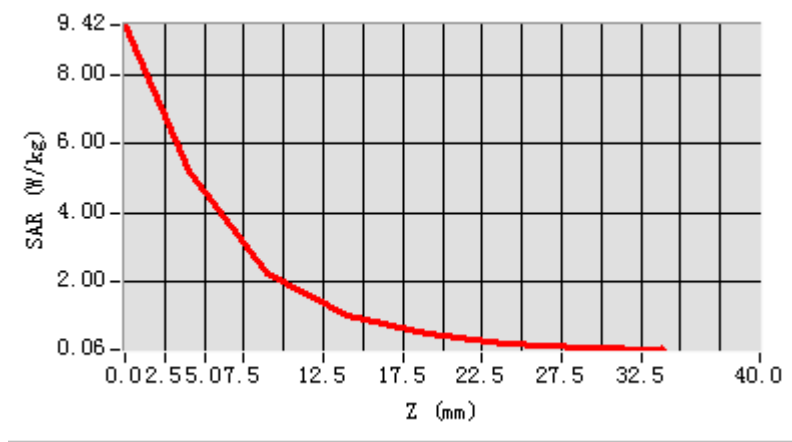

### System Performance Check Data (5200MHz)

Type: Dipole measurement (Complete)

Area scan resolution: dx=8mm,dy=8mm

Zoom scan resolution: dx=4mm, dy=4mm, dz=2mm

Date of measurement: 2022-04-12

### Experimental conditions.

Device Position	Validation plane
Band	5200 MHz
Channels	-
Signal	CW
Frequency (MHz)	5200
Relative permittivity	34.57
Conductivity (S/m)	4.62
Probe	SN 07/21 EPGO352
ConvF	1.65
Crest factor:	1:1

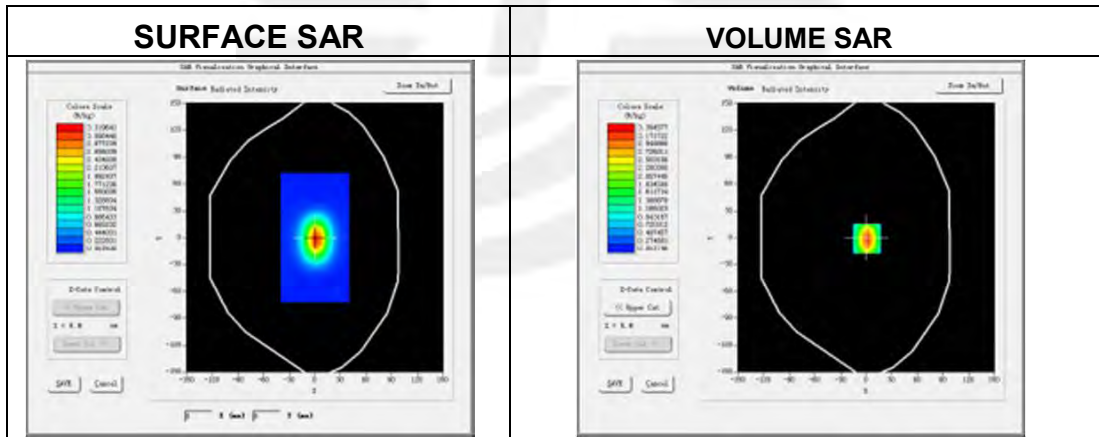

Maximum location: X=7.00, Y=2.00

SAR 10g (W/Kg)	5.651155
SAR 1g (W/Kg)	15.843035



### Z Axis Scan

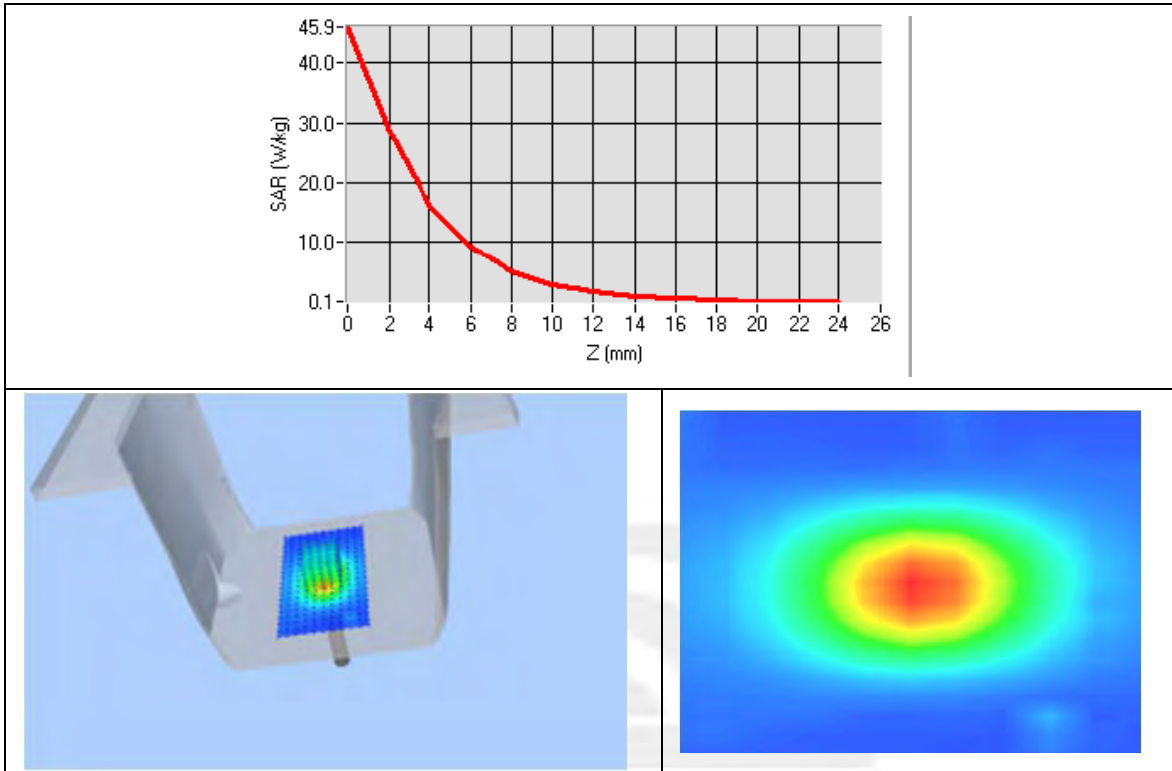

### System Performance Check Data (5300MHz)

Type: Dipole measurement (Complete)

Area scan resolution: dx=8mm,dy=8mm

Zoom scan resolution: dx=8mm, dy=8mm, dz=5mm

Date of measurement: 2022-04-13

### Experimental conditions.

Device Position	Validation plane
Band	5300 MHz
Channels	-
Signal	CW
Frequency (MHz)	5300
Relative permittivity	34.79
Conductivity (S/m)	4.79
Probe	SN 07/21 EPGO352
ConvF	1.64
Crest factor:	1:1

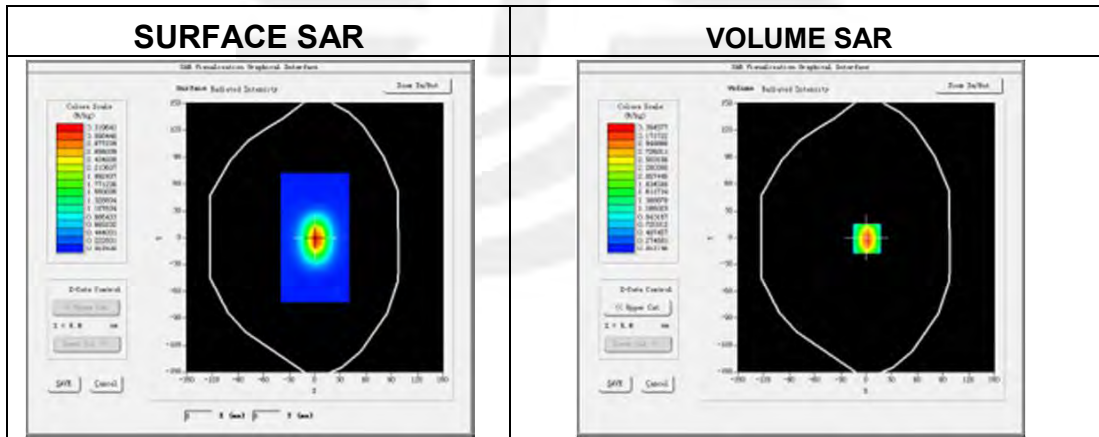

Maximum location: X=7.00, Y=2.00

SAR 10g (W/Kg)	6.154551
SAR 1g (W/Kg)	16.718196

### Z Axis Scan

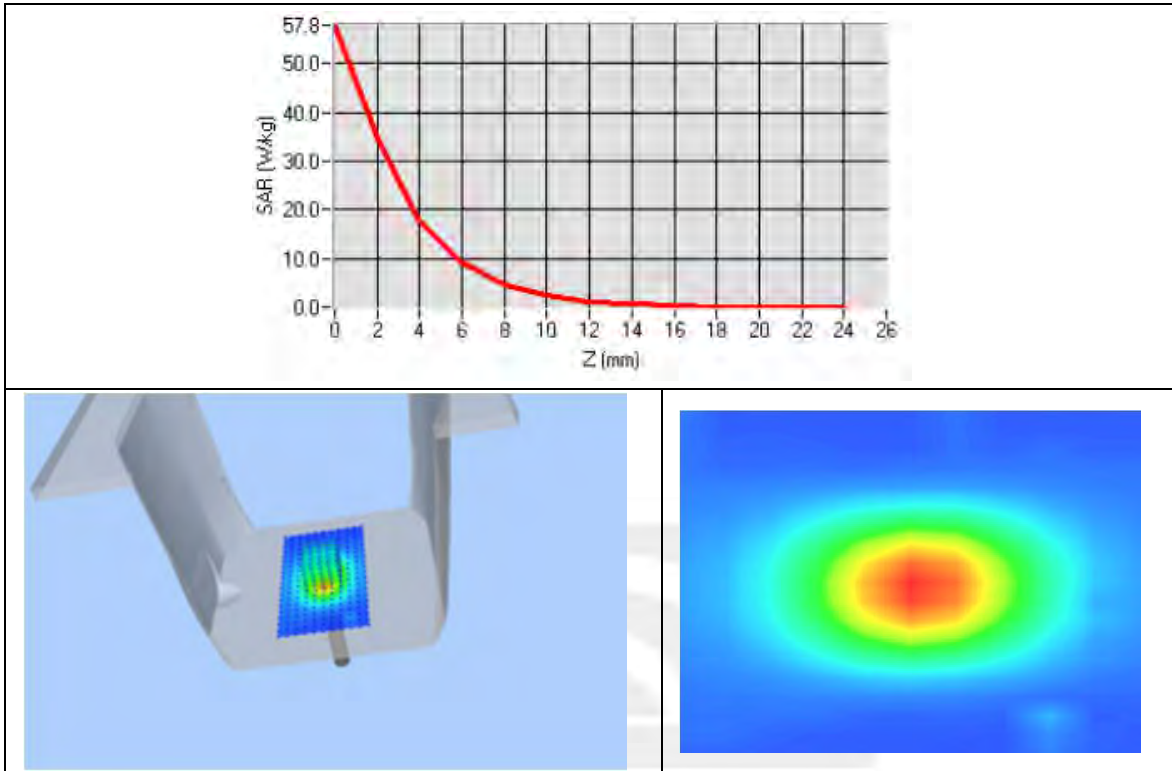

### System Performance Check Data (5600MHz)

Type: Dipole measurement (Complete)

Area scan resolution: dx=8mm,dy=8mm

Zoom scan resolution: dx=8mm, dy=8mm, dz=5mm

Date of measurement: 2022-04-14

### Experimental conditions.

Device Position	Validation plane
Band	5600 MHz
Channels	-
Signal	CW
Frequency (MHz)	5600
Relative permittivity	36.26
Conductivity (S/m)	5.09
Probe	SN 07/21 EPGO352
ConvF	1.64
Crest factor:	1:1

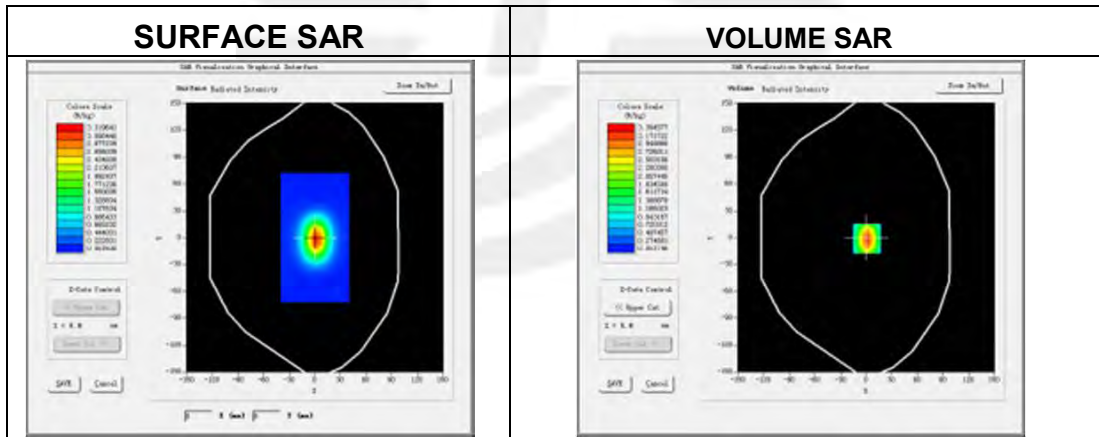

Maximum location: X=7.00, Y=2.00

SAR 10g (W/Kg)	5.681092
SAR 1g (W/Kg)	17.560538

### Z Axis Scan

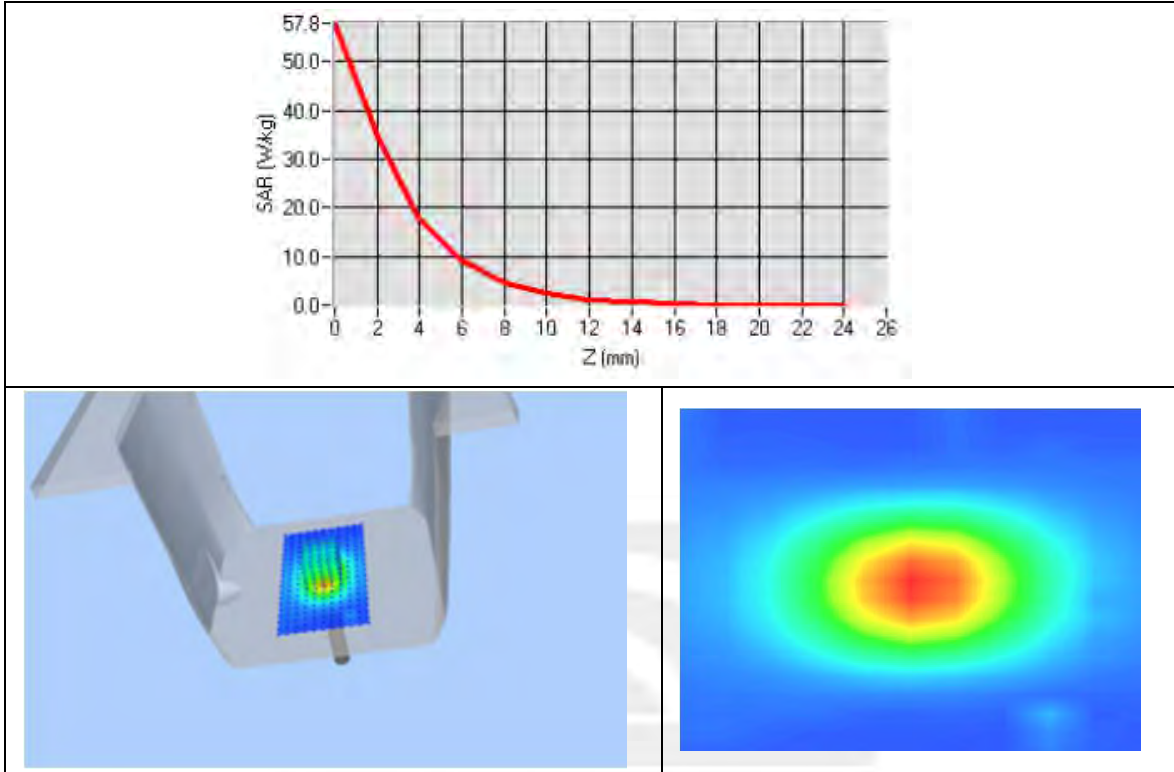

## Appendix B. SAR Test Plots

### Plot 1: DUT: Pixavi Cam; EUT Model: Pixavi Cam

Test Date	2022-04-11
Probe	SN 07/21 EPGO352
Area Scan	dx=8mm, dy=8mm, h= 5.00 mm
Zoom Scan	5x5x7, dx=8mm, dy=8mm, dz=5mm, Complete/ndx=8mm, dy=8mm, h= 5.00 mm
Phantom	Right Tilt
Device Position	Tilt
Band	IEEE 802.11b ISM
Signal	IEEE802.b (Crest factor: 1.0)
Frequency (MHz)	2437
Relative permittivity (real part)	38.53
Conductivity (S/m)	1.74

Maximum location: X=-16.00, Y=-7.00

SAR Peak: 0.19 W/kg

SAR 10g (W/Kg)	0.052611
SAR 1g (W/Kg)	0.107242

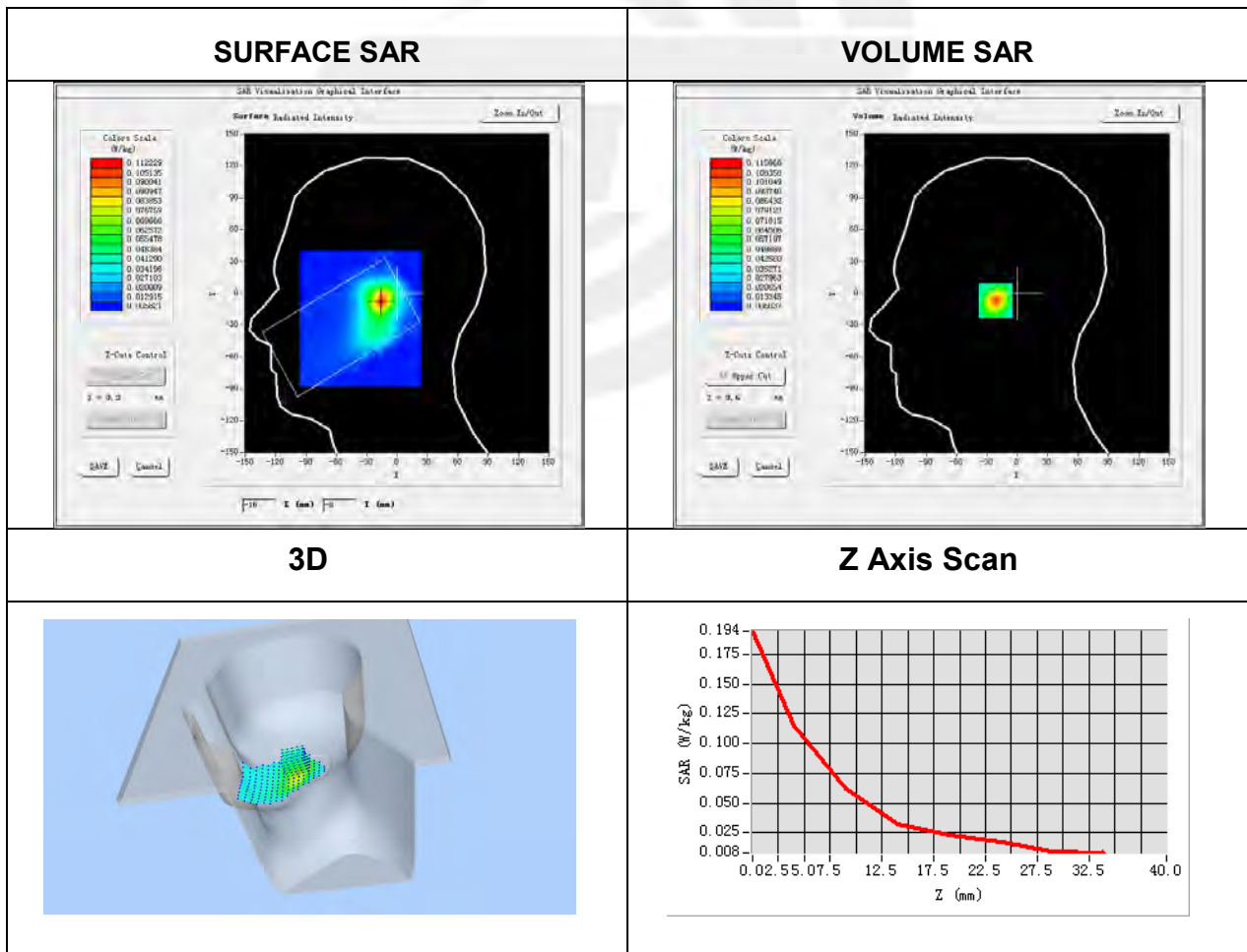

**Plot 2: DUT: Pixavi Cam; EUT Model: Pixavi Cam**

Test Date	2022-04-11
Probe	SN 07/21 EPGO352
Area Scan	dx=8mm, dy=8mm, h= 5.00 mm
Zoom Scan	5x5x7, dx=8mm, dy=8mm, dz=5mm, Complete/ndx=8mm, dy=8mm, h= 5.00 mm
Phantom	Validation plane
Device Position	Back Side
Band	IEEE 802.11b ISM
Signal	IEEE802.b (Crest factor: 1.0)
Frequency (MHz)	2437
Relative permittivity (real part)	38.53
Conductivity (S/m)	1.74

Maximum location: X=-3.00, Y=0.00

SAR Peak: 0.08 W/kg

SAR 10g (W/Kg)	0.033019
SAR 1g (W/Kg)	0.050021

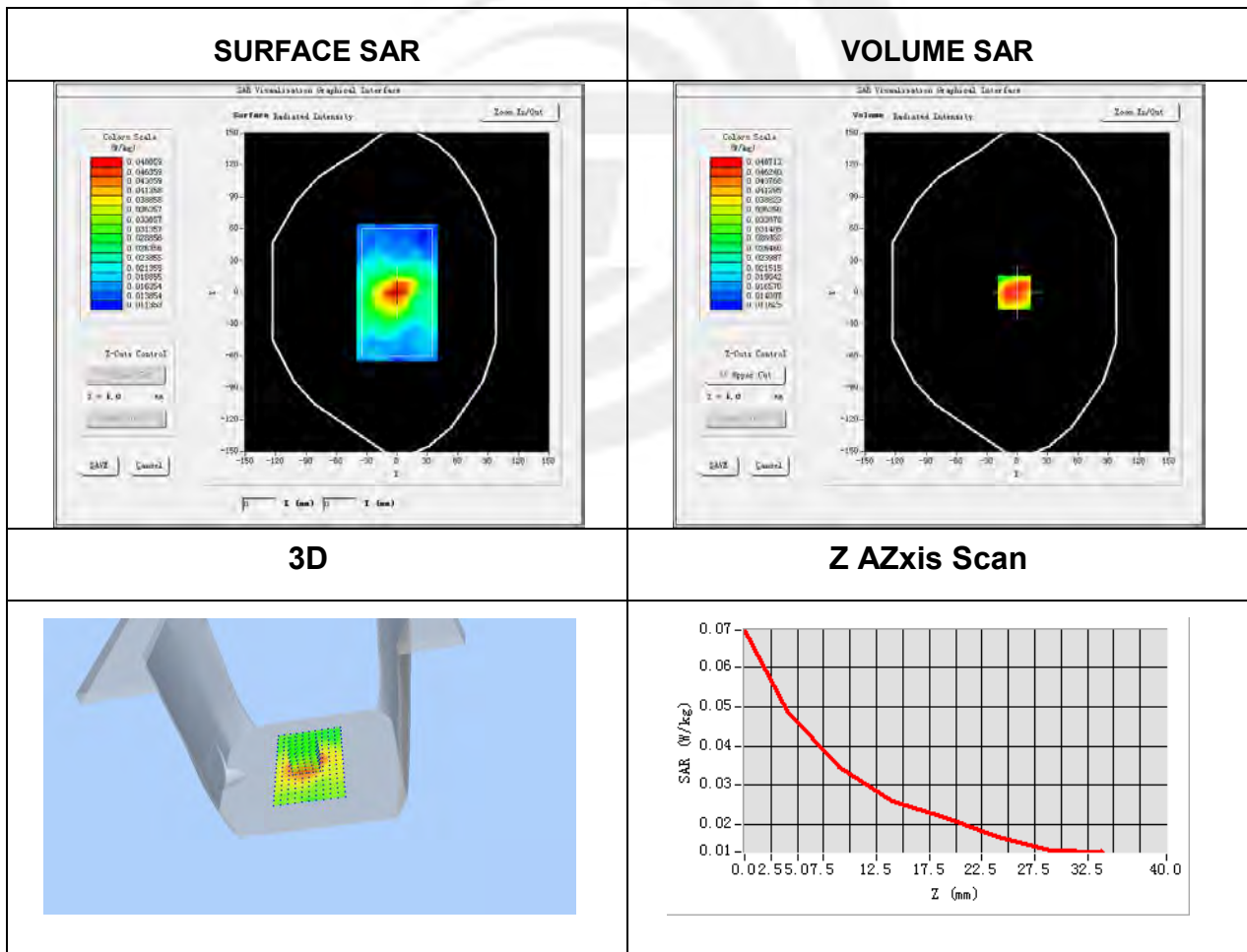

**Plot 3: DUT: Pixavi Cam; EUT Model: Pixavi Cam**

Test Date	2022-04-12
Probe	SN 07/21 EPGO352
Area Scan	dx=8mm, dy=8mm, h= 5.00 mm
Zoom Scan	7x7x12, dx=4mm, dy=4mm, dz=2mm, Complete/ndx=8mm, dy=8mm, h= 5.00 mm
Phantom	Right Tilt
Device Position	Tilt
Band	802.11ac-VHT40
Signal	IEEE802.a (Crest factor: 1.0)
Frequency (MHz)	5190
Relative permittivity (real part)	35.78

Maximum location: X=-14.00, Y=2.00

SAR Peak: 1.42 W/kg

SAR 10g (W/Kg)	0.164080
SAR 1g (W/Kg)	0.515241

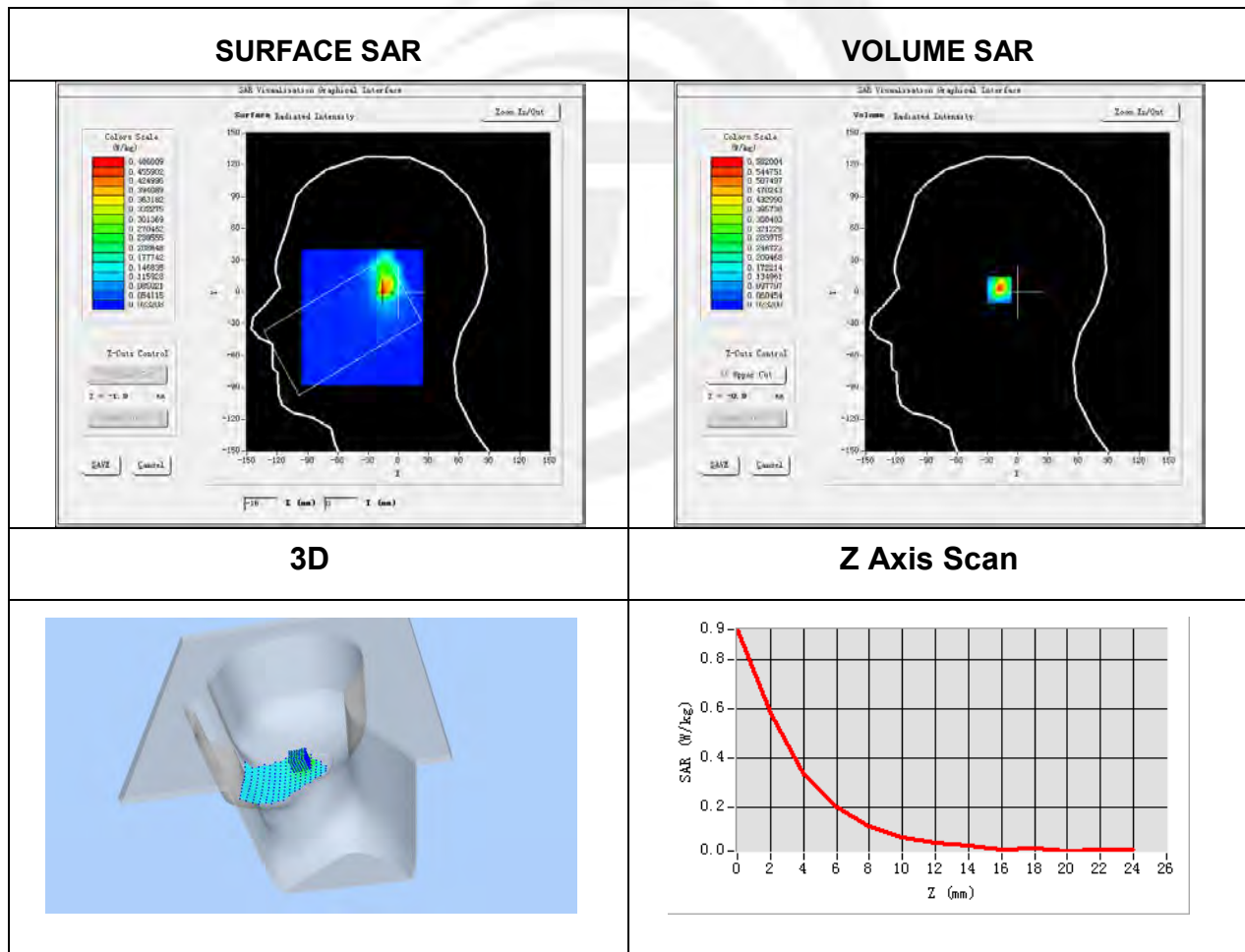



**Plot 4: DUT: Pixavi Cam; EUT Model: Pixavi Cam**

Test Date	2022-04-12
Probe	SN 07/21 EPGO352
Area Scan	dx=8mm, dy=8mm, h= 5.00 mm
Zoom Scan	7x7x12, dx=4mm, dy=4mm, dz=2mm, Complete/ndx=8mm, dy=8mm, h= 5.00 mm
Phantom	Validation plane
Device Position	Back Side
Band	802.11ac-VHT40
Signal	IEEE802.a (Crest factor: 1.0)
Frequency (MHz)	5190
Relative permittivity (real part)	35.78
Conductivity (S/m)	4.63

Maximum location: X=22.00, Y=5.00

SAR Peak: 0.28 W/kg

SAR 10g (W/Kg)	0.072802
SAR 1g (W/Kg)	0.132856

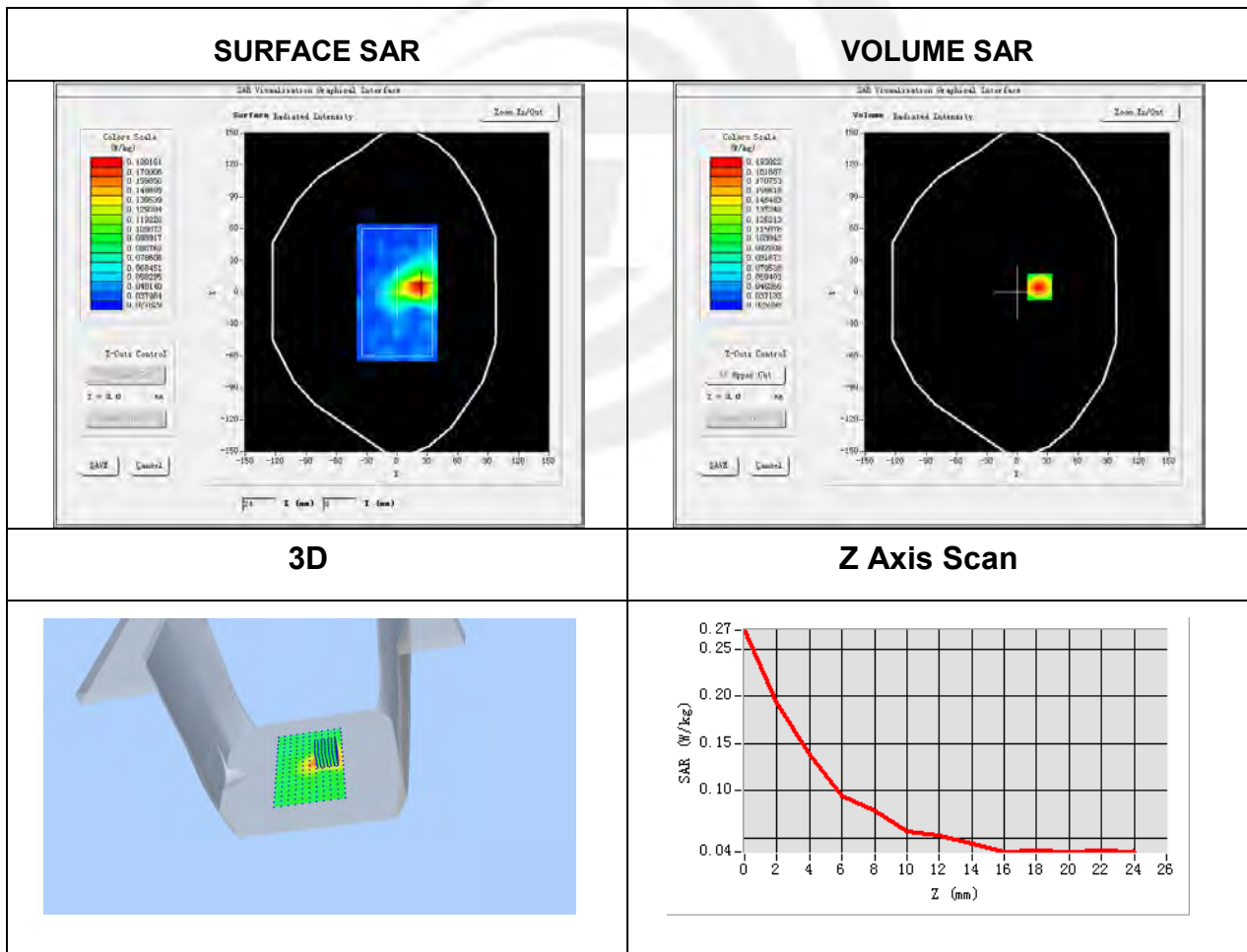

**Plot 5: DUT: Pixavi Cam; EUT Model: Pixavi Cam**

Test Date	2022-04-13
Probe	SN 07/21 EPGO352
Area Scan	dx=8mm, dy=8mm, h= 5.00 mm
Zoom Scan	7x7x12, dx=4mm, dy=4mm, dz=2mm, Complete/ndx=8mm, dy=8mm, h= 5.00 mm
Phantom	Right Tilt
Device Position	Tilt
Band	802.11ac-VHT40
Signal	IEEE802.a (Crest factor: 1.0)
Frequency (MHz)	5270
Relative permittivity (real part)	36.04
Conductivity (S/m)	4.67

Maximum location: X=-14.00, Y=6.00  
SAR Peak: 1.34 W/kg

SAR 10g (W/Kg)	0.158485
SAR 1g (W/Kg)	0.490667

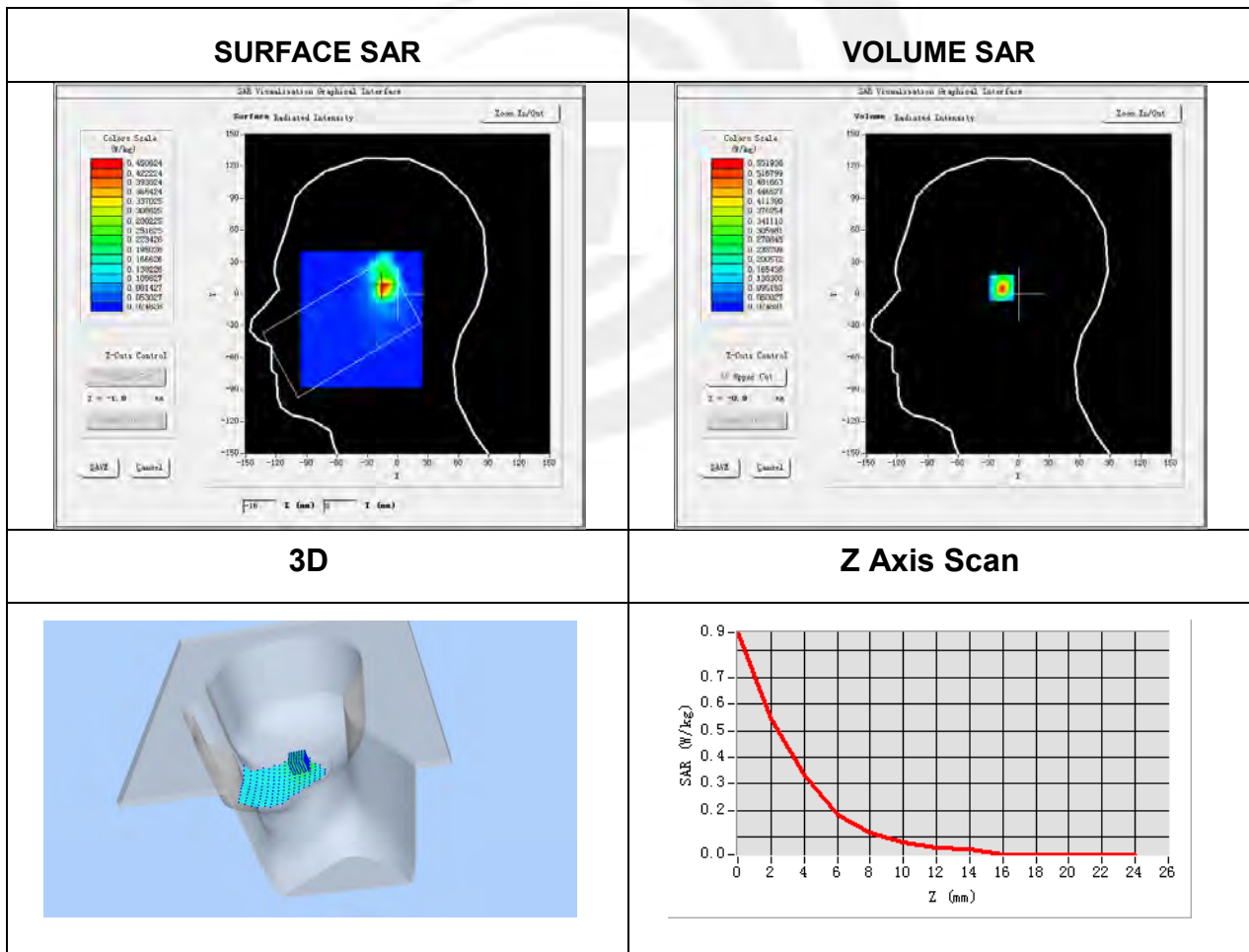

**Plot 6: DUT: Pixavi Cam; EUT Model: Pixavi Cam**

Test Date	2022-04-13
Probe	SN 07/21 EPGO352
Area Scan	dx=8mm, dy=8mm, h= 5.00 mm
Zoom Scan	7x7x12, dx=4mm, dy=4mm, dz=2mm, Complete/ndx=8mm, dy=8mm, h= 5.00 mm
Phantom	Validation plane
Device Position	Back Side
Band	802.11ac-VHT40
Signal	IEEE802.a (Crest factor: 1.0)
Frequency (MHz)	5270
Relative permittivity (real part)	36.04
Conductivity (S/m)	4.67

Maximum location: X=16.00, Y=24.00

SAR Peak: 0.23 W/kg

SAR 10g (W/Kg)	0.062000
SAR 1g (W/Kg)	0.108969

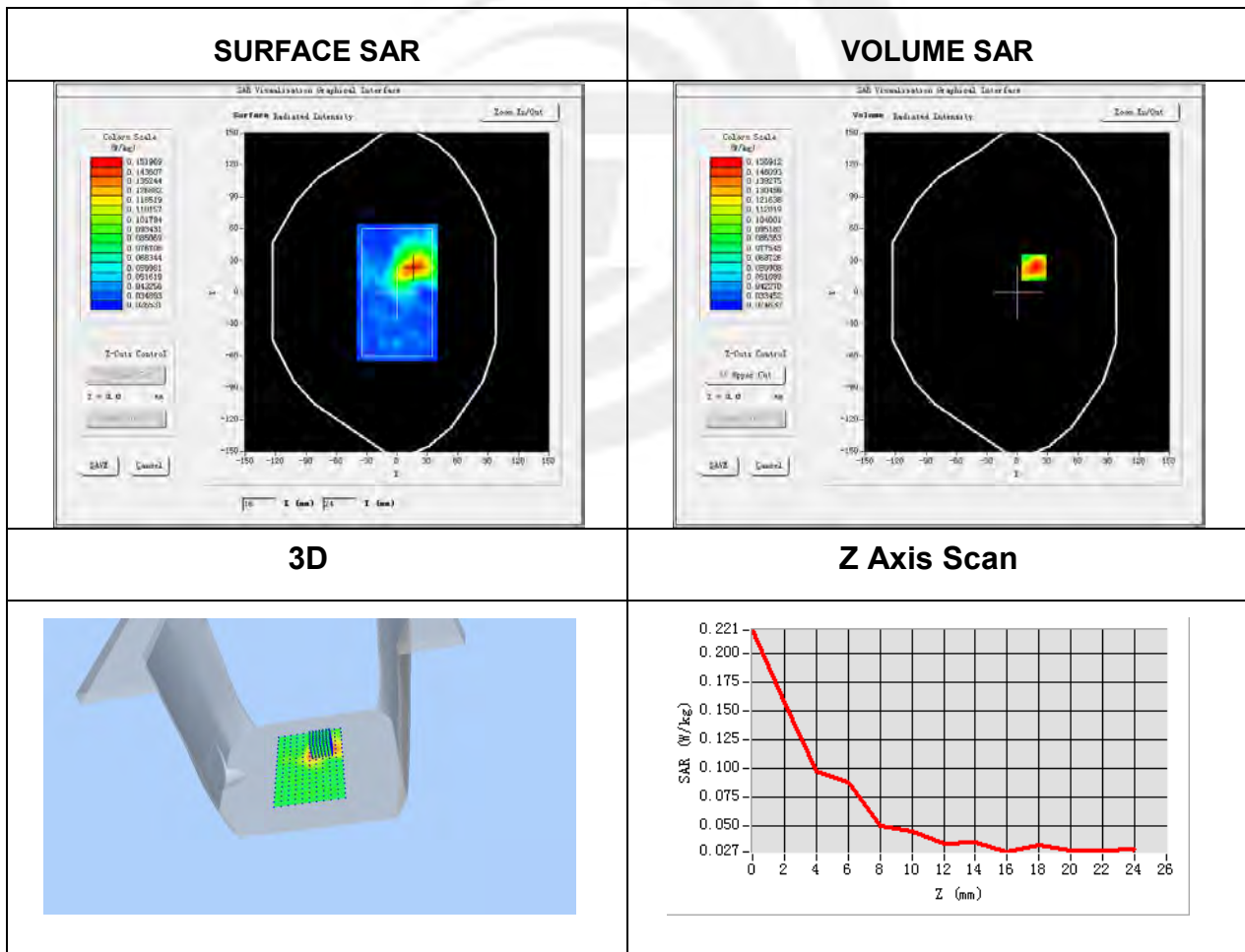

**Plot 7: DUT: Pixavi Cam; EUT Model: Pixavi Cam**

Test Date	2022-04-14
Probe	SN 07/21 EPGO352
Area Scan	dx=8mm, dy=8mm, h= 5.00 mm
Zoom Scan	7x7x12, dx=4mm, dy=4mm, dz=2mm, Complete/ndx=8mm, dy=8mm, h= 5.00 mm
Phantom	Right Tilt
Device Position	Tilt
Band	802.11a20
Signal	IEEE802.a (Crest factor: 1.0)
Frequency (MHz)	5700
Relative permittivity (real part)	36.38
Conductivity (S/m)	5.20

Maximum location: X=-16.00, Y=7.00  
SAR Peak: 0.70 W/kg

SAR 10g (W/Kg)	0.109374
SAR 1g (W/Kg)	0.273687

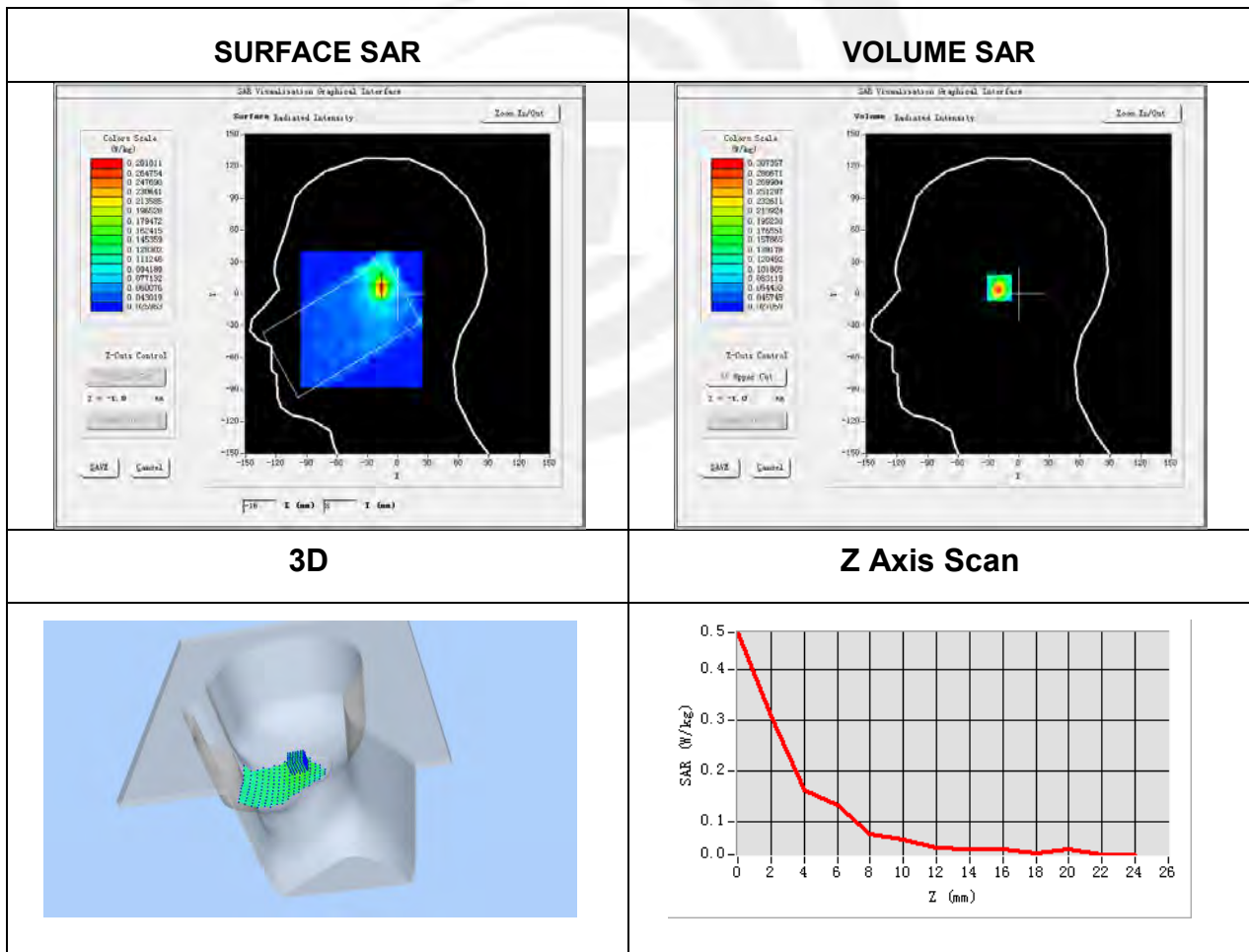

**Plot 8: DUT: Pixavi Cam; EUT Model: Pixavi Cam**

Test Date	2022-04-14
Probe	SN 07/21 EPGO352
Area Scan	dx=8mm, dy=8mm, h= 5.00 mm
Zoom Scan	7x7x12, dx=4mm, dy=4mm, dz=2mm, Complete/ndx=8mm, dy=8mm, h= 5.00 mm
Phantom	Validation plane
Device Position	Back Side
Band	802.11a20
Signal	IEEE802.a (Crest factor: 1.0)
Frequency (MHz)	5700
Relative permittivity (real part)	36.38
Conductivity (S/m)	5.20

Maximum location: X=-31.00, Y=-25.00

SAR Peak: 0.18 W/kg

SAR 10g (W/Kg)	0.049177
SAR 1g (W/Kg)	0.075513

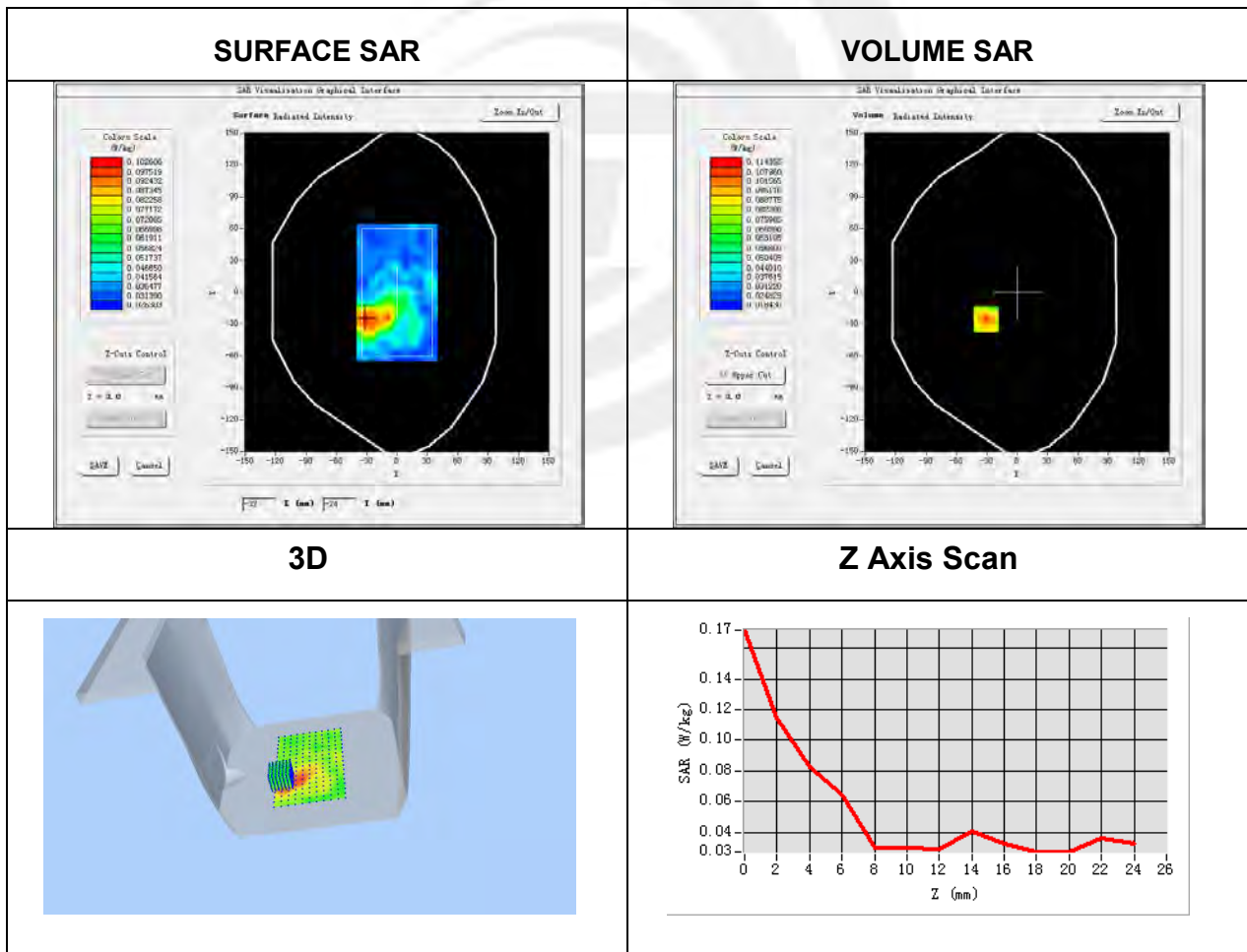

**Plot 9: DUT: Pixavi Cam; EUT Model: Pixavi Cam**

Test Date	2022-04-11
Probe	SN 07/21 EPGO352
Area Scan	dx=8mm, dy=8mm, h= 5.00 mm
Zoom Scan	5x5x7, dx=8mm, dy=8mm, dz=5mm, Complete/ndx=8mm, dy=8mm, h= 5.00 mm
Phantom	Right Tilt
Device Position	Tilt
Band	BT
Signal	GFSK (Crest factor: 1.0)
Frequency (MHz)	2480
Relative permittivity (real part)	39.15
Conductivity (S/m)	1.75

Maximum location: X=8.00, Y=-7.00  
SAR Peak: 0.05 W/kg

SAR 10g (W/Kg)	0.016369
SAR 1g (W/Kg)	0.027558

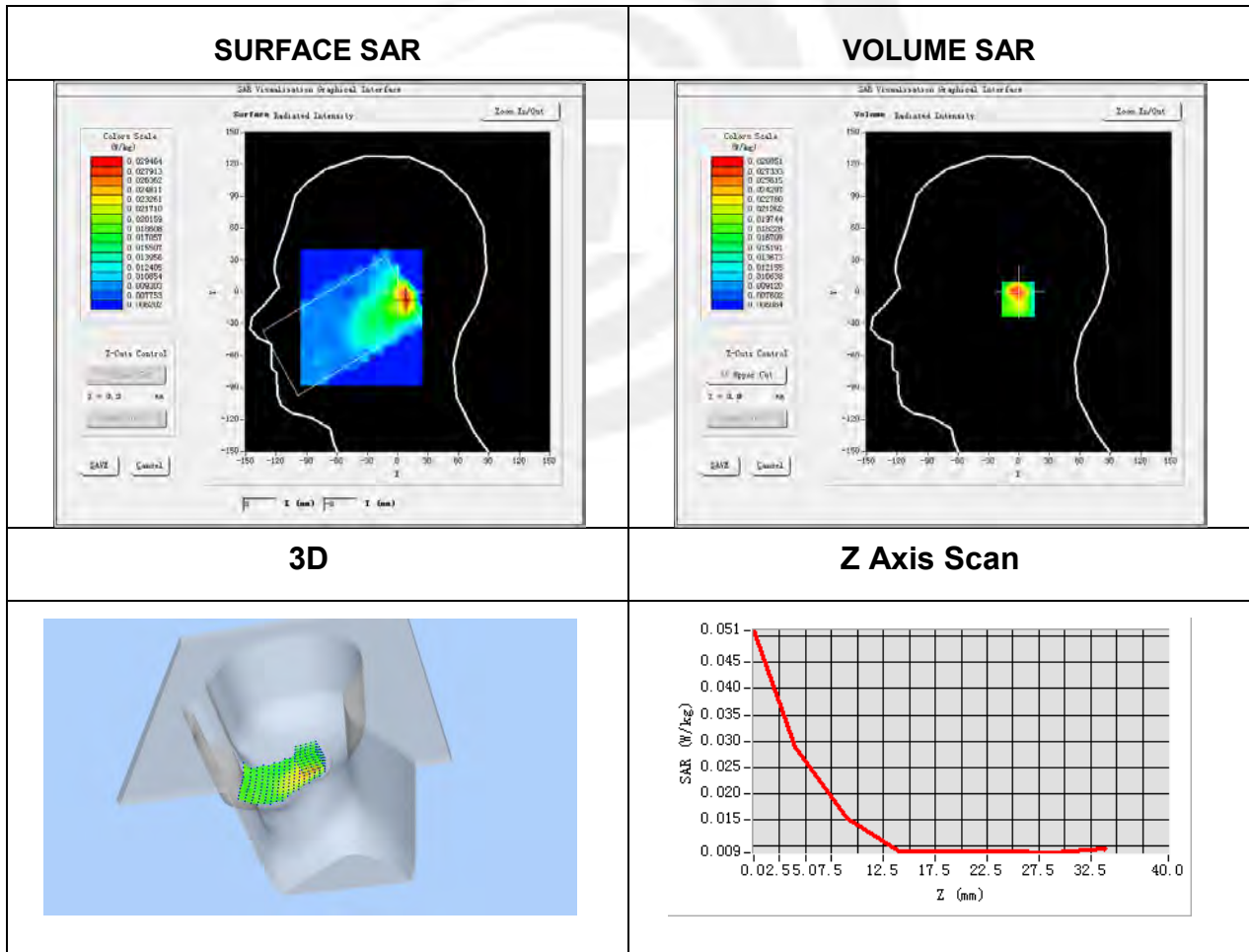

**Plot 10: DUT: Pixavi Cam; EUT Model: Pixavi Cam**

Test Date	2022-04-11
Probe	SN 07/21 EPGO352
Area Scan	dx=8mm, dy=8mm, h= 5.00 mm
Zoom Scan	5x5x7, dx=8mm, dy=8mm, dz=5mm, Complete/ndx=8mm, dy=8mm, h= 5.00 mm
Phantom	Validation plane
Device Position	Back Side
Band	BT
Signal	GFSK (Crest factor: 1.0)
Frequency (MHz)	2480
Relative permittivity (real part)	39.15
Conductivity (S/m)	1.75

Maximum location: X=-6.00, Y=9.00

SAR Peak: 0.03 W/kg

SAR 10g (W/Kg)	0.009104
SAR 1g (W/Kg)	0.011766

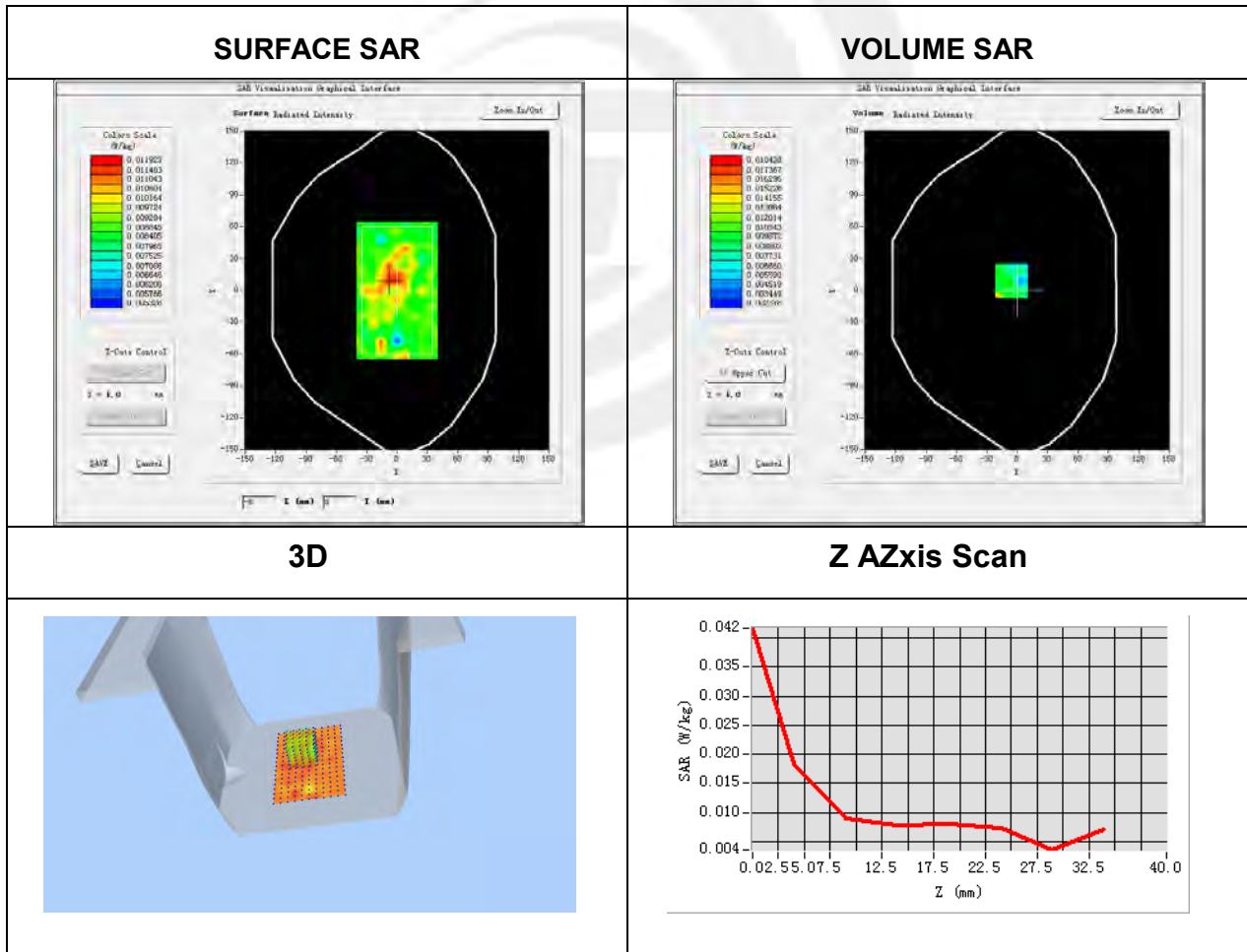



## Appendix C. Probe Calibration and Dipole Calibration Report

Refer the appendix Calibration Report.

※※※※END OF THE REPORT※※※※

