



FCC 47 CFR PART 15 SUBPART C

TEST REPORT

For

T36 one way transmitter

Model: T36

Trade Name: PORTMAN

Issued to

**PORTMAN ELECTRONICS (DONGGUAN) CO., LTD.
NO#10 , Luyi 2 Road, Keyuancheng, Tangxia Town,
Dongguan City, Guangdong Province, China**

Issued by

**Compliance Certification Services Inc.
No. 11, Wu-Gong 6th Rd., Wugu Industrial Park,
Taipei Hsien 248, Taiwan (R.O.C.)
<http://www.ccsrf.com>
service@ccsrf.com**



Note: This report shall not be reproduced except in full, without the written approval of Compliance Certification Services Inc. This document may be altered or revised by Compliance Certification Services Inc. personnel only, and shall be noted in the revision section of the document.



TABLE OF CONTENTS

- 1. TEST RESULT CERTIFICATION.....3**
- 2. EUT DESCRIPTION4**
- 3. TEST METHODOLOGY5**
 - 3.1 EUT CONFIGURATION5
 - 3.2 EUT EXERCISE.....5
 - 3.3 GENERAL TEST PROCEDURES.....5
 - 3.4 FCC PART 15.205 RESTRICTED BANDS OF OPERATIONS.....6
 - 3.5 DESCRIPTION OF TEST MODES7
- 4. INSTRUMENT CALIBRATION.....8**
 - 4.1 MEASURING INSTRUMENT CALIBRATION8
 - 4.2 MEASUREMENT EQUIPMENT USED8
 - 4.3 MEASUREMENT UNCERTAINTY8
- 5. FACILITIES AND ACCREDITATIONS9**
 - 5.1 FACILITIES9
 - 5.2 EQUIPMENT.....9
 - 5.3 TABLE OF ACCREDITATIONS AND LISTINGS.....10
- 6. SETUP OF EQUIPMENT UNDER TEST11**
 - 6.1 SETUP CONFIGURATION OF EUT.....11
 - 6.2 SUPPORT EQUIPMENT11
- 7. FCC PART 15.247 REQUIREMENTS.....12**
 - 7.1 20 DB BANDWIDTH.....12
 - 7.2 PEAK POWER.....15
 - 7.3 AVERAGE POWER16
 - 7.4 BAND EDGES MEASUREMENT17
 - 7.5 FREQUENCY SEPARATION18
 - 7.6 NUMBER OF HOPPING FREQUENCY.....20
 - 7.7 TIME OF OCCUPANCY (DWELL TIME)22
 - 7.8 SPURIOUS EMISSIONS24
 - 7.9 POWERLINE CONDUCTED EMISSIONS.....36
- APPENDIX I PHOTOGRAPHS OF TEST SETUP.....37**



1. TEST RESULT CERTIFICATION

Applicant: PORTMAN ELECTRONICS (DONGGUAN) CO., LTD.
NO#10 , Luyi 2 Road, Keyuancheng, Tangxia Town,
Dongguan City, Guangdong Province, China

Equipment Under Test: T36 one way transmitter

Trade Name: PORTMAN

Model: T36

Date of Test: February 16 ~ March 16, 2010

APPLICABLE STANDARDS	
STANDARD	TEST RESULT
FCC 47 CFR Part 15 Subpart C	No non-compliance noted

We hereby certify that:

The above equipment was tested by Compliance Certification Services Inc. The test data, data evaluation, test procedures, and equipment configurations shown in this report were made in accordance with the procedures given in **ANSI C63.4: 2003** and the energy emitted by the sample EUT tested as described in this report is in compliance with the requirements of FCC Rules Part 15.207, 15.209, 15.247.

The test results of this report relate only to the tested sample EUT identified in this report.

Approved by:

Reviewed by:

Rex Lai
Section Manager
Compliance Certification Services Inc.

Gina Lo
Section Manager
Compliance Certification Services Inc.



2. EUT DESCRIPTION

Product	T36 one way transmitter
Trade Name	PORTMAN
Model Number	T36
Model Discrepancy	N/A
Power Supply	Mercury Battery: 6V (DC3V x2)
Frequency Range	910 ~ 918.4 MHz
Transmit Power	7.96 dBm
Modulation Technique	FSK
Number of Channels	25 Channels
Channels Spacing	350kHz
Antenna Specification	Gain: 5.14dBi
Antenna Designation	Coil Antenna

Remark:

1. The sample selected for test was production product and was provided by manufacturer.
2. This submittal(s) (test report) is intended for FCC ID: **TBOT36-915** filing to comply with Section 15.207, 15.209 and 15.247 of the FCC Part 15, Subpart C Rules..



3. TEST METHODOLOGY

The tests documented in this report were performed in accordance with ANSI C63.4: 2003 and FCC CFR 47 Part 15.207, 15.209 and 15.247.

3.1 EUT CONFIGURATION

The EUT configuration for testing is installed on RF field strength measurement to meet the Commissions requirement and operating in a manner that intends to maximize its emission characteristics in a continuous normal application.

3.2 EUT EXERCISE

The EUT was operated in the engineering mode to fix the TX frequency that was for the purpose of the measurements.

According to its specifications, the EUT must comply with the requirements of the Section 15.207, 15.209 and 15.247 under the FCC Rules Part 15 Subpart C.

3.3 GENERAL TEST PROCEDURES

Conducted Emissions

The EUT is placed on the turntable, which is 0.8 m above ground plane. According to the requirements in Section 13.1.4.1 of ANSI C63.4: 2003 Conducted emissions from the EUT measured in the frequency range between 0.15 MHz and 30MHz using CISPR Quasi-peak and average detector modes.

Radiated Emissions

The EUT is placed on a turn table, which is 0.8 m above ground plane. The turntable shall rotate 360 degrees to determine the position of maximum emission level. EUT is set 3m away from the receiving antenna, which varied from 1m to 4m to find out the highest emission. And also, each emission was to be maximized by changing the polarization of receiving antenna both horizontal and vertical. In order to find out the maximum emissions, exploratory radiated emission measurements were made according to the requirements in Section 13.1.4.1 of ANSI C63.4: 2003.



3.4 FCC PART 15.205 RESTRICTED BANDS OF OPERATIONS

(a) Except as shown in paragraph (d) of this section, only spurious emissions are permitted in any of the frequency bands listed below:

MHz	MHz	MHz	GHz
0.090 - 0.110	16.42 - 16.423	399.9 - 410	4.5 - 5.15
¹ 0.495 - 0.505	16.69475 - 16.69525	608 - 614	5.35 - 5.46
2.1735 - 2.1905	16.80425 - 16.80475	960 - 1240	7.25 - 7.75
4.125 - 4.128	25.5 - 25.67	1300 - 1427	8.025 - 8.5
4.17725 - 4.17775	37.5 - 38.25	1435 - 1626.5	9.0 - 9.2
4.20725 - 4.20775	73 - 74.6	1645.5 - 1646.5	9.3 - 9.5
6.215 - 6.218	74.8 - 75.2	1660 - 1710	10.6 - 12.7
6.26775 - 6.26825	108 - 121.94	1718.8 - 1722.2	13.25 - 13.4
6.31175 - 6.31225	123 - 138	2200 - 2300	14.47 - 14.5
8.291 - 8.294	149.9 - 150.05	2310 - 2390	15.35 - 16.2
8.362 - 8.366	156.52475 -	2483.5 - 2500	17.7 - 21.4
8.37625 - 8.38675	156.52525	2655 - 2900	22.01 - 23.12
8.41425 - 8.41475	156.7 - 156.9	3260 - 3267	23.6 - 24.0
12.29 - 12.293	162.0125 - 167.17	3332 - 3339	31.2 - 31.8
12.51975 - 12.52025	167.72 - 173.2	3345.8 - 3358	36.43 - 36.5
12.57675 - 12.57725	240 - 285	3600 - 4400	(²)
13.36 - 13.41	322 - 335.4		

¹ Until February 1, 1999, this restricted band shall be 0.490-0.510 MHz.

² Above 38.6

(b) Except as provided in paragraphs (d) and (e), the field strength of emissions appearing within these frequency bands shall not exceed the limits shown in Section 15.209. At frequencies equal to or less than 1000 MHz, compliance with the limits in Section 15.209 shall be demonstrated using measurement instrumentation employing a CISPR quasi-peak detector. Above 1000 MHz, compliance with the emission limits in Section 15.209 shall be demonstrated based on the average value of the measured emissions. The provisions in Section 15.35 apply to these measurements.



3.5 DESCRIPTION OF TEST MODES

The EUT (model: T36) had been tested under operating condition.

Software used to control the EUT for staying in continuous transmitting mode was programmed.

This device is for handheld operation only.

After verification, all tests were carried out with the worst case test modes as shown below except radiated spurious emission below 1GHz a, which worst case was in normal link mode only.

Channel Low, Channel Mid and Channel High were chosen for full testing.

The field strength of spurious emission was measured in the following position: EUT stand-up position (Z axis), lie-down position (X, Y axis). The worst emission was found in lie-down position (X axis) and the worst case was recorded.



4. INSTRUMENT CALIBRATION

4.1 MEASURING INSTRUMENT CALIBRATION

The measuring equipment, which was utilized in performing the tests documented herein, has been calibrated in accordance with the manufacturer's recommendations for utilizing calibration equipment, which is traceable to recognized national standards.

4.2 MEASUREMENT EQUIPMENT USED

Equipment Used for Emissions Measurement

Remark: Each piece of equipment is scheduled for calibration once a year.

Conducted Emissions Test Site				
Name of Equipment	Manufacturer	Model	Serial Number	Calibration Due
Spectrum Analyzer	Agilent	E4446A	MY43360131	03/04/2011

3M Semi Anechoic Chamber				
Name of Equipment	Manufacturer	Model	Serial Number	Calibration Due
Spectrum Analyzer	Agilent	E4446A	US42510252	10/26/2010
Test Receiver	Rohde&Schwarz	ESCI	100064	12/23/2010
Switch Controller	TRC	Switch Controller	SC94050010	05/02/2010
4 Port Switch	TRC	4 Port Switch	SC94050020	05/02/2010
Loop Antenna	EMCO	6502	8905/2356	05/28/2010
Horn-Antenna	TRC	HA-0502	06	06/03/2010
Horn-Antenna	TRC	HA-0801	04	10/19/2010
Horn-Antenna	TRC	HA-1201A	01	10/14/2010
Horn-Antenna	TRC	HA-1301A	01	10/14/2010
Bilog- Antenna	Sunol Sciences	JB3	A030205	09/11/2010
Turn Table	Max-Full	MFT-120S	T120S940302	N.C.R.
Antenna Tower	Max-Full	MFA-430	A440940302	N.C.R.
Controller	Max-Full	MF-CM886	CC-C-1F-13	N.C.R.
Site NSA	CCS	N/A	FCC MRA: TW1039 IC: IC 2324G-1/-2	10/17/2010 11/04/2010
Test S/W	LABVIEW (V 6.1)			

4.3 MEASUREMENT UNCERTAINTY

PARAMETER	UNCERTAINTY
3M Semi Anechoic Chamber / 30MHz ~ 1GHz	+/-3.7046
3M Semi Anechoic Chamber / Above 1GHz	+/-3.0958

Remark: This uncertainty represents an expanded uncertainty expressed at approximately the 95% confidence level using a coverage factor of k=2.



5. FACILITIES AND ACCREDITATIONS

5.1 FACILITIES

All measurement facilities used to collect the measurement data are located at

No.199, Chunghsen Road, Hsintien City, Taipei Hsien, Taiwan, R.O.C.

Tel: 886-2-2217-0894 / Fax: 886-2-2217-1029

No.11, Wugong 6th Rd., Wugu Industrial Park, Taipei Hsien 248, Taiwan

Tel: 886-2-2299-9720 / Fax: 886-2-2298-4045

No.81-1, Lane 210, Bade 2nd Rd., Luchu Hsiang, Taoyuan Hsien 338, Taiwan

Tel: 886-3-324-0332 / Fax: 886-3-324-5235

The sites are constructed in conformance with the requirements of ANSI C63.7, ANSI C63.4 and CISPR Publication 22.

5.2 EQUIPMENT



Radiated emissions are measured with one or more of the following types of linearly polarized antennas: tuned dipole, biconical, log periodic, bi-log, and/or ridged waveguide, horn. Spectrum analyzers with pre-selectors and quasi-peak detectors are used to perform radiated measurements.

Conducted emissions are measured with Line Impedance Stabilization Networks and EMI Test Receivers.

Calibrated wideband preamplifiers, coaxial cables, and coaxial attenuators are also used for making measurements.

All receiving equipment conforms to CISPR Publication 16-1, "Radio Interference Measuring Apparatus and Measurement Methods."

5.3 TABLE OF ACCREDITATIONS AND LISTINGS

Country	Agency	Scope of Accreditation	Logo
USA	FCC	3M Semi Anechoic Chamber (FCC MRA: TW1039) to perform FCC Part 15 measurements	 FCC MRA: TW1039
Taiwan	TAF	LP0002, RTTE01, FCC Method-47 CFR Part 15 Subpart C, D, E, RSS-210, RSS-310 IDA TS SRD, AS/NZS 4268, AS/NZS 4771, TS 12.1 & 12.2, ETSI EN 300 440-1, ETSI EN 300 440-2, ETSI EN 300 328, ETSI EN 300 220-1, ETSI EN 300 220-2, ETSI EN 301 893, ETSI EN 301 489-1/3/7/17 FCC OET Bulletin 65 + Supplement C, EN 50360, EN 50361, EN 50371, RSS 102, EN 50383, EN 50385, EN 50392, IEC 62209, CNS 14958-1, CNS 14959 FCC Method -47 CFR Part 15 Subpart B IEC / EN 61000-3-2, IEC / EN 61000-3-3, IEC / EN 61000-4-2/3/4/5/6/8/11	
Canada	Industry Canada	3M Semi Anechoic Chamber (IC 2324G-1 / IC 2324G-2) to perform	 IC 2324G-1 IC 2324G-2

** No part of this report may be used to claim or imply product endorsement by A2LA or any agency of the US Government.*



6. SETUP OF EQUIPMENT UNDER TEST

6.1 SETUP CONFIGURATION OF EUT

See test photographs attached in Appendix I for the actual connections between EUT and support equipment.

6.2 SUPPORT EQUIPMENT

No.	Device Type	Brand	Model	Series No.	FCC ID	Data Cable	Power Cord
1.	Power Supply	Agilent	E3640A	N/A	FCC DoC	N/A	Unshielded, 1.8m

Remark:

1. *All the equipment/cables were placed in the worst-case configuration to maximize the emission during the test.*
2. *Grounding was established in accordance with the manufacturer's requirements and conditions for the intended use.*



7. FCC PART 15.247 REQUIREMENTS

7.1 20 DB BANDWIDTH

LIMIT

None; for reporting purposes only.

Test Configuration

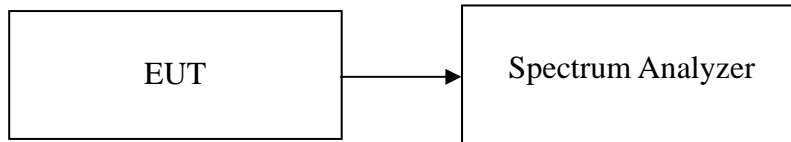

TEST PROCEDURE

1. Place the EUT on the table and set it in the transmitting mode.
2. Remove the antenna from the EUT and then connect a low loss RF cable from the antenna port to the spectrum analyzer.
3. Set the spectrum analyzer as RBW=10kHz, VBW = 30kHz, Span = 1MHz, Sweep = Auto.
4. Mark the peak frequency and 20dB (upper and lower) frequency.
5. Repeat until all the rest channels are investigated.

TEST RESULTS

No non-compliance noted.

Test Data

Channel	Frequency (MHz)	20dB Bandwidth (kHz)
Low	910.0	288
Mid	914.2	290
High	918.4	289



Test Plot

20dB Bandwidth (CH Low)

Agilent 08:27:27 Feb 16, 2010

R T

Δ Mkr2 288 kHz
0.04 dB

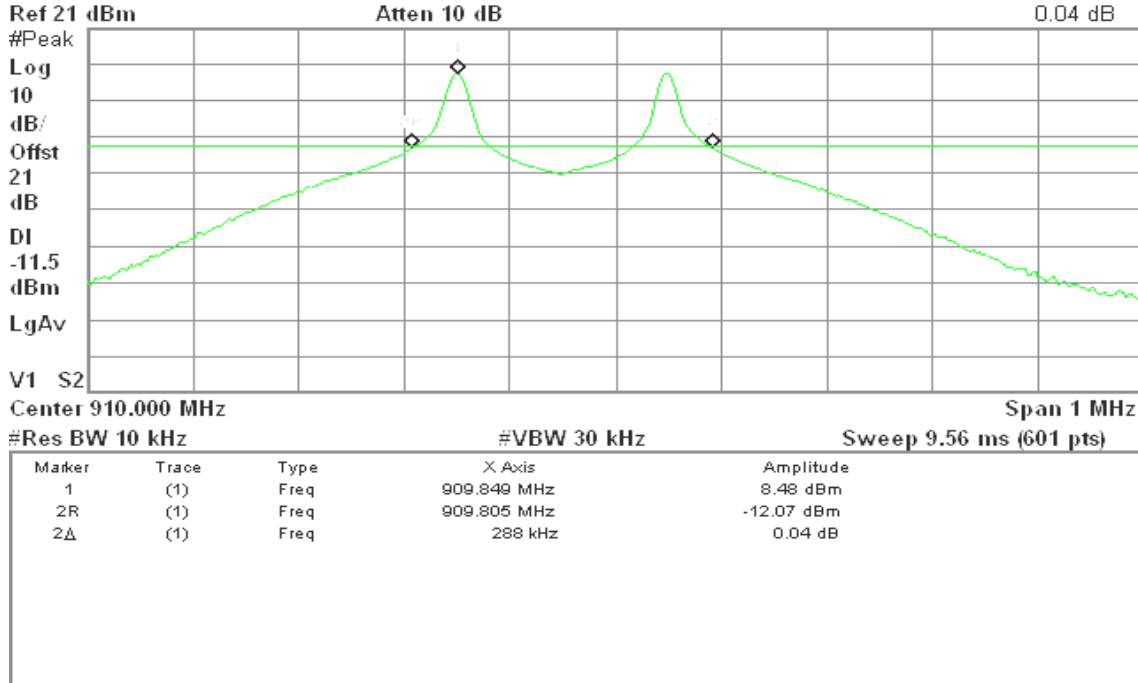

20dB Bandwidth (CH Mid)

Agilent 08:28:26 Feb 16, 2010

R T

Δ Mkr2 290 kHz
-0.03 dB

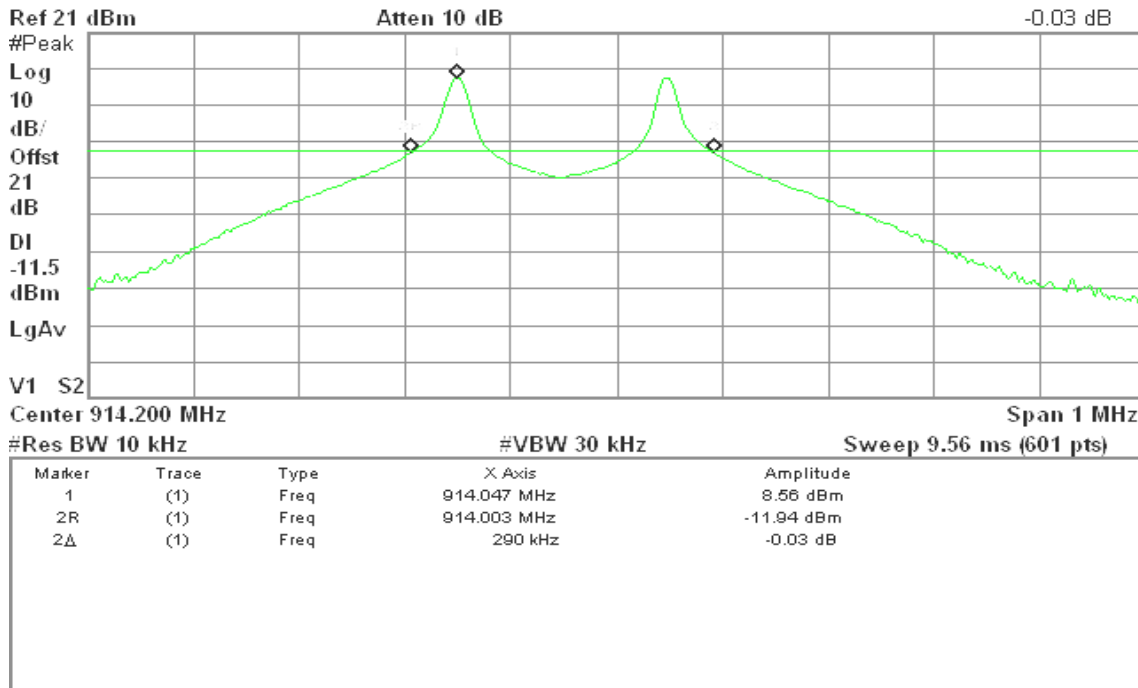



20dB Bandwidth (CH High)

Agilent 08:29:29 Feb 16, 2010

R T

Δ Mkr2 289 kHz
-0.17 dB

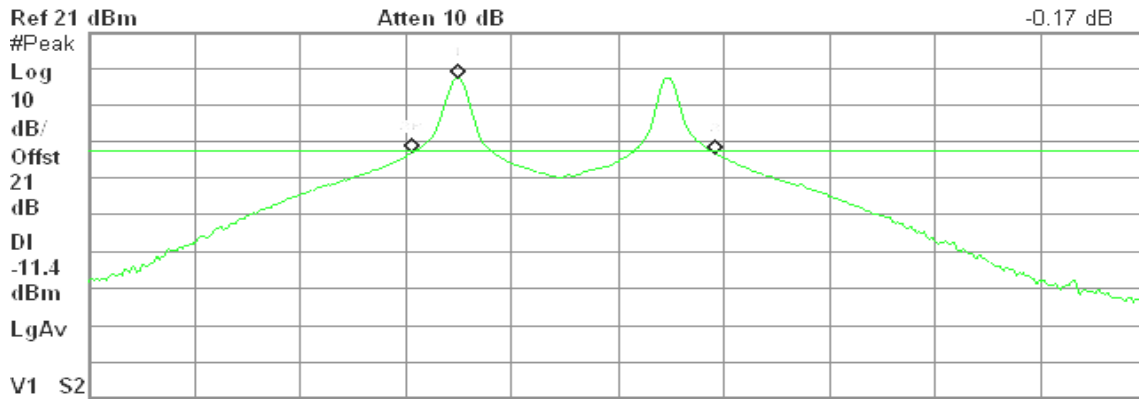

Marker	Trace	Type	X Axis	Amplitude
1	(1)	Freq	918.248 MHz	8.61 dBm
2R	(1)	Freq	918.204 MHz	-11.98 dBm
2Δ	(1)	Freq	289 kHz	-0.17 dB



7.2 PEAK POWER

LIMIT

The maximum peak output power of the intentional radiator shall not exceed the following:

1. According to §15.247(a)(1), Frequency hopping systems shall have hopping channel carrier frequencies separated by a minimum of 25 kHz or the 20 dB bandwidth of the hopping channel, whichever is greater. Alternatively, frequency hopping systems operating in the 2400-2483.5 MHz band may have hopping channel carrier frequencies that are separated by 25 kHz or two-thirds of the 20 dB bandwidth of the hopping channel, whichever is greater, provided the systems operate with an output power no greater than 125 mW.
2. According to §15.247(b)(2) For frequency hopping systems operating in the 902-928 MHz band: 1 watt for systems employing at least 50 hopping channels; and, 0.25 watts for systems employing less than 50 hopping channels, but at least 25 hopping channels, as permitted under paragraph (a)(1)(i) of this section.
3. According to §15.247(b)(3), for systems using digital modulation in the bands of 902-928 MHz, 2400-2483.5 MHz, and 5725-5850 MHz: 1 Watt.
4. According to §15.247(b)(4), the conducted output power limit specified in paragraph (b) of this section is based on the use of antennas with directional gains that do not exceed 6 dBi. Except as shown in paragraph (c) of this section, if transmitting antennas of directional gain greater than 6 dBi are used, the conducted output power from the intentional radiator shall be reduced below the stated values in paragraphs (b)(1), (b)(2), and (b)(3) of this section, as appropriate, by the amount in dB that the directional gain of the antenna exceeds 6 dBi.

Test Configuration

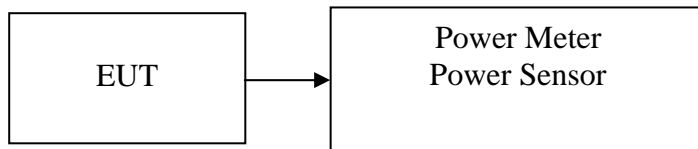

TEST PROCEDURE

The transmitter output is connected to the Power Meter. The Power Meter is set to the peak power detection.

TEST RESULTS

No non-compliance noted.

Test Data

Channel	Frequency (MHz)	Output Power (dBm)	Output Power (W)	Limit (W)	Result
Low	910.0	7.96	0.00625	0.25	PASS
Mid	914.2	7.87	0.00612		PASS
High	918.4	7.91	0.00618		PASS



7.3 AVERAGE POWER

LIMIT

None; for reporting purposes only.

Test Configuration

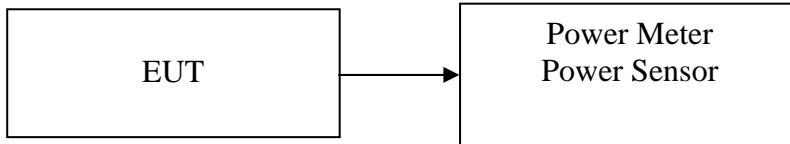

TEST PROCEDURE

The transmitter output is connected to the Power Meter. The Power Meter is set to the peak power detection.

TEST RESULTS

No non-compliance noted.

Test Data

Channel	Frequency (MHz)	Output Power (dBm)	Output Power (W)
Low	910.0	7.90	0.00617
Mid	914.2	7.82	0.00605
High	918.4	7.86	0.00611

7.4 BAND EDGES MEASUREMENT

LIMIT

According to §15.247(d), in any 100 kHz bandwidth outside the frequency bands in which the spread spectrum intentional radiator is operating, the radio frequency power that is produced by the intentional radiator shall be at least 20 dB below that in the 100 kHz bandwidth within the band that contains the highest level of the desired power, based on either an RF conducted or a radiated measurement, provided the transmitter demonstrates compliance with the peak conducted power limits. In addition, radiated emissions which fall in the restricted bands, as defined in §15.205(a), must also comply with the radiated emission limits specified in 15.209(a) (see Section 15.205(c)).

Test Configuration

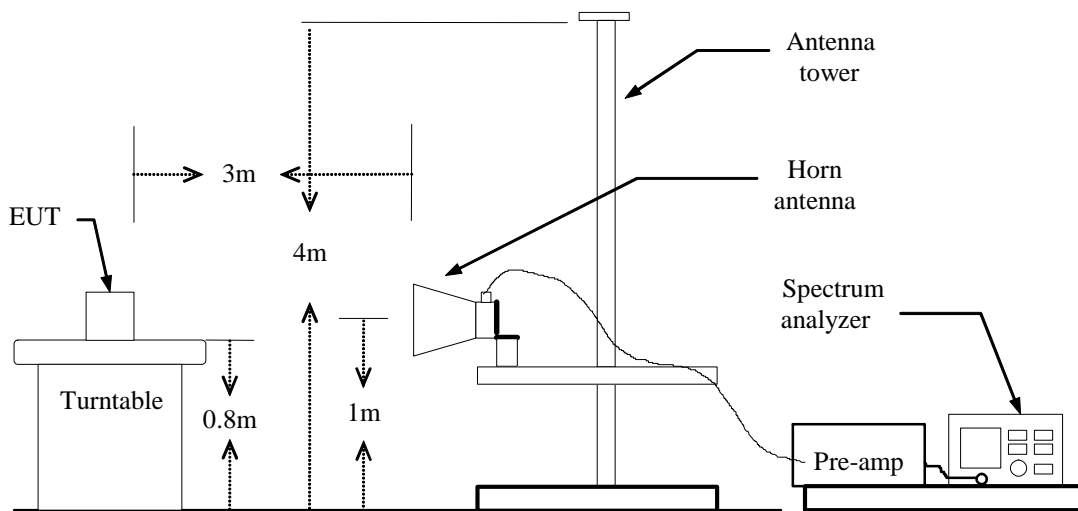

TEST PROCEDURE

1. The EUT is placed on a turntable, which is 0.8m above the ground plane.
2. The turntable shall be rotated for 360 degrees to determine the position of maximum emission level.
3. EUT is set 3m away from the receiving antenna, which is varied from 1m to 4m to find out the highest emission.
4. Set the spectrum analyzer in the following setting in order to capture the lower and upper band-edges of the emission:
 - (a) PEAK: RBW=VBW=1MHz / Sweep=AUTO
 - (b) AVERAGE: RBW=1MHz / VBW=10Hz / Sweep=AUTO
5. Repeat the procedures until all the PEAK and AVERAGE versus POLARIZATION are measured.

TEST RESULTS

1. Operating Frequency: 910 - 918.4 MHz
2. CH Low: 910MHz, CH High: 918.4MHz
3. 20dB Bandwidth: 290kHz

Because the mentioned conditions, the operating frequency is in frequency bands 910 - 918.4 MHz, the test is not applicable.



7.5 FREQUENCY SEPARATION

LIMIT

According to §15.247(a)(1)(i), For frequency hopping systems operating in the 902-928 MHz band: if the 20 dB bandwidth of the hopping channel is less than 250 kHz, the system shall use at least 50 hopping frequencies and the average time of occupancy on any frequency shall not be greater than 0.4 seconds within a 20 second period; if the 20 dB bandwidth of the hopping channel is 250 kHz or greater, the system shall use at least 25 hopping frequencies and the average time of occupancy on any frequency shall not be greater than 0.4 seconds within a 10 second period. The maximum allowed 20 dB bandwidth of the hopping channel is 500 kHz.

Test Configuration

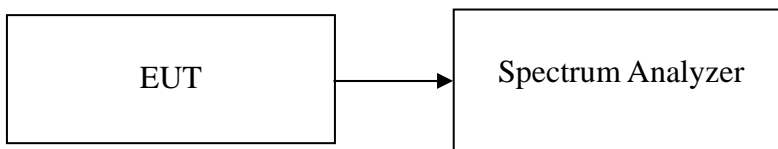

TEST PROCEDURE

1. Place the EUT on the table and set it in transmitting mode.
2. Remove the antenna from the EUT and then connect a low loss RF cable from the antenna port to the spectrum analyzer.
3. Set center frequency of spectrum analyzer = middle of hopping channel.
4. Set the spectrum analyzer as RBW = 51kHz, VBW = 51kHz, Span = 1MHz, Sweep = 1ms.
5. Max hold, mark 3 peaks of hopping channel and record the 3 peaks frequency.

TEST RESULTS

No non-compliance noted

Test Data

Channel Separation (MHz)	20dB Bandwidth (kHz)	Channel Separation Limit	Result
0.35	290	20dB Bandwidth	Pass



Test Plot

Measurement of Channel Separation

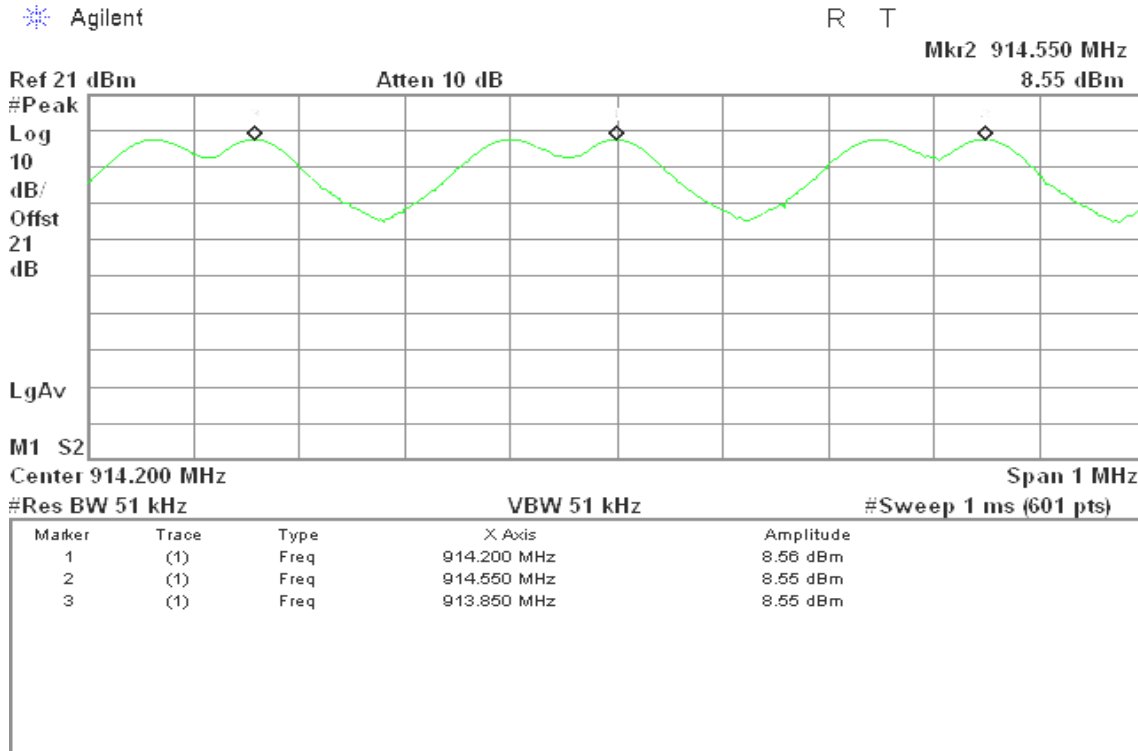

Measurement of 20dB Bandwidth

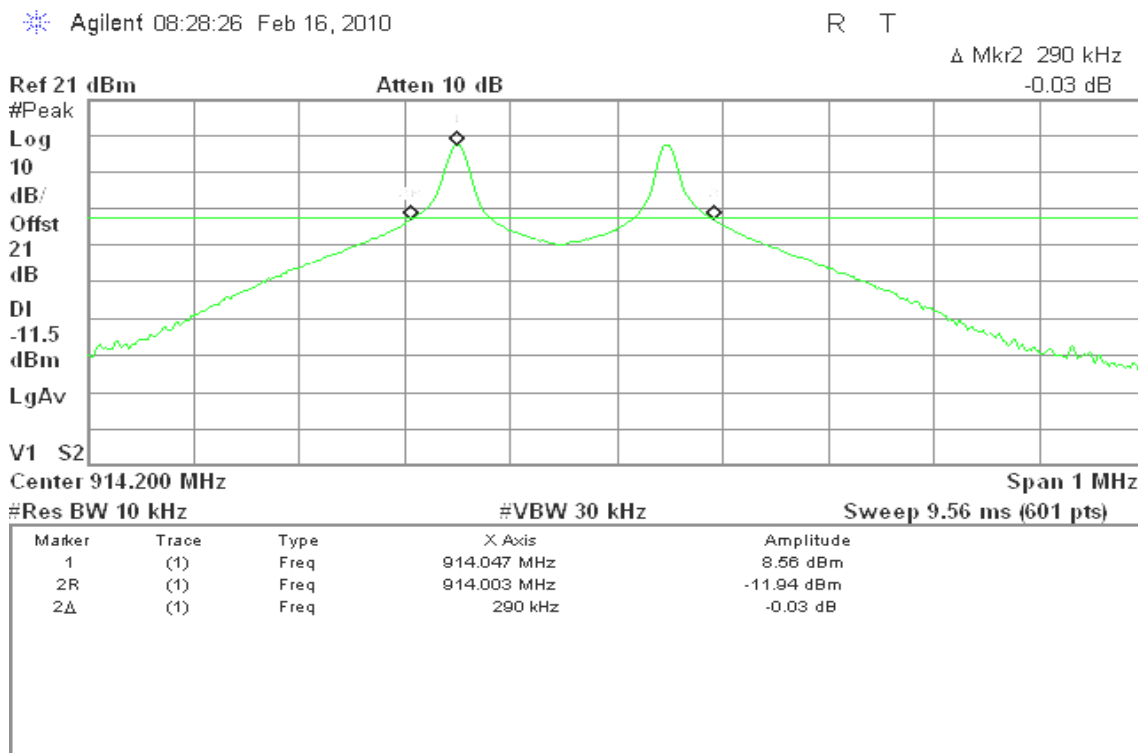

7.6 NUMBER OF HOPPING FREQUENCY

LIMIT

According to §15.247(b)(2), For frequency hopping systems operating in the 902-928 MHz band: 1 watt for systems employing at least 50 hopping channels; and, 0.25 watts for systems employing less than 50 hopping channels, but at least 25 hopping channels, as permitted under paragraph (a)(1)(i) of this section.

Test Configuration

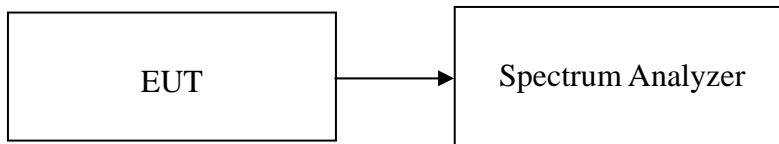

TEST PROCEDURE

1. Place the EUT on the table and set it in transmitting mode.
2. Remove the antenna from the EUT and then connect a low loss RF cable from the antenna port to the spectrum analyzer.
3. Set spectrum analyzer Start=908MHz, Stop =921MHz, Sweep = 17.44ms.
4. Set the spectrum analyzer as RBW, VBW=30kHz.
5. Max hold, view and count how many channel in the band.

TEST RESULTS

No non-compliance noted

Test Data

Result (No. of CH)	Limit (No. of CH)	Result
25	>25	PASS



Test Plot

Channel Number

08

R T

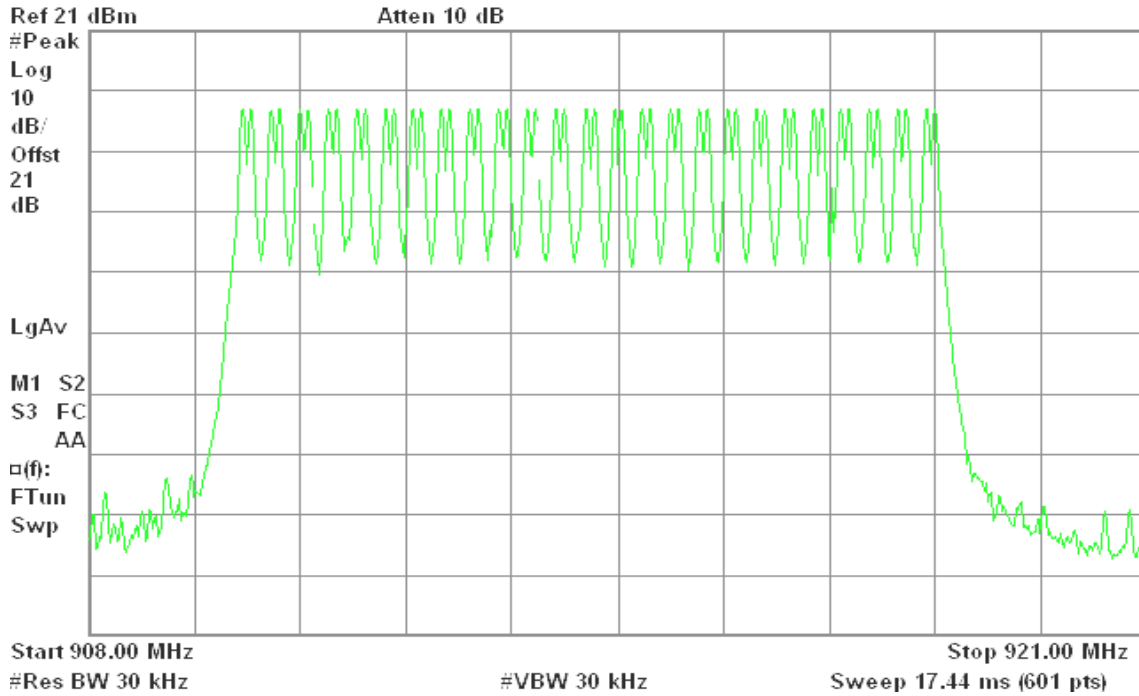

7.7 TIME OF OCCUPANCY (DWELL TIME)

LIMIT

According to §15.247(a)(1)(i), For frequency hopping systems operating in the 902-928 MHz band: if the 20 dB bandwidth of the hopping channel is less than 250 kHz, the system shall use at least 50 hopping frequencies and the average time of occupancy on any frequency shall not be greater than 0.4 seconds within a 20 second period; if the 20 dB bandwidth of the hopping channel is 250 kHz or greater, the system shall use at least 25 hopping frequencies and the average time of occupancy on any frequency shall not be greater than 0.4 seconds within a 10 second period. The maximum allowed 20 dB bandwidth of the hopping channel is 500 kHz.

Test Configuration

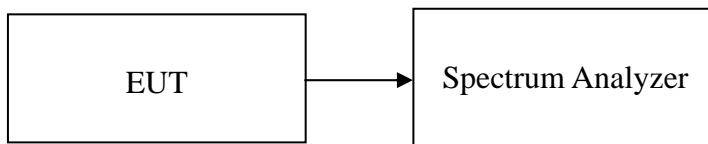

TEST PROCEDURE

The transmitter output is connected to a spectrum analyzer. The span is set to 0 Hz, centered on a single, selected hopping channel. The width of a single pulse is measured in a fast scan. The number of pulses is measured in a 1 second scan, to enable resolution of each occurrence.

The average time of occupancy in the specified 10 second period (25 channels * 0.4 s) is equal to $10 * (\# \text{ of pulses in } 1.0 \text{ s}) * \text{ pulse width}$.

TEST RESULTS

No non-compliance noted

$$\begin{aligned} \text{Average time of occupancy} &= 4 * (93.33\text{ms}) \\ &= 4 * (0.09333\text{s}) \\ &= 0.37332\text{s} \end{aligned}$$



Test Plot

Pulse width

Agilent

R T

Δ Mkr1 93.33 ms
-0.03 dB

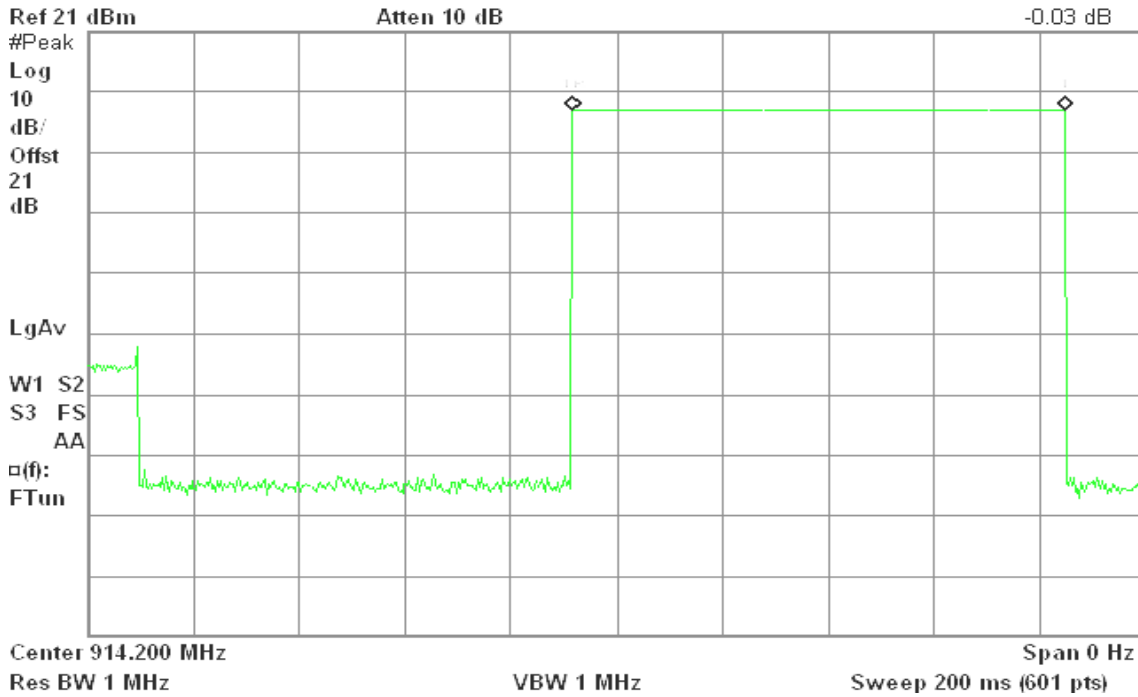

Number of pulses in 10 second observation period

R T

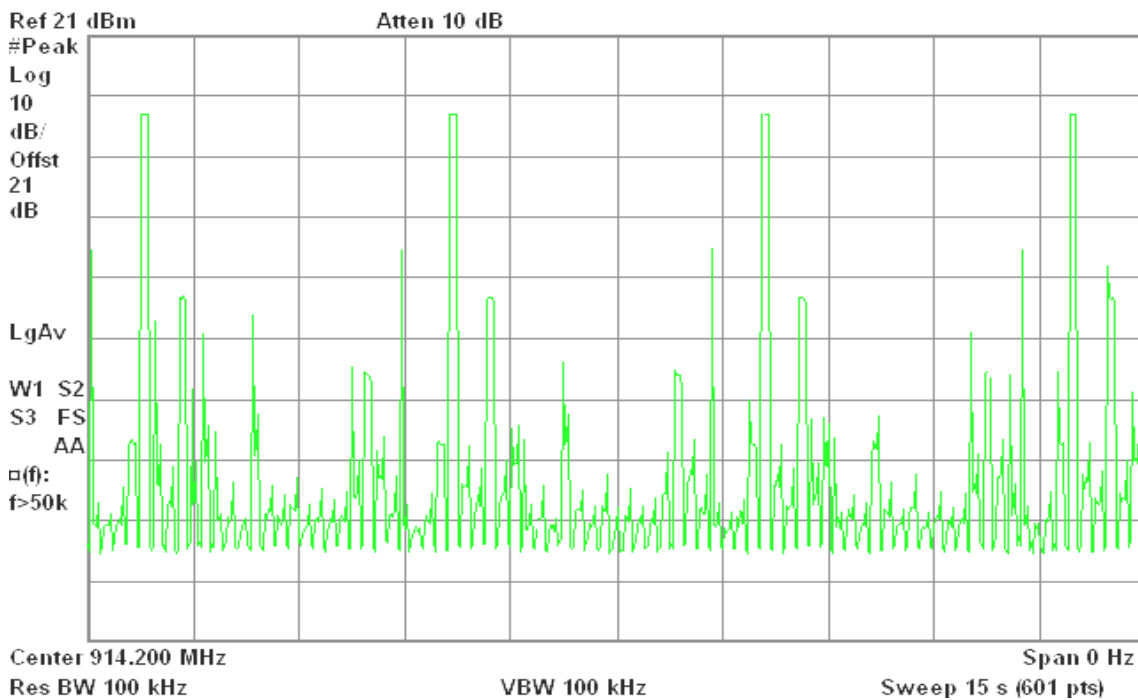



7.8 SPURIOUS EMISSIONS

7.8.1 Conducted Measurement

LIMIT

According to §15.247(d), in any 100 kHz bandwidth outside the frequency bands in which the spread spectrum intentional radiator is operating, the radio frequency power that is produced by the intentional radiator shall be at least 20 dB below that in the 100 kHz bandwidth within the band that contains the highest level of the desired power, based on either an RF conducted or a radiated measurement, provided the transmitter demonstrates compliance with the peak conducted power limits. In addition, radiated emissions which fall in the restricted bands, as defined in §15.205(a), must also comply with the radiated emission limits specified in 15.209(a) (see Section 15.205(c)).

Test Configuration

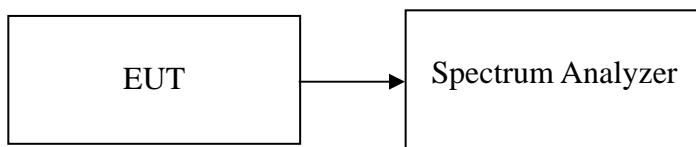

TEST PROCEDURE

Conducted RF measurements of the transmitter output were made to confirm that the EUT antenna port conducted emissions meet the specified limit and to identify any spurious signals that require further investigation or measurements on the radiated emissions site.

The transmitter output is connected to the spectrum analyzer. The resolution bandwidth is set to 100 kHz. The video bandwidth is set to 100 kHz.

Measurements are made over the 13GHz to 26GHz range with the transmitter set to the lowest, middle, and highest channels.

TEST RESULTS

No non-compliance noted



Test Plot

CH Low

Agilent 20:30:53 Mar 16, 2010

R T

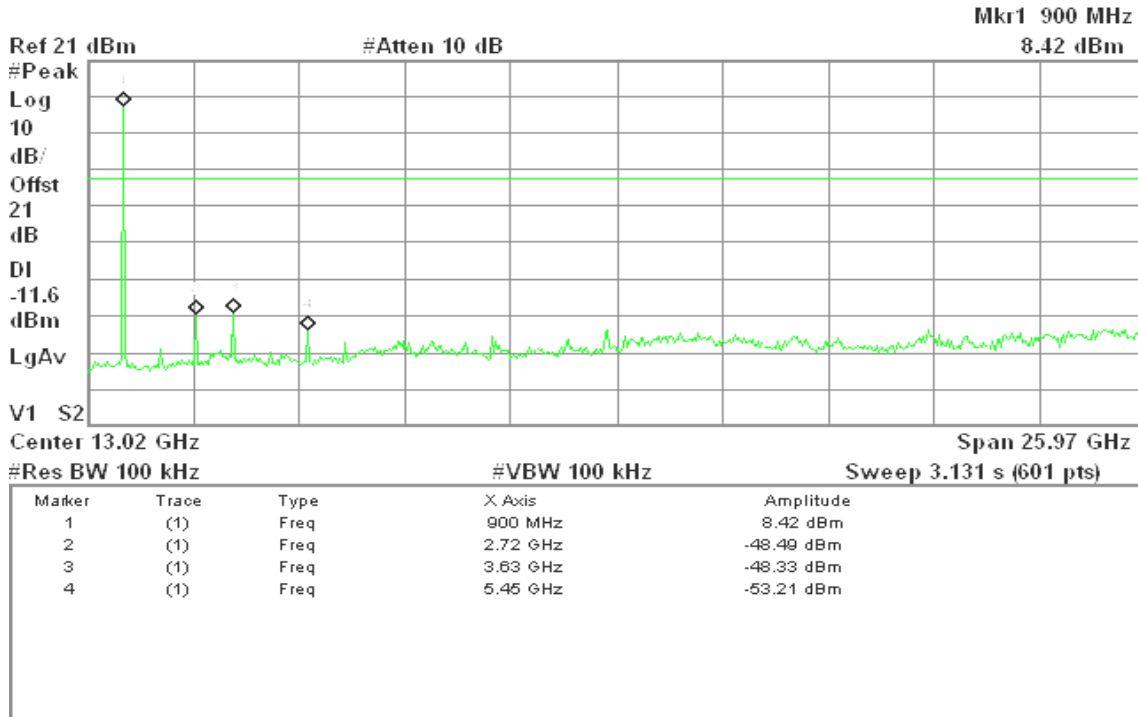

CH Mid

Agilent 20:32:24 Mar 16, 2010

R T

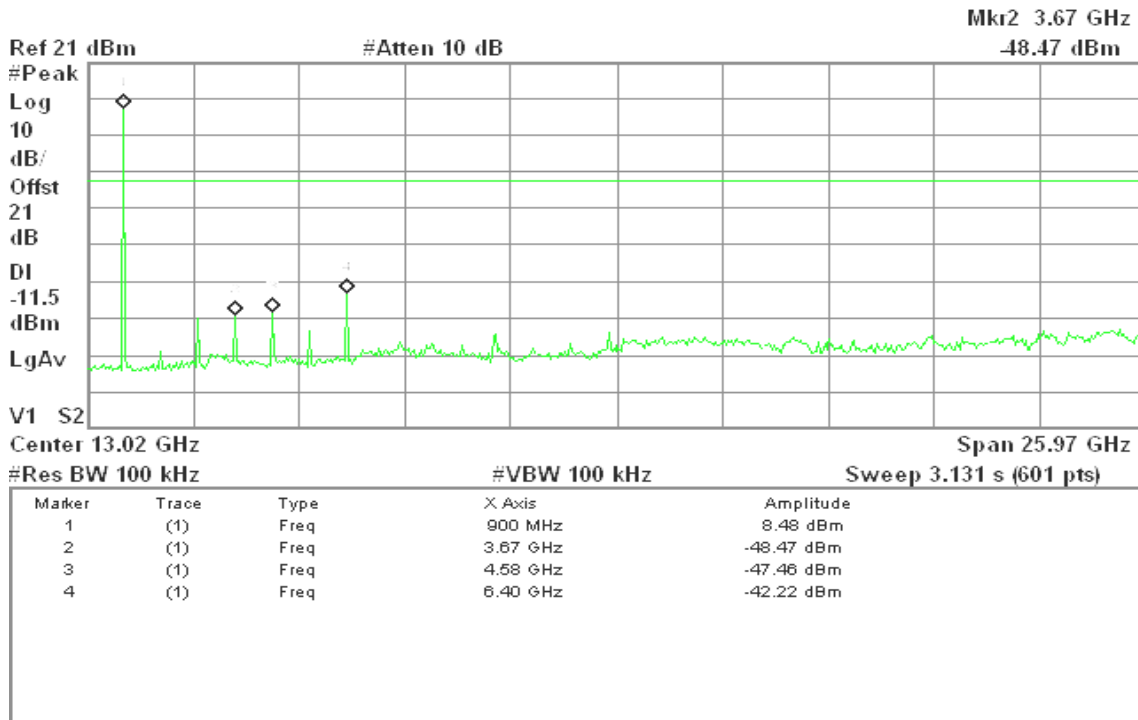



CH High

Agilent 20:33:08 Mar 16, 2010

R T

Mkr4 6.44 GHz
-43.98 dBm

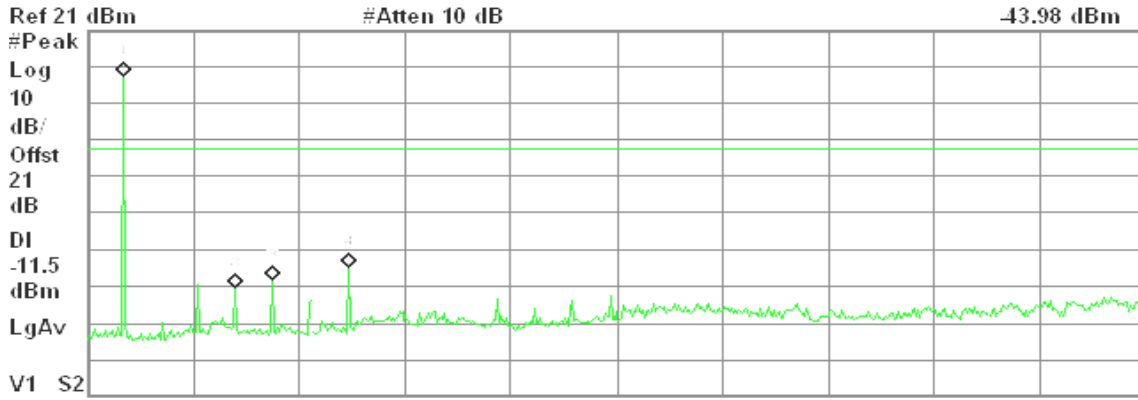

Marker	Trace	Type	X Axis	Amplitude
1	(1)	Freq	900 MHz	8.52 dBm
2	(1)	Freq	3.67 GHz	-49.56 dBm
3	(1)	Freq	4.58 GHz	-47.40 dBm
4	(1)	Freq	6.44 GHz	-43.98 dBm



7.8.2 Radiated Emissions

LIMIT

1. According to §15.209(a), except as provided elsewhere in this Subpart, the emissions from an intentional radiator shall not exceed the field strength levels specified in the following table:

Frequency (MHz)	Field Strength ($\mu\text{V/m}$)	Measurement Distance (m)
30-88	100*	3
88-216	150*	3
216-960	200*	3
Above 960	500	3

Remark: Except as provided in paragraph (g), fundamental emissions from intentional radiators operating under this Section shall not be located in the frequency bands 54-72 MHz, 76-88 MHz, 174-216 MHz or 470-806 MHz. However, operation within these frequency bands is permitted under other sections of this Part, e.g., Sections 15.231 and 15.241.

2. In the emission table above, the tighter limit applies at the band edges.

Frequency (MHz)	Field Strength ($\mu\text{V/m}$ at 3-meter)	Field Strength (dB $\mu\text{V/m}$ at 3-meter)
30-88	100	40
88-216	150	43.5
216-960	200	46
Above 960	500	54

Test Configuration

9kHz ~ 30MHz

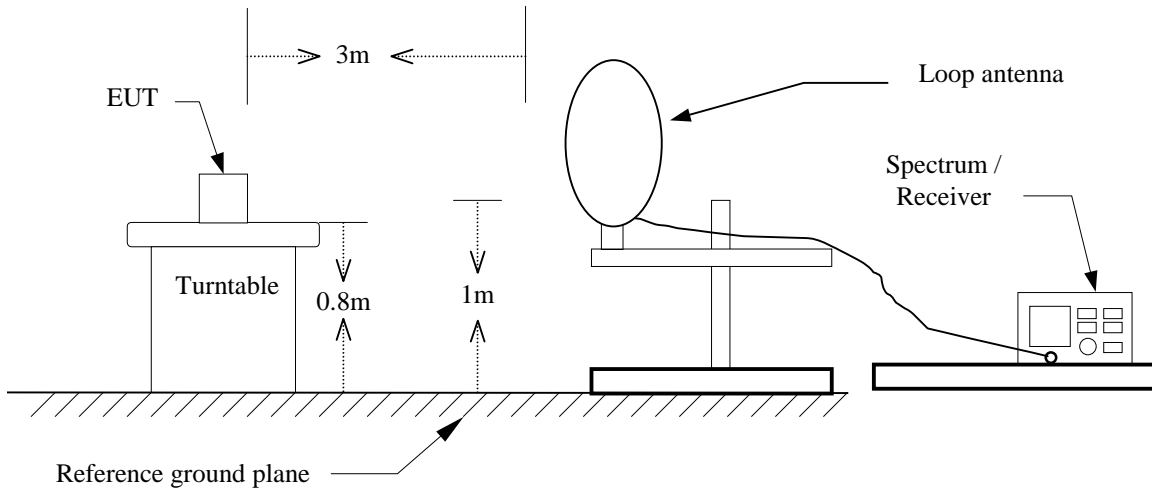

Below 1 GHz

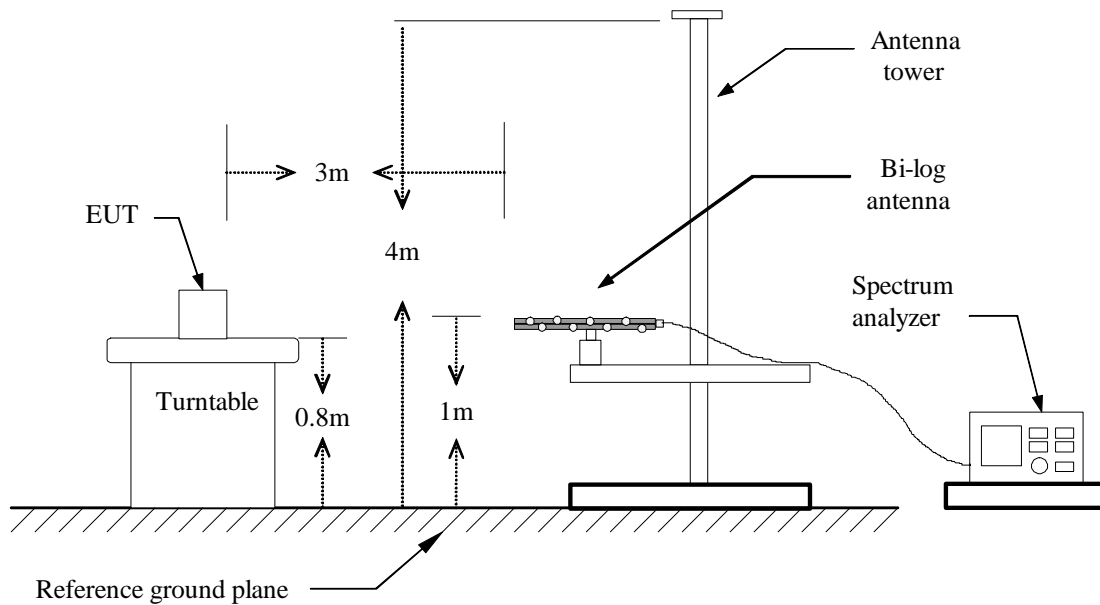

Above 1 GHz

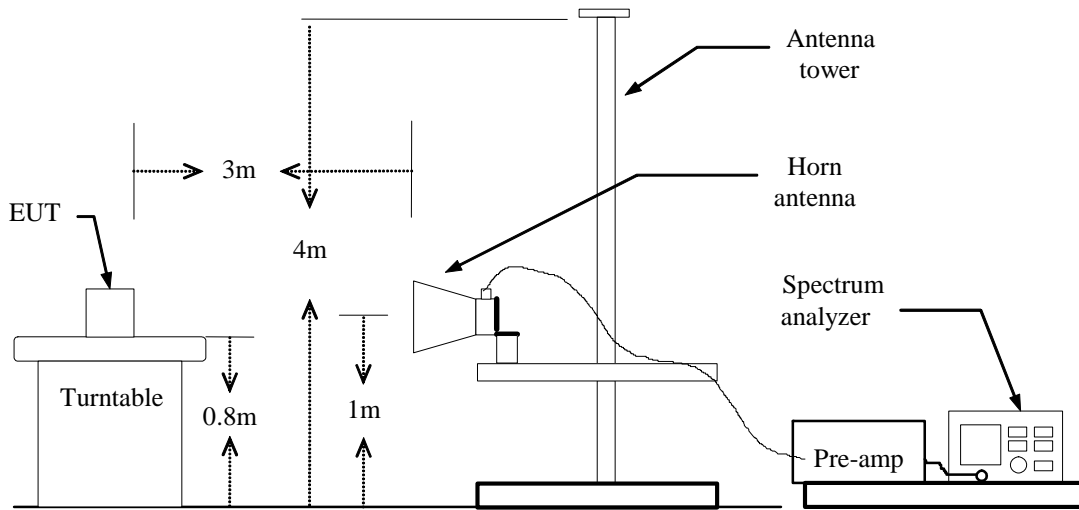

TEST PROCEDURE

1. The EUT is placed on a turntable, which is 0.8m above ground plane.
2. The turntable shall be rotated for 360 degrees to determine the position of maximum emission level.
3. EUT is set 3m away from the receiving antenna, which is varied from 1m to 4m to find out the highest emissions.
4. Maximum procedure was performed on the six highest emissions to ensure EUT compliance.
5. And also, each emission was to be maximized by changing the polarization of receiving antenna both horizontal and vertical.
6. Set the spectrum analyzer in the following setting as:

Below 1GHz:

RBW=100kHz / VBW=300kHz / Sweep=AUTO

Above 1GHz:

(a) PEAK: RBW=VBW=1MHz / Sweep=AUTO

(b) AVERAGE: RBW=1MHz / VBW=10Hz / Sweep=AUTO

7. Repeat above procedures until the measurements for all frequencies are complete.

**Below 1 GHz****Operation Mode:** CH Low**Test Date:** March 12, 2010**Temperature:** 25°C**Tested by:** Mimic Yang**Humidity:** 55 % RH**Polarity:** Ver. / Hor.

Frequency (MHz)	Ant.Pol. (H/V)	Reading (dBuV)	Correction Factor (dB/m)	Result (dBuV/m)	Limit (dBuV/m)	Margin (dB)	Remark
72.03	V	48.09	-14.70	33.39	40.00	-6.61	Peak
83.35	V	44.70	-15.26	29.44	40.00	-10.56	QP
89.82	V	53.07	-15.48	37.58	43.50	-5.92	Peak
96.28	V	49.42	-13.95	35.47	43.50	-8.03	Peak
149.63	V	38.40	-10.21	28.18	43.50	-15.32	Peak
941.80	V	39.25	0.16	39.42	46.00	-6.58	Peak
83.35	H	49.13	-15.26	33.87	40.00	-6.13	Peak
96.28	H	49.87	-13.95	35.92	43.50	-7.58	Peak
185.20	H	44.86	-11.19	33.67	43.50	-9.83	Peak
846.42	H	40.47	-0.87	39.60	46.00	-6.40	Peak
877.13	H	38.96	-0.73	38.23	46.00	-7.77	Peak
941.80	H	37.43	0.16	37.59	46.00	-8.41	QP

Remark:

1. No emission found between lowest internal used/generated frequency to 30MHz (9kHz~30MHz).
2. Radiated emissions measured were made with an instrument using peak/quasi-peak detector mode.
3. Quasi-peak test would be performed if the peak result were greater than the quasi-peak limit or as required by the applicant.
4. Measurements above show only up to 6 maximum emissions noted, or would be lesser, with " N/A " remark, if no specific emissions from the EUT are recorded (ie: margin>20dB from the applicable limit) and considered that's already beyond the background noise floor.
5. Margin (dB) = Remark result (dBuV/m) – Quasi-peak limit (dBuV/m).

**Operation Mode:** CH Mid**Test Date:** March 12, 2010**Temperature:** 25°C**Tested by:** Mimic Yang**Humidity:** 55 % RH**Polarity:** Ver. / Hor.

Frequency (MHz)	Ant.Pol. (H/V)	Reading (dBuV)	Correction Factor (dB/m)	Result (dBuV/m)	Limit (dBuV/m)	Margin (dB)	Remark
72.03	V	48.34	-14.70	33.64	40.00	-6.36	Peak
83.35	V	33.66	-15.26	18.40	40.00	-21.60	QP
89.82	V	52.20	-15.48	36.72	43.50	-6.78	Peak
96.28	V	48.80	-13.95	34.85	43.50	-8.65	Peak
149.63	V	39.33	-10.21	29.12	43.50	-14.38	Peak
946.65	V	38.70	0.26	38.96	46.00	-7.04	Peak
83.35	H	49.82	-15.26	34.57	40.00	-5.43	Peak
96.28	H	47.99	-13.95	34.04	43.50	-9.46	Peak
160.95	H	45.30	-10.60	34.70	43.50	-8.80	Peak
849.65	H	41.01	-0.83	40.18	46.00	-5.82	Peak
881.98	H	41.45	-0.71	40.74	46.00	-5.26	Peak
946.65	H	37.95	0.26	38.21	46.00	-7.79	QP

Remark:

1. No emission found between lowest internal used/generated frequency to 30MHz (9kHz~30MHz)
2. Radiated emissions measured in frequency range from 30 MHz to 1000MHz, were made with an instrument using peak/quasi-peak detector mode.
3. Quasi-peak test would be performed if the peak result were greater than the quasi-peak limit or as required by the applicant.
4. Measurements above show only up to 6 maximum emissions noted, or would be lesser, with " N/A " remark, if no specific emissions from the EUT are recorded (ie: margin>20dB from the applicable limit) and considered that's already beyond the background noise floor.
5. Margin (dB) = Remark result (dBuV/m) – Quasi-peak limit (dBuV/m).

**Operation Mode:** CH High**Test Date:** March 12, 2010**Temperature:** 25°C**Tested by:** Mimic Yang**Humidity:** 55 % RH**Polarity:** Ver. / Hor.

Frequency (MHz)	Ant.Pol. (H/V)	Reading (dBuV)	Correction Factor (dB/m)	Result (dBuV/m)	Limit (dBuV/m)	Margin (dB)	Remark
72.03	V	48.40	-14.70	33.70	40.00	-6.30	Peak
83.35	V	44.10	-15.26	28.84	40.00	-11.16	QP
89.82	V	52.66	-15.48	37.18	43.50	-6.32	Peak
96.28	V	48.01	-13.95	34.06	43.50	-9.44	Peak
149.63	V	38.93	-10.21	28.72	43.50	-14.78	Peak
949.88	V	39.17	0.32	39.49	46.00	-6.51	Peak
83.35	H	50.13	-15.26	34.87	40.00	-5.13	Peak
96.28	H	48.83	-13.95	34.88	43.50	-8.62	Peak
185.20	H	44.22	-11.19	33.04	43.50	-10.46	Peak
854.50	H	40.36	-0.81	39.55	46.00	-6.45	Peak
886.83	H	42.43	-0.69	41.74	46.00	-4.26	Peak
949.88	H	37.67	0.32	37.99	46.00	-8.01	QP

Remark:

1. No emission found between lowest internal used/generated frequency to 30MHz (9kHz~30MHz)
2. Radiated emissions measured in frequency range from 30 MHz to 1000MHz, were made with an instrument using peak/quasi-peak detector mode.
3. Quasi-peak test would be performed if the peak result were greater than the quasi-peak limit or as required by the applicant.
4. Measurements above show only up to 6 maximum emissions noted, or would be lesser, with " N/A " remark, if no specific emissions from the EUT are recorded (ie: margin>20dB from the applicable limit) and considered that's already beyond the background noise floor.
5. Margin (dB) = Remark result (dBuV/m) – Quasi-peak limit (dBuV/m).



Above 1 GHz

Operation Mode: TX / CH Low

Test Date: March 12, 2010

Temperature: 25°C

Tested by: Mimic Yang

Humidity: 55 % RH

Polarity: Ver. / Hor.

Frequency (MHz)	Ant. Pol. (H/V)	Reading (Peak) (dBuV)	Reading (Average) (dBuV)	Correction Factor (dB/m)	Result (Peak) (dBuV/m)	Result (Average) (dBuV/m)	Limit (Peak) (dBuV/m)	Limit (Average) (dBuV/m)	Margin (dB)	Remark
1820.00	V	53.98	---	-5.81	48.17	---	74.00	54.00	-5.83	Peak
2730.00	V	53.81	---	-1.99	51.82	---	74.00	54.00	-2.18	Peak
N/A										
2730.00	H	56.42	51.26	-1.99	54.43	49.27	74.00	54.00	-4.73	AVG
4551.67	H	53.02	49.33	1.26	54.28	50.59	74.00	54.00	-3.41	AVG
6371.67	H	51.14	47.08	3.32	54.46	50.40	74.00	54.00	-3.60	AVG
N/A										

Remark:

1. Measuring frequencies from 1 GHz to the 10th harmonic of highest fundamental frequency.
2. Radiated emissions measured in frequency above 1000MHz were made with an instrument using peak/average detector mode.
3. Average test would be performed if the peak result were greater than the average limit or as required by the applicant.
4. Data of measurement within this frequency range shown " --- " in the table above means the reading of emissions are attenuated more than 20dB below the permissible limits or the field strength is too small to be measured.
5. Measurements above show only up to 6 maximum emissions noted, or would be lesser, with " N/A " remark, if no specific emissions from the EUT are recorded (ie: margin>20dB from the applicable limit) and considered that's already beyond the background noise floor.
6. Margin (dB) = Remark result (dBuV/m) – Average limit (dBuV/m).



Operation Mode: TX / CH Mid

Test Date: March 12, 2010

Temperature: 25°C

Tested by: Mimic Yang

Humidity: 55 % RH

Polarity: Ver. / Hor.

Frequency (MHz)	Ant. Pol. (H/V)	Reading (Peak) (dBuV)	Reading (Average) (dBuV)	Correction Factor (dB/m)	Result (Peak) (dBuV/m)	Result (Average) (dBuV/m)	Limit (Peak) (dBuV/m)	Limit (Average) (dBuV/m)	Margin (dB)	Remark
1830.00	V	54.28	---	-5.72	48.56	---	74.00	54.00	-5.44	Peak
2743.33	V	56.32	49.75	-1.95	54.37	47.80	74.00	54.00	-6.20	AVG
N/A										
2743.33	H	56.61	51.93	-1.95	54.66	49.98	74.00	54.00	-4.02	AVG
4575.00	H	52.84	49.55	1.26	54.10	50.81	74.00	54.00	-3.19	AVG
6395.00	H	51.39	47.55	3.37	54.75	50.92	74.00	54.00	-3.08	AVG
N/A										

Remark:

1. Measuring frequencies from 1 GHz to the 10th harmonic of highest fundamental frequency.
2. Radiated emissions measured in frequency above 1000MHz were made with an instrument using peak/average detector mode.
3. Average test would be performed if the peak result were greater than the average limit or as required by the applicant.
4. Data of measurement within this frequency range shown “ --- ” in the table above means the reading of emissions are attenuated more than 20dB below the permissible limits or the field strength is too small to be measured.
5. Measurements above show only up to 6 maximum emissions noted, or would be lesser, with “ N/A ” remark, if no specific emissions from the EUT are recorded (ie: margin>20dB from the applicable limit) and considered that's already beyond the background noise floor.
6. Margin (dB) = Remark result (dBuV/m) – Average limit (dBuV/m).



Operation Mode: TX / CH High

Test Date: March 12, 2010

Temperature: 25°C

Tested by: Mimic Yang

Humidity: 55 % RH

Polarity: Ver. / Hor.

Frequency (MHz)	Ant.Pol. (H/V)	Reading (Peak) (dBuV)	Reading (Average) (dBuV)	Correction Factor (dB/m)	Result (Peak) (dBuV/m)	Result (Average) (dBuV/m)	Limit (Peak) (dBuV/m)	Limit (Average) (dBuV/m)	Margin (dB)	Remark
2753.33	V	56.13	52.25	-1.92	54.21	50.33	74.00	54.00	-3.67	AVG
N/A										
2753.33	H	55.93	51.11	-1.92	54.01	49.19	74.00	54.00	-4.81	AVG
4586.67	H	52.96	50.63	1.25	54.21	51.88	74.00	54.00	-2.12	AVG
N/A										

Remark:

1. Measuring frequencies from 1 GHz to the 10th harmonic of highest fundamental frequency.
2. Radiated emissions measured in frequency above 1000MHz were made with an instrument using peak/average detector mode.
3. Average test would be performed if the peak result were greater than the average limit or as required by the applicant.
4. Data of measurement within this frequency range shown “ --- ” in the table above means the reading of emissions are attenuated more than 20dB below the permissible limits or the field strength is too small to be measured.
5. Measurements above show only up to 6 maximum emissions noted, or would be lesser; with “ N/A ” remark, if no specific emissions from the EUT are recorded (ie: margin>20dB from the applicable limit) and considered that's already beyond the background noise floor.
6. Margin (dB) = Remark result (dBuV/m) – Average limit (dBuV/m).



7.9 POWERLINE CONDUCTED EMISSIONS

LIMIT

According to §15.207(a), except as shown in paragraphs (b) and (c) of this section, for an intentional radiator that is designed to be connected to the public utility (AC) power line, the radio frequency voltage that is conducted back onto the AC power line on any frequency or frequencies within the band 150 kHz to 30 MHz shall not exceed the limits in the following table, as measured using a 50 μ H/50 ohms line impedance stabilization network (LISN). Compliance with the provisions of this paragraph shall be based on the measurement of the radio frequency voltage between each power line and ground at the power terminal. The lower limit applies at the boundary between the frequency ranges.

Frequency Range (MHz)	Limits (dB μ V)	
	Quasi-peak	Average
0.15 to 0.50	66 to 56*	56 to 46*
0.50 to 5	56	46
5 to 30	60	50

* Decreases with the logarithm of the frequency.

Test Configuration

See test photographs attached in Appendix II for the actual connections between EUT and support equipment.

TEST PROCEDURE

1. The EUT was placed on a table, which is 0.8m above ground plane.
2. Maximum procedure was performed on the six highest emissions to ensure EUT compliance.
3. Repeat above procedures until all frequency measured were complete.

TEST RESULTS

Not applicable (Since the EUT is powered by battery)