



**FCC 47 CFR PART 15 SUBPART C**

**TEST REPORT**

**For**

**RX12 receiver**

**Model: RX12**

**Trade Name: PORTMAN**

*Issued to*

**PORTMAN ELECTRONICS (DONGGUAN) CO., LTD.  
NO#10 , Luyi 2 Road, Keyuancheng, Tangxia Town,  
Dongguan City, Guangdong Province, China**

*Issued by*

**Compliance Certification Services Inc.  
No. 11, Wu-Gong 6<sup>th</sup> Rd., Wugu Industrial Park,  
Taipei Hsien 248, Taiwan (R.O.C.)  
<http://www.ccsrf.com>  
[service@ccsrf.com](mailto:service@ccsrf.com)**



---

**Note:** This report shall not be reproduced except in full, without the written approval of Compliance Certification Services Inc. This document may be altered or revised by Compliance Certification Services Inc. personnel only, and shall be noted in the revision section of the document.



## **TABLE OF CONTENTS**

<b>1. TEST RESULT CERTIFICATION.....</b>	<b>3</b>
<b>2. EUT DESCRIPTION .....</b>	<b>4</b>
<b>3. TEST METHODOLOGY .....</b>	<b>5</b>
3.1 EUT CONFIGURATION .....	5
3.2 EUT EXERCISE.....	5
3.3 GENERAL TEST PROCEDURES.....	5
3.4 FCC PART 15.205 RESTRICTED BANDS OF OPERATIONS.....	6
3.5 DESCRIPTION OF TEST MODES .....	7
<b>4. INSTRUMENT CALIBRATION.....</b>	<b>8</b>
4.1 MEASURING INSTRUMENT CALIBRATION .....	8
4.2 MEASUREMENT EQUIPMENT USED .....	8
4.3 MEASUREMENT UNCERTAINTY .....	8
<b>5. FACILITIES AND ACCREDITATIONS .....</b>	<b>9</b>
5.1 FACILITIES .....	9
5.2 EQUIPMENT.....	9
5.3 TABLE OF ACCREDITATIONS AND LISTINGS.....	10
<b>6. SETUP OF EQUIPMENT UNDER TEST .....</b>	<b>11</b>
6.1 SETUP CONFIGURATION OF EUT.....	11
6.2 SUPPORT EQUIPMENT .....	11
<b>7. FCC PART 15.247 REQUIREMENTS.....</b>	<b>12</b>
7.1 20 DB BANDWIDTH.....	12
7.2 PEAK POWER.....	15
7.3 AVERAGE POWER .....	16
7.4 BAND EDGES MEASUREMENT .....	17
7.5 FREQUENCY SEPARATION .....	18
7.6 NUMBER OF HOPPING FREQUENCY.....	20
7.7 TIME OF OCCUPANCY (DWELL TIME) .....	22
7.8 SPURIOUS EMISSIONS .....	24
7.9 POWERLINE CONDUCTED EMISSIONS.....	36
<b>APPENDIX I PHOTOGRAPHS OF TEST SETUP.....</b>	<b>37</b>



## 1. TEST RESULT CERTIFICATION

**Applicant:** PORTMAN ELECTRONICS (DONGGUAN) CO., LTD.  
NO#10 , Luyi 2 Road, Keyuancheng, Tangxia Town,  
Dongguan City, Guangdong Province, China

**Equipment Under Test:** RX12 receiver

**Trade Name:** PORTMAN

**Model:** RX12

**Date of Test:** July 8 ~ 20, 2010

APPLICABLE STANDARDS	
STANDARD	TEST RESULT
FCC 47 CFR Part 15 Subpart C	No non-compliance noted

### We hereby certify that:

The above equipment was tested by Compliance Certification Services Inc. The test data, data evaluation, test procedures, and equipment configurations shown in this report were made in accordance with the procedures given in **ANSI C63.4: 2003** and the energy emitted by the sample EUT tested as described in this report is in compliance with the requirements of FCC Rules Part 15.207, 15.209, 15.247.

The test results of this report relate only to the tested sample EUT identified in this report.

Approved by:

\_\_\_\_\_  
Rex Lai  
Section Manager  
Compliance Certification Services Inc.

Reviewed by:

\_\_\_\_\_  
Gina Lo  
Section Manager  
Compliance Certification Services Inc.



## 2. EUT DESCRIPTION

<b>Product</b>	RX12 receiver						
<b>Trade Name</b>	PORTMAN						
<b>Model Number</b>	RX12						
<b>Model Discrepancy</b>	N/A						
<b>Power Supply</b>	Powered from host device (DC 12V)						
<b>Frequency Range</b>	910 ~ 918.4 MHz						
<b>Transmit Power</b>	7.96 dBm						
<b>Modulation Technique</b>	FSK						
<b>Number of Channels</b>	25 Channels						
<b>Channel list</b>	1	910	10	913.15	19	916.3	
	2	910.35	11	913.5	20	916.65	
	3	910.7	12	913.85	21	917	
	4	911.05	13	914.2	22	917.35	
	5	911.4	14	914.55	23	917.7	
	6	911.75	15	914.9	24	918.05	
	7	912.1	16	915.25	25	918.4	
	8	912.45	17	915.6			
	9	912.8	18	915.95			
<b>Channels Spacing</b>	350kHz						
<b>Antenna Specification</b>	Gain: 8.94dBi						
<b>Antenna Designation</b>	Linear Antenna						

**Remark:**

1. The sample selected for test was production product and was provided by manufacturer.
2. This submittal(s) (test report) is intended for FCC ID: **TBORX12-915** filing to comply with Section 15.207, 15.209 and 15.247 of the FCC Part 15, Subpart C Rules..



### **3. TEST METHODOLOGY**

The tests documented in this report were performed in accordance with ANSI C63.4: 2003 and FCC CFR 47 Part 15.207, 15.209 and 15.247.

#### **3.1 EUT CONFIGURATION**

The EUT configuration for testing is installed on RF field strength measurement to meet the Commissions requirement and operating in a manner that intends to maximize its emission characteristics in a continuous normal application.

#### **3.2 EUT EXERCISE**

The EUT was operated in the engineering mode to fix the TX frequency that was for the purpose of the measurements.

According to its specifications, the EUT must comply with the requirements of the Section 15.207, 15.209 and 15.247 under the FCC Rules Part 15 Subpart C.

#### **3.3 GENERAL TEST PROCEDURES**

##### **Conducted Emissions**

The EUT is placed on the turntable, which is 0.8 m above ground plane. According to the requirements in Section 13.1.4.1 of ANSI C63.4: 2003 Conducted emissions from the EUT measured in the frequency range between 0.15 MHz and 30MHz using CISPR Quasi-peak and average detector modes.

##### **Radiated Emissions**

The EUT is placed on a turn table, which is 0.8 m above ground plane. The turntable shall rotate 360 degrees to determine the position of maximum emission level. EUT is set 3m away from the receiving antenna, which varied from 1m to 4m to find out the highest emission. And also, each emission was to be maximized by changing the polarization of receiving antenna both horizontal and vertical. In order to find out the maximum emissions, exploratory radiated emission measurements were made according to the requirements in Section 13.1.4.1 of ANSI C63.4: 2003.



### 3.4 FCC PART 15.205 RESTRICTED BANDS OF OPERATIONS

(a) Except as shown in paragraph (d) of this section, only spurious emissions are permitted in any of the frequency bands listed below:

MHz	MHz	MHz	GHz
0.090 - 0.110	16.42 - 16.423	399.9 - 410	4.5 - 5.15
<sup>1</sup> 0.495 - 0.505	16.69475 - 16.69525	608 - 614	5.35 - 5.46
2.1735 - 2.1905	16.80425 - 16.80475	960 - 1240	7.25 - 7.75
4.125 - 4.128	25.5 - 25.67	1300 - 1427	8.025 - 8.5
4.17725 - 4.17775	37.5 - 38.25	1435 - 1626.5	9.0 - 9.2
4.20725 - 4.20775	73 - 74.6	1645.5 - 1646.5	9.3 - 9.5
6.215 - 6.218	74.8 - 75.2	1660 - 1710	10.6 - 12.7
6.26775 - 6.26825	108 - 121.94	1718.8 - 1722.2	13.25 - 13.4
6.31175 - 6.31225	123 - 138	2200 - 2300	14.47 - 14.5
8.291 - 8.294	149.9 - 150.05	2310 - 2390	15.35 - 16.2
8.362 - 8.366	156.52475 -	2483.5 - 2500	17.7 - 21.4
8.37625 - 8.38675	156.52525	2655 - 2900	22.01 - 23.12
8.41425 - 8.41475	156.7 - 156.9	3260 - 3267	23.6 - 24.0
12.29 - 12.293	162.0125 - 167.17	3332 - 3339	31.2 - 31.8
12.51975 - 12.52025	167.72 - 173.2	3345.8 - 3358	36.43 - 36.5
12.57675 - 12.57725	240 - 285	3600 - 4400	( <sup>2</sup> )
13.36 - 13.41	322 - 335.4		

<sup>1</sup> Until February 1, 1999, this restricted band shall be 0.490-0.510 MHz.

<sup>2</sup> Above 38.6

(b) Except as provided in paragraphs (d) and (e), the field strength of emissions appearing within these frequency bands shall not exceed the limits shown in Section 15.209. At frequencies equal to or less than 1000 MHz, compliance with the limits in Section 15.209 shall be demonstrated using measurement instrumentation employing a CISPR quasi-peak detector. Above 1000 MHz, compliance with the emission limits in Section 15.209 shall be demonstrated based on the average value of the measured emissions. The provisions in Section 15.35 apply to these measurements.



### **3.5 DESCRIPTION OF TEST MODES**

The EUT (model: RX12) had been tested under operating condition.

Software used to control the EUT for staying in continuous transmitting mode was programmed.

This device is for handheld operation only.

After verification, all tests were carried out with the worst case test modes as shown below except radiated spurious emission below 1GHz a, which worst case was in normal link mode only.

Channel Low, Channel Mid and Channel High were chosen for full testing.

The field strength of spurious emission was measured in the following position: EUT stand-up position (Z axis), lie-down position (X, Y axis). The worst emission was found in lie-down position (X axis) and the worst case was recorded.



## 4. INSTRUMENT CALIBRATION

### 4.1 MEASURING INSTRUMENT CALIBRATION

The measuring equipment, which was utilized in performing the tests documented herein, has been calibrated in accordance with the manufacturer's recommendations for utilizing calibration equipment, which is traceable to recognized national standards.

### 4.2 MEASUREMENT EQUIPMENT USED

#### Equipment Used for Emissions Measurement

*Remark: Each piece of equipment is scheduled for calibration once a year and Loop Antenna is scheduled for calibration once three years.*

Conducted Emissions Test Site				
Name of Equipment	Manufacturer	Model	Serial Number	Calibration Due
Spectrum Analyzer	Agilent	E4446A	MY43360131	03/04/2011

3M Semi Anechoic Chamber				
Name of Equipment	Manufacturer	Model	Serial Number	Calibration Due
Spectrum Analyzer	Agilent	E4446A	US42510252	10/26/2010
EMI Test Receiver	R&S	ESCI	100064	02/04/2011
Pre-Amplifier	Mini-Circuits	ZFL-1000LN	SF350700823	01/13/2011
Pre-Amplifier	MITEQ	AFS44-00102650-42-10P-44	1415367	11/20/2010
Bilog Antenna	Sunol Sciences	JB3	A030105	09/10/2011
Horn Antenna	EMCO	3117	00055165	12/07/2010
Loop Antenna	EMCO	6502	8905/2356	06/10/2013
Turn Table	CCS	CC-T-1F	N/A	N.C.R
Antenna Tower	CCS	CC-A-1F	N/A	N.C.R
Controller	CCS	CC-C-1F	N/A	N.C.R
Site NSA	CCS	N/A	N/A	12/31/2010
Test S/W	EZ-EMC (CCS-3A1RE)			

### 4.3 MEASUREMENT UNCERTAINTY

PARAMETER	UNCERTAINTY
3M Semi Anechoic Chamber / 30M~200M	+/- 4.0606
3M Semi Anechoic Chamber / 200M~1000M	+/- 3.9979
3M Semi Anechoic Chamber / 1G~8G	+/- 2.5790
3M Semi Anechoic Chamber / 8G~18G	+/- 2.5928
3M Semi Anechoic Chamber / 18G~26G	+/- 2.7212
3M Semi Anechoic Chamber / 26G~40G	+/- 2.9520

*Remark: This uncertainty represents an expanded uncertainty expressed at approximately the 95% confidence level using a coverage factor of k=2.*





## **5. FACILITIES AND ACCREDITATIONS**

### **5.1 FACILITIES**

All measurement facilities used to collect the measurement data are located at

No.199, Chunghsen Road, Hsintien City, Taipei Hsien, Taiwan, R.O.C.  
Tel: 886-2-2217-0894 / Fax: 886-2-2217-1029

No.11, Wugong 6th Rd., Wugu Industrial Park, Taipei Hsien 248, Taiwan  
Tel: 886-2-2299-9720 / Fax: 886-2-2298-4045

No.81-1, Lane 210, Bade 2nd Rd., Luchu Hsiang, Taoyuan Hsien 338, Taiwan  
Tel: 886-3-324-0332 / Fax: 886-3-324-5235

The sites are constructed in conformance with the requirements of ANSI C63.7, ANSI C63.4 and CISPR Publication 22.

### **5.2 EQUIPMENT**

Radiated emissions are measured with one or more of the following types of linearly polarized antennas: tuned dipole, biconical, log periodic, bi-log, and/or ridged waveguide, horn. Spectrum analyzers with pre-selectors and quasi-peak detectors are used to perform radiated measurements.



Conducted emissions are measured with Line Impedance Stabilization Networks and EMI Test Receivers.

Calibrated wideband preamplifiers, coaxial cables, and coaxial attenuators are also used for making measurements.

All receiving equipment conforms to CISPR Publication 16-1, "Radio Interference Measuring Apparatus and Measurement Methods."



### 5.3 TABLE OF ACCREDITATIONS AND LISTINGS

Country	Agency	Scope of Accreditation	Logo
USA	FCC	3M Semi Anechoic Chamber (FCC MRA: TW1039) to perform FCC Part 15 measurements	
Taiwan	TAF	LP0002, RTTE01, FCC Method-47 CFR Part 15 Subpart C, D, E, RSS-210, RSS-310 IDA TS SRD, AS/NZS 4268, AS/NZS 4771, TS 12.1 & 12.2, ETSI EN 300 440-1, ETSI EN 300 440-2, ETSI EN 300 328, ETSI EN 300 220-1, ETSI EN 300 220-2, ETSI EN 301 893, ETSI EN 301 489-1/3/7/17 FCC OET Bulletin 65 + Supplement C, EN 50360, EN 50361, EN 50371, RSS 102, EN 50383, EN 50385, EN 50392, IEC 62209, CNS 14958-1, CNS 14959 FCC Method -47 CFR Part 15 Subpart B IEC / EN 61000-3-2, IEC / EN 61000-3-3, IEC / EN 61000-4-2/3/4/5/6/8/11	
Canada	Industry Canada	3M Semi Anechoic Chamber (IC 2324G-1 / IC 2324G-2) to perform	

\* No part of this report may be used to claim or imply product endorsement by A2LA or any agency of the US Government.



## 6. SETUP OF EQUIPMENT UNDER TEST

### 6.1 SETUP CONFIGURATION OF EUT

See test photographs attached in Appendix I for the actual connections between EUT and support equipment.

### 6.2 SUPPORT EQUIPMENT

No.	Device Type	Brand	Model	Series No.	FCC ID	Data Cable	Power Cord
1.	Power Supply	Agilent	E3640A	N/A	FCC DoC	N/A	Unshielded, 1.8m
2.	car alarm system	PORTMAN	AM9600C	N/A	N/A	N/A	N/A

**Remark:**

1. *All the equipment/cables were placed in the worst-case configuration to maximize the emission during the test.*
2. *Grounding was established in accordance with the manufacturer's requirements and conditions for the intended use.*



## 7. FCC PART 15.247 REQUIREMENTS

### 7.1 20 DB BANDWIDTH

#### LIMIT

None; for reporting purposes only.

#### Test Configuration

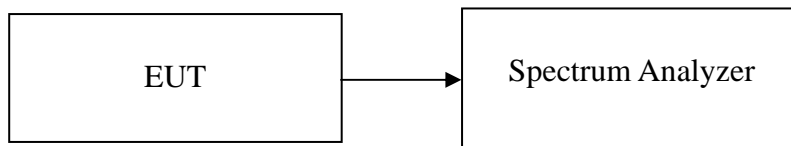

#### TEST PROCEDURE

1. Place the EUT on the table and set it in the transmitting mode.
2. Remove the antenna from the EUT and then connect a low loss RF cable from the antenna port to the spectrum analyzer.
3. Set the spectrum analyzer as RBW = 10kHz, VBW = 30kHz, Span = 1.5MHz, Sweep = Auto.
4. Mark the peak frequency and 20dB (upper and lower) frequency.
5. Repeat until all the rest channels are investigated.

#### TEST RESULTS

*No non-compliance noted.*

#### Test Data

Channel	Frequency (MHz)	20dB Bandwidth (kHz)
Low	910.0	286
Mid	914.2	273
High	918.4	285



### Test Plot

#### 20dB Bandwidth (CH Low)

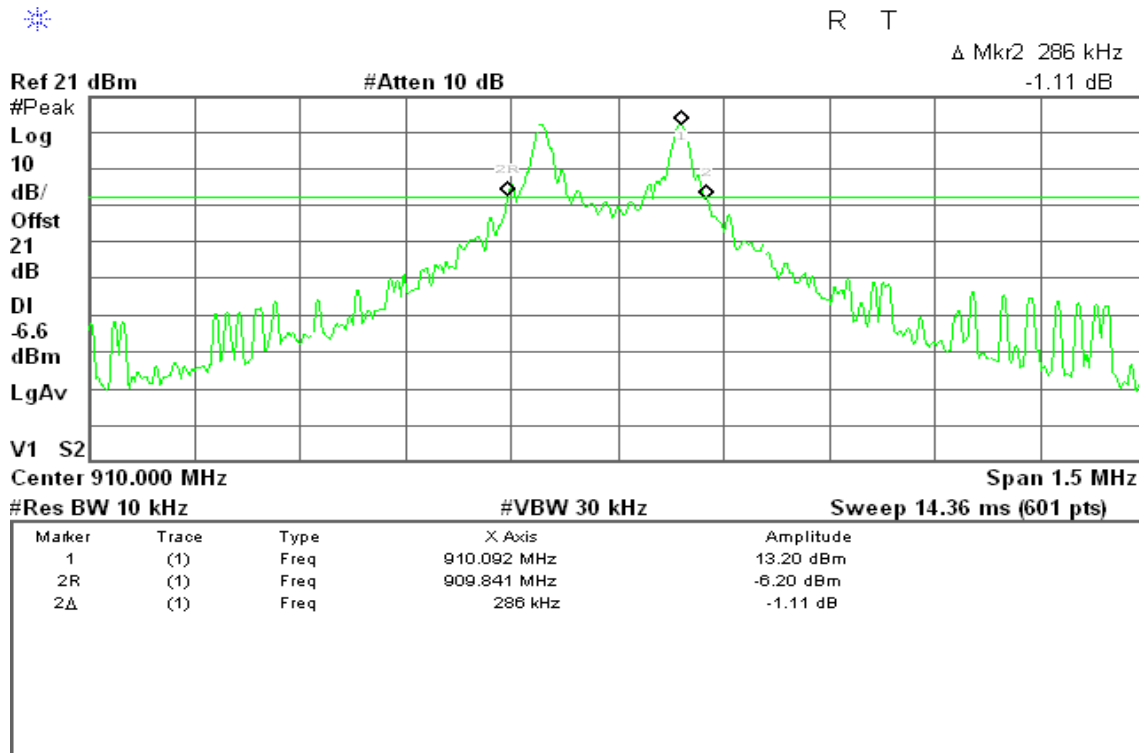

#### 20dB Bandwidth (CH Mid)

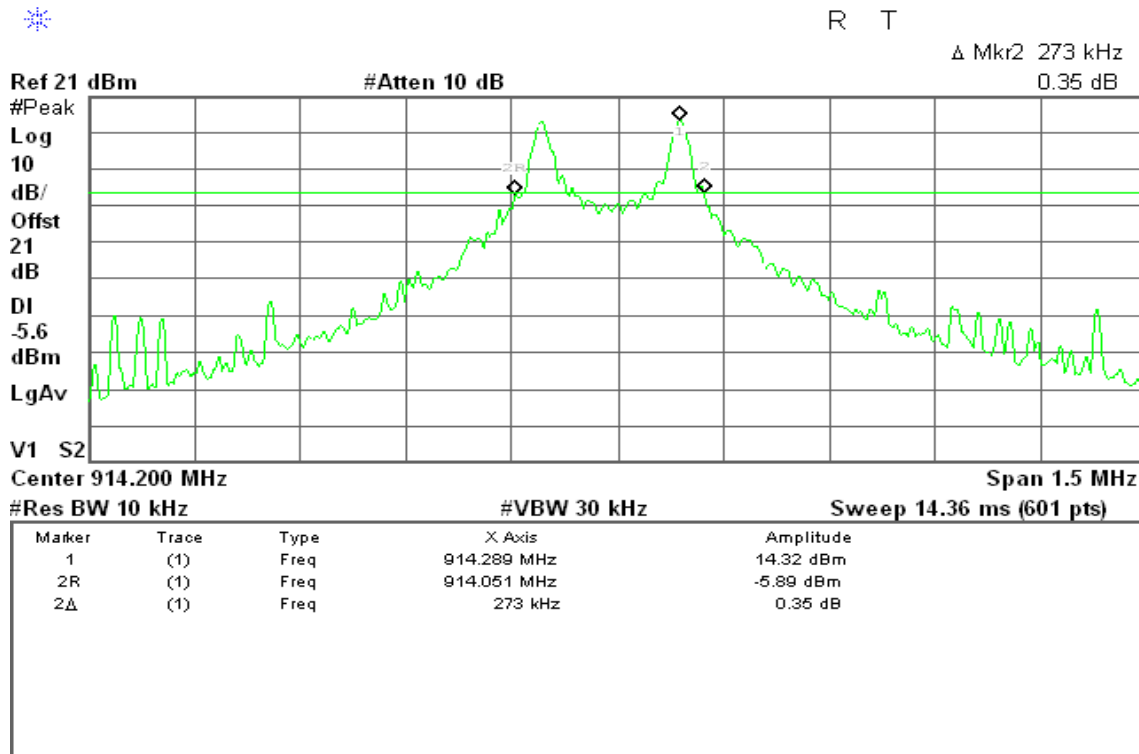



### 20dB Bandwidth (CH High)



R T

Δ Mkr2 285 kHz  
-0.34 dB

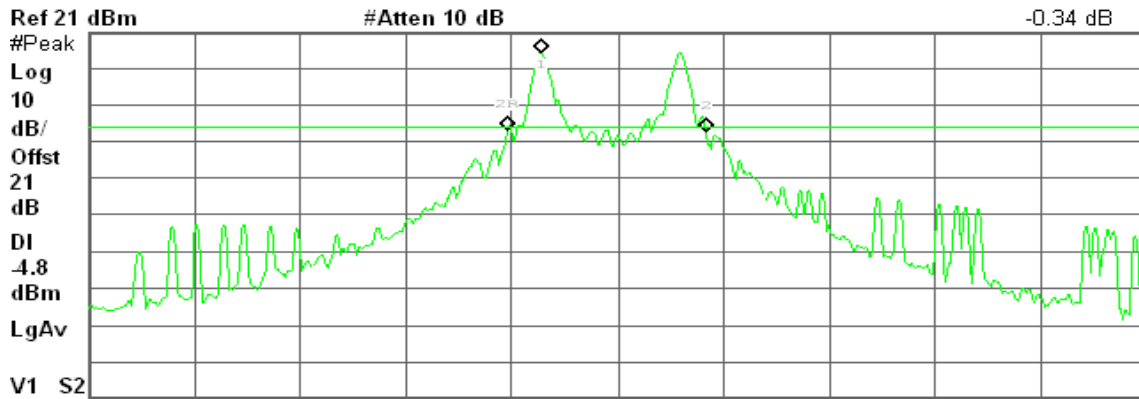

Center 918.400 MHz

Span 1.5 MHz

#Res BW 10 kHz

#VBW 30 kHz

Sweep 14.36 ms (601 pts)

Marker	Trace	Type	X Axis	Amplitude
1	(1)	Freq	918.290 MHz	15.22 dBm
2R	(1)	Freq	918.242 MHz	-5.82 dBm
2Δ	(1)	Freq	285 kHz	-0.34 dB



## 7.2 PEAK POWER

### LIMIT

The maximum peak output power of the intentional radiator shall not exceed the following:

1. According to §15.247(a)(1), Frequency hopping systems shall have hopping channel carrier frequencies separated by a minimum of 25 kHz or the 20 dB bandwidth of the hopping channel, whichever is greater. Alternatively, frequency hopping systems operating in the 2400-2483.5 MHz band may have hopping channel carrier frequencies that are separated by 25 kHz or two-thirds of the 20 dB bandwidth of the hopping channel, whichever is greater, provided the systems operate with an output power no greater than 125 mW.
2. According to §15.247(b)(2) For frequency hopping systems operating in the 902-928 MHz band: 1 watt for systems employing at least 50 hopping channels; and, 0.25 watts for systems employing less than 50 hopping channels, but at least 25 hopping channels, as permitted under paragraph (a)(1)(i) of this section.
3. According to §15.247(b)(3), for systems using digital modulation in the bands of 902-928 MHz, 2400-2483.5 MHz, and 5725-5850 MHz: 1 Watt.
4. According to §15.247(b)(4), the conducted output power limit specified in paragraph (b) of this section is based on the use of antennas with directional gains that do not exceed 6 dBi. Except as shown in paragraph (c) of this section, if transmitting antennas of directional gain greater than 6 dBi are used, the conducted output power from the intentional radiator shall be reduced below the stated values in paragraphs (b)(1), (b)(2), and (b)(3) of this section, as appropriate, by the amount in dB that the directional gain of the antenna exceeds 6 dBi.

### Test Configuration

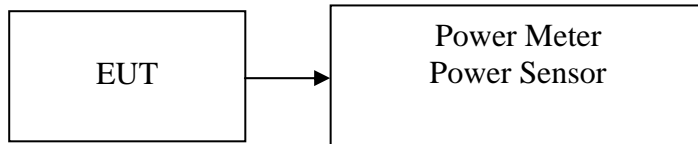

### TEST PROCEDURE

The transmitter output is connected to the Power Meter. The Power Meter is set to the peak power detection.

### TEST RESULTS

*No non-compliance noted.*

#### Test Data

Channel	Frequency (MHz)	Output Power (dBm)	Output Power (W)	Limit (dBm)	Limit (W)	Result
Low	910.0	7.96	0.00625	21.0394	0.127039	PASS
Mid	914.2	7.87	0.00612			PASS
High	918.4	7.91	0.00618			PASS

**Remark:** The maximum antenna gain is 8.94dBi; therefore the reduction due to antenna gain is 2.94dB, so the limit is 21.0394 dBm.



### 7.3 AVERAGE POWER

#### LIMIT

None; for reporting purposes only.

#### Test Configuration

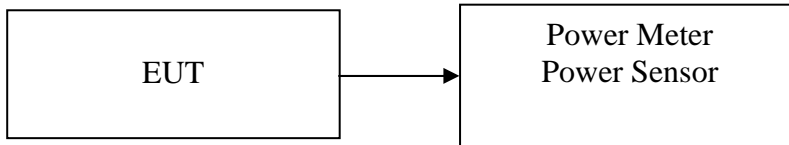

#### TEST PROCEDURE

The transmitter output is connected to the Power Meter. The Power Meter is set to the peak power detection.

#### TEST RESULTS

*No non-compliance noted.*

#### Test Data

Channel	Frequency (MHz)	Output Power (dBm)	Output Power (W)
Low	910.0	7.90	0.00617
Mid	914.2	7.82	0.00605
High	918.4	7.86	0.00611





## 7.4 BAND EDGES MEASUREMENT

### LIMIT

According to §15.247(d), in any 100 kHz bandwidth outside the frequency bands in which the spread spectrum intentional radiator is operating, the radio frequency power that is produced by the intentional radiator shall be at least 20 dB below that in the 100 kHz bandwidth within the band that contains the highest level of the desired power, based on either an RF conducted or a radiated measurement, provided the transmitter demonstrates compliance with the peak conducted power limits. In addition, radiated emissions which fall in the restricted bands, as defined in §15.205(a), must also comply with the radiated emission limits specified in 15.209(a) (see Section 15.205(c)).

### Test Configuration

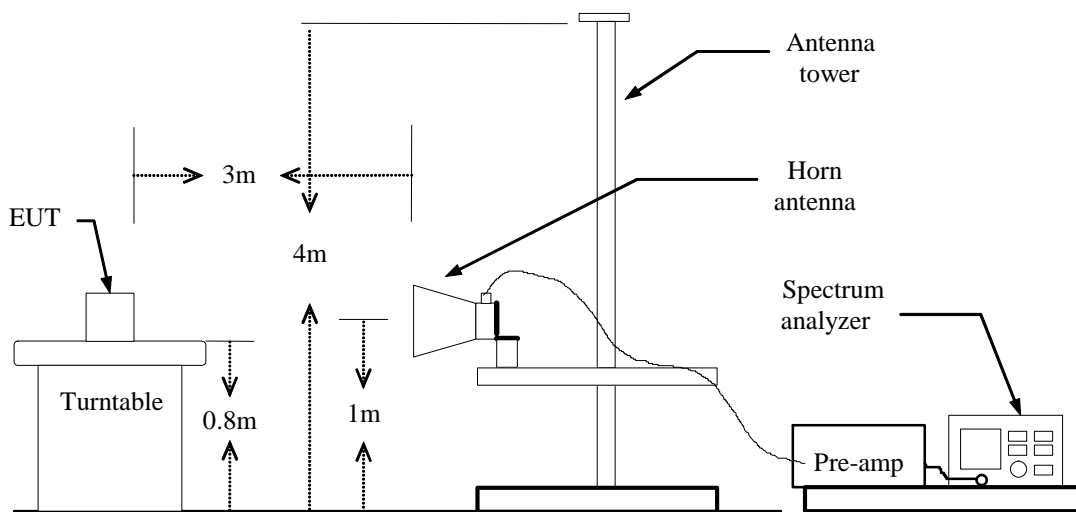

### TEST PROCEDURE

1. The EUT is placed on a turntable, which is 0.8m above the ground plane.
2. The turntable shall be rotated for 360 degrees to determine the position of maximum emission level.
3. EUT is set 3m away from the receiving antenna, which is varied from 1m to 4m to find out the highest emission.
4. Set the spectrum analyzer in the following setting in order to capture the lower and upper band-edges of the emission:
  - (a) PEAK: RBW=VBW=1MHz / Sweep=AUTO
  - (b) AVERAGE: RBW=1MHz / VBW=10Hz / Sweep=AUTO
5. Repeat the procedures until all the PEAK and AVERAGE versus POLARIZATION are measured.

### TEST RESULTS

1. Operating Frequency: 910 - 918.4 MHz
2. CH Low: 910MHz, CH High: 918.4MHz
3. 20dB Bandwidth: 286kHz

Because the mentioned conditions, the operating frequency is in frequency bands 910 - 918.4 MHz, the test is not applicable.



## 7.5 FREQUENCY SEPARATION

### LIMIT

According to §15.247(a)(1)(i), For frequency hopping systems operating in the 902-928 MHz band: if the 20 dB bandwidth of the hopping channel is less than 250 kHz, the system shall use at least 50 hopping frequencies and the average time of occupancy on any frequency shall not be greater than 0.4 seconds within a 20 second period; if the 20 dB bandwidth of the hopping channel is 250 kHz or greater, the system shall use at least 25 hopping frequencies and the average time of occupancy on any frequency shall not be greater than 0.4 seconds within a 10 second period. The maximum allowed 20 dB bandwidth of the hopping channel is 500 kHz.

### Test Configuration

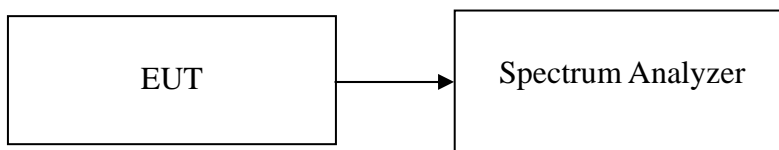

### TEST PROCEDURE

1. Place the EUT on the table and set it in transmitting mode.
2. Remove the antenna from the EUT and then connect a low loss RF cable from the antenna port to the spectrum analyzer.
3. Set center frequency of spectrum analyzer = middle of hopping channel.
4. Set the spectrum analyzer as RBW = 51kHz, VBW = 51kHz, Span = 1MHz, Sweep = 1ms.
5. Max hold, mark 3 peaks of hopping channel and record the 3 peaks frequency.

### TEST RESULTS

*No non-compliance noted*

#### Test Data

Channel Separation (MHz)	20dB Bandwidth (kHz)	Channel Separation Limit	Result
0.35	286	20dB Bandwidth	Pass



**Test Plot**

**Measurement of Channel Separation**

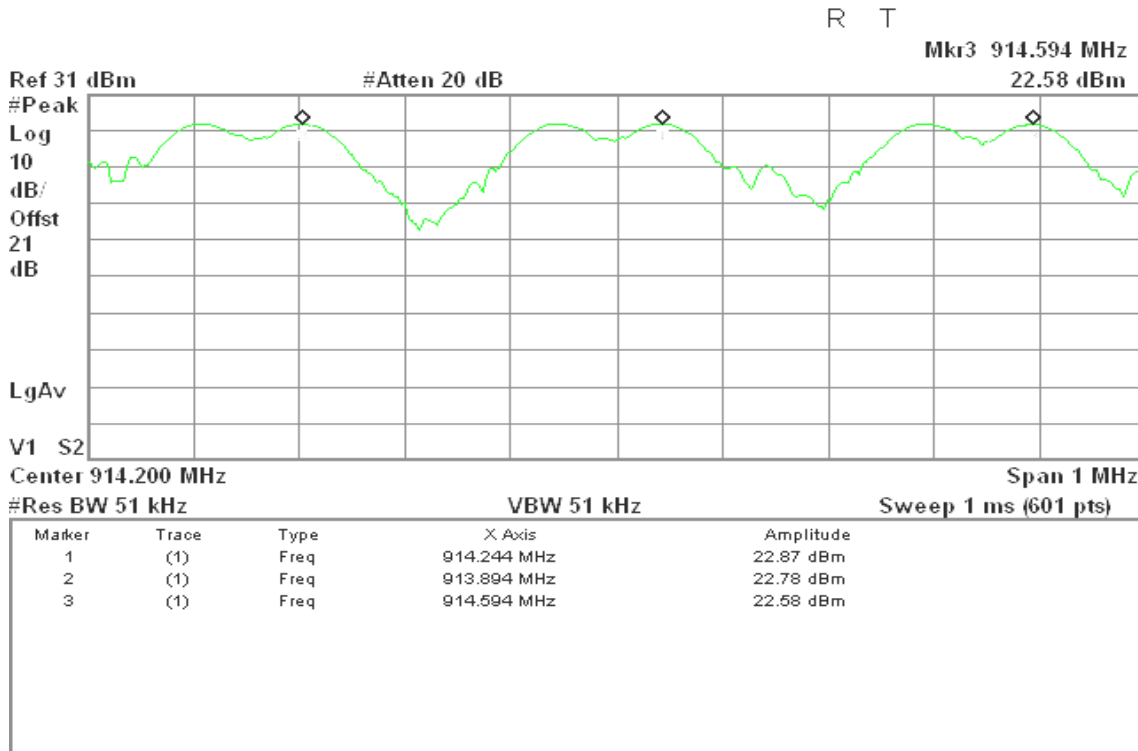

**Measurement of 20dB Bandwidth**

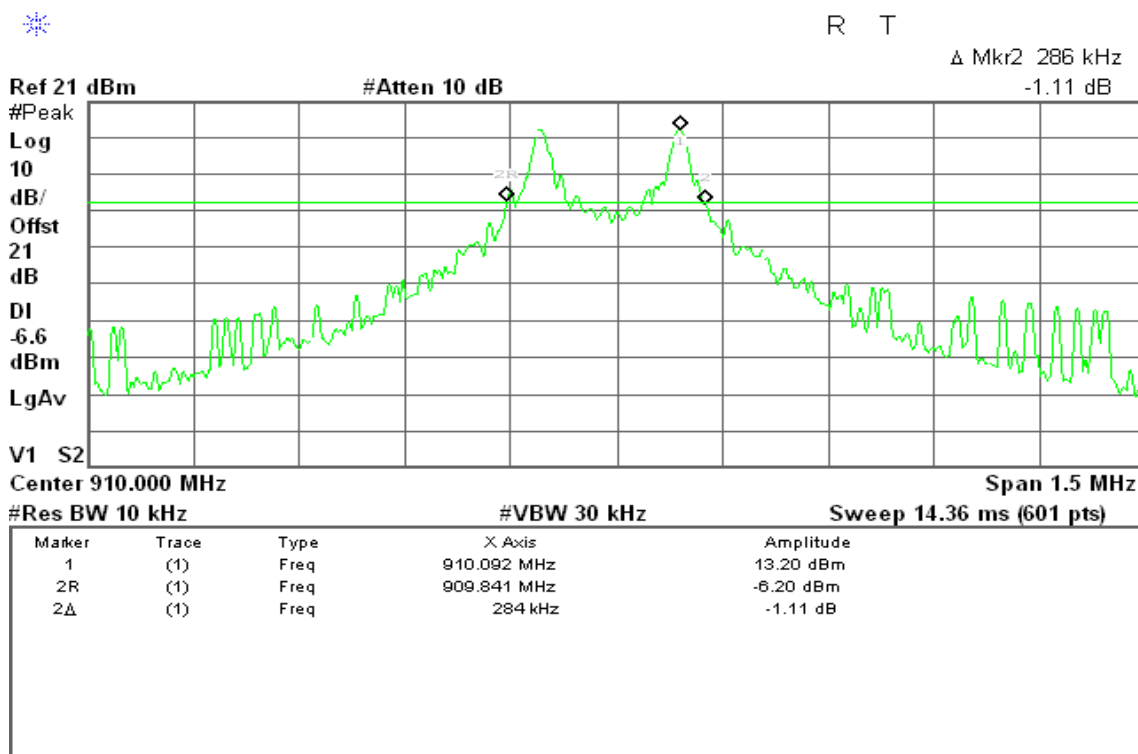



## 7.6 NUMBER OF HOPPING FREQUENCY

### LIMIT

According to §15.247(b)(2), For frequency hopping systems operating in the 902-928 MHz band: 1 watt for systems employing at least 50 hopping channels; and, 0.25 watts for systems employing less than 50 hopping channels, but at least 25 hopping channels, as permitted under paragraph (a)(1)(i) of this section.

### Test Configuration

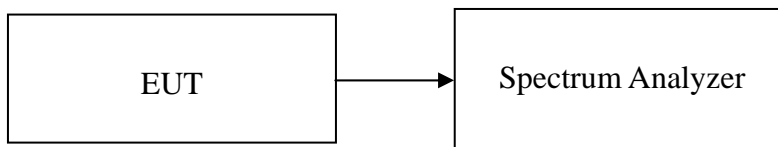

### TEST PROCEDURE

1. Place the EUT on the table and set it in transmitting mode.
2. Remove the antenna from the EUT and then connect a low loss RF cable from the antenna port to the spectrum analyzer.
3. Set spectrum analyzer Start=909MHz, Stop =920MHz, Sweep = 14.76ms.
4. Set the spectrum analyzer as RBW, VBW = 30kHz.
5. Max hold, view and count how many channel in the band.

### TEST RESULTS

*No non-compliance noted*

#### Test Data

Result (No. of CH)	Limit (No. of CH)	Result
25	$\geq 25$	PASS



**Test Plot**

**Channel Number**

\* Agilent 14:12:19 Jul 14, 2010

R T

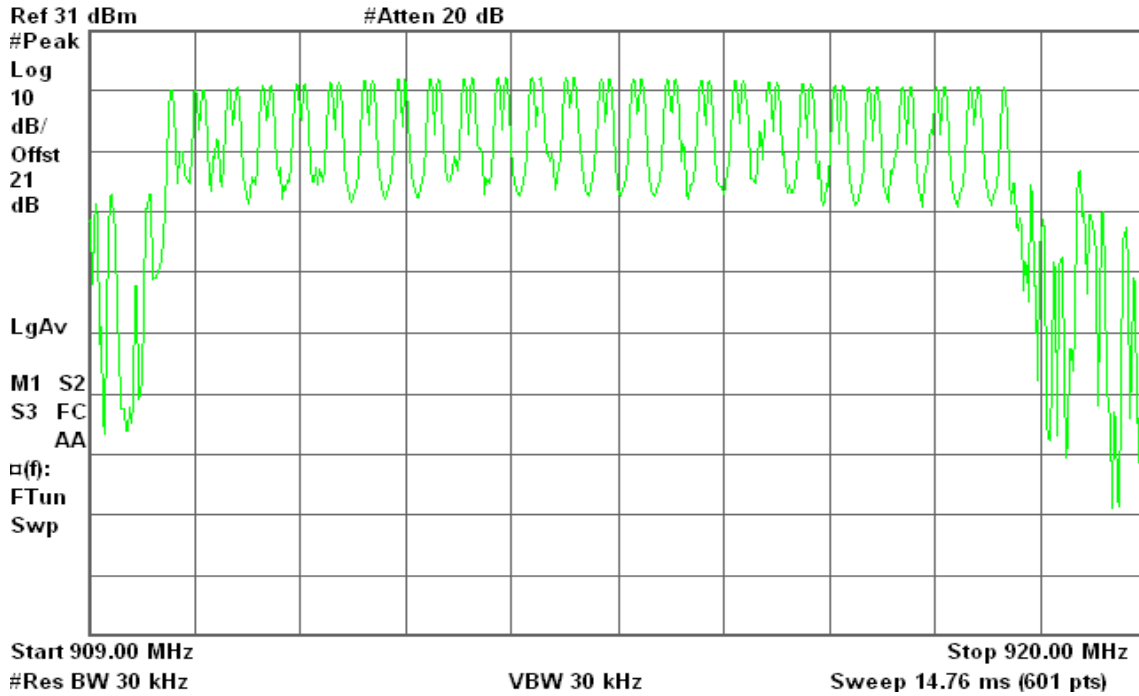



## 7.7 TIME OF OCCUPANCY (DWELL TIME)

### LIMIT

According to §15.247(a)(1)(i), For frequency hopping systems operating in the 902-928 MHz band: if the 20 dB bandwidth of the hopping channel is less than 250 kHz, the system shall use at least 50 hopping frequencies and the average time of occupancy on any frequency shall not be greater than 0.4 seconds within a 20 second period; if the 20 dB bandwidth of the hopping channel is 250 kHz or greater, the system shall use at least 25 hopping frequencies and the average time of occupancy on any frequency shall not be greater than 0.4 seconds within a 10 second period. The maximum allowed 20 dB bandwidth of the hopping channel is 500 kHz.

### Test Configuration

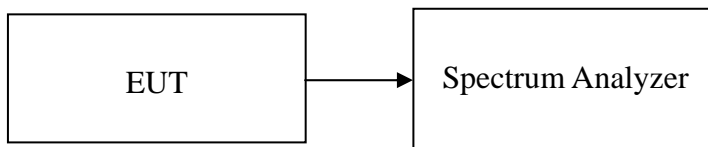

### TEST PROCEDURE

The transmitter output is connected to a spectrum analyzer. The span is set to 0 Hz, centered on a single, selected hopping channel. The width of a single pulse is measured in a fast scan. The number of pulses is measured in a 1 second scan, to enable resolution of each occurrence.

The average time of occupancy in the specified 10 second period (25 channels \* 0.4 s) is equal to  $10 * (\# \text{ of pulses in } 1.0 \text{ s}) * \text{ pulse width}$ .

### TEST RESULTS

*No non-compliance noted*

$$\begin{aligned} \text{Average time of occupancy} &= 9 * (43.89\text{ms}) \\ &= 9 * (0.04389\text{s}) \\ &= 0.3950\text{s} \end{aligned}$$



### Test Plot

#### Pulse width

Agilent 14:33:26 Jul 14, 2010

R T

Δ Mkr1 43.89 ms  
-0.11 dB

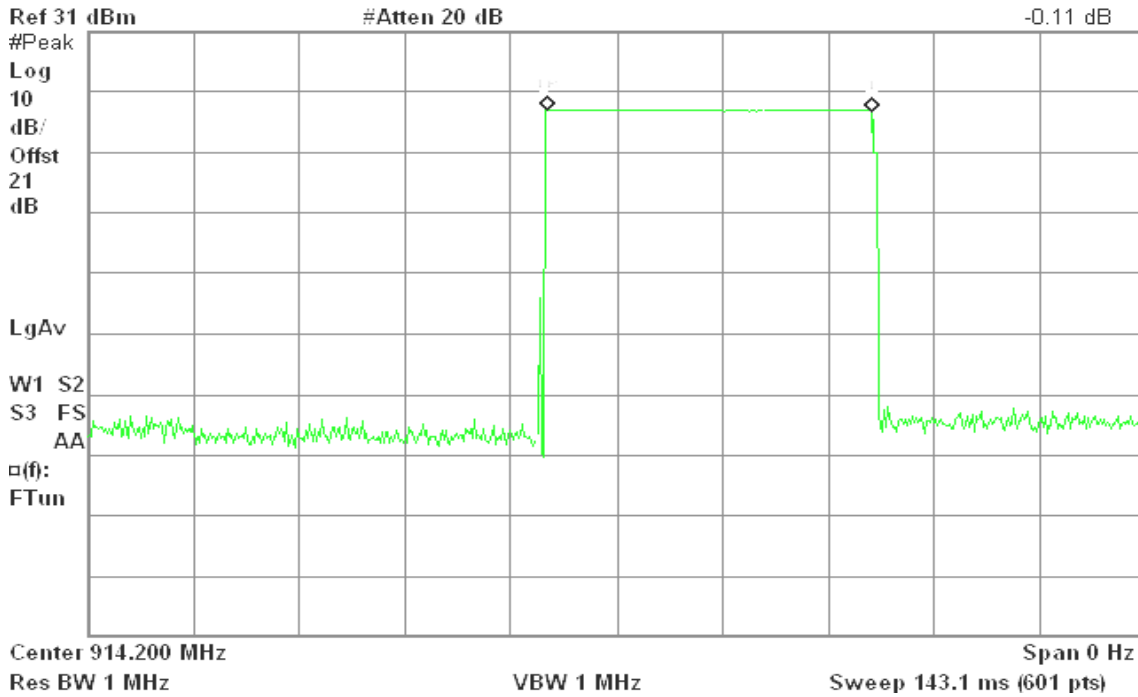

#### Number of pulses in 10 second observation period

Agilent 14:24:38 Jul 14, 2010

R T

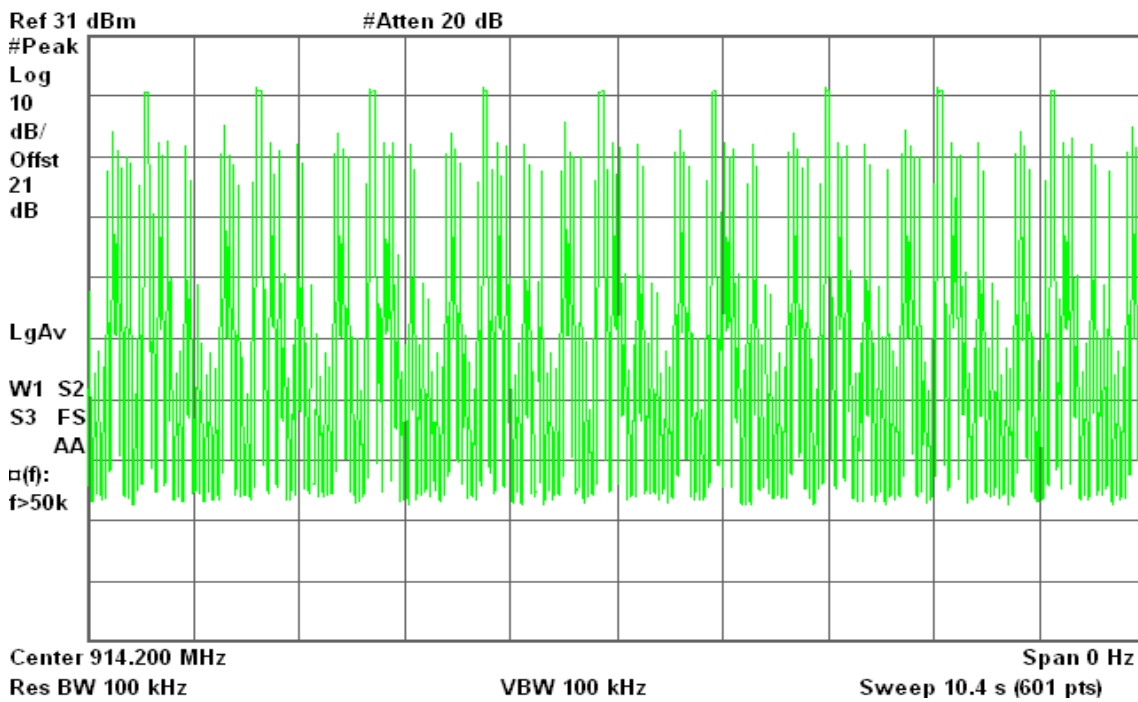



## 7.8 SPURIOUS EMISSIONS

### 7.8.1 Conducted Measurement

#### LIMIT

According to §15.247(d), in any 100 kHz bandwidth outside the frequency bands in which the spread spectrum intentional radiator is operating, the radio frequency power that is produced by the intentional radiator shall be at least 20 dB below that in the 100 kHz bandwidth within the band that contains the highest level of the desired power, based on either an RF conducted or a radiated measurement, provided the transmitter demonstrates compliance with the peak conducted power limits. In addition, radiated emissions which fall in the restricted bands, as defined in §15.205(a), must also comply with the radiated emission limits specified in 15.209(a) (see Section 15.205(c)).

#### Test Configuration

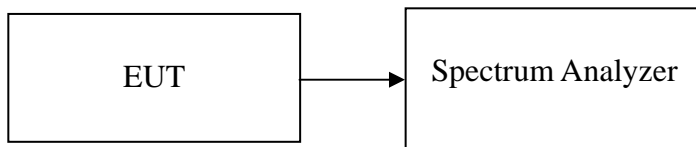

#### TEST PROCEDURE

Conducted RF measurements of the transmitter output were made to confirm that the EUT antenna port conducted emissions meet the specified limit and to identify any spurious signals that require further investigation or measurements on the radiated emissions site.

The transmitter output is connected to the spectrum analyzer. The resolution bandwidth is set to 100 kHz. The video bandwidth is set to 100 kHz.

Measurements are made over the 30MHz to 26GHz range with the transmitter set to the lowest, middle, and highest channels.

#### TEST RESULTS

*No non-compliance noted*





### Test Plot

#### CH Low

Agilent 15:38:09 Jul 20, 2010

R T

Mkr4 3.62 GHz

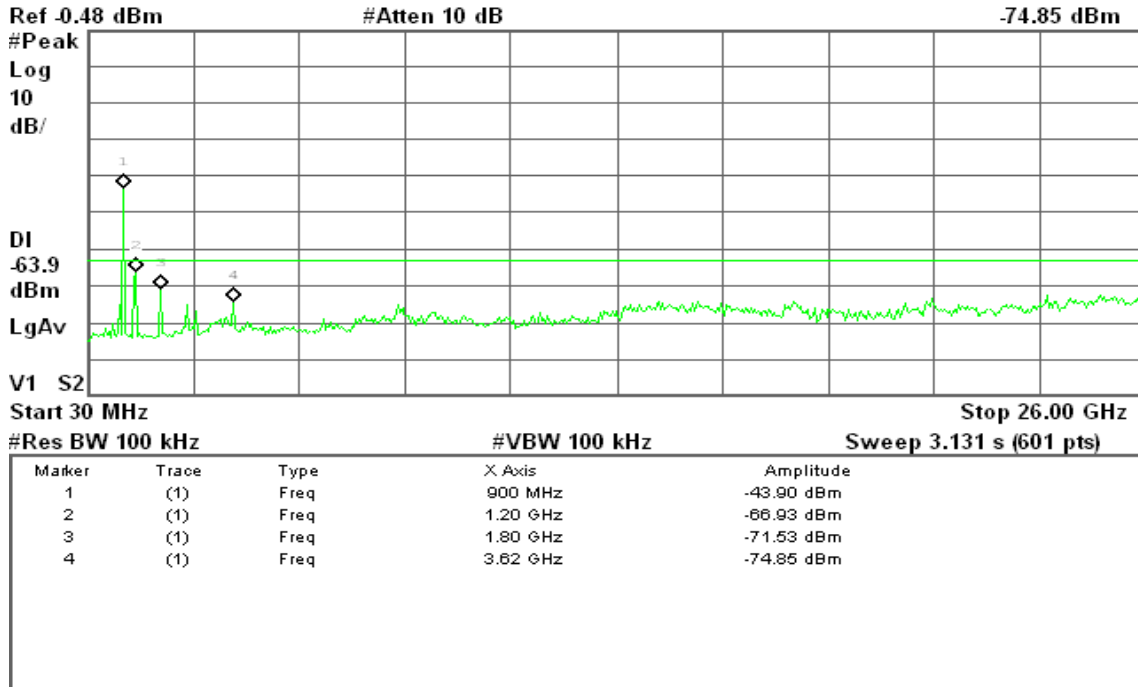

#### CH Mid

Agilent 15:32:56 Jul 20, 2010

R T

Mkr4 6.39 GHz

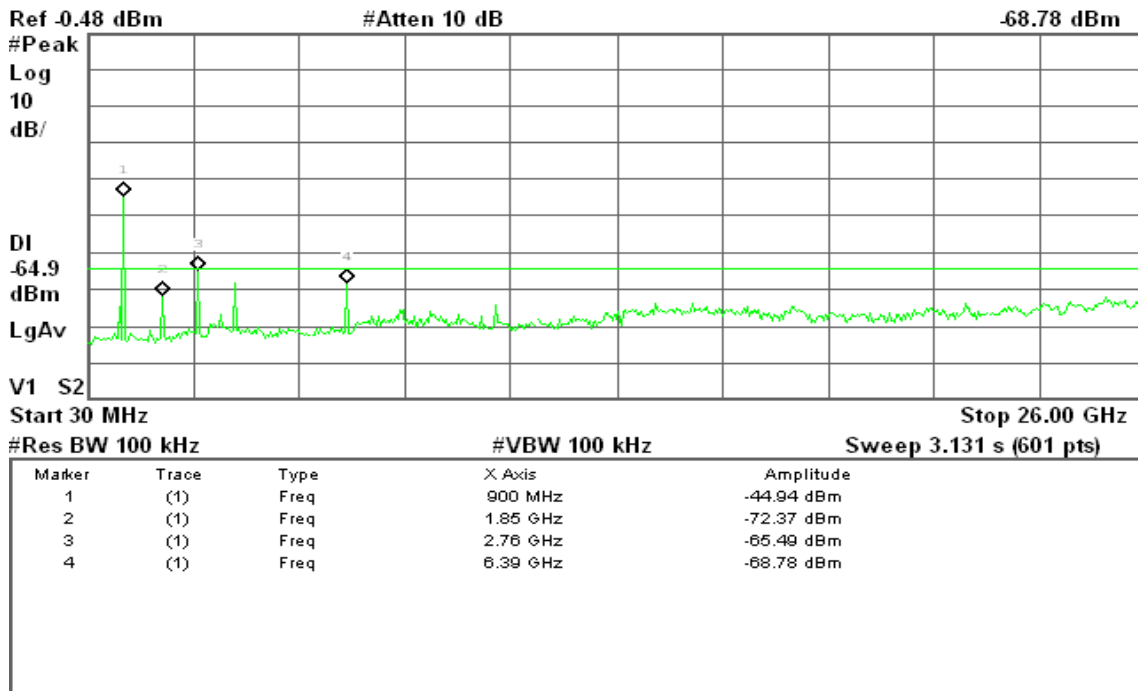



### CH High

Agilent 15:34:32 Jul 20, 2010

R T

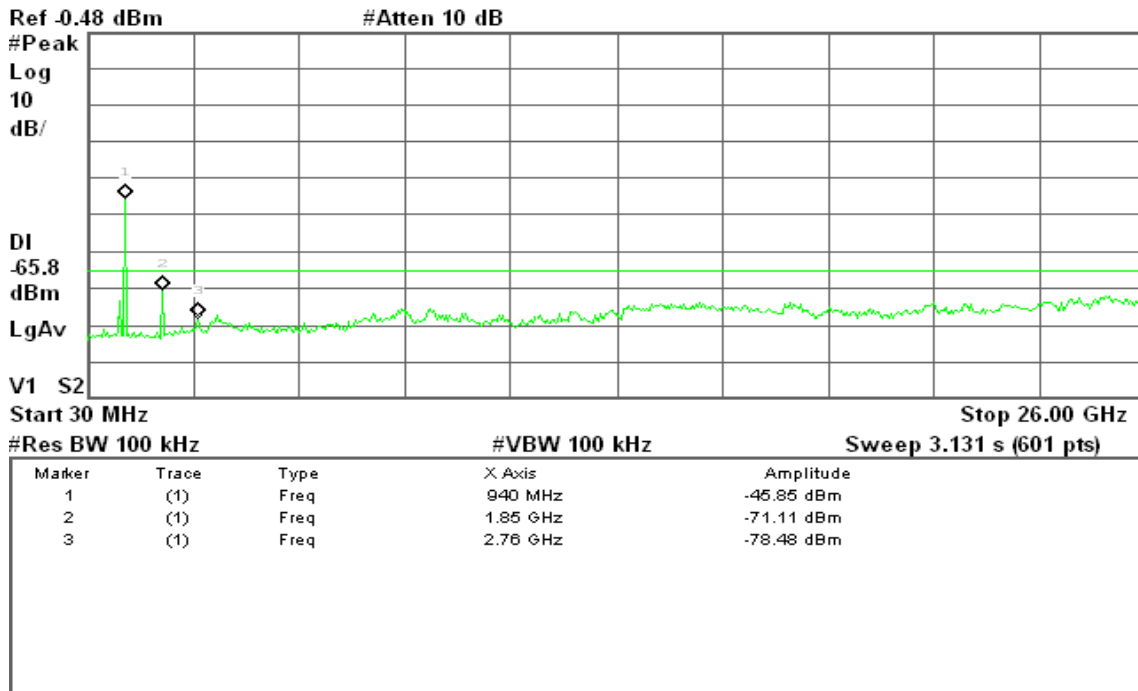



## 7.8.2 Radiated Emissions

### LIMIT

1. According to §15.209(a), except as provided elsewhere in this Subpart, the emissions from an intentional radiator shall not exceed the field strength levels specified in the following table:

Frequency (MHz)	Field Strength ( $\mu\text{V/m}$ )	Measurement Distance (m)
30-88	100*	3
88-216	150*	3
216-960	200*	3
Above 960	500	3

*Remark: Except as provided in paragraph (g), fundamental emissions from intentional radiators operating under this Section shall not be located in the frequency bands 54-72 MHz, 76-88 MHz, 174-216 MHz or 470-806 MHz. However, operation within these frequency bands is permitted under other sections of this Part, e.g., Sections 15.231 and 15.241.*

2. In the emission table above, the tighter limit applies at the band edges.

Frequency (MHz)	Field Strength ( $\mu\text{V/m}$ at 3-meter)	Field Strength (dB $\mu\text{V/m}$ at 3-meter)
30-88	100	40
88-216	150	43.5
216-960	200	46
Above 960	500	54



### Test Configuration

9kHz ~ 30MHz

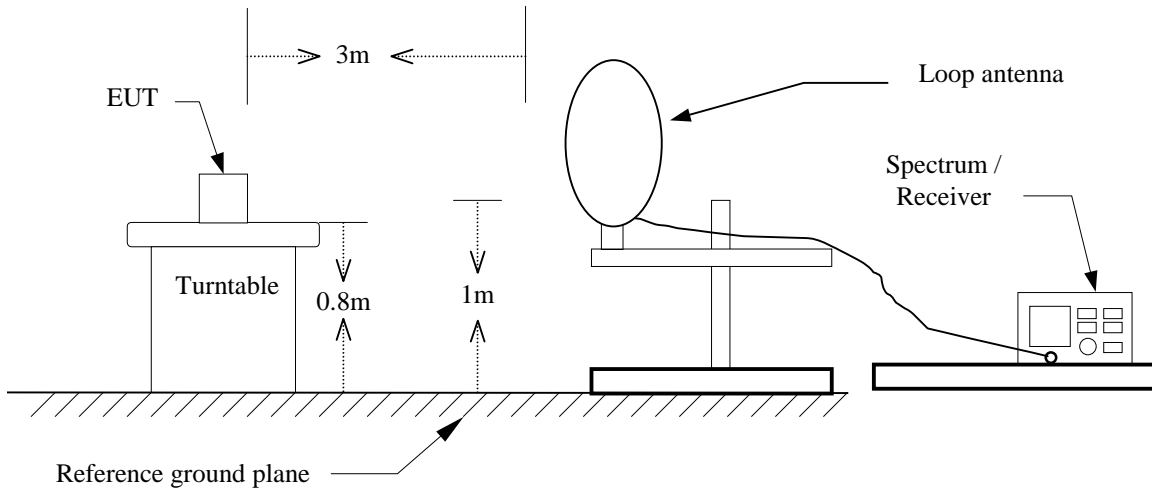

### Below 1 GHz

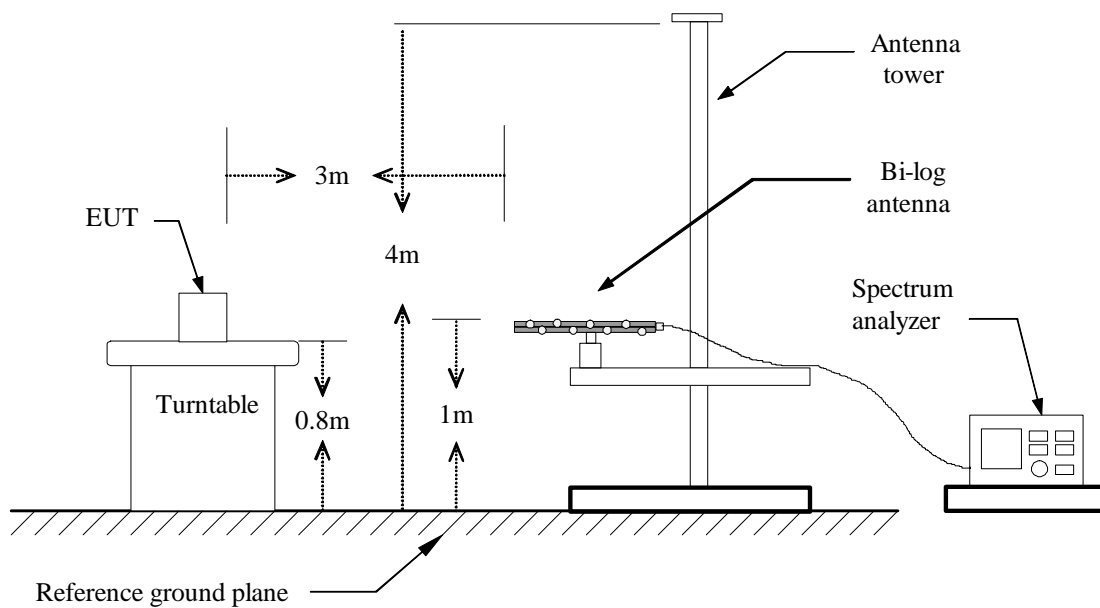



## Above 1 GHz

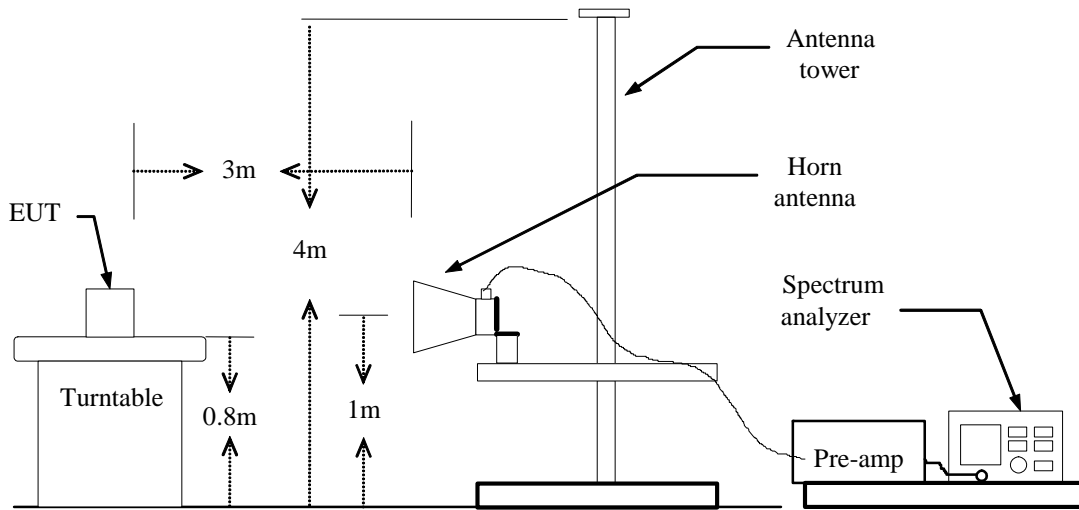

## TEST PROCEDURE

1. The EUT is placed on a turntable, which is 0.8m above ground plane.
2. The turntable shall be rotated for 360 degrees to determine the position of maximum emission level.
3. EUT is set 3m away from the receiving antenna, which is varied from 1m to 4m to find out the highest emissions.
4. Maximum procedure was performed on the six highest emissions to ensure EUT compliance.
5. And also, each emission was to be maximized by changing the polarization of receiving antenna both horizontal and vertical.
6. Set the spectrum analyzer in the following setting as:

Below 1GHz:

RBW=100kHz / VBW=300kHz / Sweep=AUTO

Above 1GHz:

(a) PEAK: RBW=VBW=1MHz / Sweep=AUTO

(b) AVERAGE: RBW=1MHz / VBW=10Hz / Sweep=AUTO

7. Repeat above procedures until the measurements for all frequencies are complete.



**Below 1 GHz**

**Operation Mode:** CH Low

**Test Date:** July 8, 2010

**Temperature:** 22°C

**Tested by:** Ming Chen

**Humidity:** 51 % RH

**Polarity:** Ver. / Hor.

Frequency (MHz)	Ant.Pol. (H/V)	Reading (dBuV)	Correction Factor (dB/m)	Result (dBuV/m)	Limit (dBuV/m)	Margin (dB)	Remark
243.40	V	39.04	-11.03	28.02	46.00	-17.98	Peak
296.75	V	37.00	-9.27	27.73	46.00	-18.27	Peak
647.57	V	31.68	-2.95	28.73	46.00	-17.27	Peak
707.38	V	34.78	-2.43	32.34	46.00	-13.66	Peak
728.40	V	29.95	-2.13	27.82	46.00	-18.18	Peak
809.23	V	39.03	-1.25	37.78	46.00	-8.22	Peak
201.37	H	31.93	-10.03	21.90	43.50	-21.60	Peak
243.40	H	26.33	-11.03	15.30	46.00	-30.70	Peak
296.75	H	24.54	-9.27	15.27	46.00	-30.73	Peak
405.07	H	28.53	-6.97	21.57	46.00	-24.43	Peak
707.38	H	40.73	-2.43	38.30	46.00	-7.70	Peak
809.23	H	45.05	-1.25	43.81	46.00	-2.19	Peak

**Remark:**

1. No emission found between lowest internal used/generated frequency to 30MHz (9kHz~30MHz).
2. Radiated emissions measured were made with an instrument using peak/quasi-peak detector mode.
3. Quasi-peak test would be performed if the peak result were greater than the quasi-peak limit or as required by the applicant.
4. Measurements above show only up to 6 maximum emissions noted, or would be lesser, with " N/A " remark, if no specific emissions from the EUT are recorded (ie: margin>20dB from the applicable limit) and considered that's already beyond the background noise floor.
5. Margin (dB) = Remark result (dBuV/m) – Quasi-peak limit (dBuV/m).



Operation Mode: CH Mid

Test Date: July 8, 2010

Temperature: 22°C

Tested by: Ming Chen

Humidity: 51 % RH

Polarity: Ver. / Hor.

Frequency (MHz)	Ant.Pol. (H/V)	Reading (dBuV)	Correction Factor (dB/m)	Result (dBuV/m)	Limit (dBuV/m)	Margin (dB)	Remark
243.40	V	26.41	-11.03	15.39	46.00	-30.61	Peak
351.72	V	23.98	-8.02	15.96	46.00	-30.04	Peak
406.68	V	28.54	-6.93	21.62	46.00	-24.38	Peak
427.70	V	24.64	-6.41	18.23	46.00	-27.77	Peak
686.37	V	23.98	-2.64	21.35	46.00	-24.65	Peak
812.47	V	46.16	-1.21	44.95	46.00	-1.05	QP
135.08	H	23.27	-9.82	13.46	43.50	-30.04	Peak
243.40	H	23.70	-11.03	12.67	46.00	-33.33	Peak
296.75	H	26.27	-9.27	16.99	46.00	-29.01	Peak
406.68	H	28.61	-6.93	21.69	46.00	-24.31	Peak
649.18	H	23.25	-2.91	20.34	46.00	-25.66	Peak
812.47	H	44.39	-1.21	43.18	46.00	-2.82	QP

**Remark:**

1. No emission found between lowest internal used/generated frequency to 30MHz (9kHz~30MHz)
2. Radiated emissions measured in frequency range from 30 MHz to 1000MHz, were made with an instrument using peak/quasi-peak detector mode.
3. Quasi-peak test would be performed if the peak result were greater than the quasi-peak limit or as required by the applicant.
4. Measurements above show only up to 6 maximum emissions noted, or would be lesser, with " N/A " remark, if no specific emissions from the EUT are recorded (ie: margin>20dB from the applicable limit) and considered that's already beyond the background noise floor.
5. Margin (dB) = Remark result (dBuV/m) – Quasi-peak limit (dBuV/m).



Operation Mode: CH High

Test Date: July 8, 2010

Temperature: 22°C

Tested by: Ming Chen

Humidity: 51 % RH

Polarity: Ver. / Hor.

Frequency (MHz)	Ant.Pol. (H/V)	Reading (dBuV)	Correction Factor (dB/m)	Result (dBuV/m)	Limit (dBuV/m)	Margin (dB)	Remark
243.40	V	38.60	-11.03	27.58	46.00	-18.42	Peak
296.75	V	36.33	-9.27	27.06	46.00	-18.94	Peak
647.57	V	32.83	-2.95	29.88	46.00	-16.12	Peak
713.85	V	35.55	-2.34	33.21	46.00	-12.79	Peak
728.40	V	29.86	-2.13	27.73	46.00	-18.27	Peak
815.70	V	39.62	-1.18	38.44	46.00	-7.56	Peak
204.60	H	33.86	-10.28	23.59	43.50	-19.91	Peak
243.40	H	26.37	-11.03	15.35	46.00	-30.65	Peak
450.33	H	23.26	-5.86	17.40	46.00	-28.60	Peak
660.50	H	23.25	-2.82	20.43	46.00	-25.57	Peak
713.85	H	41.87	-2.34	39.53	46.00	-6.47	Peak
815.70	H	44.90	-1.18	43.72	46.00	-2.28	Peak

**Remark:**

1. No emission found between lowest internal used/generated frequency to 30MHz (9kHz~30MHz)
2. Radiated emissions measured in frequency range from 30 MHz to 1000MHz, were made with an instrument using peak/quasi-peak detector mode.
3. Quasi-peak test would be performed if the peak result were greater than the quasi-peak limit or as required by the applicant.
4. Measurements above show only up to 6 maximum emissions noted, or would be lesser, with " N/A " remark, if no specific emissions from the EUT are recorded (ie: margin>20dB from the applicable limit) and considered that's already beyond the background noise floor.
5. Margin (dB) = Remark result (dBuV/m) – Quasi-peak limit (dBuV/m).





**Above 1 GHz**

**Operation Mode:** TX / CH Low

**Test Date:** July 8, 2010

**Temperature:** 22°C

**Tested by:** Ming Chen

**Humidity:** 51 % RH

**Polarity:** Ver. / Hor.

Frequency (MHz)	Ant.Pol. (H/V)	Reading (Peak) (dBuV)	Reading (Average) (dBuV)	Correction Factor (dB/m)	Result (Peak) (dBuV/m)	Result (Average) (dBuV/m)	Limit (Peak) (dBuV/m)	Limit (Average) (dBuV/m)	Margin (dB)	Remark
1820.00	V	60.53	56.97	-5.81	54.72	51.16	74.00	54.00	-2.84	AVG
N/A										
1820.00	H	60.58	58.84	-5.81	54.77	53.03	74.00	54.00	-0.97	AVG
8191.67	H	50.74	45.41	7.49	58.23	52.90	74.00	54.00	-1.10	AVG
N/A										

**Remark:**

1. Measuring frequencies from 1 GHz to the 10th harmonic of highest fundamental frequency.
2. Radiated emissions measured in frequency above 1000MHz were made with an instrument using peak/average detector mode.
3. Average test would be performed if the peak result were greater than the average limit or as required by the applicant.
4. Data of measurement within this frequency range shown " --- " in the table above means the reading of emissions are attenuated more than 20dB below the permissible limits or the field strength is too small to be measured.
5. Measurements above show only up to 6 maximum emissions noted, or would be lesser, with " N/A " remark, if no specific emissions from the EUT are recorded (ie: margin>20dB from the applicable limit) and considered that's already beyond the background noise floor.
6. Margin (dB) = Remark result (dBuV/m) – Average limit (dBuV/m).



Operation Mode: TX / CH Mid

Test Date: July 8, 2010

Temperature: 22°C

Tested by: Ming Chen

Humidity: 51 % RH

Polarity: Ver. / Hor.

Frequency (MHz)	Ant.Pol. (H/V)	Reading (Peak) (dBuV)	Reading (Average) (dBuV)	Correction Factor (dB/m)	Result (Peak) (dBuV/m)	Result (Average) (dBuV/m)	Limit (Peak) (dBuV/m)	Limit (Average) (dBuV/m)	Margin (dB)	Remark
1826.67	V	55.22	---	-5.75	49.47	---	74.00	54.00	-4.53	Peak
7316.67	V	52.92	48.06	5.30	58.22	53.36	74.00	54.00	-0.64	AVG
9148.33	V	47.98	41.89	10.59	58.57	52.48	74.00	54.00	-1.52	AVG
N/A										
1830.00	H	55.91	---	-5.72	50.19	---	74.00	54.00	-3.81	Peak
3653.33	H	52.46	---	-0.63	51.84	---	74.00	54.00	-2.16	Peak
7316.67	H	50.01	48.30	5.30	55.30	53.60	74.00	54.00	-0.40	AVG
N/A										

**Remark:**

1. Measuring frequencies from 1 GHz to the 10th harmonic of highest fundamental frequency.
2. Radiated emissions measured in frequency above 1000MHz were made with an instrument using peak/average detector mode.
3. Average test would be performed if the peak result were greater than the average limit or as required by the applicant.
4. Data of measurement within this frequency range shown " --- " in the table above means the reading of emissions are attenuated more than 20dB below the permissible limits or the field strength is too small to be measured.
5. Measurements above show only up to 6 maximum emissions noted, or would be lesser; with " N/A " remark, if no specific emissions from the EUT are recorded (ie: margin > 20dB from the applicable limit) and considered that's already beyond the background noise floor.
6. Margin (dB) = Remark result (dBuV/m) – Average limit (dBuV/m).



Operation Mode: TX / CH High

Test Date: July 8, 2010

Temperature: 22°C

Tested by: Ming Chen

Humidity: 51 % RH

Polarity: Ver. / Hor.

Frequency (MHz)	Ant.Pol. (H/V)	Reading (Peak) (dBuV)	Reading (Average) (dBuV)	Correction Factor (dB/m)	Result (Peak) (dBuV/m)	Result (Average) (dBuV/m)	Limit (Peak) (dBuV/m)	Limit (Average) (dBuV/m)	Margin (dB)	Remark
1836.67	V	59.85	57.58	-5.66	54.20	51.92	74.00	54.00	-2.08	AVG
N/A										
1836.67	H	57.64	---	-5.66	51.99	---	74.00	54.00	-2.01	Peak
2753.33	H	53.29	---	-1.92	51.37	---	74.00	54.00	-2.63	Peak
3676.67	H	54.80	53.01	-0.55	54.25	52.46	74.00	54.00	-1.54	AVG
N/A										

**Remark:**

1. Measuring frequencies from 1 GHz to the 10th harmonic of highest fundamental frequency.
2. Radiated emissions measured in frequency above 1000MHz were made with an instrument using peak/average detector mode.
3. Average test would be performed if the peak result were greater than the average limit or as required by the applicant.
4. Data of measurement within this frequency range shown “ --- ” in the table above means the reading of emissions are attenuated more than 20dB below the permissible limits or the field strength is too small to be measured.
5. Measurements above show only up to 6 maximum emissions noted, or would be lesser; with “ N/A ” remark, if no specific emissions from the EUT are recorded (ie: margin>20dB from the applicable limit) and considered that's already beyond the background noise floor.
6. Margin (dB) = Remark result (dBuV/m) – Average limit (dBuV/m).



## 7.9 POWERLINE CONDUCTED EMISSIONS

### LIMIT

According to §15.207(a), except as shown in paragraphs (b) and (c) of this section, for an intentional radiator that is designed to be connected to the public utility (AC) power line, the radio frequency voltage that is conducted back onto the AC power line on any frequency or frequencies within the band 150 kHz to 30 MHz shall not exceed the limits in the following table, as measured using a 50  $\mu$ H/50 ohms line impedance stabilization network (LISN). Compliance with the provisions of this paragraph shall be based on the measurement of the radio frequency voltage between each power line and ground at the power terminal. The lower limit applies at the boundary between the frequency ranges.

Frequency Range (MHz)	Limits (dB $\mu$ V)	
	Quasi-peak	Average
0.15 to 0.50	66 to 56*	56 to 46*
0.50 to 5	56	46
5 to 30	60	50

\* Decreases with the logarithm of the frequency.

### Test Configuration

See test photographs attached in Appendix II for the actual connections between EUT and support equipment.

### TEST PROCEDURE

1. The EUT was placed on a table, which is 0.8m above ground plane.
2. Maximum procedure was performed on the six highest emissions to ensure EUT compliance.
3. Repeat above procedures until all frequency measured were complete.

### TEST RESULTS

*Not applicable (Since the EUT is powered by battery)*