

# ELECTROMAGNETIC EMISSIONS COMPLIANCE REPORT

## INTENTIONAL RADIATOR CERTIFICATION TO FCC PART 22 SUBPART H and PART 24 SUBPART E REQUIREMENT

OF

**Product Name:** HEAVY EQUIPMENT UNIT

**Brand Name:** N/A

**Model Name:** HEU-100

**FCC ID:** TBQHEU-100

**GSM Module ID:** PY76220511

**Report No.:** ER/2006/60001

**Issue Date:** Jun. 15, 2006

**FCC Rule Part:** 2 & 24E& 22H

**Prepared for** Portman Electronics (shenzhen) CO., LTD.  
9th Building, Tongfuyu Industrial District,  
Shenzhen 518109, China

**Prepared by** SGS Taiwan Ltd.  
No. 134, Wu Kung Rd., Wuku Industrial Zone,  
Taipei County, Taiwan.

*Note: This report shall not be reproduced except in full, without the written approval of SGS Taiwan Ltd. This document may be altered or revised by SGS Taiwan Ltd. personnel only, and shall be noted in the revision section of the document.*

Any unauthorized alteration, forgery or falsification of the content or appearance of this report is unlawful and offenders may be prosecuted to the fullest extent of the law. 對本報告內容或外觀之任何未經授權之變更、偽造、竄改皆屬非法，違犯者將會被依法追訴。

This Test Report is issued by the Company subject to its General Conditions of Service printed overleaf. Attention is drawn to the limitations of liability, indemnification, and Jurisdictional issued defined therein. The results shown in this test report refer only to the sample(s) tested unless otherwise stated. This test report cannot be reproduced, except in full, without prior written permission of the Company. 此報告是遵循本公司訂定之通用服務條款所製作發放。請注意此條款列印於背面，將本公司之義務，免責，管轄權皆明確規範之。此報告結果除非另有說明僅對檢驗之樣品負責。本報告未經本公司書面許可，不可部份複製。

## VERIFICATION OF COMPLIANCE

**Applicant:** Portman Electronics (shenzhen) CO., LTD.  
9th Building, Tongfuyu Industrial District, Shenzhen 518109, China

**Equipment Under Test:** HEAVY EQUIPMENT UNIT

**FCC ID Number:** TBQHEU-100

**Brand Name:** N/A

**Model No.:** HEU-100

**Model Difference:** N/A

**File Number:** ER/2006/60001

**Date of test:** Jun. 02, 2006 ~ Jun. 12, 2006

**Date of EUT Received:** Jun. 01, 2006

**We hereby certify that:**

The above equipment was tested by SGS Taiwan Ltd. The test data, data evaluation, test procedures, and equipment configurations shown in this report were made in accordance with the procedures given in TIA/EIA-603-1-1998 and the energy emitted by the sample EUT tested as described in this report is in compliance with conducted and radiated emission limits of FCC Rule FCC PART 22 subpart H and FCC PART 24 subpart E.

The test results of this report relate only to the tested sample identified in this report.

|                     |  |             |               |
|---------------------|--|-------------|---------------|
| <b>Test By:</b>     | <br><hr style="border: 0.5px solid black;"/> Sky Wang   | <b>Date</b> | Jun. 15, 2006 |
| <b>Prepared By:</b> | <br><hr style="border: 0.5px solid black;"/> Eva Kao    | <b>Date</b> | Jun. 15, 2006 |
| <b>Approved By</b>  | <br><hr style="border: 0.5px solid black;"/> Vincent Su | <b>Date</b> | Jun. 15, 2006 |

## Version

| Version No. | Date          |
|-------------|---------------|
| 00          | Jun. 15, 2006 |
|             |               |

This Test Report is issued by the Company subject to its General Conditions of Service printed overleaf. Attention is drawn to the limitations of liability, indemnification, and Jurisdictional issued defined therein. The results shown in this test report refer only to the sample(s) tested unless otherwise stated. This test report cannot be reproduced, except in full, without prior written permission of the Company. 此報告是遵循本公司訂定之通用服務條款所製作發放。請注意此條款列印於背面，將本公司之義務，免責，管轄權皆明確規範之。此報告結果除非另有說明僅對檢驗之樣品負責。本報告未經本公司書面許可，不可部份複製。

## Table of Contents

|  |           |
|--|-----------|
| <b>1. GENERAL INFORMATION .....</b>                              | <b>5</b>  |
| 1.1 Product Description .....                                    | 5         |
| 1.2 Related Submittal(s) / Grant (s) .....                       | 5         |
| 1.3 Test Methodology .....                                       | 5         |
| 1.4 Test Facility .....  | 6         |
| 1.5 Special Accessories .....                                    | 6         |
| 1.6 Equipment Modifications .....                                | 6         |
| <b>2. SYSTEM TEST CONFIGURATION .....</b>                        | <b>7</b>  |
| 2.1 EUT Configuration .....                                      | 7         |
| 2.2 EUT Exercise .....   | 7         |
| 2.3 Test Procedure .....   | 7         |
| 2.4 Configuration of Tested System .....                         | 8         |
| <b>3. SUMMARY OF TEST RESULTS .....</b>                          | <b>9</b>  |
| <b>4. DESCRIPTION OF TEST MODES .....</b>                        | <b>9</b>  |
| <b>5. RF POWER OUTPUT MEASUREMENT .....</b>                      | <b>10</b> |
| 5.1 Standard Applicable .....                                    | 10        |
| 5.2 Test Set-up: .....   | 10        |
| 5.3 Measurement Procedure .....                                  | 10        |
| 5.4 Measurement Equipment Used: .....                            | 11        |
| 5.5 Measurement Result .....                                     | 11        |
| <b>6. ERP, EIRP MEASUREMENT .....</b>                            | <b>12</b> |
| 6.1 Standard Applicable .....                                    | 12        |
| 6.2 Test SET-UP (Block Diagram of Configuration) .....           | 12        |
| 6.3 Measurement Procedure .....                                  | 14        |
| 6.4 Measurement Equipment Used: .....                            | 15        |
| 6.5 Measurement Result .....                                     | 16        |
| <b>7. FIELD STRENGTH OF SPURIOUS RADIATION MEASUREMENT .....</b> | <b>17</b> |
| 7.1 Standard Applicable .....                                    | 17        |
| 7.2 EUT Setup (Block Diagram of Configuration) .....             | 17        |
| 7.3 Measurement Procedure .....                                  | 19        |
| 7.4 Measurement Equipment Used: .....                            | 20        |
| 7.5 Measurement Result .....                                     | 20        |
| <b>APPENDIX 1 PHOTOGRPHS OF SET UP .....</b>                     | <b>27</b> |
| <b>APPENDIX 2 PHOTOGRPHS OF EUT .....</b>                        | <b>29</b> |

This Test Report is issued by the Company subject to its General Conditions of Service printed overleaf. Attention is drawn to the limitations of liability, indemnification, and Jurisdictional issued defined therein. The results shown in this test report refer only to the sample(s) tested unless otherwise stated. This test report cannot be reproduced, except in full, without prior written permission of the Company. 此報告是遵循本公司訂定之通用服務條款所製作發放。請注意此條款列印於背面，將本公司之義務，免責，管轄權皆明確規範之。此報告結果除非另有說明僅對檢驗之樣品負責。本報告未經本公司書面許可，不可部份複製。

# 1. GENERAL INFORMATION

## 1.1 Product Description

|                           |                              |        |
|---------------------------|------------------------------|--------|
| Product                   | HEAVY EQUIPMENT UNIT         |        |
| Model Name                | HEU-100                      |        |
| Model Difference:         | N/A                          |        |
| Brand Name                | N/A                          |        |
| Frequency Range and Power | GSM 850: 824 MHz – 849 MHz   | 33 dBm |
|                           | GSM 1900: 1850 MHz –1910 MHz | 30 dBm |
| Type of Emission          | 300KGXW                      |        |
| Power Supply              | 12V DC by Car Battery        |        |
| Antenna Type              | Micro-Strip Antenna, 1 dBi   |        |

## 1.2 Related Submittal(s) / Grant (s)

This submittal(s) (test report) is intended for FCC ID: **TBQHEU-100** filing to comply with Section Part 22 subpart H and Part 24 subpart E of the FCC CFR 47 Rules.

## 1.3 Test Methodology

Both conducted and radiated testing were performed according to the procedures documented on chapter 13 of ANSI C63.4 (2003) and FCC CFR 47.1046, 2.1047, 2.1049, 2.1051, 2.1053, 2.1055 and 2.1057.

## 1.4 Test Facility

The open area test site and conducted measurement facility used to collect the radiated data is located on the address of SGS Taiwan Ltd. No. 134, Wu Kung Rd., Wuku Industrial Zone, Taipei Country, Taiwan. The Open Area Test Sites and the Line Conducted labs are constructed and calibrated to meet the FCC requirements in documents ANSI C63.4: 2003 and CISPR 22/EN 55022 requirements. Site No. 1(3 & 10 meters) Registration Number: 94644, Anechoic chamber (3 meters) Registration Number: 573967

## 1.5 Special Accessories

Not available for this EUT intended for grant.

## 1.6 Equipment Modifications

Not available for this EUT intended for grant.

## 2. SYSTEM TEST CONFIGURATION

### 2.1 EUT Configuration

The EUT configuration for testing is installed on RF field strength measurement to meet the Commissions requirement and operating in a manner which intends to maximize its emission characteristics in a continuous normal application.

### 2.2 EUT Exercise

The EUT (Transmitter) was operated in the engineering mode to fix the Tx frequency which was for the purpose of the measurements.

### 2.3 Test Procedure

#### 2.3.1 Conducted Emissions

The EUT is placed on a turn table which is 0.8 m above ground plane. According to the requirements in Section 7&13 of ANSI C63.4-2003. Conducted emissions from the EUT measured in the frequency range between 0.15 MHz and 30MHz using CISPR Quasi-Peak and Average detector mode.

#### 2.3.2 Radiated Emissions

The EUT is placed on a turn table which is 1.0 m above ground plane. The turn table shall rotate 360 degrees to determine the position of maximum emission level. EUT is set 3m away from the receiving antenna which varied from 1m to 4m to find out the highest emission. And also, each emission was to be maximized by changing the polarization of receiving antenna both horizontal and vertical. In order to find out the max. emission, the relative positions of this hand-held transmitter(EUT) was rotated through three orthogonal axes according to the requirements in Section 8&13 of ANSI C63.4-2003.

## 2.4 Configuration of Tested System

Fig. 2-1 Configuration of Tested System

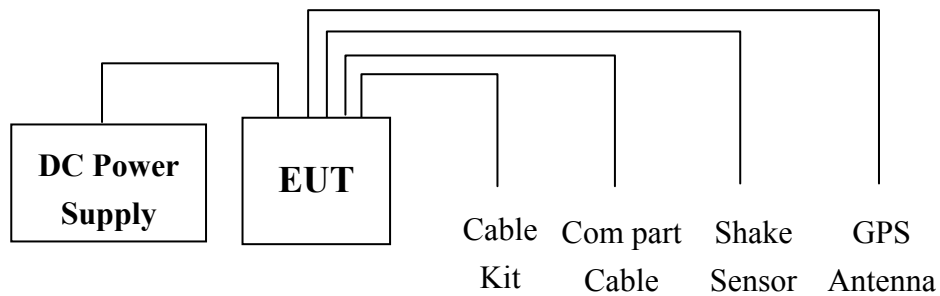

Table 2-1 Equipment Used in Tested System

| Item | Equipment       | Mfr/Brand | Model/<br>Type No. | FCC ID | Series No. |
|------|-----------------|-----------|--------------------|--------|------------|
| 1.   | DC Power Supply | TOPWARD   | 3303A              | N/A    | 715856     |



### 3. SUMMARY OF TEST RESULTS

| FCC Rules                              | Description Of Test  | Result    |
|--|--|-----------|
| §2.1046(a)<br>§22.913(a)<br>§24.232(a) | RF Power Output  | Compliant |
| §2.1046(a)<br>§22.913(a)<br>§24.232(a) | ERP/ EIRP measurement  | Compliant |
| §2.1049(h)                             | 99% Occupied Bandwidth   | N/A       |
| §2.1051<br>§22.917(a)<br>§24.238(a)    | Out of Band Emissions at Antenna<br>Terminals and<br>Band Edge | N/A       |
| §2.1053<br>§22.917(a)<br>§24.238(a)    | Field Strength of Spurious Radiation                           | Compliant |
| §2.1055(a)(1)(b)                       | Frequency Stability vs. Temperature                            | N/A       |
| §2.1055(d)(1)(2)                       | Frequency Stability vs. Voltage                                | N/A       |
| §15.107;§15.207                        | AC Power Line Conducted Emission                               | N/A       |

### 4. DESCRIPTION OF TEST MODES

The EUT has been tested under operating condition.

EUT staying in continuous transmitting mode. Channel low, Mid and High for each type and band with rated data rate are chosen for full testing.

The GSM module was approved and the FCC ID number is **PY76220511**. Thus, the output power, ERP/EIRP and Field Strength of Spurious Radiation were tested.

## 5. RF POWER OUTPUT MEASUREMENT

### 5.1 Standard Applicable

According to FCC §2.1046.

FCC 22.913(a) Mobile station are limited to 7W.

FCC 24.232(b) Mobile station are limited to 2W.

### 5.2 Test Set-up:

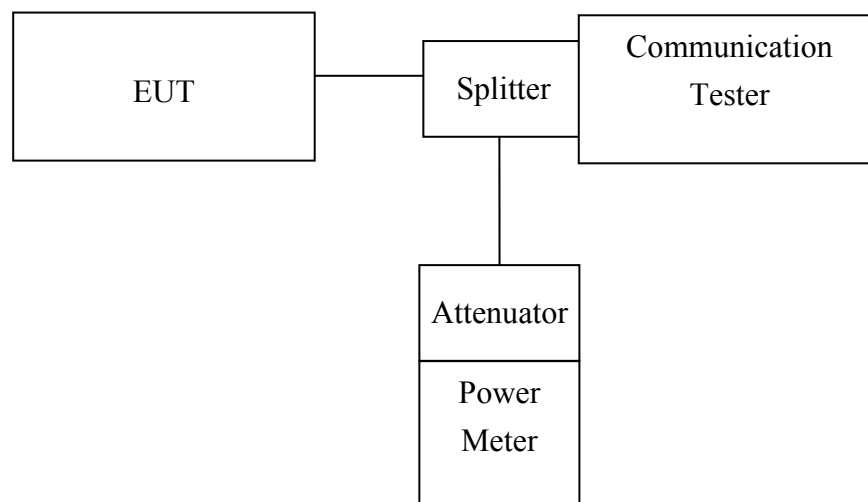

*Note: Measurement setup for testing on Antenna connector*

### 5.3 Measurement Procedure

The transmitter output was connected to a calibrated attenuator, the other end of which was connected to a power meter. Transmitter output was read off the power meter in dBm. The power output at the transmitter antenna port was determined by adding the value of the attenuator to the power meter reading.

### 5.4 Measurement Equipment Used:

| Conducted Emission Test Site |              |                 |               |            |            |
|------------------------------|--------------|-----------------|---------------|------------|------------|
| EQUIPMENT TYPE               | MFR          | MODEL NUMBER    | SERIAL NUMBER | LAST CAL.  | CAL DUE.   |
| Spectrum Analyzer            | Agilent      | E4446A          | MY43360126    | 03/29/2006 | 03/28/2007 |
| Spectrum Analyzer            | Agilent      | E7405A          | US41160416    | 06/28/2005 | 06/29/2006 |
| Spectrum Analyzer            | R&S          | FSP 40          | 100034        | 11/09/2005 | 11/10/2006 |
| Communication Test           | R&S          | SMU200          | N/A           | N/A        | N/A        |
| Power Sensor                 | Anritsu      | MA2490A         | 31431         | 06/28/2005 | 06/29/2006 |
| Power Meter                  | Anritsu      | ML2487A         | 6K00002070    | 06/28/2005 | 06/29/2006 |
| Temperature Chamber          | TERCHY       | MHG-120LF       | 911009        | 10/14/2005 | 10/13/2006 |
| Low Loss Cable               | HUBER+SUHNER | SUCOFLEX 104PEA | N/A           | N/A        | N/A        |
| Attenuator                   | Mini-Circuit | BW-S10W5        | N/A           | 09/23/2005 | 09/22/2006 |
| Attenuator                   | Mini-Circuit | BW-S6W5         | N/A           | 09/23/2005 | 09/22/2006 |
| Splitter                     | Agilent      | 11636B          | 51728         | 09/23/2005 | 09/22/2006 |
| DC Power Supply              | TOPWARD      | 3303A           | N/A           | N/A        | N/A        |

### 5.5 Measurement Result

| EUT Mode | Frequency (MHz) | CH  | CMU200 Reading (dBm) | Offset (dB) | Average Power (dBm) |
|----------|-----------------|-----|----------------------|-------------|---------------------|
| GSM 850  | 824.20          | 128 | 22.60                | 10.30       | 32.90               |
|          | 836.60          | 190 | 22.49                | 10.30       | 32.79               |
|          | 848.80          | 251 | 22.28                | 10.30       | 32.58               |

| EUT Mode | Frequency (MHz) | CH  | Power Meter Reading (dBm) | Offset (dB) | Average Power (dBm) |
|----------|-----------------|-----|---------------------------|-------------|---------------------|
| PCS 1900 | 1850.20         | 512 | 19.36                     | 10.30       | 29.66               |
|          | 1880.00         | 661 | 19.50                     | 10.30       | 29.80               |
|          | 1909.80         | 810 | 19.66                     | 10.30       | 29.96               |

This Test Report is issued by the Company subject to its General Conditions of Service printed overleaf. Attention is drawn to the limitations of liability, indemnification, and Jurisdictional issued defined therein. The results shown in this test report refer only to the sample(s) tested unless otherwise stated. This test report cannot be reproduced, except in full, without prior written permission of the Company. 此報告是遵循本公司訂定之通用服務條款所製作發放。請注意此條款列印於背面，將本公司之義務，免責，管轄權皆明確規範之。此報告結果除非另有說明僅對檢驗之樣品負責。本報告未經本公司書面許可，不可部份複製。

## 6. ERP, EIRP MEASUREMENT

### 6.1 Standard Applicable

According to FCC §2.1046

FCC 22.913(a) Mobile station are limited to 7W ERP.

FCC 24.232(b) Mobile station are limited to 2W EIRP.

### 6.2 Test SET-UP (Block Diagram of Configuration)

(A) Radiated Emission Test Set-Up, Frequency Below 1000MHz

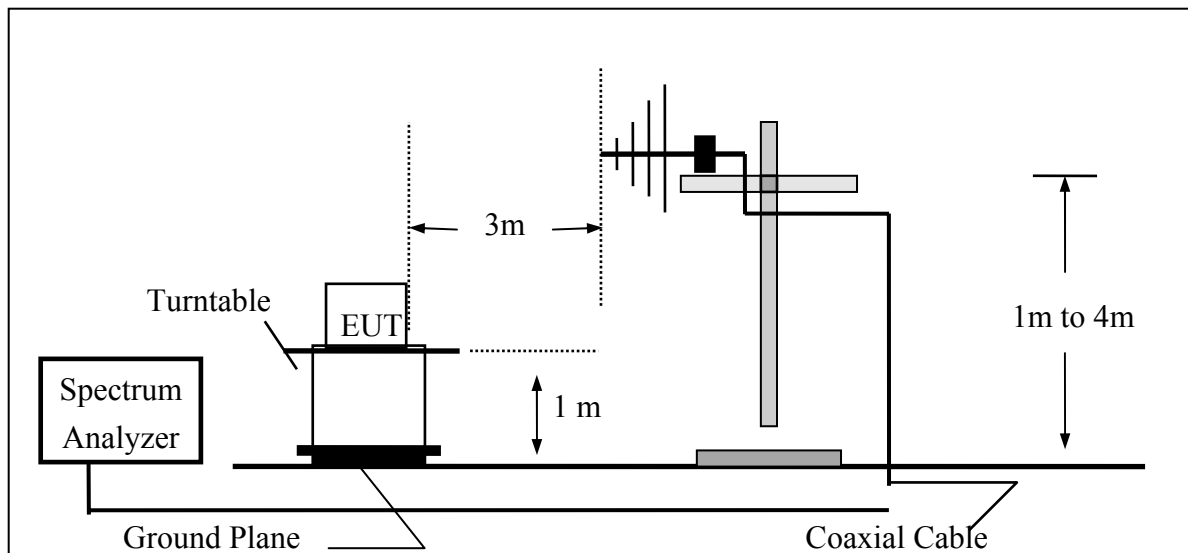

(B) Radiated Emission Test Set-UP Frequency Over 1 GHz

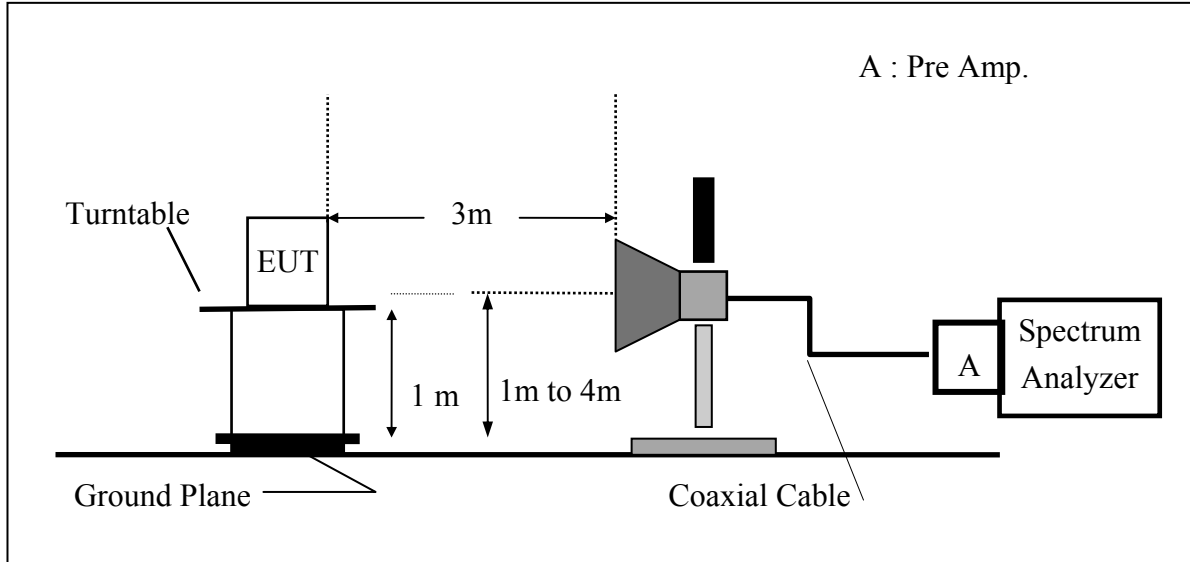

(C) Substituted Method Test Set-UP

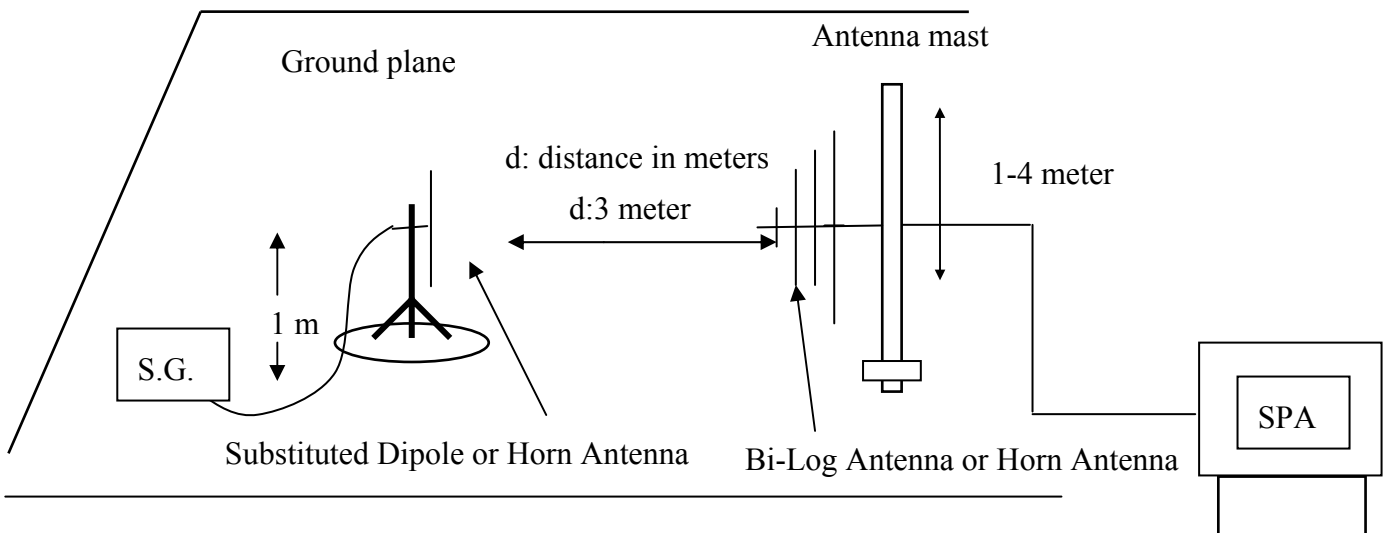

### 6.3 Measurement Procedure

The EUT was placed on a non-conductive turntable using a non-conductive support. The radiated emission at the fundamental frequency was measured at 3 m with a test antenna and EMI spectrum analyzer.

During the measurement, the EUT was in communication with the station. The highest emission was recorded with the rotation of the turntable and the lowering of the test antenna from 4m to 1m. The reading was recorded and the field strength (E in dBuV/m) was calculated.

ERP in frequency band 824.2 –848.80.8MHz were measured using a substitution method. The EUT was replaced by a dipole antenna connected, the S.G. output was recorded and ERP was calculated as follows:

EIRP in frequency band 1850.2 –1909.8MHz were measured using a substitution method. The EUT was replaced by a horn antenna connected, the S.G. output was recorded and EIRP was calculated as follows:

$$\text{ERP} = \text{S.G. output (dBm)} + \text{Antenna Gain (dBd)} - \text{Cable Loss (dB)}$$

$$\text{EIRP} = \text{S.G. output (dBm)} + \text{Antenna Gain (dBi)} - \text{Cable Loss (dB)}$$

#### 6.4 Measurement Equipment Used:

| EQUIPMENT TYPE     | MFR          | MODEL NUMBER         | SERIAL NUMBER | LAST CAL.  | CAL DUE.   |
|--------------------|--------------|----------------------|---------------|------------|------------|
| Spectrum Analyzer  | Agilent      | E4446A               | MY43360126    | 03/29/2006 | 03/28/2007 |
| Spectrum Analyzer  | Agilent      | 7405A                | US41160416    | 06/28/2005 | 06/29/2006 |
| Spectrum Analyzer  | R&S          | FSP 40               | 100034        | 11/09/2005 | 11/10/2006 |
| Communication Test | R&S          | SMU200               | N/A           | N/A        | N/A        |
| Bilog Antenna      | SCHWAZBECK   | VULB9163             | 152           | 06/03/2005 | 06/02/2006 |
| Horn antenna       | Schwarzbeck  | BBHA 9120D           | 309/320       | 08/16/2005 | 08/15/2006 |
| Pre-Amplifier      | HP           | 8447D                | 2944A09469    | 07/19/2005 | 07/18/2006 |
| Pre-Amplifier      | HP           | 8494B                | 3008A00578    | 02/26/2006 | 02/25/2007 |
| Signal Generator   | R&S          | SMR40                | 100210        | 02/09/2006 | 02/10/2007 |
| Turn Table         | HD           | DT420                | N/A           | N.C.R      | N.C.R      |
| Antenna Tower      | HD           | MA240-N              | 240/657       | N.C.R      | N.C.R      |
| Controller         | HD           | HD100                | N/A           | N.C.R      | N.C.R      |
| Low Loss Cable     | HUBER+SUHNER | SUCOFLEX 104PEA-10M  | 10m           | 10/09/2005 | 10/08/2006 |
| Low Loss Cable     | HUBER+SUHNER | SUCOFLEX 104PEA-3M   | 3m            | 10/09/2005 | 10/08/2006 |
| Low Loss Cable     | HUBER+SUHNER | SUCOFLEX 104PEA-0.5M | 0.5m          | 10/09/2005 | 10/08/2006 |
| Site NSA           | SGS          | 966 chamber          | N/A           | 11/17/2005 | 11/16/2006 |
| Attenuator         | Mini-Circuit | BW-S10W5             | N/A           | 09/23/2005 | 09/22/2006 |
| Dipole Antenna     | Schwarzbeck  | VHAP                 | 908/909       | 06/10/2004 | 06/11/2006 |
| Dipole Antenna     | Schwarzbeck  | UHAP                 | 891/892       | 06/10/2004 | 06/11/2006 |
| Horn antenna       | Schwarzbeck  | BBHA 9120D           | N/A           | 08/16/2004 | 08/15/2006 |

### 6.5 Measurement Result

| EUT Mode | Frequency (MHz) | CH  | Antenna Pol. | SPA Reading (dBuV) | S.G. Output (dBm) | Antenna Gain (dBd) | Cable Loss (dB) | ERP (dBm) | Limit (dBm) |
|----------|-----------------|-----|--------------|--------------------|-------------------|--------------------|-----------------|-----------|-------------|
| GSM 850  | 824.20          | 128 | V            | 122.67             | 35.34             | -7.87              | 3.64            | 23.83     | 38.45       |
|          |                 |     | H            | 125.08             | 37.42             | -7.87              | 3.64            | 25.90     | 38.45       |
|          | 836.60          | 190 | V            | 123.38             | 36.35             | -7.88              | 3.70            | 24.78     | 38.45       |
|          |                 |     | H            | 126.07             | 38.73             | -7.88              | 3.70            | 27.16     | 38.45       |
|          | 848.80          | 251 | V            | 124.98             | 38.24             | -7.88              | 3.75            | 26.61     | 38.45       |
|          |                 |     | H            | 125.16             | 38.14             | -7.88              | 3.75            | 26.51     | 38.45       |

| EUT Mode | Frequency (MHz) | CH  | Antenna Pol. | SPA Reading (dBuV) | S.G. Output (dBm) | Antenna Gain (dBi) | Cable Loss (dB) | EIRP (dBm) | Limit (dBm) |
|----------|-----------------|-----|--------------|--------------------|-------------------|--------------------|-----------------|------------|-------------|
| PCS 1900 | 1850.20         | 512 | V            | 131.33             | 24.37             | 9.90               | 5.41            | 28.86      | 33.00       |
|          |                 |     | H            | 127.04             | 20.15             | 9.90               | 5.41            | 24.64      | 33.00       |
|          | 1880.00         | 661 | V            | 132.71             | 25.76             | 9.99               | 5.46            | 30.29      | 33.00       |
|          |                 |     | H            | 126.81             | 19.94             | 9.99               | 5.46            | 24.47      | 33.00       |
|          | 1909.80         | 810 | V            | 132.95             | 26.01             | 10.08              | 5.51            | 30.58      | 33.00       |
|          |                 |     | H            | 127.29             | 20.44             | 10.08              | 5.51            | 25.00      | 33.00       |

|                 |   |
|-----------------|---|
| <b>Remark :</b> |   |
| (1)             | The RBW,VBW of SPA for frequency<br>Below 1GHz was RBW=100 KHz, VBW=300KHz,<br>Above 1GHz was RBW= 1MHz , VBW= 3MHz |



## 7. FIELD STRENGTH OF SPURIOUS RADIATION MEASUREMENT

### 7.1 Standard Applicable

According to FCC §2.1053,

FCC §22.917(a), §24.238(a), the magnitude of each spurious and harmonic emission that can be detected when the equipment is operated under the conditions specified in the instruction manual and/ or alignment procedure, shall not be less than  $43 + 10 \log$  (mean output power in watts) dBc below the mean power output outside a license's frequency block (-13dBm)

### 7.2 EUT Setup (Block Diagram of Configuration)

(A) Radiated Emission Test Set-Up, Frequency Below 1000MHz

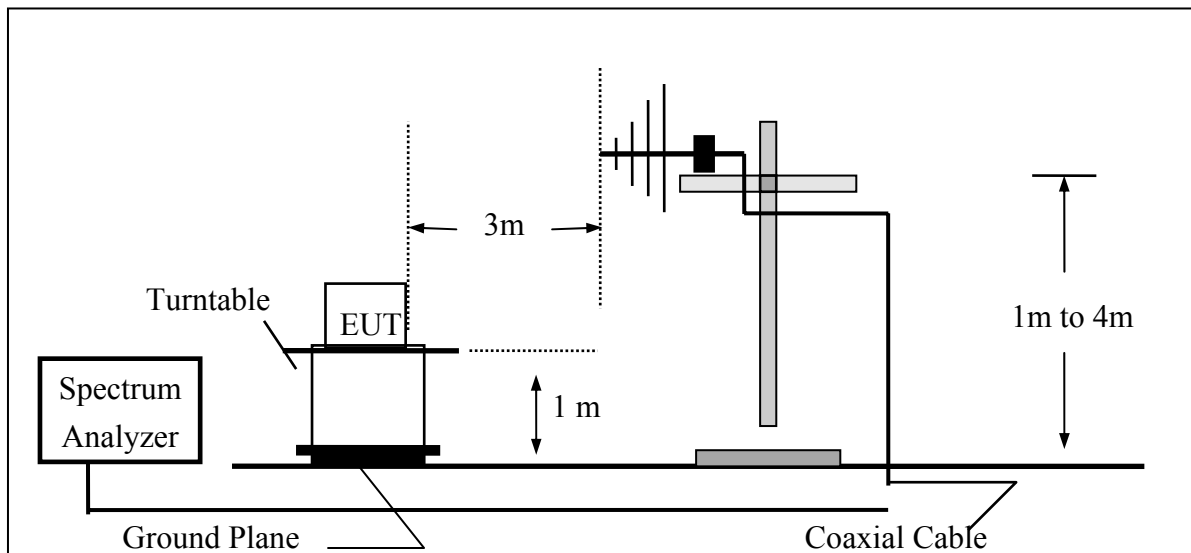

(B) Radiated Emission Test Set-UP Frequency Over 1 GHz

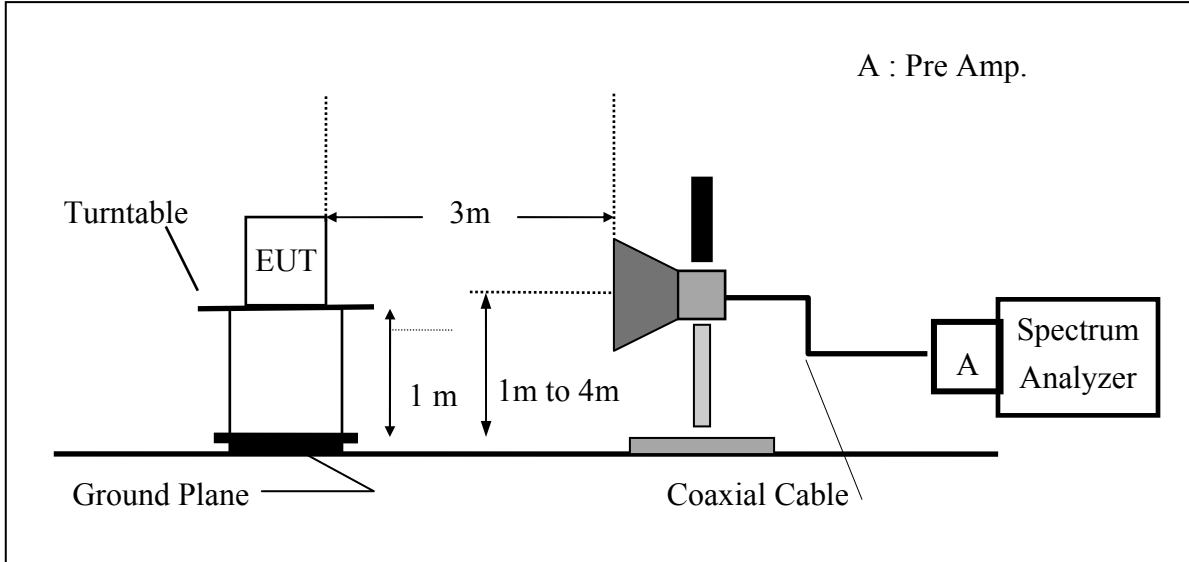

(C) Substituted Method Test Set-UP

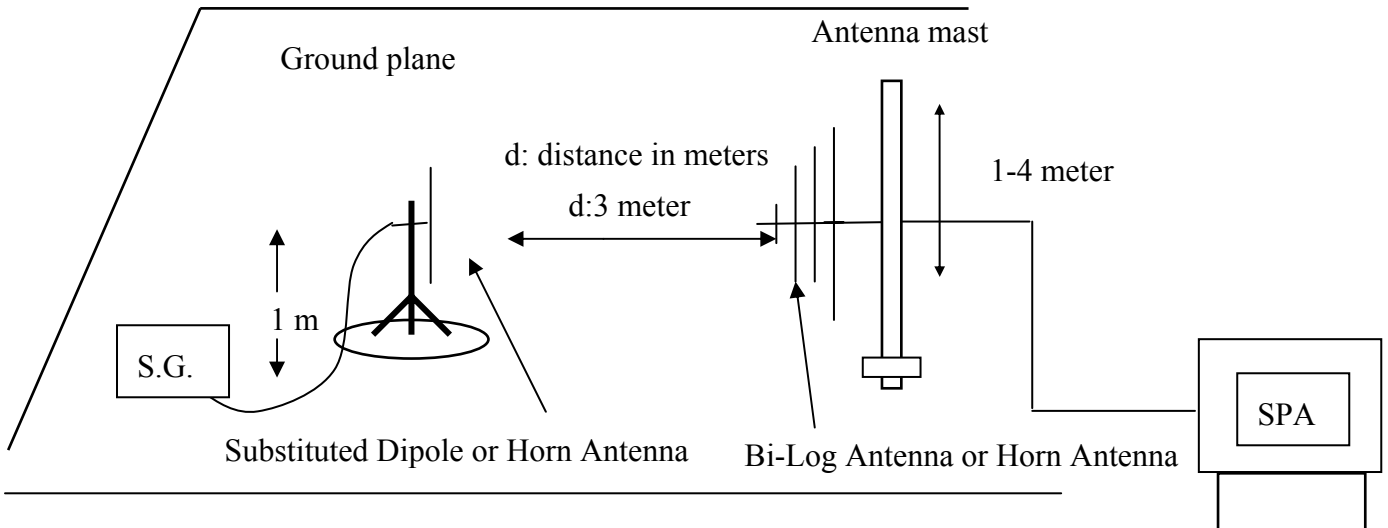

### 7.3 Measurement Procedure

The EUT was placed on a non-conductive, The measurement antenna was placed at a distance of 3 meters from the EUT. During the tests, the antenna height and the EUT azimuth were varied in order to identify the maximum level of emissions from the EUT. This maximization process was repeated with the EUT positioned in each of its three orthogonal orientations.

The frequency range up to tenth harmonic was investigated for each of three fundamental frequency (low, middle and high channels). Once spurious emission were identified, the power of the emission was determined using the substitution method.

The spurious emissions attenuation was calculated as the difference between radiated power at the fundamental frequency and the spurious emissions frequency.

$$\text{ERP} = \text{S.G. output (dBm)} + \text{Antenna Gain(dBd)} - \text{Cable Loss (dB)}$$

$$\text{EIRP} = \text{S.G. output (dBm)} + \text{Antenna Gain(dBi)} - \text{Cable Loss (dB)}$$

### 7.4 Measurement Equipment Used:

| EQUIPMENT TYPE     | MFR          | MODEL NUMBER         | SERIAL NUMBER | LAST CAL.  | CAL DUE.   |
|--------------------|--------------|----------------------|---------------|------------|------------|
| Spectrum Analyzer  | Agilent      | E4446A               | MY43360126    | 03/29/2006 | 03/28/2007 |
| Spectrum Analyzer  | Agilent      | 7405A                | US41160416    | 06/28/2005 | 06/29/2006 |
| Spectrum Analyzer  | R&S          | FSP 40               | 100034        | 11/09/2005 | 11/10/2006 |
| Communication Test | R&S          | SMU200               | N/A           | N/A        | N/A        |
| Bilog Antenna      | SCHWAZBECK   | VULB9163             | 152           | 06/03/2005 | 06/02/2006 |
| Horn antenna       | Schwarzbeck  | BBHA 9120D           | 309/320       | 08/16/2005 | 08/15/2006 |
| Pre-Amplifier      | HP           | 8447D                | 2944A09469    | 07/19/2005 | 07/18/2006 |
| Pre-Amplifier      | HP           | 8494B                | 3008A00578    | 02/26/2006 | 02/25/2007 |
| Signal Generator   | R&S          | SMR40                | 100210        | 02/09/2006 | 02/10/2007 |
| Turn Table         | HD           | DT420                | N/A           | N.C.R      | N.C.R      |
| Antenna Tower      | HD           | MA240-N              | 240/657       | N.C.R      | N.C.R      |
| Controller         | HD           | HD100                | N/A           | N.C.R      | N.C.R      |
| Low Loss Cable     | HUBER+SUHNER | SUCOFLEX 104PEA-10M  | 10m           | 10/09/2005 | 10/08/2006 |
| Low Loss Cable     | HUBER+SUHNER | SUCOFLEX 104PEA-3M   | 3m            | 10/09/2005 | 10/08/2006 |
| Low Loss Cable     | HUBER+SUHNER | SUCOFLEX 104PEA-0.5M | 0.5m          | 10/09/2005 | 10/08/2006 |
| Site NSA           | SGS          | 966 chamber          | N/A           | 11/17/2005 | 11/16/2006 |
| Attenuator         | Mini-Circuit | BW-S10W5             | N/A           | 09/23/2005 | 09/22/2006 |
| Dipole Antenna     | Schwarzbeck  | VHAP                 | 908/909       | 06/10/2004 | 06/11/2006 |
| Dipole Antenna     | Schwarzbeck  | UHAP                 | 891/892       | 06/10/2004 | 06/11/2006 |
| Horn antenna       | Schwarzbeck  | BBHA 9120D           | N/A           | 08/16/2004 | 08/15/2006 |

### 7.5 Measurement Result

Refer to attach tabular data sheets.

**Radiated Spurious Emission Measurement Result: GSM 850 Mode**

|                       |              |            |               |
|-----------------------|--------------|------------|---------------|
| Operation Mode        | : TX CH Low  | Test Date: | Jun. 09, 2005 |
| Fundamental Frequency | : 824.20 MHz | Test By:   | Sky           |
| Temperature           | : 25°C       | Pol:       | Ver / Hor     |
| Humidity              | : 65%        |            |               |

| Freq.   | SPA Reading | Ant.Pol. | S.G Output | Antenna Gain | Cable Loss | ERP/EIRP | Limit  | Safe Margin |
|---------|-------------|----------|------------|--------------|------------|----------|--------|-------------|
| (MHz)   | (dBuV)      | H/V      | (dBm)      | (dB/dBi)     | (dB)       | (dBm)    | (dBm)  | (dBm)       |
| 823.98  | 75.42       | V        | -11.91     | -7.87        | 3.64       | -23.43   | -13.00 | -10.43      |
| 1648.54 | 78.49       | V        | -28.55     | 9.29         | 5.06       | -24.32   | -13.00 | -11.32      |
| 2472.81 | 63.26       | V        | -40.80     | 10.08        | 6.30       | -37.03   | -13.00 | -24.03      |
| 3297.08 | 56.52       | V        | -46.06     | 12.17        | 7.26       | -41.15   | -13.00 | -28.15      |
| 4121.35 | 47.50       | V        | -52.28     | 12.61        | 8.33       | -47.99   | -13.00 | -34.99      |
| 4945.62 | ---         | V        | ---        | ---          | ---        | ---      | -13.00 | ---         |
| 5769.89 | 40.76       | V        | -53.83     | 13.55        | 9.80       | -50.07   | -13.00 | -37.07      |
| 6594.16 | ---         | V        | ---        | ---          | ---        | ---      | -13.00 | ---         |
| 7418.43 | ---         | V        | ---        | ---          | ---        | ---      | -13.00 | ---         |
| 8242.70 | ---         | V        | ---        | ---          | ---        | ---      | -13.00 | ---         |
| 824.00  | 75.10       | H        | -12.56     | -7.87        | 3.64       | -24.08   | -13.00 | -11.08      |
| 1648.54 | 80.93       | H        | -26.08     | 9.29         | 5.06       | -21.85   | -13.00 | -8.85       |
| 2472.81 | 64.98       | H        | -39.08     | 10.08        | 6.30       | -35.30   | -13.00 | -22.30      |
| 3297.08 | 57.01       | H        | -45.35     | 12.17        | 7.26       | -40.44   | -13.00 | -27.44      |
| 4121.35 | 49.45       | H        | -50.20     | 12.61        | 8.33       | -45.91   | -13.00 | -32.91      |
| 4945.62 | 44.63       | H        | -51.87     | 12.65        | 9.19       | -48.41   | -13.00 | -35.41      |
| 5769.89 | 39.30       | H        | -55.25     | 13.55        | 9.80       | -51.49   | -13.00 | -38.49      |
| 6594.16 | ---         | H        | ---        | ---          | ---        | ---      | -13.00 | ---         |
| 7418.43 | ---         | H        | ---        | ---          | ---        | ---      | -13.00 | ---         |
| 8242.70 | ---         | H        | ---        | ---          | ---        | ---      | -13.00 | ---         |

Remark :

- 1 The emission behaviour belongs to narrowband spurious emission.
- 2 Remark”---“ means that the emission level is too low to be measured
- 3 The result basic equation calculation is as follows:
- 4  $ERP/EIRP (dBm) = SG \text{ Setting}(dBm) + Antenna \text{ Gain} (dBd/dBi) - Cable \text{ loss} (dB)$

**Radiated Spurious Emission Measurement Result: GSM 850 Mode**

Operation Mode : TX CH Mid  
 Fundamental Frequency : 836.60 MHz  
 Temperature : 25°C  
 Humidity : 65%

Test Date: Jun. 09, 2005  
 Test By: Sky  
 Pol: Ver / Hor

| Freq.   | SPA Reading | Ant.Pol. | S.G Output | Antenna Gain | Cable Loss | ERP/EIRP | Limit  | Safe Margin |
|---------|-------------|----------|------------|--------------|------------|----------|--------|-------------|
| (MHz)   | (dBuV)      | H/V      | (dBm)      | (dB/dBi)     | (dB)       | (dBm)    | (dBm)  | (dBm)       |
| 1673.04 | 82.65       | V        | -24.38     | 9.36         | 5.10       | -20.12   | -13.00 | -7.12       |
| 2509.56 | 67.36       | V        | -36.52     | 10.09        | 6.35       | -32.78   | -13.00 | -19.78      |
| 3346.08 | 62.32       | V        | -40.24     | 12.27        | 7.29       | -35.26   | -13.00 | -22.26      |
| 4182.60 | 53.45       | V        | -46.11     | 12.62        | 8.39       | -41.89   | -13.00 | -28.89      |
| 5019.12 | 49.81       | V        | -46.49     | 12.67        | 9.26       | -43.08   | -13.00 | -30.08      |
| 5855.64 | 41.41       | V        | -52.94     | 13.68        | 9.85       | -49.10   | -13.00 | -36.10      |
| 6692.16 | ---         | V        | ---        | ---          | ---        | ---      | -13.00 | ---         |
| 7528.68 | ---         | V        | ---        | ---          | ---        | ---      | -13.00 | ---         |
| 8365.20 | ---         | V        | ---        | ---          | ---        | ---      | -13.00 | ---         |
| 1673.04 | 81.79       | H        | -25.21     | 9.36         | 5.10       | -20.94   | -13.00 | -7.94       |
| 2509.56 | 70.78       | H        | -33.10     | 10.09        | 6.35       | -29.35   | -13.00 | -16.35      |
| 3346.08 | 59.63       | H        | -42.69     | 12.27        | 7.29       | -37.71   | -13.00 | -24.71      |
| 4182.60 | 52.43       | H        | -46.99     | 12.62        | 8.39       | -42.76   | -13.00 | -29.76      |
| 5019.12 | 50.71       | H        | -45.54     | 12.67        | 9.26       | -42.13   | -13.00 | -29.13      |
| 5855.64 | 45.00       | H        | -49.32     | 13.68        | 9.85       | -45.48   | -13.00 | -32.48      |
| 6692.16 | ---         | H        | ---        | ---          | ---        | ---      | -13.00 | ---         |
| 7528.68 | ---         | H        | ---        | ---          | ---        | ---      | -13.00 | ---         |
| 8365.20 | ---         | H        | ---        | ---          | ---        | ---      | -13.00 | ---         |

Remark :

- 1 The emission behaviour belongs to narrowband spurious emission.
- 2 Remark"---" means that the emission level is too low to be measured
- 3 The result basic equation calculation is as follows:
- 4  $ERP/EIRP (dBm) = SG \text{ Setting}(dBm) + Antenna \text{ Gain} (dBd/dBi) - Cable \text{ loss} (dB)$

**Radiated Spurious Emission Measurement Result: GSM 850 Mode**

Operation Mode : TX CH High  
 Fundamental Frequency : 848.80 MHz  
 Temperature : 25°C  
 Humidity : 65%

Test Date: Jun. 09, 2005  
 Test By: Sky  
 Pol: Ver / Hor

| Freq.   | SPA Reading | Ant.Pol. | S.G Output | Antenna Gain | Cable Loss | ERP/EIRP | Limit  | Safe Margin |
|---------|-------------|----------|------------|--------------|------------|----------|--------|-------------|
| (MHz)   | (dBuV)      | H/V      | (dBm)      | (dB/dBi)     | (dB)       | (dBm)    | (dBm)  | (dBm)       |
| 849.02  | 76.13       | V        | -10.60     | -7.88        | 3.75       | -22.23   | -13.00 | -9.23       |
| 1697.74 | 84.18       | V        | -22.84     | 9.44         | 5.14       | -18.54   | -13.00 | -5.54       |
| 2546.61 | 68.32       | V        | -35.47     | 10.20        | 6.40       | -31.67   | -13.00 | -18.67      |
| 3395.48 | 57.29       | V        | -45.25     | 12.38        | 7.33       | -40.20   | -13.00 | -27.20      |
| 4244.35 | 49.87       | V        | -49.48     | 12.63        | 8.46       | -45.31   | -13.00 | -32.31      |
| 5093.22 | 48.17       | V        | -47.99     | 12.74        | 9.32       | -44.56   | -13.00 | -31.56      |
| 5942.09 | 37.17       | V        | -56.93     | 13.81        | 9.89       | -53.01   | -13.00 | -40.01      |
| 6790.96 | 37.96       | V        | -50.56     | 11.85        | 10.87      | -49.57   | -13.00 | -36.57      |
| 7639.83 | ---         | V        | ---        | ---          | ---        | ---      | -13.00 | ---         |
| 8488.70 | ---         | V        | ---        | ---          | ---        | ---      | -13.00 | ---         |
| 849.02  | 75.98       | H        | -11.04     | -7.88        | 3.75       | -22.66   | -13.00 | -9.66       |
| 1697.74 | 84.36       | H        | -22.62     | 9.44         | 5.14       | -18.33   | -13.00 | -5.33       |
| 2546.61 | 70.94       | H        | -32.84     | 10.20        | 6.40       | -29.04   | -13.00 | -16.04      |
| 3395.48 | 62.13       | H        | -40.15     | 12.38        | 7.33       | -35.10   | -13.00 | -22.10      |
| 4244.35 | 56.09       | H        | -43.10     | 12.63        | 8.46       | -38.93   | -13.00 | -25.93      |
| 5093.22 | 52.07       | H        | -44.03     | 12.74        | 9.32       | -40.60   | -13.00 | -27.60      |
| 5942.09 | 40.63       | H        | -53.46     | 13.81        | 9.89       | -49.54   | -13.00 | -36.54      |
| 6790.96 | ---         | H        | ---        | ---          | ---        | ---      | -13.00 | ---         |
| 7639.83 | ---         | H        | ---        | ---          | ---        | ---      | -13.00 | ---         |
| 8488.70 | ---         | H        | ---        | ---          | ---        | ---      | -13.00 | ---         |

Remark :

- 1 The emission behaviour belongs to narrowband spurious emission.
- 2 Remark”---“ means that the emission level is too low to be measured
- 3 The result basic equation calculation is as follows:
- 4  $ERP/EIRP (dBm) = SG \text{ Setting}(dBm) + Antenna \text{ Gain} (dBd/dBi) - Cable \text{ loss} (dB)$

**Radiated Spurious Emission Measurement Result: PCS 1900 Mode**

Operation Mode : TX CH Low  
 Fundamental Frequency : 1850.20MHz  
 Temperature : 25°C  
 Humidity : 65%

Test Date Jun. 09, 2005  
 Test By: Sky  
 Pol: Ver/Hor

| Freq.    | SPA Reading | Ant.Pol. | S.G Output | Antenna Gain | Cable Loss | ERP/EIRP | Limit  | Safe Margin |
|----------|-------------|----------|------------|--------------|------------|----------|--------|-------------|
| (MHz)    | (dBuV)      | H/V      | (dBm)      | (dB/dBi)     | (dB)       | (dBm)    | (dBm)  | (dBm)       |
| 1849.98  | 86.45       | V        | -20.51     | 9.90         | 5.41       | -16.02   | -13.00 | -3.02       |
| 3700.40  | 47.51       | V        | -54.07     | 12.61        | 7.73       | -49.19   | -13.00 | -36.19      |
| 5550.60  | 46.89       | V        | -48.32     | 13.23        | 9.68       | -44.78   | -13.00 | -31.78      |
| 7400.80  | 40.58       | V        | -45.42     | 11.50        | 11.28      | -45.19   | -13.00 | -32.19      |
| 9251.00  | ---         | V        | ---        | ---          | ---        | ---      | -13.00 | ---         |
| 11101.20 | ---         | V        | ---        | ---          | ---        | ---      | -13.00 | ---         |
| 12951.40 | ---         | V        | ---        | ---          | ---        | ---      | -13.00 | ---         |
| 14801.60 | ---         | V        | ---        | ---          | ---        | ---      | -13.00 | ---         |
| 16651.80 | ---         | V        | ---        | ---          | ---        | ---      | -13.00 | ---         |
| 18502.00 | ---         | V        | ---        | ---          | ---        | ---      | -13.00 | ---         |
| 1849.97  | 79.09       | H        | -27.80     | 9.90         | 5.41       | -23.31   | -13.00 | -10.31      |
| 3700.40  | 47.23       | H        | -54.13     | 12.61        | 7.73       | -49.25   | -13.00 | -36.25      |
| 5550.60  | 43.89       | H        | -51.24     | 13.23        | 9.68       | -47.69   | -13.00 | -34.69      |
| 7400.80  | ---         | H        | ---        | ---          | ---        | ---      | -13.00 | ---         |
| 9251.00  | ---         | H        | ---        | ---          | ---        | ---      | -13.00 | ---         |
| 11101.20 | ---         | H        | ---        | ---          | ---        | ---      | -13.00 | ---         |
| 12951.40 | ---         | H        | ---        | ---          | ---        | ---      | -13.00 | ---         |
| 14801.60 | ---         | H        | ---        | ---          | ---        | ---      | -13.00 | ---         |
| 16651.80 | ---         | H        | ---        | ---          | ---        | ---      | -13.00 | ---         |
| 18502.00 | ---         | H        | ---        | ---          | ---        | ---      | -13.00 | ---         |

Remark :

- 1 The emission behaviour belongs to narrowband spurious emission.
- 2 Remark”---“ means that the emission level is too low to be measured
- 3 The result basic equation calculation is as follows:
- 4  $ERP/EIRP (dBm) = SG \text{ Setting}(dBm) + Antenna \text{ Gain} (dBd/dBi) - Cable \text{ loss} (dB)$



**Radiated Spurious Emission Measurement Result : PCS 1900 Mode**

Operation Mode : TX CH Mid  
 Fundamental Frequency : 1880MHz  
 Temperature : 25°C  
 Humidity : 65%

Test Date Jun. 09, 2005  
 Test By Sky  
 Pol : Ver/Hor

| Freq.    | SPA Reading | Ant.Pol. | S.G Out-put | Antenna Gain | Cable Loss | ERP/EIRP | Limit  | Safe Margin |
|----------|-------------|----------|-------------|--------------|------------|----------|--------|-------------|
| (MHz)    | (dBuV)      | H/V      | (dBm)       | (dB/dBi)     | (dB)       | (dBm)    | (dBm)  | (dBm)       |
| 3760.00  | 50.59       | V        | -50.71      | 12.60        | 7.82       | -45.93   | -13.00 | -32.93      |
| 5640.00  | 47.55       | V        | -47.41      | 13.36        | 9.73       | -43.78   | -13.00 | -30.78      |
| 7520.00  | 39.30       | V        | -46.31      | 11.45        | 11.33      | -46.20   | -13.00 | -33.20      |
| 9400.00  | ---         | V        | ---         | ---          | ---        | ---      | -13.00 | ---         |
| 11280.00 | ---         | V        | ---         | ---          | ---        | ---      | -13.00 | ---         |
| 13160.00 | ---         | V        | ---         | ---          | ---        | ---      | -13.00 | ---         |
| 15040.00 | ---         | V        | ---         | ---          | ---        | ---      | -13.00 | ---         |
| 16920.00 | ---         | V        | ---         | ---          | ---        | ---      | -13.00 | ---         |
| 18800.00 | ---         | V        | ---         | ---          | ---        | ---      | -13.00 | ---         |
| 3760.00  | 50.81       | H        | -50.30      | 12.60        | 7.82       | -45.51   | -13.00 | -32.51      |
| 5640.00  | 45.93       | H        | -48.96      | 13.36        | 9.73       | -45.33   | -13.00 | -32.33      |
| 7520.00  | ---         | H        | ---         | ---          | ---        | ---      | -13.00 | ---         |
| 9400.00  | ---         | H        | ---         | ---          | ---        | ---      | -13.00 | ---         |
| 11280.00 | ---         | H        | ---         | ---          | ---        | ---      | -13.00 | ---         |
| 13160.00 | ---         | H        | ---         | ---          | ---        | ---      | -13.00 | ---         |
| 15040.00 | ---         | H        | ---         | ---          | ---        | ---      | -13.00 | ---         |
| 16920.00 | ---         | H        | ---         | ---          | ---        | ---      | -13.00 | ---         |
| 18800.00 | ---         | H        | ---         | ---          | ---        | ---      | -13.00 | ---         |

Remark :

- 1 The emission behaviour belongs to narrowband spurious emission.
- 2 Remark"---" means that the emission level is too low to be measured
- 3 The result basic equation calculation is as follows:
- 4  $ERP/EIRP (dBm) = SG \text{ Setting}(dBm) + Antenna \text{ Gain} (dBd/dBi) - Cable \text{ loss} (dB)$

**Radiated Spurious Emission Measurement Result: PCS 1900 Mode**

Operation Mode : TX CH High  
 Fundamental Frequency : 1909.8 MHz  
 Temperature : 25°C  
 Humidity : 65%

Test Date Jun. 09, 2005  
 Test By Sky  
 Pol Ver/Hor

| Freq.    | SPA Reading | Ant.Pol. | S.G Output | Antenna Gain | Cable Loss | ERP/EIRP | Limit  | Safe Margin |
|----------|-------------|----------|------------|--------------|------------|----------|--------|-------------|
| (MHz)    | (dBuV)      | H/V      | (dBm)      | (dB/dBi)     | (dB)       | (dBm)    | (dBm)  | (dBm)       |
| 1910.02  | 87.18       | V        | -19.76     | 10.08        | 5.51       | -15.19   | -13.00 | -2.19       |
| 3819.60  | 45.54       | V        | -55.49     | 12.60        | 7.92       | -50.80   | -13.00 | -37.80      |
| 5729.40  | 43.14       | V        | -51.56     | 13.49        | 9.78       | -47.85   | -13.00 | -34.85      |
| 7639.20  | 41.66       | V        | -43.51     | 11.40        | 11.48      | -43.58   | -13.00 | -30.58      |
| 9549.00  | ---         | V        | ---        | ---          | ---        | ---      | -13.00 | ---         |
| 11458.80 | ---         | V        | ---        | ---          | ---        | ---      | -13.00 | ---         |
| 13368.60 | ---         | V        | ---        | ---          | ---        | ---      | -13.00 | ---         |
| 15278.40 | ---         | V        | ---        | ---          | ---        | ---      | -13.00 | ---         |
| 17188.20 | ---         | V        | ---        | ---          | ---        | ---      | -13.00 | ---         |
| 19098.00 | ---         | V        | ---        | ---          | ---        | ---      | -13.00 | ---         |
| 1910.03  | 78.23       | H        | -28.62     | 10.08        | 5.51       | -24.06   | -13.00 | -11.06      |
| 3819.60  | 49.39       | H        | -51.47     | 12.60        | 7.92       | -46.78   | -13.00 | -33.78      |
| 5729.40  | 46.21       | H        | -48.44     | 13.49        | 9.78       | -44.73   | -13.00 | -31.73      |
| 7639.20  | ---         | H        | ---        | ---          | ---        | ---      | -13.00 | ---         |
| 9549.00  | ---         | H        | ---        | ---          | ---        | ---      | -13.00 | ---         |
| 11458.80 | ---         | H        | ---        | ---          | ---        | ---      | -13.00 | ---         |
| 13368.60 | ---         | H        | ---        | ---          | ---        | ---      | -13.00 | ---         |
| 15278.40 | ---         | H        | ---        | ---          | ---        | ---      | -13.00 | ---         |
| 17188.20 | ---         | H        | ---        | ---          | ---        | ---      | -13.00 | ---         |
| 19098.00 | ---         | H        | ---        | ---          | ---        | ---      | -13.00 | ---         |

Remark :

- 1 The emission behaviour belongs to narrowband spurious emission.
- 2 Remark”---“ means that the emission level is too low to be measured
- 3 The result basic equation calculation is as follows:
- 4  $ERP/EIRP (dBm) = SG \text{ Setting}(dBm) + Antenna \text{ Gain} (dBd/dBi) - Cable \text{ loss} (dB)$

This Test Report is issued by the Company subject to its General Conditions of Service printed overleaf. Attention is drawn to the limitations of liability, indemnification, and Jurisdictional issued defined therein. The results shown in this test report refer only to the sample(s) tested unless otherwise stated. This test report cannot be reproduced, except in full, without prior written permission of the Company. 此報告是遵循本公司訂定之通用服務條款所製作發放。請注意此條款列印於背面，將本公司之義務，免責，管轄權皆明確規範之。此報告結果除非另有說明僅對檢驗之樣品負責。本報告未經本公司書面許可，不可部份複製。