

# ELECTROMAGNETIC EMISSIONS COMPLIANCE REPORT

## INTENTIONAL RADIATOR CERTIFICATION TO FCC PART 22 SUBPART H and PART 24 SUBPART E REQUIREMENT

OF

**Product Name:** GPS tracking system with voice function

**Brand Name:** N/A

**Model Name:** GV8300 with HS100, GV8100N, GV8200N,  
GT8000N ,GT8005N

**FCC ID:** TBQGV-8300

**GSM Module ID:** QIPMC56

**Report No.:** ER/2006/80030

**Issue Date:** Nov. 07, 2006

**FCC Rule Part:** 2 & 24E& 22H

**Prepared for** Portman Electronics (shenzhen) Co., Ltd.  
9th Building, Tongfuyu Industrial District,  
Shenzhen 518109, China

**Prepared by** SGS Taiwan Ltd.  
No. 134, Wu Kung Rd., Wuku Industrial Zone,  
Taipei County, Taiwan.

*Note: This report shall not be reproduced except in full, without the written approval of SGS Taiwan Ltd. This document may be altered or revised by SGS Taiwan Ltd. personnel only, and shall be noted in the revision section of the document.*

## VERIFICATION OF COMPLIANCE

**Applicant:** Portman Electronics (shenzhen) Co., Ltd.  
9th Building, Tongfuyu Industrial District, Shenzhen 518109, China

**Equipment Under Test:** GPS tracking system with voice function

**FCC ID Number:** TBQGV-8300

**Brand Name:** N/A

**Model No.:** GV8300 with HS100, GV8100N, GV8200N, GT8000N ,GT8005N

**Model Difference:** Please see page 3

**File Number:** ER/2006/80030



**Date of test:** Apr. 29, 2006 ~ Oct. 13, 2006

**Date of EUT Received:** Apr. 29, 2006

### We hereby certify that:

The above equipment was tested by SGS Taiwan Ltd. The test data, data evaluation, test procedures, and equipment configurations shown in this report were made in accordance with the procedures given in TIA/EIA-603-1-1998 and the energy emitted by the sample EUT tested as described in this report is in compliance with conducted and radiated emission limits of FCC Rule FCC PART 22 subpart H and FCC PART 24 subpart E.

The test results of this report relate only to the tested sample identified in this report.

<b>Test By:</b>		<b>Date</b>	Nov. 07, 2006
	<i>Jason Wu / Sr. Engineer</i>		
<b>Prepared By:</b>		<b>Date</b>	Nov. 07, 2006
	<i>Eva Kao / Sr. Engineer</i>		
<b>Approved By</b>		<b>Date</b>	Nov. 07, 2006
	<i>Vincent Su / Manager</i>		

## List of Model different

Main model name: GV8300 with HS100

Series model name: GV8100N, GV8200N, GT8000N ,GT8005N

The list of model different as below:

Modification Id.	Reason for modification
GV8100N	Function is the same as GV-8300 (without telemetric display HS-100), but the accessories do not include (1) Tilt sensor (2) Temperature sensor (3) 1-button keypad (4) 12 button keypad and (5) HS-100 information display.
GV8200N	Function is the same as GV-8300 (without telemetric display HS-100), but the accessories do not include (1) Tilt sensor (2) Temperature sensor (3) 1-button keypad (4) 2 button keypad and (5) HS-100 information display
GT8000N	Function is the same as GV-8300 (but without voice function), the accessories do not include (1) Tilt sensor (2) Temperature sensor (3) 2-button keypad (4) 12 button keypad (5) Mic (6) Speaker and (7) HS-100 information display
GT8005N	Function is the same as GV-8300 (but without voice function), the accessories do not include (1) Temperature sensor (2) 2-button keypad (3) 12 button keypad (4) Mic (5) Speaker and (6) HS-100 information display

## Version

Version No.	Date
00	Oct. 20, 2006
01	Nov. 07, 2006

## Table of Contents

<b>1. GENERAL INFORMATION .....</b>	<b>6</b>
1.1 Product Description .....	6
1.2 Related Submittal(s) / Grant (s) .....	6
1.3 Test Methodology .....	6
1.4 Test Facility .....	7
1.5 Special Accessories .....	7
1.6 Equipment Modifications .....	7
<b>2. SYSTEM TEST CONFIGURATION .....</b>	<b>8</b>
2.1 EUT Configuration .....	8
2.2 EUT Exercise .....	8
2.3 Test Procedure .....	8
2.4 Configuration of Tested System .....	9
<b>3. SUMMARY OF TEST RESULTS .....</b>	<b>10</b>
<b>4. DESCRIPTION OF TEST MODES .....</b>	<b>10</b>
<b>5. RF POWER OUTPUT MEASUREMENT .....</b>	<b>11</b>
5.1 Standard Applicable .....	11
5.2 Test Set-up: .....	11
5.3 Measurement Procedure .....	11
5.4 Measurement Equipment Used: .....	12
5.5 Measurement Result .....	12
<b>6. ERP, EIRP MEASUREMENT .....</b>	<b>13</b>
6.1 Standard Applicable .....	13
6.2 Test SET-UP (Block Diagram of Configuration) .....	13
6.3 Measurement Procedure .....	15
6.4 Measurement Equipment Used: .....	16
6.5 Measurement Result .....	17
<b>7. FIELD STRENGTH OF SPURIOUS RADIATION MEASUREMENT .....</b>	<b>18</b>
7.1 Standard Applicable .....	18
7.2 EUT Setup (Block Diagram of Configuration) .....	18
7.3 Measurement Procedure .....	20
7.4 Measurement Equipment Used: .....	21
7.5 Measurement Result .....	21

GENERAL INFORMATION

1.1 Product Description

Product	GPS tracking system with voice function	
Model Name	GV8300 with HS100, GV8100N, GV8200N, GT8000N, GT8005N	
Model Difference:	N/A	
Brand Name	N/A	
Frequency Range and Power	GSM 850: 824 MHz – 849 MHz	33 dBm
	GSM 1900: 1850 MHz –1910 MHz	30 dBm
Type of Emission	300KGXW	
Power Supply	12V DC by Car Battery	
Antenna Type / Gain	Dipole antenna / 3dBi	

1.2 Related Submittal(s) / Grant (s)

This submittal(s) (test report) is intended for FCC ID: **TBQGV-8300** filing to comply with Section Part 22 subpart H and Part 24 subpart E of the FCC CFR 47 Rules.

1.3 Test Methodology

Both conducted and radiated testing were performed according to the procedures document on chapter 13 of ANSI C63.4 (2003) and FCC CFR 47.1046, 2.1047, 2.1049, 2.1051, 2.1053, 2.1055 and 2.1057.

## 1.4 Test Facility

The open area test site and conducted measurement facility used to collect the radiated data is located on the address of SGS Taiwan Ltd. No. 134, Wu Kung Rd., Wuku Industrial Zone, Taipei Country, Taiwan. The Open Area Test Sites and the Line Conducted labs are constructed and calibrated to meet the FCC requirements in documents ANSI C63.4: 2003 and CISPR 22/EN 55022 requirements. Site No. 1(3 & 10 meters) Registration Number: 94644, Anechoic chamber (3 meters) Registration Number: 573967

## 1.5 Special Accessories

Not available for this EUT intended for grant.

## 1.6 Equipment Modifications

Not available for this EUT intended for grant.

## 2. SYSTEM TEST CONFIGURATION

### 2.1 EUT Configuration

The EUT configuration for testing is installed on RF field strength measurement to meet the Commissions requirement and operating in a manner which intends to maximize its emission characteristics in a continuous normal application.

### 2.2 EUT Exercise

The EUT (Transmitter) was operated in the engineering mode to fix the Tx frequency which was for the purpose of the measurements.

### 2.3 Test Procedure

#### 2.3.1 Conducted Emissions

The EUT is placed on a turn table which is 0.8 m above ground plane. According to the requirements in Section 7&13 of ANSI C63.4-2003. Conducted emissions from the EUT measured in the frequency range between 0.15 MHz and 30MHz using CISPR Quasi-Peak and Average detector mode.

#### 2.3.2 Radiated Emissions

The EUT is placed on a turn table which is 1.0 m above ground plane. The turn table shall rotate 360 degrees to determine the position of maximum emission level. EUT is set 3m away from the receiving antenna which varied from 1m to 4m to find out the highest emission. And also, each emission was to be maximized by changing the polarization of receiving antenna both horizontal and vertical. In order to find out the max. emission, the relative positions of this hand-held transmitter(EUT) was rotated through three orthogonal axes according to the requirements in Section 8&13 of ANSI C63.4-2003.



## 2.4 Configuration of Tested System

Fig. 2-1 Configuration of Tested System

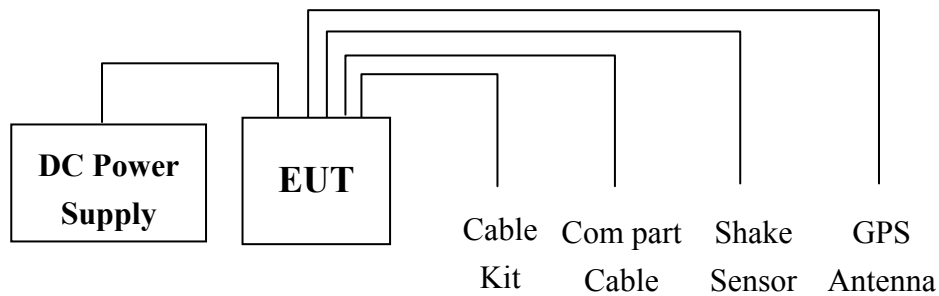

Table 2-1 Equipment Used in Tested System

Item	Equipment	Mfr/Brand	Model/ Type No.	FCC ID	Series No.
1.	DC Power Supply	TOPWARD	3303A	N/A	715856

### 3. SUMMARY OF TEST RESULTS

FCC Rules	Description Of Test	Result
§2.1046(a) §22.913(a) §24.232(a)	RF Power Output	Compliant
§2.1046(a) §22.913(a) §24.232(a)	ERP/ EIRP measurement	Compliant
§2.1049(h)	99% Occupied Bandwidth	N/A
§2.1051 §22.917(a) §24.238(a)	Out of Band Emissions at Antenna Terminals and Band Edge	N/A
§2.1053 §22.917(a) §24.238(a)	Field Strength of Spurious Radiation	Compliant
§2.1055(a)(1)(b)	Frequency Stability vs. Temperature	N/A
§2.1055(d)(1)(2)	Frequency Stability vs. Voltage	N/A
§15.107;§15.207	AC Power Line Conducted Emission	N/A

### 4. DESCRIPTION OF TEST MODES

The EUT has been tested under operating condition.

EUT staying in continuous transmitting mode. Channel low, Mid and High for each type and band with rated data rate are chosen for full testing.

The GSM module was approved and the FCC ID number is **QIPMC56**. Thus, the output power, ERP/EIRP and Field Strength of Spurious Radiation were tested.

## 5. RF POWER OUTPUT MEASUREMENT

### 5.1 Standard Applicable

According to FCC §2.1046.

FCC 22.913(a) Mobile station are limited to 7W.

FCC 24.232(b) Mobile station are limited to 2W.

### 5.2 Test Set-up:

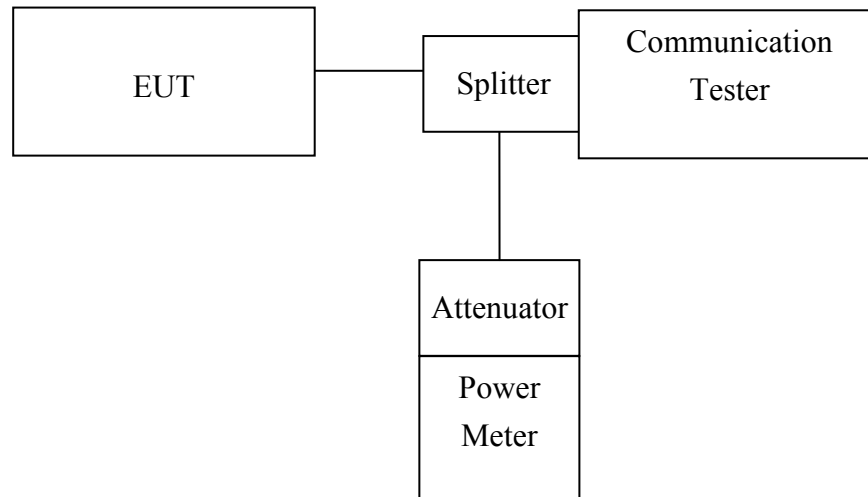

*Note: Measurement setup for testing on Antenna connector*

### 5.3 Measurement Procedure

The transmitter output was connected to a calibrated attenuator, the other end of which was connected to a power meter. Transmitter output was read off the power meter in dBm. The power output at the transmitter antenna port was determined by adding the value of the attenuator to the power meter reading.

### 5.4 Measurement Equipment Used:

Conducted Emission Test Site					
EQUIPMENT TYPE	MFR	MODEL NUMBER	SERIAL NUMBER	LAST CAL.	CAL DUE.
Spectrum Analyzer	Agilent	E4446A	MY43360126	03/29/2006	03/28/2007
Spectrum Analyzer	Agilent	E7405A	US41160416	06/28/2006	06/29/2007
Spectrum Analyzer	R&S	FSP 40	100034	11/09/2005	11/10/2006
Communication Test	R&S	SMU200	N/A	N/A	N/A
Power Sensor	Anritsu	MA2490A	31431	06/28/2006	06/29/2007
Power Meter	Anritsu	ML2487A	6K00002070	06/28/2006	06/29/2007
Temperature Chamber	TERCHY	MHG-120LF	911009	10/14/2006	10/13/2007
Low Loss Cable	HUBER+SUHNER	SUCOFLEX 104PEA	N/A	N/A	N/A
Attenuator	Mini-Circuit	BW-S10W5	N/A	09/23/2006	09/22/2007
Attenuator	Mini-Circuit	BW-S6W5	N/A	09/23/2006	09/22/2007
Splitter	Agilent	11636B	51728	09/23/2006	09/22/2007
DC Power Supply	TOPWARD	3303A	N/A	N/A	N/A

### 5.5 Measurement Result

EUT Mode	Frequency (MHz)	CH	Power meter Reading (dBm)	Path Loss (dB)	Peak Power (dBm)
GSM 850	824.20	128	4.10	27.50	31.60
	836.60	190	4.22	27.50	31.72
	848.80	251	4.23	27.50	31.73

EUT Mode	Frequency (MHz)	CH	Power Meter Reading (dBm)	Path Loss (dB)	Peak Power (dBm)
PCS 1900	1850.20	512	2.43	27.50	29.93
	1880.00	661	2.04	27.50	29.54
	1909.80	810	2.44	27.50	29.94

This document is issued by the Company subject to its General Conditions of Service printed overleaf or available on request and accessible at [www.sgs.com](http://www.sgs.com). Attention is drawn to the limitations of liability, indemnification, and Jurisdictional issued defined therein. Unless otherwise stated, the results shown in this test report refer only to the sample(s) tested. This document cannot be reproduced except in full, without prior approval of Company. Any unauthorized alteration, forgery or falsification of the content or appearance of this report is unlawful and offenders may be prosecuted to the fullest extent of the law. 此報告是遵循本公司訂定之通用服務條款所製作發放，請注意此條款列印於背面，亦可在[www.sgs.com](http://www.sgs.com)中查閱。將本公司之義務，免責，管轄權皆明確規範之。除非另有說明，此報告結果僅對檢驗之樣品負責。本報告未經本公司書面許可，不可部份複製。對本報告內容或外觀之任何未經授權之變更、偽造、竄改皆屬非法，違犯者將會被依法追訴。

## 6. ERP, EIRP MEASUREMENT

### 6.1 Standard Applicable

According to FCC §2.1046

FCC 22.913(a) Mobile station are limited to 7W ERP.

FCC 24.232(b) Mobile station are limited to 2W EIRP.

### 6.2 Test SET-UP (Block Diagram of Configuration)

(A) Radiated Emission Test Set-Up, Frequency Below 1000MHz

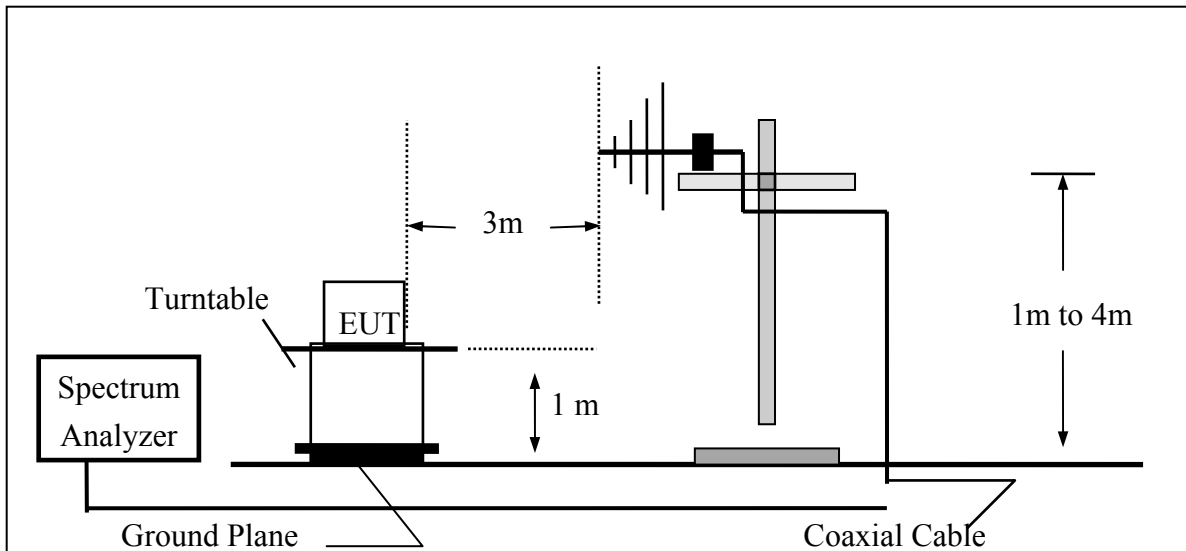

(B) Radiated Emission Test Set-UP Frequency Over 1 GHz

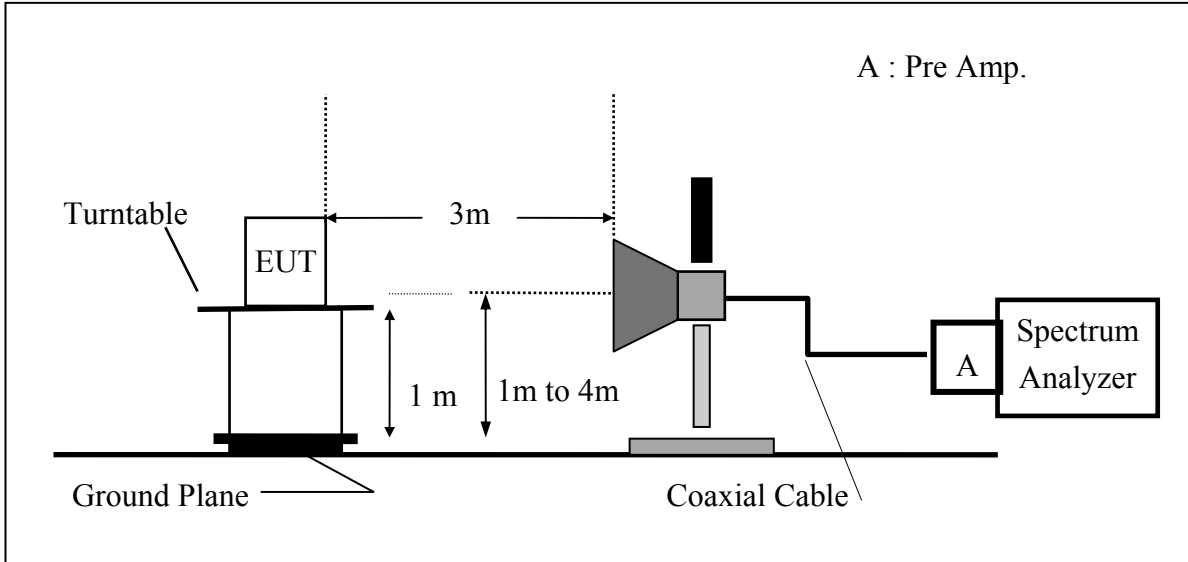

(C) Substituted Method Test Set-UP

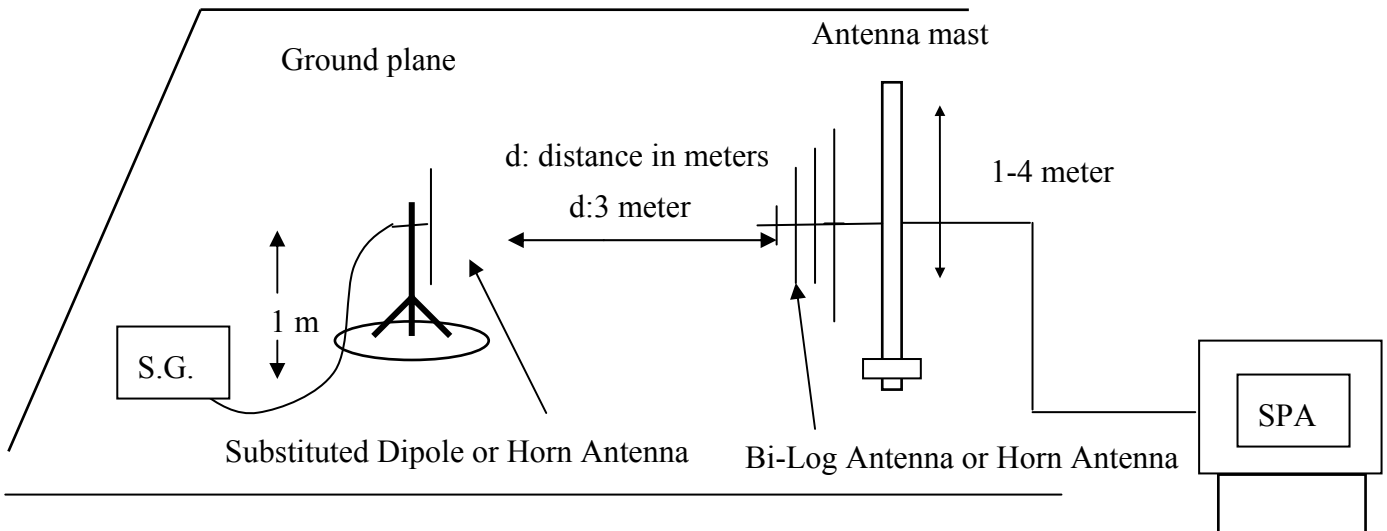

### 6.3 Measurement Procedure

The EUT was placed on a non-conductive turntable using a non-conductive support. The radiated emission at the fundamental frequency was measured at 3 m with a test antenna and EMI spectrum analyzer.

During the measurement, the EUT was in communication with the station. The highest emission was recorded with the rotation of the turntable and the lowering of the test antenna from 4m to 1m. The reading was recorded and the field strength (E in dBuV/m) was calculated.

ERP in frequency band 824.2 –848.80.8MHz were measured using a substitution method. The EUT was replaced by a dipole antenna connected, the S.G. output was recorded and ERP was calculated as follows:

EIRP in frequency band 1850.2 –1909.8MHz were measured using a substitution method. The EUT was replaced by a horn antenna connected, the S.G. output was recorded and EIRP was calculated as follows:

$$\text{ERP} = \text{S.G. output (dBm)} + \text{Antenna Gain (dBd)} - \text{Cable Loss (dB)}$$

$$\text{EIRP} = \text{S.G. output (dBm)} + \text{Antenna Gain (dBi)} - \text{Cable Loss (dB)}$$

#### 6.4 Measurement Equipment Used:

EQUIPMENT TYPE	MFR	MODEL NUMBER	SERIAL NUMBER	LAST CAL.	CAL DUE.
Spectrum Analyzer	Agilent	E4446A	MY43360126	03/29/2006	03/28/2007
Spectrum Analyzer	Agilent	7405A	US41160416	06/28/2006	06/29/2007
Spectrum Analyzer	R&S	FSP 40	100034	11/09/2005	11/10/2006
Communication Test	R&S	SMU200	N/A	N/A	N/A
Bilog Antenna	SCHWAZBECK	VULB9163	152	06/03/2006	06/02/2007
Horn antenna	Schwarzbeck	BBHA 9120D	309/320	08/16/2006	08/15/2007
Pre-Amplifier	HP	8447D	2944A09469	07/19/2006	07/18/2007
Pre-Amplifier	HP	8494B	3008A00578	02/26/2006	02/25/2007
Signal Generator	R&S	SMR40	100210	02/09/2006	02/10/2007
Turn Table	HD	DT420	N/A	N.C.R	N.C.R
Antenna Tower	HD	MA240-N	240/657	N.C.R	N.C.R
Controller	HD	HD100	N/A	N.C.R	N.C.R
Low Loss Cable	HUBER+SUHNER	SUCOFLEX 104PEA-10M	10m	10/09/2006	10/08/2007
Low Loss Cable	HUBER+SUHNER	SUCOFLEX 104PEA-3M	3m	10/09/2006	10/08/2007
Low Loss Cable	HUBER+SUHNER	SUCOFLEX 104PEA-0.5M	0.5m	10/09/2006	10/08/2007
Site NSA	SGS	966 chamber	N/A	11/17/2005	11/16/2006
Attenuator	Mini-Circuit	BW-S10W5	N/A	09/23/2006	09/22/2007
Dipole Antenna	Schwarzbeck	VHAP	908/909	06/10/2006	06/11/2007
Dipole Antenna	Schwarzbeck	UHAP	891/892	06/10/2006	06/11/2007
Horn antenna	Schwarzbeck	BBHA 9120D	N/A	08/16/2006	08/15/2007



### 6.5 Measurement Result

EUT Mode	Frequency (MHz)	CH	Antenna Pol.	SPA Reading (dBuV)	S.G. Output (dBm)	Antenna Gain (dBd)	Cable Loss (dB)	ERP (dBm)	Limit (dBm)
GSM 850	824.20	128	V	129.69	43.30	-7.87	3.62	31.80	38.45
			H	125.49	39.22	-7.87	3.62	27.72	38.45
	836.60	190	V	129.97	43.72	-7.88	3.65	32.19	38.45
			H	125.73	39.50	-7.88	3.65	27.97	38.45
	848.80	251	V	130.04	43.92	-7.88	3.68	32.36	38.45
			H	125.12	38.93	-7.88	3.68	27.37	38.45

EUT Mode	Frequency (MHz)	CH	Antenna Pol.	SPA Reading (dBuV)	S.G. Output (dBm)	Antenna Gain (dBi)	Cable Loss (dB)	EIRP (dBm)	Limit (dBm)
PCS 1900	1850.20	512	V	128.18	23.79	9.90	5.56	28.13	33.00
			H	124.98	20.80	9.90	5.56	25.14	33.00
	1880.00	661	V	128.71	24.35	9.99	5.61	28.73	33.00
			H	125.78	21.64	9.99	5.61	26.01	33.00
	1909.80	810	V	128.50	24.17	10.08	5.66	28.59	33.00
			H	126.71	22.60	10.08	5.66	27.02	33.00

Remark :	
(1)	The RBW,VBW of SPA for frequency Below 1GHz was RBW=100 KHz, VBW=300KHz, Above 1GHz was RBW= 1MHz , VBW= 3MHz

## 7. FIELD STRENGTH OF SPURIOUS RADIATION MEASUREMENT

### 7.1 Standard Applicable

According to FCC §2.1053,

FCC §22.917(a), §24.238(a), the magnitude of each spurious and harmonic emission that can be detected when the equipment is operated under the conditions specified in the instruction manual and/ or alignment procedure, shall not be less than  $43 + 10 \log$  (mean output power in watts) dBc below the mean power output outside a license's frequency block (-13dBm)

### 7.2 EUT Setup (Block Diagram of Configuration)

(A) Radiated Emission Test Set-Up, Frequency Below 1000MHz

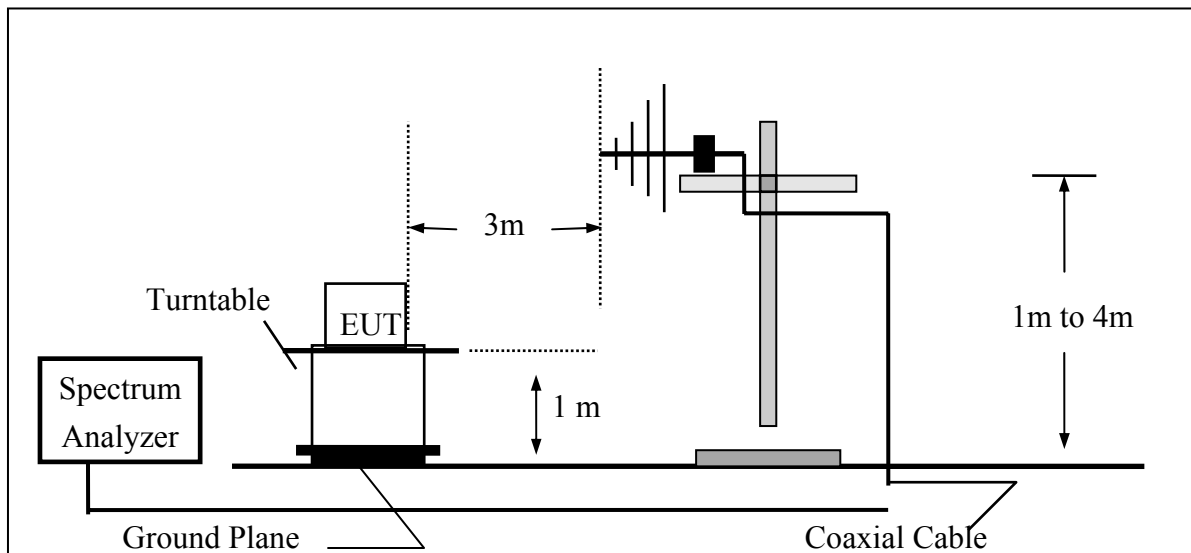

(B) Radiated Emission Test Set-UP Frequency Over 1 GHz

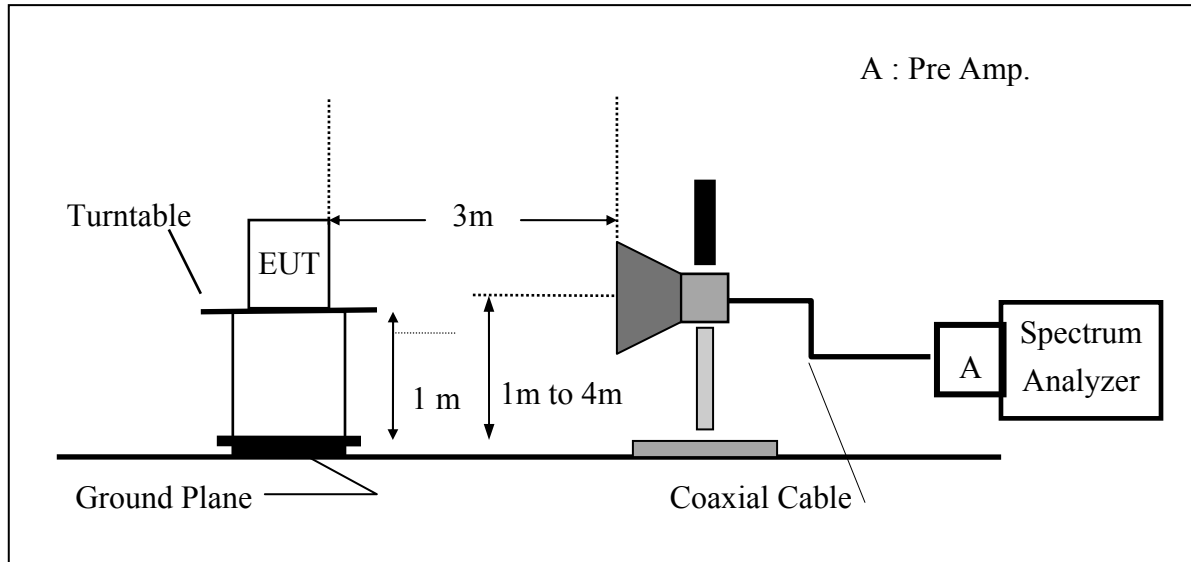

(C) Substituted Method Test Set-UP

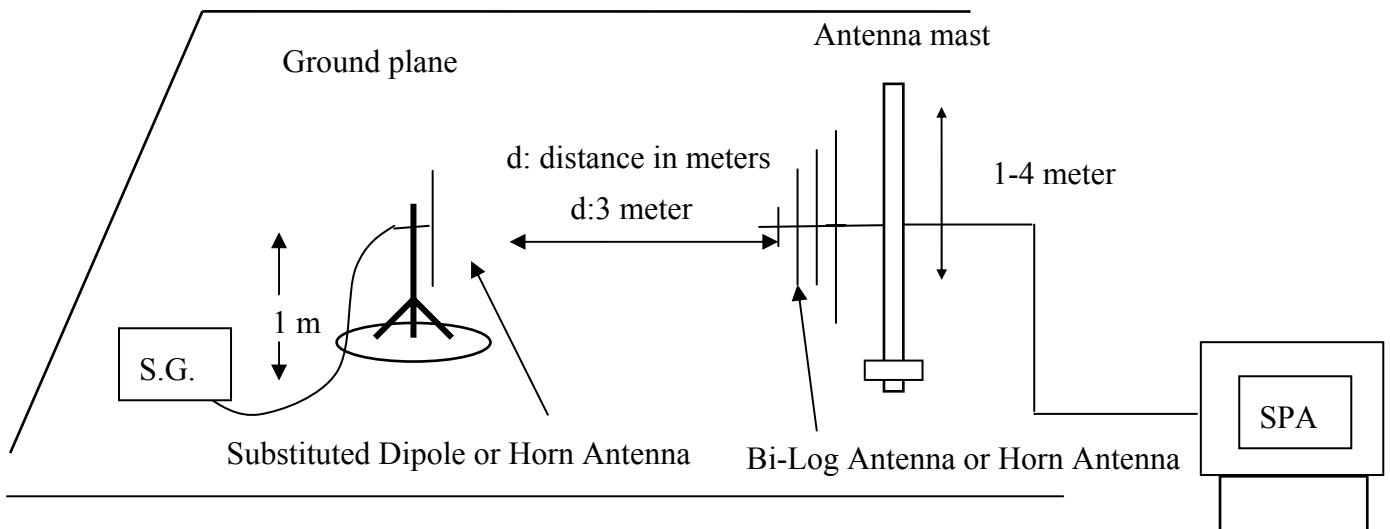

### 7.3 Measurement Procedure

The EUT was placed on a non-conductive, The measurement antenna was placed at a distance of 3 meters from the EUT. During the tests, the antenna height and the EUT azimuth were varied in order to identify the maximum level of emissions from the EUT. This maximization process was repeated with the EUT positioned in each of its three orthogonal orientations.

The frequency range up to tenth harmonic was investigated for each of three fundamental frequency (low, middle and high channels). Once spurious emission were identified, the power of the emission was determined using the substitution method.

The spurious emissions attenuation was calculated as the difference between radiated power at the fundamental frequency and the spurious emissions frequency.

$$\text{ERP} = \text{S.G. output (dBm)} + \text{Antenna Gain(dBd)} - \text{Cable Loss (dB)}$$

$$\text{EIRP} = \text{S.G. output (dBm)} + \text{Antenna Gain(dBi)} - \text{Cable Loss (dB)}$$

### 7.4 Measurement Equipment Used:

EQUIPMENT TYPE	MFR	MODEL NUMBER	SERIAL NUMBER	LAST CAL.	CAL DUE.
Spectrum Analyzer	Agilent	E4446A	MY43360126	03/29/2006	03/28/2007
Spectrum Analyzer	Agilent	7405A	US41160416	06/28/2006	06/29/2007
Spectrum Analyzer	R&S	FSP 40	100034	11/09/2005	11/10/2006
Communication Test	R&S	SMU200	N/A	N/A	N/A
Bilog Antenna	SCHWAZBECK	VULB9163	152	06/03/2006	06/02/2007
Horn antenna	Schwarzbeck	BBHA 9120D	309/320	08/16/2006	08/15/2007
Pre-Amplifier	HP	8447D	2944A09469	07/19/2006	07/18/2007
Pre-Amplifier	HP	8494B	3008A00578	02/26/2006	02/25/2007
Signal Generator	R&S	SMR40	100210	02/09/2006	02/10/2007
Turn Table	HD	DT420	N/A	N.C.R	N.C.R
Antenna Tower	HD	MA240-N	240/657	N.C.R	N.C.R
Controller	HD	HD100	N/A	N.C.R	N.C.R
Low Loss Cable	HUBER+SUHNER	SUCOFLEX 104PEA-10M	10m	10/09/2006	10/08/2007
Low Loss Cable	HUBER+SUHNER	SUCOFLEX 104PEA-3M	3m	10/09/2006	10/08/2007
Low Loss Cable	HUBER+SUHNER	SUCOFLEX 104PEA-0.5M	0.5m	10/09/2006	10/08/2007
Site NSA	SGS	966 chamber	N/A	11/17/2005	11/16/2006
Attenuator	Mini-Circuit	BW-S10W5	N/A	09/23/2006	09/22/2007
Dipole Antenna	Schwarzbeck	VHAP	908/909	06/10/2006	06/11/2007
Dipole Antenna	Schwarzbeck	UHAP	891/892	06/10/2006	06/11/2007
Horn antenna	Schwarzbeck	BBHA 9120D	N/A	08/16/2006	08/15/2007

### 7.5 Measurement Result

Refer to attach tabular data sheets.

**Radiated Spurious Emission Measurement Result: GSM 850 Mode**

Operation Mode : TX CH Low  
 Fundamental Frequency : 824.20 MHz  
 Temperature : 25°C  
 Humidity : 65%

Test Date: Jun. 09, 2005  
 Test By: Sky  
 Pol: Ver / Hor

Freq. (MHz)	SPA. Reading (dBuV)	Ant.Pol. H/V	S.G Out-put (dBm)	Antenna Gain (dB/dBi)	Cable Loss (dB)	ERP/EIRP (dBm)	Limit (dBm)	Safe Margin (dBm)
823.98	82.43	V	-3.96	-7.87	3.62	-15.46	-13.00	-2.46
1648.40	64.74	V	-39.84	9.29	5.23	-35.78	-13.00	-22.78
2472.60	---	V		10.08	6.53		-13.00	
3296.80	---	V		12.17	7.71		-13.00	
4121.00	---	V		12.61	8.86		-13.00	
4945.20	---	V		12.65	9.74		-13.00	
5769.40	---	V		13.55	10.54		-13.00	
6593.60	---	V		12.05	11.30		-13.00	
7417.80	---	V		11.49	12.10		-13.00	
8242.00	---	V		11.48	12.71		-13.00	

823.98	76.23	H	-10.04	-7.87	3.62	-21.54	-13.00	-8.54
1648.40	55.78	H	-48.62	9.29	5.23	-44.56	-13.00	-31.56
2472.60	---	H		10.08	6.53		-13.00	
3296.80	---	H		12.17	7.71		-13.00	
4121.00	---	H		12.61	8.86		-13.00	
4945.20	---	H		12.65	9.74		-13.00	
5769.40	---	H		13.55	10.54		-13.00	
6593.60	---	H		12.05	11.30		-13.00	
7417.80	---	H		11.49	12.10		-13.00	
8242.00	---	H		11.48	12.71		-13.00	

Measurement uncertainty	30MHz - 80MHz: 5.04dB
	80MHz -1000MHz: 3.76dB
	1GHz - 13GHz: 4.45dB

Remark :

- 1 The emission behaviour belongs to narrowband spurious emission.
- 2 Remark”---“ means that the emission level is too low to be measured
- 3 The result basic equation calculation is as follows:
- 4  $ERP/EIRP (dBm) = SG \text{ Setting}(dBm) + Antenna \text{ Gain} (dB/dBi) - Cable \text{ loss} (dB)$

This document is issued by the Company subject to its General Conditions of Service printed overleaf or available on request and accessible at [www.sgs.com](http://www.sgs.com). Attention is drawn to the limitations of liability, indemnification, and Jurisdictional issued defined therein. Unless otherwise stated, the results shown in this test report refer only to the sample(s) tested. This document cannot be reproduced except in full, without prior approval of Company. Any unauthorized alteration, forgery or falsification of the content or appearance of this report is unlawful and offenders may be prosecuted to the fullest extent of the law. 此報告是遵循本公司訂定之通用服務條款所製作發放，請注意此條款列印於背面，亦可在[www.sgs.com](http://www.sgs.com)中查閱。將本公司之義務，免責，管轄權皆明確規範之。除非另有說明，此報告結果僅對檢驗之樣品負責。本報告未經本公司書面許可，不可部份複製。對本報告內容或外觀之任何未經授權之變更、偽造、竄改皆屬非法，違犯者將會被依法追訴。

**Radiated Spurious Emission Measurement Result: GSM 850 Mode**

Operation Mode : TX CH Mid  
 Fundamental Frequency : 836.60 MHz  
 Temperature : 25°C  
 Humidity : 65%

Test Date: Jun. 09, 2005  
 Test By: Sky  
 Pol: Ver / Hor

Freq. (MHz)	SPA. Reading (dBUV)	Ant.Pol. H/V	S.G Out-put (dBm)	Antenna Gain (dB/dBi)	Cable Loss (dB)	ERP/EIRP (dBm)	Limit (dBm)	Safe Margin (dBm)
1673.20	59.74	V	-44.82	9.36	5.27	-40.72	-13.00	-27.72
2509.80	---	V		10.09	6.58		-13.00	
3346.40	---	V		12.28	7.79		-13.00	
4183.00	---	V		12.62	8.93		-13.00	
5019.60	---	V		12.67	9.81		-13.00	
5856.20	---	V		13.68	10.62		-13.00	
6692.80	---	V		11.95	11.39		-13.00	
7529.40	---	V		11.45	12.20		-13.00	
8366.00	---	V		11.59	12.81		-13.00	

1673.20	56.06	H	-48.32	9.36	5.27	-44.22	-13.00	-31.22
2509.80	---	H		10.09	6.58		-13.00	
3346.40	---	H		12.28	7.79		-13.00	
4183.00	---	H		12.62	8.93		-13.00	
5019.60	---	H		12.67	9.81		-13.00	
5856.20	---	H		13.68	10.62		-13.00	
6692.80	---	H		11.95	11.39		-13.00	
7529.40	---	H		11.45	12.20		-13.00	
8366.00	---	H		11.59	12.81		-13.00	

Measurement uncertainty	30MHz - 80MHz: 5.04dB
	80MHz -1000MHz: 3.76dB
	1GHz - 13GHz: 4.45dB

Remark :

- 1 The emission behaviour belongs to narrowband spurious emission.
- 2 Remark”---“ means that the emission level is too low to be measured
- 3 The result basic equation calculation is as follows:
- 4  $ERP/EIRP (dBm) = SG \text{ Setting}(dBm) + Antenna \text{ Gain} (dB/dBi) - Cable \text{ loss} (dB)$

**Radiated Spurious Emission Measurement Result: GSM 850 Mode**

Operation Mode : TX CH High  
 Fundamental Frequency : 848.80 MHz  
 Temperature : 25°C  
 Humidity : 65%

Test Date: Jun. 09, 2005  
 Test By: Sky  
 Pol: Ver / Hor

Freq. (MHz)	SPA. Reading (dBuV)	Ant.Pol. H/V	S.G Out-put (dBm)	Antenna Gain (dB/dBi)	Cable Loss (dB)	ERP/EIRP (dBm)	Limit (dBm)	Safe Margin (dBm)
849.02	83.79	V	-2.33	-7.88	3.68	-13.89	-13.00	-0.89
1697.60	53.80	V	-50.74	9.44	5.31	-46.61	-13.00	-33.61
2546.40	---	V		10.20	6.63		-13.00	
3395.20	---	V		12.38	7.87		-13.00	
4244.00	---	V		12.63	9.00		-13.00	
5092.80	---	V		12.74	9.88		-13.00	
5941.60	---	V		13.81	10.70		-13.00	
6790.40	---	V		11.86	11.48		-13.00	
7639.20	---	V		11.40	12.27		-13.00	
8488.00	---	V		11.70	12.91		-13.00	

849.02	79.09	H	-7.10	-7.88	3.68	-18.66	-13.00	-5.66
1697.60	50.07	H	-54.28	9.44	5.31	-50.15	-13.00	-37.15
2546.40	---	H		10.20	6.63		-13.00	
3395.20	---	H		12.38	7.87		-13.00	
4244.00	---	H		12.63	9.00		-13.00	
5092.80	---	H		12.74	9.88		-13.00	
5941.60	---	H		13.81	10.70		-13.00	
6790.40	---	H		11.86	11.48		-13.00	
7639.20	---	H		11.40	12.27		-13.00	
8488.00	---	H		11.70	12.91		-13.00	

Measurement uncertainty	30MHz - 80MHz: 5.04dB
	80MHz -1000MHz: 3.76dB
	1GHz - 13GHz: 4.45dB

Remark :

- 1 The emission behaviour belongs to narrowband spurious emission.
- 2 Remark"---" means that the emission level is too low to be measured
- 3 The result basic equation calculation is as follows:
- 4  $ERP/EIRP (dBm) = SG \text{ Setting}(dBm) + Antenna \text{ Gain} (dB/dBi) - Cable \text{ loss} (dB)$

This document is issued by the Company subject to its General Conditions of Service printed overleaf or available on request and accessible at [www.sgs.com](http://www.sgs.com). Attention is drawn to the limitations of liability, indemnification, and Jurisdictional issued defined therein. Unless otherwise stated, the results shown in this test report refer only to the sample(s) tested. This document cannot be reproduced except in full, without prior approval of Company. Any unauthorized alteration, forgery or falsification of the content or appearance of this report is unlawful and offenders may be prosecuted to the fullest extent of the law. 此報告是遵循本公司訂定之通用服務條款所製作發放，請注意此條款列印於背面，亦可在[www.sgs.com](http://www.sgs.com)中查閱。將本公司之義務，免責，管轄權皆明確規範之。除非另有說明，此報告結果僅對檢驗之樣品負責。本報告未經本公司書面許可，不可部份複製。對本報告內容或外觀之任何未經授權之變更、偽造、竄改皆屬非法，違犯者將會被依法追訴。



**Radiated Spurious Emission Measurement Result: PCS 1900 Mode**

Operation Mode : TX CH Low  
 Fundamental Frequency : 1850.20MHz  
 Temperature : 25°C  
 Humidity : 65%

Test Date Jun. 09, 2005  
 Test By: Sky  
 Pol: Ver/Hor

Freq. (MHz)	SPA Reading (dBuV)	Ant.Pol. H/V	S.G Out-put (dBm)	Antenna Gain (dB/dBi)	Cable Loss (dB)	ERP/EIRP (dBm)	Limit (dBm)	Safe Margin (dBm)
1457.50	46.18	V	-58.73	8.60	4.56	-54.69	-13.00	-41.69
1850.00	80.81	V	-23.58	9.90	5.56	-19.24	-13.00	-6.24
3700.40	52.98	V	-44.95	12.61	8.31	-40.65	-13.00	-27.65
5550.60	50.79	V	-40.05	13.23	10.33	-37.15	-13.00	-24.15
7400.80	37.80	V	-43.44	11.50	12.08	-44.02	-13.00	-31.02
9251.00	---	V		11.92	13.50		-13.00	
11101.20	---	V		11.66	15.11		-13.00	
12951.40	---	V		13.63	16.60		-13.00	
14801.60	---	V		12.76	17.95		-13.00	
16651.80	---	V		15.92	19.14		-13.00	
18502.00	---	V		18.75	10.40		-13.00	
1850.00	74.43	H	-29.75	9.90	5.56	-25.41	-13.00	-12.41
3700.40	55.70	H	-42.34	12.61	8.31	-38.04	-13.00	-25.04
5550.60	46.00	H	-45.05	13.23	10.33	-42.15	-13.00	-29.15
7400.80	---	H		11.50	12.08		-13.00	
9251.00	---	H		11.92	13.50		-13.00	
11101.20	---	H		11.66	15.11		-13.00	
12951.40	---	H		13.63	16.60		-13.00	
14801.60	---	H		12.76	17.95		-13.00	
16651.80	---	H		15.92	19.14		-13.00	
18502.00	---	H		18.75	10.40		-13.00	

Measurement uncertainty	30MHz - 80MHz: 5.04dB
	80MHz -1000MHz: 3.76dB
	1GHz - 13GHz: 4.45dB

Remark :

- 1 The emission behaviour belongs to narrowband spurious emission.
- 2 Remark"---" means that the emission level is too low to be measured
- 3 The result basic equation calculation is as follows:
- 4  $ERP/EIRP (dBm) = SG \text{ Setting}(dBm) + Antenna \text{ Gain} (dB/dBi) - Cable \text{ loss} (dB)$

This document is issued by the Company subject to its General Conditions of Service printed overleaf or available on request and accessible at [www.sgs.com](http://www.sgs.com). Attention is drawn to the limitations of liability, indemnification, and Jurisdictional issued defined therein. Unless otherwise stated, the results shown in this test report refer only to the sample(s) tested. This document cannot be reproduced except in full, without prior approval of Company. Any unauthorized alteration, forgery or falsification of the content or appearance of this report is unlawful and offenders may be prosecuted to the fullest extent of the law. 此報告是遵循本公司訂定之通用服務條款所製作發放，請注意此條款列印於背面，亦可在[www.sgs.com](http://www.sgs.com)中查閱。將本公司之義務，免責，管轄權皆明確規範之。除非另有說明，此報告結果僅對檢驗之樣品負責。本報告未經本公司書面許可，不可部份複製。對本報告內容或外觀之任何未經授權之變更、偽造、竄改皆屬非法，違犯者將會被依法追訴。

**Radiated Spurious Emission Measurement Result : PCS 1900 Mode**

Operation Mode : TX CH Mid  
 Fundamental Frequency : 1880MHz  
 Temperature : 25°C  
 Humidity : 65%

Test Date Jun. 09, 2005  
 Test By Sky  
 Pol : Ver/Hor

Freq. (MHz)	SPA. Reading (dBuV)	Ant.Pol. H/V	S.G Out-put (dBm)	Antenna Gain (dB/dBi)	Cable Loss (dB)	ERP/EIRP (dBm)	Limit (dBm)	Safe Margin (dBm)
3760.00	56.39	V	-41.27	12.60	8.39	-37.05	-13.00	-24.05
5640.00	51.74	V	-38.84	13.36	10.41	-35.89	-13.00	-22.89
7520.00	37.72	V	-42.94	11.45	12.19	-43.68	-13.00	-30.68
9400.00	---	V		11.93	13.61		-13.00	
11280.00	---	V		11.92	15.27		-13.00	
13160.00	---	V		13.33	16.71		-13.00	
15040.00	---	V		13.76	18.15		-13.00	
16920.00	---	V		15.27	19.32		-13.00	
18800.00	---	V		18.68	16.58		-13.00	

3760.00	59.53	H	-38.24	12.60	8.39	-34.03	-13.00	-21.03
5640.00	47.38	H	-43.37	13.36	10.41	-40.42	-13.00	-27.42
7520.00	---	H		11.45	12.19		-13.00	
9400.00	---	H		11.93	13.61		-13.00	
11280.00	---	H		11.92	15.27		-13.00	
13160.00	---	H		13.33	16.71		-13.00	
15040.00	---	H		13.76	18.15		-13.00	
16920.00	---	H		15.27	19.32		-13.00	
18800.00	---	H		18.68	16.58		-13.00	

Measurement uncertainty	30MHz - 80MHz: 5.04dB
	80MHz -1000MHz: 3.76dB
	1GHz - 13GHz: 4.45dB

Remark :

- 1 The emission behaviour belongs to narrowband spurious emission.
- 2 Remark"---" means that the emission level is too low to be measured
- 3 The result basic equation calculation is as follows:
- 4  $ERP/EIRP (dBm) = SG \text{ Setting}(dBm) + Antenna \text{ Gain} (dB/dBi) - Cable \text{ loss} (dB)$

**Radiated Spurious Emission Measurement Result: PCS 1900 Mode**

Operation Mode : TX CH High  
 Fundamental Frequency : 1909.8 MHz  
 Temperature : 25°C  
 Humidity : 65%

Test Date Jun. 09, 2005  
 Test By Sky  
 Pol Ver/Hor

Freq. (MHz)	SPA. Reading (dBuV)	Ant.Pol. H/V	S.G Out-put (dBm)	Antenna Gain (dB/dBi)	Cable Loss (dB)	ERP/EIRP (dBm)	Limit (dBm)	Safe Margin (dBm)
1910.00	82.20	V	-22.13	10.08	5.66	-17.71	-13.00	-4.71
3819.60	56.66	V	-40.73	12.60	8.47	-36.60	-13.00	-23.60
5729.40	48.08	V	-42.24	13.49	10.50	-39.24	-13.00	-26.24
7639.20	42.33	V	-38.15	11.40	12.27	-39.02	-13.00	-26.02
9549.00	---	V		11.95	13.74		-13.00	
11458.80	---	V		12.17	15.43		-13.00	
13368.60	---	V		12.97	16.82		-13.00	
15278.40	---	V		15.00	18.29		-13.00	
17188.20	---	V		14.47	19.52		-13.00	
19098.00	---	V		18.66	20.78		-13.00	
1910.00	78.31	H	-25.80	10.08	5.66	-21.38	-13.00	-8.38
3819.60	58.39	H	-39.12	12.60	8.47	-34.98	-13.00	-21.98
5729.40	42.98	H	-47.47	13.49	10.50	-44.48	-13.00	-31.48
7639.20	37.41	H	-43.02	11.40	12.27	-43.89	-13.00	-30.89
9549.00	---	H		11.95	13.74		-13.00	
11458.80	---	H		12.17	15.43		-13.00	
13368.60	---	H		12.97	16.82		-13.00	
15278.40	---	H		15.00	18.29		-13.00	
17188.20	---	H		14.47	19.52		-13.00	

Measurement uncertainty	30MHz - 80MHz: 5.04dB
	80MHz -1000MHz: 3.76dB
	1GHz - 13GHz: 4.45dB

Remark :

- 1 The emission behaviour belongs to narrowband spurious emission.
- 2 Remark”---“ means that the emission level is too low to be measured
- 3 The result basic equation calculation is as follows:
- 4  $ERP/EIRP (dBm) = SG \text{ Setting}(dBm) + Antenna \text{ Gain} (dB/dBi) - Cable \text{ loss} (dB)$

This document is issued by the Company subject to its General Conditions of Service printed overleaf or available on request and accessible at [www.sgs.com](http://www.sgs.com). Attention is drawn to the limitations of liability, indemnification, and Jurisdictional issued defined therein. Unless otherwise stated, the results shown in this test report refer only to the sample(s) tested. This document cannot be reproduced except in full, without prior approval of Company. Any unauthorized alteration, forgery or falsification of the content or appearance of this report is unlawful and offenders may be prosecuted to the fullest extent of the law. 此報告是遵循本公司訂定之通用服務條款所製作發放，請注意此條款列印於背面，亦可在[www.sgs.com](http://www.sgs.com)中查閱。將本公司之義務，免責，管轄權皆明確規範之。除非另有說明，此報告結果僅對檢驗之樣品負責。本報告未經本公司書面許可，不可部份複製。對本報告內容或外觀之任何未經授權之變更、偽造、竄改皆屬非法，違犯者將會被依法追訴。