

GPS/GPRS/SMS

TRACKING & ALARM SYSTEM

OPERATION GUIDE
GT-8000>8500

Introducing the next generation in vehicle security

Extends protection options beyond traditional car alarm

Monitor your vehicle location and status remotely

Communicate with it, be in control



ISO 9001 QS 9000

I. INTRODUCTION

PORTAN GPS GPRS Tracking and Alarm System utilize the GPS and car alarm functions in one unit. You can monitor the vehicle location and control the car alarm remotely. In addition, the unit will send event report if any trigger occurs. It has built-in 7 outputs and 5 inputs to perform essential alarm functions. More importantly, it can be connected with a PORTMAN AM series alarm to provide full protection.

1.1 Report structure

The standard report sent by the unit includes the information: (1) unit's ID, (2) status, (3) time, (4) GPS's latitude and longitude, (5) speed, (6) direction, (7) temperature, (8) device's status, (9) event number, and (10) report configuration parameters.

- (1) Unit's ID: each device has its own unique ID and must be registered in the server in order to perform monitoring or controlling.
- (2) status: A=Valid, L=last known.
- (3) Time: report time in Greenwich Mean time zone.
- (4) GPS's latitude and longitude.
- (5) Speed: in km/H
- (6) Direction: in degree to the North.
- (7) Temperature: in Celsius. If the temperature is not connected, 'NA' will be shown in this field.
- (8) Device's status: there are 32 states to represent the I/O and working modes for the both the device and the external alarm.
- (9) Event number: all the generated reports will include a unique event Nnumber to indicate why it has been sent.
- (10) Report configuration parameters: user can remotely change the report configuration, and the configuration parameters will be shown in this field.

1.2 Report Setup

GT-8000/GT8500 must be initialized by PORTMAN PC setup program in order to make communication with the remote server /call center. There are 4 main sections that allow users to program the device, (1) User detail (Device ID, server IP, and port, SMS number, GPRS APN,...) (2) In-built Geofence function (up to 5 circular and 5 rectangular Geofence shapes can be set in the device) (3) Automatic report setting (Time, Distance, Intelligent mode, Temperature, Low battery, Course change, ...) (4) ALARM report (to enable or disable the event generated by the inputs or external ALARM, e.g. ACC, DOOR, ALARM,...) Those data is saved in device's EEPROM and will not be lost even if the power is failure.

Note that the device ID, GPRS APN name, GPRS login name and password need to be set in initial PC setup in order to make the connection to the server. All the report configuration or Geofence setup can be changed at anytime via over-the-air commands.

The automatic reporting mode can be categorized as 'time' report, 'distance' report, or 'time & velocity' report. User can choose the reporting mode and related parameters via the PC setup program or the remote sever.

The event trigger report is also configurable. User can turn on or off any event generated report from the PC setup program or via the air command. The event triggered report include (1) In-vehicle Door close/open (2) In-vehicle ignition on/off (3) Temperature range in/out the preset range (4) In-vehicle shock sensor trigger. The external alarm (optional) trigger reports are also configurable and can be set from PC setup program or air command.

The server can not only configure the device just like the PC setup program does, but it also can send the command to control the device. The server can control both the device and the external alarm.

1.3 Geofence function

The device has built-in 10 Geofence sets (4 circular, 5 rectangular shapes and one immediate geofence)it will send the report to the server if the Geofence event is triggered. User can setup the Geofence area from the PC setup program or sending the define.

★ A unique immediate Geofence function:

'Immediate-Geofence function' is a circular type Geofence which can be activated or deactivated from a single button. When activated, the system will record the current position and use the pre-defined radius as a circular Geofence to guard the vehicle. If the vehicle moves out of the preset Geofence zone, a report will be generated to the server. User can deactivate the self-Geofence at any time by pressing the button again. If the GPS cannot be located when the Immediate Geofence function is been executed, GT-8000/GT8500 will use the last known position as the origin of the circular Geofence zone to perform the protection.

★ US patten for immediate Geofence function is pending.

1.4 Store and forward ability

When there is no GPRS service or the server close, the unit will send short message to the server if SMS numbers is defined. All the stored report will be forward to the server when GPRS connection is completed next time.

1.5 TCP and UDP socket support

GT-8000/GT8500 supports both UDP and TCP socket communication. The server IP, port number and socket type can be selected from the PC-setup program or remote server command. In addition, the connection can be swap over to any server IP or port (either UDP or TCP) via the air command.

1.6 Valet switch operation

User can use the supplied Valet switch to perform 5 essential tasks, including (1) sending help/ SOS report (2) activate or deactivate Immediate Geofence (3) Activate panic mode and send 'panic' report (4) sending 'Duty on' or 'Duty off' report to the server and (5) Emergency release to exit 'ARM', 'Anti-carjacking' or 'Panic' modes.

1.7 History report

Flash memory for recording reports up to 900 reports. It can be read out from the PC setup program via serial port.

1.8 Backup battery

The system has a built-in rechargeable battery (4.8V 80mA/H) for emergency use. The system will send a power cut report when all the external power are disconnected. A 12V 1.2A/H backup battery is suggested to be used in order to maintain maximum performance.

1.9 LED indication

Three LED indicate the status of the POWER, GPRS signal and GPS signal. The LED on the valet switch can also indicate the status of the button operation, e.g. sending help report, panic report, ...

II. BASIC FUNCTIONS

FUNCTIONS	APPLICATIONS
GPS	GPS receiver will output a complete position, velocity, and time (PVT) solution in the NMEA Version 3.0 protocol
GPRS, SMS	GPRS use standard TCP or UDP communicate protocol. If the GPRS service is failed, the SMS mode will be turned on for emergency use.
5 input	In-vehicle Door. In-vehicle ACC Temperature sensor port Shock/ultrasonic sensor port Valet Switch
7 output	1. Parking light 2. Door Lock 3. Door Unlock 4. ARM 5. Horn 6. Trunk Release 7. Valet Switch LED
Valet Switch	1. Help /SOS report sending 2. Immediate Geofence activate/deactivate 3. Panic mode + report activate/deactivate 4. Duty on/off report 5. Emergency release

FUNCTIONS	APPLICATIONS
PC-setup	<p>Initialize the unit and program the device, including Network APN, server IP address, user message, report control, and Geogence setting, etc ...</p> <p>Note that Network APN and server IP details must be set before the installation.</p>
External ALARM (Optional)	<p>If a PORTMAN external alarm is installed, the system will gather all the alarm information for the remote monitoring. The server also has the ability to control the external alarm.</p>
Standard Report	<p>Automatic report for AVL tracking purpose:</p> <ul style="list-style-type: none"> Fixed time report Fixed distance report Intelligent report (combine time and distance) Self-diagnostic report Keep alive report
Event Report	<ul style="list-style-type: none"> Temperature report Speeding report Low battery report Geofence trigger report ALARM trigger report, e.g. PANIC mode, ARM, ACC inputs, etc ...
History data store	<p>900 report can be saved in unit, and read from server and pc-setup</p>

III. PANEL INSTALLATION AND WIRING DIAGRAM

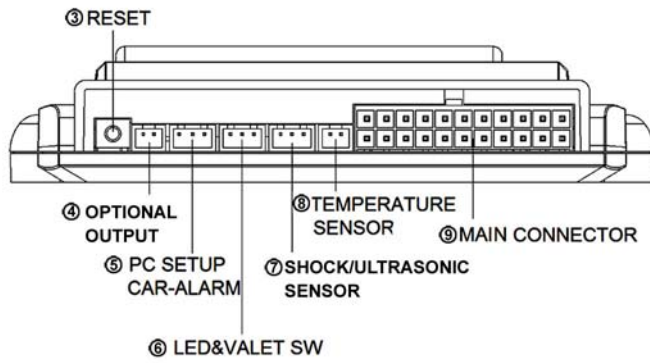
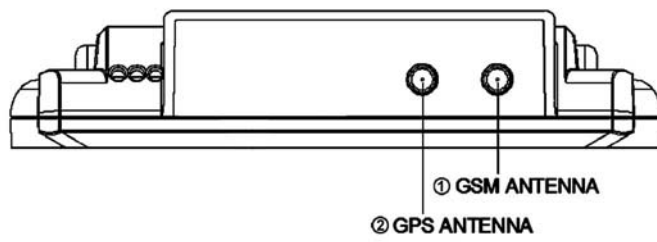

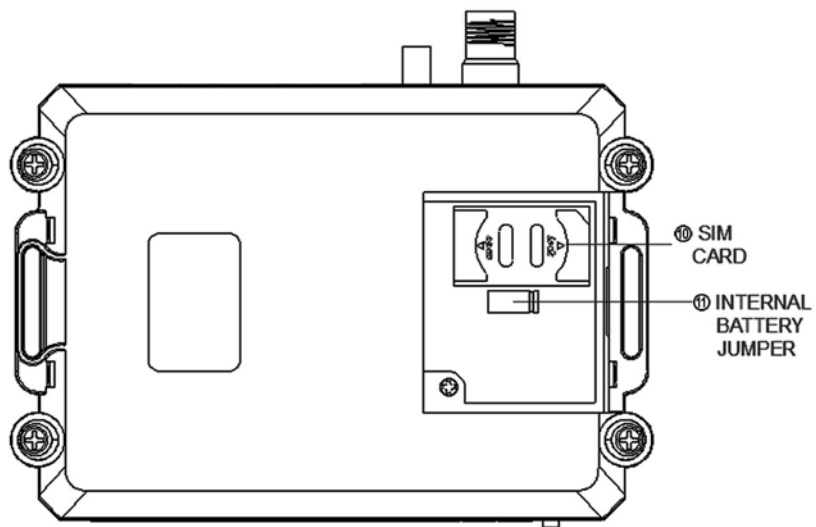

- (1) GSM antenna port: female TNC
- (2) GPS antenna port: female SMA
- (3) Reset Button
- (4) Optional output
- (5) PC setup / External alarm port: white 3-pin connector.
- (6) LED + Valet switch port: red 3-pin connector.
- (7) Shock sensor or Ultrasonic sensor port: red 3-pin connector.
- (8) Temperature sensor port: white 2-pin connector.
- (9) In-vehicle I/O and power port: for in-vehicle I/O, external battery, solar panel and power.
- (10) SIM card holder
- (11) Internal battery switch jumper: opened by default, and shorted to use this battery.

IV. VALET SWITCH/LED OPERATION

User can use the supplied Valet switch to perform 5 essential tasks.

(1) Sending help/ SOS report

Press the button less than one second and then release. The LED will flash once and a 'help/SOS report will be generated.

(2) Activate/Deactivate Immediate Geofence

Press the button and release it when the LED flashes once. After releasing it, the LED will stay continuously on to indicate the 'Immediate Geofence' is on. To deactivate: Press the button (the LED will be temporarily off), and release it when the LED flashes once. After releasing it, the LED will then stay continuously off. A report will be sent out if the vehicle goes out/in to the Geofence zone.

(3) Activate/Deactivate panic mode and send 'panic' report

Press the button (the LED will be temporarily stay off) and release it when the LED flashes twice. After releasing it, the LED will flashes twice to indicate that the panic mode is been triggered and the panic report is sent out. In panic mode, the siren will sound and the parking light will flash. To exit panic mode: press the button (the LED will be temporarily stay off), and release it when the LED flashes twice. After releasing it, the siren and parking light will stop.

(4) 'Duty on' or 'Duty off' reports / 'Status on' Status off' reports

Press the button (the LED will be temporarily stay off) and release it when he LED flashes 3 times. After releasing it, a 'Duty on' report will be sent out, and the LED will be in the cycle for flashing 3 times and then stop for one second. To deactivate: Press the button (the LED will be temporarily stay off) and release it when the LED flashes 3 times. After releasing it, a 'Duty off' report will be sent out, and the LED will stop flashing.

(5) Emergency release to exit 'ARM', 'Anti-carjacking' or 'Panic' modes.
Press the button (the LED will be temporarily stay off) and release it when the LED flashes 5 times. After releasing it, 'ARM', 'parking light', and 'siren' outputs will back to normal (Disarm) status.

V. STATUS INDICATOR

System LED:

RED: Power indicator. When the unit power on, the led will light all the time.

YELLOW: GSM/GPRS indicator. Yellow LED will flash when the device is connected to the server with valid GPRS connection. It will stay continuously on when it is in GSM mode. It will stay off if there is no GSM reception.

GREEN: GPS indicator. This LED will be continuously on when the unit received a valid GPS data.

Note that the Yellow and Green LEDs indication will not be valid until the system goes to the working mode, normally 30 seconds after power on.

Valet Switch LED:

Immediate-Geofence on: Valet Switch LED will on continuously.

Duty on: the LED will be in the cycle for flashing 3 times and then off for one second.

Immediate-Geofence and Duty both on: the LED will be in the cycle for flashing 3 times and then on for one second.

VI. PC SETUP AND SYSTEM INITIATION

PC setup Procedure:

(1) Connect the 3PIN to RS232 PORTMAN PC-setup cable into the #5 port, and then connect it into a serial port.

- (2) Open the PC setup program.
- (3) Select the correct COM port for communication.
- (4) Power on the device or press the reset button for at least 1 second.
- (5) Click 'OK' to start the program

Note that, if the connection fails, please check the cable connection is secured correctly. Press the reset button for a longer time, e.g. another 2 seconds.

A. LOGIN dialog window

Select the correct COM port number, then "reset" the unit by pressing the reset button. And next click "OK".

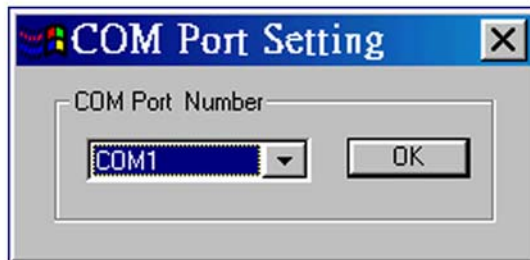

Note that: it is necessary to power on and reset the PORTMAN device soon after click the 'OK' button.

PC setup program will detect the hardware for 60 seconds. If no hardware is detected, it will exit. During the opening up screen shown as below, user can press "Esc" key to terminate the program.

B. Version No. Checking

The below interface will last until correct UNIT Version No. is checked.

(You should run this program before turn on power of UNIT)

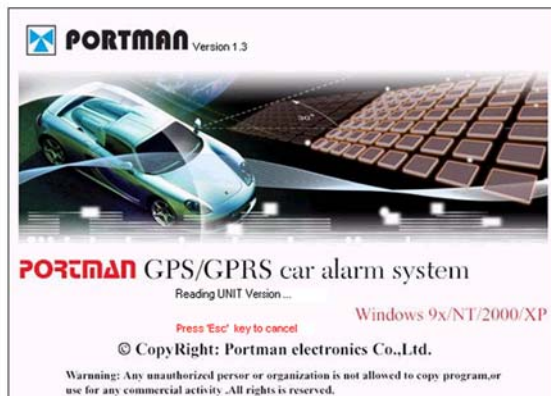

C. MAIN INTERFACE

1.[User detail]:

PORTMAN GT-8000

User Detail | Geofence | Report | Alarm Setup

Version: 1.7 Device ID:

SIM PIN: Device Password:

OPRS login information: Server information:

APN: TCP P Address: 192.168.192.168 Port: 99999

User Name: UDP P Address: Port:

Password:

SMS

Primary SMS number:

Secondary SMS number1:

Secondary SMS number1:

Secondary SMS number1:

Export History Record

To Text To Excel

Initialize Request All Request Apply Apply All Load... Save... Exit

Device ID:
Device Password:

Set UNIT ID and UNIT password of for the device.

GPRS login information:

APN:
User Name:
Password:

Set Access Point Name (APN), User Name, Password and Dialup Number for the GPRS connection. The maximum length of the APN, User name and Password is 49 characters.

Server information:

TCP IP Address: Port:
 UDP IP Address: Port:

TCP/UDP address and Port number of the remote server being set, UNIT will send reports to this address.

Note that only one TCP or UDP server will be used at the same time.

Set the SMS Number of the server. The unit will send reports to the server if GPRS connection is failed.

UNIT can save up to 900 most recent reports. Click 'Export' button to export those stored reports to Text or Excel file.

Note that Device ID , GPRS Login and server IP/Port information need to be input correctly in order to make the connection. If the report sending using GPRS connection fails, the report will be sent to the 'primary' SMS number first. The report will be resent, when the GPRS connection becomes available.

Initialize All Data: clear all settings in UNIT.

Exit PC-Setup: exit PC-Setup to main program.

Request All: read out the whole existing setting from GT-8000/GT8500.

Request: read out the setting in the current page.

Load: load the saved configuration files.

Apply: transfer the setting to GT-8000/GT8500 in the current pages.

Apply All: transfer the whole setting to GT-8000/GT8500.

2.[Geofence]:

The screenshot shows the 'Geofence' configuration window for the PORTMAN GT-8000. The window has a title bar with 'PORTMAN GT-8000' and standard window controls. Below the title bar are four tabs: 'User Detail', 'Geofence', 'Report', and 'Alarm Setup'. The 'Geofence' tab is active.

The main area is divided into two sections:

- Circular Type:** This section has a title 'Circular Type' and an 'Origin Format' field with the example 'N2446.5321E12120.4231'. It contains a table with 4 rows, each with a checkbox, a 'No.' field, an 'Origin' text input, and a 'Radius' field with a 'Km' dropdown menu. Below the table is a 'Self geofence:' label and a '1' in a text input field.
- Round Type:** This section has a title 'Round Type' and a 'Point Format' field with the example 'N2446.5321E12120.4231'. It contains a table with 5 rows, each with a checkbox, a 'No.' field, an 'Upright' text input, and a 'Downleft point' text input.

At the bottom of the window is a toolbar with buttons: 'Initialize', 'Request All', 'Request', 'Apply', 'Apply All', 'Load...', 'Save...', and 'Exit'.

4 circular and 5 rectangle Geofence zones can be set. When UNIT is out of these predefined zones, a report will be generated. Please refer to section IV, (2) to perform the self geofence function. When self geofence is activated, it will record the current position as the origin and use the predefined distance for the radius to enable a circular geofence zone.

Origin\Upright point\Downright point has the format: N2446.5321E12120.4231
 (21 fixed digits)
 Radius has the format:
 User can input the circular radius from 0.1 to 1000 (in km).

3.[Report]:

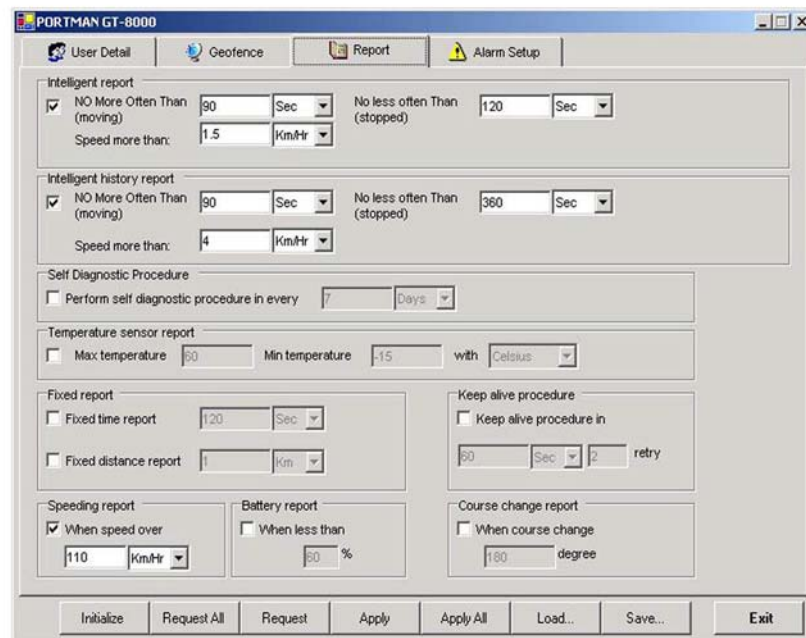

Automatic report can be configured in this section. To activate the function(s), please select "√" in checkbox and fill in data in the textbox.

The reports will be summarized as

- (1) Intelligent report

Parameters: On/Off, Report time when moving, Report time when stop, and threshold speed (recommand threshold speed: 5 km/h).

(2) Intelligent history report (record the report in the system's flash ram)

Parameters: On/Off, Report time when moving, Report time when stop, and threshold speed (recommand threshold speed: 5 km/h).

(3) Fixed time report

Parameters: On/Off, and time.

(4) Fixed distance report

Parameters: On/Off, and distance. (min. distance is 0.1 km, max. distance is 100 km).

(5) Keep alive procedure (in order keep connection in GPRS network, the unit can be set to send short keep alive report to the server in order to prevent the disconnection from the mobile service provider)

Parameters: On/Off, and time.

(6) Self-diagnostic report (for a contain period of time, the UNIT can send a report to the server in order to check the functionality)

Parameters: On/Off, and time.

(7) Course change report (to send a report when the course change is bigger than the value set here)

Parameters: On/Off, and course change in degree.

(8) Temperature report

Parameters: On/Off, and min. and max. temperature.

(8) Low battery warning report (to alert user when the external battery level is low)

Parameters: On/Off, and warning battery level for report. For example, 30 to represent 30% lower level report.

The system will ignore the parameter with a value '0' to prevent continuous non-stop reporting.

4.[Alarm REPORT setup]

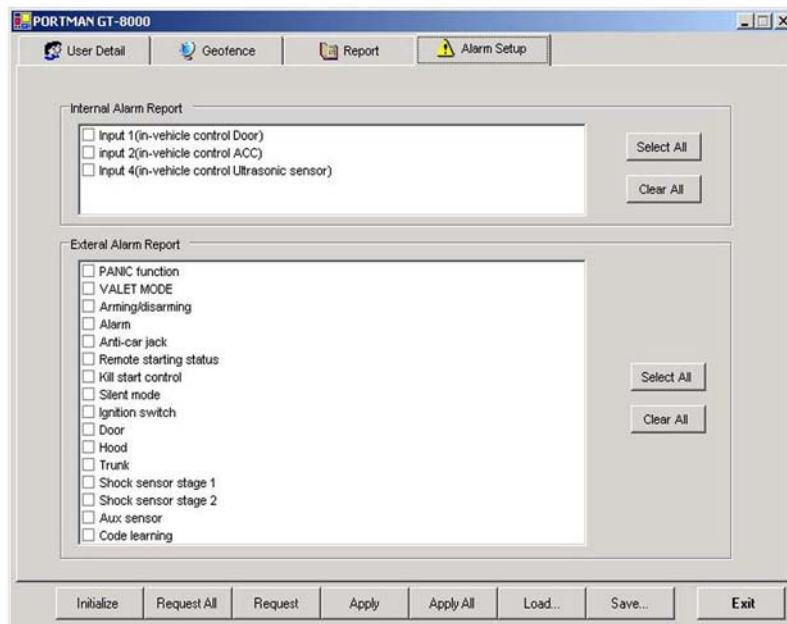

Alarm report(s) is also configurable. User can customize the events generated by the in-vehicle input or external car alarm to be sent to the server. If the item(s) be checked, the related reports will be sent. Otherwise the report will be ignored even when an event is occurred internally.

APPENDIX 1
GT8000/GT8500 SPECIFICATIONS

Physical Parameters

Enclosure dimensions	138(L)*95(W)*29(H)
Weight	200g

Electrical

DC Supply voltage	12V
DC Tolerance voltage	10V – 40V
Current (GPRS online)	50mA
Current (GPRS transmission)	80mA
Current (Peak)	120mA

Backup Battery

	Internal for emergency report	External(optional)
Battery type	Ni-Mh 4.8V	Lead acid 12V
Battery capacity	80 mA/H	1.2 A/H
Charge type	Built-in charge circuit, with jumper protection	Built-in charge circuit

GPRS*

* Data provided by Sony Ericsson

Frequency Range (MHz)	900&1800 and 850&1900 models
Channel spacing (Hz)	200
GPRS connectivity	GPRS multi-slot class 8 GPRS mobile station class B
SIM card interface	3V/5V
SMS storage Capacity	40 in ME
Antenna Connector	Male TNC
Antenna Impedance	50ohms

GPS*

* Data provided by Trimble

Protocol	NMEA0183
Baud Rate	9600
Signal	1575MHz
Accuracy Horizontal	<6 meters (50%), <9 meters (90%)
Altitude	<11 meters (50%), <18 meters (90%)

Velocity	0.06 m/sec.
Hot Start:	<14 sec. (50%), <18 sec. (90%)
Warm Start:	<38 sec. (50%), <45 sec. (90%)
Cold Start:	<90 sec. (50%), <170 sec. (90%)
Antenna Type	Active 3.3V
Antenna Connector	Male SMA

IO Connection

1*two pin connector	Temperature sensor
1*two pin connector	Optional channel output
1*three pin connector	Shock sensor / Ultrasonic sensor
1* three pin connector	PC setup/External alarm port
1* Valet Switch with LED	Set self geofence zone panic report, Send help report
1* 24pin IO connector	Backup battery, solar panel port, Power in and I/O pins
1*button	RESET

Communication

	GPRS \SMS\RS232\RF(with external alarm)
--	---

Environmental

Operating Temperature	-40°C to +80°C
Storage Temperature	-40°C to +85°C

Optional Accessories

1. External Backup Battery

Battery type	Ni-Mh 12V
Battery capacity	3 A/H
Charge type	Built-in charge circuit

2. Solar Panel

Solar Panel Type	MONOCRYSTALLINE SILICON
Power	2.5W max.
Voltage*	12.5V @ max point 15.1V @ open Circuit
Current*	0.2A @ max point 0.22A @ short Circuit

Measured at AM1.5, 100W/m2 sun radiation and 25°C Temperature

3. Combined Antenna (with GPRS and active GPS) 900/1800 and 850/1900 MHz two types
4. GPRS Antenna 900/1800 and 850/1900 MHz two types
5. GPS Active Antenna
6. Temperature sensor
7. Shock sensor
8. Ultrasonic sensor
9. PORTMAN PC setup cable
10. External PORTMAN AM680G alarm

VII. Federal Communications Commission (FCC) Statement

7.1

You are cautioned that changes or modifications not expressly approved by the part responsible for compliance could void the user's authority to operate the equipment.

7.2

This equipment has been tested and found to comply with the limits for a Class B digital device, pursuant to part 15 of the FCC rules. These limits are designed to provide reasonable protection against harmful interference in a residential installation. This equipment generates, uses and can radiate radio frequency energy and, if not installed and used in accordance with the instructions, may cause harmful interference to radio communications. However, there is no guarantee that interference will not occur in a particular installation. If this equipment does cause harmful interference to radio or television reception, which can be determined by turning the equipment off and on, the user is encouraged to try to correct the interference by one or more of the following measures:

- Reorient or relocate the receiving antenna.
- Increase the separation between the equipment and receiver.
- Connect the equipment into an outlet on a circuit different from that to which the receiver is connected.
- Consult the dealer or an experienced radio/TV technician for help.

VIII. Operation is subject to the following two conditions:

- (1) this device may not cause interference and
- (2) this device must accept any interference, including interference that may cause undesired operation of the device.

IX. FCC RF Radiation Exposure Statement:

(1) This Transmitter must not be co-located or operating in conjunction with any other antenna or transmitter.

(2) This equipment complies with FCC RF radiation exposure limits set forth for an uncontrolled environment. This equipment should be installed and operated with a minimum distance of 20 centimeters between the radiator and your body.