

ELECTROMAGNETIC EMISSIONS COMPLIANCE REPORT**INTENTIONAL RADIATOR CERTIFICATION TO
FCC PART 22 SUBPART H and PART 24 SUBPART E**

OF

Product Name: Basic Function tracking system

Brand Name: N/A

Model Name: GT3200ST、GT3010ST、GT3200ST-KP、GT3200ST-100

FCC ID: TBQGT-3200ST

Model Difference: Please see page 6

Report No: ER/2008/50011

Issue Date: May. 21, 2008

FCC Rule Part: 2, 22H & 24E

Prepared for: Portman Electronics (shenzhen) CO.,LTD
9th Building, Tong Fuyu Industrial Park, Longhua,
Baoan, Shenzhen 518109, China

Prepared by: SGS Taiwan Ltd.
Electronics & Communication Laboratory
No. 134, Wu Kung Rd., Wuku Industrial Zone,
Taipei County, Taiwan.

Note: This report shall not be reproduced except in full, without the written approval of SGS Taiwan Ltd. This document may be altered or revised by SGS Taiwan Ltd. personnel only, and shall be noted in the revision section of the document.

Unless otherwise stated the results shown in this test report refer only to the sample(s) tested. This test report cannot be reproduced, except in full, without prior written permission of the Company. 除非另有明，此報告結果僅對測試之樣品負責。本報告未經本公司書面許可，可部份複製。
This Test Report is issued by the Company under its General Conditions of Service which is available on request or accessible at http://www.sgs.com/terms_and_conditions.htm. Attention is drawn to the limitation of liability, indemnification and jurisdiction issues defined therein. Any holder of this Test Report is advised that information contained hereon reflects the Company's findings at the time of its intervention only and within the limits of Client's instructions, if any. The Company's sole responsibility is to its Client and this document does not exonerate parties to a transaction from exercising all their rights and obligations under the transaction documents. Any unauthorized alteration, forgery or falsification of the content or appearance of this document is unlawful and offenders may be prosecuted to the fullest extent of the law.

VERIFICATION OF COMPLIANCE

Applicant: Portman Electronics (shenzhen) CO.,LTD
9th Building, Tong Fuyu Industrial Park, Longhua, Baoan, Shenzhen
518109, China

Product Name: Basic Function tracking system

FCC ID Number: TBQGT-3200ST

Brand Name: N/A

Model No: GT3200ST、GT3010ST、GT3200ST-KP、GT3200ST-100

Model Difference: Please see page 6

File Number: ER/2008/50011

Date of test: May. 08, 2008 ~ May. 21, 2008

Date of EUT Received: May. 07, 2008

We hereby certify that:

The above equipment was tested by SGS Taiwan Ltd. The test data, data evaluation, test procedures, and equipment configurations shown in this report were made in accordance with the procedures given in TIA/EIA-603-B-2002 and the energy emitted by the sample EUT tested as described in this report is in compliance with conducted and radiated emission limits of FCC Rule FCC PART 22 subpart H and FCC PART 24 subpart E.

The test results of this report relate only to the limits of the tested sample identified in this report.

Test By:		Date	May. 26, 2008
	_____ <i>Sky Wang / Asst. Supervisor</i>		
Prepared By:		Date	May. 26, 2008
	_____ <i>Alex Hsieh / Sr. Engineer</i>		
Approved By:		Date	May. 26, 2008
	_____ <i>Vincent Su/Manager</i>		

Unless otherwise stated the results shown in this test report refer only to the sample(s) tested. This test report cannot be reproduced, except in full, without prior written permission of the Company. 除非另有明，此報告結果僅對測試之樣品負責。本報告未經本公司書面許可，可部份複製。
This Test Report is issued by the Company under its General Conditions of Service which is available on request or accessible at http://www.sgs.com/terms_and_conditions.htm. Attention is drawn to the limitation of liability, indemnification and jurisdiction issues defined therein. Any holder of this Test Report is advised that information contained hereon reflects the Company's findings at the time of its intervention only and within the limits of Client's instructions, if any. The Company's sole responsibility is to its Client and this document does not exonerate parties to a transaction from exercising all their rights and obligations under the transaction documents. Any unauthorized alteration, forgery or falsification of the content or appearance of this document is unlawful and offenders may be prosecuted to the fullest extent of the law.

Version

Version No.	Date
00	May. 26, 2008

Unless otherwise stated the results shown in this test report refer only to the sample(s) tested. This test report cannot be reproduced, except in full, without prior written permission of the Company. 除非另有明，此報告結果僅對測試之樣品負責。本報告未經本公司書面許可，可部份複製。

This Test Report is issued by the Company under its General Conditions of Service which is available on request or accessible at http://www.sgs.com/terms_and_conditions.htm. Attention is drawn to the limitation of liability, indemnification and jurisdiction issues defined therein. Any holder of this Test Report is advised that information contained hereon reflects the Company's findings at the time of its intervention only and within the limits of Client's instructions, if any. The Company's sole responsibility is to its Client and this document does not exonerate parties to a transaction from exercising all their rights and obligations under the transaction documents. Any unauthorized alteration, forgery or falsification of the content or appearance of this document is unlawful and offenders may be prosecuted to the fullest extent of the law.

Table of Contents

1.		
1. GENERAL INFORMATION		6
1.1. Related Submittal(s) / Grant (s)		7
1.2. Test Methodology		7
1.3. Test Facility		7
1.4. Special Accessories		7
1.5. Equipment Modifications		7
2. SYSTEM TEST CONFIGURATION		8
2.1. EUT Configuration		8
2.2. EUT Exercise		8
2.3. Test Procedure		8
2.4. Configuration of Tested System		9
3. SUMMARY OF TEST RESULTS		10
4. DESCRIPTION OF TEST MODES		10
5. RF POWER OUTPUT MEASUREMENT		11
5.1. Standard Applicable		11
5.2. Test Set-up:		11
5.3. Measurement Procedure		11
5.4. Measurement Equipment Used:		12
5.5. Measurement Result		13
6. ERP, EIRP MEASUREMENT		14
6.1. Standard Applicable		14
6.2. Test SET-UP (Block Diagram of Configuration)		14
6.3. Measurement Procedure		16
6.4. Measurement Equipment Used:		17
6.5. Measurement Result		18
6.6. Measurement Result		18
7. 99% OCCUPIED BANDWIDTH MEASUREMENT		19
7.1. Standard Applicable		19
7.2. Test Set-up:		19
7.3. Measurement Procedure		19
7.4. Measurement Equipment Used:		20
7.5. Measurement Result:		21
8. OUT OF BAND EMISSION AT ANTENNA TERMINALS		25
8.1. Standard Applicable		25

Unless otherwise stated the results shown in this test report refer only to the sample(s) tested. This test report cannot be reproduced, except in full, without prior written permission of the Company. 除非另有明，此報告結果僅對測試之樣品負責。本報告未經本公司書面許可，可部份複製。

This Test Report is issued by the Company under its General Conditions of Service which is available on request or accessible at http://www.sgs.com/terms_and_conditions.htm.

Attention is drawn to the limitation of liability, indemnification and jurisdiction issues defined therein. Any holder of this Test Report is advised that information contained hereon reflects the Company's findings at the time of its intervention only and within the limits of Client's instructions, if any. The Company's sole responsibility is to its Client and this document does not exonerate parties to a transaction from exercising all their rights and obligations under the transaction documents. Any unauthorized alteration, forgery or falsification of the content or appearance of this document is unlawful and offenders may be prosecuted to the fullest extent of the law.

8.2.	Test SET-UP.....	25
8.3.	Measurement Procedure.....	25
8.4.	Measurement Equipment Used:.....	26
8.5.	Measurement Result.....	27
9.	FIELD STRENGTH OF SPURIOUS RADIATION MEASUREMENT	35
9.1.	Standard Applicable	35
9.2.	EUT Setup (Block Diagram of Configuration).....	35
9.3.	Measurement Procedure.....	37
9.4.	Measurement Equipment Used:.....	38
9.5.	Measurement Result.....	38
10.	FREQUENCY STABILITY V.S. TEMPERATURE MEASUREMENT	51
10.1.	Standard Applicable	51
10.2.	Test Set-up:	51
10.3.	Measurement Procedure.....	51
10.4.	Measurement Equipment Used:.....	52
10.5.	Measurement Result.....	53
11.	FREQUENCY STABILITY V.S. VOLTAGE MEASUREMENT	54
11.1.	Standard Applicable	54
11.2.	Test Set-up:	54
11.3.	Measurement Procedure.....	54
11.4.	Measurement Equipment Used:.....	55
11.5.	Measurement Result.....	56
12.	AC POWER LINE CONDUCTED EMISSION TEST	57
12.1.	Standard Applicable	57
12.2.	EUT Setup.....	57
12.3.	Measurement Procedure.....	57
12.4.	Measurement Equipment Used:.....	58
12.5.	Measurement Result : N/A.....	58
	PHOTOGRAPHS OF SET UP	59
	PHOTOGRAPHS OF EUT	61

Unless otherwise stated the results shown in this test report refer only to the sample(s) tested. This test report cannot be reproduced, except in full, without prior written permission of the Company. 除非另有明，此報告結果僅對測試之樣品負責。本報告未經本公司書面許可，可部份複製。

This Test Report is issued by the Company under its General Conditions of Service which is available on request or accessible at http://www.sgs.com/terms_and_conditions.htm.

Attention is drawn to the limitation of liability, indemnification and jurisdiction issues defined therein. Any holder of this Test Report is advised that information contained hereon reflects the Company's findings at the time of its intervention only and within the limits of Client's instructions, if any. The Company's sole responsibility is to its Client and this document does not exonerate parties to a transaction from exercising all their rights and obligations under the transaction documents. Any unauthorized alteration, forgery or falsification of the content or appearance of this document is unlawful and offenders may be prosecuted to the fullest extent of the law. °

1. GENERAL INFORMATION

General:

Product Name:	Basic Function tracking system
Brand Name:	N/A
Model Name:	GT3200ST、GT3010ST、GT3200ST-KP、GT3200ST-100
Model Difference:	see below
Power Supply:	4.8Vdc Li-ion Battery or 12V DC by Car Battery

The list of model different as below:

Modification Id.	Reason for modification
GT3010ST	can not optional handfree and MIC in accordance with GT3200ST
GT3200ST-KP	can optional Infrared keypad/hand free/MIC in accordance with GT3200ST
GT3200ST-100	can optional HS100/hand free/MIC in accordance with GT3200ST

GSM

Frequency Range and Power:	GSM/GPRS 850: 824MHz –849MHz Class 10	33 dBm
	GSM/GPRS 1900: 1850MHz –1910MHz Class 10	30 dBm
Hardware Version:	N/A	
Software Version:	N/A	

This test report applies for GSM/GPRS 850, GSM/GPRS 1900.

Unless otherwise stated the results shown in this test report refer only to the sample(s) tested. This test report cannot be reproduced, except in full, without prior written permission of the Company. 除非另有明，此報告結果僅對測試之樣品負責。本報告未經本公司書面許可，可部份複製。

This Test Report is issued by the Company under its General Conditions of Service which is available on request or accessible at http://www.sgs.com/terms_and_conditions.htm.

Attention is drawn to the limitation of liability, indemnification and jurisdiction issues defined therein. Any holder of this Test Report is advised that information contained hereon reflects the Company's findings at the time of its intervention only and within the limits of Client's instructions, if any. The Company's sole responsibility is to its Client and this document does not exonerate parties to a transaction from exercising all their rights and obligations under the transaction documents. Any unauthorized alteration, forgery or falsification of the content or appearance of this document is unlawful and offenders may be prosecuted to the fullest extent of the law.

1.1. Related Submittal(s) / Grant (s)

This submittal(s) (test report) is intended for FCC ID: **TBQGT-3200ST** filing to comply with Section Part 22 subpart H and Part 24 subpart E of the FCC CFR 47 Rules.

1.2. Test Methodology

Both conducted and radiated testing were performed according to the procedures documented on chapter 13 of ANSI C63.4 (2003) and FCC CFR 47.1046, 2.1047, 2.1049, 2.1051, 2.1053, 2.1055 and 2.1057.

1.3. Test Facility

The measurement facilities used to collect the 3m Radiated Emission and AC power line conducted data are located on the address of SGS Taiwan Ltd. Electronics & Communication Laboratory No. 134, Wu Kung Rd., Wuku Industrial Zone, Taipei Country, Taiwan which are constructed and calibrated to meet the FCC requirements in documents ANSI C63.4: 2003. FCC Registration Number are: 990257 and 236194, Canada Registration Number: 4620A-1

The 10 m Open Area Test Sites located on the address of SGS Taiwan Ltd. Electronics & Communication Laboratory No. 29, Pau-Tou-Tsuo Valley Chia-Pau Tsuen, Linkou Hsiang, Taipei county, which is constructed and calibrated to meet the CISPR 22/EN 55022 requirements. SGS Site No. 1(3 &10 meters) and FCC Registration Number: 94644.

1.4. Special Accessories

Not available for this EUT intended for grant.

1.5. Equipment Modifications

Not available for this EUT intended for grant.

Unless otherwise stated the results shown in this test report refer only to the sample(s) tested. This test report cannot be reproduced, except in full, without prior written permission of the Company. 除非另有明，此報告結果僅對測試之樣品負責。本報告未經本公司書面許可，可部份複製。

This Test Report is issued by the Company under its General Conditions of Service which is available on request or accessible at http://www.sgs.com/terms_and_conditions.htm.

Attention is drawn to the limitation of liability, indemnification and jurisdiction issues defined therein. Any holder of this Test Report is advised that information contained hereon reflects the Company's findings at the time of its intervention only and within the limits of Client's instructions, if any. The Company's sole responsibility is to its Client and this document does not exonerate parties to a transaction from exercising all their rights and obligations under the transaction documents. Any unauthorized alteration, forgery or falsification of the content or appearance of this document is unlawful and offenders may be prosecuted to the fullest extent of the law.

SYSTEM TEST CONFIGURATION

2.1. EUT Configuration

The EUT configuration for testing is installed on RF field strength measurement to meet the Commissions requirement and operating in a manner which intends to maximize its emission characteristics in a continuous normal application.

2.2. EUT Exercise

The EUT (Transmitter) was operated in the engineering mode to fix the Tx frequency which was for the purpose of the measurements.

2.3. Test Procedure

2.3.1 Conducted Emissions

The EUT is placed on a turn table which is 0.8 m above ground plane. According to the requirements in Section 7 and 13 of ANSI C63.4-2003. Conducted emissions from the EUT measured in the frequency range between 0.15 MHz and 30MHz using CISPR Quasi-Peak and Average detector mode.

2.3.2 Radiated Emissions

The EUT is placed on a turn table which is 0.8 m above ground plane. The turn table shall rotate 360 degrees to determine the position of maximum emission level. EUT is set 3m away from the receiving antenna which varied from 1m to 4m to find out the highest emission. And also, each emission was to be maximized by changing the polarization of receiving antenna both horizontal and vertical. In order to find out the max. emission, the relative positions of this hand-held transmitter(EUT) was rotated through three orthogonal axes and measurement procedures for electric field radiated emissions above 1 GHz the EUT measurement is to be made "while keeping the antenna in the 'cone of radiation' from that area and pointed at the area both in azimuth and elevation, with polarization oriented for maximum response." is still within the 3dB illumination BW of the measurement antenna. according to the requirements in Section 8 and 13 and Subclause 8.3.1.2 of ANSI C63.4-2003.

Unless otherwise stated the results shown in this test report refer only to the sample(s) tested. This test report cannot be reproduced, except in full, without prior written permission of the Company. 除非另有明，此報告結果僅對測試之樣品負責。本報告未經本公司書面許可，可部份複製。

This Test Report is issued by the Company under its General Conditions of Service which is available on request or accessible at http://www.sgs.com/terms_and_conditions.htm.

Attention is drawn to the limitation of liability, indemnification and jurisdiction issues defined therein. Any holder of this Test Report is advised that information contained hereon reflects the Company's findings at the time of its intervention only and within the limits of Client's instructions, if any. The Company's sole responsibility is to its Client and this document does not exonerate parties to a transaction from exercising all their rights and obligations under the transaction documents. Any unauthorized alteration, forgery or falsification of the content or appearance of this document is unlawful and offenders may be prosecuted to the fullest extent of the law.

2.4. Configuration of Tested System

Fig. 2-1 Configuration of Tested System (Fixed Channel)

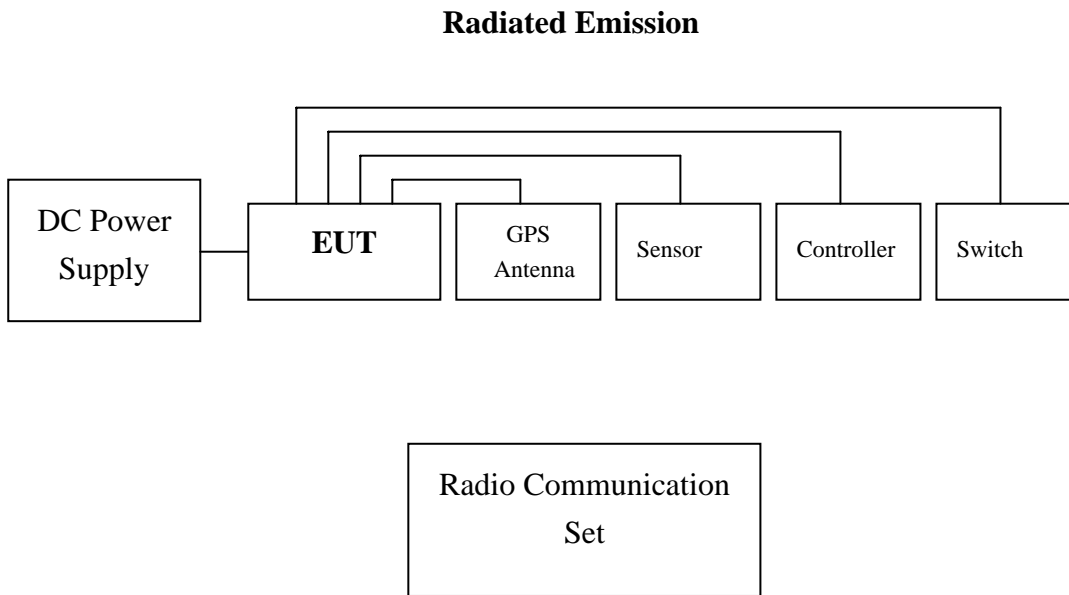

(Remote)

Table 2-2 Support Equipment Used in Tested System

Item	Equipment	Mfr/Brand	Model/Type No.	Series No.	Data Cable	Power Cord
1.	DC Power Supply	Topward	3303A	715856	N/A	Un-shielding
2.	Radio Communication Set	Anritsu	MT8820A	6200307563	N/A	Un-shielding

Note: All the above equipment/cables were placed in worse case positions to maximize emission signals during emission test.

Grounding: Grounding was in accordance with the manufacturer's requirements and conditions for the intended use.

Unless otherwise stated the results shown in this test report refer only to the sample(s) tested. This test report cannot be reproduced, except in full, without prior written permission of the Company. 除非另有明，此報告結果僅對測試之樣品負責。本報告未經本公司書面許可，可部份複製。
 This Test Report is issued by the Company under its General Conditions of Service which is available on request or accessible at http://www.sgs.com/terms_and_conditions.htm. Attention is drawn to the limitation of liability, indemnification and jurisdiction issues defined therein. Any holder of this Test Report is advised that information contained hereon reflects the Company's findings at the time of its intervention only and within the limits of Client's instructions, if any. The Company's sole responsibility is to its Client and this document does not exonerate parties to a transaction from exercising all their rights and obligations under the transaction documents. Any unauthorized alteration, forgery or falsification of the content or appearance of this document is unlawful and offenders may be prosecuted to the fullest extent of the law.

SUMMARY OF TEST RESULTS

FCC Rules	Description Of Test	Result
§2.1046(a) §22.913(a) §24.232(a)	RF Power Output	Compliant
§2.1046(a) §22.913(a) §24.232(a)	ERP/ EIRP measurement	Compliant
§2.1049(h)	99% Occupied Bandwidth	Compliant
§2.1051 §22.917(a) §24.238(a)	Out of Band Emissions at Antenna Terminals and Band Edge	Compliant
§2.1053 §22.917(a) §24.238(a)	Field Strength of Spurious Radiation	Compliant
§2.1055(a)(1)(b)	Frequency Stability vs. Temperature	Compliant
§2.1055(d)(1)(2)	Frequency Stability vs. Voltage	Compliant
§15.107;§15.207	AC Power Line Conducted Emission	Compliant

DESCRIPTION OF TEST MODES

The EUT has been tested under operating condition.

EUT staying in continuous transmitting mode. Channel Low, Mid and High for each type band with rated data rate were chosen for full testing.

The field strength of spurious radiation emission was measured as EUT lie down position (H Mode)

Unless otherwise stated the results shown in this test report refer only to the sample(s) tested. This test report cannot be reproduced, except in full, without prior written permission of the Company. 除非另有明，此報告結果僅對測試之樣品負責。本報告未經本公司書面許可，可部份複製。
This Test Report is issued by the Company under its General Conditions of Service which is available on request or accessible at http://www.sgs.com/terms_and_conditions.htm. Attention is drawn to the limitation of liability, indemnification and jurisdiction issues defined therein. Any holder of this Test Report is advised that information contained hereon reflects the Company's findings at the time of its intervention only and within the limits of Client's instructions, if any. The Company's sole responsibility is to its Client and this document does not exonerate parties to a transaction from exercising all their rights and obligations under the transaction documents. Any unauthorized alteration, forgery or falsification of the content or appearance of this document is unlawful and offenders may be prosecuted to the fullest extent of the law.

RF POWER OUTPUT MEASUREMENT

5.1. Standard Applicable

According to FCC §2.1046.

FCC 22.913(a) Mobile station are limited to 7W.

FCC 24.232(b) Mobile station are limited to 2W.

5.2. Test Set-up:

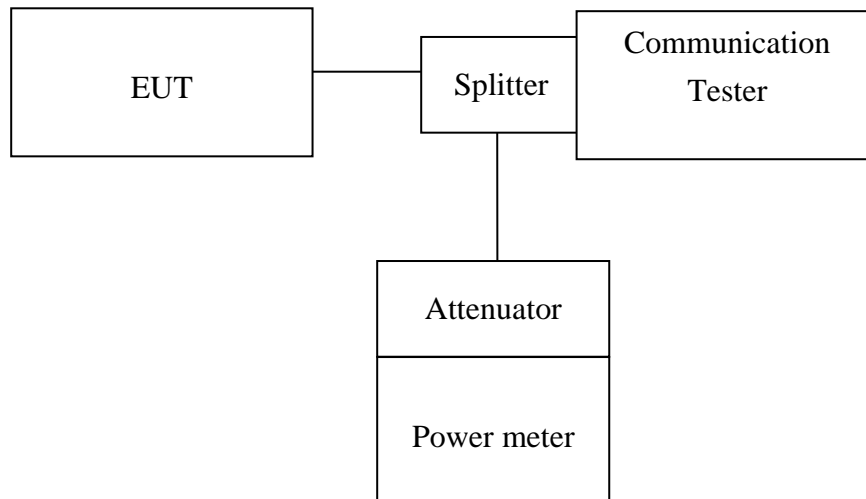

Note: Measurement setup for testing on Antenna connector

5.3. Measurement Procedure

The transmitter output was connected to a calibrated attenuator, the other end of which was connected to a power meter. Transmitter output was read off the power meter in dBm. The power output at the transmitter antenna port was determined by adding the value of the attenuator to the power meter reading.

Unless otherwise stated the results shown in this test report refer only to the sample(s) tested. This test report cannot be reproduced, except in full, without prior written permission of the Company. 除非另有明，此報告結果僅對測試之樣品負責。本報告未經本公司書面許可，可部份複製。

This Test Report is issued by the Company under its General Conditions of Service which is available on request or accessible at http://www.sgs.com/terms_and_conditions.htm. Attention is drawn to the limitation of liability, indemnification and jurisdiction issues defined therein. Any holder of this Test Report is advised that information contained hereon reflects the Company's findings at the time of its intervention only and within the limits of Client's instructions, if any. The Company's sole responsibility is to its Client and this document does not exonerate parties to a transaction from exercising all their rights and obligations under the transaction documents. Any unauthorized alteration, forgery or falsification of the content or appearance of this document is unlawful and offenders may be prosecuted to the fullest extent of the law.

5.4. Measurement Equipment Used:

Conducted Emission Test Site					
EQUIPMENT TYPE	MFR	MODEL NUMBER	SERIAL NUMBER	LAST CAL.	CAL DUE.
Spectrum Analyzer	Agilent	E4446A	MY43360126	04/27/2008	04/27/2009
Spectrum Analyzer	Agilent	E7405A	US41160416	07/04/2007	07/03/2008
Spectrum Analyzer	R&S	FSP 40	100034	01/05/2008	01/04/2009
Communication Test	R&S	SMU200	N/A	N/A	N/A
Power Sensor	Anritsu	MA2490A	31431	07/07/2007	07/06/2008
Power Meter	Anritsu	ML2487A	6K00002070	07/07/2007	07/06/2008
Temperature Chamber	TERCHY	MHG-120LF	911009	04/26/2008	04/25/2009
Low Loss Cable	HUBER+SUHNER	SUCOFLEX 104PEA	N/A	N/A	N/A
Attenuator	Mini-Circuit	BW-S10W5	N/A	07/05/2007	07/04/2008
Attenuator	Mini-Circuit	BW-S6W5	N/A	07/05/2007	07/04/2008
Splitter	Agilent	11636B	51728	07/05/2007	07/04/2008
DC Power Supply	Agilent	6038A	2929A-07548	06/27/2007	06/26/2008

Unless otherwise stated the results shown in this test report refer only to the sample(s) tested. This test report cannot be reproduced, except in full, without prior written permission of the Company. 除非另有明，此報告結果僅對測試之樣品負責。本報告未經本公司書面許可，可部份複製。

This Test Report is issued by the Company under its General Conditions of Service which is available on request or accessible at http://www.sgs.com/terms_and_conditions.htm. Attention is drawn to the limitation of liability, indemnification and jurisdiction issues defined therein. Any holder of this Test Report is advised that information contained hereon reflects the Company's findings at the time of its intervention only and within the limits of Client's instructions, if any. The Company's sole responsibility is to its Client and this document does not exonerate parties to a transaction from exercising all their rights and obligations under the transaction documents. Any unauthorized alteration, forgery or falsification of the content or appearance of this document is unlawful and offenders may be prosecuted to the fullest extent of the law.

5.5. Measurement Result

EUT Mode	Frequency (MHz)	CH	Power meter Reading (dBm)	Path Loss (dB)	Peak Power (dBm)
GSM 850	824.20	128	28.55	0.00	28.55
	836.60	190	28.51	0.00	28.51
	848.80	251	28.10	0.00	28.10

* Offset 17.8dB

EUT Mode	Frequency (MHz)	CH	Power Meter Reading (dBm)	Path Loss (dB)	Peak Power (dBm)
PCS 1900	1850.20	512	29.60	0.00	29.60
	1880.00	661	29.70	0.00	29.70
	1909.80	810	29.60	0.00	29.60

* Offset 17.8dB

Unless otherwise stated the results shown in this test report refer only to the sample(s) tested. This test report cannot be reproduced, except in full, without prior written permission of the Company. 除非另有明，此報告結果僅對測試之樣品負責。本報告未經本公司書面許可，可部份複製。

This Test Report is issued by the Company under its General Conditions of Service which is available on request or accessible at http://www.sgs.com/terms_and_conditions.htm. Attention is drawn to the limitation of liability, indemnification and jurisdiction issues defined therein. Any holder of this Test Report is advised that information contained hereon reflects the Company's findings at the time of its intervention only and within the limits of Client's instructions, if any. The Company's sole responsibility is to its Client and this document does not exonerate parties to a transaction from exercising all their rights and obligations under the transaction documents. Any unauthorized alteration, forgery or falsification of the content or appearance of this document is unlawful and offenders may be prosecuted to the fullest extent of the law.

ERP, EIRP MEASUREMENT

6.1. Standard Applicable

According to FCC §2.1046

FCC 22.913(a) Mobile station are limited to 7W ERP.

FCC 24.232(b) Mobile station are limited to 2W EIRP.

6.2. Test SET-UP (Block Diagram of Configuration)

(A) Radiated Emission Test Set-Up, Frequency Below 1000MHz

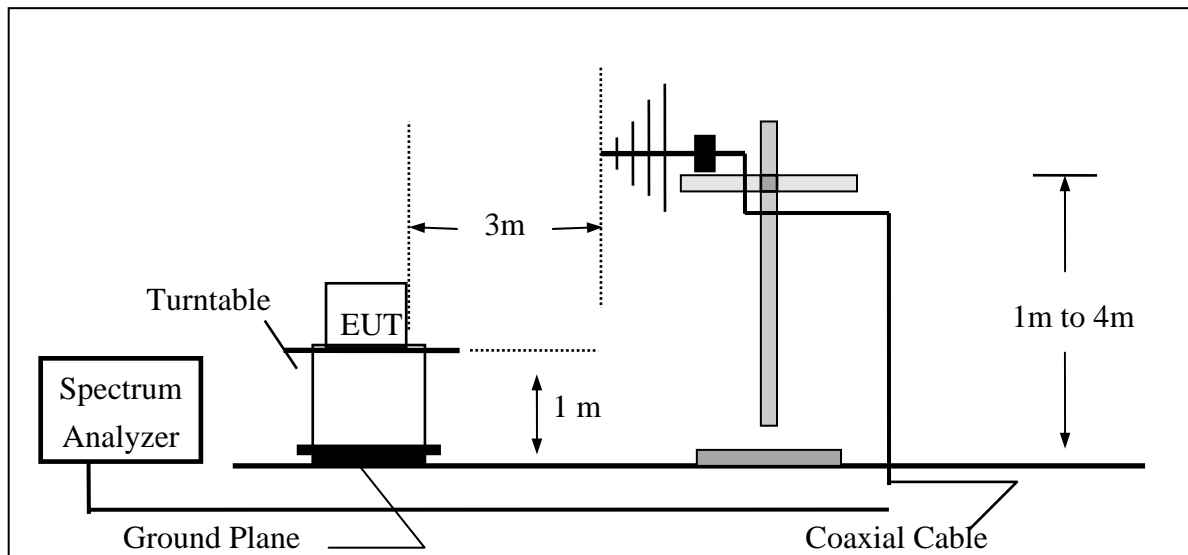

Unless otherwise stated the results shown in this test report refer only to the sample(s) tested. This test report cannot be reproduced, except in full, without prior written permission of the Company. 除非另有明，此報告結果僅對測試之樣品負責。本報告未經本公司書面許可，可部份複製。

This Test Report is issued by the Company under its General Conditions of Service which is available on request or accessible at http://www.sgs.com/terms_and_conditions.htm.

Attention is drawn to the limitation of liability, indemnification and jurisdiction issues defined therein. Any holder of this Test Report is advised that information contained hereon reflects the Company's findings at the time of its intervention only and within the limits of Client's instructions, if any. The Company's sole responsibility is to its Client and this document does not exonerate parties to a transaction from exercising all their rights and obligations under the transaction documents. Any unauthorized alteration, forgery or falsification of the content or appearance of this document is unlawful and offenders may be prosecuted to the fullest extent of the law.

(B) Radiated Emission Test Set-UP Frequency Over 1 GHz

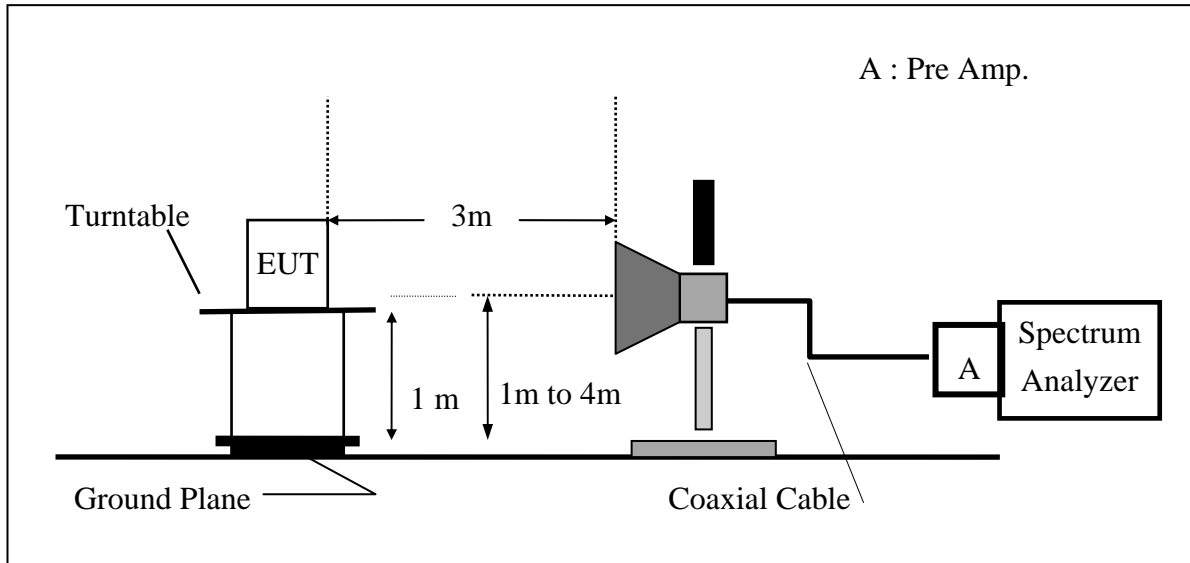

(C) Substituted Method Test Set-UP

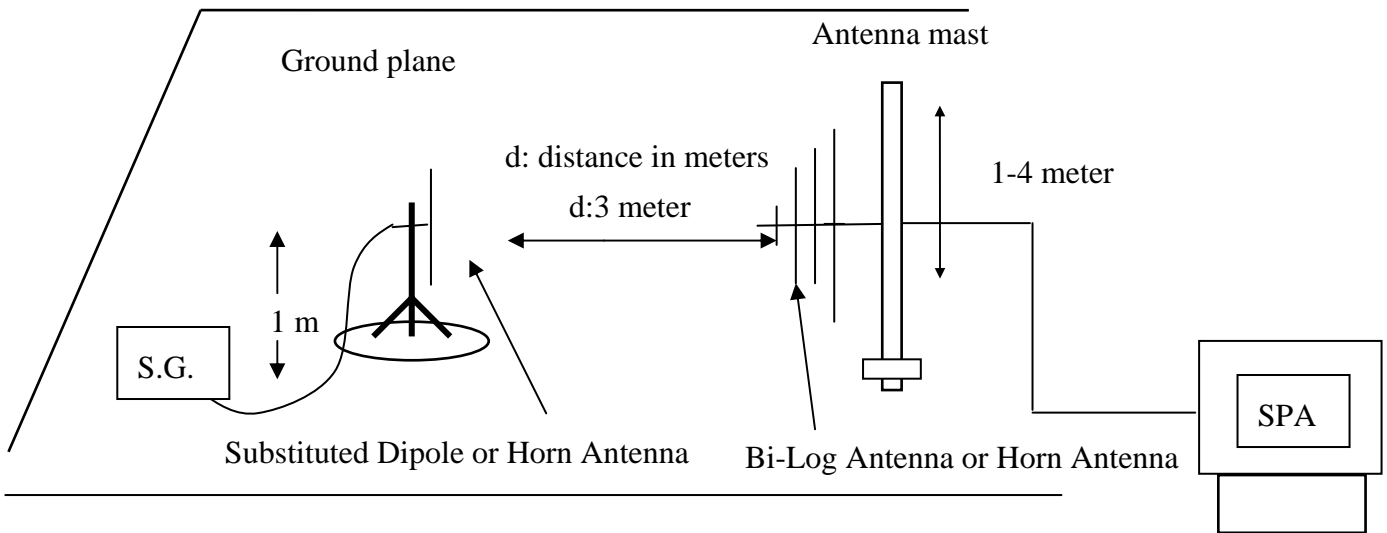

Unless otherwise stated the results shown in this test report refer only to the sample(s) tested. This test report cannot be reproduced, except in full, without prior written permission of the Company. 除非另有明，此報告結果僅對測試之樣品負責。本報告未經本公司書面許可，可部份複製。
 This Test Report is issued by the Company under its General Conditions of Service which is available on request or accessible at http://www.sgs.com/terms_and_conditions.htm. Attention is drawn to the limitation of liability, indemnification and jurisdiction issues defined therein. Any holder of this Test Report is advised that information contained hereon reflects the Company's findings at the time of its intervention only and within the limits of Client's instructions, if any. The Company's sole responsibility is to its Client and this document does not exonerate parties to a transaction from exercising all their rights and obligations under the transaction documents. Any unauthorized alteration, forgery or falsification of the content or appearance of this document is unlawful and offenders may be prosecuted to the fullest extent of the law.

6.3. Measurement Procedure

The EUT was placed on a non-conductive, The measurement antenna was placed at a distance of 3 meters from the EUT. During the tests, the antenna height and the EUT azimuth were varied in order to identify the maximum level of emissions from the EUT. This maximization process was repeated with the EUT positioned in each of its three orthogonal orientations.

During the measurement, the EUT was communication with the station. The highest emission was recorded with the rotation of the turntable and the lowering of the test antenna from 4m to 1m. The reading was recorded and the field strength (E in dBuV/m) was calculated. And Peak detector was used during this test.

ERP in frequency band 824.2 –846.60.8MHz were measured using a substitution method. The EUT was replaced by dipole antenna connected, the S.G. output was recorded and ERP was calculated as follows:

EIRP in frequency band 1850.2 –1907.60MHz were measured using a substitution method. The EUT was replaced by or horn antenna connected, the S.G. output was recorded and EIRP was calculated as follows:

$$\text{ERP} = \text{S.G. output (dBm)} + \text{Antenna Gain (dBd)} - \text{Cable Loss (dB)}$$

$$\text{EIRP} = \text{S.G. output (dBm)} + \text{Antenna Gain (dBi)} - \text{Cable Loss (dB)}$$

Unless otherwise stated the results shown in this test report refer only to the sample(s) tested. This test report cannot be reproduced, except in full, without prior written permission of the Company. 除非另有明，此報告結果僅對測試之樣品負責。本報告未經本公司書面許可，可部份複製。

This Test Report is issued by the Company under its General Conditions of Service which is available on request or accessible at http://www.sgs.com/terms_and_conditions.htm. Attention is drawn to the limitation of liability, indemnification and jurisdiction issues defined therein. Any holder of this Test Report is advised that information contained hereon reflects the Company's findings at the time of its intervention only and within the limits of Client's instructions, if any. The Company's sole responsibility is to its Client and this document does not exonerate parties to a transaction from exercising all their rights and obligations under the transaction documents. Any unauthorized alteration, forgery or falsification of the content or appearance of this document is unlawful and offenders may be prosecuted to the fullest extent of the law. °

6.4. Measurement Equipment Used:

EQUIPMENT TYPE	MFR	MODEL NUMBER	SERIAL NUMBER	LAST CAL.	CAL DUE.
Spectrum Analyzer	Agilent	E4446A	MY43360126	04/27/2008	04/26/2009
Spectrum Analyzer	Agilent	E7405A	US41160416	07/04/2007	07/03/2008
Spectrum Analyzer	R&S	FSP 40	100034	01/05/2008	01/04/2009
Communication Test	R&S	SMU200	N/A	N/A	N/A
Bi-log Antenna	SCHWAZBECK	VULB9160	3224	11/14/2007	11/13/2008
Horn antenna	SCHWAZBECK	BBHA 9120D	309/320	08/16/2007	08/15/2008
Pre-Amplifier	HP	8447D	2944A09469	07/19/2007	07/18/2008
Pre-Amplifier	HP	8494B	3008A00578	02/26/2008	02/25/2009
Signal Generator	R&S	SMR40	100210	02/09/2008	02/10/2009
Turn Table	HD	DT420	N/A	N.C.R	N.C.R
Antenna Tower	HD	MA240-N	240/657	N.C.R	N.C.R
Controller	HD	HD100	N/A	N.C.R	N.C.R
Low Loss Cable	HUBER+SUHNER	SUCOFLEX 104PEA-10M	10m	10/09/2007	10/08/2008
Low Loss Cable	HUBER+SUHNER	SUCOFLEX 104PEA-3M	3m	10/09/2007	10/08/2008
Low Loss Cable	HUBER+SUHNER	SUCOFLEX 104PEA-0.5M	0.5m	10/09/2007	10/08/2008
Site NSA	SGS	966 chamber	N/A	11/17/2007	11/16/2008
Attenuator	Mini-Circuit	BW-S10W5	N/A	09/23/2007	09/22/2008
Dipole Antenna	SCHWAZBECK	VHAP	908/909	06/09/2007	06/10/2008
Dipole Antenna	SCHWAZBECK	UHAP	891/892	06/09/2007	06/10/2008
Horn antenna	SCHWAZBECK	BBHA 9120D	N/A	08/16/2007	08/15/2008

Unless otherwise stated the results shown in this test report refer only to the sample(s) tested. This test report cannot be reproduced, except in full, without prior written permission of the Company. 除非另有明，此報告結果僅對測試之樣品負責。本報告未經本公司書面許可，可部份複製。
 This Test Report is issued by the Company under its General Conditions of Service which is available on request or accessible at http://www.sgs.com/terms_and_conditions.htm. Attention is drawn to the limitation of liability, indemnification and jurisdiction issues defined therein. Any holder of this Test Report is advised that information contained hereon reflects the Company's findings at the time of its intervention only and within the limits of Client's instructions, if any. The Company's sole responsibility is to its Client and this document does not exonerate parties to a transaction from exercising all their rights and obligations under the transaction documents. Any unauthorized alteration, forgery or falsification of the content or appearance of this document is unlawful and offenders may be prosecuted to the fullest extent of the law.

6.5. Measurement Result

EUT Mode	Frequency (MHz)	CH	EUT Pol.	Antenna Pol.	SPA Reading (dBuV)	S.G. Output (dBm)	Antenna Gain (dBd)	Cable Loss (dB)	ERP (dBm)	Limit (dBm)
GSM 850	824.20	128	H	V	125.21	37.89	-7.87	3.64	26.37	38.45
				H	127.19	39.53	-7.87	3.64	28.02	38.45
	836.60	190	H	V	126.76	39.73	-7.88	3.70	28.16	38.45
				H	128.43	41.09	-7.88	3.70	29.52	38.45
	848.80	251	H	V	126.85	40.11	-7.88	3.75	28.48	38.45
				H	128.80	41.78	-7.88	3.75	30.15	38.45

Remark :

- (1) The RBW,VBW of SPA for frequency
 Below 1GHz was RBW=100 KHz, VBW=300KHz,
 Above 1GHz was RBW= 1MHz , VBW= 3MHz

6.6. Measurement Result

EUT Mode	Frequency (MHz)	CH	EUT Pol.	Antenna Pol.	SPA Reading (dBuV)	S.G. Output (dBm)	Antenna Gain (dBi)	Cable Loss (dB)	EIRP (dBm)	Limit (dBm)
PCS 1900	1850.20	512	H	V	125.79	18.83	9.90	5.41	23.32	33.00
				H	128.45	21.56	9.90	5.41	26.05	33.00
	1880.00	661	H	V	125.96	19.01	9.99	5.46	23.54	33.00
				H	128.22	21.35	9.99	5.46	25.88	33.00
	1909.80	810	H	V	126.86	19.92	10.08	5.51	24.49	33.00
				H	128.17	21.32	10.08	5.51	25.88	33.00

Remark :

- (1) The RBW,VBW of SPA for frequency
 Below 1GHz was RBW=100 KHz, VBW=300KHz,
 Above 1GHz was RBW= 1MHz , VBW= 3MHz

Unless otherwise stated the results shown in this test report refer only to the sample(s) tested. This test report cannot be reproduced, except in full, without prior written permission of the Company. 除非另有明，此報告結果僅對測試之樣品負責。本報告未經本公司書面許可，可部份複製。
 This Test Report is issued by the Company under its General Conditions of Service which is available on request or accessible at http://www.sgs.com/terms_and_conditions.htm.
 Attention is drawn to the limitation of liability, indemnification and jurisdiction issues defined therein. Any holder of this Test Report is advised that information contained hereon reflects the Company's findings at the time of its intervention only and within the limits of Client's instructions, if any. The Company's sole responsibility is to its Client and this document does not exonerate parties to a transaction from exercising all their rights and obligations under the transaction documents. Any unauthorized alteration, forgery or falsification of the content or appearance of this document is unlawful and offenders may be prosecuted to the fullest extent of the law.

99% OCCUPIED BANDWIDTH MEASUREMENT

7.1. Standard Applicable

According to §FCC 2.1049.

7.2. Test Set-up:

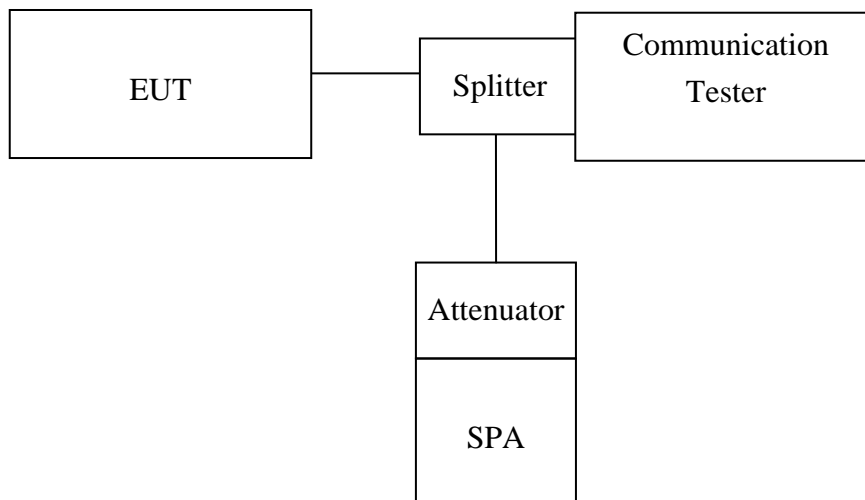

Note: Measurement setup for testing on Antenna connector

7.3. Measurement Procedure

The EUT's output RF connector was connected with a short cable to the spectrum analyzer, RBW (10/30KHz) was set to about 1% of emission BW, VBW= 3 times RBW(30/100KHz), -26dBc display line was placed on the screen (or 99% bandwidth), the occupied bandwidth is the delta frequency between the two points where the display line intersects the signal trace.

Unless otherwise stated the results shown in this test report refer only to the sample(s) tested. This test report cannot be reproduced, except in full, without prior written permission of the Company. 除非另有明，此報告結果僅對測試之樣品負責。本報告未經本公司書面許可，可部份複製。

This Test Report is issued by the Company under its General Conditions of Service which is available on request or accessible at http://www.sgs.com/terms_and_conditions.htm. Attention is drawn to the limitation of liability, indemnification and jurisdiction issues defined therein. Any holder of this Test Report is advised that information contained hereon reflects the Company's findings at the time of its intervention only and within the limits of Client's instructions, if any. The Company's sole responsibility is to its Client and this document does not exonerate parties to a transaction from exercising all their rights and obligations under the transaction documents. Any unauthorized alteration, forgery or falsification of the content or appearance of this document is unlawful and offenders may be prosecuted to the fullest extent of the law.

7.4. Measurement Equipment Used:

Conducted Emission Test Site					
EQUIPMENT TYPE	MFR	MODEL NUMBER	SERIAL NUMBER	LAST CAL.	CAL DUE.
Spectrum Analyzer	Agilent	E4446A	MY43360126	04/27/2008	04/27/2009
Spectrum Analyzer	Agilent	E7405A	US41160416	07/04/2007	07/03/2008
Spectrum Analyzer	R&S	FSP 40	100034	01/05/2008	01/04/2009
Communication Test	R&S	SMU200	N/A	N/A	N/A
Power Sensor	Anritsu	MA2490A	31431	07/07/2007	07/06/2008
Power Meter	Anritsu	ML2487A	6K00002070	07/07/2007	07/06/2008
Temperature Chamber	TERCHY	MHG-120LF	911009	04/26/2008	04/25/2009
Low Loss Cable	HUBER+SUHNER	SUCOFLEX 104PEA	N/A	N/A	N/A
Attenuator	Mini-Circuit	BW-S10W5	N/A	07/05/2007	07/04/2008
Attenuator	Mini-Circuit	BW-S6W5	N/A	07/05/2007	07/04/2008
Splitter	Agilent	11636B	51728	07/05/2007	07/04/2008

Unless otherwise stated the results shown in this test report refer only to the sample(s) tested. This test report cannot be reproduced, except in full, without prior written permission of the Company. 除非另有明，此報告結果僅對測試之樣品負責。本報告未經本公司書面許可，可部份複製。

This Test Report is issued by the Company under its General Conditions of Service which is available on request or accessible at http://www.sgs.com/terms_and_conditions.htm. Attention is drawn to the limitation of liability, indemnification and jurisdiction issues defined therein. Any holder of this Test Report is advised that information contained hereon reflects the Company's findings at the time of its intervention only and within the limits of Client's instructions, if any. The Company's sole responsibility is to its Client and this document does not exonerate parties to a transaction from exercising all their rights and obligations under the transaction documents. Any unauthorized alteration, forgery or falsification of the content or appearance of this document is unlawful and offenders may be prosecuted to the fullest extent of the law.

7.5. Measurement Result:.

EUT Mode	Frequency (MHz)	CH	99% Bandwidth (MHz)
GSM 850	824.20	128	0.2391
	836.60	190	0.2392
	848.80	251	0.2419

EUT Mode	Frequency (MHz)	CH	99% Bandwidth (MHz)
PCS 1900	1850.20	512	0.2432
	1880.00	661	0.2387
	1909.80	810	0.2406

Unless otherwise stated the results shown in this test report refer only to the sample(s) tested. This test report cannot be reproduced, except in full, without prior written permission of the Company. 除非另有明，此報告結果僅對測試之樣品負責。本報告未經本公司書面許可，可部份複製。

This Test Report is issued by the Company under its General Conditions of Service which is available on request or accessible at http://www.sgs.com/terms_and_conditions.htm. Attention is drawn to the limitation of liability, indemnification and jurisdiction issues defined therein. Any holder of this Test Report is advised that information contained hereon reflects the Company's findings at the time of its intervention only and within the limits of Client's instructions, if any. The Company's sole responsibility is to its Client and this document does not exonerate parties to a transaction from exercising all their rights and obligations under the transaction documents. Any unauthorized alteration, forgery or falsification of the content or appearance of this document is unlawful and offenders may be prosecuted to the fullest extent of the law.

Figure 7-1: GSM Channel Low

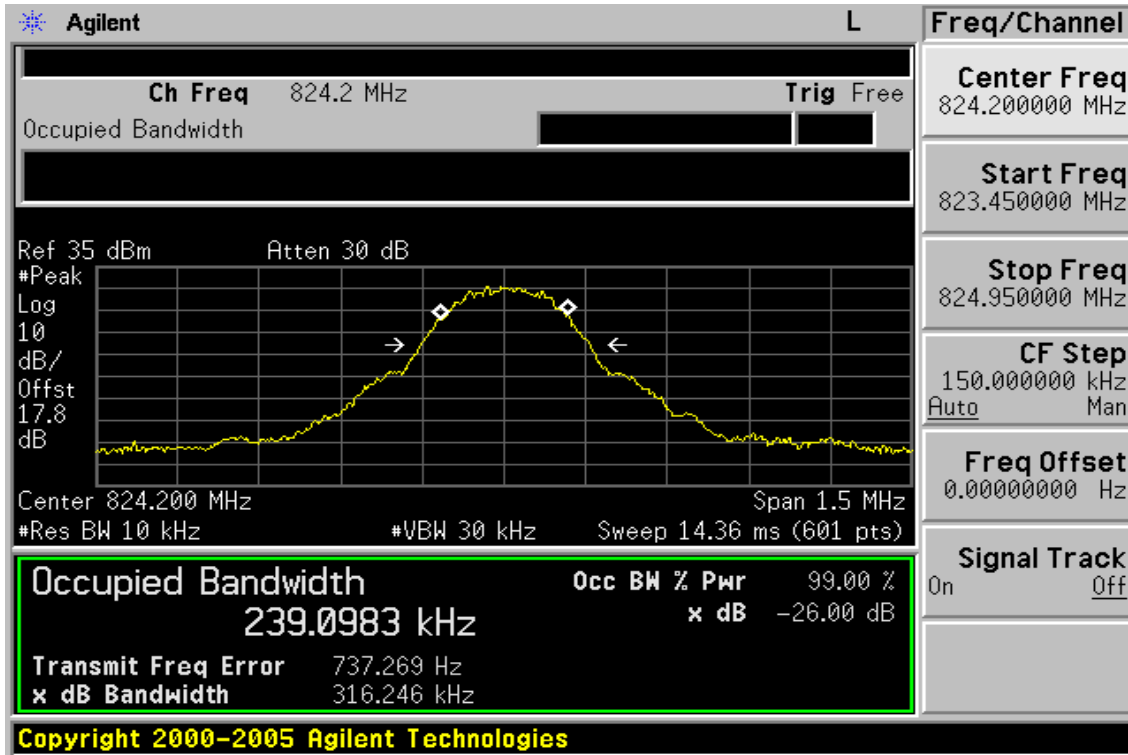
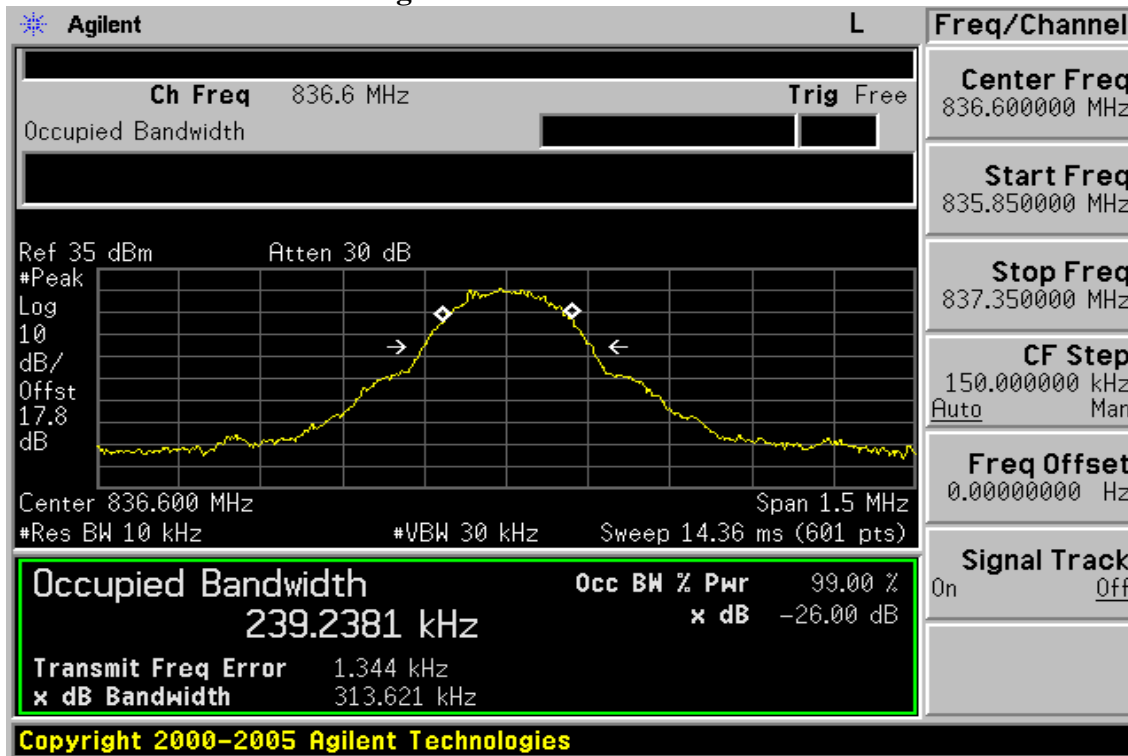

Figure 7-2 GSM Channel Mid



Unless otherwise stated the results shown in this test report refer only to the sample(s) tested. This test report cannot be reproduced, except in full, without prior written permission of the Company. 除非另有明，此報告結果僅對測試之樣品負責。本報告未經本公司書面許可，可部份複製。
 This Test Report is issued by the Company under its General Conditions of Service which is available on request or accessible at http://www.sgs.com/terms_and_conditions.htm. Attention is drawn to the limitation of liability, indemnification and jurisdiction issues defined therein. Any holder of this Test Report is advised that information contained hereon reflects the Company's findings at the time of its intervention only and within the limits of Client's instructions, if any. The Company's sole responsibility is to its Client and this document does not exonerate parties to a transaction from exercising all their rights and obligations under the transaction documents. Any unauthorized alteration, forgery or falsification of the content or appearance of this document is unlawful and offenders may be prosecuted to the fullest extent of the law.

Figure 7-3: GSM Channel High

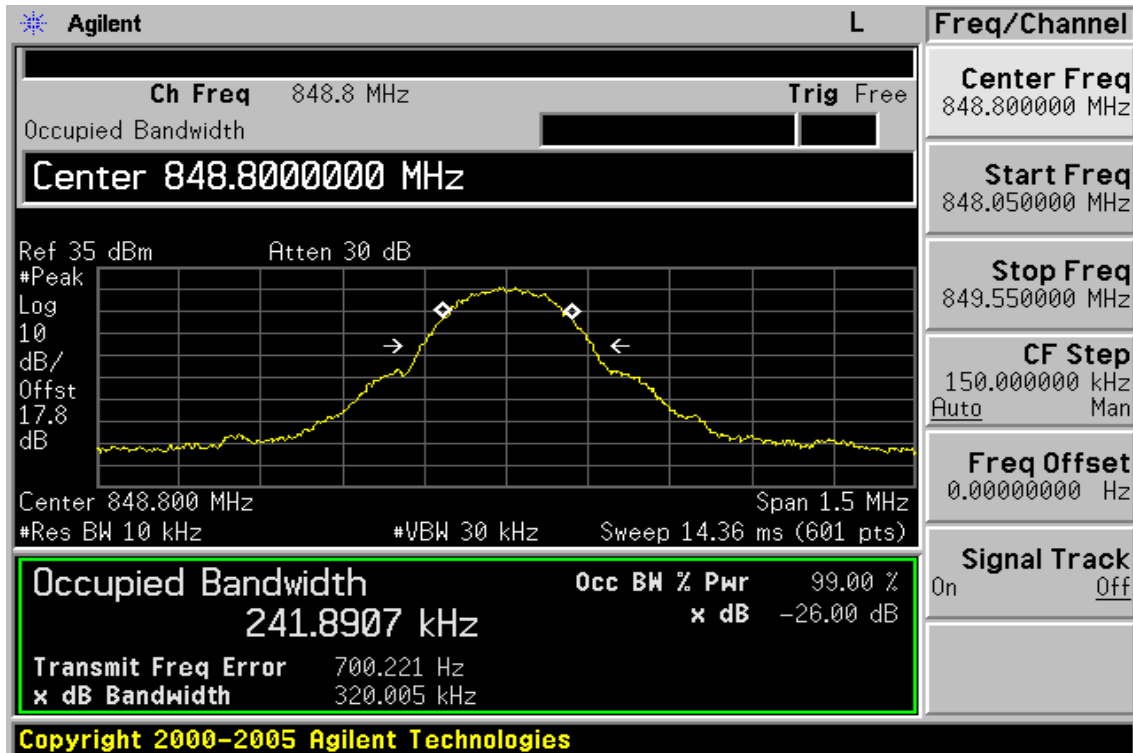
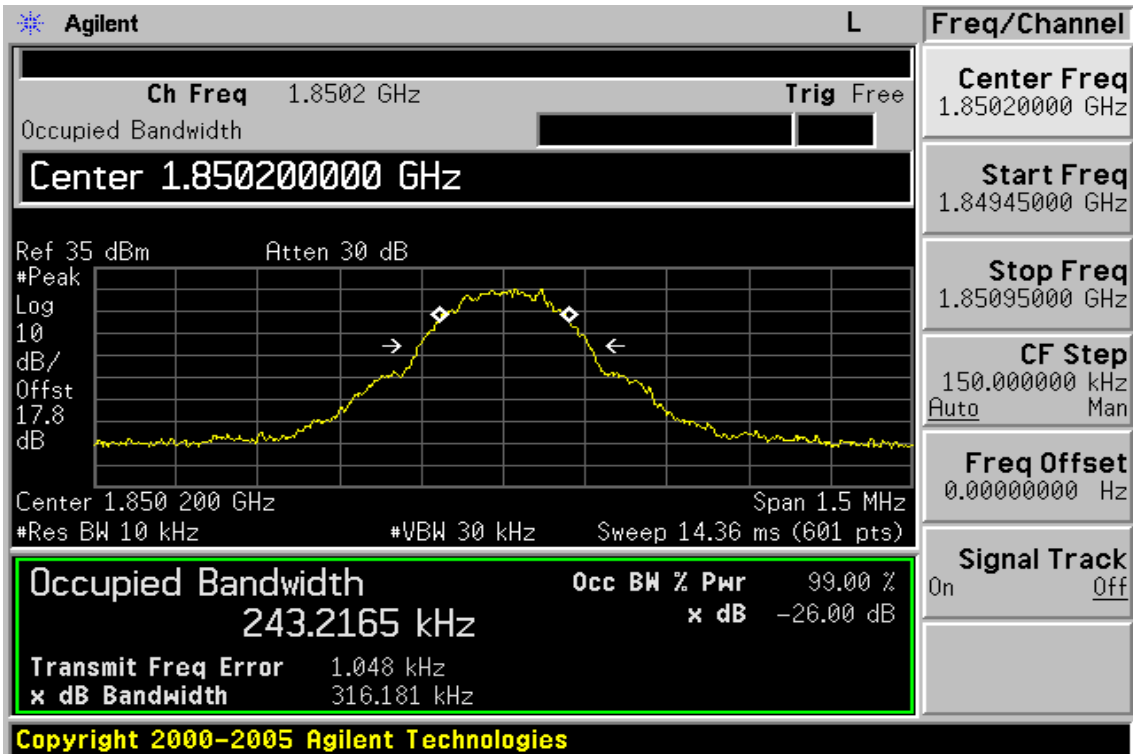

Figure 7-4: PCS Channel Low



Unless otherwise stated the results shown in this test report refer only to the sample(s) tested. This test report cannot be reproduced, except in full, without prior written permission of the Company. 除非另有明，此報告結果僅對測試之樣品負責。本報告未經本公司書面許可，可部份複製。
 This Test Report is issued by the Company under its General Conditions of Service which is available on request or accessible at http://www.sgs.com/terms_and_conditions.htm.
 Attention is drawn to the limitation of liability, indemnification and jurisdiction issues defined therein. Any holder of this Test Report is advised that information contained hereon reflects the Company's findings at the time of its intervention only and within the limits of Client's instructions, if any. The Company's sole responsibility is to its Client and this document does not exonerate parties to a transaction from exercising all their rights and obligations under the transaction documents. Any unauthorized alteration, forgery or falsification of the content or appearance of this document is unlawful and offenders may be prosecuted to the fullest extent of the law.

Figure 7-5 PCS Channel Mid

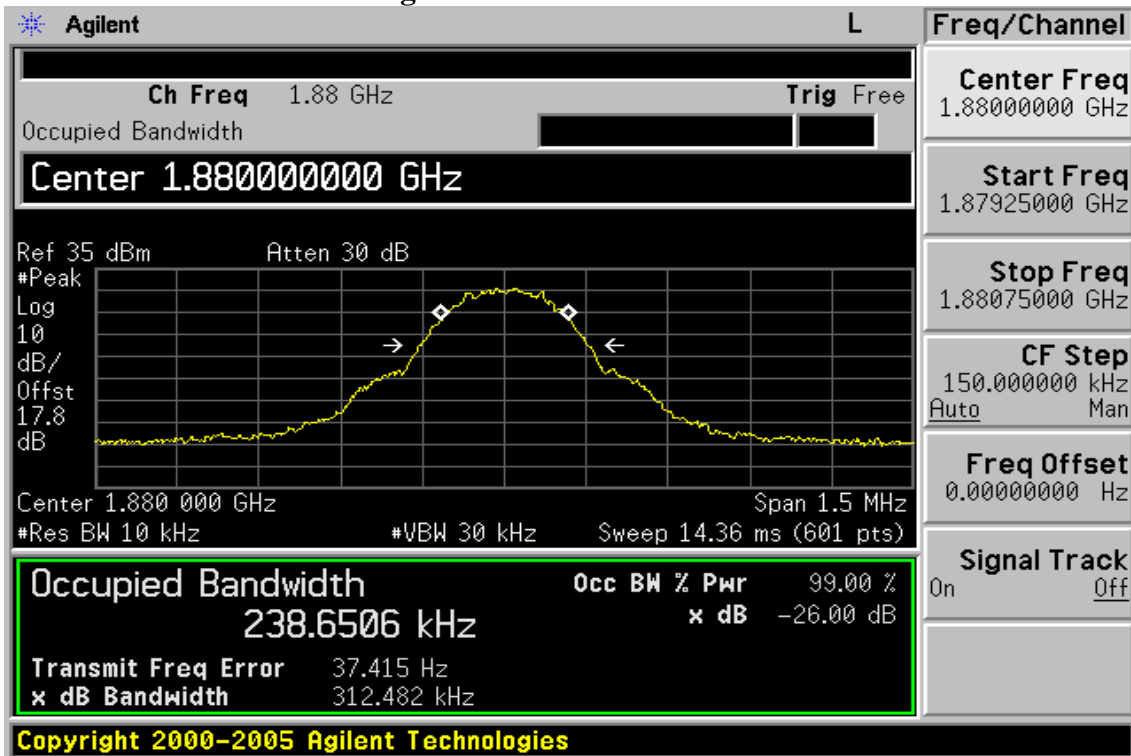
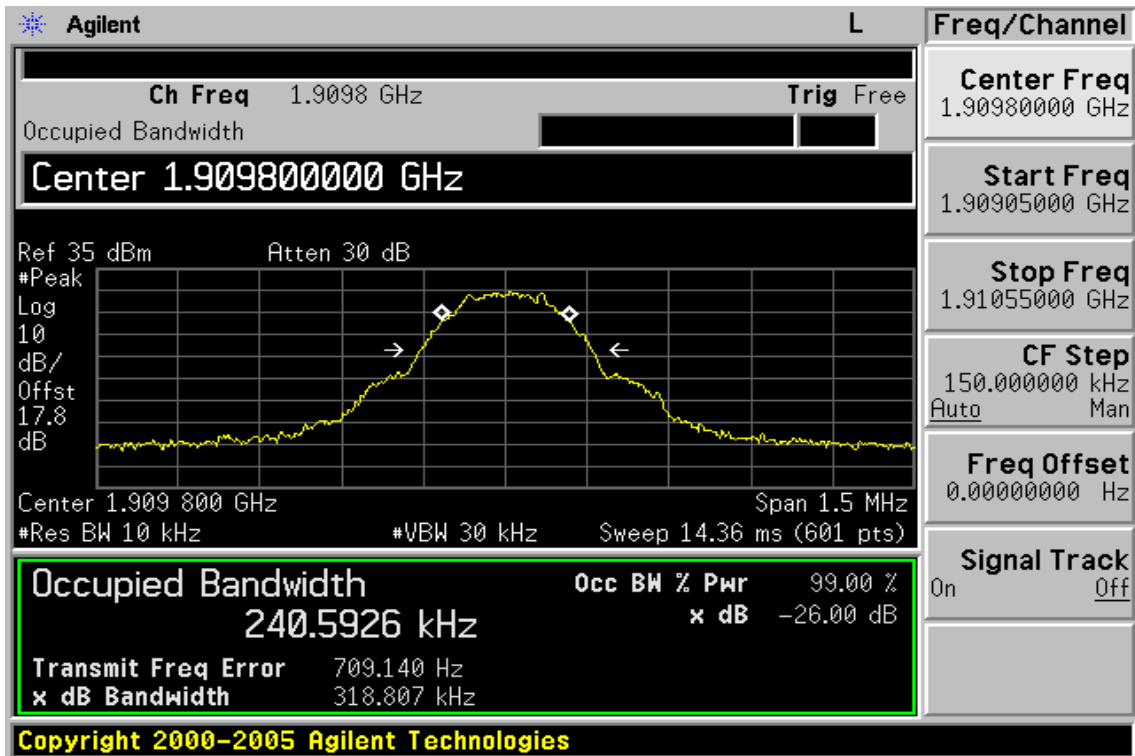

Figure 7-6: PCS Channel High



Unless otherwise stated the results shown in this test report refer only to the sample(s) tested. This test report cannot be reproduced, except in full, without prior written permission of the Company. 除非另有明，此報告結果僅對測試之樣品負責。本報告未經本公司書面許可，可部份複製。
 This Test Report is issued by the Company under its General Conditions of Service which is available on request or accessible at http://www.sgs.com/terms_and_conditions.htm. Attention is drawn to the limitation of liability, indemnification and jurisdiction issues defined therein. Any holder of this Test Report is advised that information contained hereon reflects the Company's findings at the time of its intervention only and within the limits of Client's instructions, if any. The Company's sole responsibility is to its Client and this document does not exonerate parties to a transaction from exercising all their rights and obligations under the transaction documents. Any unauthorized alteration, forgery or falsification of the content or appearance of this document is unlawful and offenders may be prosecuted to the fullest extent of the law.

OUT OF BAND EMISSION AT ANTENNA TERMINALS

8.1. Standard Applicable

According to FCC §2.1051.

FCC §22.917(a),§24.238(a), the magnitude of each spurious and harmonic emission that can be detected when the equipment is operated under the conditions specified in the instruction manual and/ or alignment procedure, shall not be less than $43 + 10 \log$ (mean output power in watts) dBc below the mean power output outside a license's frequency block (-13dBm)

8.2. Test SET-UP

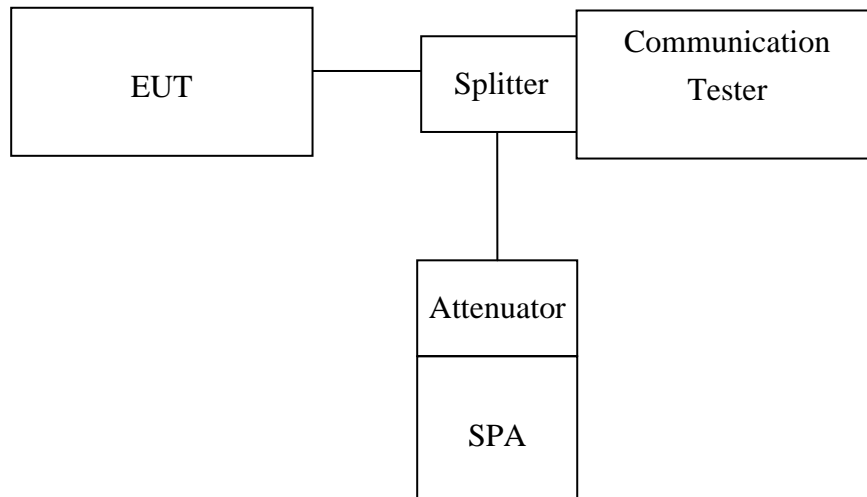

Note: Measurement setup for testing on Antenna connector

8.3. Measurement Procedure

The RF output of the transceiver was connected to a spectrum analyzer through appropriate attenuation. The resolution bandwidth of the spectrum analyzer was set at 1MHz, sufficient scans were taken to show the out of band Emissions if any up to 10th harmonic.

For the out of band: Set the RBW, VBW = 1MHz, Start=30MHz, Stop= 10th harmonic.
Limit = -13dBm

Band Edge Requirements: In the 1 MHz bands immediately outside and adjacent to the frequency block, a resolution bandwidth of at least 1 percent of the emission bandwidth of the fundamental emission of the transmitter may be employed to measure the out of band Emissions. Limit, -13dBm.

Unless otherwise stated the results shown in this test report refer only to the sample(s) tested. This test report cannot be reproduced, except in full, without prior written permission of the Company. 除非另有明，此報告結果僅對測試之樣品負責。本報告未經本公司書面許可，可部份複製。
This Test Report is issued by the Company under its General Conditions of Service which is available on request or accessible at http://www.sgs.com/terms_and_conditions.htm. Attention is drawn to the limitation of liability, indemnification and jurisdiction issues defined therein. Any holder of this Test Report is advised that information contained hereon reflects the Company's findings at the time of its intervention only and within the limits of Client's instructions, if any. The Company's sole responsibility is to its Client and this document does not exonerate parties to a transaction from exercising all their rights and obligations under the transaction documents. Any unauthorized alteration, forgery or falsification of the content or appearance of this document is unlawful and offenders may be prosecuted to the fullest extent of the law.

8.4. Measurement Equipment Used:

Conducted Emission Test Site					
EQUIPMENT TYPE	MFR	MODEL NUMBER	SERIAL NUMBER	LAST CAL.	CAL DUE.
Spectrum Analyzer	Agilent	E4446A	MY43360126	04/27/2008	04/27/2009
Spectrum Analyzer	Agilent	E7405A	US41160416	07/04/2007	07/03/2008
Spectrum Analyzer	R&S	FSP 40	100034	01/05/2008	01/04/2009
Communication Test	R&S	SMU200	N/A	N/A	N/A
Power Sensor	Anritsu	MA2490A	31431	07/07/2007	07/06/2008
Power Meter	Anritsu	ML2487A	6K00002070	07/07/2007	07/06/2008
Temperature Chamber	TERCHY	MHG-120LF	911009	04/26/2008	04/25/2009
Low Loss Cable	HUBER+SUHNER	SUCOFLEX 104PEA	N/A	N/A	N/A
Attenuator	Mini-Circuit	BW-S10W5	N/A	07/05/2007	07/04/2008
Attenuator	Mini-Circuit	BW-S6W5	N/A	07/05/2007	07/04/2008
Splitter	Agilent	11636B	51728	07/05/2007	07/04/2008
DC Power Supply	Agilent	6038A	2929A-07548	06/27/2007	06/26/2008

Unless otherwise stated the results shown in this test report refer only to the sample(s) tested. This test report cannot be reproduced, except in full, without prior written permission of the Company. 除非另有明，此報告結果僅對測試之樣品負責。本報告未經本公司書面許可，可部份複製。

This Test Report is issued by the Company under its General Conditions of Service which is available on request or accessible at http://www.sgs.com/terms_and_conditions.htm.

Attention is drawn to the limitation of liability, indemnification and jurisdiction issues defined therein. Any holder of this Test Report is advised that information contained hereon reflects the Company's findings at the time of its intervention only and within the limits of Client's instructions, if any. The Company's sole responsibility is to its Client and this document does not exonerate parties to a transaction from exercising all their rights and obligations under the transaction documents. Any unauthorized alteration, forgery or falsification of the content or appearance of this document is unlawful and offenders may be prosecuted to the fullest extent of the law.

8.5. Measurement Result

Figure 8-1: Out of Band emission at antenna terminals– GSM Channel Lowest

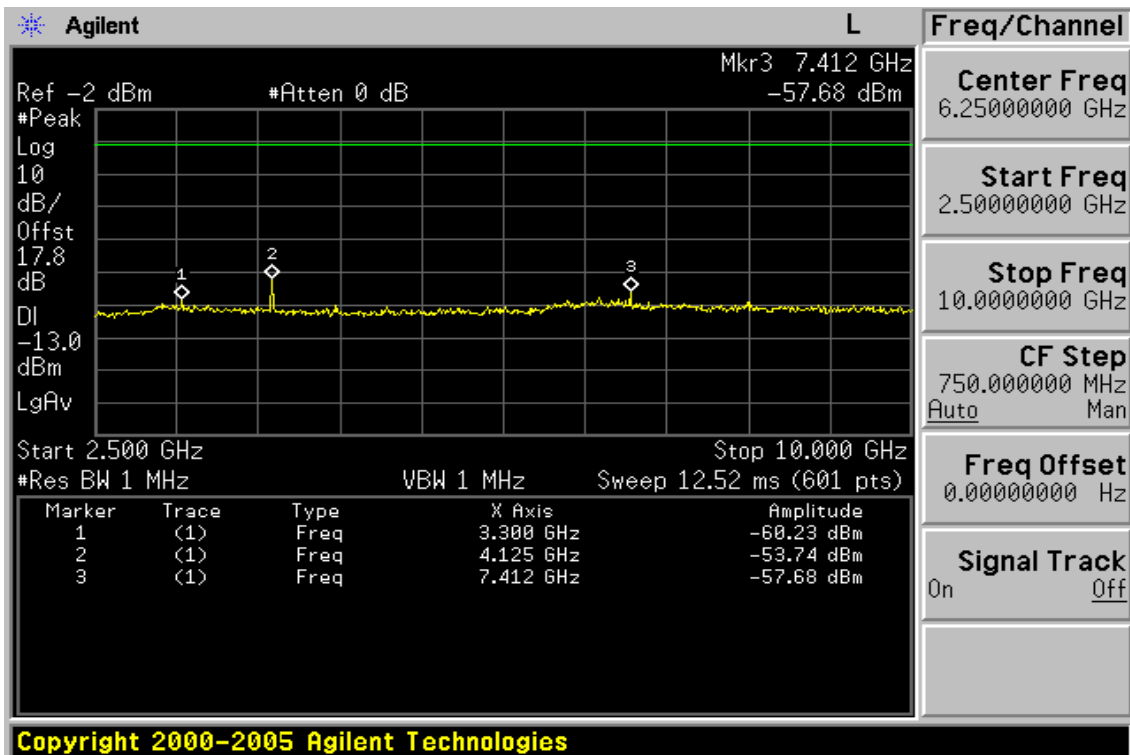
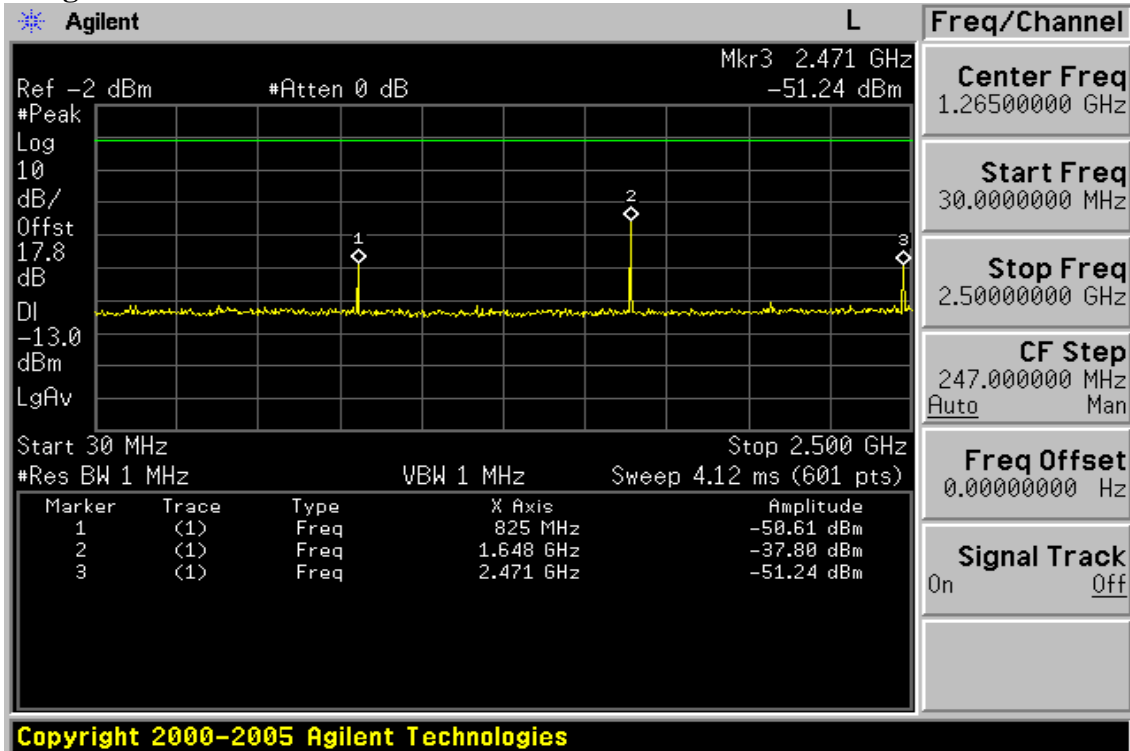

Unless otherwise stated the results shown in this test report refer only to the sample(s) tested. This test report cannot be reproduced, except in full, without prior written permission of the Company. 除非另有明，此報告結果僅對測試之樣品負責。本報告未經本公司書面許可，可部份複製。
 This Test Report is issued by the Company under its General Conditions of Service which is available on request or accessible at http://www.sgs.com/terms_and_conditions.htm. Attention is drawn to the limitation of liability, indemnification and jurisdiction issues defined therein. Any holder of this Test Report is advised that information contained hereon reflects the Company's findings at the time of its intervention only and within the limits of Client's instructions, if any. The Company's sole responsibility is to its Client and this document does not exonerate parties to a transaction from exercising all their rights and obligations under the transaction documents. Any unauthorized alteration, forgery or falsification of the content or appearance of this document is unlawful and offenders may be prosecuted to the fullest extent of the law.

Figure 8-2: Out of Band emission at antenna terminals –GSM Channel Mid

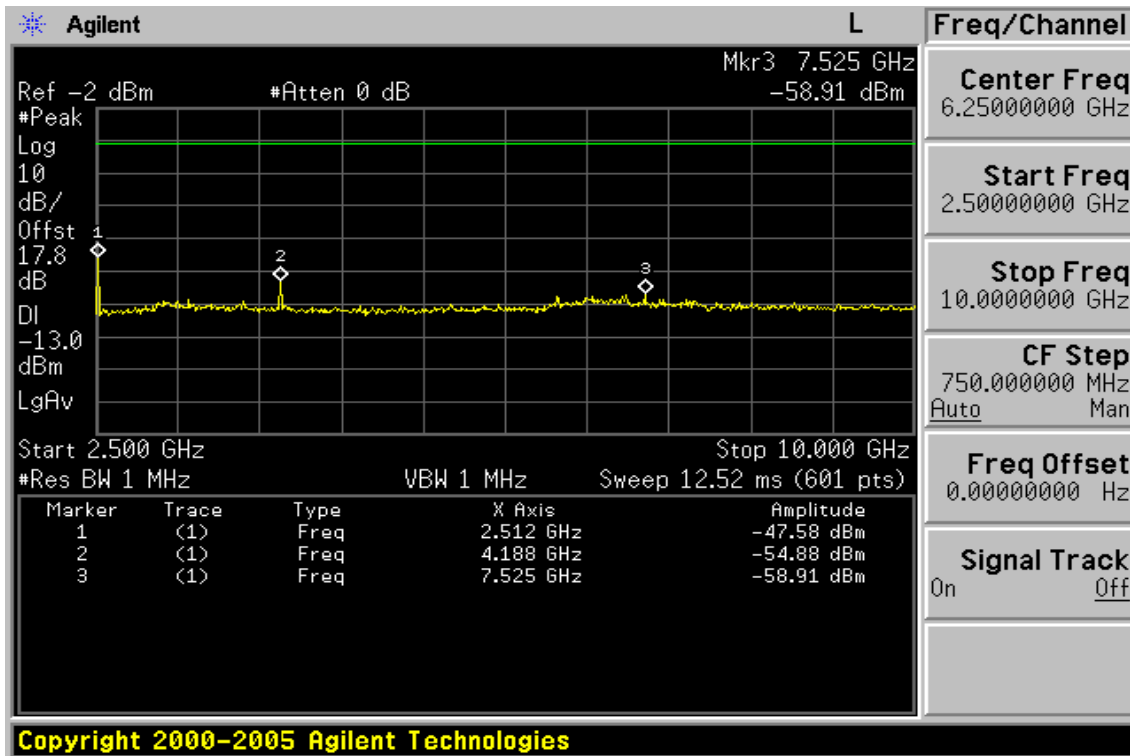
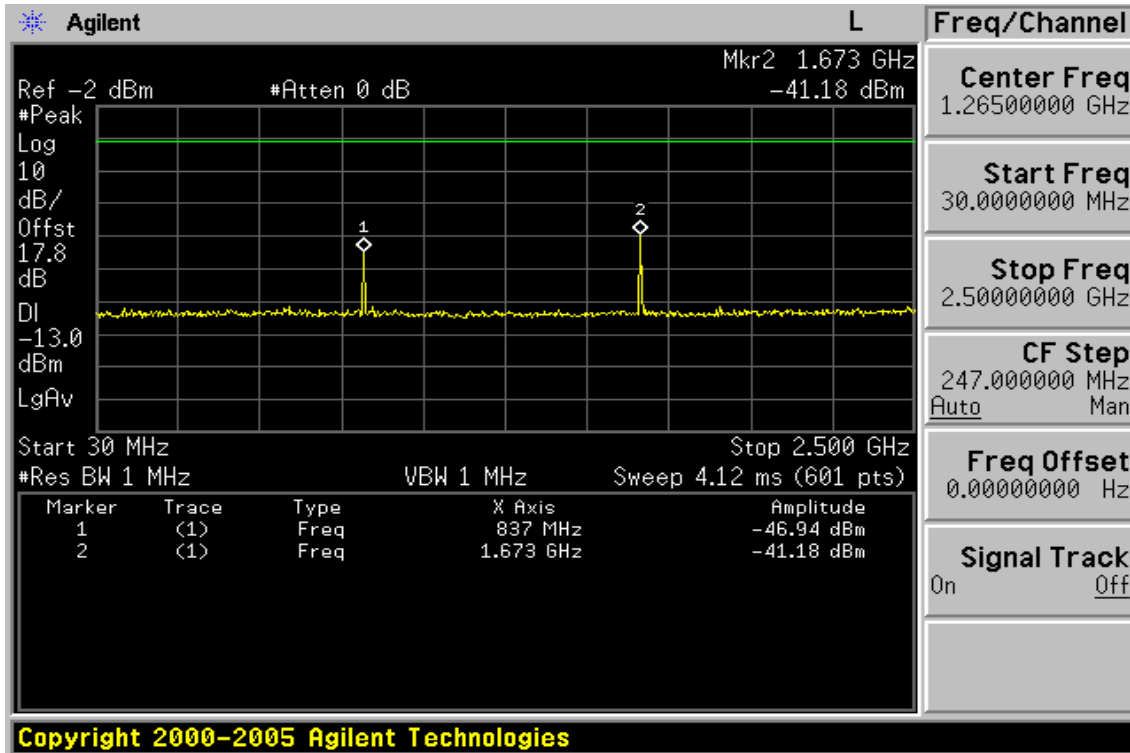

Unless otherwise stated the results shown in this test report refer only to the sample(s) tested. This test report cannot be reproduced, except in full, without prior written permission of the Company. 除非另有明，此報告結果僅對測試之樣品負責。本報告未經本公司書面許可，可部份複製。
 This Test Report is issued by the Company under its General Conditions of Service which is available on request or accessible at http://www.sgs.com/terms_and_conditions.htm.
 Attention is drawn to the limitation of liability, indemnification and jurisdiction issues defined therein. Any holder of this Test Report is advised that information contained hereon reflects the Company's findings at the time of its intervention only and within the limits of Client's instructions, if any. The Company's sole responsibility is to its Client and this document does not exonerate parties to a transaction from exercising all their rights and obligations under the transaction documents. Any unauthorized alteration, forgery or falsification of the content or appearance of this document is unlawful and offenders may be prosecuted to the fullest extent of the law.

Figure 8-3: Out of Band emission at antenna terminals–GSM Channel Highest

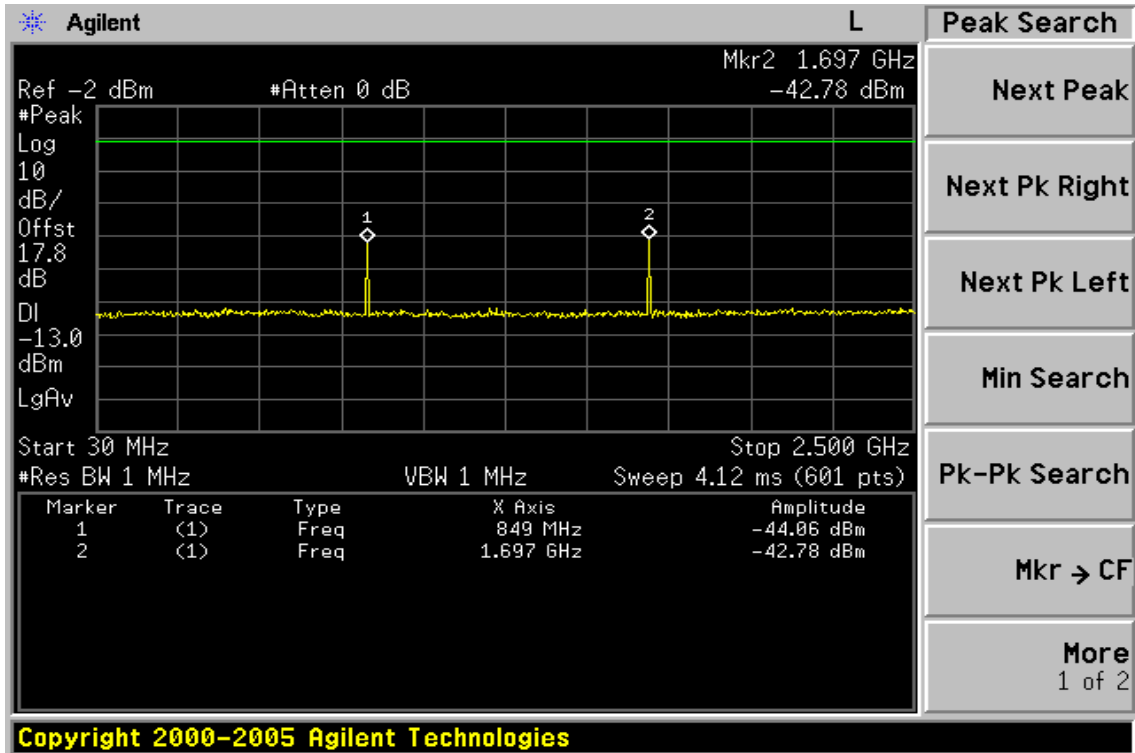

Copyright 2000–2005 Agilent Technologies

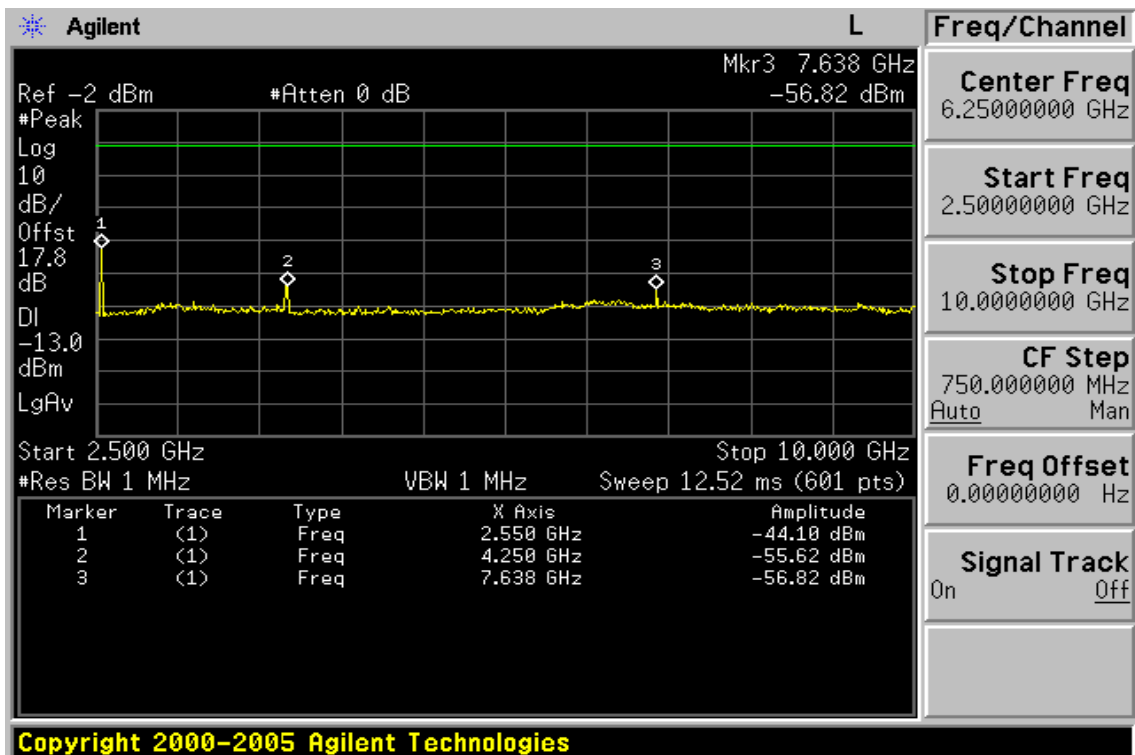

Copyright 2000–2005 Agilent Technologies

Unless otherwise stated the results shown in this test report refer only to the sample(s) tested. This test report cannot be reproduced, except in full, without prior written permission of the Company. 除非另有明，此報告結果僅對測試之樣品負責。本報告未經本公司書面許可，可部份複製。
 This Test Report is issued by the Company under its General Conditions of Service which is available on request or accessible at http://www.sgs.com/terms_and_conditions.htm. Attention is drawn to the limitation of liability, indemnification and jurisdiction issues defined therein. Any holder of this Test Report is advised that information contained hereon reflects the Company's findings at the time of its intervention only and within the limits of Client's instructions, if any. The Company's sole responsibility is to its Client and this document does not exonerate parties to a transaction from exercising all their rights and obligations under the transaction documents. Any unauthorized alteration, forgery or falsification of the content or appearance of this document is unlawful and offenders may be prosecuted to the fullest extent of the law.

Figure 8-4: Band edge emission at antenna terminals – GSM Channel Lowest

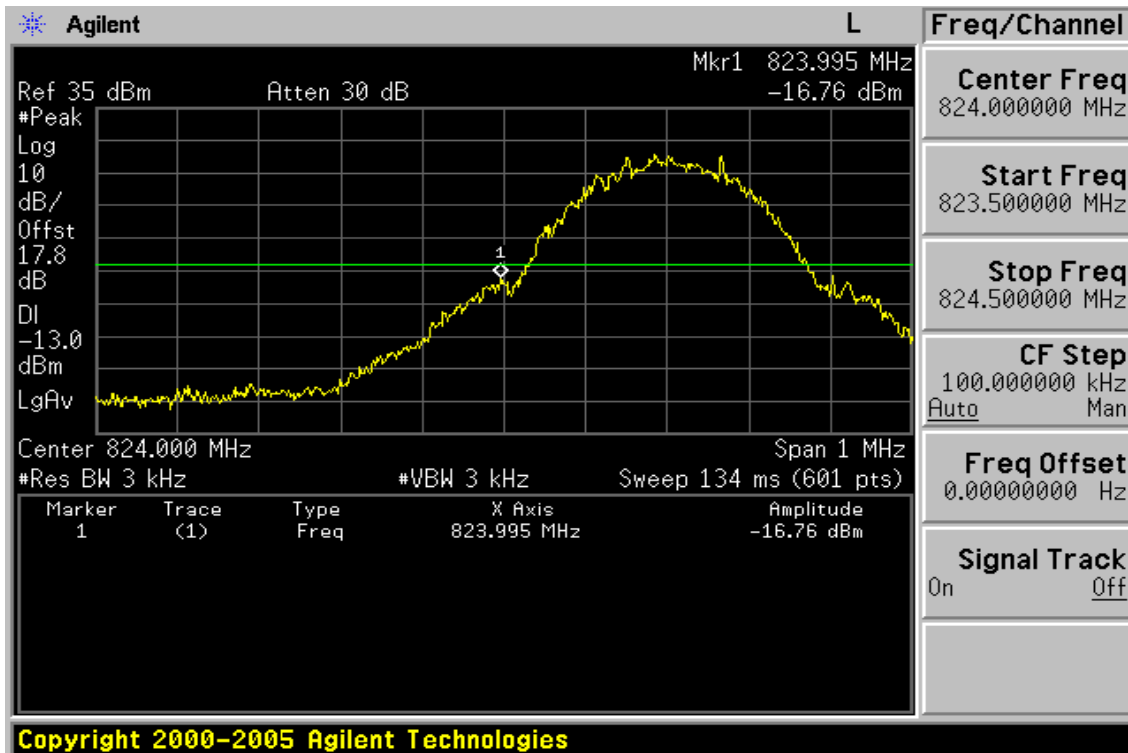
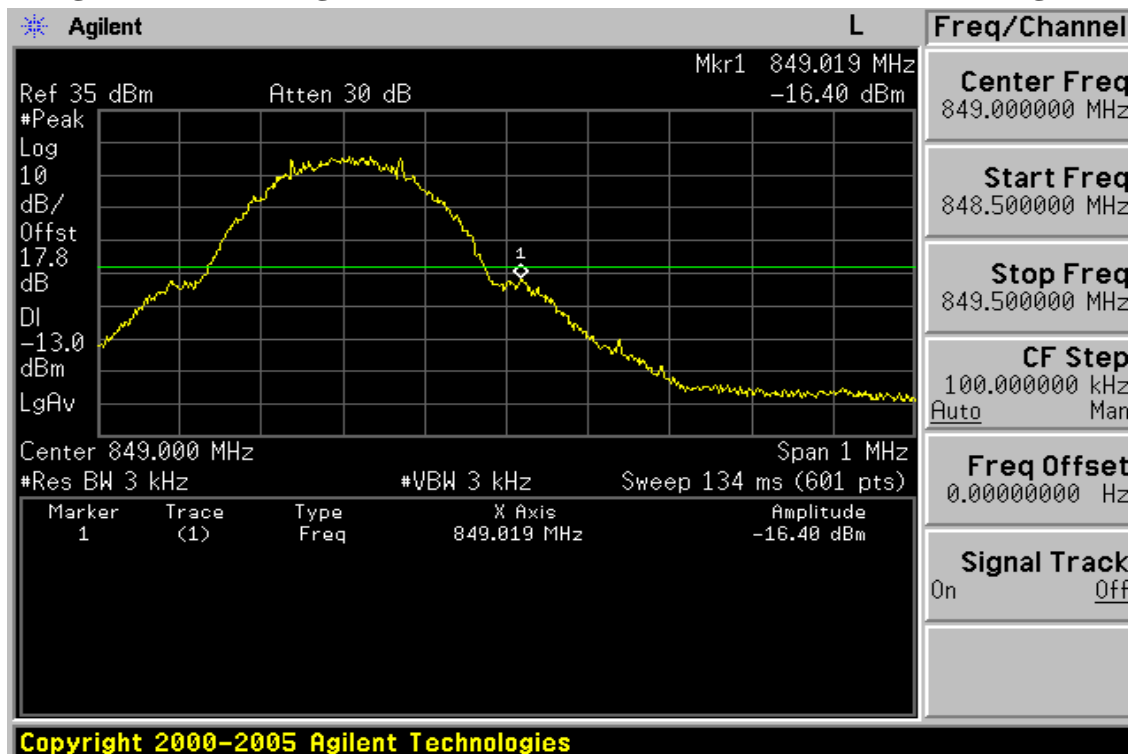
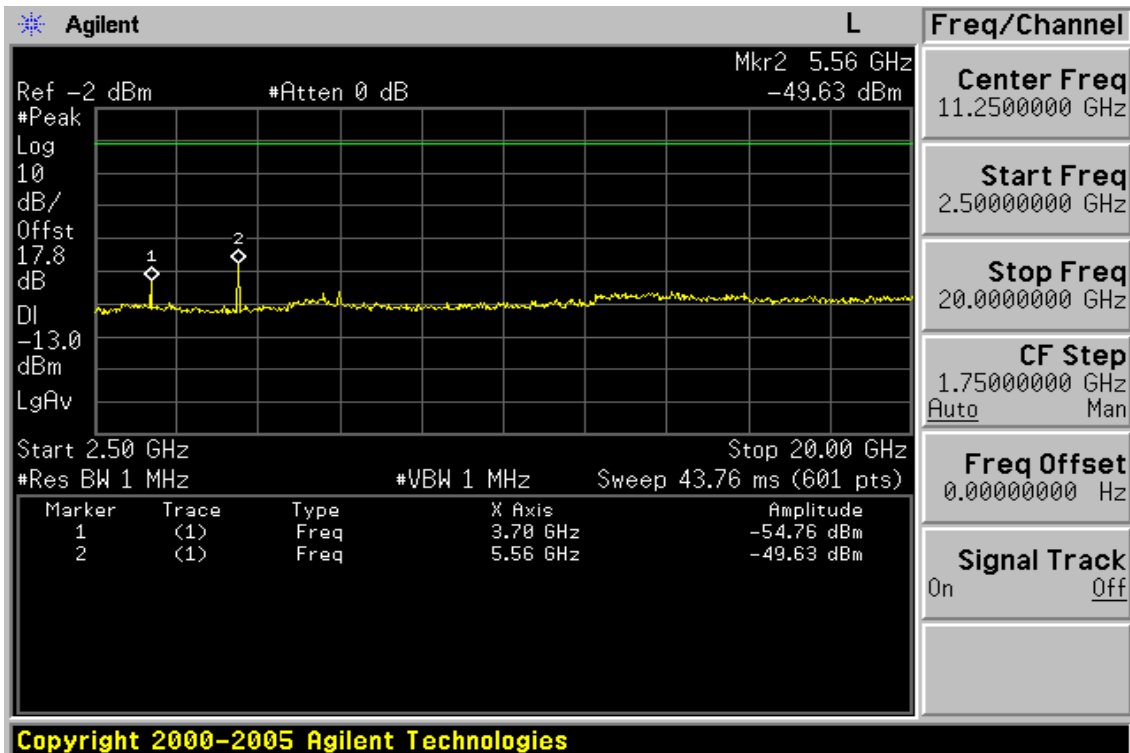
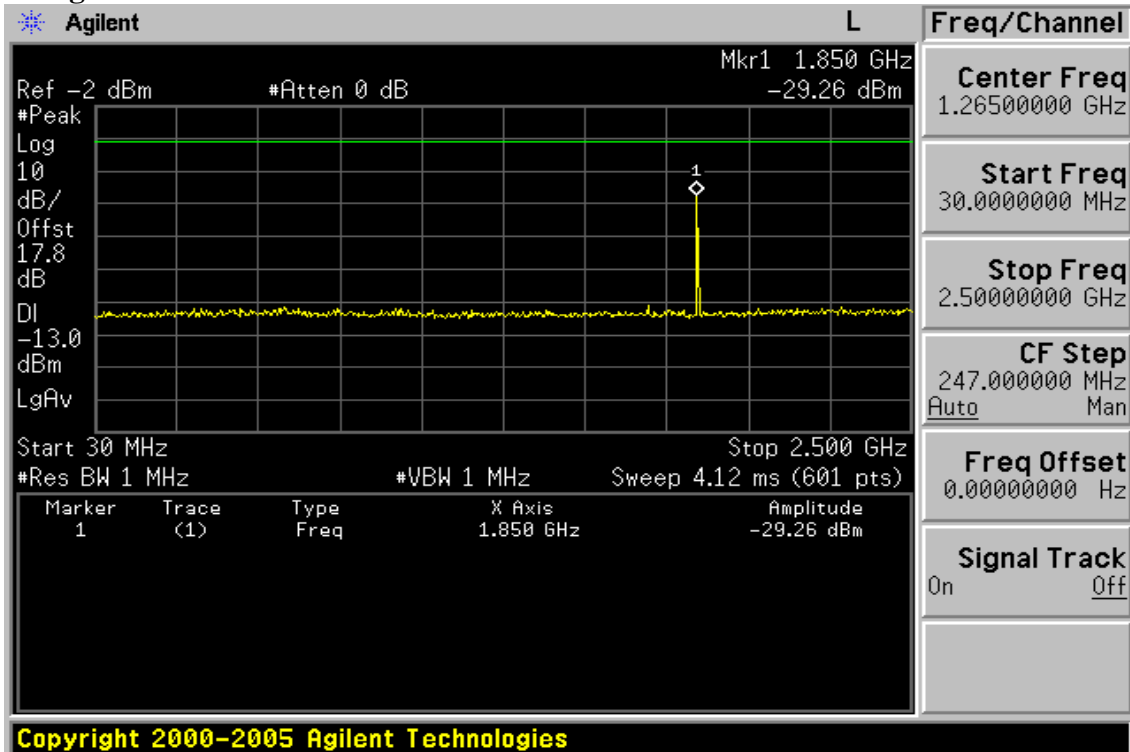

Figure 8-5: Band edge emission at antenna terminals – GSM Channel Highest



Unless otherwise stated the results shown in this test report refer only to the sample(s) tested. This test report cannot be reproduced, except in full, without prior written permission of the Company. 除非另有明，此報告結果僅對測試之樣品負責。本報告未經本公司書面許可，可部份複製。
 This Test Report is issued by the Company under its General Conditions of Service which is available on request or accessible at http://www.sgs.com/terms_and_conditions.htm. Attention is drawn to the limitation of liability, indemnification and jurisdiction issues defined therein. Any holder of this Test Report is advised that information contained hereon reflects the Company's findings at the time of its intervention only and within the limits of Client's instructions, if any. The Company's sole responsibility is to its Client and this document does not exonerate parties to a transaction from exercising all their rights and obligations under the transaction documents. Any unauthorized alteration, forgery or falsification of the content or appearance of this document is unlawful and offenders may be prosecuted to the fullest extent of the law.

Figure 8-6: Out of Band emission at antenna terminals– PCS Channel Lowest



Unless otherwise stated the results shown in this test report refer only to the sample(s) tested. This test report cannot be reproduced, except in full, without prior written permission of the Company. 除非另有明，此報告結果僅對測試之樣品負責。本報告未經本公司書面許可，可部份複製。
 This Test Report is issued by the Company under its General Conditions of Service which is available on request or accessible at http://www.sgs.com/terms_and_conditions.htm. Attention is drawn to the limitation of liability, indemnification and jurisdiction issues defined therein. Any holder of this Test Report is advised that information contained hereon reflects the Company's findings at the time of its intervention only and within the limits of Client's instructions, if any. The Company's sole responsibility is to its Client and this document does not exonerate parties to a transaction from exercising all their rights and obligations under the transaction documents. Any unauthorized alteration, forgery or falsification of the content or appearance of this document is unlawful and offenders may be prosecuted to the fullest extent of the law.

Figure 8-7: Out of Band emission at antenna terminals –PCS Channel Mid

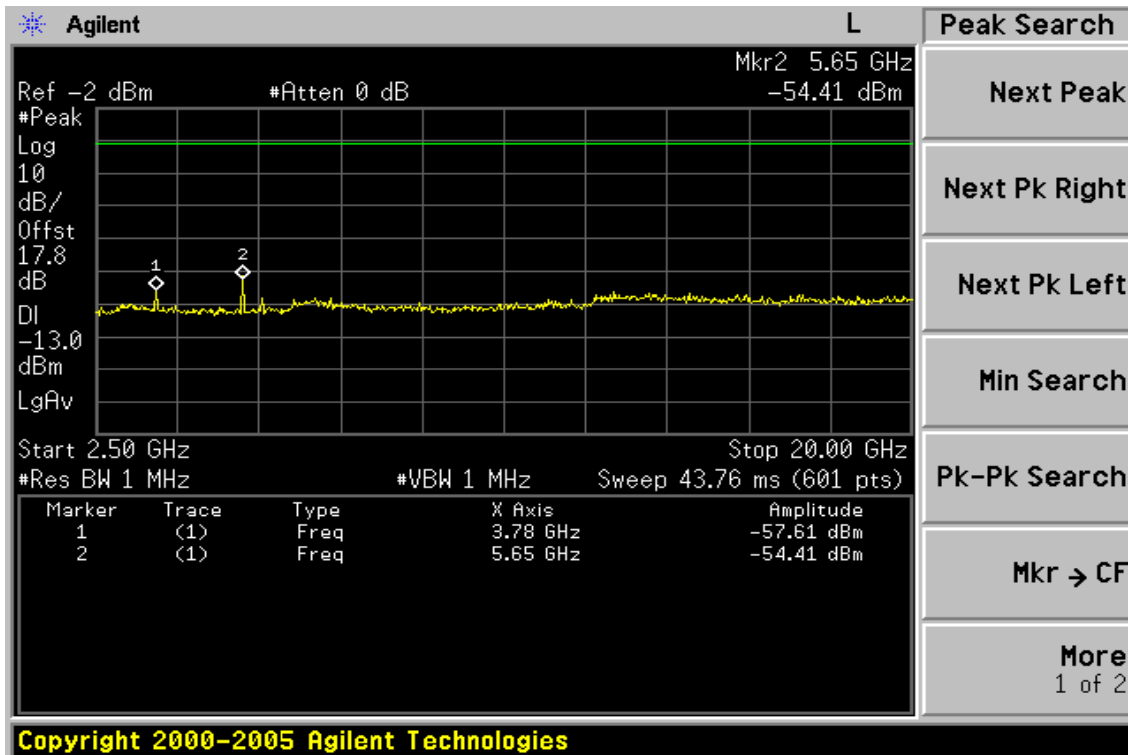
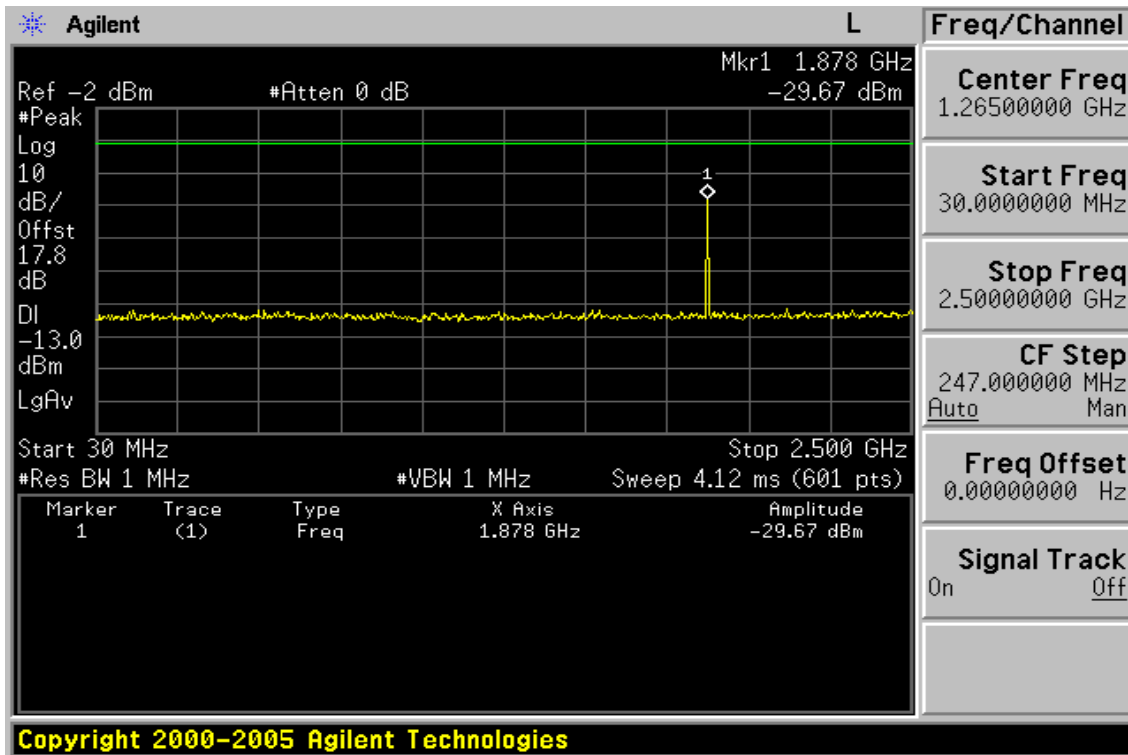

Unless otherwise stated the results shown in this test report refer only to the sample(s) tested. This test report cannot be reproduced, except in full, without prior written permission of the Company. 除非另有明，此報告結果僅對測試之樣品負責。本報告未經本公司書面許可，可部份複製。
 This Test Report is issued by the Company under its General Conditions of Service which is available on request or accessible at http://www.sgs.com/terms_and_conditions.htm. Attention is drawn to the limitation of liability, indemnification and jurisdiction issues defined therein. Any holder of this Test Report is advised that information contained hereon reflects the Company's findings at the time of its intervention only and within the limits of Client's instructions, if any. The Company's sole responsibility is to its Client and this document does not exonerate parties to a transaction from exercising all their rights and obligations under the transaction documents. Any unauthorized alteration, forgery or falsification of the content or appearance of this document is unlawful and offenders may be prosecuted to the fullest extent of the law.

Figure 8-8: Out of Band emission at antenna terminals–PCS Channel Highest

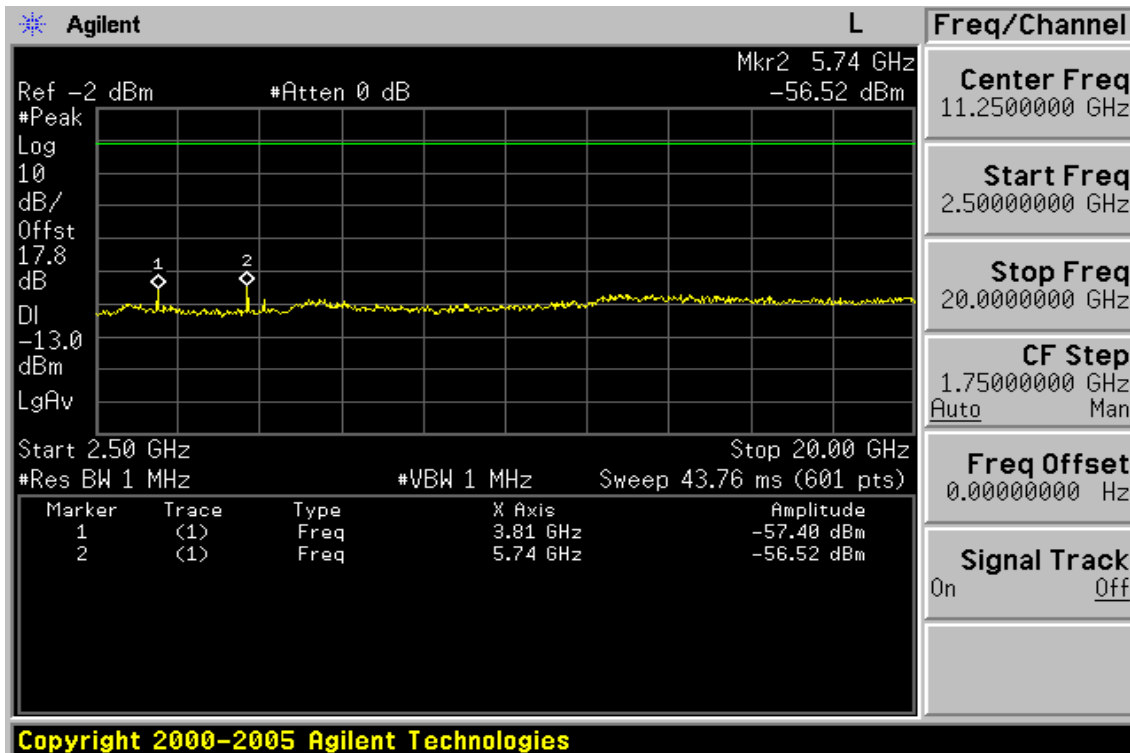
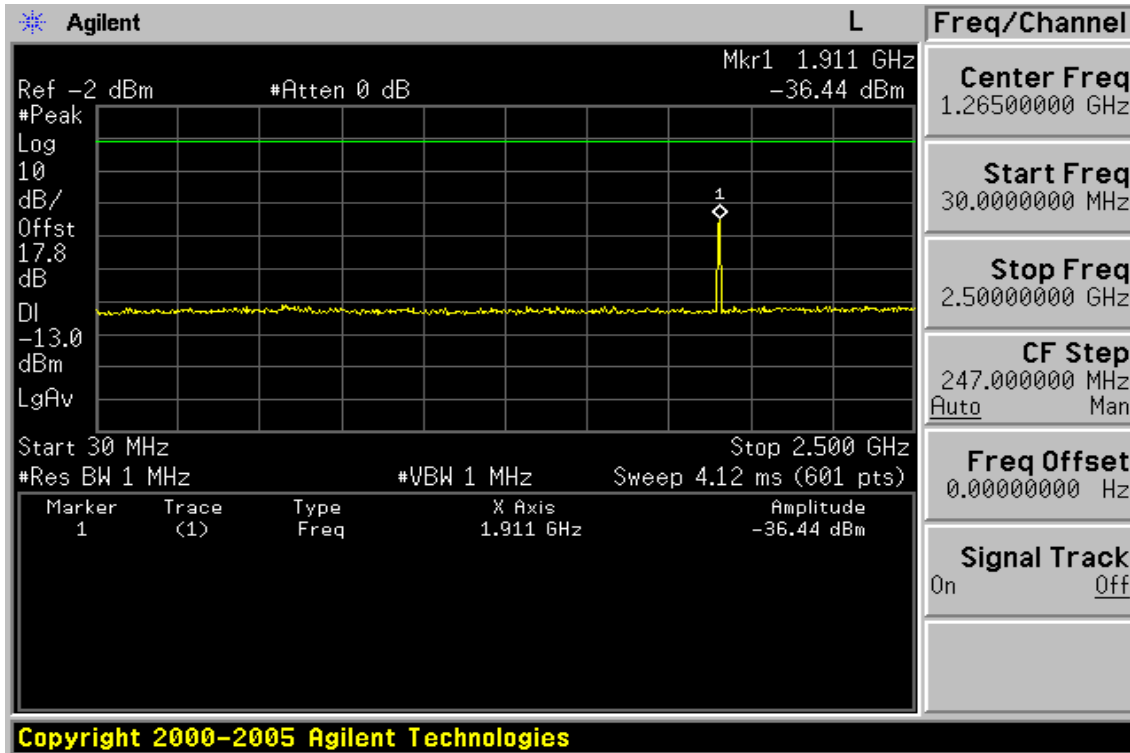

Unless otherwise stated the results shown in this test report refer only to the sample(s) tested. This test report cannot be reproduced, except in full, without prior written permission of the Company. 除非另有明，此報告結果僅對測試之樣品負責。本報告未經本公司書面許可，可部份複製。
 This Test Report is issued by the Company under its General Conditions of Service which is available on request or accessible at http://www.sgs.com/terms_and_conditions.htm.
 Attention is drawn to the limitation of liability, indemnification and jurisdiction issues defined therein. Any holder of this Test Report is advised that information contained hereon reflects the Company's findings at the time of its intervention only and within the limits of Client's instructions, if any. The Company's sole responsibility is to its Client and this document does not exonerate parties to a transaction from exercising all their rights and obligations under the transaction documents. Any unauthorized alteration, forgery or falsification of the content or appearance of this document is unlawful and offenders may be prosecuted to the fullest extent of the law.

Figure 8-9: Bad edge emission at antenna terminals – PCS Channel Lowest

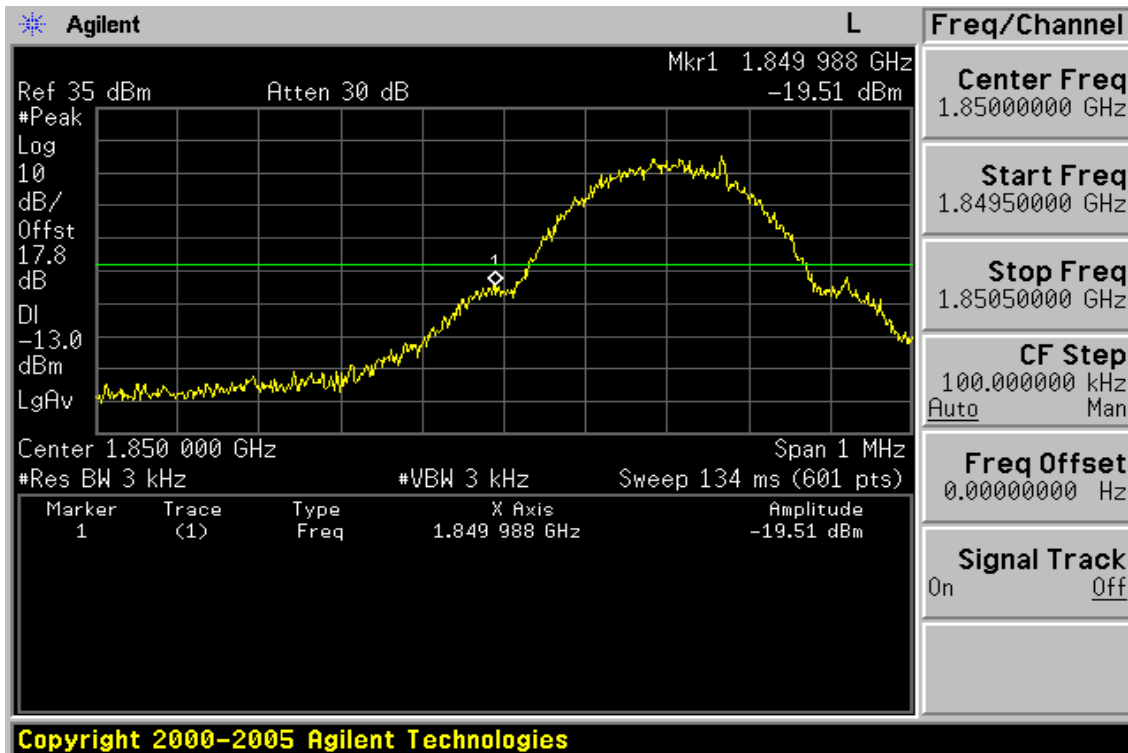
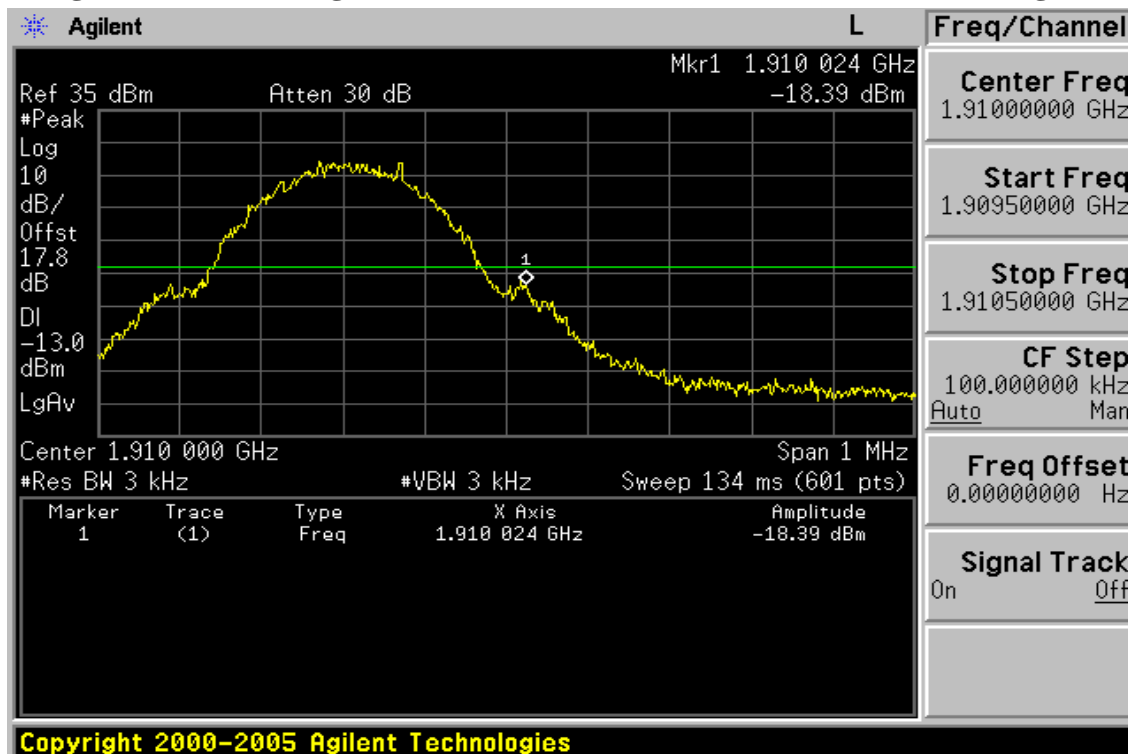

Figure 8-10: Band edge emission at antenna terminals – PCS Channel Highest



Unless otherwise stated the results shown in this test report refer only to the sample(s) tested. This test report cannot be reproduced, except in full, without prior written permission of the Company. 除非另有明，此報告結果僅對測試之樣品負責。本報告未經本公司書面許可，可部份複製。
 This Test Report is issued by the Company under its General Conditions of Service which is available on request or accessible at http://www.sgs.com/terms_and_conditions.htm. Attention is drawn to the limitation of liability, indemnification and jurisdiction issues defined therein. Any holder of this Test Report is advised that information contained hereon reflects the Company's findings at the time of its intervention only and within the limits of Client's instructions, if any. The Company's sole responsibility is to its Client and this document does not exonerate parties to a transaction from exercising all their rights and obligations under the transaction documents. Any unauthorized alteration, forgery or falsification of the content or appearance of this document is unlawful and offenders may be prosecuted to the fullest extent of the law.

FIELD STRENGTH OF SPURIOUS RADIATION MEASUREMENT

9.1. Standard Applicable

According to FCC §2.1053,

FCC §22.917(a),§24.238(a), the magnitude of each spurious and harmonic emission that can be detected when the equipment is operated under the conditions specified in the instruction manual and/ or alignment procedure, shall not be less than $43 + 10 \log$ (mean output power in watts) dBc below the mean power output outside a license's frequency block (-13dBm)

9.2. EUT Setup (Block Diagram of Configuration)

(A) Radiated Emission Test Set-Up, Frequency Below 1000MHz

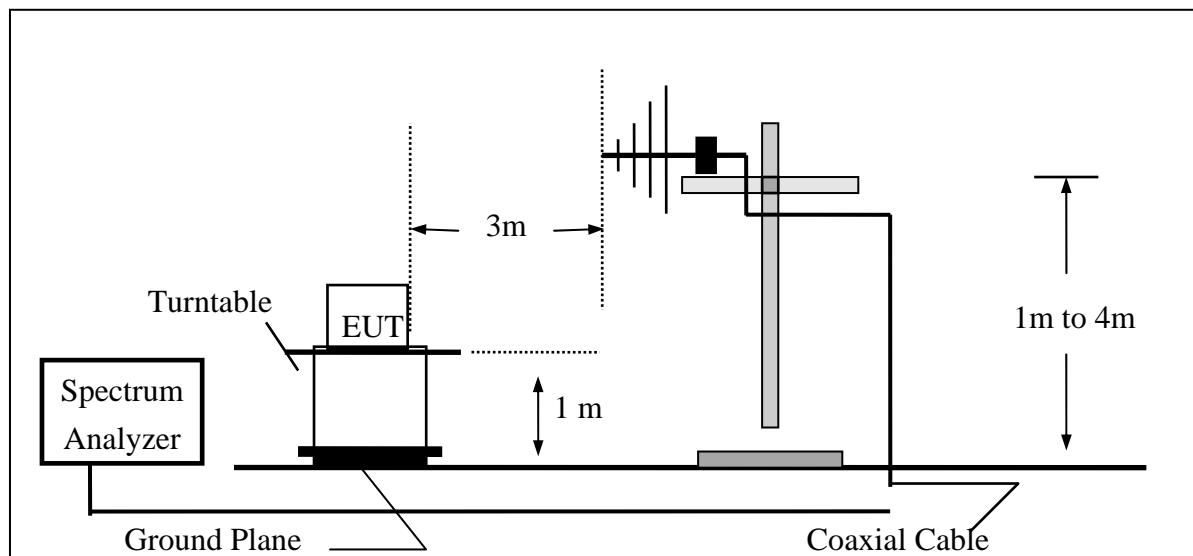

Unless otherwise stated the results shown in this test report refer only to the sample(s) tested. This test report cannot be reproduced, except in full, without prior written permission of the Company. 除非另有明，此報告結果僅對測試之樣品負責。本報告未經本公司書面許可，可部份複製。
 This Test Report is issued by the Company under its General Conditions of Service which is available on request or accessible at http://www.sgs.com/terms_and_conditions.htm. Attention is drawn to the limitation of liability, indemnification and jurisdiction issues defined therein. Any holder of this Test Report is advised that information contained hereon reflects the Company's findings at the time of its intervention only and within the limits of Client's instructions, if any. The Company's sole responsibility is to its Client and this document does not exonerate parties to a transaction from exercising all their rights and obligations under the transaction documents. Any unauthorized alteration, forgery or falsification of the content or appearance of this document is unlawful and offenders may be prosecuted to the fullest extent of the law.

(B) Radiated Emission Test Set-UP Frequency Over 1 GHz

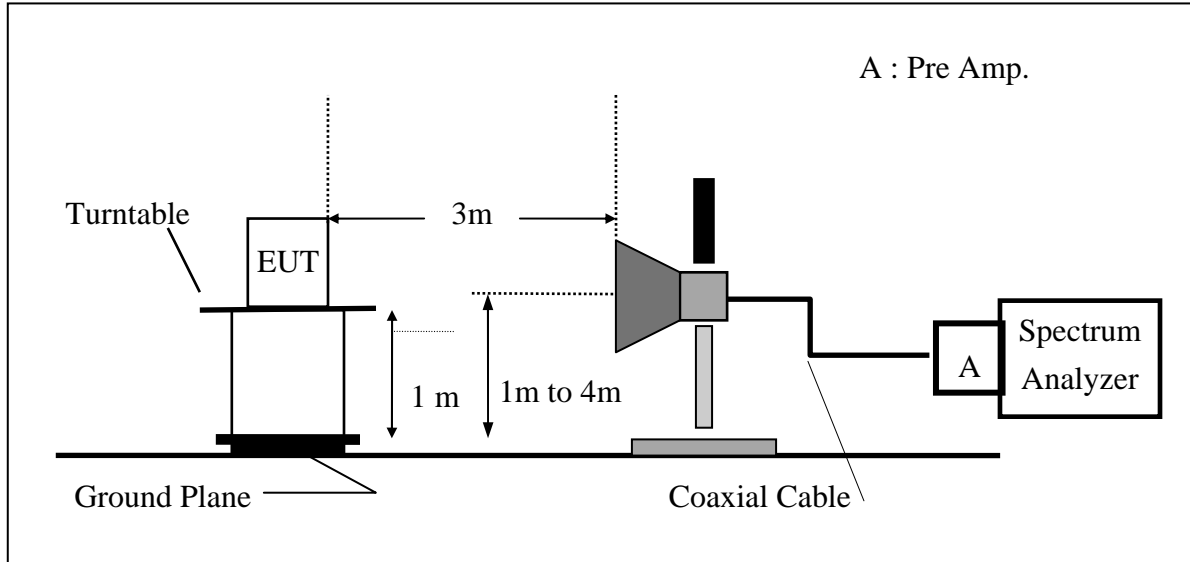

(C) Substituted Method Test Set-UP

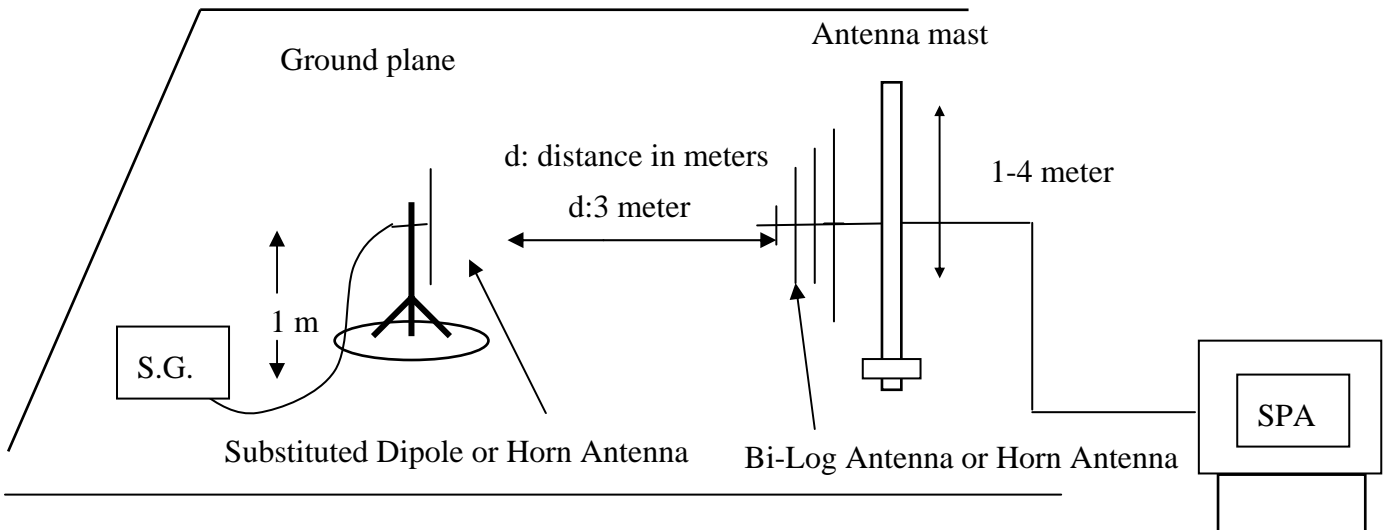

Unless otherwise stated the results shown in this test report refer only to the sample(s) tested. This test report cannot be reproduced, except in full, without prior written permission of the Company. 除非另有明，此報告結果僅對測試之樣品負責。本報告未經本公司書面許可，可部份複製。
 This Test Report is issued by the Company under its General Conditions of Service which is available on request or accessible at http://www.sgs.com/terms_and_conditions.htm. Attention is drawn to the limitation of liability, indemnification and jurisdiction issues defined therein. Any holder of this Test Report is advised that information contained hereon reflects the Company's findings at the time of its intervention only and within the limits of Client's instructions, if any. The Company's sole responsibility is to its Client and this document does not exonerate parties to a transaction from exercising all their rights and obligations under the transaction documents. Any unauthorized alteration, forgery or falsification of the content or appearance of this document is unlawful and offenders may be prosecuted to the fullest extent of the law.

9.3. Measurement Procedure

The EUT was placed on a non-conductive, The measurement antenna was placed at a distance of 3 meters from the EUT. During the tests, the antenna height and the EUT azimuth were varied in order to identify the maximum level of emissions from the EUT. This maximization process was repeated with the EUT positioned in each of its three orthogonal orientations.

During the measurement, the EUT was communication with the station. The highest emission was recorded with the rotation of the turntable and the lowering of the test antenna from 4m to 1m. The reading was recorded and the field strength (E in dBuV/m) was calculated. And Peak detector was used during this test.

When measurement procedures for electric field radiated emissions above 1 GHz the EUT measurement is to be made “while keeping the antenna in the ‘cone of radiation’ from that area and pointed at the area both in azimuth and elevation, with polarization oriented for maximum response.” is still within the 3dB illumination BW of the measurement antenna.

ERP was measured using a substitution method. The EUT was replaced by dipole antenna connected, the S.G. output was recorded and ERP was calculated as follows:

EIRP was measured using a substitution method. The EUT was replaced by or horn antenna connected, the S.G. output was recorded and EIRP was calculated as follows:

$$\text{ERP} = \text{S.G. output (dBm)} + \text{Antenna Gain (dBd)} - \text{Cable Loss (dB)}$$

$$\text{EIRP} = \text{S.G. output (dBm)} + \text{Antenna Gain (dBi)} - \text{Cable Loss (dB)}$$

Unless otherwise stated the results shown in this test report refer only to the sample(s) tested. This test report cannot be reproduced, except in full, without prior written permission of the Company. 除非另有明，此報告結果僅對測試之樣品負責。本報告未經本公司書面許可，可部份複製。

This Test Report is issued by the Company under its General Conditions of Service which is available on request or accessible at http://www.sgs.com/terms_and_conditions.htm. Attention is drawn to the limitation of liability, indemnification and jurisdiction issues defined therein. Any holder of this Test Report is advised that information contained hereon reflects the Company's findings at the time of its intervention only and within the limits of Client's instructions, if any. The Company's sole responsibility is to its Client and this document does not exonerate parties to a transaction from exercising all their rights and obligations under the transaction documents. Any unauthorized alteration, forgery or falsification of the content or appearance of this document is unlawful and offenders may be prosecuted to the fullest extent of the law.

9.4. Measurement Equipment Used:

EQUIPMENT TYPE	MFR	MODEL NUMBER	SERIAL NUMBER	LAST CAL.	CAL DUE.
Spectrum Analyzer	Agilent	E4446A	MY43360126	04/27/2008	04/26/2009
Spectrum Analyzer	Agilent	E7405A	US41160416	07/04/2007	07/03/2008
Communication Test	R&S	SMU200	N/A	N/A	N/A
Bi-log Antenna	SCHWAZBECK	VULB9160	3224	11/14/2008	11/13/2008
Horn antenna	SCHWAZBECK	BBHA 9120D	309/320	08/16/2007	08/15/2008
Pre-Amplifier	HP	8447D	2944A09469	07/19/2007	07/18/2008
Pre-Amplifier	HP	8494B	3008A00578	02/26/2008	02/25/2009
Signal Generator	R&S	SMR40	100210	02/09/2008	02/10/2009
Turn Table	HD	DT420	N/A	N.C.R	N.C.R
Antenna Tower	HD	MA240-N	240/657	N.C.R	N.C.R
Controller	HD	HD100	N/A	N.C.R	N.C.R
Low Loss Cable	HUBER+SUHNER	SUCOFLEX 104PEA-10M	10m	10/09/2007	10/08/2008
Low Loss Cable	HUBER+SUHNER	SUCOFLEX 104PEA-3M	3m	10/09/2007	10/08/2008
Low Loss Cable	HUBER+SUHNER	SUCOFLEX 104PEA-0.5M	0.5m	10/09/2007	10/08/2008
Site NSA	SGS	966 chamber	N/A	11/17/2007	11/16/2008
Attenuator	Mini-Circuit	BW-S10W5	N/A	09/23/2007	09/22/2008
Dipole Antenna	SCHWAZBECK	VHAP	908/909	06/09/2007	06/10/2008
Dipole Antenna	SCHWAZBECK	UHAP	891/892	06/09/2007	06/10/2008
Horn antenna	SCHWAZBECK	BBHA 9120D	N/A	08/16/2007	08/15/2008

9.5. Measurement Result

Refer to attach tabular data sheets.

Unless otherwise stated the results shown in this test report refer only to the sample(s) tested. This test report cannot be reproduced, except in full, without prior written permission of the Company. 除非另有明，此報告結果僅對測試之樣品負責。本報告未經本公司書面許可，可部份複製。
 This Test Report is issued by the Company under its General Conditions of Service which is available on request or accessible at http://www.sgs.com/terms_and_conditions.htm. Attention is drawn to the limitation of liability, indemnification and jurisdiction issues defined therein. Any holder of this Test Report is advised that information contained hereon reflects the Company's findings at the time of its intervention only and within the limits of Client's instructions, if any. The Company's sole responsibility is to its Client and this document does not exonerate parties to a transaction from exercising all their rights and obligations under the transaction documents. Any unauthorized alteration, forgery or falsification of the content or appearance of this document is unlawful and offenders may be prosecuted to the fullest extent of the law.

Radiated Spurious Emission Measurement Result: GSM 850 Mode

Operation Mode	: TX CH Low H Mode	Test Date:	May. 16, 2008
Fundamental Frequency	: 824.20 MHz	Test By:	Sky
Temperature	: 25	Pol:	Ver
Humidity	: 65%		

Freq. (MHz)	SPA. Reading (dBuV)	Ant.Pol. H/V	S.G Out-put (dBm)	Antenna Gain (dB/dBi)	Cable Loss (dB)	ERP/EIRP (dBm)	Limit (dBm)	Safe Margin (dBm)
93.05	64.03	V	-40.16	-7.75	1.18	-49.09	-13.00	-36.09
102.75	63.99	V	-39.38	-7.76	1.23	-48.37	-13.00	-35.37
120.21	40.08	V	-61.16	-7.78	1.32	-70.25	-13.00	-57.25
186.17	40.06	V	-60.80	-7.83	1.54	-70.16	-13.00	-57.16
199.75	48.18	V	-53.90	-7.84	1.56	-63.30	-13.00	-50.30
824.00	78.84	V	-8.49	-7.87	3.64	-20.01	-13.00	-7.01
1648.40	74.17	V	-32.87	9.29	5.06	-28.64	-13.00	-15.64
2463.00	67.61	V	-36.51	10.08	6.28	-32.72	-13.00	-19.72
2472.60	---	V		10.08	6.30		-13.00	
3296.80	50.44	V	-52.14	12.17	7.26	-47.23	-13.00	-34.23
4108.00	45.44	V	-54.38	12.61	8.32	-50.09	-13.00	-37.09
4121.00	---	V		12.61	8.33		-13.00	
4945.20	---	V		12.65	9.19		-13.00	
5769.40	---	V		13.55	9.80		-13.00	
6593.60	---	V		12.05	10.61		-13.00	
7417.80	---	V		11.49	11.28		-13.00	
8242.00	---	V		11.48	12.26		-13.00	

Measurement uncertainty	30MHz - 80MHz: 5.04dB
	80MHz -1000MHz: 3.76dB
	1GHz - 13GHz: 4.45dB

Remark :

- 1 The emission behaviors belong to narrowband spurious emission.
- 2 Remark"---" means that the emission level is too low to be measured
- 3 The result basic equation calculation is as follows:
- 4 $ERP/EIRP (dBm) = SG \text{ Setting}(dBm) + Antenna \text{ Gain} (dB/dBi) - Cable \text{ loss} (dB)$

Unless otherwise stated the results shown in this test report refer only to the sample(s) tested. This test report cannot be reproduced, except in full, without prior written permission of the Company. 除非另有明，此報告結果僅對測試之樣品負責。本報告未經本公司書面許可，可部份複製。
 This Test Report is issued by the Company under its General Conditions of Service which is available on request or accessible at http://www.sgs.com/terms_and_conditions.htm. Attention is drawn to the limitation of liability, indemnification and jurisdiction issues defined therein. Any holder of this Test Report is advised that information contained hereon reflects the Company's findings at the time of its intervention only and within the limits of Client's instructions, if any. The Company's sole responsibility is to its Client and this document does not exonerate parties to a transaction from exercising all their rights and obligations under the transaction documents. Any unauthorized alteration, forgery or falsification of the content or appearance of this document is unlawful and offenders may be prosecuted to the fullest extent of the law.

Radiated Spurious Emission Measurement Result: GSM 850 Mode

Operation Mode	: TX CH Low H Mode	Test Date:	May. 16, 2008
Fundamental Frequency	: 824.20 MHz	Test By:	Sky
Temperature	: 25	Pol:	Hor
Humidity	: 65%		

Freq. (MHz)	SPA. Reading (dBuV)	Ant.Pol. H/V	S.G Out-put (dBm)	Antenna Gain (dB/dBi)	Cable Loss (dB)	ERP/EIRP (dBm)	Limit (dBm)	Safe Margin (dBm)
94.02	55.77	H	-47.73	-7.75	1.18	-56.67	-13.00	-43.67
120.21	47.40	H	-53.93	-7.78	1.32	-63.03	-13.00	-50.03
139.61	43.11	H	-56.43	-7.79	1.42	-65.64	-13.00	-52.64
199.75	43.81	H	-57.97	-7.84	1.56	-67.38	-13.00	-54.38
285.11	47.25	H	-52.74	-7.91	1.99	-62.64	-13.00	-49.64
824.00	82.50	H	-5.16	-7.87	3.64	-16.68	-13.00	-3.68
1648.40	71.43	H	-35.58	9.29	5.06	-31.35	-13.00	-18.35
2463.00	64.38	H	-39.73	10.08	6.28	-35.94	-13.00	-22.94
2472.60	---	H		10.08	6.30		-13.00	
3296.80	48.95	H	-53.41	12.17	7.26	-48.50	-13.00	-35.50
4108.00	42.29	H	-57.41	12.61	8.32	-53.11	-13.00	-40.11
4121.00	---	H		12.61	8.33		-13.00	
4945.20	---	H		12.65	9.19		-13.00	
5769.40	39.11	H	-55.44	13.55	9.80	-51.68	-13.00	-38.68
6593.60	---	H		12.05	10.61		-13.00	
7417.80	---	H		11.49	11.28		-13.00	
8242.00	---	H		11.48	12.26		-13.00	

Measurement uncertainty	30MHz - 80MHz: 5.04dB
	80MHz -1000MHz: 3.76dB
	1GHz - 13GHz: 4.45dB

Remark :

- 1 The emission behaviors belong to narrowband spurious emission.
- 2 Remark"---" means that the emission level is too low to be measured
- 3 The result basic equation calculation is as follows:
- 4 $ERP/EIRP (dBm) = SG \text{ Setting}(dBm) + Antenna \text{ Gain} (dB/dBi) - Cable \text{ loss} (dB)$

Unless otherwise stated the results shown in this test report refer only to the sample(s) tested. This test report cannot be reproduced, except in full, without prior written permission of the Company. 除非另有明，此報告結果僅對測試之樣品負責。本報告未經本公司書面許可，可部份複製。
 This Test Report is issued by the Company under its General Conditions of Service which is available on request or accessible at http://www.sgs.com/terms_and_conditions.htm. Attention is drawn to the limitation of liability, indemnification and jurisdiction issues defined therein. Any holder of this Test Report is advised that information contained hereon reflects the Company's findings at the time of its intervention only and within the limits of Client's instructions, if any. The Company's sole responsibility is to its Client and this document does not exonerate parties to a transaction from exercising all their rights and obligations under the transaction documents. Any unauthorized alteration, forgery or falsification of the content or appearance of this document is unlawful and offenders may be prosecuted to the fullest extent of the law.

Radiated Spurious Emission Measurement Result: GSM 850 Mode

Operation Mode : TX CH Mid H Mode

Test Date: May. 16, 2008

Fundamental Frequency : 836.60 MHz

Test By: Sky

Temperature : 25

Pol: Ver

Humidity : 65%

Freq. (MHz)	SPA. Reading (dBuV)	Ant.Pol. H/V	S.G Out-put (dBm)	Antenna Gain (dB/dBi)	Cable Loss (dB)	ERP/EIRP (dBm)	Limit (dBm)	Safe Margin (dBm)
93.05	63.95	V	-40.24	-7.75	1.18	-49.17	-13.00	-36.17
102.75	64.14	V	-39.23	-7.76	1.23	-48.22	-13.00	-35.22
120.21	40.28	V	-60.96	-7.78	1.32	-70.05	-13.00	-57.05
186.17	40.53	V	-60.33	-7.83	1.54	-69.69	-13.00	-56.69
199.75	48.45	V	-53.63	-7.84	1.56	-63.03	-13.00	-50.03
1673.20	77.34	V	-29.69	9.36	5.10	-25.43	-13.00	-12.43
2498.00	---	V		10.06	6.33		-13.00	
2509.80	61.25	V	-42.63	10.09	6.35	-38.89	-13.00	-25.89
3346.40	---	V		12.28	7.29		-13.00	
4178.00	39.23	V	-60.35	12.62	8.39	-56.12	-13.00	-43.12
4183.00	---	V		12.62	8.40		-13.00	
5019.60	---	V		12.67	9.26		-13.00	
5856.20	---	V		13.68	9.85		-13.00	
6692.80	---	V		11.95	10.74		-13.00	
7529.40	---	V		11.45	11.35		-13.00	
8366.00	---	V		11.59	12.43		-13.00	

Measurement uncertainty	30MHz - 80MHz: 5.04dB
	80MHz - 1000MHz: 3.76dB
	1GHz - 13GHz: 4.45dB

Remark :

- 1 The emission behaviors belongs to narrowband spurious emission.
- 2 Remark"---" means that the emission level is too low to be measured
- 3 The result basic equation calculation is as follows:
- 4 $ERP/EIRP (dBm) = SG \text{ Setting}(dBm) + Antenna \text{ Gain} (dB/dBi) - Cable \text{ loss} (dB)$

Unless otherwise stated the results shown in this test report refer only to the sample(s) tested. This test report cannot be reproduced, except in full, without prior written permission of the Company. 除非另有明，此報告結果僅對測試之樣品負責。本報告未經本公司書面許可，可部份複製。

This Test Report is issued by the Company under its General Conditions of Service which is available on request or accessible at http://www.sgs.com/terms_and_conditions.htm.

Attention is drawn to the limitation of liability, indemnification and jurisdiction issues defined therein. Any holder of this Test Report is advised that information contained hereon reflects the Company's findings at the time of its intervention only and within the limits of Client's instructions, if any. The Company's sole responsibility is to its Client and this document does not exonerate parties to a transaction from exercising all their rights and obligations under the transaction documents. Any unauthorized alteration, forgery or falsification of the content or appearance of this document is unlawful and offenders may be prosecuted to the fullest extent of the law.

Radiated Spurious Emission Measurement Result: GSM 850 Mode

Operation Mode	: TX CH Mid H Mode	Test Date:	May. 16, 2008
Fundamental Frequency	: 836.60 MHz	Test By:	Sky
Temperature	: 25	Pol:	Hor
Humidity	: 65%		

Freq. (MHz)	SPA Reading (dBuV)	Ant.Pol. H/V	S.G Output (dBm)	Antenna Gain (dB/dBi)	Cable Loss (dB)	ERP/EIRP (dBm)	Limit (dBm)	Safe Margin (dBm)
105.66	58.20	H	-44.48	-7.76	1.25	-53.49	-13.00	-40.49
125.06	47.41	H	-53.47	-7.78	1.34	-62.60	-13.00	-49.60
139.61	43.01	H	-56.53	-7.79	1.42	-65.74	-13.00	-52.74
199.75	42.77	H	-59.01	-7.84	1.56	-68.42	-13.00	-55.42
285.11	46.91	H	-53.08	-7.91	1.99	-62.98	-13.00	-49.98
1673.20	61.26	H	-45.74	9.36	5.10	-41.47	-13.00	-28.47
2498.00	---	H		10.06	6.33		-13.00	
2509.80	58.90	H	-44.97	10.09	6.35	-41.23	-13.00	-28.23
3346.40	40.54	H	-61.78	12.28	7.29	-56.80	-13.00	-43.80
4183.00	---	H		12.62	8.40		-13.00	
5019.60	---	H		12.67	9.26		-13.00	
5856.20	---	H		13.68	9.85		-13.00	
6692.80	---	H		11.95	10.74		-13.00	
7529.40	---	H		11.45	11.35		-13.00	
8366.00	---	H		11.59	12.43		-13.00	

Measurement uncertainty	30MHz - 80MHz: 5.04dB
	80MHz - 1000MHz: 3.76dB
	1GHz - 13GHz: 4.45dB

Remark :

- 1 The emission behaviors belong to narrowband spurious emission.
- 2 Remark"---" means that the emission level is too low to be measured
- 3 The result basic equation calculation is as follows:
- 4 $ERP/EIRP (dBm) = SG \text{ Setting}(dBm) + Antenna \text{ Gain} (dB/dBi) - Cable \text{ loss} (dB)$

Unless otherwise stated the results shown in this test report refer only to the sample(s) tested. This test report cannot be reproduced, except in full, without prior written permission of the Company. 除非另有明，此報告結果僅對測試之樣品負責。本報告未經本公司書面許可，可部份複製。
 This Test Report is issued by the Company under its General Conditions of Service which is available on request or accessible at http://www.sgs.com/terms_and_conditions.htm. Attention is drawn to the limitation of liability, indemnification and jurisdiction issues defined therein. Any holder of this Test Report is advised that information contained hereon reflects the Company's findings at the time of its intervention only and within the limits of Client's instructions, if any. The Company's sole responsibility is to its Client and this document does not exonerate parties to a transaction from exercising all their rights and obligations under the transaction documents. Any unauthorized alteration, forgery or falsification of the content or appearance of this document is unlawful and offenders may be prosecuted to the fullest extent of the law.

Radiated Spurious Emission Measurement Result: GSM 850 Mode

Operation Mode	: TX CH High H Mode	Test Date:	May. 16, 2008
Fundamental Frequency	: 848.80 MHz	Test By:	Sky
Temperature	: 25	Pol:	Ver
Humidity	: 65%		

Freq. (MHz)	SPA. Reading (dBuV)	Ant.Pol. H/V	S.G Out-put (dBm)	Antenna Gain (dB/dBi)	Cable Loss (dB)	ERP/EIRP (dBm)	Limit (dBm)	Safe Margin (dBm)
102.75	64.59	V	-38.78	-7.76	1.23	-47.77	-13.00	-34.77
113.42	54.30	V	-47.77	-7.77	1.28	-56.82	-13.00	-43.82
127.97	41.29	V	-59.00	-7.78	1.36	-68.14	-13.00	-55.14
199.75	45.78	V	-56.30	-7.84	1.56	-65.70	-13.00	-52.70
248.25	45.52	V	-55.23	-7.89	1.97	-65.09	-13.00	-52.09
850.00	79.88	V	-6.83	-7.88	3.75	-18.46	-13.00	-5.46
1697.60	66.06	V	-40.96	9.44	5.14	-36.67	-13.00	-23.67
2533.00	---	V		10.16	6.38		-13.00	
2546.40	50.28	V	-53.51	10.20	6.40	-49.71	-13.00	-36.71
3395.20	46.68	V	-55.86	12.38	7.33	-50.81	-13.00	-37.81
4244.00	---	V		12.63	8.46		-13.00	
5088.00	---	V		12.74	9.31		-13.00	
5092.80	---	V		12.74	9.32		-13.00	
5941.60	---	V		13.81	9.89		-13.00	
6790.40	---	V		11.86	10.87		-13.00	
7639.20	---	V		11.40	11.48		-13.00	
8488.00	---	V		11.70	12.59		-13.00	

Measurement uncertainty	30MHz - 80MHz: 5.04dB
	80MHz - 1000MHz: 3.76dB
	1GHz - 13GHz: 4.45dB

Remark :

- 1 The emission behaviors belong to narrowband spurious emission.
- 2 Remark"---" means that the emission level is too low to be measured
- 3 The result basic equation calculation is as follows:
- 4 $ERP/EIRP (dBm) = SG \text{ Setting}(dBm) + Antenna \text{ Gain} (dB/dBi) - Cable \text{ loss} (dB)$

Unless otherwise stated the results shown in this test report refer only to the sample(s) tested. This test report cannot be reproduced, except in full, without prior written permission of the Company. 除非另有明，此報告結果僅對測試之樣品負責。本報告未經本公司書面許可，可部份複製。
 This Test Report is issued by the Company under its General Conditions of Service which is available on request or accessible at http://www.sgs.com/terms_and_conditions.htm. Attention is drawn to the limitation of liability, indemnification and jurisdiction issues defined therein. Any holder of this Test Report is advised that information contained hereon reflects the Company's findings at the time of its intervention only and within the limits of Client's instructions, if any. The Company's sole responsibility is to its Client and this document does not exonerate parties to a transaction from exercising all their rights and obligations under the transaction documents. Any unauthorized alteration, forgery or falsification of the content or appearance of this document is unlawful and offenders may be prosecuted to the fullest extent of the law.

Radiated Spurious Emission Measurement Result: GSM 850 Mode

Operation Mode	: TX CH High H Mode	Test Date:	May. 16, 2008
Fundamental Frequency	: 848.80 MHz	Test By:	Sky
Temperature	: 25	Pol:	Hor
Humidity	: 65%		

Freq. (MHz)	SPA. Reading (dBuV)	Ant.Pol. H/V	S.G Output (dBm)	Antenna Gain (dB/dBi)	Cable Loss (dB)	ERP/EIRP (dBm)	Limit (dBm)	Safe Margin (dBm)
102.75	54.48	H	-48.47	-7.76	1.23	-57.46	-13.00	-44.46
125.06	46.68	H	-54.20	-7.78	1.34	-63.33	-13.00	-50.33
139.61	44.58	H	-54.96	-7.79	1.42	-64.17	-13.00	-51.17
199.75	42.13	H	-59.65	-7.84	1.56	-69.06	-13.00	-56.06
285.11	45.70	H	-54.29	-7.91	1.99	-64.19	-13.00	-51.19
850.00	82.55	H	-4.44	-7.88	3.75	-16.07	-13.00	-3.07
1697.60	75.61	H	-31.37	9.44	5.14	-27.08	-13.00	-14.08
2533.00	49.40	H	-54.41	10.16	6.38	-50.64	-13.00	-37.64
2546.40	---	H		10.20	6.40		-13.00	
3395.20	38.11	H	-64.17	12.38	7.33	-59.12	-13.00	-46.12
4244.00	---	H		12.63	8.46		-13.00	
5088.00	---	H		12.74	9.31		-13.00	
5092.80	---	H		12.74	9.32		-13.00	
5941.60	---	H		13.81	9.89		-13.00	
6790.40	---	H		11.86	10.87		-13.00	
7639.20	---	H		11.40	11.48		-13.00	
8488.00	---	H		11.70	12.59		-13.00	

Measurement uncertainty	30MHz - 80MHz: 5.04dB
	80MHz - 1000MHz: 3.76dB
	1GHz - 13GHz: 4.45dB

Remark :

- 1 The emission behaviors belong to narrowband spurious emission.
- 2 Remark"---" means that the emission level is too low to be measured
- 3 The result basic equation calculation is as follows:
- 4 $ERP/EIRP (dBm) = SG \text{ Setting}(dBm) + Antenna \text{ Gain} (dB/dBi) - Cable \text{ loss} (dB)$

Unless otherwise stated the results shown in this test report refer only to the sample(s) tested. This test report cannot be reproduced, except in full, without prior written permission of the Company. 除非另有明，此報告結果僅對測試之樣品負責。本報告未經本公司書面許可，可部份複製。
 This Test Report is issued by the Company under its General Conditions of Service which is available on request or accessible at http://www.sgs.com/terms_and_conditions.htm. Attention is drawn to the limitation of liability, indemnification and jurisdiction issues defined therein. Any holder of this Test Report is advised that information contained hereon reflects the Company's findings at the time of its intervention only and within the limits of Client's instructions, if any. The Company's sole responsibility is to its Client and this document does not exonerate parties to a transaction from exercising all their rights and obligations under the transaction documents. Any unauthorized alteration, forgery or falsification of the content or appearance of this document is unlawful and offenders may be prosecuted to the fullest extent of the law.

Radiated Spurious Emission Measurement Result: PCS 1900 Mode

Operation Mode	: TX CH Low H Mode	Test Date:	May. 16, 2008
Fundamental Frequency	: 1850.20MHz	Test By:	Sky
Temperature	: 25	Pol:	Ver
Humidity	: 65%		

Freq. (MHz)	SPA. Reading (dBuV)	Ant.Pol. H/V	S.G Out-put (dBm)	Antenna Gain (dB/dBi)	Cable Loss (dB)	ERP/EIRP (dBm)	Limit (dBm)	Safe Margin (dBm)
35.82	50.30	V	-52.71	-4.61	0.74	-58.07	-13.00	-45.07
73.65	49.50	V	-62.12	-1.58	1.04	-64.74	-13.00	-51.74
125.06	40.25	V	-60.40	-7.78	1.34	-69.52	-13.00	-56.52
154.16	34.52	V	-63.46	-7.80	1.47	-72.74	-13.00	-59.74
215.27	38.24	V	-63.43	-7.86	1.69	-72.98	-13.00	-59.98
1850.00	80.27	V	-26.69	9.90	5.41	-22.20	-13.00	-9.20
3688.00	52.41	V	-49.23	12.61	7.71	-44.33	-13.00	-31.33
3700.40	---	V		12.61	7.73		-13.00	
5543.00	---	V		13.21	9.68		-13.00	
5550.60	---	V		13.23	9.68		-13.00	
7400.80	---	V		11.50	11.28		-13.00	
9251.00	---	V		11.92	13.10		-13.00	
11101.20	---	V		11.66	14.33		-13.00	
12951.40	---	V		13.63	15.98		-13.00	
14801.60	---	V		12.76	17.27		-13.00	
16651.80	---	V		15.92	19.04		-13.00	
18502.00	---	V		18.75	21.21		-13.00	

Measurement uncertainty	30MHz - 80MHz: 5.04dB
	80MHz -1000MHz: 3.76dB
	1GHz - 13GHz: 4.45dB

Remark :

- 1 The emission behaviors belong to narrowband spurious emission.
- 2 Remark"---" means that the emission level is too low to be measured
- 3 The result basic equation calculation is as follows:
- 4 $ERP/EIRP (dBm) = SG \text{ Setting}(dBm) + Antenna \text{ Gain} (dB/dBi) - Cable \text{ loss} (dB)$

Unless otherwise stated the results shown in this test report refer only to the sample(s) tested. This test report cannot be reproduced, except in full, without prior written permission of the Company. 除非另有明，此報告結果僅對測試之樣品負責。本報告未經本公司書面許可，可部份複製。
 This Test Report is issued by the Company under its General Conditions of Service which is available on request or accessible at http://www.sgs.com/terms_and_conditions.htm. Attention is drawn to the limitation of liability, indemnification and jurisdiction issues defined therein. Any holder of this Test Report is advised that information contained hereon reflects the Company's findings at the time of its intervention only and within the limits of Client's instructions, if any. The Company's sole responsibility is to its Client and this document does not exonerate parties to a transaction from exercising all their rights and obligations under the transaction documents. Any unauthorized alteration, forgery or falsification of the content or appearance of this document is unlawful and offenders may be prosecuted to the fullest extent of the law.

Radiated Spurious Emission Measurement Result: PCS 1900 Mode

Operation Mode	: TX CH Low H Mode	Test Date:	May. 16, 2008
Fundamental Frequency	: 1850.20MHz	Test By:	Sky
Temperature	: 25	Pol:	Hor
Humidity	: 65%		

Freq. (MHz)	SPA. Reading (dBuV)	Ant.Pol. H/V	S.G Out-put (dBm)	Antenna Gain (dB/dBi)	Cable Loss (dB)	ERP/EIRP (dBm)	Limit (dBm)	Safe Margin (dBm)
35.82	44.87	H	-59.23	-4.61	0.74	-64.58	-13.00	-51.58
60.07	39.17	H	-72.04	-0.46	0.95	-73.45	-13.00	-60.45
125.06	46.51	H	-54.37	-7.78	1.34	-63.50	-13.00	-50.50
205.57	40.98	H	-60.72	-7.85	1.61	-70.17	-13.00	-57.17
261.16	37.03	H	-63.58	-7.90	1.99	-73.46	-13.00	-60.46
1850.00	80.57	H	-26.32	9.90	5.41	-21.83	-13.00	-8.83
3688.00	55.30	H	-46.11	12.61	7.71	-41.21	-13.00	-28.21
3700.40	---	H		12.61	7.73		-13.00	
5543.00	---	H		13.21	9.68		-13.00	
5550.60	---	H		13.23	9.68		-13.00	
7400.80	---	H		11.50	11.28		-13.00	
9251.00	---	H		11.92	13.10		-13.00	
11101.20	---	H		11.66	14.33		-13.00	
12951.40	---	H		13.63	15.98		-13.00	
14801.60	---	H		12.76	17.27		-13.00	
16651.80	---	H		15.92	19.04		-13.00	
18502.00	---	H		18.75	21.21		-13.00	

Measurement uncertainty	30MHz - 80MHz: 5.04dB
	80MHz -1000MHz: 3.76dB
	1GHz - 13GHz: 4.45dB

Remark :

- 1 The emission behaviors belong to narrowband spurious emission.
- 2 Remark"---" means that the emission level is too low to be measured
- 3 The result basic equation calculation is as follows:
- 4 $ERP/EIRP (dBm) = SG \text{ Setting}(dBm) + Antenna \text{ Gain} (dB/dBi) - Cable \text{ loss} (dB)$

Unless otherwise stated the results shown in this test report refer only to the sample(s) tested. This test report cannot be reproduced, except in full, without prior written permission of the Company. 除非另有明，此報告結果僅對測試之樣品負責。本報告未經本公司書面許可，可部份複製。
 This Test Report is issued by the Company under its General Conditions of Service which is available on request or accessible at http://www.sgs.com/terms_and_conditions.htm. Attention is drawn to the limitation of liability, indemnification and jurisdiction issues defined therein. Any holder of this Test Report is advised that information contained hereon reflects the Company's findings at the time of its intervention only and within the limits of Client's instructions, if any. The Company's sole responsibility is to its Client and this document does not exonerate parties to a transaction from exercising all their rights and obligations under the transaction documents. Any unauthorized alteration, forgery or falsification of the content or appearance of this document is unlawful and offenders may be prosecuted to the fullest extent of the law.

Radiated Spurious Emission Measurement Result: PCS 1900 Mode

Operation Mode	: TX CH Mid H Mode	Test Date:	May. 16, 2008
Fundamental Frequency	: 1880MHz	Test By:	Sky
Temperature	: 25	Pol:	Ver
Humidity	: 65%		

Freq. (MHz)	SPA. Reading (dBuV)	Ant.Pol. H/V	S.G Out-put (dBm)	Antenna Gain (dB/dBi)	Cable Loss (dB)	ERP/EIRP (dBm)	Limit (dBm)	Safe Margin (dBm)
49.40	46.67	V	-60.02	-0.72	0.89	-61.64	-13.00	-48.64
62.01	39.73	V	-71.67	-0.58	0.96	-73.21	-13.00	-60.21
120.21	41.01	V	-60.23	-7.78	1.32	-69.32	-13.00	-56.32
154.16	34.85	V	-63.13	-7.80	1.47	-72.41	-13.00	-59.41
205.57	38.41	V	-63.53	-7.85	1.61	-72.99	-13.00	-59.99
3760.00	66.19	V	-35.11	12.60	7.82	-30.33	-13.00	-17.33
5640.00	39.19	V	-55.77	13.36	9.73	-52.14	-13.00	-39.14
5634.00	---	V		13.35	9.73		-13.00	
7520.00	---	V		11.45	11.33		-13.00	
9400.00	---	V		11.93	13.15		-13.00	
11280.00	---	V		11.92	14.56		-13.00	
13160.00	---	V		13.33	16.11		-13.00	
15040.00	---	V		13.76	17.57		-13.00	
16920.00	---	V		15.27	19.66		-13.00	
18800.00	---	V		18.68	21.34		-13.00	

Measurement uncertainty	30MHz - 80MHz: 5.04dB
	80MHz - 1000MHz: 3.76dB
	1GHz - 13GHz: 4.45dB

Remark :

- 1 The emission behaviors belong to narrowband spurious emission.
- 2 Remark"---" means that the emission level is too low to be measured
- 3 The result basic equation calculation is as follows:
- 4 $ERP/EIRP (dBm) = SG \text{ Setting}(dBm) + Antenna \text{ Gain} (dB/dBi) - Cable \text{ loss} (dB)$

Unless otherwise stated the results shown in this test report refer only to the sample(s) tested. This test report cannot be reproduced, except in full, without prior written permission of the Company. 除非另有明，此報告結果僅對測試之樣品負責。本報告未經本公司書面許可，可部份複製。
 This Test Report is issued by the Company under its General Conditions of Service which is available on request or accessible at http://www.sgs.com/terms_and_conditions.htm. Attention is drawn to the limitation of liability, indemnification and jurisdiction issues defined therein. Any holder of this Test Report is advised that information contained hereon reflects the Company's findings at the time of its intervention only and within the limits of Client's instructions, if any. The Company's sole responsibility is to its Client and this document does not exonerate parties to a transaction from exercising all their rights and obligations under the transaction documents. Any unauthorized alteration, forgery or falsification of the content or appearance of this document is unlawful and offenders may be prosecuted to the fullest extent of the law.

Radiated Spurious Emission Measurement Result: PCS 1900 Mode

Operation Mode	: TX CH Mid H Mode	Test Date:	May. 16, 2008
Fundamental Frequency	: 1880MHz	Test By:	Sky
Temperature	: 25	Pol:	Hor
Humidity	: 65%		

Freq. (MHz)	SPA. Reading (dBuV)	Ant.Pol. H/V	S.G Output (dBm)	Antenna Gain (dB/dBi)	Cable Loss (dB)	ERP/EIRP (dBm)	Limit (dBm)	Safe Margin (dBm)
35.82	46.52	H	-57.58	-4.61	0.74	-62.93	-13.00	-49.93
125.06	46.39	H	-54.49	-7.78	1.34	-63.62	-13.00	-50.62
139.61	42.65	H	-56.89	-7.79	1.42	-66.10	-13.00	-53.10
212.36	40.47	H	-61.11	-7.85	1.67	-70.63	-13.00	-57.63
280.26	37.14	H	-62.98	-7.91	1.99	-72.87	-13.00	-59.87
3760.00	64.42	H	-36.69	12.60	7.82	-31.90	-13.00	-18.90
5634.00	---	H		13.35	9.73		-13.00	
5640.00	38.65	H	-56.24	13.36	9.73	-52.61	-13.00	-39.61
7520.00	---	H		11.45	11.33		-13.00	
9400.00	---	H		11.93	13.15		-13.00	
11280.00	---	H		11.92	14.56		-13.00	
13160.00	---	H		13.33	16.11		-13.00	
15040.00	---	H		13.76	17.57		-13.00	
16920.00	---	H		15.27	19.66		-13.00	
18800.00	---	H		18.68	21.34		-13.00	

Measurement uncertainty	30MHz - 80MHz: 5.04dB
	80MHz - 1000MHz: 3.76dB
	1GHz - 13GHz: 4.45dB

Remark :

- 1 The emission behaviors belong to narrowband spurious emission.
- 2 Remark"---" means that the emission level is too low to be measured
- 3 The result basic equation calculation is as follows:
- 4 $ERP/EIRP (dBm) = SG \text{ Setting}(dBm) + Antenna \text{ Gain} (dB/dBi) - Cable \text{ loss} (dB)$

Unless otherwise stated the results shown in this test report refer only to the sample(s) tested. This test report cannot be reproduced, except in full, without prior written permission of the Company. 除非另有明，此報告結果僅對測試之樣品負責。本報告未經本公司書面許可，可部份複製。
 This Test Report is issued by the Company under its General Conditions of Service which is available on request or accessible at http://www.sgs.com/terms_and_conditions.htm. Attention is drawn to the limitation of liability, indemnification and jurisdiction issues defined therein. Any holder of this Test Report is advised that information contained hereon reflects the Company's findings at the time of its intervention only and within the limits of Client's instructions, if any. The Company's sole responsibility is to its Client and this document does not exonerate parties to a transaction from exercising all their rights and obligations under the transaction documents. Any unauthorized alteration, forgery or falsification of the content or appearance of this document is unlawful and offenders may be prosecuted to the fullest extent of the law.

Radiated Spurious Emission Measurement Result: PCS 1900 Mode

Operation Mode	: TX CH High H Mode	Test Date:	May. 16, 2008
Fundamental Frequency	: 1909.8 MHz	Test By:	Sky
Temperature	: 25	Pol:	Ver
Humidity	: 65%		

Freq. (MHz)	SPA. Reading (dBuV)	Ant.Pol. H/V	S.G Out-put (dBm)	Antenna Gain (dB/dBi)	Cable Loss (dB)	ERP/EIRP (dBm)	Limit (dBm)	Safe Margin (dBm)
49.40	47.85	V	-58.84	-0.72	0.89	-60.46	-13.00	-47.46
62.01	39.22	V	-72.18	-0.58	0.96	-73.72	-13.00	-60.72
120.21	41.05	V	-60.19	-7.78	1.32	-69.28	-13.00	-56.28
154.16	35.04	V	-62.94	-7.80	1.47	-72.22	-13.00	-59.22
205.57	39.21	V	-62.73	-7.85	1.61	-72.19	-13.00	-59.19
1910.00	80.15	V	-26.79	10.08	5.51	-22.22	-13.00	-9.22
3814.00	48.49	V	-52.57	12.60	7.91	-47.87	-13.00	-34.87
3981.60	---	V		12.60	8.17		-13.00	
5718.00	---	V		13.48	9.77		-13.00	
5972.40	---	V		13.86	9.91		-13.00	
7963.20	---	V		11.27	11.88		-13.00	
9954.00	---	V		12.08	13.43		-13.00	
11944.80	---	V		13.08	15.21		-13.00	
13935.60	---	V		11.82	16.86		-13.00	
15926.40	---	V		17.08	18.33		-13.00	
17917.20	---	V		9.63	20.12		-13.00	
19908.00	---	V		18.88	20.85		-13.00	

Measurement uncertainty	30MHz - 80MHz: 5.04dB
	80MHz - 1000MHz: 3.76dB
	1GHz - 13GHz: 4.45dB

Remark :

- 1 The emission behaviors belong to narrowband spurious emission.
- 2 Remark"---" means that the emission level is too low to be measured
- 3 The result basic equation calculation is as follows:
- 4 ERP/EIRP (dBm) = SG Setting(dBm) + Antenna Gain (dB/dBi) – Cable loss (dB)

Unless otherwise stated the results shown in this test report refer only to the sample(s) tested. This test report cannot be reproduced, except in full, without prior written permission of the Company. 除非另有明，此報告結果僅對測試之樣品負責。本報告未經本公司書面許可，可部份複製。
 This Test Report is issued by the Company under its General Conditions of Service which is available on request or accessible at http://www.sgs.com/terms_and_conditions.htm. Attention is drawn to the limitation of liability, indemnification and jurisdiction issues defined therein. Any holder of this Test Report is advised that information contained hereon reflects the Company's findings at the time of its intervention only and within the limits of Client's instructions, if any. The Company's sole responsibility is to its Client and this document does not exonerate parties to a transaction from exercising all their rights and obligations under the transaction documents. Any unauthorized alteration, forgery or falsification of the content or appearance of this document is unlawful and offenders may be prosecuted to the fullest extent of the law.

Radiated Spurious Emission Measurement Result: PCS 1900 Mode

Operation Mode	: TX CH High H Mode	Test Date:	May. 16, 2008
Fundamental Frequency	: 1909.8 MHz	Test By:	Sky
Temperature	: 25	Pol:	Hor
Humidity	: 65%		

Freq. (MHz)	SPA Reading (dBuV)	Ant.Pol. H/V	S.G Output (dBm)	Antenna Gain (dB/dBi)	Cable Loss (dB)	ERP/EIRP (dBm)	Limit (dBm)	Safe Margin (dBm)
35.82	45.06	H	-59.04	-4.61	0.74	-64.39	-13.00	-51.39
125.06	45.82	H	-55.06	-7.78	1.34	-64.19	-13.00	-51.19
215.27	39.69	H	-61.84	-7.86	1.69	-71.38	-13.00	-58.38
251.16	37.96	H	-62.91	-7.89	1.99	-72.79	-13.00	-59.79
280.26	36.76	H	-63.36	-7.91	1.99	-73.25	-13.00	-60.25
1910.00	81.14	H	-25.71	10.08	5.51	-21.15	-13.00	-8.15
3968.00	50.38	H	-49.85	12.60	8.15	-45.40	-13.00	-32.40
3981.60	---	H		12.60	8.17		-13.00	
5718.00	---	H		13.48	9.77		-13.00	
5972.40	---	H		13.86	9.91		-13.00	
7963.20	---	H		11.27	11.88		-13.00	
9954.00	---	H		12.08	13.43		-13.00	
11944.80	---	H		13.08	15.21		-13.00	
13935.60	---	H		11.82	16.86		-13.00	
15926.40	---	H		17.08	18.33		-13.00	
17917.20	---	H		9.63	20.12		-13.00	
19908.00	---	H		18.88	20.85		-13.00	

Measurement uncertainty	30MHz - 80MHz: 5.04dB
	80MHz - 1000MHz: 3.76dB
	1GHz - 13GHz: 4.45dB

Remark :

- 1 The emission behaviors belong to narrowband spurious emission.
- 2 Remark"---" means that the emission level is too low to be measured
- 3 The result basic equation calculation is as follows:
- 4 $ERP/EIRP (dBm) = SG \text{ Setting}(dBm) + Antenna \text{ Gain} (dB/dBi) - Cable \text{ loss} (dB)$

Unless otherwise stated the results shown in this test report refer only to the sample(s) tested. This test report cannot be reproduced, except in full, without prior written permission of the Company. 除非另有明，此報告結果僅對測試之樣品負責。本報告未經本公司書面許可，可部份複製。
 This Test Report is issued by the Company under its General Conditions of Service which is available on request or accessible at http://www.sgs.com/terms_and_conditions.htm. Attention is drawn to the limitation of liability, indemnification and jurisdiction issues defined therein. Any holder of this Test Report is advised that information contained hereon reflects the Company's findings at the time of its intervention only and within the limits of Client's instructions, if any. The Company's sole responsibility is to its Client and this document does not exonerate parties to a transaction from exercising all their rights and obligations under the transaction documents. Any unauthorized alteration, forgery or falsification of the content or appearance of this document is unlawful and offenders may be prosecuted to the fullest extent of the law.

FREQUENCY STABILITY V.S. TEMPERATURE MEASUREMENT

10.1. Standard Applicable

According to FCC §2.1055(a)(1)(b).

Frequency Tolerance: +/-0.1 ppm for 850MHz band

+/-0.04 ppm for 1900MHz band

10.2. Test Set-up:

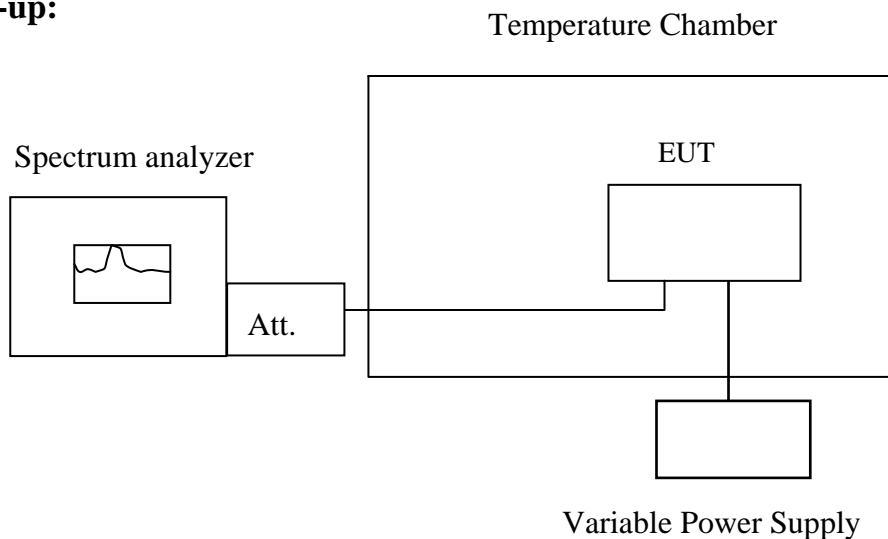

Note : Measurement setup for testing on Antenna connector

10.3. Measurement Procedure

The equipment under test was connected to an external AC or DC power supply and input rated voltage. RF output was connected to a frequency counter or spectrum analyzer via feed through attenuators. The EUT was placed inside the temperature chamber. Set the spectrum analyzer RBW low enough to obtain the desired frequency resolution and measure EUT 25°C operating frequency as reference frequency. Turn EUT off and set the chamber temperature to -30°C. After the temperature stabilized for approximately 30 minutes recorded the frequency. Repeat step measure with 10°C increased per stage until the highest temperature of +50°C reached.

Unless otherwise stated the results shown in this test report refer only to the sample(s) tested. This test report cannot be reproduced, except in full, without prior written permission of the Company. 除非另有明，此報告結果僅對測試之樣品負責。本報告未經本公司書面許可，可部份複製。
 This Test Report is issued by the Company under its General Conditions of Service which is available on request or accessible at http://www.sgs.com/terms_and_conditions.htm. Attention is drawn to the limitation of liability, indemnification and jurisdiction issues defined therein. Any holder of this Test Report is advised that information contained hereon reflects the Company's findings at the time of its intervention only and within the limits of Client's instructions, if any. The Company's sole responsibility is to its Client and this document does not exonerate parties to a transaction from exercising all their rights and obligations under the transaction documents. Any unauthorized alteration, forgery or falsification of the content or appearance of this document is unlawful and offenders may be prosecuted to the fullest extent of the law.

10.4. Measurement Equipment Used:

Conducted Emission Test Site					
EQUIPMENT TYPE	MFR	MODEL NUMBER	SERIAL NUMBER	LAST CAL.	CAL DUE.
Spectrum Analyzer	Agilent	E4446A	MY43360126	04/27/2008	04/27/2009
Spectrum Analyzer	Agilent	E7405A	US41160416	07/04/2007	07/03/2008
Spectrum Analyzer	R&S	FSP 40	100034	01/05/2008	01/04/2009
Communication Test	R&S	SMU200	N/A	N/A	N/A
Power Sensor	Anritsu	MA2490A	31431	07/07/2007	07/06/2008
Power Meter	Anritsu	ML2487A	6K00002070	07/07/2007	07/06/2008
Temperature Chamber	TERCHY	MHG-120LF	911009	04/26/2008	04/25/2009
Low Loss Cable	HUBER+SUHNER	SUCOFLEX 104PEA	N/A	N/A	N/A
Attenuator	Mini-Circuit	BW-S10W5	N/A	07/05/2007	07/04/2008
Attenuator	Mini-Circuit	BW-S6W5	N/A	07/05/2007	07/04/2008
Splitter	Agilent	11636B	51728	07/05/2007	07/04/2008

Unless otherwise stated the results shown in this test report refer only to the sample(s) tested. This test report cannot be reproduced, except in full, without prior written permission of the Company. 除非另有明，此報告結果僅對測試之樣品負責。本報告未經本公司書面許可，可部份複製。

This Test Report is issued by the Company under its General Conditions of Service which is available on request or accessible at http://www.sgs.com/terms_and_conditions.htm.

Attention is drawn to the limitation of liability, indemnification and jurisdiction issues defined therein. Any holder of this Test Report is advised that information contained hereon reflects the Company's findings at the time of its intervention only and within the limits of Client's instructions, if any. The Company's sole responsibility is to its Client and this document does not exonerate parties to a transaction from exercising all their rights and obligations under the transaction documents. Any unauthorized alteration, forgery or falsification of the content or appearance of this document is unlawful and offenders may be prosecuted to the fullest extent of the law.

10.5. Measurement Result

Reference Frequency: GSM Mid Channel 836.6 MHz @ 25°C				
Limit: +/- 0.1 ppm = 83.6 Hz				
Power Supply	Environment	Frequency	Delta (Hz)	Limit (Hz)
Vdc	Temperature (°C)	(MHz)		
12	-30	836.599980	10.00	83.6
12	-20	836.599984	6.00	83.6
12	-10	836.599990	0.00	83.6
12	0	836.599993	-3.00	83.6
12	10	836.599985	5.00	83.6
12	20	836.599990	0.00	83.6
12	30	836.599991	-1.00	83.6
12	40	836.599988	2.00	83.6
12	50	836.599990	0.00	83.6

Reference Frequency: PCS Mid Channel 1880 MHz @ 25°C				
Limit: +/- 0.04 ppm = 75.2 Hz				
Power Supply	Environment	Frequency	Delta (Hz)	Limit (Hz)
Vdc	Temperature (°C)	(MHz)		
12	-30	1879.999952	20.00	75.2
12	-20	1879.999970	2.00	75.2
12	-10	1879.999977	-5.00	75.2
12	0	1879.999943	29.00	75.2
12	10	1879.999964	8.00	75.2
12	20	1879.999972	0.00	75.2
12	30	1879.999951	21.00	75.2
12	40	1879.999973	-1.00	75.2
12	50	1879.999960	12.00	75.2

Unless otherwise stated the results shown in this test report refer only to the sample(s) tested. This test report cannot be reproduced, except in full, without prior written permission of the Company. 除非另有明，此報告結果僅對測試之樣品負責。本報告未經本公司書面許可，可部份複製。
 This Test Report is issued by the Company under its General Conditions of Service which is available on request or accessible at http://www.sgs.com/terms_and_conditions.htm. Attention is drawn to the limitation of liability, indemnification and jurisdiction issues defined therein. Any holder of this Test Report is advised that information contained hereon reflects the Company's findings at the time of its intervention only and within the limits of Client's instructions, if any. The Company's sole responsibility is to its Client and this document does not exonerate parties to a transaction from exercising all their rights and obligations under the transaction documents. Any unauthorized alteration, forgery or falsification of the content or appearance of this document is unlawful and offenders may be prosecuted to the fullest extent of the law.

FREQUENCY STABILITY V.S. VOLTAGE MEASUREMENT

11.1. Standard Applicable

According to FCC §2.1055(d)(1)(2)

Frequency Tolerance: +/-0.1ppm for 850MHz band

+/-0.04ppm for 1900MHz band

11.2. Test Set-up:

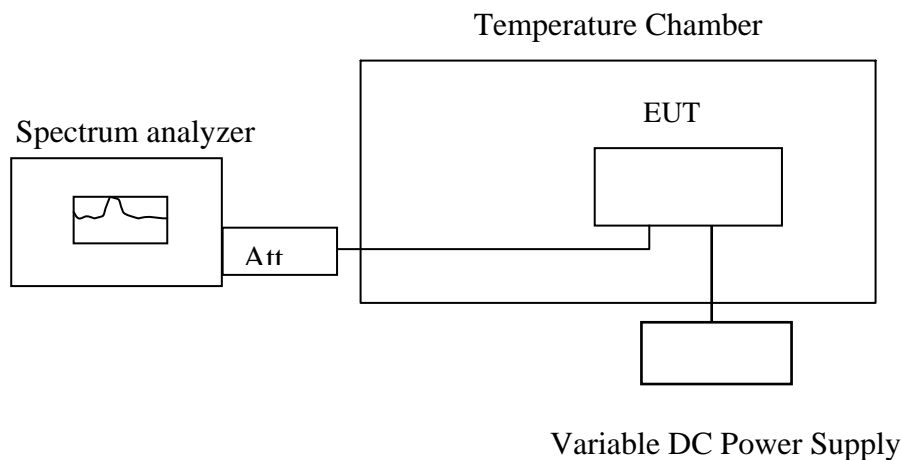

Note: Measurement setup for testing on Antenna connector

11.3. Measurement Procedure

Set chamber temperature to 25°C. Use a variable AC power supply / DC power source to power the EUT and set the voltage to rated voltage. Set the spectrum analyzer RBW low enough to obtain the desired frequency resolution and recorded the frequency.

Reduce the input voltage to specified extreme voltage variation (+/- 15%) and endpoint, record the maximum frequency change.

Unless otherwise stated the results shown in this test report refer only to the sample(s) tested. This test report cannot be reproduced, except in full, without prior written permission of the Company. 除非另有明，此報告結果僅對測試之樣品負責。本報告未經本公司書面許可，可部份複製。

This Test Report is issued by the Company under its General Conditions of Service which is available on request or accessible at http://www.sgs.com/terms_and_conditions.htm. Attention is drawn to the limitation of liability, indemnification and jurisdiction issues defined therein. Any holder of this Test Report is advised that information contained hereon reflects the Company's findings at the time of its intervention only and within the limits of Client's instructions, if any. The Company's sole responsibility is to its Client and this document does not exonerate parties to a transaction from exercising all their rights and obligations under the transaction documents. Any unauthorized alteration, forgery or falsification of the content or appearance of this document is unlawful and offenders may be prosecuted to the fullest extent of the law.

11.4. Measurement Equipment Used:

Conducted Emission Test Site					
EQUIPMENT TYPE	MFR	MODEL NUMBER	SERIAL NUMBER	LAST CAL.	CAL DUE.
Spectrum Analyzer	Agilent	E4446A	MY43360126	04/27/2008	04/27/2009
Spectrum Analyzer	Agilent	E7405A	US41160416	07/04/2007	07/03/2008
Spectrum Analyzer	R&S	FSP 40	100034	01/05/2008	01/04/2009
Communication Test	R&S	SMU200	N/A	N/A	N/A
Power Sensor	Anritsu	MA2490A	31431	07/07/2007	07/06/2008
Power Meter	Anritsu	ML2487A	6K00002070	07/07/2007	07/06/2008
Temperature Chamber	TERCHY	MHG-120LF	911009	04/26/2008	04/25/2009
Low Loss Cable	HUBER+SUHNER	SUCOFLEX 104PEA	N/A	N/A	N/A
Attenuator	Mini-Circuit	BW-S10W5	N/A	07/05/2007	07/04/2008
Attenuator	Mini-Circuit	BW-S6W5	N/A	07/05/2007	07/04/2008
Splitter	Agilent	11636B	51728	07/05/2007	07/04/2008

Unless otherwise stated the results shown in this test report refer only to the sample(s) tested. This test report cannot be reproduced, except in full, without prior written permission of the Company. 除非另有明，此報告結果僅對測試之樣品負責。本報告未經本公司書面許可，可部份複製。

This Test Report is issued by the Company under its General Conditions of Service which is available on request or accessible at http://www.sgs.com/terms_and_conditions.htm. Attention is drawn to the limitation of liability, indemnification and jurisdiction issues defined therein. Any holder of this Test Report is advised that information contained hereon reflects the Company's findings at the time of its intervention only and within the limits of Client's instructions, if any. The Company's sole responsibility is to its Client and this document does not exonerate parties to a transaction from exercising all their rights and obligations under the transaction documents. Any unauthorized alteration, forgery or falsification of the content or appearance of this document is unlawful and offenders may be prosecuted to the fullest extent of the law.

11.5. Measurement Result

Reference Frequency: GSM Mid Channel 836.6 MHz @ 25°C				
Limit: +/- 0.1 ppm = 83.6 Hz				
Power Supply	Environment	Frequency	Delta (Hz)	Limit (Hz)
Vdc	Temperature (°C)	(MHz)		
13.80	25.00	836.599994	0.00	83.6
12.00	25.00	836.599990	4.00	83.6
10.20	25.00	836.600005	-11.00	83.6
9 (End Point)	25.00	836.600004	-10.00	83.6

Reference Frequency: PCS Mid Channel 1880 MHz @ 25°C				
Limit: +/- 0.04 ppm = 75.2 Hz				
Power Supply	Environment	Frequency	Delta (Hz)	Limit (Hz)
Vdc	Temperature (°C)	(MHz)		
13.8	25	1879.999979	0.00	75.2
12	25	1879.999972	7.00	75.2
10.2	25	1879.999984	-5.00	75.2
9 (Endpoint)	25	1879.999980	-1.00	75.2

Unless otherwise stated the results shown in this test report refer only to the sample(s) tested. This test report cannot be reproduced, except in full, without prior written permission of the Company. 除非另有明，此報告結果僅對測試之樣品負責。本報告未經本公司書面許可，可部份複製。

This Test Report is issued by the Company under its General Conditions of Service which is available on request or accessible at http://www.sgs.com/terms_and_conditions.htm. Attention is drawn to the limitation of liability, indemnification and jurisdiction issues defined therein. Any holder of this Test Report is advised that information contained hereon reflects the Company's findings at the time of its intervention only and within the limits of Client's instructions, if any. The Company's sole responsibility is to its Client and this document does not exonerate parties to a transaction from exercising all their rights and obligations under the transaction documents. Any unauthorized alteration, forgery or falsification of the content or appearance of this document is unlawful and offenders may be prosecuted to the fullest extent of the law.

AC POWER LINE CONDUCTED EMISSION TEST

12.1. Standard Applicable

According to §15.207. The emission value for frequency within 150KHz to 30MHz shall not exceed criteria of below chart.

Frequency range MHz	Limits dB(uV)	
	Quasi-peak	Average
0.15 to 0.50	66 to 56	56 to 46
0.50 to 5	56	46
5 to 30	60	50

Note

- 1.The lower limit shall apply at the transition frequencies
- 2.The limit decreases linearly with the logarithm of the frequency in the range 0.15 MHz to 0.50 MHz.

12.2. EUT Setup

1. The conducted emission tests were performed in the test site, using the setup in accordance with the ANSI C63.4-2001.
2. The EUT was plug-in DC power adaptor and was placed on the center of the back edge on the test table. The peripherals like earphone was placed on the side of the EUT. The rear of the EUT and peripherals were placed flushed with the rear of the tabletop.
3. The Power adaptor was connected with 110Vac/60Hz power source.

12.3. Measurement Procedure

1. The EUT was placed on a table which is 0.8m above ground plane.
2. Maximum procedure was performed on the six highest emissions to ensure EUT compliance.
3. Repeat above procedures until all frequency measured were complete.

Unless otherwise stated the results shown in this test report refer only to the sample(s) tested. This test report cannot be reproduced, except in full, without prior written permission of the Company. 除非另有明，此報告結果僅對測試之樣品負責。本報告未經本公司書面許可，可部份複製。

This Test Report is issued by the Company under its General Conditions of Service which is available on request or accessible at http://www.sgs.com/terms_and_conditions.htm.

Attention is drawn to the limitation of liability, indemnification and jurisdiction issues defined therein. Any holder of this Test Report is advised that information contained hereon reflects the Company's findings at the time of its intervention only and within the limits of Client's instructions, if any. The Company's sole responsibility is to its Client and this document does not exonerate parties to a transaction from exercising all their rights and obligations under the transaction documents. Any unauthorized alteration, forgery or falsification of the content or appearance of this document is unlawful and offenders may be prosecuted to the fullest extent of the law.

12.4. Measurement Equipment Used:

Conducted Emission Test Site					
EQUIPMENT TYPE	MFR	MODEL NUMBER	SERIAL NUMBER	LAST CAL.	CAL DUE.
EMC Analyzer	HP	8594EM	3624A00203	09/02/2007	09/03/2008
EMI Test Receiver	R&S	ESCS30	828985/004	06/09/2007	06/08/2008
Transient Limiter	HP	11947A	3107A02062	09/02/2007	09/03/2008
LISN	Rolf-Heine	NNB-2/16Z	99012	12/31/2007	12/30/2008
LISN	Rolf-Heine	NNB-2/16Z	99013	12/24/2007	12/23/2008
LISN	FCC	50/250-25-2-01	04034	01/24/2008	01/23/2009
Coaxial Cables	N/A	No. 3, 4	N/A	12/24/2007	12/23/2008

12.5. Measurement Result: N/A

Unless otherwise stated the results shown in this test report refer only to the sample(s) tested. This test report cannot be reproduced, except in full, without prior written permission of the Company. 除非另有明，此報告結果僅對測試之樣品負責。本報告未經本公司書面許可，可部份複製。

This Test Report is issued by the Company under its General Conditions of Service which is available on request or accessible at http://www.sgs.com/terms_and_conditions.htm.

Attention is drawn to the limitation of liability, indemnification and jurisdiction issues defined therein. Any holder of this Test Report is advised that information contained hereon reflects the Company's findings at the time of its intervention only and within the limits of Client's instructions, if any. The Company's sole responsibility is to its Client and this document does not exonerate parties to a transaction from exercising all their rights and obligations under the transaction documents. Any unauthorized alteration, forgery or falsification of the content or appearance of this document is unlawful and offenders may be prosecuted to the fullest extent of the law.