



Sverige



Report On

FCC and ISED Testing of the Ericsson Radio 4415 B66A, NB-IoT IB, KRC 161 644/1 (2100 MHz) Base Station in accordance with FCC CFR 47 Part 2, FCC CFR 47 Part 27, ISED RSS-GEN and ISED RSS-139

COMMERCIAL-IN-CONFIDENCE

FCC ID: TA8AKRC161644

IC: 287AB-FS161644

PREPARED BY

Maggie Whiting
Key Account Manager

APPROVED BY

Steve Scarfe
Authorised Signatory

DATED

9 September 2021

Document 75952701 Report 06 Issue 1

September 2021



CONTENTS

Section	Page No
1	REPORT INFORMATION 2
1.1	Report Details 3
1.2	Brief Summary of Results 4
1.3	Test Rationale 5
1.4	Configuration Description 6
1.5	Declaration of Build Status 7
1.6	Product Information 8
1.7	Test Setup 9
1.8	Test Conditions 10
1.9	Deviation From The Standard 10
1.10	Modification Record 10
1.11	Additional Information 10
2	TEST DETAILS 11
2.1	Maximum Peak Output Power and Peak to Average Ratio - Conducted 12
2.1	Occupied Bandwidth 19
2.2	Band Edge 25
2.3	Transmitter Spurious Emissions 29
3	TEST EQUIPMENT USED 53
3.1	Test Equipment Used 54
3.2	Measurement Uncertainty 56
4	ACCREDITATION, DISCLAIMERS AND COPYRIGHT 57
4.1	Accreditation, Disclaimers and Copyright 58
ANNEX A	Module Lists A.2



SECTION 1

REPORT INFORMATION



1.1 REPORT DETAILS

Manufacturer	Ericsson
Address	Torshamnsgatan 23 Kista SE-16480 Stockholm Sweden
Product Name & Product Number	Radio 4415 B66A - KRC 161 644/1
Serial Number(s)	D827454598
Software Version	CXP9013268/12 Revision R82CM
Hardware Version	R5B
Test Specification/Issue/Date	FCC CFR 47 Part 2: 2020 FCC CFR 47 Part 27: 2020 ISED RSS-GEN: Issue 5: March 2019 Amendment 1, 2021 Amendment 2 Industry Canada RSS-139: Issue 3: 2015
Test Plan	Q1 FCC_IC test plan for MR7602-1 NR-IoT V 0.9 Reduced Scope
Start of Test	07 July 2021
Finish of Test	07 July 2021
Name of Engineer(s)	Hector Moreno & Ashok Kumar
Related Document(s)	KDB 971168 D01 v02r02 KDB 662911 D01 v02r01 ICES-003:Issue 7 (2020-10) ANSI C63.26-2015

ENGINEERING STATEMENT

The measurements shown in this report were made in accordance with the procedures described on test pages. All reported testing was carried out on a sample equipment to demonstrate compliance with and FCC CFR 47 Part 2: 2020, FCC CFR 47 Part 27: 2020, ISED RSS-GEN: Issue 5: March 2019 Amendment 1, 2021 Amendment 2, Industry Canada RSS-139: Issue 3: 2015 The sample tested was found to comply with the requirements defined in the applied rules.

Test Engineer(s);

Hector Moreno & Ashok Kumar



1.2 BRIEF SUMMARY OF RESULTS

A brief summary of results for each configuration, in accordance with FCC CFR 47 Part 2, FCC CFR 47 Part 27, ISED RSS-GEN and Industry Canada RSS-139 is shown below.

Section	Specification Clause				Test Description	Result
	FCC CFR 47 Part 2	FCC CFR 47 Part 27	RSS-GEN	RSS-139		
2.1	2.1046	27.50	-	6.5	Maximum Peak Output Power and Peak to Average Ratio - Conducted	Pass
2.2	2.1049	27.53	6.6	-	Occupied Bandwidth	Pass
2.3	2.1051	27.53	-	6.5	Band Edge	Pass
2.4	2.1051	27.53	-	6.6	Transmitter Spurious Emissions	Pass

Testing for Radiated Spurious Emissions are recording in the following report:
2104108STO-108 Radio 4415 B66A G3 FCC27



1.3 TEST RATIONALE

The tests that have been selected are detailed in the customer Test Plan as defined in section 1.1 of this report. The Test Plan is based on the TÜV SÜD FCC Test Plan Rationale, available on request.



1.4 CONFIGURATION DESCRIPTION

Configuration	RAT	No. Of carriers	Pout (W)	Carrier Bandwidth	Carrier Frequency Configuration (MHz)		
					Bottom	Middle	Top
1	NR in NR/ESS Setup (NB-IoT)	1	40	10 MHz- SCS 15kHz	2115.0	2145.0	2175.0
				15 MHz- SCS 15kHz	2117.5	2145.0	2172.5
				20 MHz- SCS 15kHz	2120.0	2145.0	2170.0



1.5 DECLARATION OF BUILD STATUS

Equipment Description						
Technical Description: (Please provide a brief description of the intended use of the equipment including the technologies the product supports)		Multi-standard remote radio unit				
Manufacturer:		Ericsson AB				
Model:		Radio 4415 B66A				
Part Number:		KRC 161 644/1				
Hardware Version:		R5B				
Software Version:		CXP 901 3268/12 R82CM				
FCC ID of the product under test		TA8FKRC161644				
IC ID of the product under test		287AB-FS161644				
Intentional Radiators						
FDD, TDD		FDD				
Frequency Range (MHz to MHz)		2110MHz - 2180MHz DL 17100MHz - 1780MHz UL				
FDD / TDD		FDD				
Conducted Declared Output Power (dBm)		40W per antenna connector (NB IoT SA carrier max 20W)				
RAT		WCDMA	NB IoT SA	LTE (incl. NB IoT IB, GB)	NR (incl NB IoT IB)	MRO
Supported Bandwidth(s) (MHz)		5MHz		5, 10, 15, 20MHz	5,10,15,20MHz	
Modulation Scheme(s) DL		QPSK, 16QAM, 64QAM	QPSK	QPSK, 16QAM, 64QAM, 256QAM	QPSK, 16QAM, 64QAM, 256QAM	
ITU Emission Designator		5M40F9W	230KG7D	5M00F9W, 10M0F9W, 15M0F9W, 20M0F9W	4M47W7D, 9M29W7D, 14M11W7D, 18M9W7D, 37M8W7D, 9M43W7D, 14M4W7D, 19M2W7D	
IBW		70MHz	20MHz	70MHz	70MHz	
Maximum number of carriers		6		6	6	6
Unintentional Radiators						
Highest frequency generated or used in the device or on which the device operates or tunes		10.1 Gbit/s				
Lowest frequency generated or used in the device or on which the device operates or tunes if <30MHz		-				
Class A Digital Device (Use in commercial, industrial or business environment) or Class B Digital Device (Use in residential environment)		Class B				
DC Power Supply (Delete if Not Applicable)						
Nominal voltage:		-48V				
Extreme upper voltage:		-36V				
Extreme lower voltage:		-58.5V				
Max current:		20A				
Temperature						
Minimum temperature:		-40°C				
Maximum temperature:		55°C				
I hereby declare that I am entitled to sign on behalf of the manufacturer and that the information supplied is correct and complete.						
		<i>Faysal Pirmohamed</i>				
Name:		Faysal Pirmohamed				
Position held:		Regulatory Engineer				
Date:		2021-09-01				

No responsibility will be accepted by TÜV SÜD as to the accuracy of the information declared in this document by the manufacturer.

1.6 PRODUCT INFORMATION

1.6.1 Technical Description

The Equipment Under Test (EUT) Radio 4415 B66A - KRC 161 644/1 is an Ericsson AB Radio Unit working in the public mobile service 2110-2180 MHz band which provides communication connections to 2110-2180 MHz network. The EUT operates from a -48V DC supply.

The Equipment Under Test (EUT) is shown in the photograph below. A full technical description can be found in the Manufacturer's documentation.

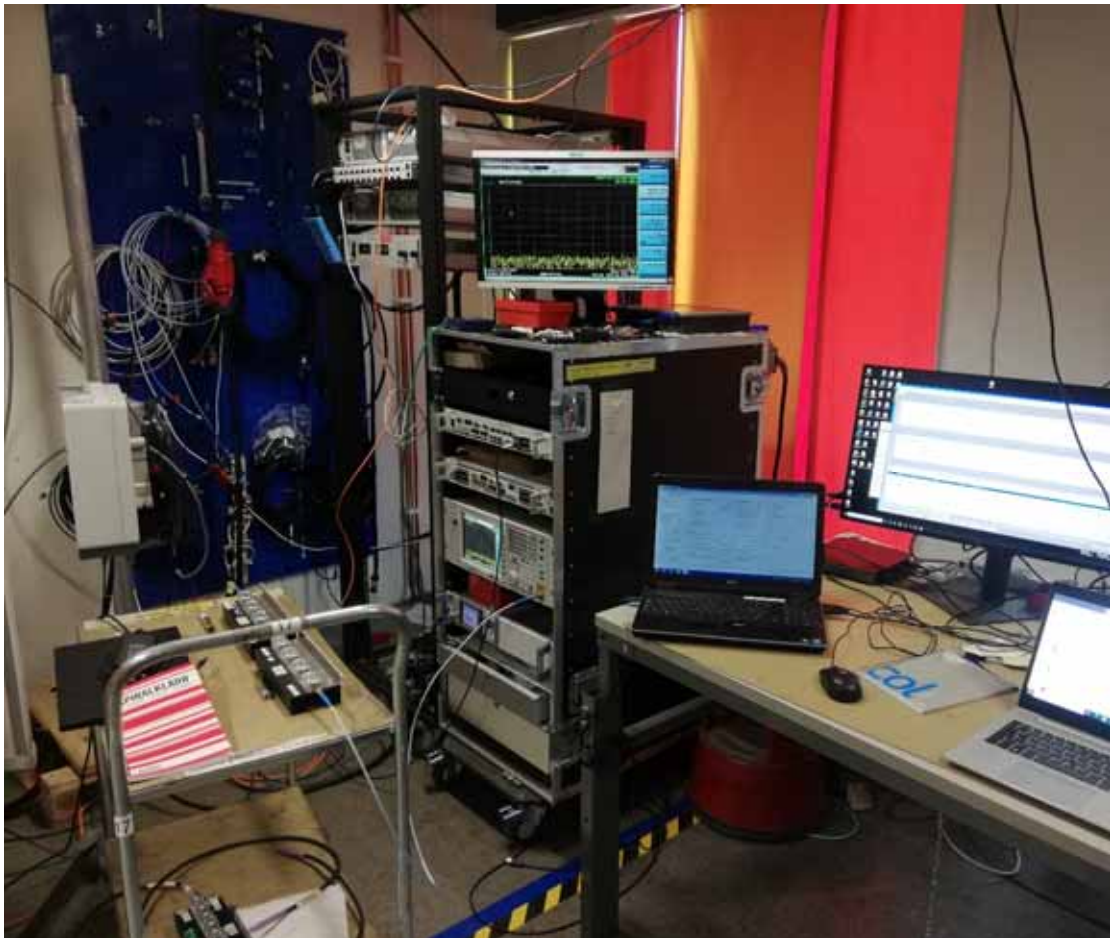

Equipment Under Test



1.7 TEST SETUP

Conducted Test Set Up

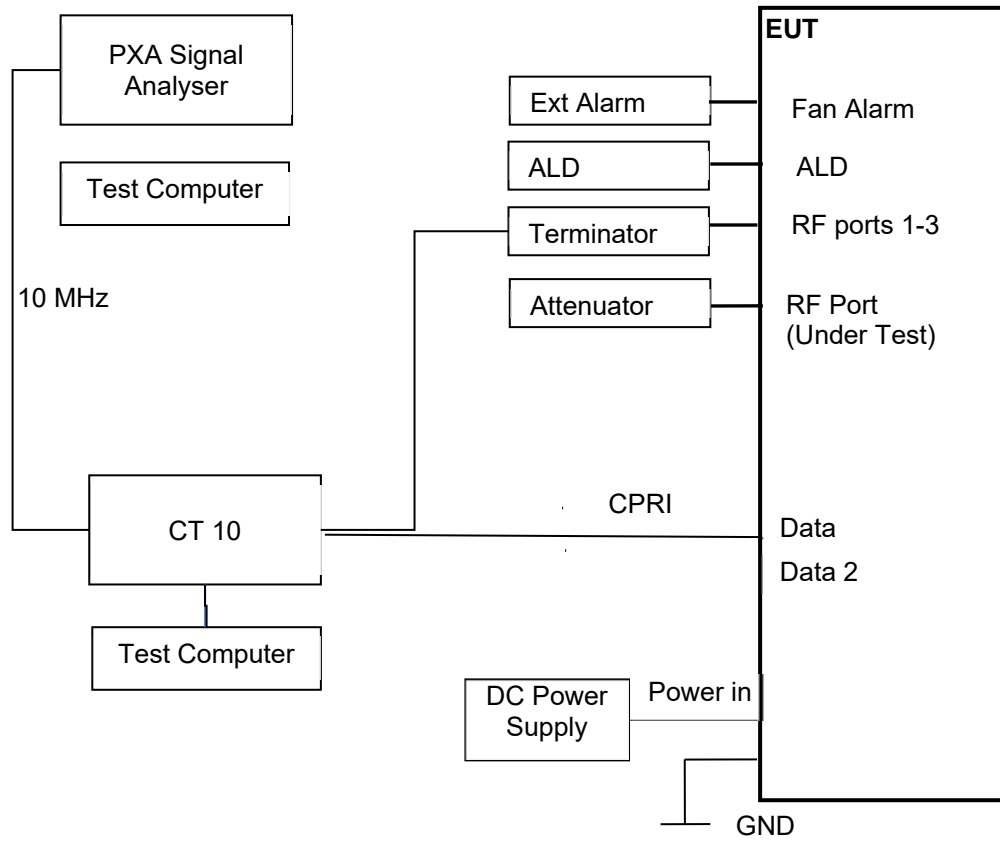



1.8 TEST CONDITIONS

For all tests the EUT was set up in accordance with the relevant test standard and to represent typical operating conditions. Tests were applied with the EUT situated as described in the Test Method for each Test.

The EUT was powered from a -48V DC supply.

FCC Measurement Facility Registration Number
563983 Ericsson Test Laboratory, Kista
Postal Address: Ericsson AB, Isafjordsgatan 10, Stockholm, SE-16 440, Sweden

ISED Accreditation
IC#26170 Ericsson Test Laboratory, Kista
Postal Address: Ericsson AB, Isafjordsgatan 10, Stockholm, SE-164 40, Sweden

Test Name	Name of Engineer(s)
Maximum Peak Output Power and Peak to Average Ratio - Conducted	Ashok Kumar, Hector Eric Moreno Trujillo
Occupied Bandwidth	Ashok Kumar, Hector Eric Moreno Trujillo
Band Edge	Ashok Kumar, Hector Eric Moreno Trujillo
Transmitter Spurious Emissions	Ashok Kumar, Hector Eric Moreno Trujillo

1.9 DEVIATION FROM THE STANDARD

No deviations from the applicable test standards or test plan were made during testing.

1.10 MODIFICATION RECORD

No modifications were made to the EUT during testing.

1.11 ADDITIONAL INFORMATION

Ericsson will limit this product through the software from operating across the whole of Band 66A, it will be limited to 2110-2180 MHz.

This filing is for a Class 2 Permissive change to add NR in NR/ESS (NB-IoT) to a previously certified Radio for use in the USA and Canada under the following ID's:

FCC ID: TA8FKRC161644
IC: 287AB-FS161644

This device is electrically identical as originally certified as no hardware changes have been made
Frequency Stability has been verified at time of original certification.

The Test Plan is based on the TUV SUD Document FCC and ISED Test Plan Rationale for Base Station Equipment.

This TX and RX share the same port and therefore Rx Spurious Emissions have not been performed.



SECTION 2

TEST DETAILS



2.1 MAXIMUM PEAK OUTPUT POWER AND PEAK TO AVERAGE RATIO - CONDUCTED

2.1.1 Specification Reference

FCC CFR 47 Part 27, Clause 27.50
 FCC CFR 47 Part 2, Clause 2.1046
 Industry Canada RSS-139, Clause 6.5

2.1.2 Date of Test and Modification State

13 July 2021 - Modification State 0

2.1.1 Test Equipment Used

The major items of test equipment used for the above tests are identified in Section 3.1.

2.1.2 Environmental Conditions

Ambient Temperature 23.8°C
 Relative Humidity 53.5%

2.1.3 Test Method

All measurements were made in accordance with FCC KDB 971168 D01, clause 5.2.1 and summed in accordance with FCC KDB 662911 D01.

Calculations

Total Power = Measured PSD (Total Power Port A) + 10log (N_{ANT}), where N_{ANT} =4

Maximum Total Power (EIRP) = Total Power (as above) + Declared Antenna Gain

2.1.4 Test Results

Configuration 1

Maximum Output Power 46.00 dBm

Antenna	NR in NR/ESS Setup (NB-IoT) Modulation	NR in NR/ESS Setup (NB-IoT) Carrier Bandwidth	Peak to Average Ratio (PAR) / Output Power / PSD				
			PAR (dB)	Channel Position B		Total Power Port A + B + C + D	
				dBm	dBm/MHz	dBm	dBm/MHz
A	QPSK	10.0 MHz	7.37	46.01	37.49	52.03	43.51
A	QPSK	15.0 MHz	7.42	46.06	36.94	52.08	42.96
A	QPSK	20.0 MHz	7.44	46.02	36.95	52.04	42.97



Antenna A - NR in NR/ESS Setup (NB-IoT) Modulation QPSK - NR in NR/ESS Setup (NB-IoT)
Carrier Bandwidth 10.0 MHz - Channel Position B

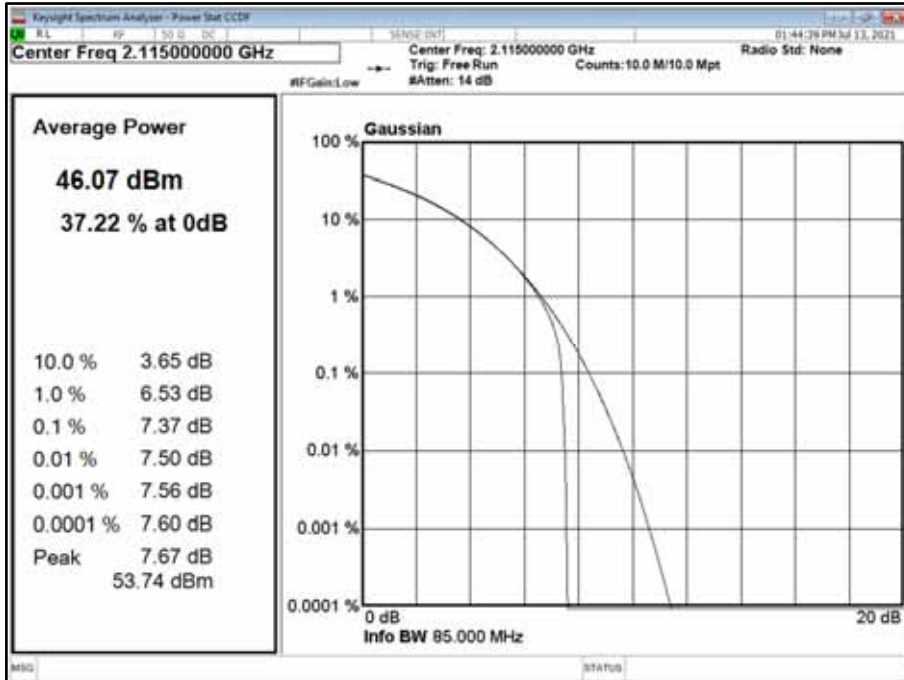

Antenna A - NR in NR/ESS Setup (NB-IoT) Modulation QPSK - NR in NR/ESS Setup (NB-IoT)
Carrier Bandwidth 15.0 MHz - Channel Position B

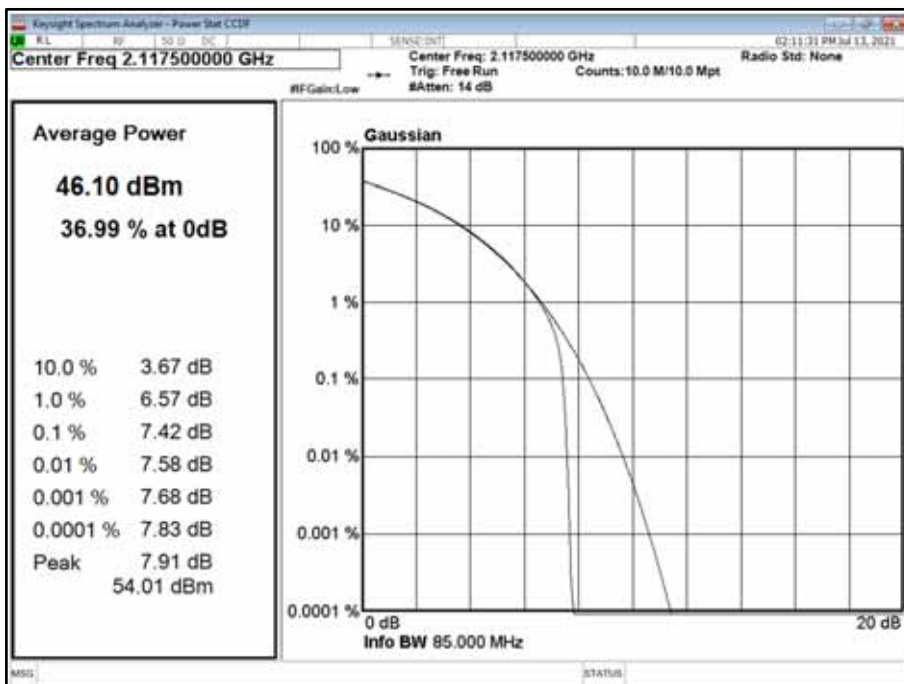



Antenna A - NR in NR/ESS Setup (NB-IoT) Modulation QPSK - NR in NR/ESS Setup (NB-IoT)
Carrier Bandwidth 20.0 MHz - Channel Position B

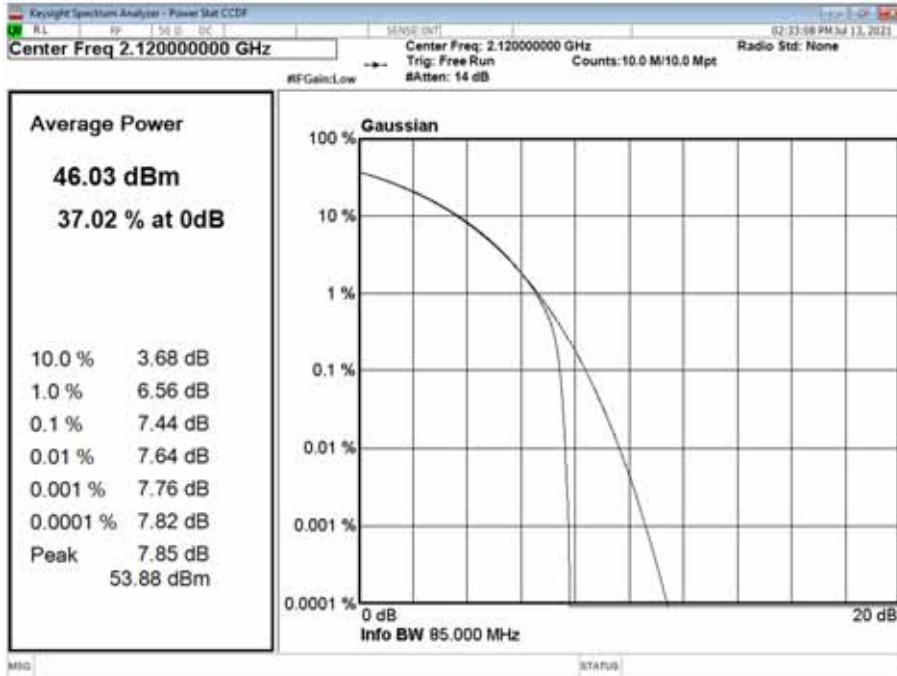

Configuration 1

Maximum Output Power 46.00 dBm

Antenna	NR in NR/ESS Setup (NB-IoT) Modulation	NR in NR/ESS Setup (NB-IoT) Carrier Bandwidth	Peak to Average Ratio (PAR) / Output Power / PSD				
			Channel Position M				
			PAR (dB)	Average Power/PSD		Total Power Port A + B + C +D	
			dBm	dBm/MHz	dBm	dBm/MHz	
A	QPSK	10.0 MHz	7.35	46.25	37.42	52.27	43.44
A	QPSK	15.0 MHz	7.41	46.20	36.90	52.22	42.92
A	QPSK	20.0 MHz	7.41	46.05	36.91	52.07	42.93



Antenna A - NR in NR/ESS Setup (NB-IoT) Modulation QPSK - NR in NR/ESS Setup (NB-IoT)
Carrier Bandwidth 10.0 MHz - Channel Position M

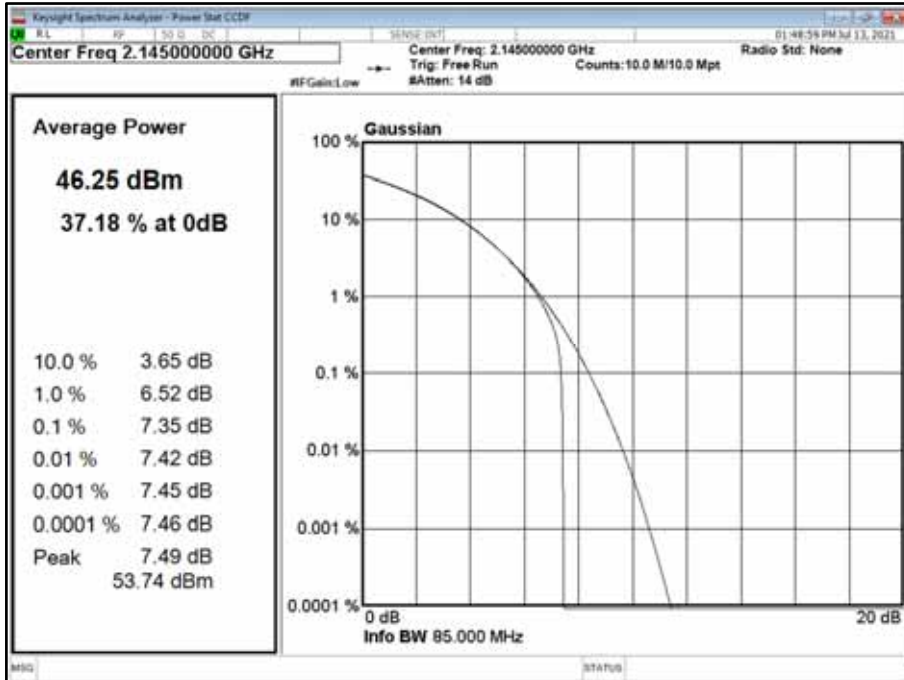

Antenna A - NR in NR/ESS Setup (NB-IoT) Modulation QPSK - NR in NR/ESS Setup (NB-IoT)
Carrier Bandwidth 15.0 MHz - Channel Position M

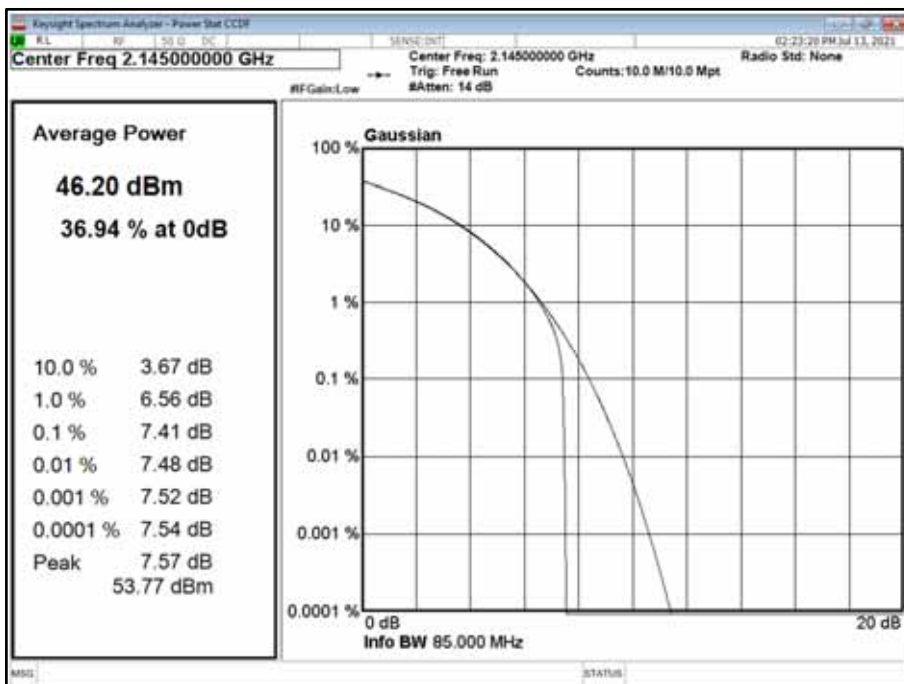



Antenna A - NR in NR/ESS Setup (NB-IoT) Modulation QPSK - NR in NR/ESS Setup (NB-IoT)
Carrier Bandwidth 20.0 MHz - Channel Position M

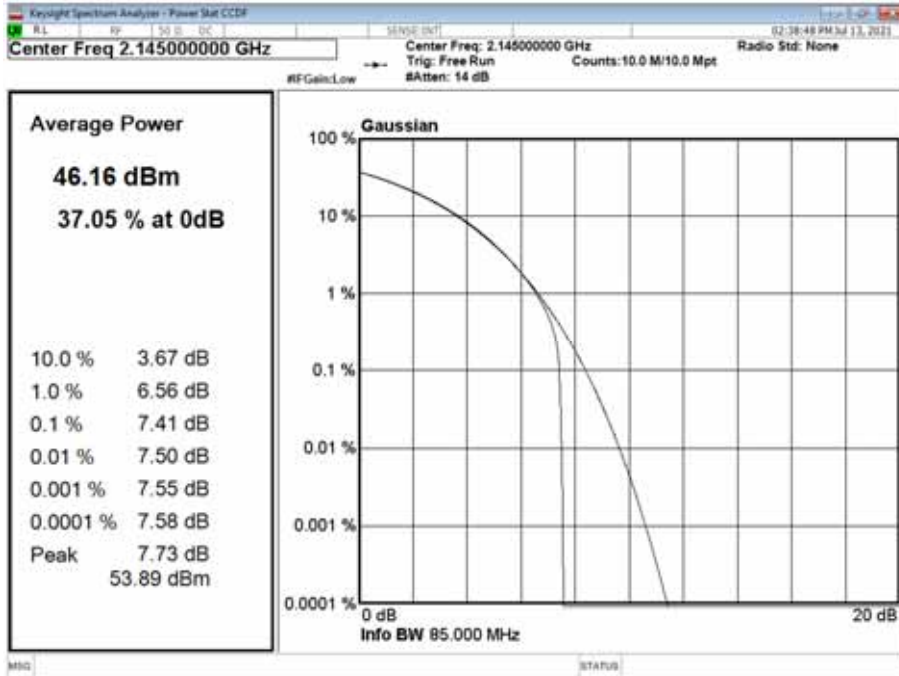

Configuration 1

Maximum Output Power 46.00 dBm

Antenna	NR in NR/ESS Setup (NB-IoT) Modulation	NR in NR/ESS Setup (NB-IoT) Carrier Bandwidth	Peak to Average Ratio (PAR) / Output Power / PSD				
			Channel Position T				
			PAR (dB)	Average Power/PSD		Total Power Port A + B + C +D	
			dBm	dBm/MHz	dBm	dBm/MHz	
A	QPSK	10.0 MHz	7.38	46.03	37.48	52.05	43.50
A	QPSK	15.0 MHz	7.43	46.09	37.12	52.11	43.14
A	QPSK	20.0 MHz	7.47	46.05	36.71	52.07	42.73



Antenna A - NR in NR/ESS Setup (NB-IoT) Modulation QPSK - NR in NR/ESS Setup (NB-IoT)
Carrier Bandwidth 10.0 MHz - Channel Position T

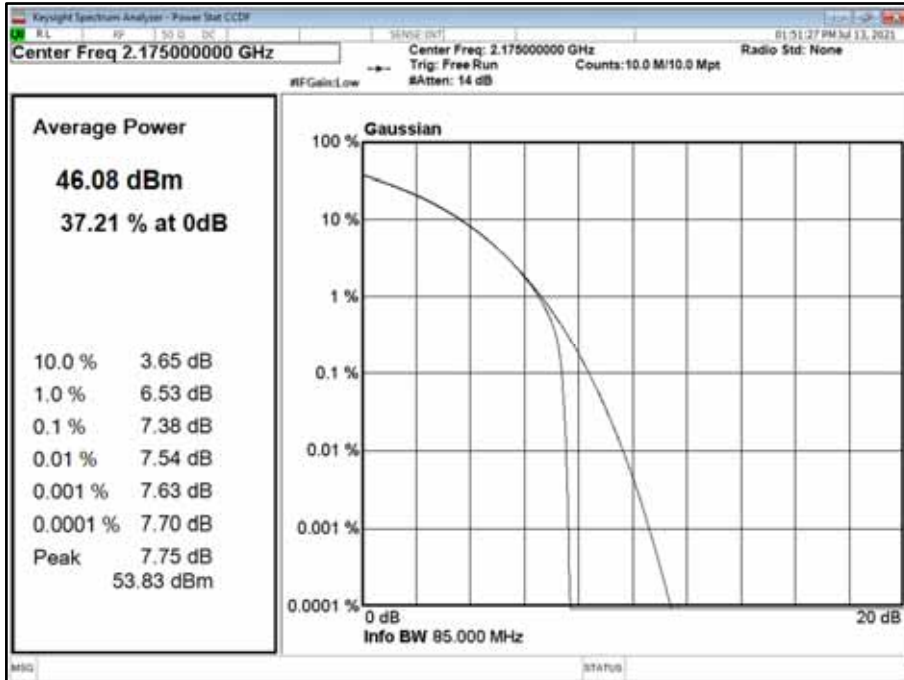

Antenna A - NR in NR/ESS Setup (NB-IoT) Modulation QPSK - NR in NR/ESS Setup (NB-IoT)
Carrier Bandwidth 15.0 MHz - Channel Position T

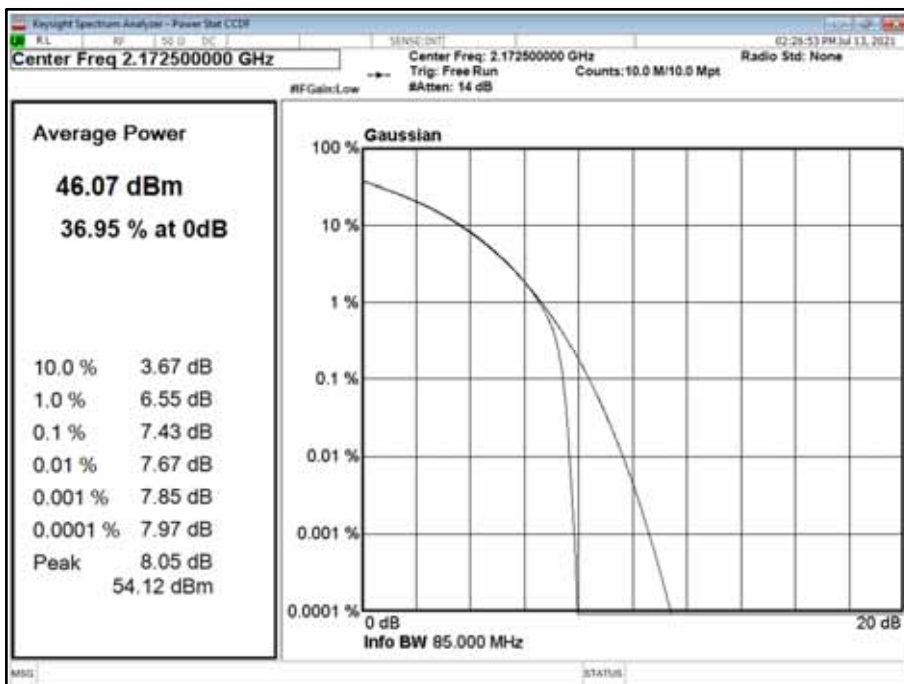



Antenna A - NR in NR/ESS Setup (NB-IoT) Modulation QPSK - NR in NR/ESS Setup (NB-IoT)
Carrier Bandwidth 20.0 MHz - Channel Position T

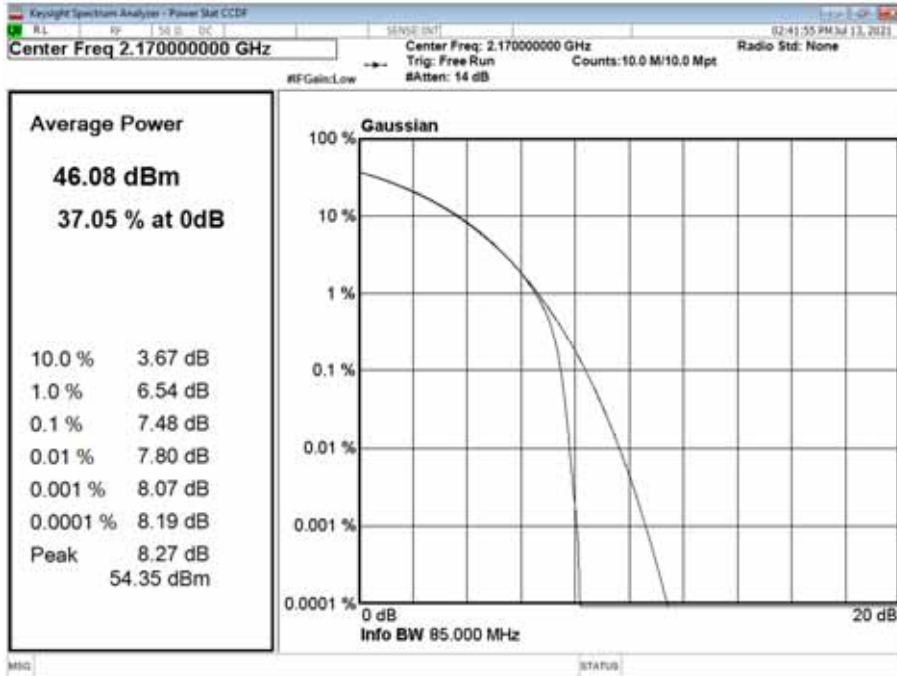

Limit	
Maximum rated output power (Non-Rural)	≤ 1640 W/MHz or ≤+62.15 dBm/MHz
Maximum rated output power (Rural)	≤ 3280 W/MHz or ≤+65.15 dBm/MHz
Peak to Average Ratio	13 dB

The radio unit was tested with maximum output power and without an antenna. ERP/EIRP compliance is addressed at the time of licensing, as required by the responsible FCC/ISED Bureau(s). Licensees are required to take into account maximum allowed antenna gain used in combination with the applicable power settings to prevent the radiated output power exceeding the limits.



2.1 OCCUPIED BANDWIDTH

2.1.1 Specification Reference

FCC CFR 47 Part 27, Clause 27.53
 ISED RSS-GEN, Clause 6.6
 FCC CFR 47 Part 2, Clause 2.1049

2.1.2 Date of Test and Modification State

13 July 2021 - Modification State 0

2.1.3 Test Equipment Used

The major items of test equipment used for the above tests are identified in Section 3.1.

2.1.4 Environmental Conditions

Ambient Temperature 23.8°C
 Relative Humidity 53.5%

2.1.5 Test Method

All measurements were made in accordance with FCC KDB 971168 D01, Clause 4.3. The Spectrum Analyser RBW was configured to be at least 1% of the channel bandwidth of the carrier to be measured.

For 26 dB Bandwidth, in accordance with KDB 971168 D01, a peak detector and a trace setting of Max Hold were used. The trace was allowed to stabilise. Using the Spectrum Analyser function, the 26dB measurement result was obtained.

4.3 Occupied bandwidth – power bandwidth (99 %) measurement procedure
 Subclause 5.4.4 of ANSI C63.26-2015 is applicable (wherein the recommendation is to use the 99 % power bandwidth function of a spectrum analyser).

2.1.6 Test Results

Configuration 1

Antenna	NR in NR/ESS Setup (NB-IoT) Modulation	NR in NR/ESS Setup (NB-IoT) Carrier Bandwidth	Result (kHz)					
			Channel Position B		Channel Position M		Channel Position T	
			Occupied Bandwidth	-26 dB Bandwidth	Occupied Bandwidth	-26 dB Bandwidth	Occupied Bandwidth	-26 dB Bandwidth
A	QPSK	10.0 MHz	9428.10	9789.82	9422.21	9783.71	9410.10	9790.73
A	QPSK	15.0 MHz	14360.33	14759.38	14369.11	14789.29	14365.56	14768.96
A	QPSK	20.0 MHz	19216.08	19769.69	19192.24	19743.12	19179.79	19720.47



Antenna A - NR in NR/ESS Setup (NB-IoT) Modulation QPSK - NR in NR/ESS Setup (NB-IoT)
Carrier Bandwidth 10.0 MHz - Channel Position B

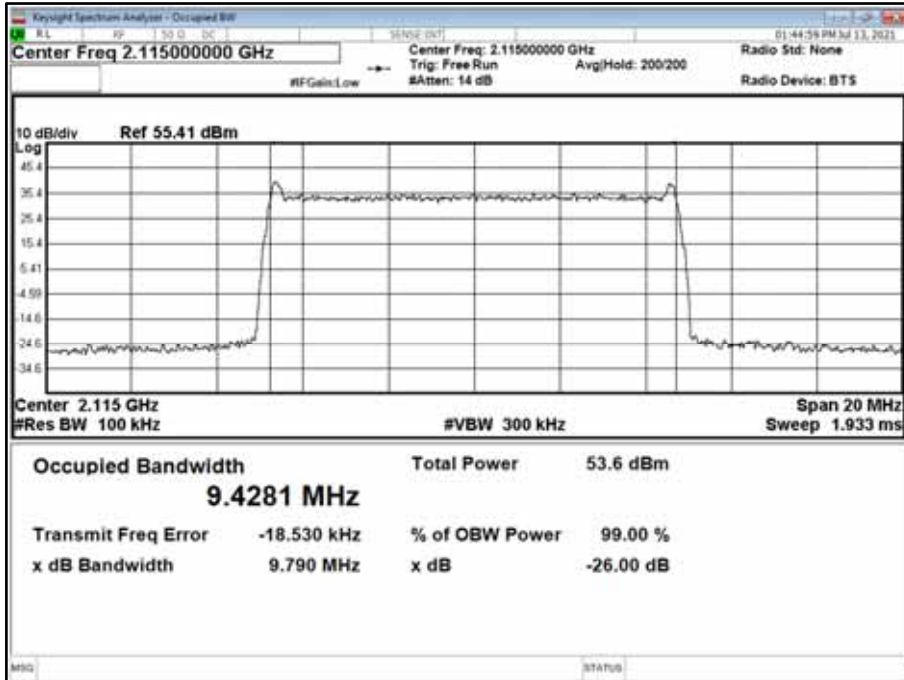

Antenna A - NR in NR/ESS Setup (NB-IoT) Modulation QPSK - NR in NR/ESS Setup (NB-IoT)
Carrier Bandwidth 10.0 MHz - Channel Position M





Antenna A - NR in NR/ESS Setup (NB-IoT) Modulation QPSK - NR in NR/ESS Setup (NB-IoT)
Carrier Bandwidth 10.0 MHz - Channel Position T



Antenna A - NR in NR/ESS Setup (NB-IoT) Modulation QPSK - NR in NR/ESS Setup (NB-IoT)
Carrier Bandwidth 15.0 MHz - Channel Position B

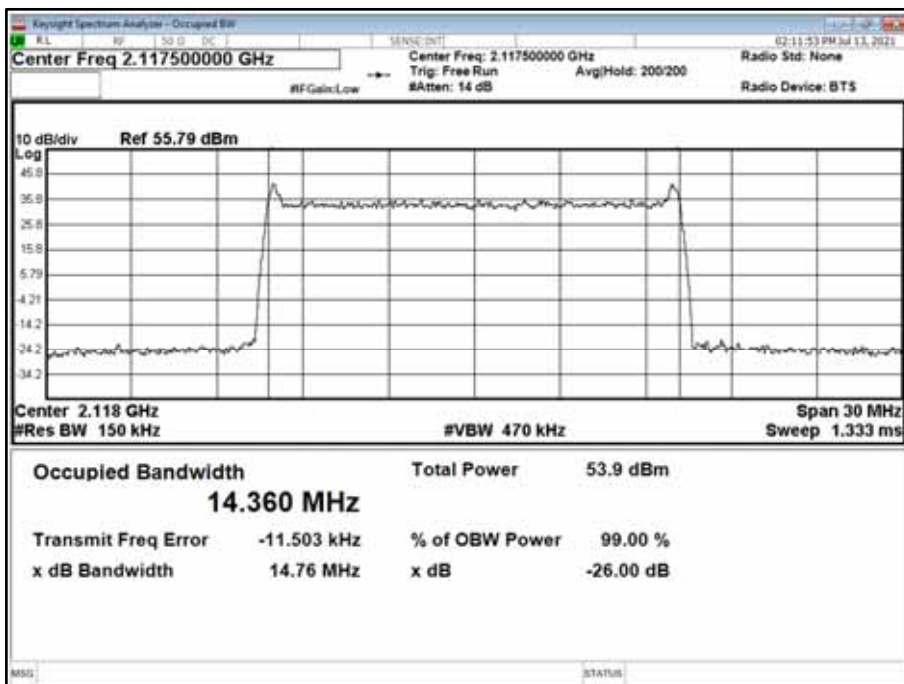



Antenna A - NR in NR/ESS Setup (NB-IoT) Modulation QPSK - NR in NR/ESS Setup (NB-IoT)
Carrier Bandwidth 15.0 MHz - Channel Position M

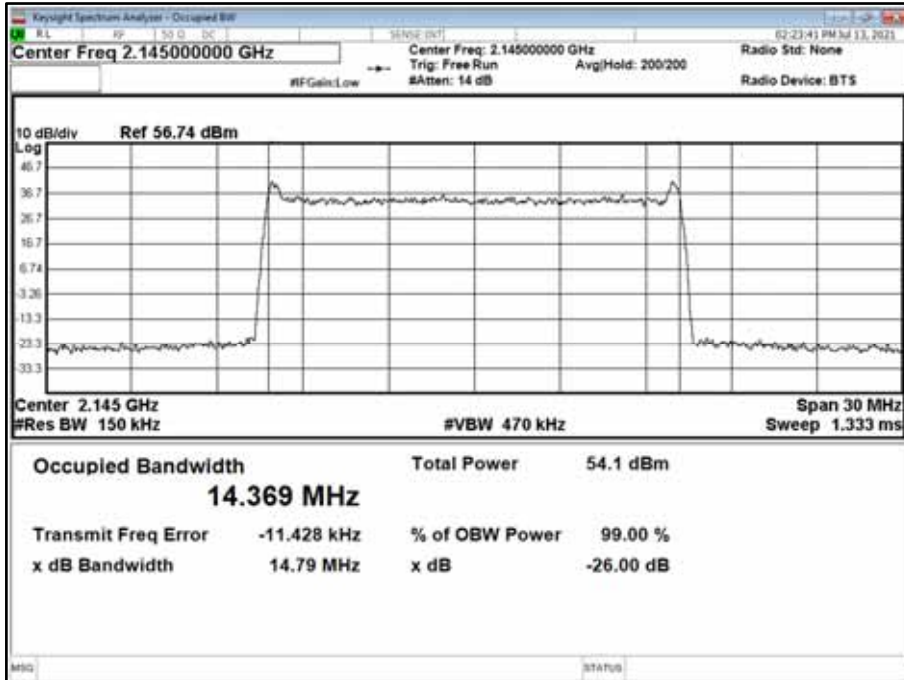

Antenna A - NR in NR/ESS Setup (NB-IoT) Modulation QPSK - NR in NR/ESS Setup (NB-IoT)
Carrier Bandwidth 15.0 MHz - Channel Position T

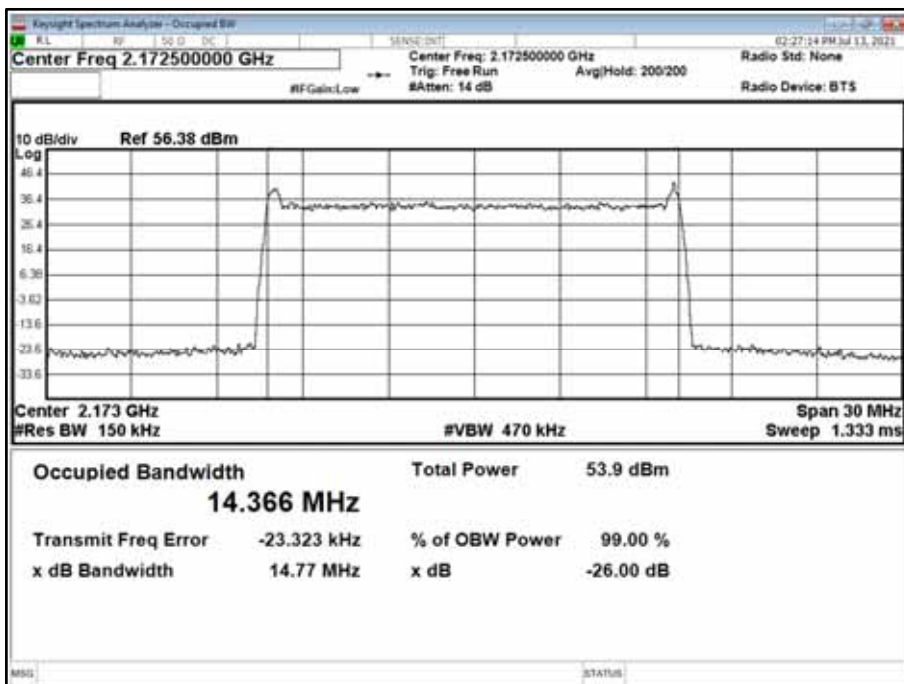



Antenna A - NR in NR/ESS Setup (NB-IoT) Modulation QPSK - NR in NR/ESS Setup (NB-IoT)
Carrier Bandwidth 20.0 MHz - Channel Position B

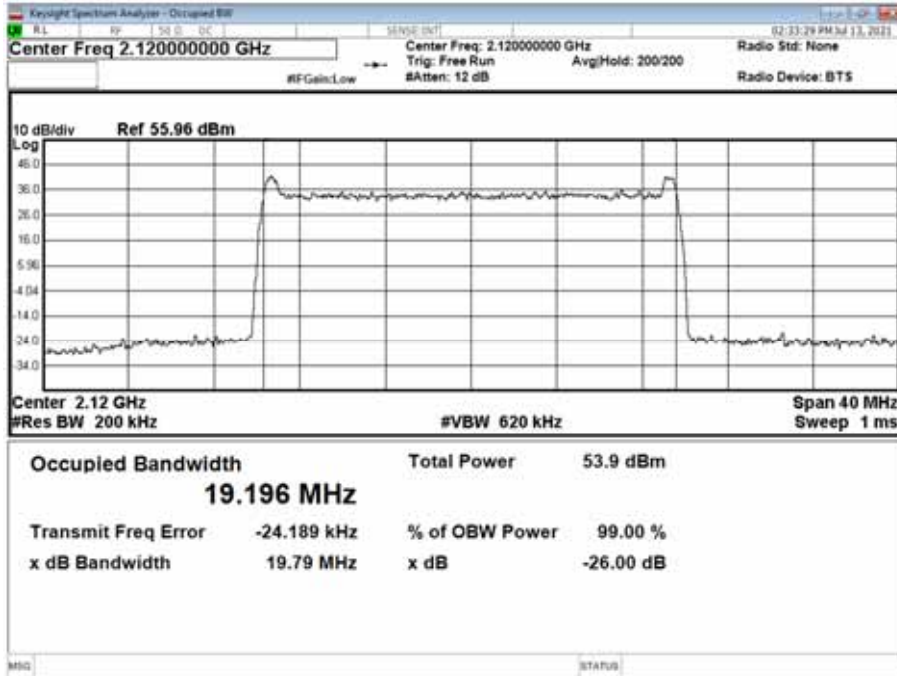

Antenna A - NR in NR/ESS Setup (NB-IoT) Modulation QPSK - NR in NR/ESS Setup (NB-IoT)
Carrier Bandwidth 20.0 MHz - Channel Position M

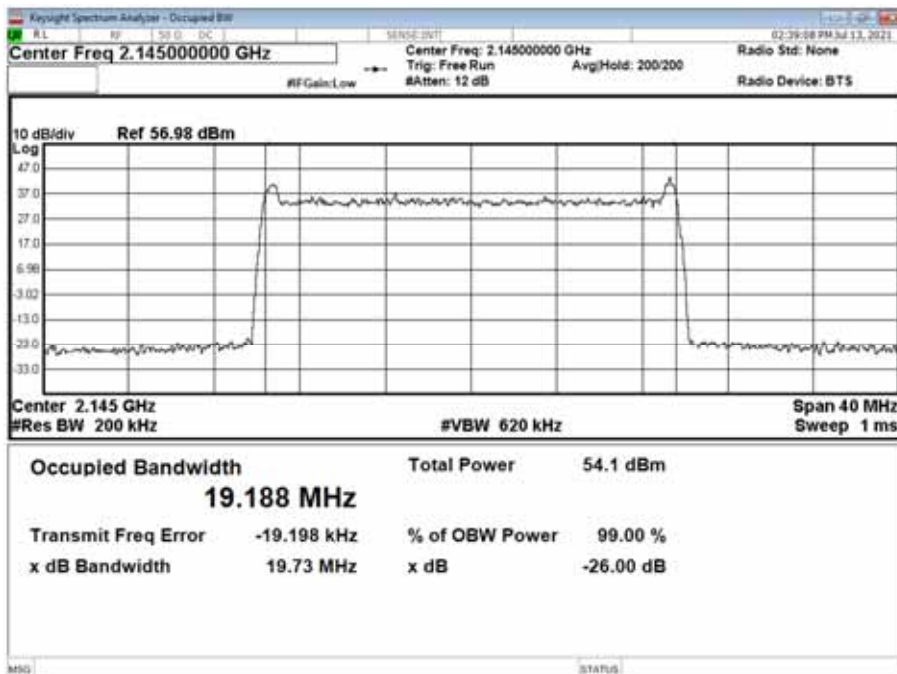



Antenna A - NR in NR/ESS Setup (NB-IoT) Modulation QPSK - NR in NR/ESS Setup (NB-IoT)
Carrier Bandwidth 20.0 MHz - Channel Position T

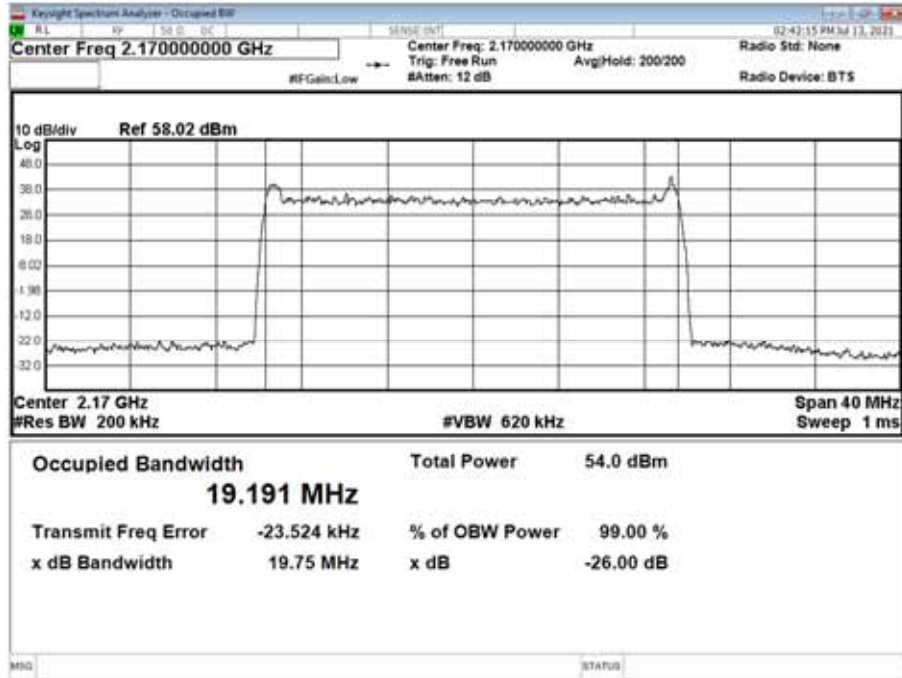



2.2 BAND EDGE

2.2.1 Specification Reference

FCC CFR 47 Part 27, Clause 27.53
Industry Canada RSS-139, Clause 6.5
FCC CFR 47 Part 2, Clause 2.1051

2.2.2 Date of Test and Modification State

13 July 2021 - Modification State 0

2.2.1 Test Equipment Used

The major items of test equipment used for the above tests are identified in Section 3.1.

2.2.2 Environmental Conditions

Ambient Temperature 23.8°C
Relative Humidity 53.5%

2.2.3 Test Method

All measurements were made in accordance with FCC KDB 971168 D01, Clause 6.0.

Band Edge measurements were used an Integration Bandwidth of at least 1% of the measured 26dB Bandwidth.

Each antenna port has been declared as being equivalent, therefore measurements were made on one antenna port only. To account for this, the limit was tightened by $10 * \text{Log}(N)$, where N is equal to the number of MIMO antenna ports.

For 4 ports, the limit was calculated as being $-13 \text{ dBm} - 10 * \text{Log}(4) = -19 \text{ dBm}$.

2.2.4 Test Results

Configuration 1

Maximum Output Power 46.00 dBm

Antenna	NR in NR/ESS Setup (NB-IoT) Modulation	NR in NR/ESS Setup (NB-IoT) Carrier Bandwidth	Band Edge (MHz)	
			Channel Position B	Channel Position T
A	QPSK	10.0 MHz	2,115.0	2,175.0
A	QPSK	15.0 MHz	2,117.5	2,172.5
A	QPSK	20.0 MHz	2,120.0	2,170.0



Antenna A - NR in NR/ESS Setup (NB-IoT) Modulation QPSK - NR in NR/ESS Setup (NB-IoT)
Carrier Bandwidth 10.0 MHz - Channel Position B

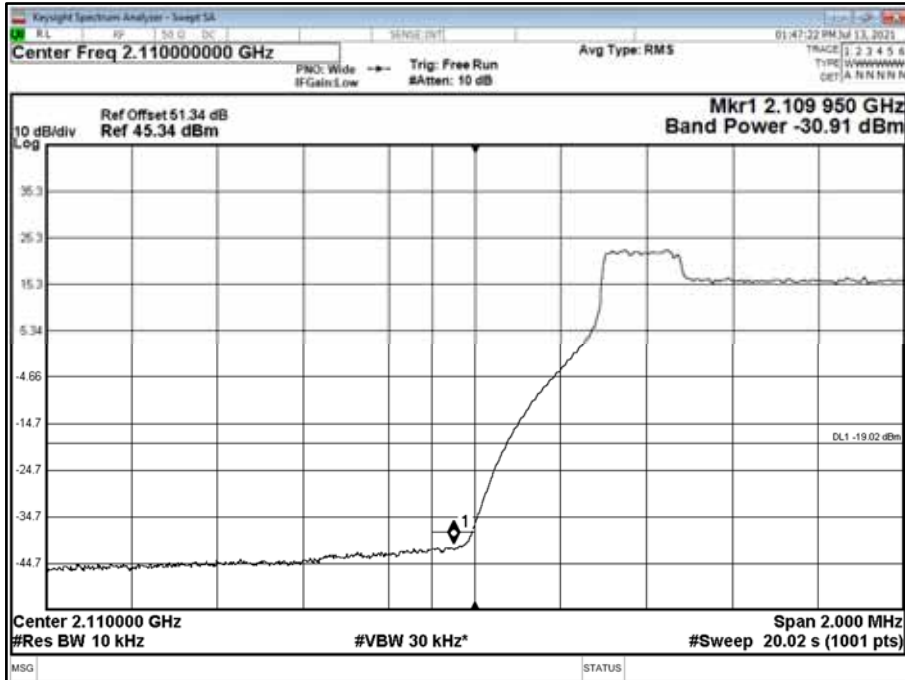

Antenna A - NR in NR/ESS Setup (NB-IoT) Modulation QPSK - NR in NR/ESS Setup (NB-IoT)
Carrier Bandwidth 10.0 MHz - Channel Position T

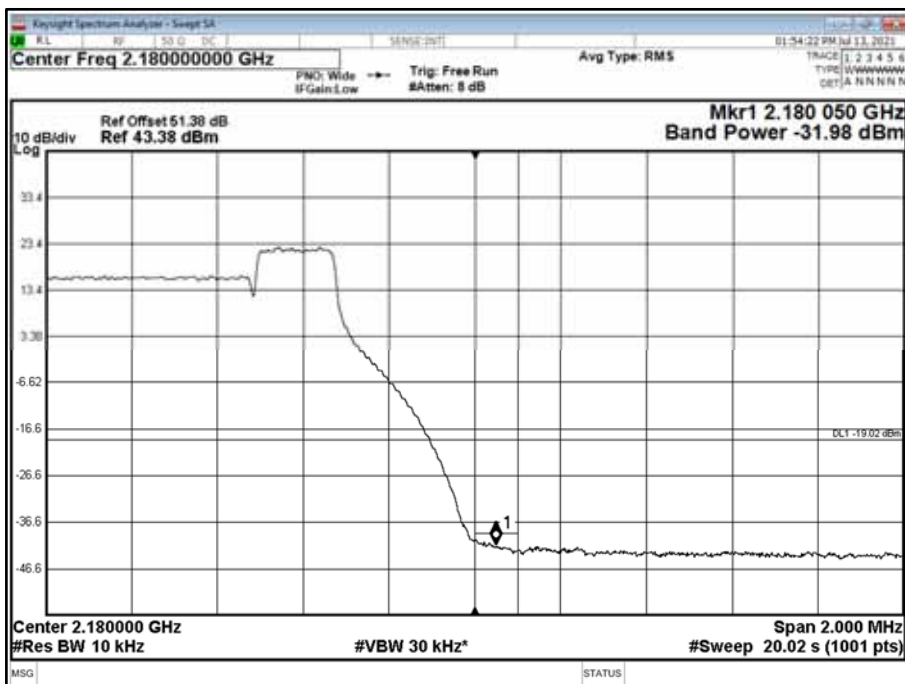



Antenna A - NR in NR/ESS Setup (NB-IoT) Modulation QPSK - NR in NR/ESS Setup (NB-IoT)
Carrier Bandwidth 15.0 MHz - Channel Position B

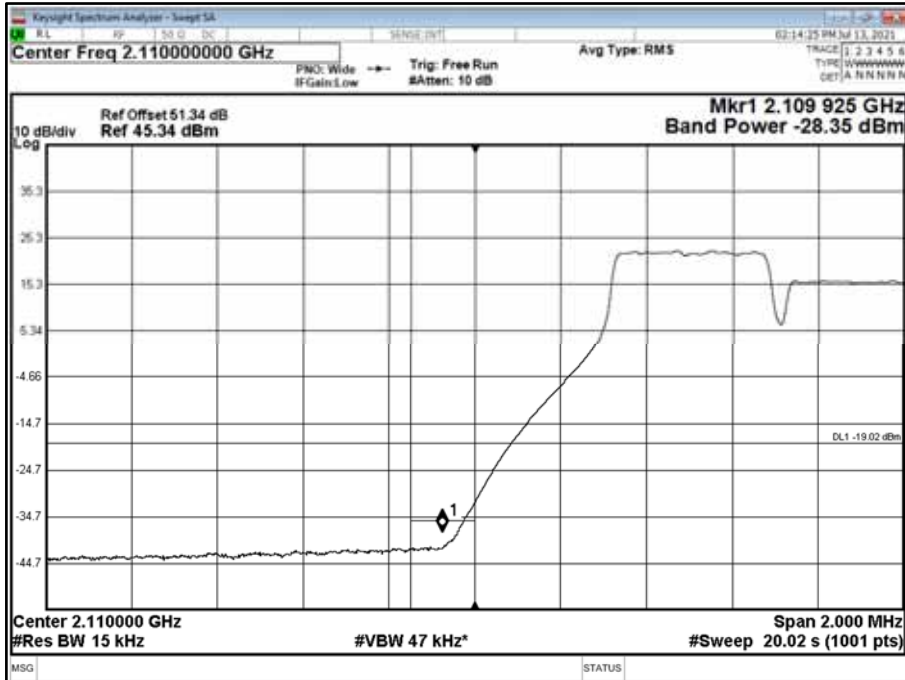

Antenna A - NR in NR/ESS Setup (NB-IoT) Modulation QPSK - NR in NR/ESS Setup (NB-IoT)
Carrier Bandwidth 15.0 MHz - Channel Position T

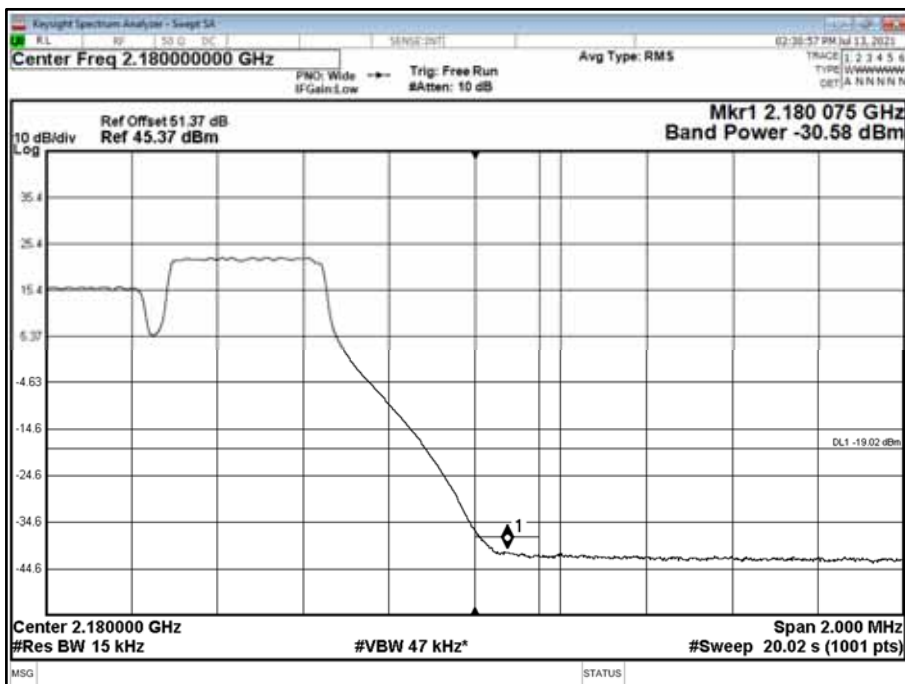



Antenna A - NR in NR/ESS Setup (NB-IoT) Modulation QPSK - NR in NR/ESS Setup (NB-IoT)
Carrier Bandwidth 20.0 MHz - Channel Position B



Antenna A - NR in NR/ESS Setup (NB-IoT) Modulation QPSK - NR in NR/ESS Setup (NB-IoT)
Carrier Bandwidth 20.0 MHz - Channel Position T

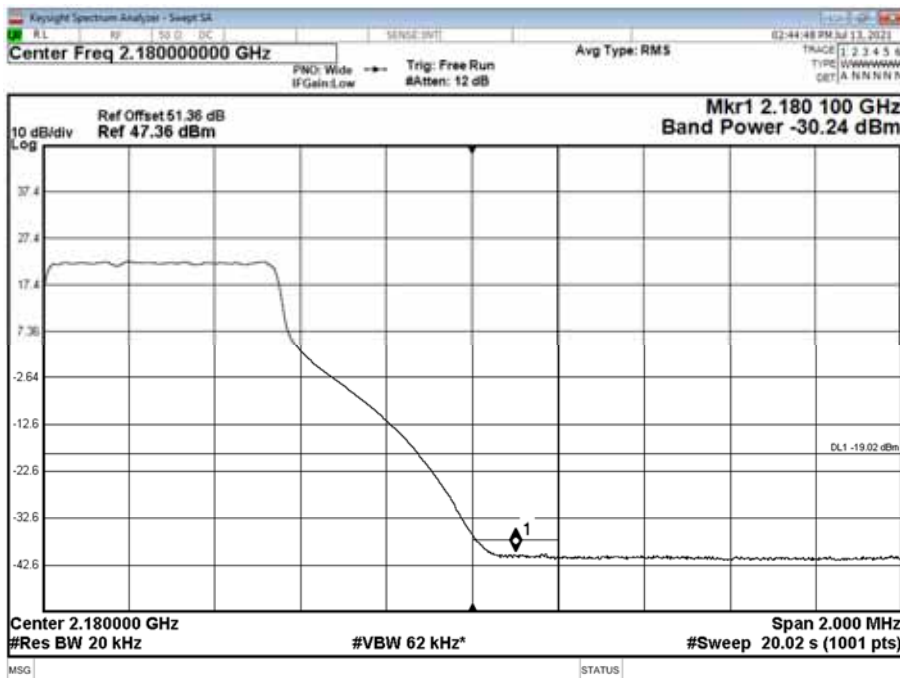

Limit	-19 dBm
-------	---------



2.3 TRANSMITTER SPURIOUS EMISSIONS

2.3.1 Specification Reference

FCC CFR 47 Part 27, Clause 27.53
Industry Canada RSS-139, Clause 6.6
FCC CFR 47 Part 2, Clause 2.1051

2.3.2 Date of Test and Modification State

13 July 2021 - Modification State 0

2.3.1 Test Equipment Used

The major items of test equipment used for the above tests are identified in Section 3.1.

2.3.2 Environmental Conditions

Ambient Temperature	23.8°C
Relative Humidity	53.5%

2.3.3 Test Method

All measurements were made in accordance with FCC KDB 971168 D01, Clause 6.1.

Each antenna port has been declared as being equivalent, therefore measurements were made on one antenna port only. To account for this, the limit was tightened by $10 * \text{Log}(N)$, where N is equal to the number of MIMO antenna ports.

For 4 ports, the limit was calculated as being $-13 \text{ dBm} - 10 * \text{Log}(4) = -19 \text{ dBm}$.

2.3.4 Test Results

Configuration 1

Maximum Output Power 46.00 dBm



Antenna A - NR in NR/ESS Setup (NB-IoT) Modulation QPSK - NR in NR/ESS Setup (NB-IoT)
Carrier Bandwidth 10.0 MHz - Channel Position B - Band 1 - Range 0.009 to 3500 MHz

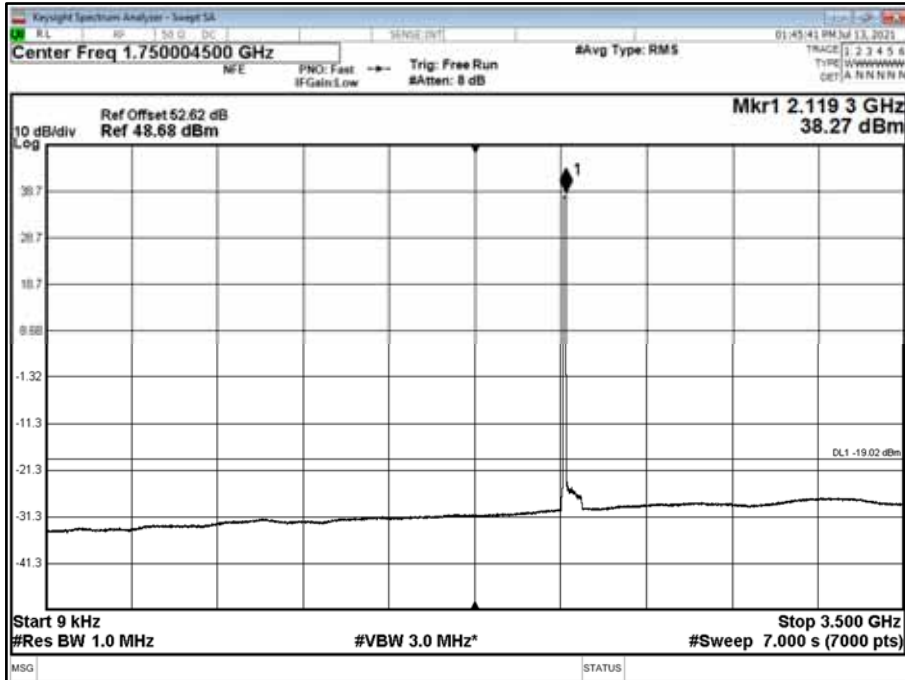

Antenna A - NR in NR/ESS Setup (NB-IoT) Modulation QPSK - NR in NR/ESS Setup (NB-IoT)
Carrier Bandwidth 10.0 MHz - Channel Position M - Band 1 - Range 0.009 to 3500 MHz

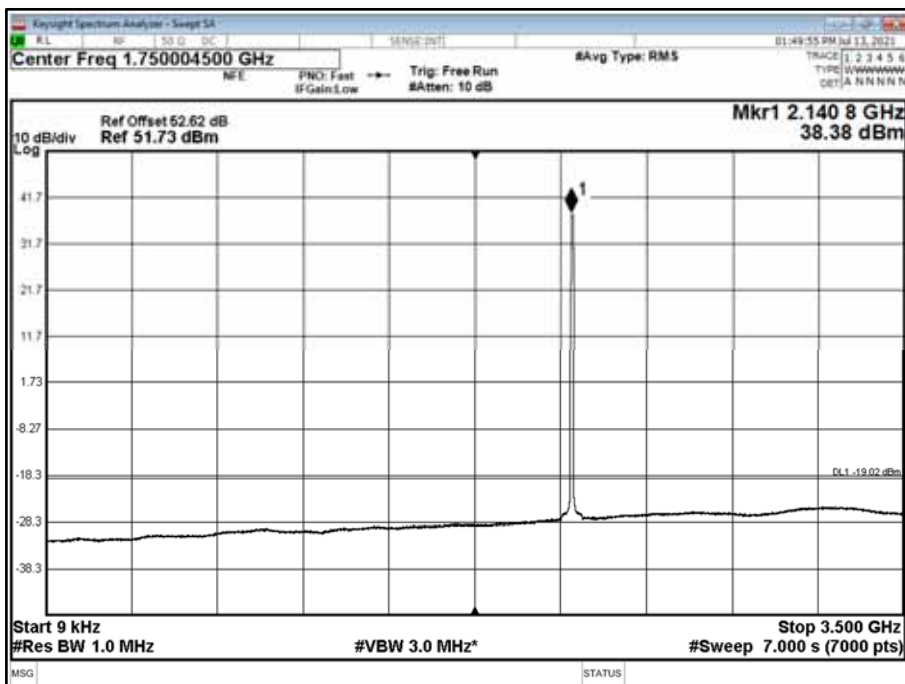



Antenna A - NR in NR/ESS Setup (NB-IoT) Modulation QPSK - NR in NR/ESS Setup (NB-IoT)
Carrier Bandwidth 10.0 MHz - Channel Position T - Band 1 - Range 0.009 to 3500 MHz

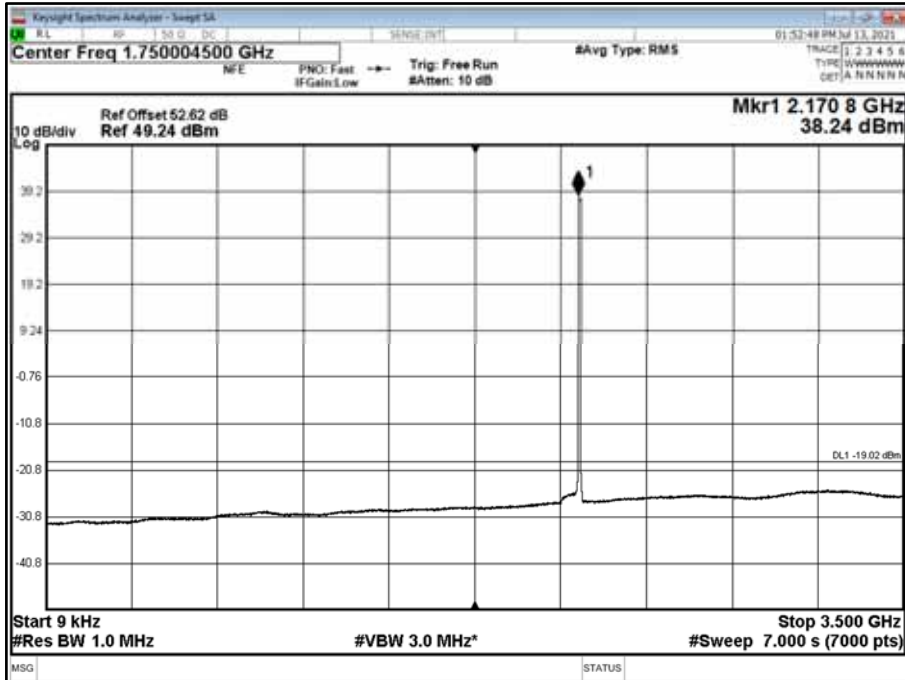

Antenna A - NR in NR/ESS Setup (NB-IoT) Modulation QPSK - NR in NR/ESS Setup (NB-IoT)
Carrier Bandwidth 10.0 MHz - Channel Position B - Band 2 - Range 3500 to 8000 MHz

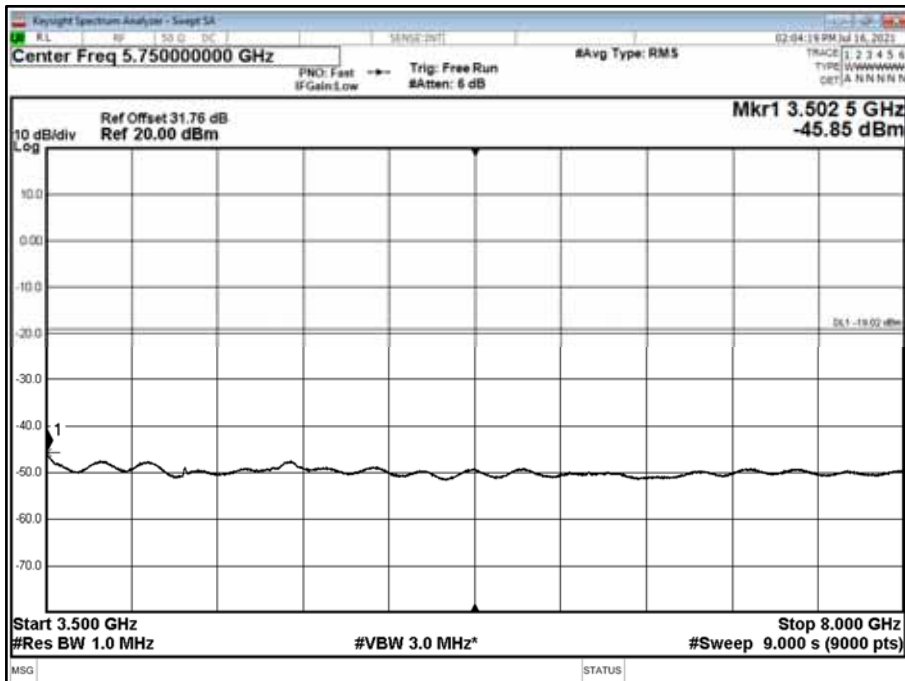



Antenna A - NR in NR/ESS Setup (NB-IoT) Modulation QPSK - NR in NR/ESS Setup (NB-IoT)
Carrier Bandwidth 10.0 MHz - Channel Position M - Band 2 - Range 3500 to 8000 MHz

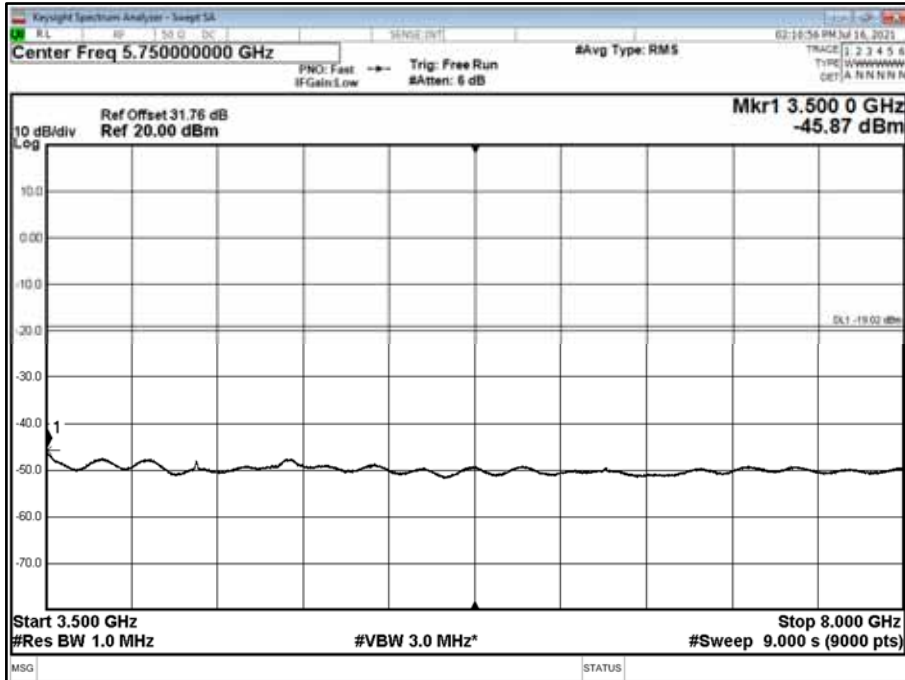

Antenna A - NR in NR/ESS Setup (NB-IoT) Modulation QPSK - NR in NR/ESS Setup (NB-IoT)
Carrier Bandwidth 10.0 MHz - Channel Position T - Band 2 - Range 3500 to 8000 MHz

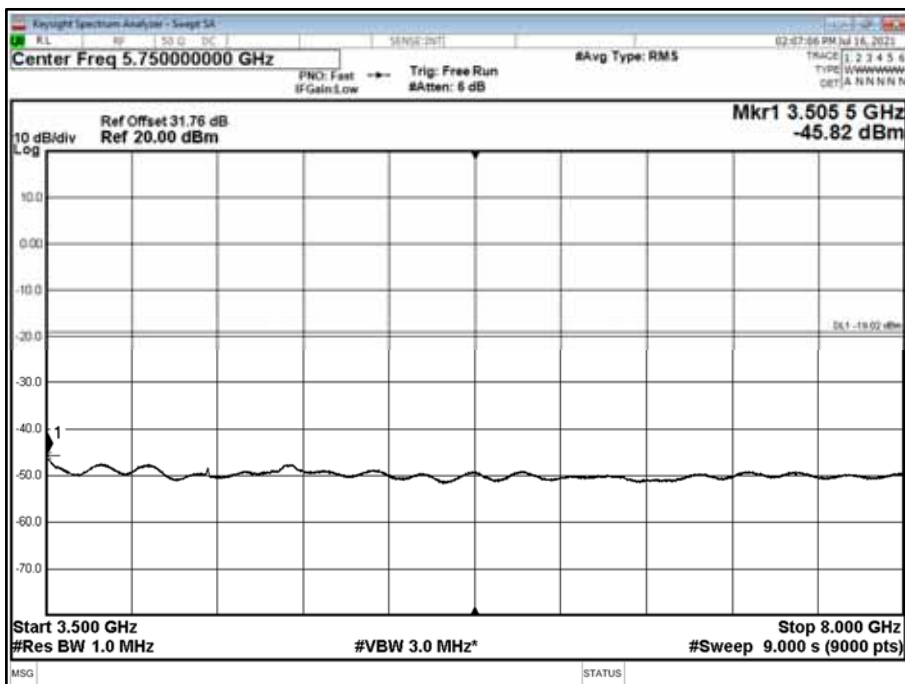



Antenna A - NR in NR/ESS Setup (NB-IoT) Modulation QPSK - NR in NR/ESS Setup (NB-IoT)
Carrier Bandwidth 10.0 MHz - Channel Position B - Band 3 - Range 8000 to 12000 MHz

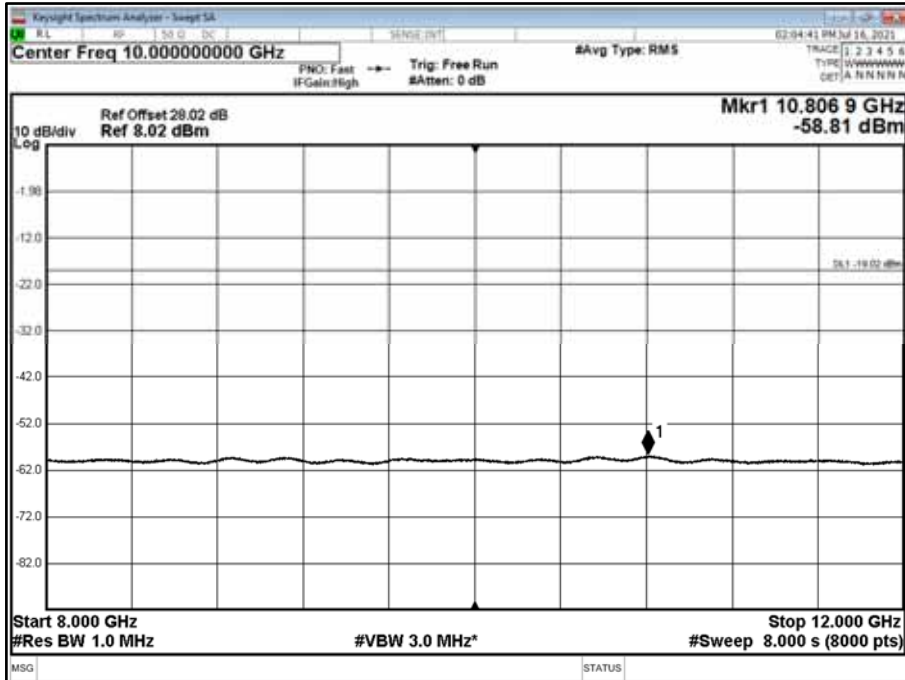

Antenna A - NR in NR/ESS Setup (NB-IoT) Modulation QPSK - NR in NR/ESS Setup (NB-IoT)
Carrier Bandwidth 10.0 MHz - Channel Position M - Band 3 - Range 8000 to 12000 MHz

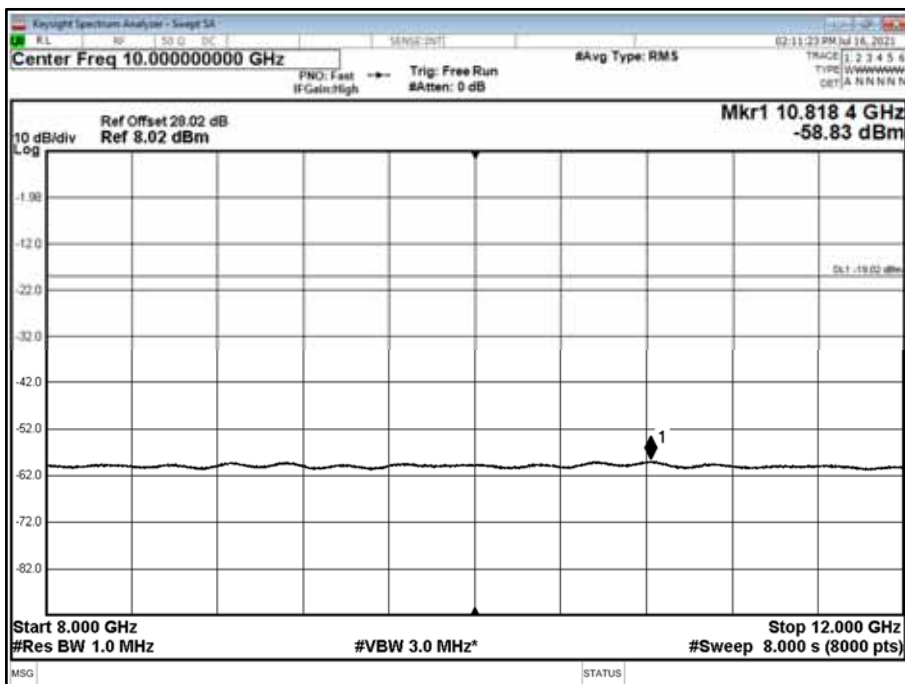



Antenna A - NR in NR/ESS Setup (NB-IoT) Modulation QPSK - NR in NR/ESS Setup (NB-IoT)
Carrier Bandwidth 10.0 MHz - Channel Position T - Band 3 - Range 8000 to 12000 MHz

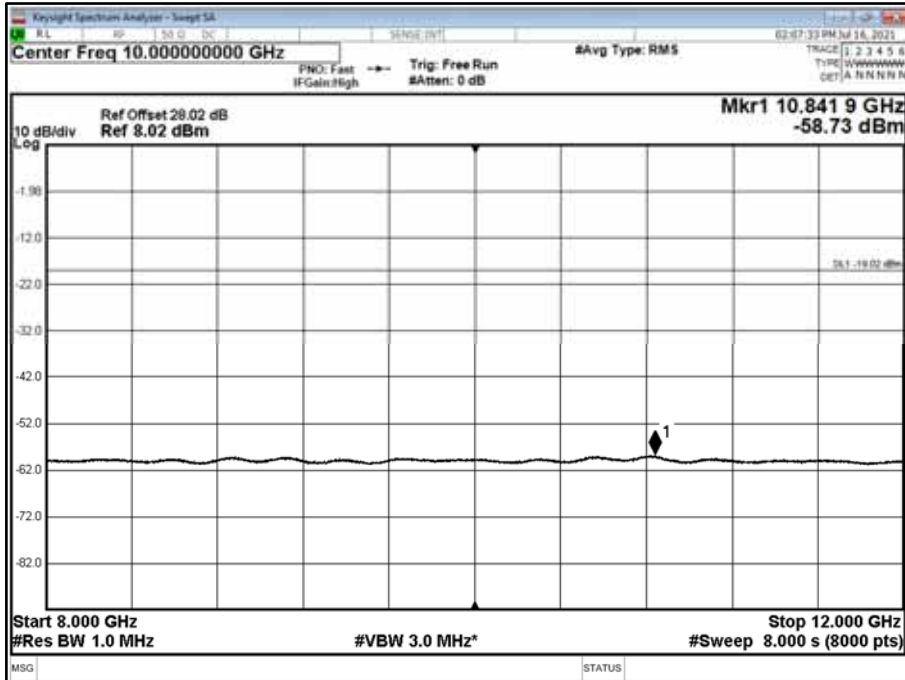

Antenna A - NR in NR/ESS Setup (NB-IoT) Modulation QPSK - NR in NR/ESS Setup (NB-IoT)
Carrier Bandwidth 10.0 MHz - Channel Position B - Band 4 - Range 12000 to 18000 MHz

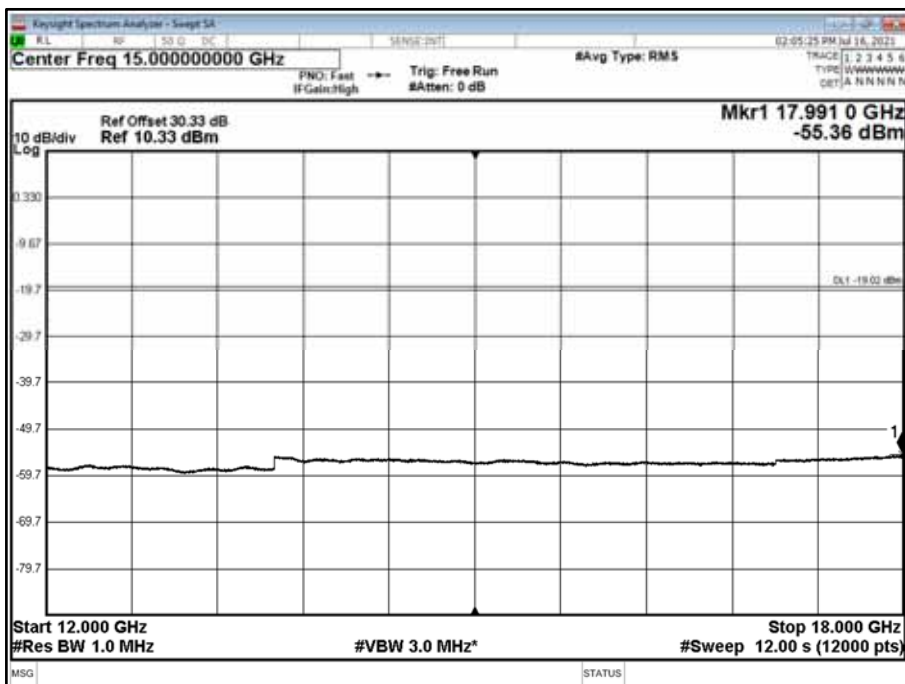



Antenna A - NR in NR/ESS Setup (NB-IoT) Modulation QPSK - NR in NR/ESS Setup (NB-IoT)
Carrier Bandwidth 10.0 MHz - Channel Position M - Band 4 - Range 12000 to 18000 MHz

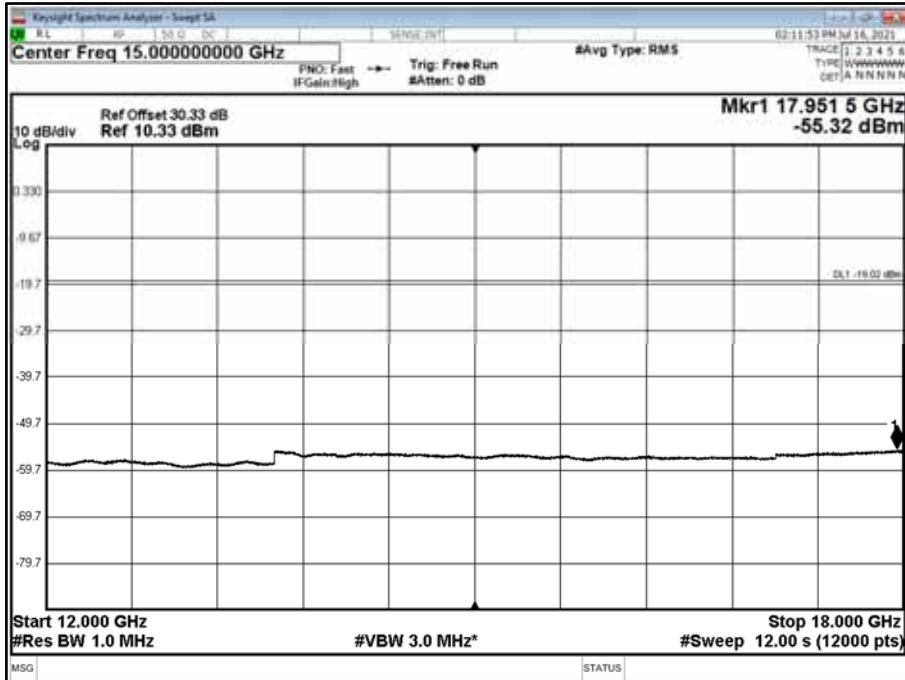

Antenna A - NR in NR/ESS Setup (NB-IoT) Modulation QPSK - NR in NR/ESS Setup (NB-IoT)
Carrier Bandwidth 10.0 MHz - Channel Position T - Band 4 - Range 12000 to 18000 MHz

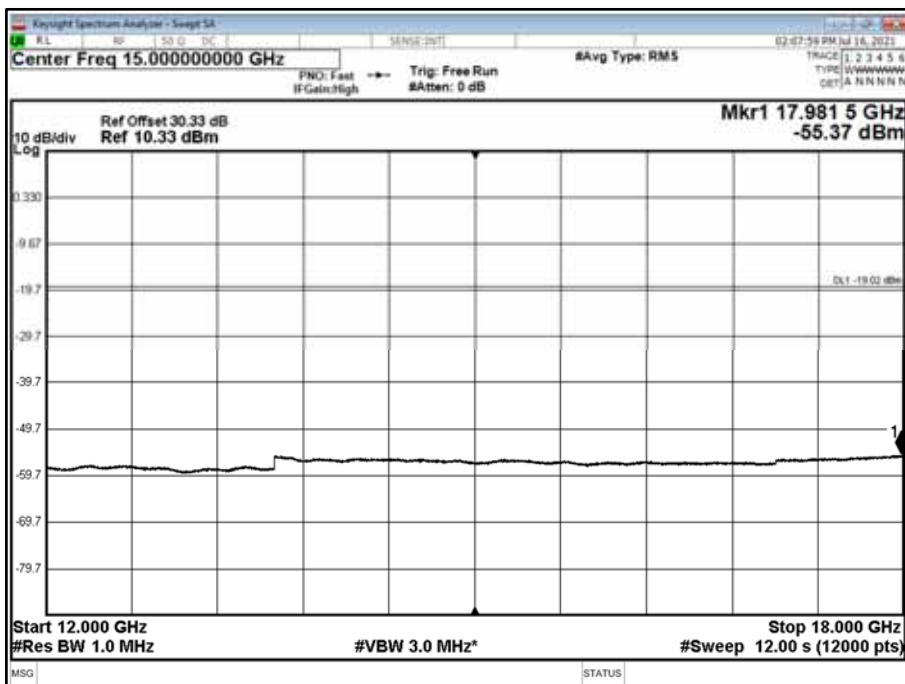



Antenna A - NR in NR/ESS Setup (NB-IoT) Modulation QPSK - NR in NR/ESS Setup (NB-IoT)
Carrier Bandwidth 10.0 MHz - Channel Position B - Band 5 - Range 18000 to 22000 MHz

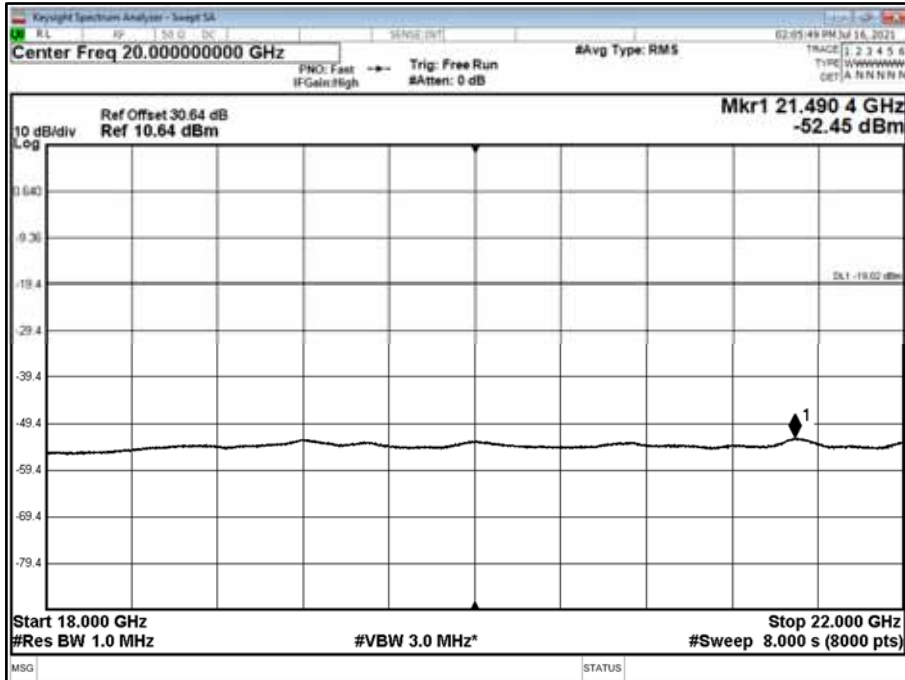

Antenna A - NR in NR/ESS Setup (NB-IoT) Modulation QPSK - NR in NR/ESS Setup (NB-IoT)
Carrier Bandwidth 10.0 MHz - Channel Position M - Band 5 - Range 18000 to 22000 MHz

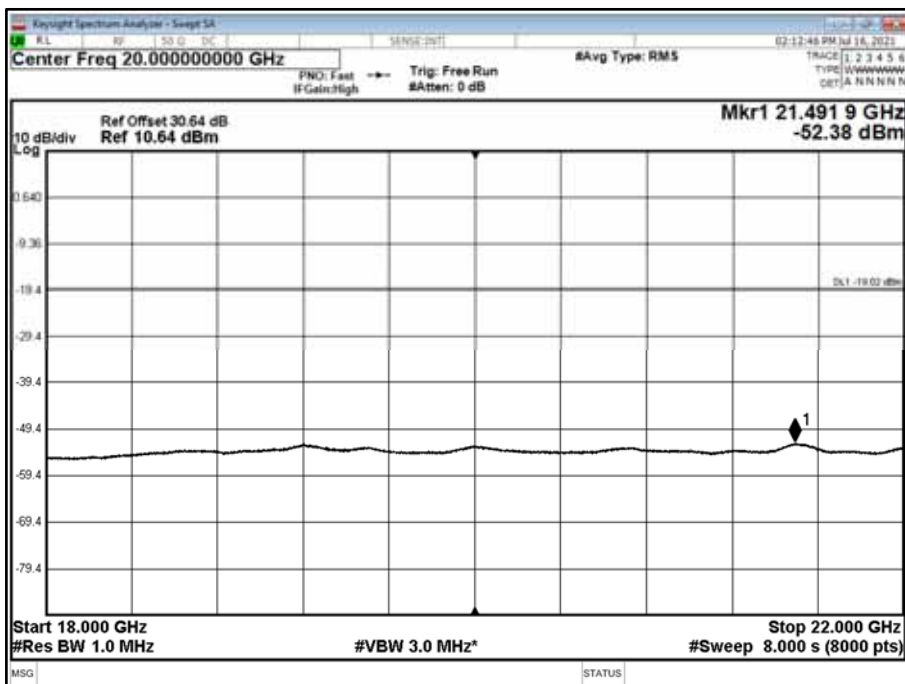



Antenna A - NR in NR/ESS Setup (NB-IoT) Modulation QPSK - NR in NR/ESS Setup (NB-IoT)
Carrier Bandwidth 10.0 MHz - Channel Position T - Band 5 - Range 18000 to 22000 MHz

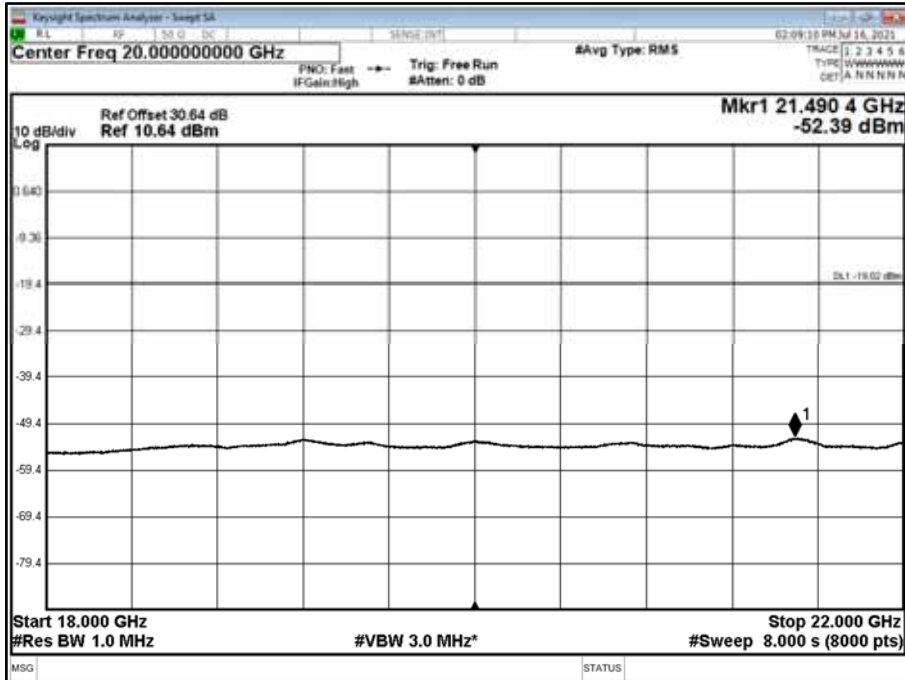

Antenna A - NR in NR/ESS Setup (NB-IoT) Modulation QPSK - NR in NR/ESS Setup (NB-IoT)
Carrier Bandwidth 15.0 MHz - Channel Position B - Band 1 - Range 0.009 to 3500 MHz

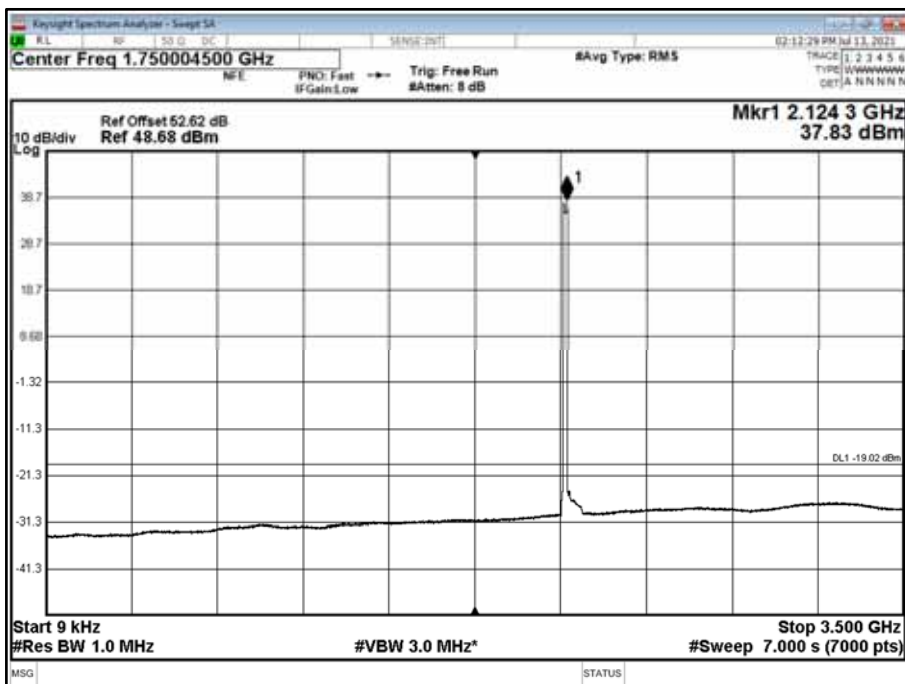



Antenna A - NR in NR/ESS Setup (NB-IoT) Modulation QPSK - NR in NR/ESS Setup (NB-IoT)
Carrier Bandwidth 15.0 MHz - Channel Position M - Band 1 - Range 0.009 to 3500 MHz

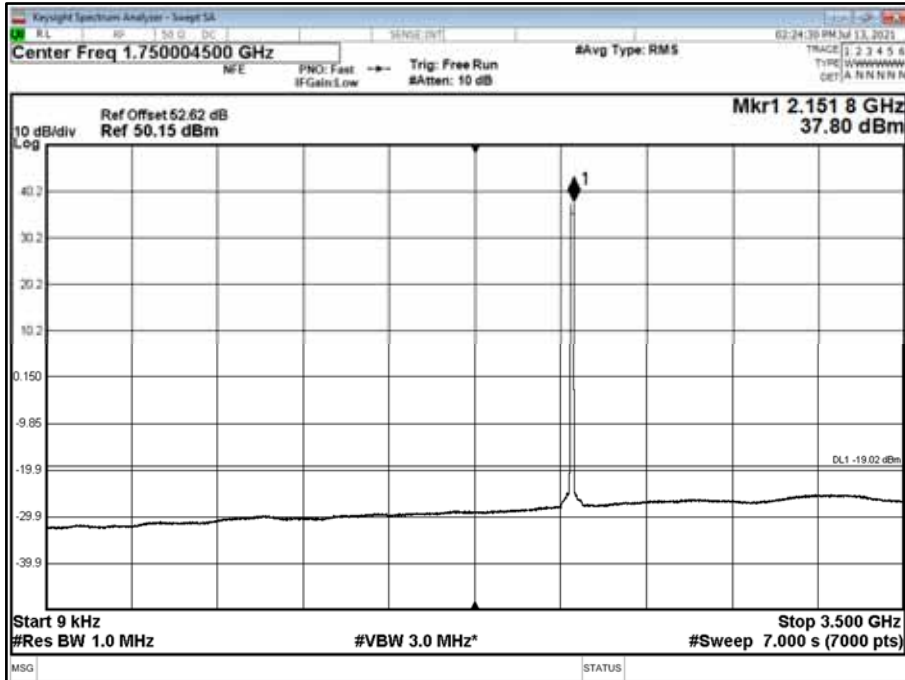

Antenna A - NR in NR/ESS Setup (NB-IoT) Modulation QPSK - NR in NR/ESS Setup (NB-IoT)
Carrier Bandwidth 15.0 MHz - Channel Position T - Band 1 - Range 0.009 to 3500 MHz

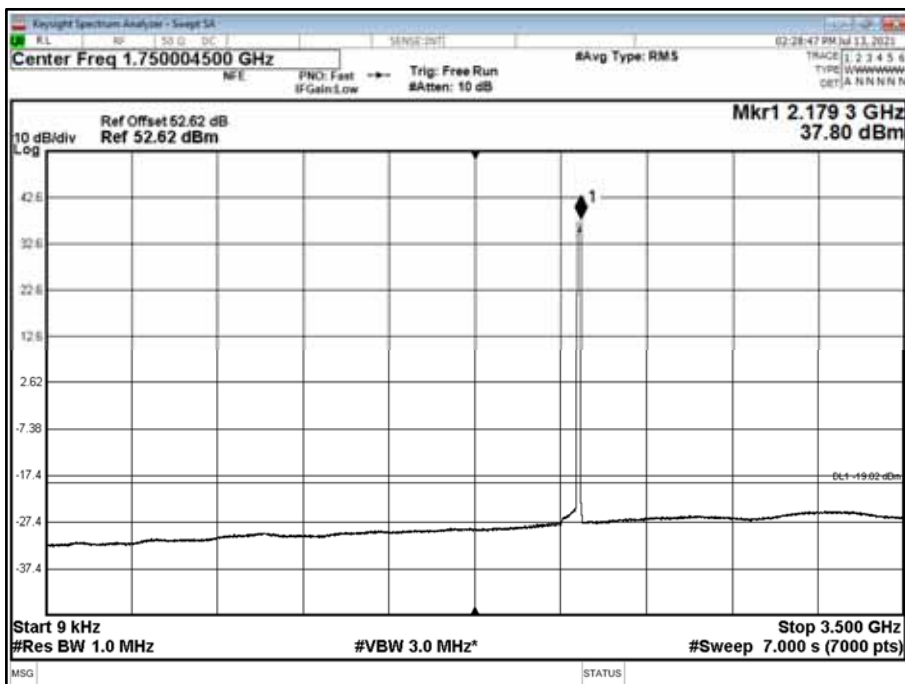



Antenna A - NR in NR/ESS Setup (NB-IoT) Modulation QPSK - NR in NR/ESS Setup (NB-IoT)
Carrier Bandwidth 15.0 MHz - Channel Position B - Band 2 - Range 3500 to 8000 MHz

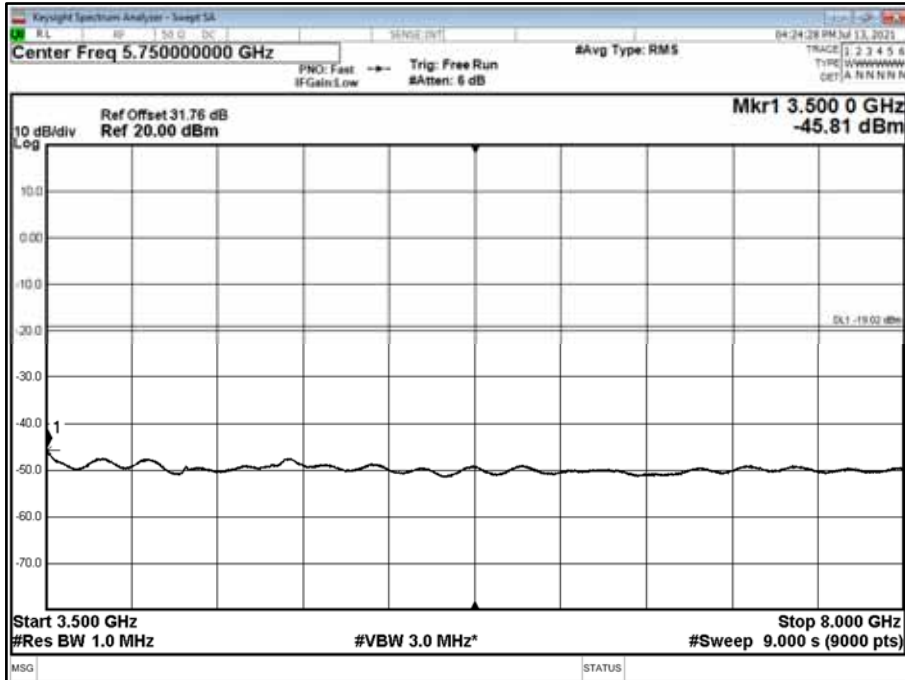

Antenna A - NR in NR/ESS Setup (NB-IoT) Modulation QPSK - NR in NR/ESS Setup (NB-IoT)
Carrier Bandwidth 15.0 MHz - Channel Position M - Band 2 - Range 3500 to 8000 MHz

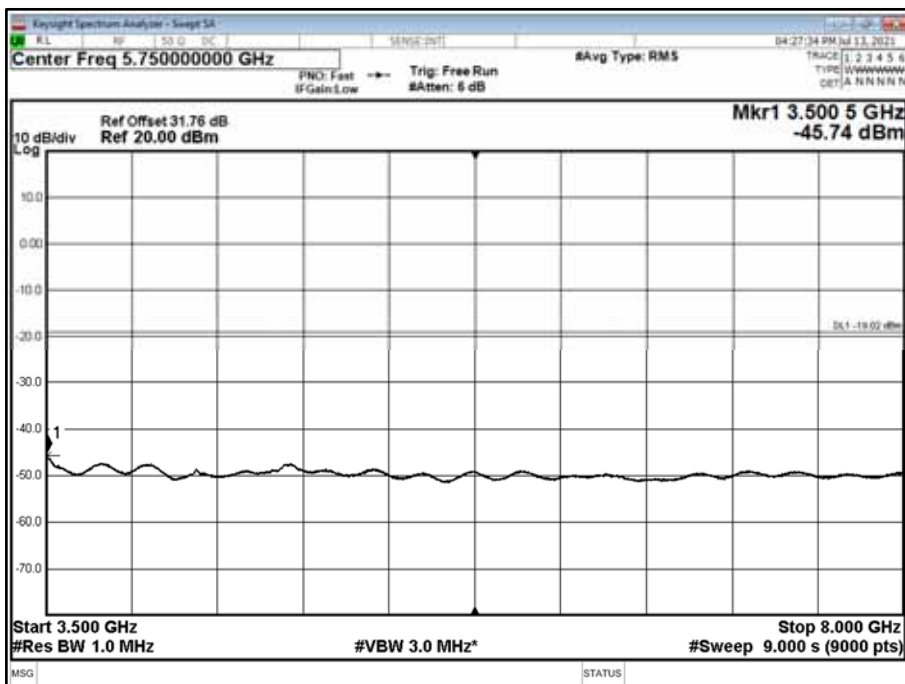



Antenna A - NR in NR/ESS Setup (NB-IoT) Modulation QPSK - NR in NR/ESS Setup (NB-IoT)
Carrier Bandwidth 15.0 MHz - Channel Position T - Band 2 - Range 3500 to 8000 MHz

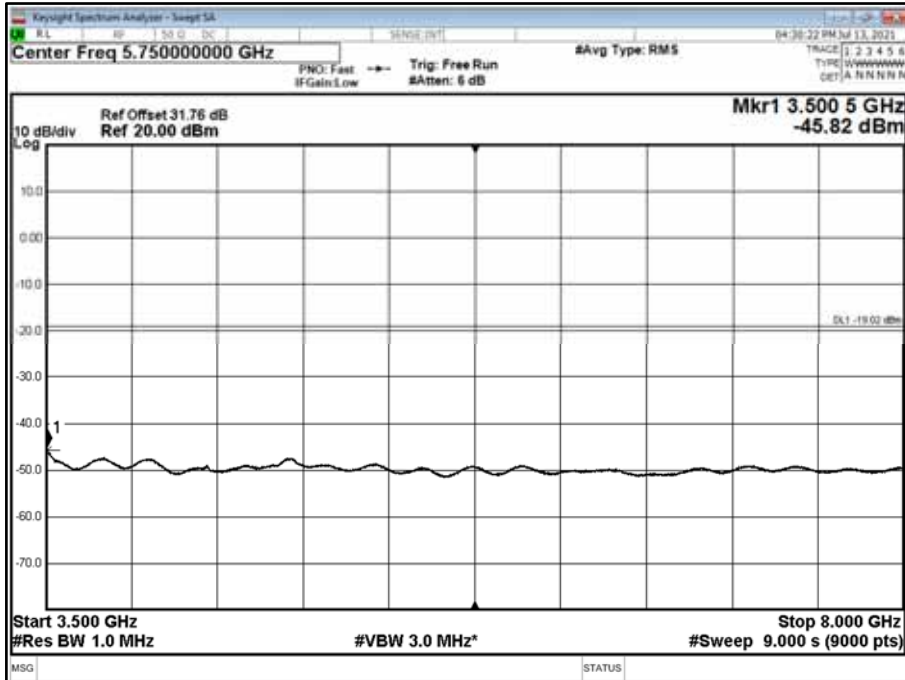

Antenna A - NR in NR/ESS Setup (NB-IoT) Modulation QPSK - NR in NR/ESS Setup (NB-IoT)
Carrier Bandwidth 15.0 MHz - Channel Position B - Band 3 - Range 8000 to 12000 MHz

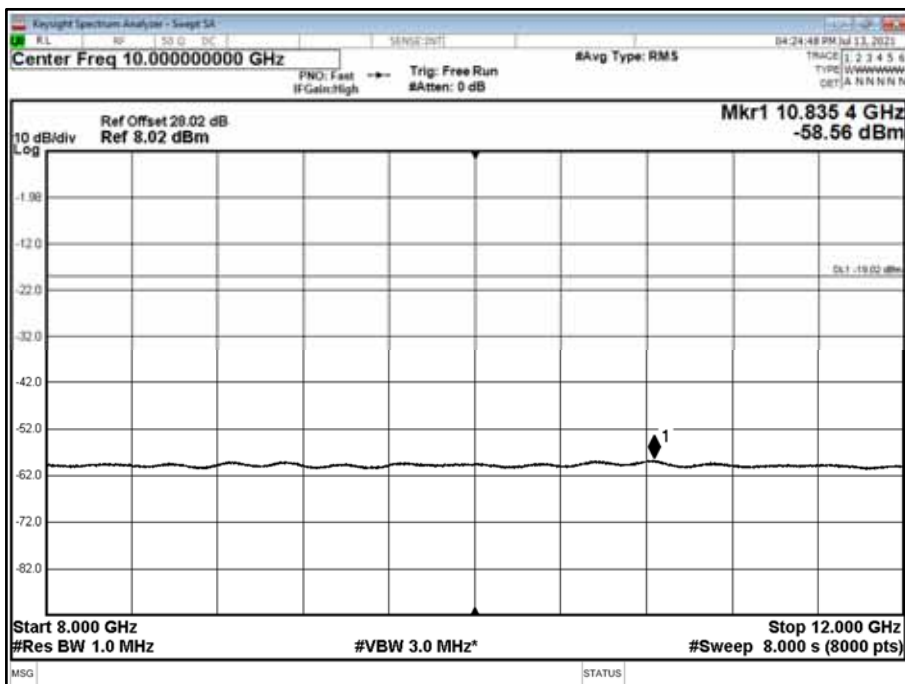



Antenna A - NR in NR/ESS Setup (NB-IoT) Modulation QPSK - NR in NR/ESS Setup (NB-IoT)
Carrier Bandwidth 15.0 MHz - Channel Position M - Band 3 - Range 8000 to 12000 MHz

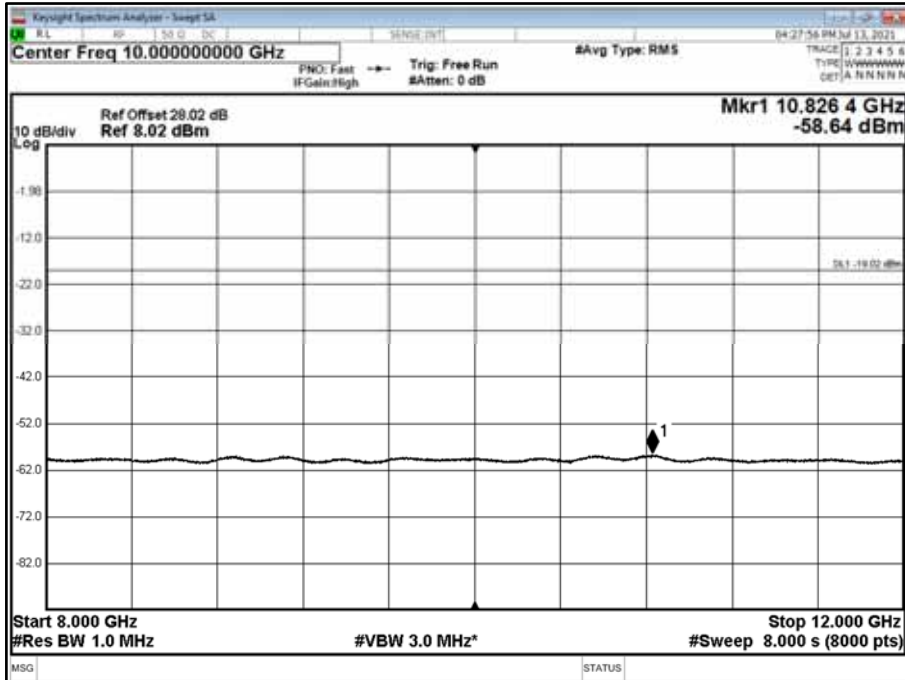

Antenna A - NR in NR/ESS Setup (NB-IoT) Modulation QPSK - NR in NR/ESS Setup (NB-IoT)
Carrier Bandwidth 15.0 MHz - Channel Position T - Band 3 - Range 8000 to 12000 MHz

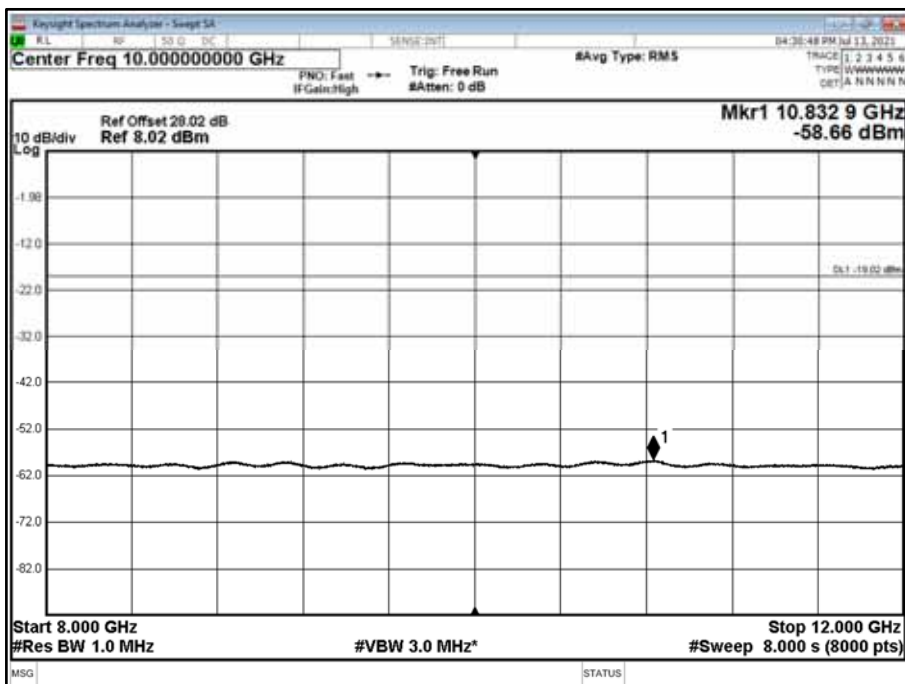



Antenna A - NR in NR/ESS Setup (NB-IoT) Modulation QPSK - NR in NR/ESS Setup (NB-IoT)
Carrier Bandwidth 15.0 MHz - Channel Position B - Band 4 - Range 12000 to 18000 MHz

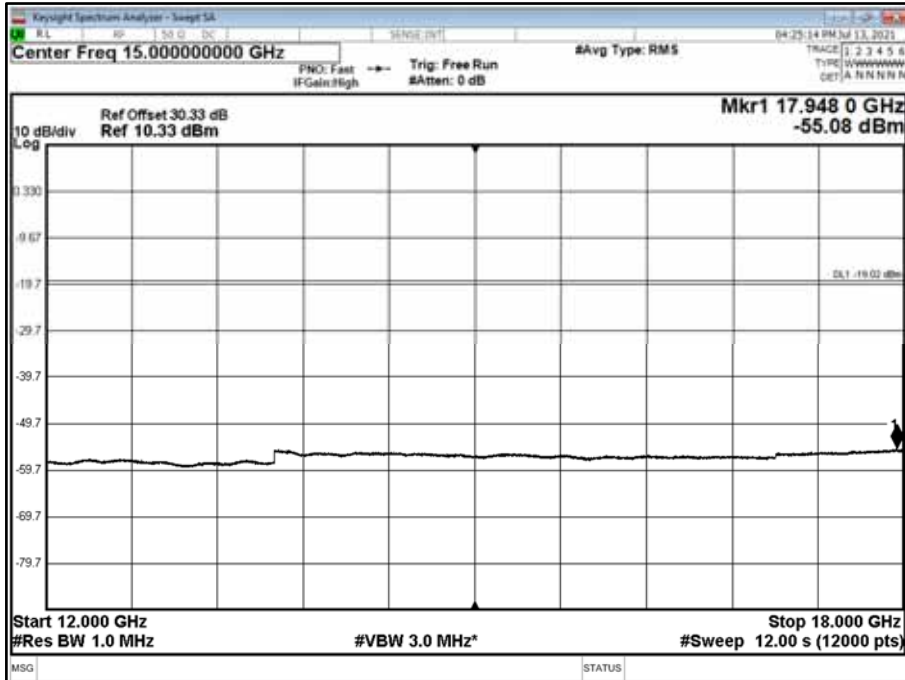

Antenna A - NR in NR/ESS Setup (NB-IoT) Modulation QPSK - NR in NR/ESS Setup (NB-IoT)
Carrier Bandwidth 15.0 MHz - Channel Position M - Band 4 - Range 12000 to 18000 MHz

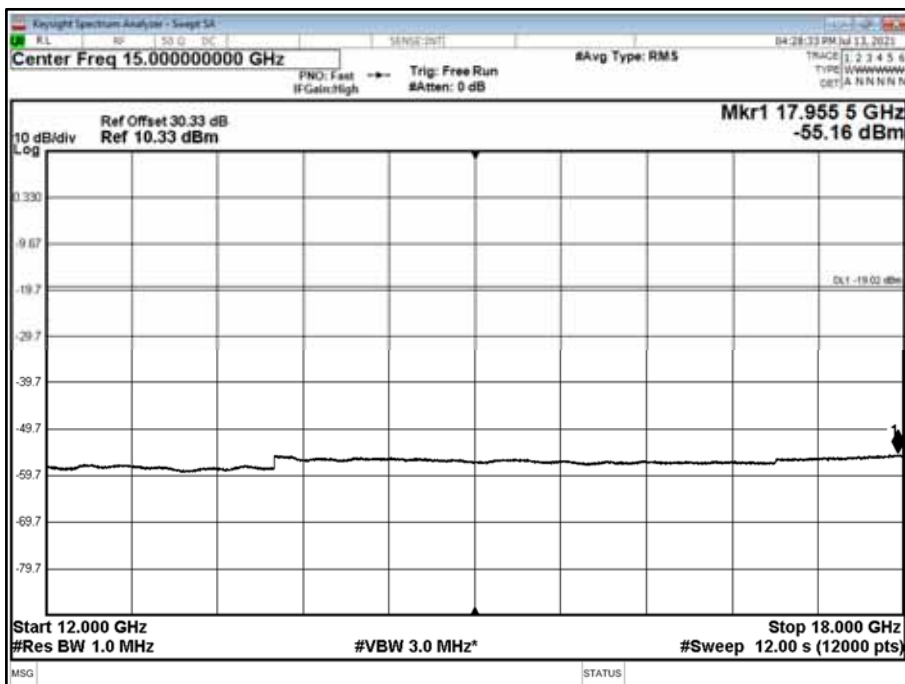



Antenna A - NR in NR/ESS Setup (NB-IoT) Modulation QPSK - NR in NR/ESS Setup (NB-IoT)
Carrier Bandwidth 15.0 MHz - Channel Position T - Band 4 - Range 12000 to 18000 MHz

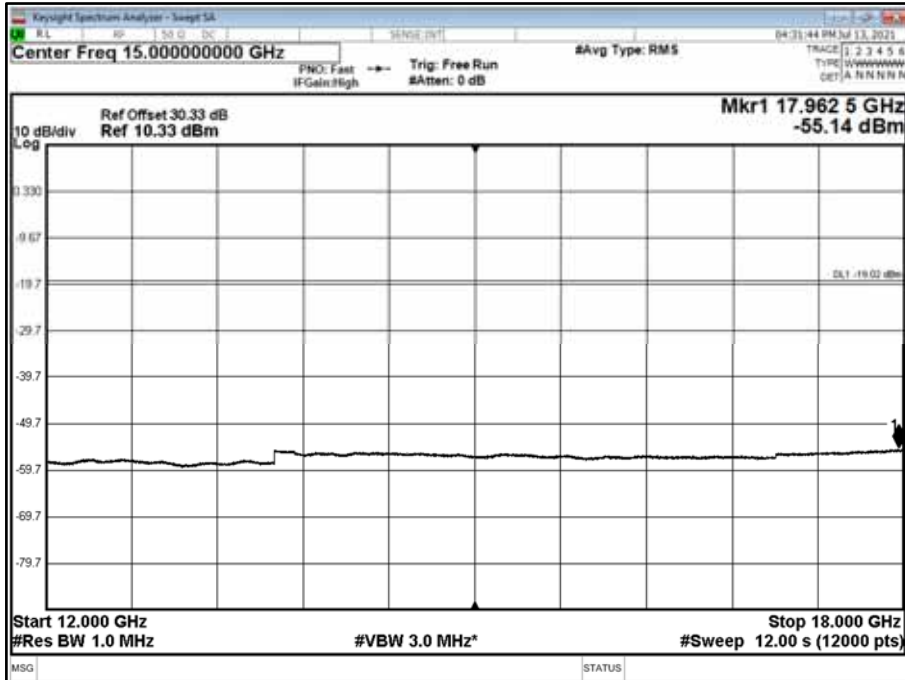

Antenna A - NR in NR/ESS Setup (NB-IoT) Modulation QPSK - NR in NR/ESS Setup (NB-IoT)
Carrier Bandwidth 15.0 MHz - Channel Position B - Band 5 - Range 18000 to 22000 MHz

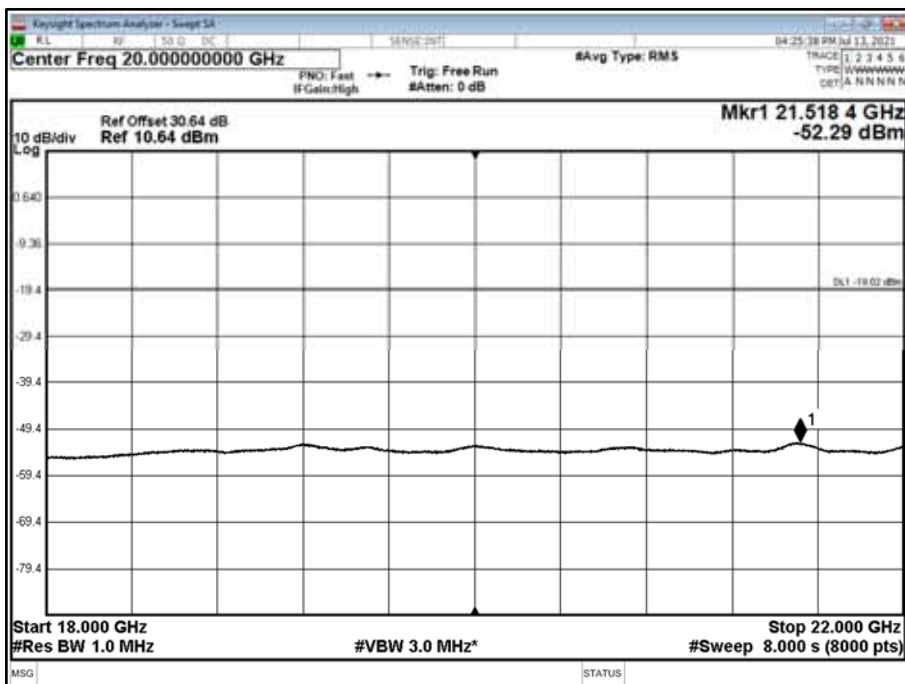



Antenna A - NR in NR/ESS Setup (NB-IoT) Modulation QPSK - NR in NR/ESS Setup (NB-IoT)
Carrier Bandwidth 15.0 MHz - Channel Position M - Band 5 - Range 18000 to 22000 MHz

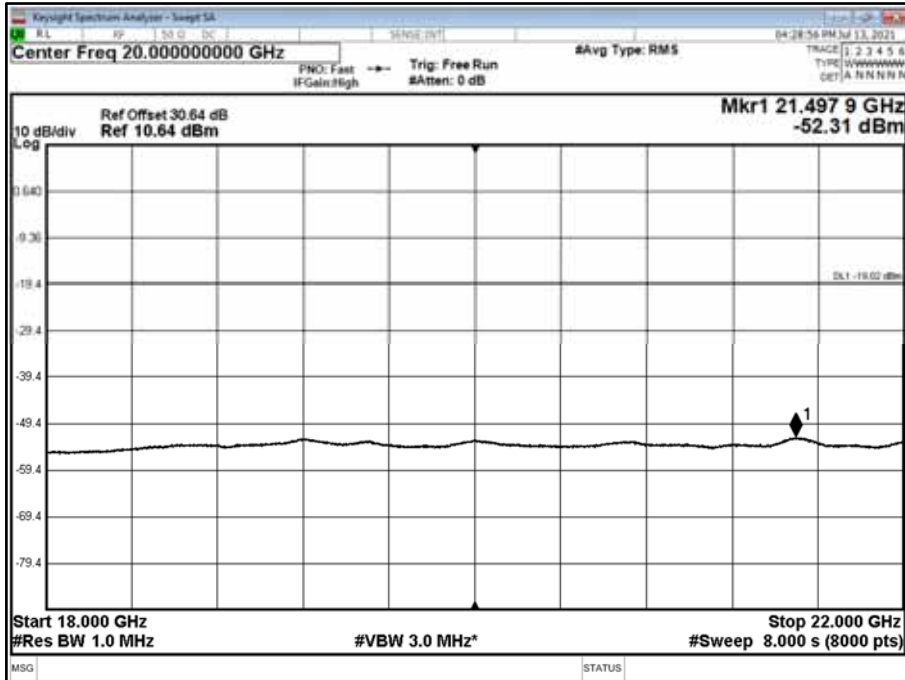

Antenna A - NR in NR/ESS Setup (NB-IoT) Modulation QPSK - NR in NR/ESS Setup (NB-IoT)
Carrier Bandwidth 15.0 MHz - Channel Position T - Band 5 - Range 18000 to 22000 MHz

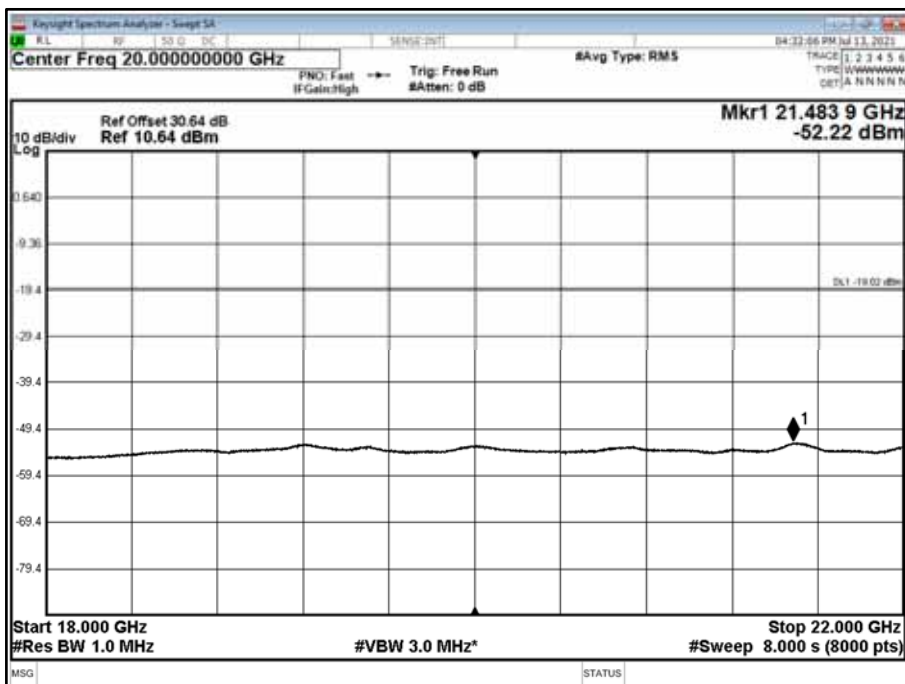



Antenna A - NR in NR/ESS Setup (NB-IoT) Modulation QPSK - NR in NR/ESS Setup (NB-IoT)
Carrier Bandwidth 20.0 MHz - Channel Position B - Band 1 - Range 0.009 to 3500 MHz

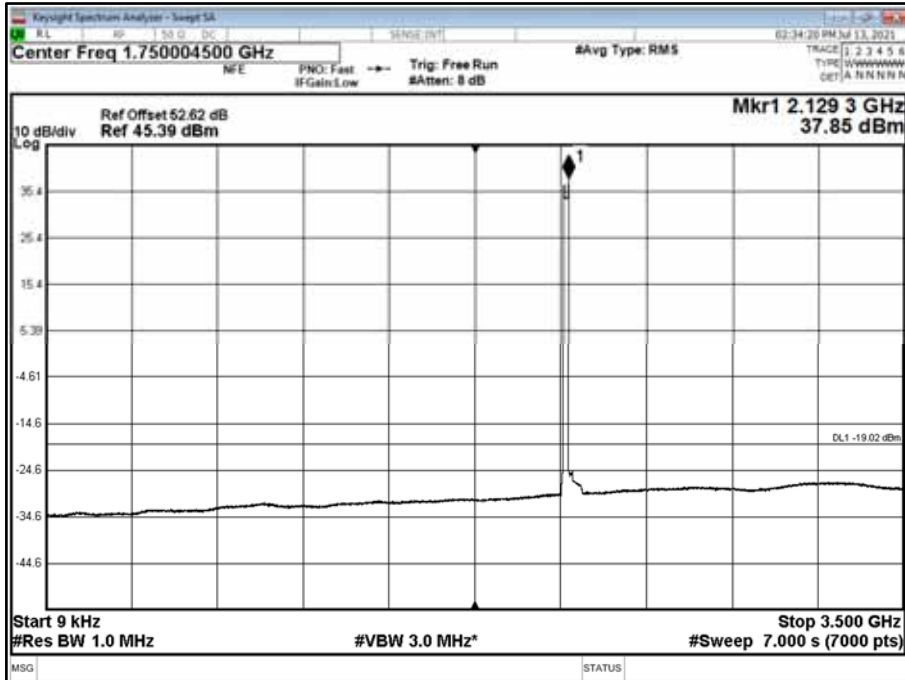

Antenna A - NR in NR/ESS Setup (NB-IoT) Modulation QPSK - NR in NR/ESS Setup (NB-IoT)
Carrier Bandwidth 20.0 MHz - Channel Position M - Band 1 - Range 0.009 to 3500 MHz

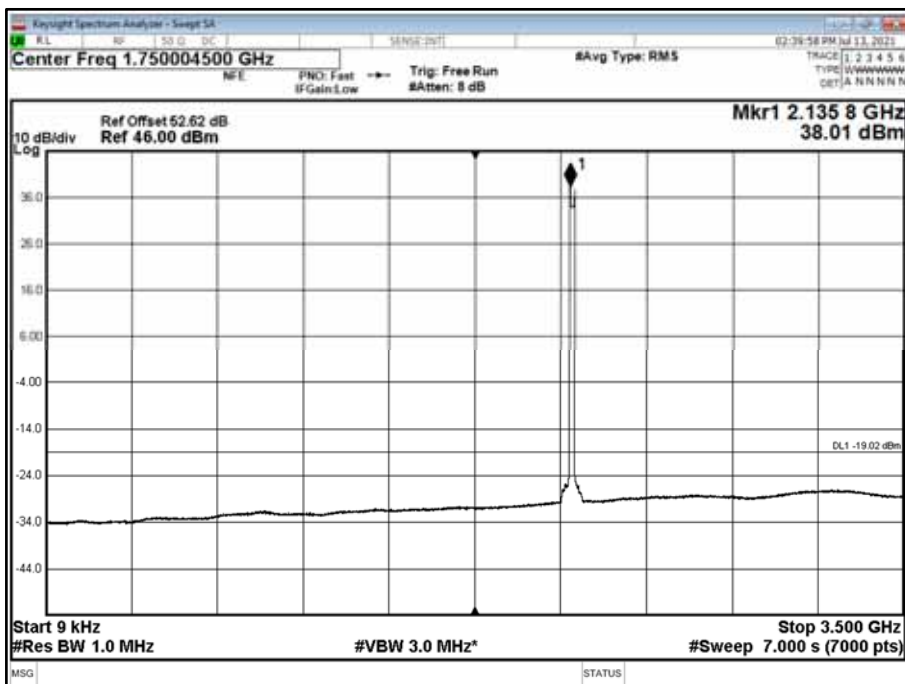



Antenna A - NR in NR/ESS Setup (NB-IoT) Modulation QPSK - NR in NR/ESS Setup (NB-IoT)
Carrier Bandwidth 20.0 MHz - Channel Position T - Band 1 - Range 0.009 to 3500 MHz

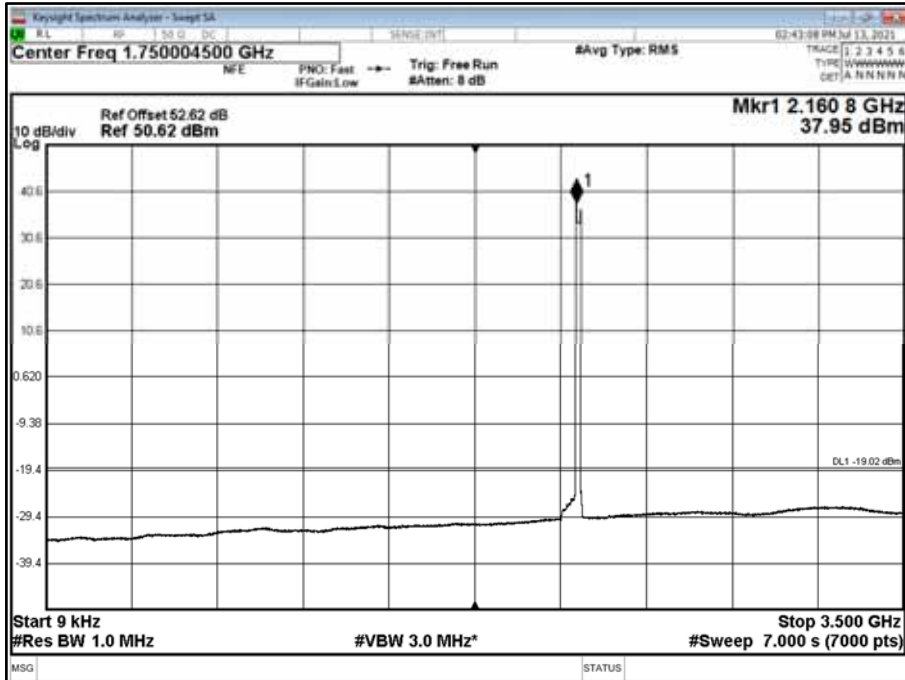

Antenna A - NR in NR/ESS Setup (NB-IoT) Modulation QPSK - NR in NR/ESS Setup (NB-IoT)
Carrier Bandwidth 20.0 MHz - Channel Position B - Band 2 - Range 3500 to 8000 MHz

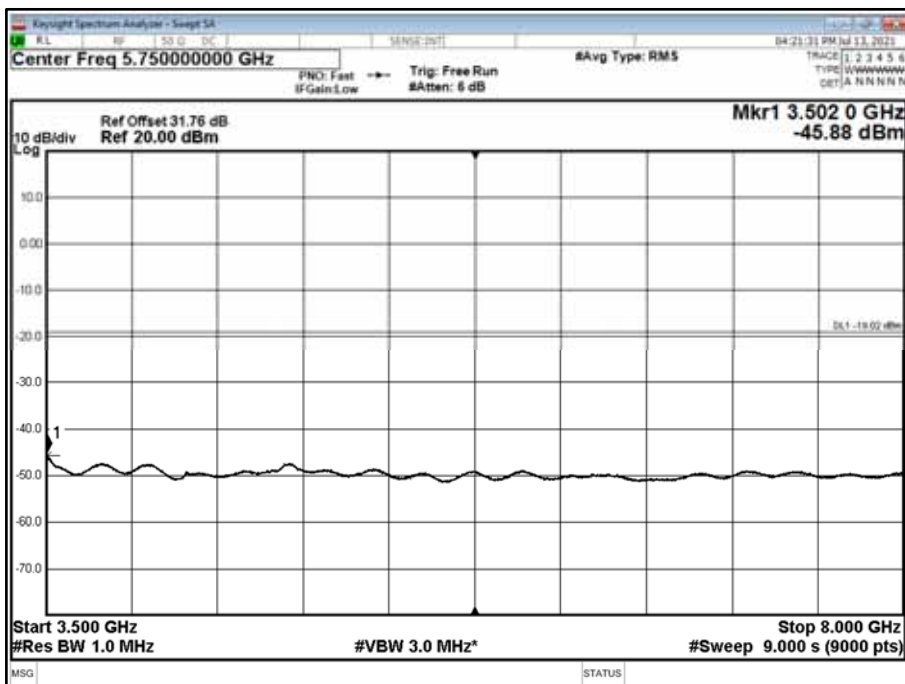



Antenna A - NR in NR/ESS Setup (NB-IoT) Modulation QPSK - NR in NR/ESS Setup (NB-IoT)
Carrier Bandwidth 20.0 MHz - Channel Position M - Band 2 - Range 3500 to 8000 MHz

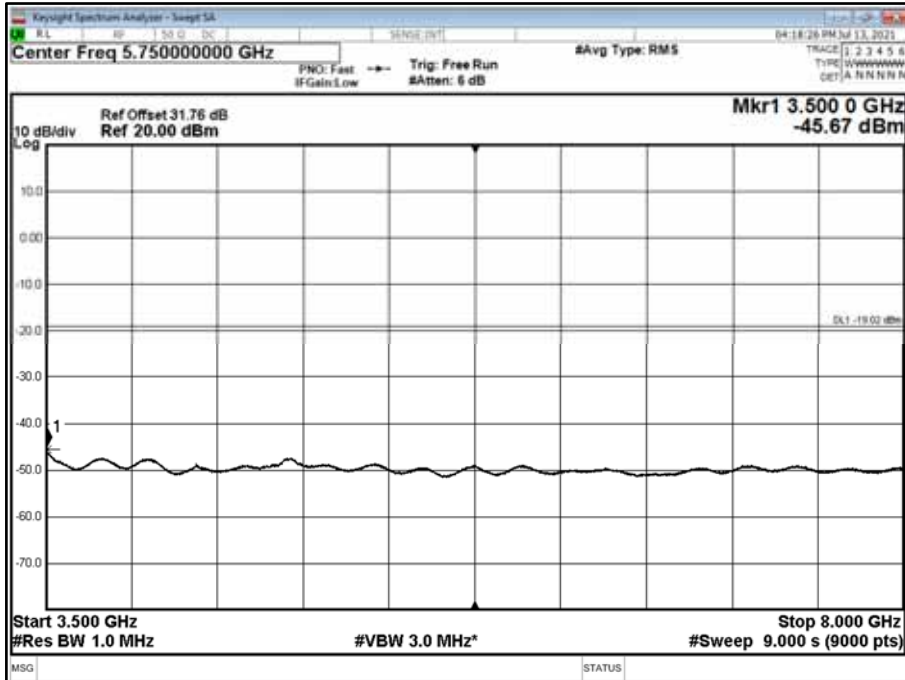

Antenna A - NR in NR/ESS Setup (NB-IoT) Modulation QPSK - NR in NR/ESS Setup (NB-IoT)
Carrier Bandwidth 20.0 MHz - Channel Position T - Band 2 - Range 3500 to 8000 MHz

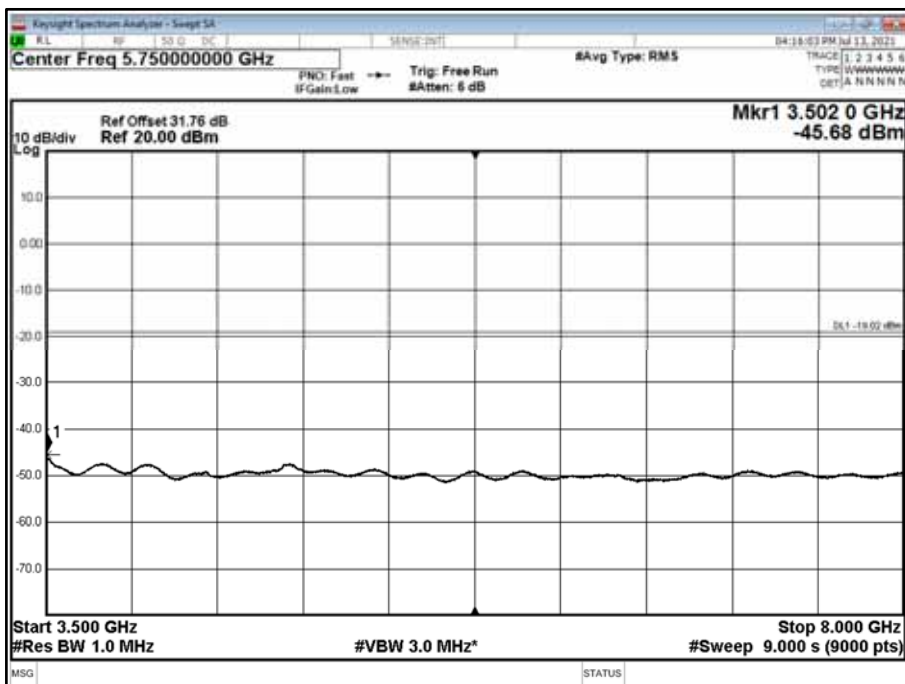



Antenna A - NR in NR/ESS Setup (NB-IoT) Modulation QPSK - NR in NR/ESS Setup (NB-IoT)
Carrier Bandwidth 20.0 MHz - Channel Position B - Band 3 - Range 8000 to 12000 MHz

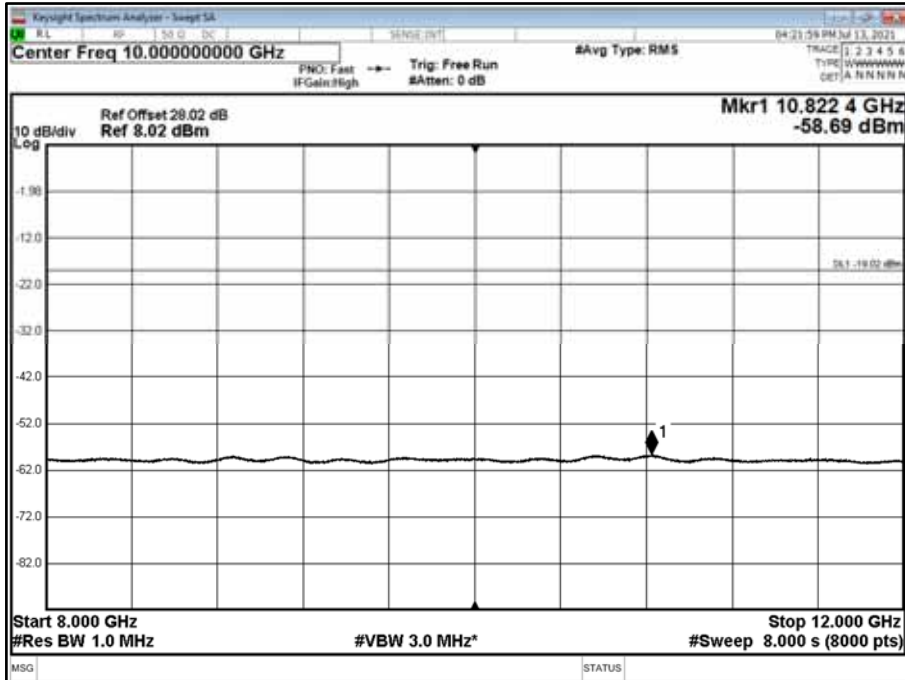

Antenna A - NR in NR/ESS Setup (NB-IoT) Modulation QPSK - NR in NR/ESS Setup (NB-IoT)
Carrier Bandwidth 20.0 MHz - Channel Position M - Band 3 - Range 8000 to 12000 MHz

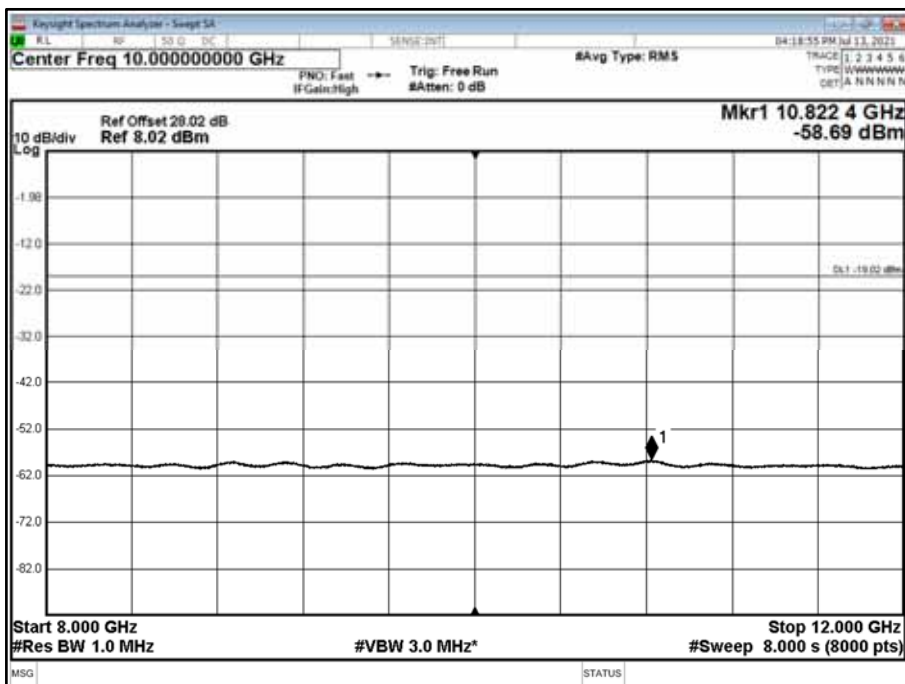



Antenna A - NR in NR/ESS Setup (NB-IoT) Modulation QPSK - NR in NR/ESS Setup (NB-IoT)
Carrier Bandwidth 20.0 MHz - Channel Position T - Band 3 - Range 8000 to 12000 MHz

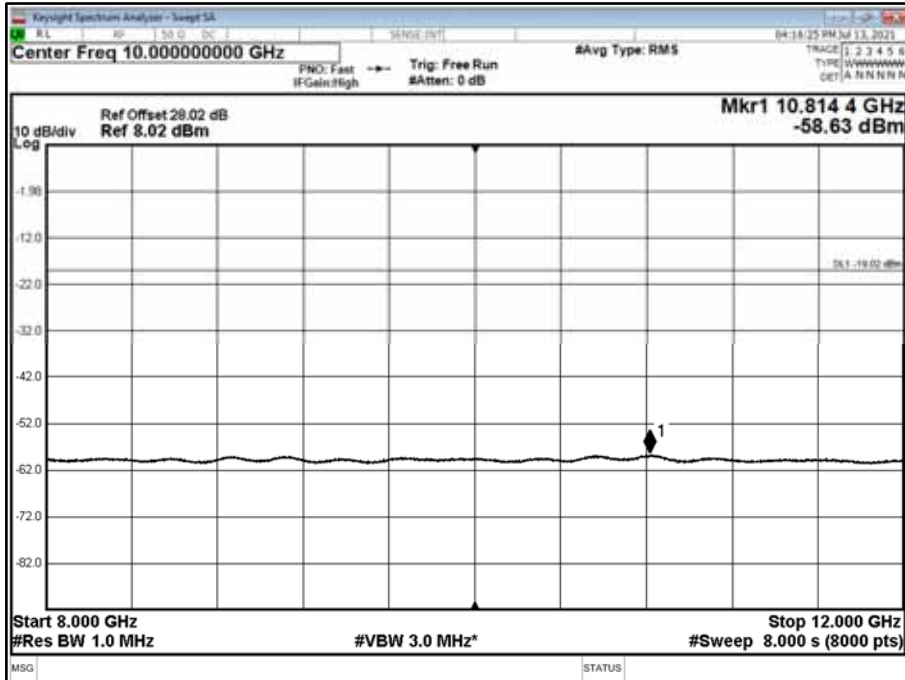

Antenna A - NR in NR/ESS Setup (NB-IoT) Modulation QPSK - NR in NR/ESS Setup (NB-IoT)
Carrier Bandwidth 20.0 MHz - Channel Position B - Band 4 - Range 12000 to 18000 MHz

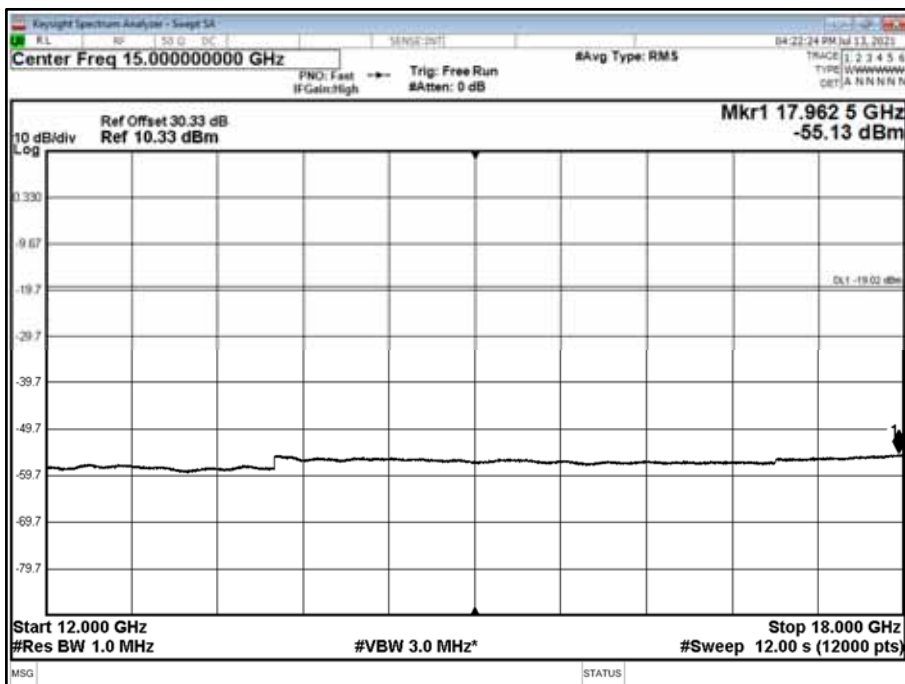



Antenna A - NR in NR/ESS Setup (NB-IoT) Modulation QPSK - NR in NR/ESS Setup (NB-IoT)
Carrier Bandwidth 20.0 MHz - Channel Position M - Band 4 - Range 12000 to 18000 MHz



Antenna A - NR in NR/ESS Setup (NB-IoT) Modulation QPSK - NR in NR/ESS Setup (NB-IoT)
Carrier Bandwidth 20.0 MHz - Channel Position T - Band 4 - Range 12000 to 18000 MHz

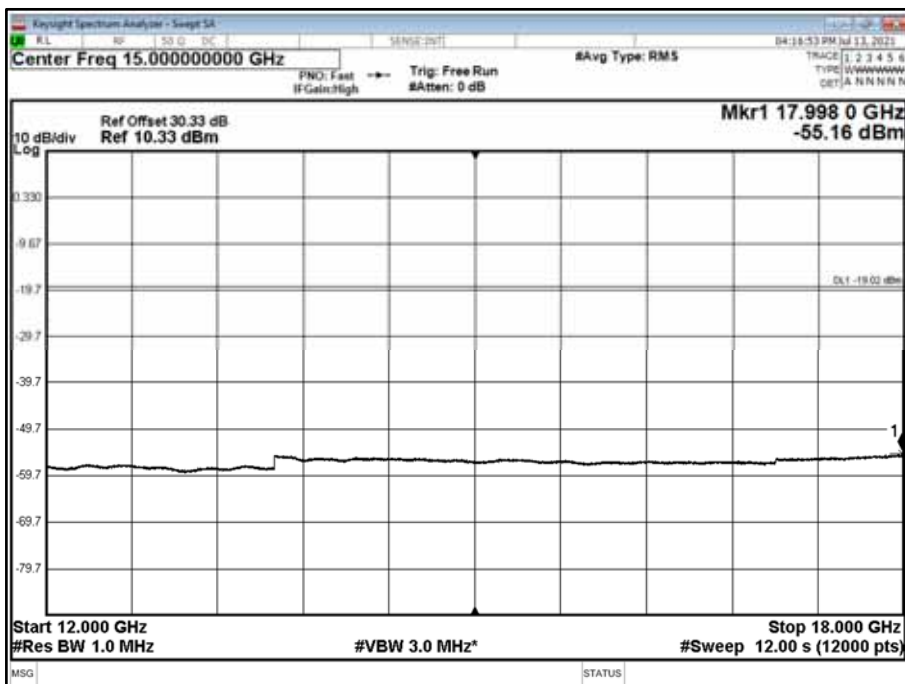



Antenna A - NR in NR/ESS Setup (NB-IoT) Modulation QPSK - NR in NR/ESS Setup (NB-IoT)
Carrier Bandwidth 20.0 MHz - Channel Position B - Band 5 - Range 18000 to 22000 MHz

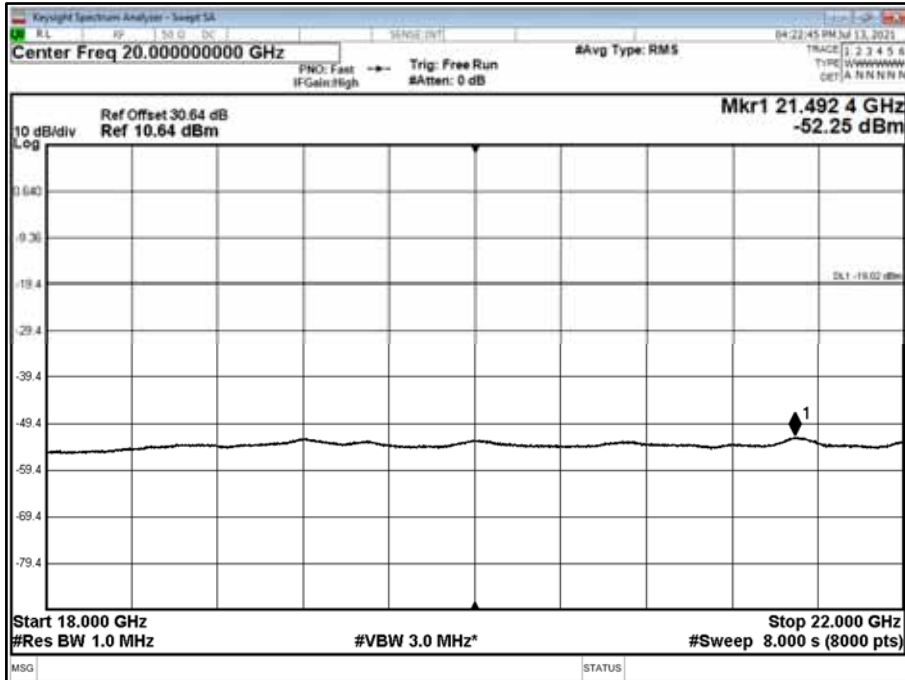

Antenna A - NR in NR/ESS Setup (NB-IoT) Modulation QPSK - NR in NR/ESS Setup (NB-IoT)
Carrier Bandwidth 20.0 MHz - Channel Position M - Band 5 - Range 18000 to 22000 MHz

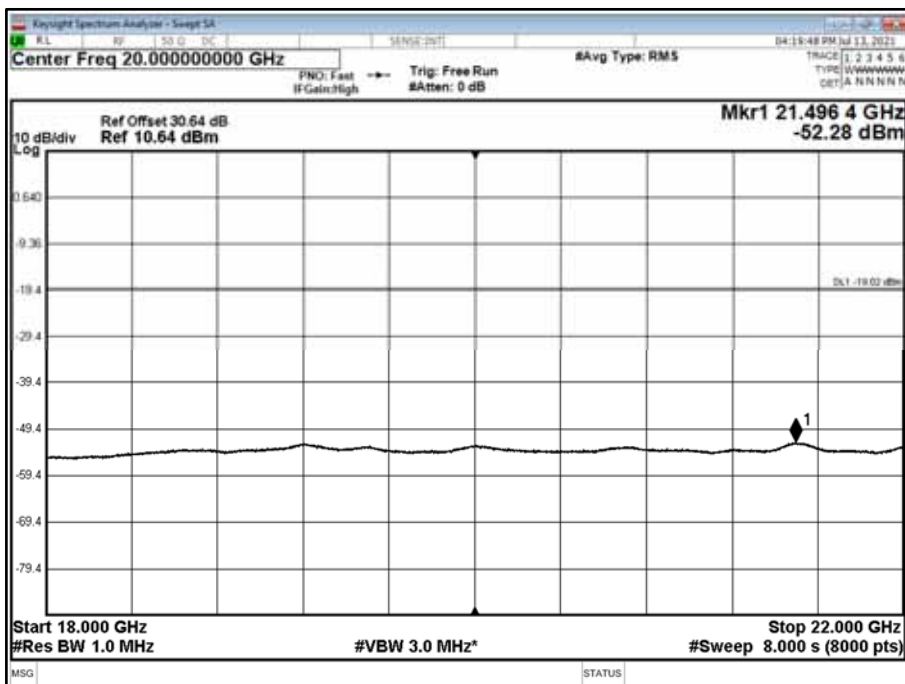



Antenna A - NR in NR/ESS Setup (NB-IoT) Modulation QPSK - NR in NR/ESS Setup (NB-IoT)
Carrier Bandwidth 20.0 MHz - Channel Position T - Band 5 - Range 18000 to 22000 MHz

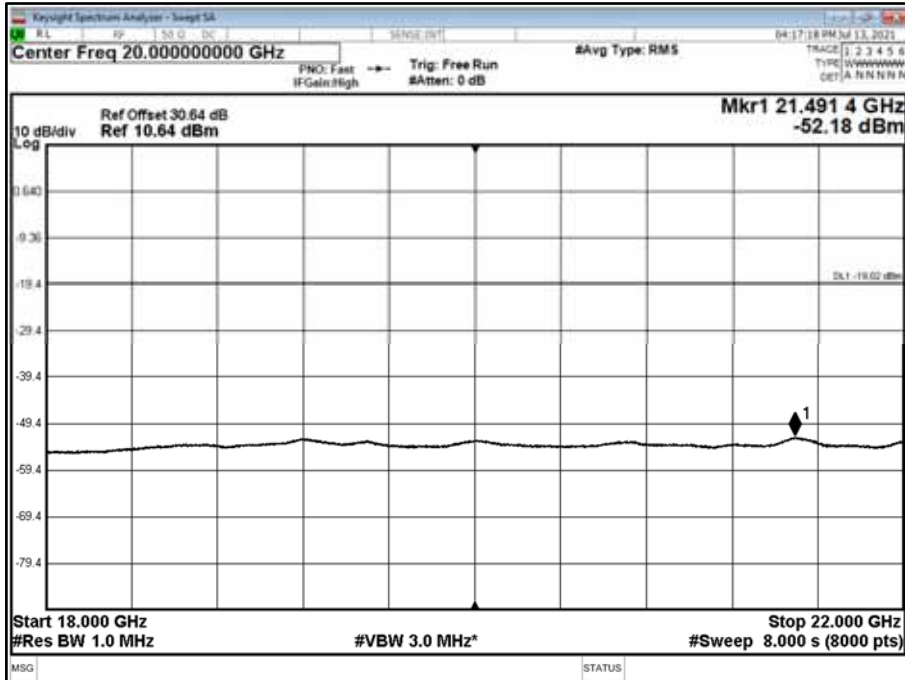

Limit 4.7.1

Limit	The power of any emission outside of the authorized operating frequency ranges must be attenuated below the transmitting power (P) by a factor of at least $43 + 10 \log(P)$ db.
-------	--

Limit 4.7.2

Limits	The power of any unwanted emissions in any 6.25 kHz bandwidth for all frequencies between 763-775 MHz and 793-806 MHz shall be attenuated below the transmitter power, P (dBW), by at least: $76 + 10 \log_{10} p$ (watts), dB, for base and fixed equipment
	The e.i.r.p. in the band 1559-1610 MHz shall not exceed -70 dBW/MHz for wideband signal and -80 dBW for discrete emission with bandwidth less than 700 Hz



SECTION 3

TEST EQUIPMENT USED



3.1 TEST EQUIPMENT USED

List of absolute measuring and other principal items of test equipment.

Instrument	Manufacturer	Type No.	TE No.	Calibration Period (months)	Calibration Due
Carrier Power					
PXA Signal Analyzer	Keysight	N9030A	BAMS-1001562403	12	14-Jan-2022
Network Analyzer (10MHz to 40 GHz)	Agilent Technologies	N5230A	BAMS-1000635869	12	07-Apr-2022
Ecal Module	Agilent	N4690-60006	BAMS-1000235612	12	30-Jun-2021
Network Analyzer (10MHz to 20GHz)	Agilent Technologies	N5230A	S/N: MY45000737	12	13-Apr-2022
Hygrometer	Rotronic	A1	TE2760	12	12-Jun-2022
Power Supply	Delta Elektronika	SM 52-30	BAMS-1000077230	-	O/P Mon
Attenuator 20 dB	Aeroflex / Weinschel	6834-20-11	QM935	-	O/P Mon
Attenuator 20 dB	Aeroflex / Weinschel	6834-20-11	QC181	-	O/P Mon
Attenuator 20 dB	Aeroflex / Weinschel	6834-20-11	004	-	O/P Mon
Attenuator 10 dB	Wainwright	56-10	T3515	-	O/P Mon
High Pass Filter	Wainwright Instruments	WHNX3.8/26.5 G	D-82346	-	O/P Mon
CCDF - PAR					
PXA Signal Analyzer	Keysight	N9030A	BAMS-1001562403	12	14-Jan-2022
Network Analyzer (10MHz to 40 GHz)	Agilent Technologies	N5230A	BAMS-1000635869	12	07-Apr-2022
Ecal Module	Agilent	N4690-60006	BAMS-1000235612	12	30-Jun-2021
Network Analyzer (10MHz to 20GHz)	Agilent Technologies	N5230A	S/N: MY45000737	12	13-Apr-2022
Hygrometer	Rotronic	A1	TE2760	12	12-Jun-2022
Power Supply	Delta Elektronika	SM 52-30	BAMS-1000077230	-	O/P Mon
Attenuator 20 dB	Aeroflex / Weinschel	6834-20-11	QM935	-	O/P Mon
Attenuator 20 dB	Aeroflex / Weinschel	6834-20-11	QC181	-	O/P Mon
Attenuator 20 dB	Aeroflex / Weinschel	6834-20-11	004	-	O/P Mon
Attenuator 10 dB	Wainwright	56-10	T3515	-	O/P Mon
High Pass Filter	Wainwright Instruments	WHNX3.8/26.5 G	D-82346	-	O/P Mon
PSD - Av					
PXA Signal Analyzer	Keysight	N9030A	BAMS-1001562403	12	14-Jan-2022
Network Analyzer (10MHz to 40 GHz)	Agilent Technologies	N5230A	BAMS-1000635869	12	07-Apr-2022
Ecal Module	Agilent	N4690-60006	BAMS-1000235612	12	30-Jun-2021
Network Analyzer (10MHz to 20GHz)	Agilent Technologies	N5230A	S/N: MY45000737	12	13-Apr-2022
Hygrometer	Rotronic	A1	TE2760	12	12-Jun-2022
Power Supply	Delta Elektronika	SM 52-30	BAMS-1000077230	-	O/P Mon
Attenuator 20 dB	Aeroflex / Weinschel	6834-20-11	QM935	-	O/P Mon
Attenuator 20 dB	Aeroflex / Weinschel	6834-20-11	QC181	-	O/P Mon
Attenuator 20 dB	Aeroflex / Weinschel	6834-20-11	004	-	O/P Mon



Instrument	Manufacturer	Type No.	TE No.	Calibration Period (months)	Calibration Due
Attenuator 10 dB	Wainwright	56-10	T3515	-	O/P Mon
High Pass Filter	Wainwright Instruments	WHNX3.8/26.5 G	D-82346	-	O/P Mon
OBW / 99% resp 26dB BW - Pk					
PXA Signal Analyzer	Keysight	N9030A	BAMS-1001562403	12	14-Jan-2022
Network Analyzer (10MHz to 40 GHz)	Agilent Technologies	N5230A	BAMS-1000635869	12	07-Apr-2022
Ecal Module	Agilent	N4690-60006	BAMS-1000235612	12	30-Jun-2021
Network Analyzer (10MHz to 20GHz)	Agilent Technologies	N5230A	S/N: MY45000737	12	13-Apr-2022
Hygrometer	Rotronic	A1	TE2760	12	12-Jun-2022
Power Supply	Delta Elektronika	SM 52-30	BAMS-1000077230	-	O/P Mon
Attenuator 20 dB	Aeroflex / Weinschel	6834-20-11	QM935	-	O/P Mon
Attenuator 20 dB	Aeroflex / Weinschel	6834-20-11	QC181	-	O/P Mon
Attenuator 20 dB	Aeroflex / Weinschel	6834-20-11	004	-	O/P Mon
Attenuator 10 dB	Wainwright	56-10	T3515	-	O/P Mon
High Pass Filter	Wainwright Instruments	WHNX3.8/26.5 G	D-82346	-	O/P Mon
Band Edge					
PXA Signal Analyzer	Keysight	N9030A	BAMS-1001562403	12	14-Jan-2022
Network Analyzer (10MHz to 40 GHz)	Agilent Technologies	N5230A	BAMS-1000635869	12	07-Apr-2022
Ecal Module	Agilent	N4690-60006	BAMS-1000235612	12	30-Jun-2021
Network Analyzer (10MHz to 20GHz)	Agilent Technologies	N5230A	S/N: MY45000737	12	13-Apr-2022
Hygrometer	Rotronic	A1	TE2760	12	12-Jun-2022
Power Supply	Delta Elektronika	SM 52-30	BAMS-1000077230	-	O/P Mon
Attenuator 20 dB	Aeroflex / Weinschel	6834-20-11	QM935	-	O/P Mon
Attenuator 20 dB	Aeroflex / Weinschel	6834-20-11	QC181	-	O/P Mon
Attenuator 20 dB	Aeroflex / Weinschel	6834-20-11	004	-	O/P Mon
Attenuator 10 dB	Wainwright	56-10	T3515	-	O/P Mon
High Pass Filter	Wainwright Instruments	WHNX3.8/26.5 G	D-82346	-	O/P Mon
Spurious Emissions					
PXA Signal Analyzer	Keysight	N9030A	BAMS-1001562403	12	14-Jan-2022
Network Analyzer (10MHz to 40 GHz)	Agilent Technologies	N5230A	BAMS-1000635869	12	07-Apr-2022
Ecal Module	Agilent	N4690-60006	BAMS-1000235612	12	30-Jun-2021
Network Analyzer (10MHz to 20GHz)	Agilent Technologies	N5230A	S/N: MY45000737	12	13-Apr-2022
Hygrometer	Rotronic	A1	TE2760	12	12-Jun-2022
Power Supply	Delta Elektronika	SM 52-30	BAMS-1000077230	-	O/P Mon
Attenuator 20 dB	Aeroflex / Weinschel	6834-20-11	QM935	-	O/P Mon
Attenuator 20 dB	Aeroflex / Weinschel	6834-20-11	QC181	-	O/P Mon
Attenuator 20 dB	Aeroflex / Weinschel	6834-20-11	004	-	O/P Mon
Attenuator 10 dB	Wainwright	56-10	T3515	-	O/P Mon
High Pass Filter	Wainwright Instruments	WHNX3.8/26.5 G	D-82346	-	O/P Mon

N/A – Not Applicable

O/P Mon – Output Monitored with Calibrated Equipment

List of measurement software versions used for testing.

Instrument	Manufacturer	Type No.	TE No.	Software Version
PXA Signal Analyser	Keysight	N9030A	BAMS1001562403	A.19.05
HP-VEE Software	TUV SUD	HP_VEE	N/A	V3.27



3.2 MEASUREMENT UNCERTAINTY

For a 95% confidence level, the measurement uncertainties for defined systems are:-

Test Discipline	Frequency / Parameter	MU	
Conducted Maximum Peak Output Power	30 MHz to 20 GHz Amplitude	± 0.89 dB	
Conducted Emissions	30 MHz to 20 GHz Amplitude	± 1.81dB	
Occupied Bandwidth	Up to 20 MHz Bandwidth	10 MHz Bandwidth	±67172 Hz
		15MHz Bandwidth	±353784 Hz
		20 MHz Bandwidth	±145903 Hz
Band Edge	30 MHz to 20 GHz Amplitude	±0.89dB	

Measurement Uncertainty Decision Rule

Determination of conformity with the specification limits is based on the decision rule according to IEC Guide 115: 2007, clause 4.4.3 and 4.5.1.



SECTION 4

ACCREDITATION, DISCLAIMERS AND COPYRIGHT



4.1 ACCREDITATION, DISCLAIMERS AND COPYRIGHT



This report relates only to the actual item/items tested.

Our Swedac Accreditation does not cover opinions and interpretations and any expressed are outside the scope of our Swedac Accreditation.

Results of tests not covered by our Swedac Accreditation Schedule are marked NSA (Not Swedac Accredited).

© 2021 TÜV SÜD
Sverige

Postal Address: Djäknegatan 31, 211 35, Malmö, Sweden



ANNEX A

MODULE LIST



Configuration 1			
Product	Product No	R-State	Serial No
CT10	LPC102487/1	R1C	T01F307250
Radio 4415 B66A	KRC 161 644/1	R5B	D827454598
Software Version:	CXP9013268/12	Revision:	R82CM