



TEST REPORT

No.I18Z61323-WMD01

for

Ericsson AB Radio 4415 B66A KRC 161 644/1

Remote Radio Unit

FCC ID: TA8FKRC161644

IC : 287AB-FS161644

In accordance with FCC CFR 47 Part 27

ISED RSS-139: Issue 3

Issued Date: 2018-08-13



Note:

The test results in this test report relate only to the devices specified in this report. This report shall not be reproduced except in full without the written approval of CTTL.

The report must not be used by the client to claim product certification, approval, or endorsement by NVLAP, NIST, or any agency of the U.S. Government.

Test Laboratory:

ISED(IC) accredited test site number: 12389A-1 / 12389B-1

CTTL, Telecommunication Technology Labs, CAICT

No. 52, Huayuan North Road, Haidian District, Beijing, P. R. China 100191.

Tel:+86(0)10-62304633-2512, Fax:+86(0)10-62304633-2504

Email: ctl_terminals@caict.ac.cn, website: www.caict.ac.cn

REPORT HISTORY

Report Number	Revision	Description	Issue Date
I18Z61323-WMD01	Rev.0	1 st edition	2018-08-13



CONTENTS

1. TEST LABORATORY	4
1.1. TESTING LOCATION	4
1.2. PROJECT DATA	4
1.3. SIGNATURE.....	4
2. CLIENT INFORMATION.....	5
2.1. APPLICANT INFORMATION.....	5
2.2. MANUFACTURER INFORMATION.....	5
3. EQUIPMENT UNDER TEST (EUT).....	6
3.1. ABOUT EUT.....	6
3.2. GENERAL DESCRIPTION	7
3.3. CONFIGURATION DESCRIPTION	8
4. REFERENCE DOCUMENTS.....	10
4.1. REFERENCE DOCUMENTS FOR TESTING.....	10
5. TEST SETUP	11
6. LABORATORY ENVIRONMENT.....	12
7. SUMMARY OF TEST RESULTS	13
8. TEST EQUIPMENT UTILIZED	14
9. MEASUREMENT UNCERTAINTY	14
ANNEX A: MEASUREMENT RESULTS.....	15
A.1 MAXIMUM OUTPUT POWER AND PEAK-TO-AVERAGE POWER RATIO.....	15
A.2 OCCUPIED BANDWIDTH	20
A.3 SPURIOUS EMISSIONS AT BAND EDGE	26
A.4 CONDUCTED SPURIOUS EMISSION.....	46
A.5 RADIATED SPURIOUS EMISSION	73
A.6 FREQUENCY STABILITY	79
ANNEX B: ACCREDITATION CERTIFICATE.....	81

1. Test Laboratory

1.1. Testing Location

Location 1:CTTL(Kangding Road) 12389B-1

Address: No. 18, Kangding Road, Yizhuang, Beijing,
P. R. China 100176

Location 2:CTTL(Shouxiang) conducted testing

Address: No. 51 Shouxiang Science Building, Xueyuan Road,
Haidian District, Beijing, P. R. China100191

1.2. Project data

Testing Start Date: 2018-07-30

Testing End Date: 2018-08-13

1.3. Signature



Dong Yuan
(Prepared this test report)



Zhou Yu
(Reviewed this test report)



Liu Baodian
(Approved this test report)



2. Client Information

2.1. Applicant Information

Company Name: Ericsson (China) Communications Company Ltd.
Address /Post: Ericsson Tower, Lize East Street, Chaoyang District, Beijing 100102,
P.R.China
Contact: Jieying Zhu
Email: jieying.zhu@ericsson.com
Telephone: +86 13911554808

2.2. Manufacturer Information

Company Name: Ericsson AB
Address /Post: Isafjordsgatan 10, 164 80 Stockholm
Sweden
Contact: /
Email: /
Telephone: /

3. Equipment Under Test (EUT)

3.1. About EUT

Description	Remote Radio Unit
Product Name	Radio 4415 B66A
Product Number	KRC 161 644/1
FCC ID	TA8FKRC161644
IC	287AB-FS161644
Antenna	N/A
Output power	Maximum 46.02dBm (40W) per port
Power source	-48V DC
Serial Number	D827597054
Hardware Version	R5C
Software Version	R71HX
Frequency range	Rx: 1710-1780 MHz, Tx: 2110-2180 MHz (WCDMA: Rx:1710 -1755 MHz; Tx:2110 -2155 MHz)
Supported TX/RX configuration	4 TX / 4 RX
Maximum RF bandwidth (IBW)	WCDMA SR: 45MHz LTE SR: 70MHz valid for LTE BW \geq 5 MHz NB-IoT Standalone: 20MHz LTE+WCDMA Mix Mode: 70MHz valid for LTE BW \geq 5 MHz NB+WCDMA: 70MHz NB+LTE: 70MHz valid for LTE BW \geq 5 MHz NB+WCDMA+LTE: 70MHz valid for LTE BW \geq 5 MHz
Supported channel bandwidth configuration	WCDMA: 3.8MHz to 5MHz LTE: 5MHz, 10MHz, 15MHz and 20MHz NB-IoT Standalone: 250kHz NB-IoT In-Band: 5MHz, 10MHz, 15MHz and 20MHz NB-IoT GuardBand: 10MHz, 15MHz and 20MHz
Total number of supported carriers per port	Maximum 6 carriers for all except NB-IoT Standalone per port. NB-IoT Standalone: Maximum 2 carriers
Supported modulations	WCDMA: QPSK, 16QAM, 64QAM LTE: QPSK, 16QAM, 64QAM, 256QAM NB-IoT: QPSK
Date of receipt	2018-07-30

3.2. General Description

The Equipment Under Test (EUT) is an Ericsson Remote Radio Unit working in the wireless communications services 2100MHz band which provides communication connections to 2100MHz network in WCDMA / LTE / NB-IoT modes and MSR modes. The Radio 4415 B66A KRC 161 644/1 operates from a -48V DC supply.

The EUT includes 4 TX/RX ports and it can be configured to transmit in MIMO mode for WCDMA or LTE carriers, and MIMO mode for WCDMA or LTE was used for measurements as the worst configuration. The complete testing was performed with the EUT transmitting at maximum RF power unless otherwise stated.

The EUT is shown in the photograph below. A full technical description can be found in the Manufacturer's documentation.



Equipment Under Test

3.3. Configuration Description

The following settings were used to representative for all traffic scenarios when settings with different modulations, channel bandwidths, number for carriers and RF configurations have been tested to find the worst case setting. The settings below were used for all measurements unless otherwise noted:

NB-IoT

Configuration	Carrier	Carrier Bandwidth (MHz)	Carrier Frequency Configuration (MHz)		
			Bottom	Middle	Top
NB-IoT-GuardBand-1 C	1 Carrier	10MHz	2115.0	2145.0	2175.0
		15MHz	2117.5	2145.0	2172.5
		20MHz	2120.0	2145.0	2170.0
NB-IoT-GuardBand-1 C-BE	1 Carrier	10MHz	2115.0	N/A	2175.0
		15MHz	2117.5	N/A	2172.5
		20MHz	2120.0	N/A	2170.0

NB-IoT+WCDMA

Configuration	Carrier	Carrier Frequency Configuration (MHz)		
		Bottom	Middle	Top
NB-IoT-IB+WCDMA-MI MO-MC-1	1IB+1W	-	(W)2112.4 + (IB)2177.5	-
NB-IoT-IB+WCDMA-MI MO-MC-1-BE	1IB+1W	(IB)2112.5+(W)2117.4	N/A	-
NB-IoT-IB+WCDMA -MIMO-MC-2-BE	1IB+2W	(IB)2112.5+(W)2117.4+21 22.4	N/A	-

Configuration	Carrier	Carrier Frequency Configuration (MHz)		
		Bottom	Middle	Top
NB-IoT-GB+WCDMA-M IMO-MC-1	1GB+1W	-	(W)2112.4 + (GB)2175.0	-
NB-IoT-GB+WCDMA-M IMO-MC-2	1GB+2W	-	(W)2112.4+2167.6+(GB)2175. 0	-
NB-IoT-GB+WCDMA-M IMO-MC-3	1GB+5W	-	(W)2112.4+2137.4+2142.4+21 47.4+2152.4+(GB)2175.0	-
NB-IoT-GB+WCDMA-M IMO-MC-1-BE	1GB+1W	(GB)2115+(W)2122.4	N/A	-
NB-IoT-GB+WCDMA-M IMO-MC-2-BE	1GB+2W	(GB)2115+(W)2122.4+21 27.4	N/A	-

NB-IoT+ LTE

Configuration	Carrier	LTE Carrier Bandwidth	Carrier Frequency Configuration (MHz)		
			Bottom	Middle	Top
NB-IoT-IB+LTE-M IMO-MC-1	1IB+1L	5MHz	-	(IB)2112.5 + (L)2177.5	-
NB-IoT-IB+LTE-M IMO-MC-3	1IB+5L	5MHz	-	(IB)2112.5 + (L)2157.5+2162.5+2167.5 +2172.5+2177.5	-
NB-IoT-IB+LTE-M IMO-MC-1-BE	1IB+1L	5MHz	(IB)2112.5+(L)2117.5	N/A	(L)2172.5+(IB)2177.5
NB-IoT-IB+LTE-M IMO-MC-2-BE	1IB+2L	5MHz	(IB)2112.5+(L)2117.5+212 2.5	N/A	(L)2167.5+2172.5+(IB)217 7.5

Configuration	Carrier	LTE Carrier Bandwidth	Carrier Frequency Configuration (MHz)		
			Bottom	Middle	Top
NB-IoT-GB+LTE- MIMO-MC-1	1GB+1L	10MHz	-	(GB)2115.0 + (L)2175.0	-
NB-IoT-GB+LTE- MIMO-MC-2	1GB+2L	10MHz	-	(GB)2115.0 + (L)2165+2175.0	-
NB-IoT-GB+LTE- MIMO-MC-3	1GB+5L	10MHz	-	(GB)2115.0 + (L)2135+2145+2155+216 5+2175	-
NB-IoT-GB+LTE- MIMO-MC-1-BE	1GB+1L	10MHz	(GB)2115+(L)2125	N/A	(L)2165+(GB)2175
NB-IoT-GB+LTE- MIMO-MC-2-BE	1GB+2L	10MHz	(GB)2115+(L)2125+2135	N/A	(L)2155+2165+(GB)2175

NB-IoT+ WCDMA+LTE

Configuration	Carrier	LTE Carrier Bandwidth	Carrier Frequency Configuration (MHz)		
			Bottom	Middle	Top
NB-IoT-IB+WCD MA+LTE-MIMO- MC-1	1IB+1W +1L	5MHz	-	(W)2112.4 + (L)2172.5+(IB)2177.5	-

N/A – Not Applicable

4. Reference Documents

4.1. Reference Documents for testing

The following documents listed in this section are referred for testing.

Reference	Title	Version
FCC Part 27	MISCELLANEOUS WIRELESS COMMUNICATIONS SERVICES	10-1-17 Edition
FCC Part 2	FREQUENCY ALLOCATIONS AND RADIO TREATY MATTERS; GENERAL RULES AND REGULATIONS	10-1-17 Edition
ANSI/TIA-603-E	Land Mobile FM or PM Communications Equipment Measurement and Performance Standards	2016
ANSI C63.4	Methods of Measurement of Radio-Noise Emissions from Low-Voltage Electrical and Electronic Equipment in the Range of 9 KHz to 40 GHz	2014
ANSI 63.26	IEEE/ANSI Standard for Compliance Testing of Transmitters Used in Licensed Radio Services	2015
TIA 102.CAAA-E	Project 25 Digital C4FM/CQPSK Transceiver Measurement Methods	2016
KDB 971168 D01	MEASUREMENT GUIDANCE FOR CERTIFICATION OF LICENSED DIGITAL TRANSMITTERS	v03
KDB 662911 D01	Emissions Testing of Transmitters with Multiple Outputs in the Same Band	v02r01
RSS-GEN	General Requirements for Compliance of Radio Apparatus	Issue 4 2014
RSS 139	Advanced Wireless Services (AWS) Equipment Operating in the Bands 1710-1780 MHz and 2110-2180 MHz	Issue 3 2015

5. TEST SETUP

Test Setup, Conducted Measurement:

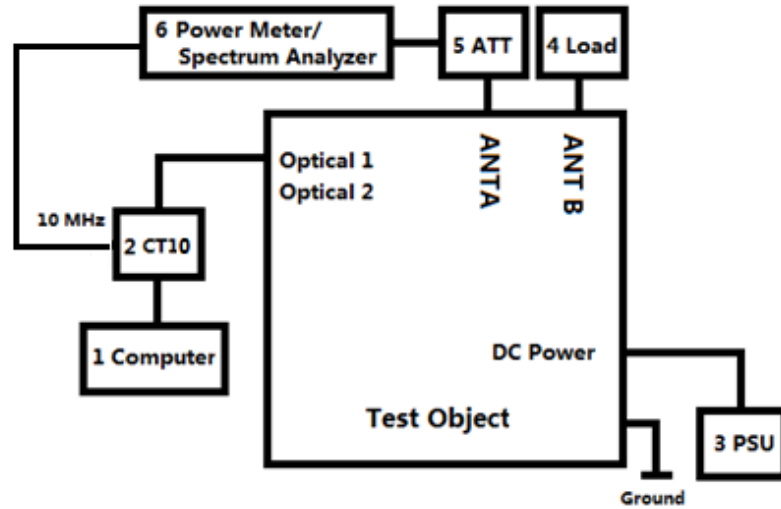

No.	Auxilliary Equipment	Model Type	Version
1	Computer	HP EliteBook 8540w	-
2	CT10	LPC 102 487/1	R1C
3	Power supply unit	PCR2000M	-
4	Load	TF150	-
5	40dB Attenuator	Aeroflex / Weinschel	-

Test Setup, Radiated Measurement:

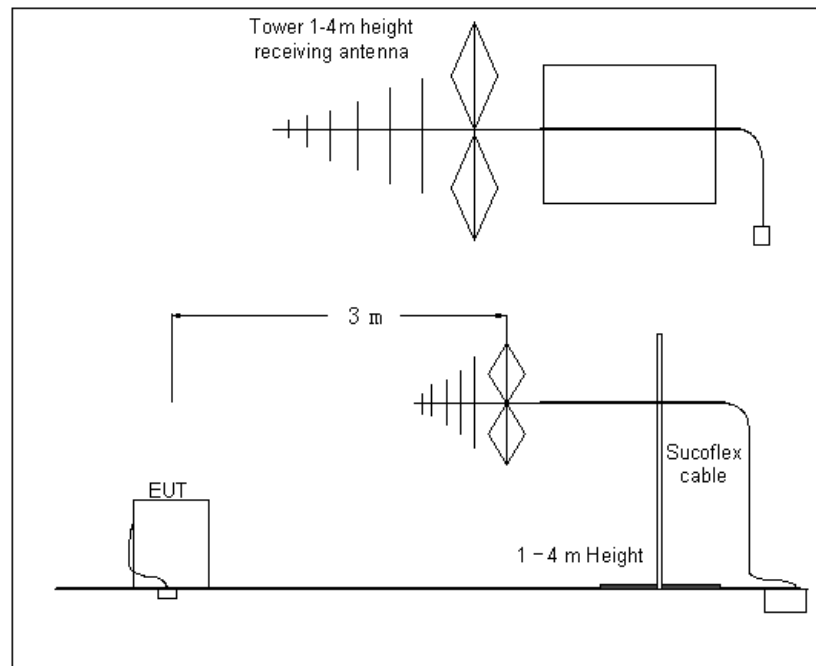

6. LABORATORY ENVIRONMENT

Control room / conducted chamber did not exceed following limits along the EMC testing:

Temperature	Min. = 15 °C, Max. = 35 °C
Relative humidity	Min. =20 %, Max. = 80 %
Shielding effectiveness	> 110 dB
Electrical insulation	>2 M Ω
Ground system resistance	< 0.5 Ω

Semi-anechoic chamber(10 meters X6.7 meters X6.15 meters) did not exceed following limits along the EMC testing:

Temperature	Min. = 15 °C, Max. = 30 °C
Relative humidity	Min. = 35 %, Max. = 60 %
Shielding effectiveness	> 100 dB
Electrical insulation	>2 M Ω
Ground system resistance	< 0.5 Ω
Normalised site attenuation (NSA)	< \pm 3.5 dB, 3 m distance
Site voltage standing-wave ratio (S_{VSWR})	Between 0 and 6 dB, from 1GHz to 18GHz
Uniformity of field strength	Between 0 and 6 dB, from 80 to 3000 MHz



7. SUMMARY OF TEST RESULTS

The Equipment Under Test (EUT) is a class II permissive change based on Radio 4415 B66A KRC 161 644/1 (FCC ID: TA8FKRC161644, IC: 287AB-FS161644, granted on 2018-05-22), the initial test report number is I18Z60623-WMD01, according to the declaration of changes provided by the applicant and FCC KDB publication 178919 D01, only partial tests were performed on this device. For detail differences between two models please refer the Declaration of Changes document.

Items	Test Name	Clause in FCC rules	Clause in ISED rules	Verdict
1	Maximum Output Power and Peak-to-Average Power Ratio	27.50(d)	RSS-139 4.1, 6.5	Pass
2	Equivalent Isotropically Radiated Power (EIRP)	-	-	N/A ¹
3	Occupied Bandwidth	27.53(h), 2.1049	RSS-GEN 6.6	Pass
4	Spurious Emissions at Band Edge	27.53(h)	RSS-139 6.6	Pass
5	Conducted Spurious Emission	27.53(h)	RSS-139 6.6	Pass
6	Radiated Spurious Emission	27.53(h)	RSS-139 6.6	Pass
7	Frequency Stability	27.54	RSS-139 6.4	Pass
8	Receiver Spurious Emission	-	-	N/A

N/A¹ - Not Applicable, due to no integrated antenna

N/A – Not Applicable

8. Test Equipment Utilized

NO.	Description	TYPE	series number	MANUFACTURE	CAL DUE DATE
1	AC Power Supply	PCR2000M	PJ000583	Kikusui	2019-02-24
2	Load	TF150	11081907, 090323432	Shanghai Huaxiang	-
3	40dB Attenuator	66-40-33	CD4019	Aeroflex / Weinschel	-
4	40dB Attenuator	TSG150R-4-40N11	1511040001	Nanjing Jiexi Technologies	-
5	Spectrum Analyzer	N9030	MY54490239	Keysight	2019-07-31
6	Spectrum Analyzer	N9030	MY54490502	Keysight	2018-11-15
7	Power Sensor	NRP-Z91	103104	Rohde & Schwarz	2019-01-18
8	Power Sensor	NRP-Z21	102432	Rohde & Schwarz	2019-07-31
9	Power Meter	NRP2	105423-GL	Rohde & Schwarz	2018-08-15
10	EMI Antenna	3115	00167250	ETS-LINDGREN	2020-05-21
11	EMI Antenna	3116	2661	ETS-LINDGREN	2020-07-27
12	EMI Antenna	VULB 9163	9163-514	SCHWARZBECK	2021-01-03
13	Test Receiver	ESU26	100376	Rohde & Schwarz	2018-11-27
14	Climate Chamber	KTHG-415TBS	7353K	QINGSHENG	2018-12-16

9. MEASUREMENT UNCERTAINTY

For a 95% confidence level, the measurement uncertainties for defined systems are:

Test Discipline	Measurement Uncertainty
Conducted Maximum Peak Output Power	0.5dB
Occupied Bandwidth	1.1Hz
Conducted Spurious Emissions	2.3dB
Band Edge	2.3dB
Radiated Spurious Emissions	5.4dB
Frequency Stability	$<\pm 1 \times 10^{-7}$

ANNEX A: MEASUREMENT RESULTS

A.1 Maximum Output Power and Peak-to-Average Power Ratio

A.1.1 Reference

FCC CFR 47 Part 27, Clause 27.50(d)

RSS-Gen, Clause 6.12, RSS-139, Clause 4.1, Clause 6.5

A.1.2 Method of Measurements

During the process of testing, the EUT was configured to transmit on maximum power and proper modulation. The transmitter power shall be measured in terms of a root-mean-square (RMS) average value. In case of the EUT was configured to MIMO mode, since the EUT transmits on all antennas simultaneously in the same frequency range, using the Measure-and-Sum approach, the output power at all antennas were tested, and the total output power were then summed mathematically in linear power units according to FCC KDB 662911 D01.

A peak to average ratio measurement is performed at the conducted ports of the EUT for single carrier for single RAT mode. The spectrum analyzers Complementary Cumulative Distribution Function (CCDF) was used and 0.1% probability value recorded.

A.1.3 Limit

Output Power:

(EIRP) 1640 W or 62.15 dBm for emission bandwidth \leq 1MHz

1640 W/MHz or 62.15 dBm/MHz for emission bandwidth $>$ 1MHz

Peak to Average Ratio: 13 dB

A.1.4 Measurement result

Configuration NB-IoT-GuardBand-1C

Maximum Output Power 46.02dBm per port

Antenna	Modulation/ Carrier Bandwidth (MHz)	Output Power / Peak to Average Ratio (PAR)								
		Channel position B			Channel position M			Channel position T		
		POWER (dBm)	POWER (dBm/MHz)	PAR (db)	POWER (dBm)	POWER (dBm/MHz)	PAR (db)	POWER (dBm)	POWER (dBm/MHz)	PAR (db)
A	QPSK/10.0	45.95	35.93	7.47	46.03	35.92	7.45	45.92	35.83	7.46
B		45.92	35.72	7.47	46.10	35.93	7.44	45.93	35.77	7.47
C		45.93	35.77	7.47	46.07	35.93	7.45	45.84	35.72	7.47
D		45.91	35.94	7.47	46.18	36.04	7.44	45.98	36.02	7.47
Total		51.95	41.86	-	52.12	41.98	-	51.94	41.86	-

Antenna	Modulation/ Carrier Bandwidth (MHz)	Output Power / Peak to Average Ratio (PAR)								
		Channel position B			Channel position M			Channel position T		
		POWER (dBm)	POWER (dBm/MHz)	PAR (db)	POWER (dBm)	POWER (dBm/MHz)	PAR (db)	POWER (dBm)	POWER (dBm/MHz)	PAR (db)
A	QPSK/15.0	46.07	34.12	7.43	46.08	34.12	7.42	46.03	34.03	7.46
B		46.09	34.08	7.43	46.11	34.10	7.43	46.01	34.13	7.46
C		46.03	34.06	7.43	46.02	34.16	7.41	45.95	34.02	7.46
D		46.11	34.18	7.43	46.23	34.20	7.42	46.14	34.16	7.46
Total		52.10	40.13	-	52.13	40.17	-	52.05	40.11	-

Antenna	Modulation/ Carrier Bandwidth (MHz)	Output Power / Peak to Average Ratio (PAR)								
		Channel position B			Channel position M			Channel position T		
		POWER (dBm)	POWER (dBm/MHz)	PAR (db)	POWER (dBm)	POWER (dBm/MHz)	PAR (db)	POWER (dBm)	POWER (dBm/MHz)	PAR (db)
A	QPSK/20.0	46.25	32.98	7.34	46.22	33.02	7.31	46.18	33.00	7.36
B		46.24	33.05	7.35	46.24	33.12	7.34	46.15	32.96	7.37
C		46.17	32.89	7.32	46.16	33.05	7.31	46.08	32.90	7.38
D		46.30	32.93	7.33	46.36	33.15	7.31	46.26	33.10	7.37
Total		52.26	38.98	-	52.27	39.10	-	52.19	39.01	-

Configuration NB-IoT-IB+WCDMA-MIMO-MC-1 (1IB+1WCDMA)

Maximum Output Power 46.02dBm per port

Antenna	IB Mod./ WCDMA Mod.	Output Power / Peak to Average Ratio (PAR)								
		Channel position B			Channel position M			Channel position T		
		POWER (dBm)	POWER (dBm/MHz)	PAR (db)	POWER (dBm)	POWER (dBm/MHz)	PAR (db)	POWER (dBm)	POWER (dBm/MHz)	PAR (db)
D	QPSK/ 16QAM	-	-	-	45.96	-	-	-	-	-

Configuration NB-IoT-GB+WCDMA-MIMO-MC-1 (1GB+1WCDMA)
Maximum Output Power 46.02dBm per port

Antenna	GB Mod./ WCDMA Mod.	Output Power / Peak to Average Ratio (PAR)								
		Channel position B			Channel position M			Channel position T		
		POWER (dBm)	POWER (dBm/MHz)	PAR (db)	POWER (dBm)	POWER (dBm/MHz)	PAR (db)	POWER (dBm)	POWER (dBm/MHz)	PAR (db)
D	QPSK/ 16QAM	-	-	-	45.97	-	-	-	-	-

Configuration NB-IoT-GB+WCDMA-MIMO-MC-2 (1GB+2WCDMA)
Maximum Output Power 46.02dBm per port

Antenna	GB Mod./ WCDMA Mod.	Output Power / Peak to Average Ratio (PAR)								
		Channel position B			Channel position M			Channel position T		
		POWER (dBm)	POWER (dBm/MHz)	PAR (db)	POWER (dBm)	POWER (dBm/MHz)	PAR (db)	POWER (dBm)	POWER (dBm/MHz)	PAR (db)
D	QPSK/ 16QAM	-	-	-	46.00	-	-	-	-	-

Configuration NB-IoT-GB+WCDMA-MIMO-MC-3(1GB+5WCDMA)
Maximum Output Power 46.02dBm per port

Antenna	GB Mod./ WCDMA Mod.	Output Power / Peak to Average Ratio (PAR)								
		Channel position B			Channel position M			Channel position T		
		POWER (dBm)	POWER (dBm/MHz)	PAR (db)	POWER (dBm)	POWER (dBm/MHz)	PAR (db)	POWER (dBm)	POWER (dBm/MHz)	PAR (db)
D	QPSK/ 16QAM	-	-	-	46.17	-	-	-	-	-

Configuration NB-IoT-IB+LTE-MIMO-MC-1 (1IB+1LTE)
Maximum Output Power 46.02dBm per port

Antenna	IB Mod./ LTE Mod. Bandwidth (MHz)	Output Power / Peak to Average Ratio (PAR)								
		Channel position B			Channel position M			Channel position T		
		POWER (dBm)	POWER (dBm/MHz)	PAR (db)	POWER (dBm)	POWER (dBm/MHz)	PAR (db)	POWER (dBm)	POWER (dBm/MHz)	PAR (db)
D	QPSK/ QPSK 5	-	-	-	45.65	-	-	-	-	-



Configuration NB-IoT-IB+LTE-MIMO-MC-3(1IB+5LTE)
Maximum Output Power 46.02dBm per port

Antenna	IB Mod./ LTE Mod. Bandwidth (MHz)	Output Power / Peak to Average Ratio (PAR)								
		Channel position B			Channel position M			Channel position T		
		POWER (dBm)	POWER (dBm/MHz)	PAR (db)	POWER (dBm)	POWER (dBm/MHz)	PAR (db)	POWER (dBm)	POWER (dBm/MHz)	PAR (db)
D	QPSK/ QPSK 5	-	-	-	45.45	-	-	-	-	-

Configuration NB-IoT-GB+LTE-MIMO-MC-1 (1GB+1LTE)
Maximum Output Power 46.02dBm per port

Antenna	GB Mod./ LTE Mod. Bandwidth (MHz)	Output Power / Peak to Average Ratio (PAR)								
		Channel position B			Channel position M			Channel position T		
		POWER (dBm)	POWER (dBm/MHz)	PAR (db)	POWER (dBm)	POWER (dBm/MHz)	PAR (db)	POWER (dBm)	POWER (dBm/MHz)	PAR (db)
D	QPSK/ QPSK 10	-	-	-	45.70	-	-	-	-	-

Configuration NB-IoT-GB+LTE-MIMO-MC-2 (1GB+2LTE)
Maximum Output Power 46.02dBm per port

Antenna	GB Mod./ LTE Mod. Bandwidth (MHz)	Output Power / Peak to Average Ratio (PAR)								
		Channel position B			Channel position M			Channel position T		
		POWER (dBm)	POWER (dBm/MHz)	PAR (db)	POWER (dBm)	POWER (dBm/MHz)	PAR (db)	POWER (dBm)	POWER (dBm/MHz)	PAR (db)
D	QPSK/ QPSK 10	-	-	-	45.76	-	-	-	-	-

Configuration NB-IoT-GB+LTE-MIMO-MC-3(1GB+5LTE)
Maximum Output Power 46.02dBm per port

Antenna	GB Mod./ LTE Mod. Bandwidth (MHz)	Output Power / Peak to Average Ratio (PAR)								
		Channel position B			Channel position M			Channel position T		
		POWER (dBm)	POWER (dBm/MHz)	PAR (db)	POWER (dBm)	POWER (dBm/MHz)	PAR (db)	POWER (dBm)	POWER (dBm/MHz)	PAR (db)
D	QPSK/ QPSK 10	-	-	-	45.84	-	-	-	-	-



Configuration NB-IoT-IB+WCDMA+LTE-MIMO-MC-1(1IB+1WCDMA+1LTE)
Maximum Output Power 46.02dBm per port

Antenna	IB Mod./ WCDMA Mod./ LTE Mod. Bandwidth (MHz)	Output Power / Peak to Average Ratio (PAR)								
		Channel position B			Channel position M			Channel position T		
		POWER (dBm)	POWER (dBm/MHz)	PAR (db)	POWER (dBm)	POWER (dBm/MHz)	PAR (db)	POWER (dBm)	POWER (dBm/MHz)	PAR (db)
D	QPSK/ 16 QAM/ QPSK 5.0	-	-	-	45.99	-	-	-	-	-

NOTE:

The DUT is tested without antenna. ERP/EIRP compliance is addressed at the time of licensing, as required by the responsible FCC Bureau. Licensee's are required to take into account maximum allowed antenna gain used in combination with above power settings to prevent the radiated output power to exceed the limits.

A.2 Occupied Bandwidth

A.2.1 Reference

FCC CFR 47 Part 2, Clause 2.1049

FCC CFR 47 Part 27, Clause 27.53 (h)

RSS-GEN, Clause 6.6

A.2.2 Method of Measurements

The EUT was set to transmit at maximum power and testing was carried out on bottom, middle and top channels. Using the Occupied Bandwidth measurement function in the spectrum analyzer, the 26dB bandwidth was measured in accordance with FCC KDB 971168 D01 Clause 4.2.

The measurement method is from KDB 971168 4.2:

- a) The spectrum analyzer center frequency is set to the nominal EUT channel center frequency. The frequency span for the spectrum analyzer shall be set wide enough to capture all modulation products including the emission skirts (i.e., two to five times the OBW).
- b) The nominal IF filter bandwidth (3 dB RBW) shall be in the range of 1 to 5 % of the anticipated OBW, and the VBW shall be at least 3 times the RBW.
- c) Set the reference level of the instrument as required to keep the signal from exceeding the maximum input mixer level for linear operation. In general, the peak of the spectral envelope must be at least $10\log(\text{OBW} / \text{RBW})$ below the reference level.
- d) Set the detection mode to peak, and the trace mode to max hold.
- e) Use the 99 % power bandwidth function of the spectrum analyzer and report the measured bandwidth.

A.2.3 Measurement result

Configuration NB-IoT-GuardBand-1C
-26dBc Occupied Bandwidth

Antenna	Modulation / Bandwidth	Occupied Bandwidth (MHz)		
		Channel Position B	Channel Position M	Channel Position T
D	QPSK/ 10.0 MHz	9.72	9.72	9.71
	QPSK/ 15.0 MHz	14.54	14.53	14.57
	QPSK/ 20.0 MHz	19.29	19.27	19.40

99% Occupied Bandwidth

Antenna	Modulation / Bandwidth	Occupied Bandwidth (MHz)		
		Channel Position B	Channel Position M	Channel Position T
D	QPSK/ 10.0 MHz	9.186	9.188	9.190
	QPSK/ 15.0 MHz	13.727	13.725	13.740
	QPSK/ 20.0 MHz	18.179	18.176	18.201

Port D, QPSK 10.0M Channel position B

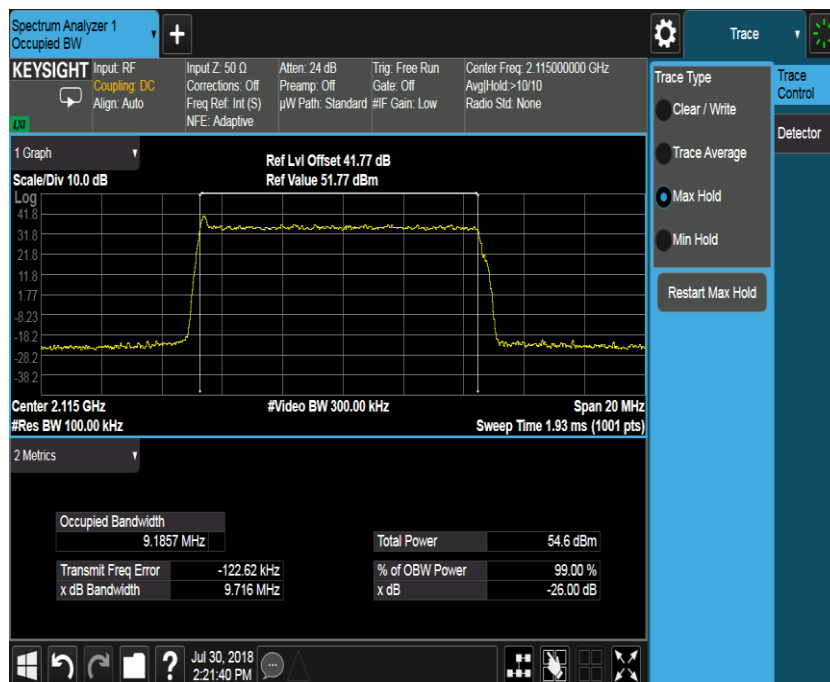

Port D, QPSK 10.0M Channel position M

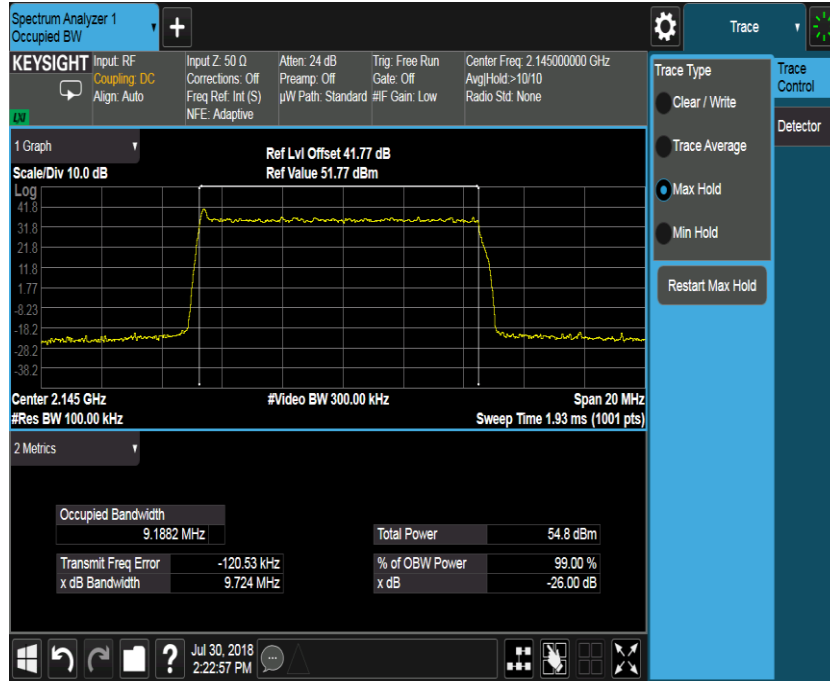

Port D, QPSK 10.0M Channel position T

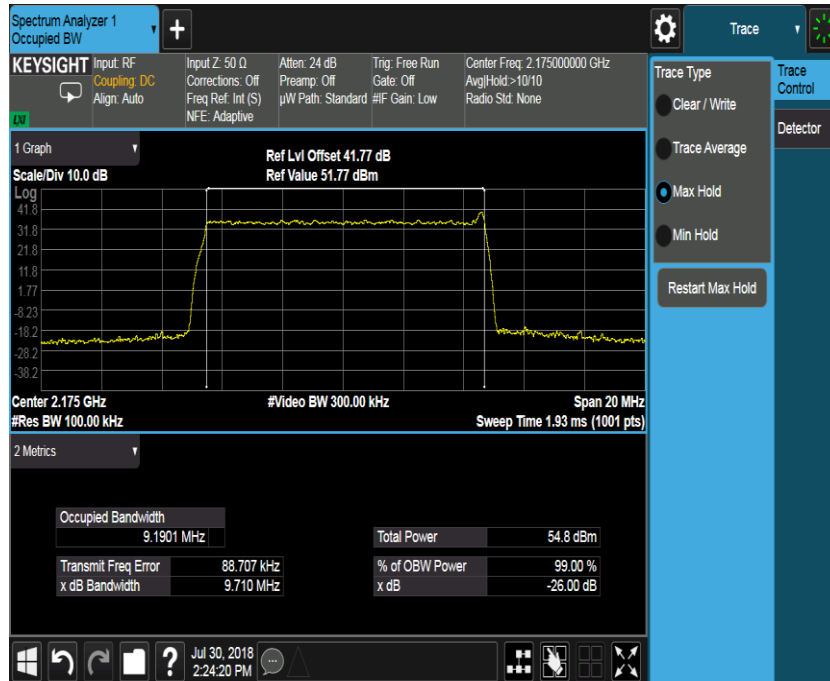

Port D, QPSK 15.0M Channel position B

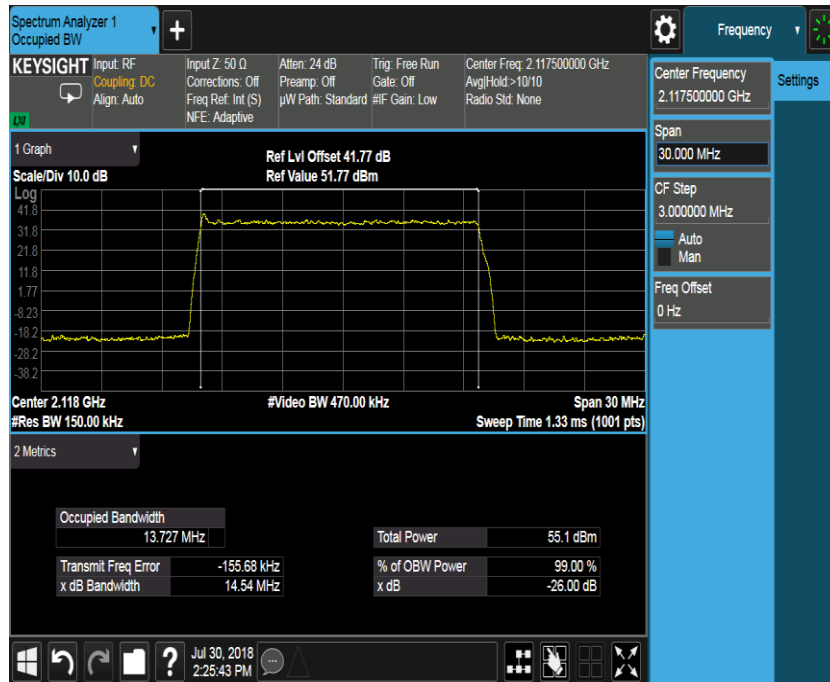

Port D, QPSK 15.0M Channel position M

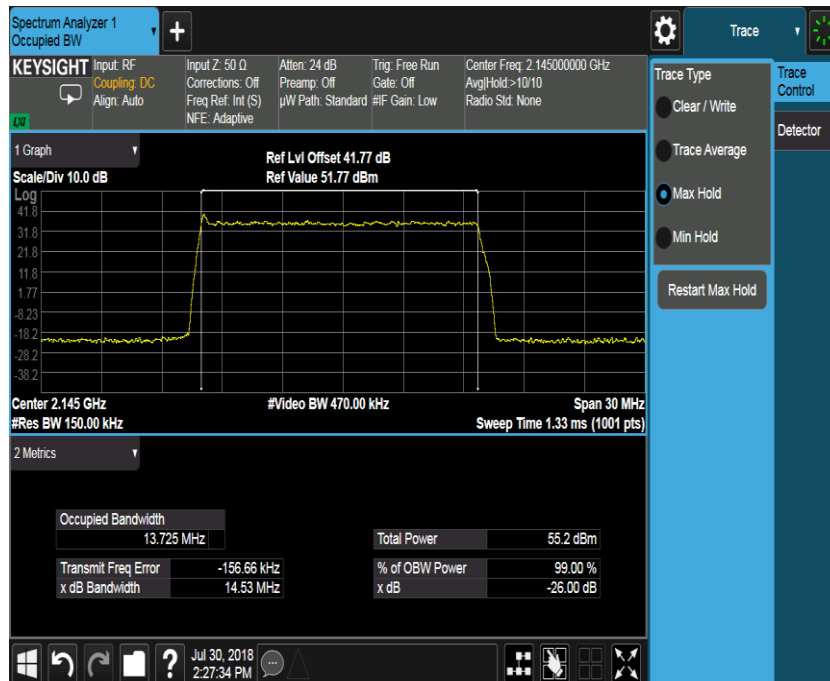

Port D, QPSK 15.0M Channel position T

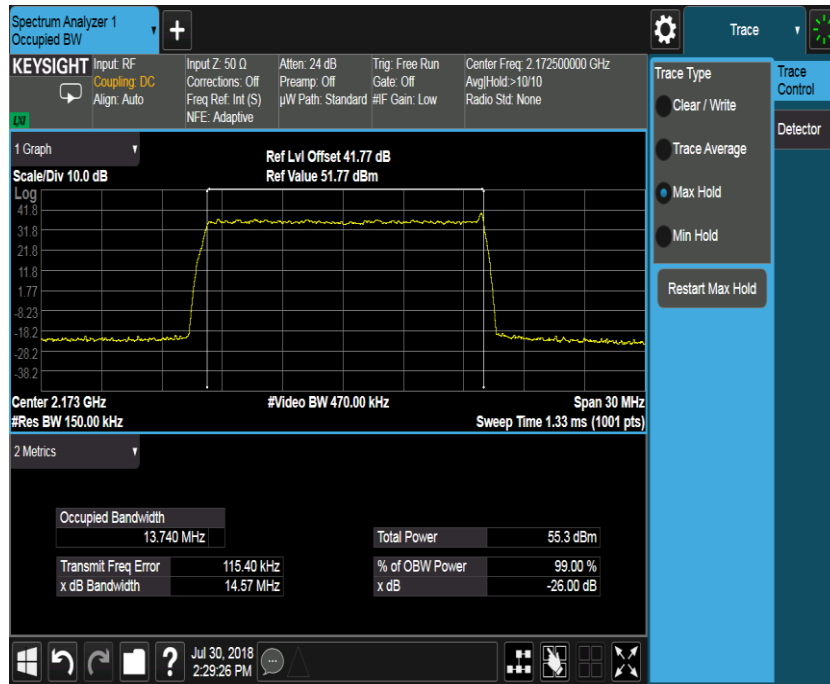

Port D, QPSK 20.0M Channel position B

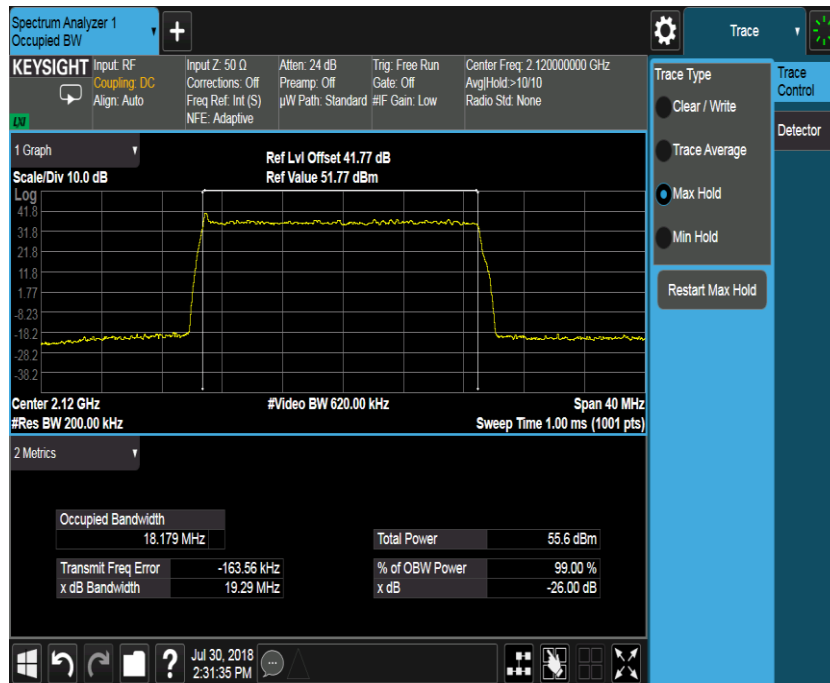

Port D, QPSK 20.0M Channel position M

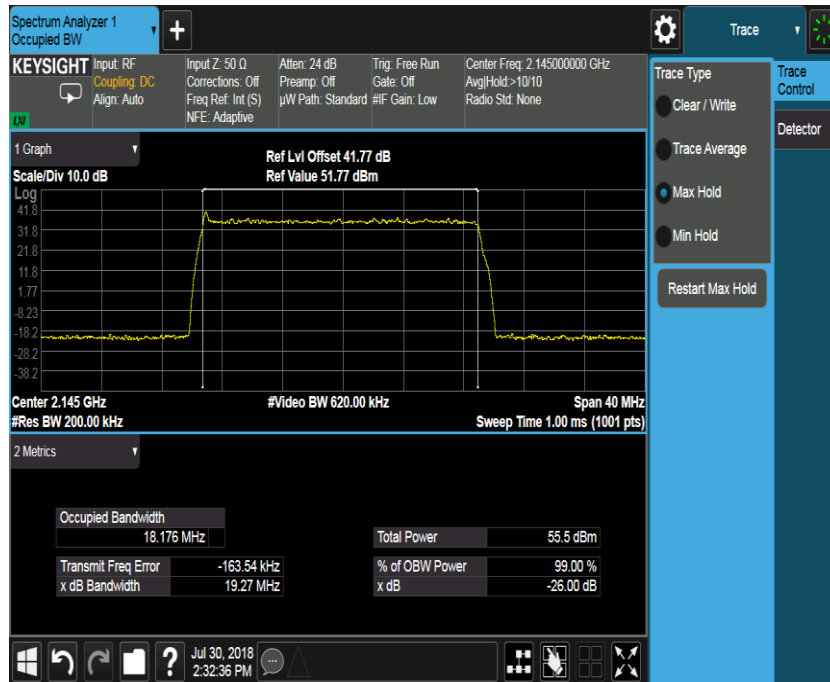

Port D, QPSK 20.0M Channel position T

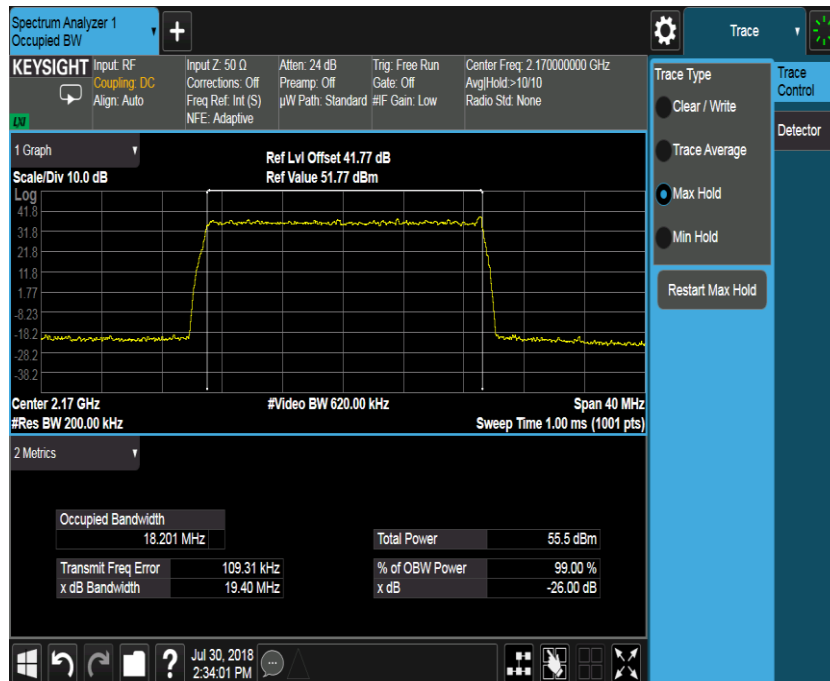

A.3 Spurious Emissions at Band Edge

A.3.1 Reference

FCC CFR 47 Part 27, Clause 27.53(h)
RSS-139, Clause 6.6

A.3.2 Method of measurement

The power of any emission outside of the authorized operating frequency ranges must be attenuated below the transmitting power (P) by a factor of at least $43 + 10\log(P)$ dB.

For MIMO mode configurations, the limit was adjusted with a correction of -6.02dB [10Log4] by using the Measure and Add 10Log(N) dB technique according to FCC KDB 662911 D01 accounting for simultaneous transmission from all antenna ports.

According to FCC rules, in the 1 MHz bands immediately outside and adjacent to the frequency block, a resolution bandwidth of at least one percent of the emission bandwidth of the fundamental emission of the transmitter may be employed and a RBW of 1MHz for measurements of emissions > 1MHz away from the band edges. The limit was adjusted with -13.01dB [10Log(50/1000)] to compensate for the reduce measurement bandwidth 50KHz for emission more than 1MHz away from the band edges. For MIMO mode, the limit of -32.03dBm was used for emission more than 1MHz away from the band edges. For Non-MIMO mode, the limit of -26.01dBm was used for emission more than 1MHz away from the band edges. Spectrum analyzer detector was set as RMS.

A.3.3 Measurement limit

The power of any emission outside of the authorized operating frequency ranges must be attenuated below the transmitting power (P) by a factor of at least $43 + 10\log(P)$ dB.

A.3.4 Measurement result

Configuration NB-IoT-GuardBand-1C, QPSK

Band Edge Frequency	Channel Bandwidth	RBW(KHz)	Limit(dBm)
Channel Position B 2110.0MHz	10.0 MHz	100	-19.02
	15.0 MHz	150	-19.02
	20.0 MHz	200	-19.02
Channel Position T 2180.0MHz	10.0 MHz	100	-19.02
	15.0 MHz	150	-19.02
	20.0 MHz	200	-19.02

Port D, Channel Position B, 10.0MHz

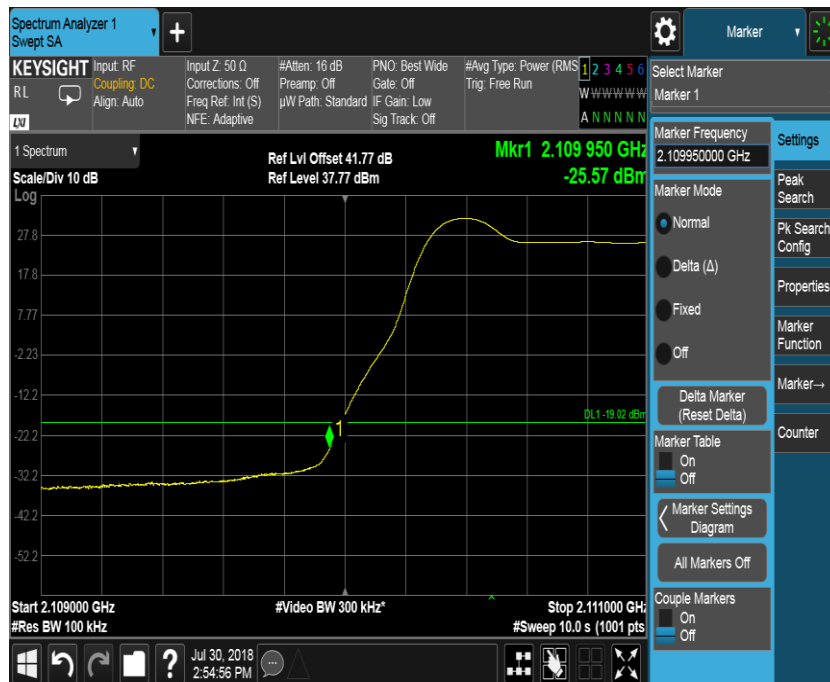

The channel power of 100kHz for 2109.950MHz is -29.18dBm, which is within the limit of-19.02dBm

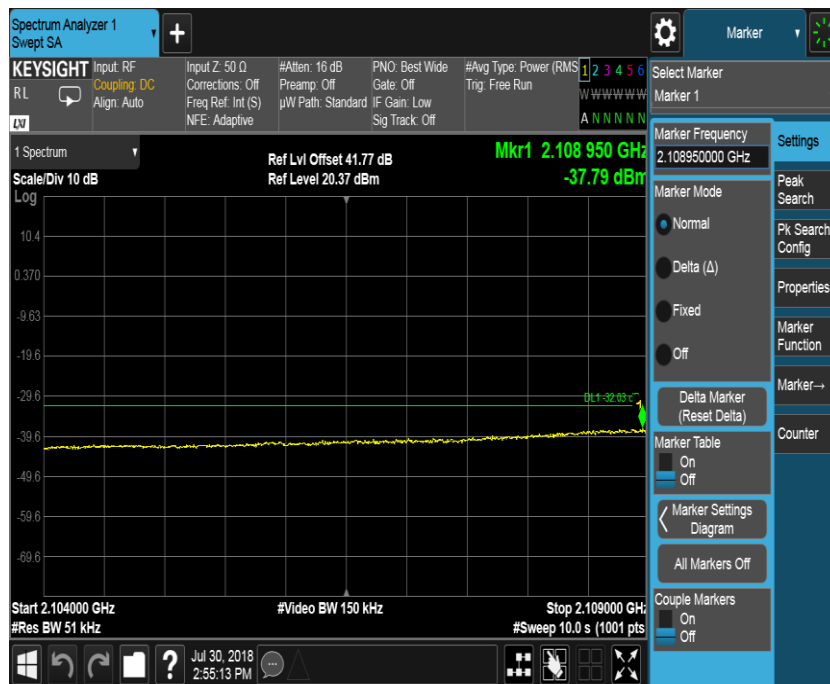
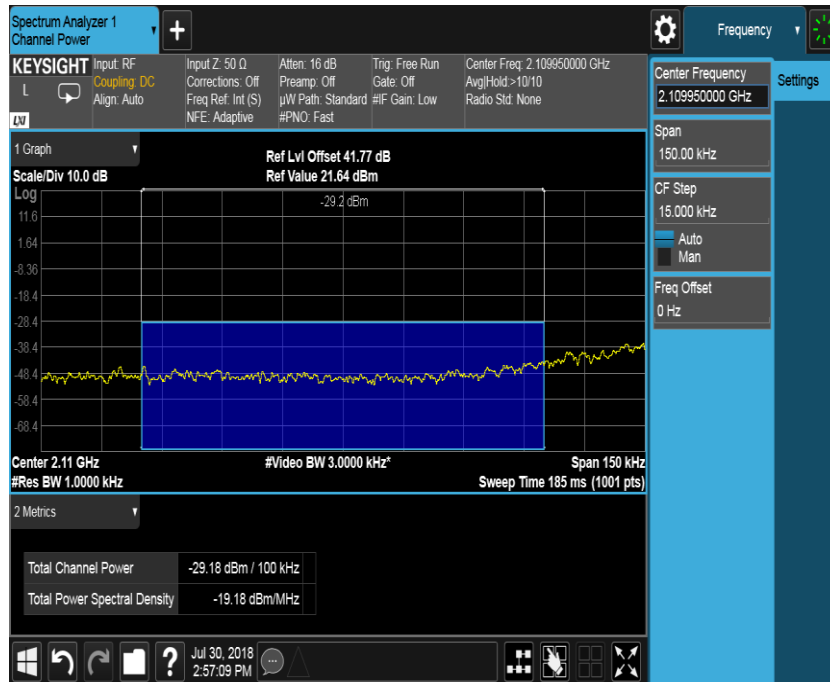

Port D, Channel Position T, 10.0MHz

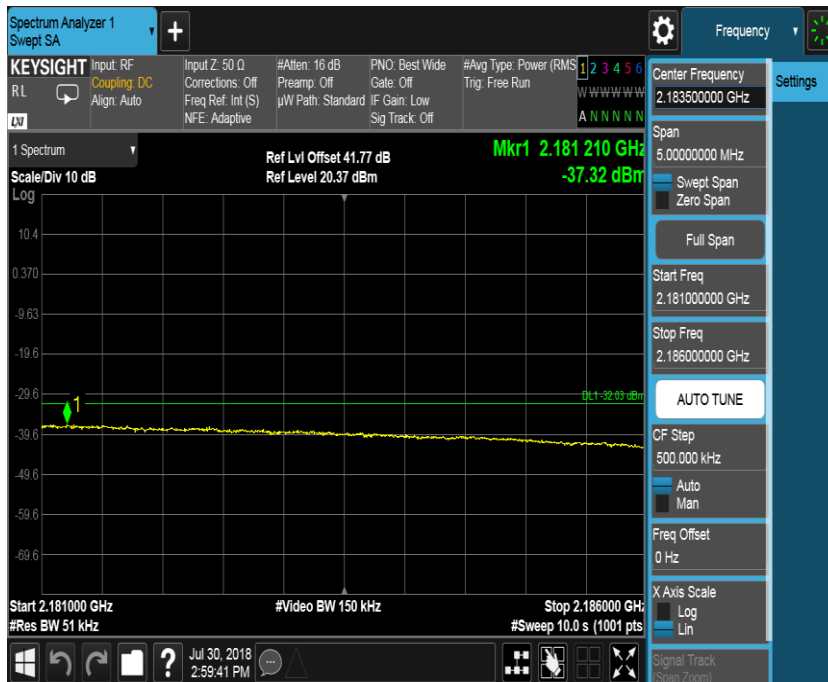

Port D, Channel Position B, 15.0MHz

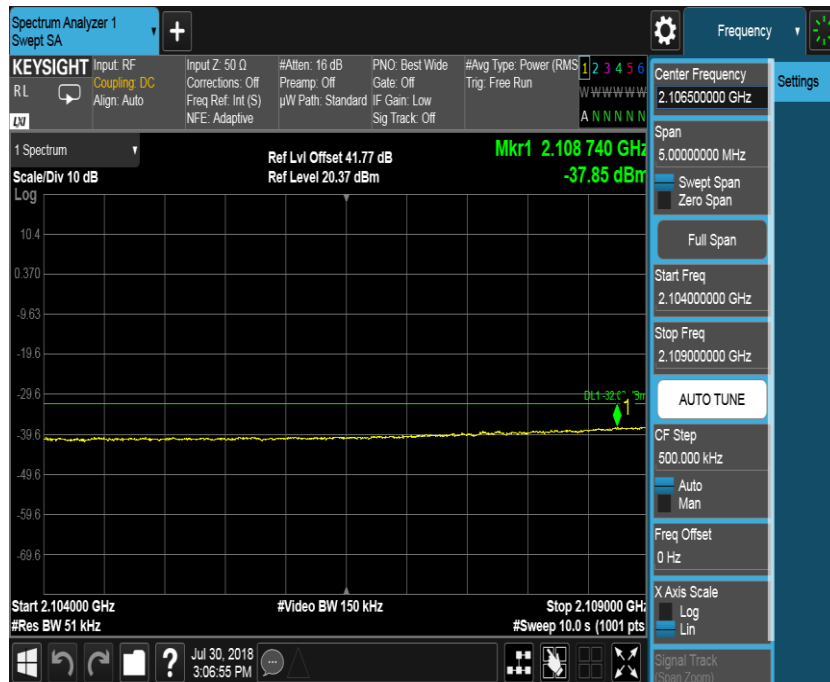

Port D, Channel Position T, 15.0MHz



Port D, Channel Position B, 20.0MHz

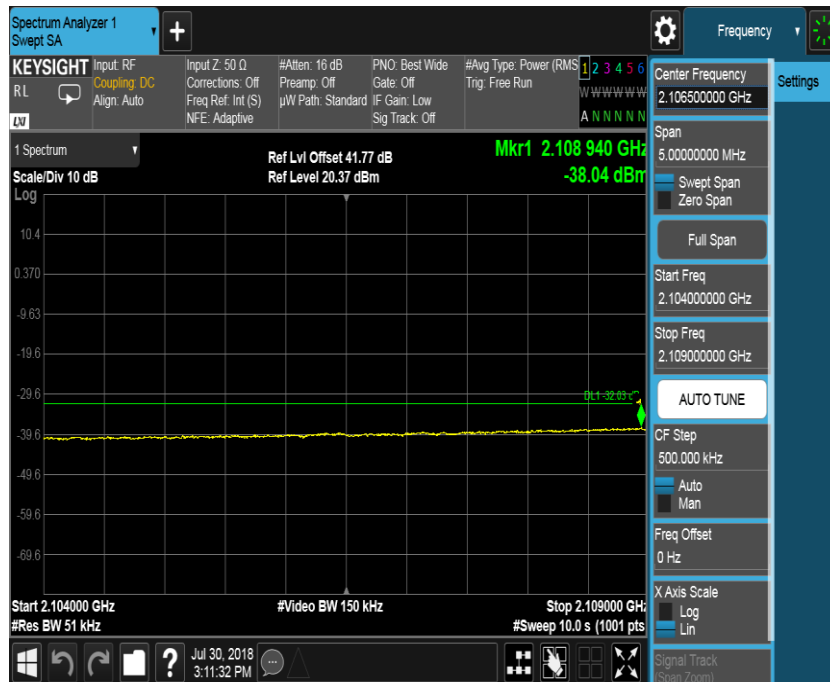
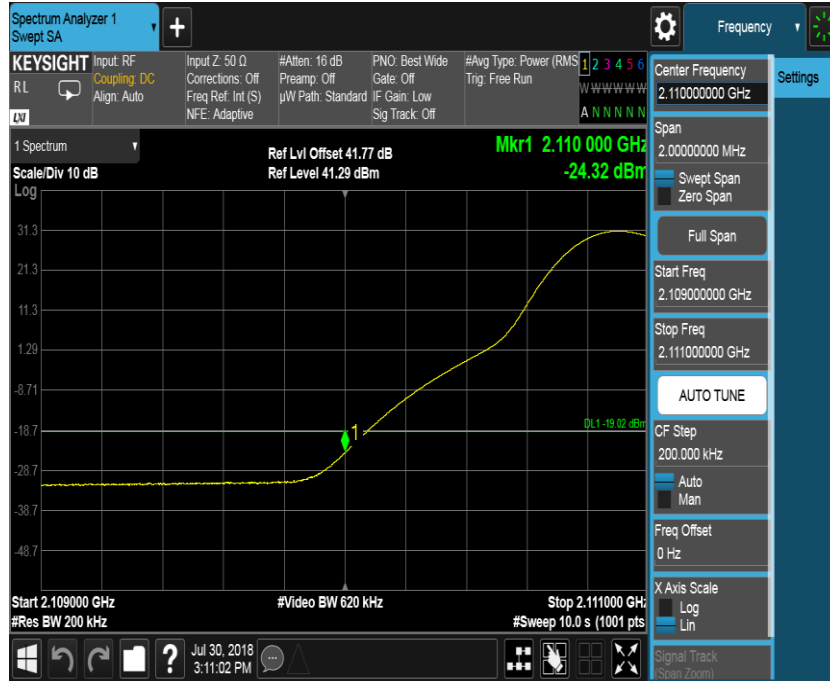

Port D, Channel Position T, 20.0MHz

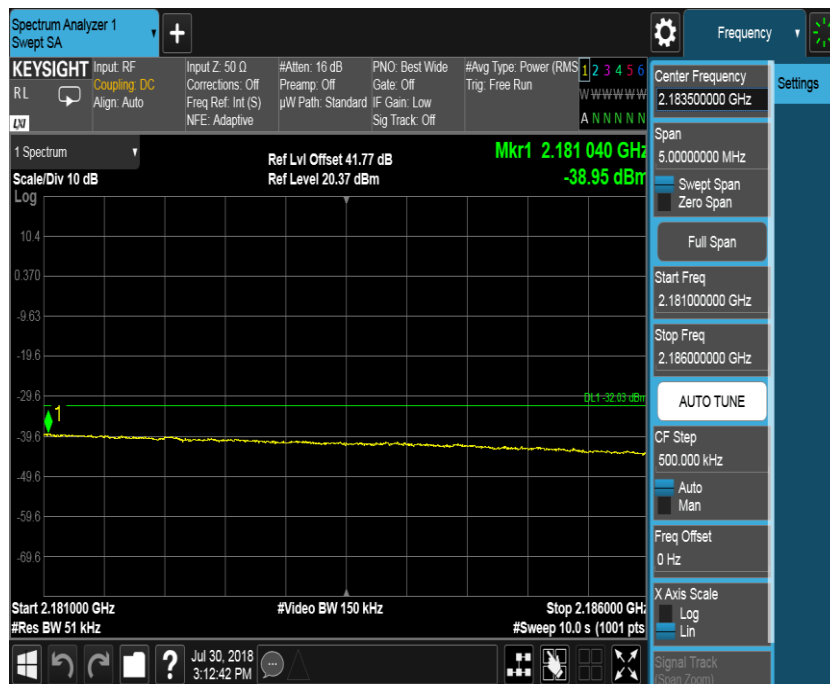

Configuration NB-IoT-IB+WCDMA-MIMO-MC-1-BE, (1IB, QPSK +1WCDMA, 16QAM)

Band Edge Frequency	Channel Bandwidth	RBW (KHz)	Limit (dBm)
Channel Position B 2110.0MHz	(IB) 5.0MHz, (W) 5.0MHz	51	-19.02

Port D, Channel Position B

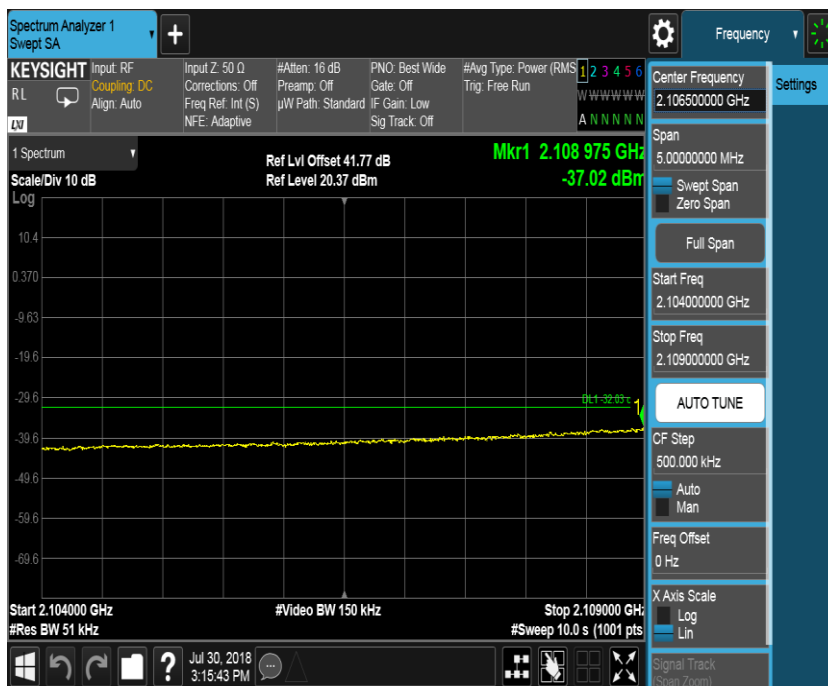
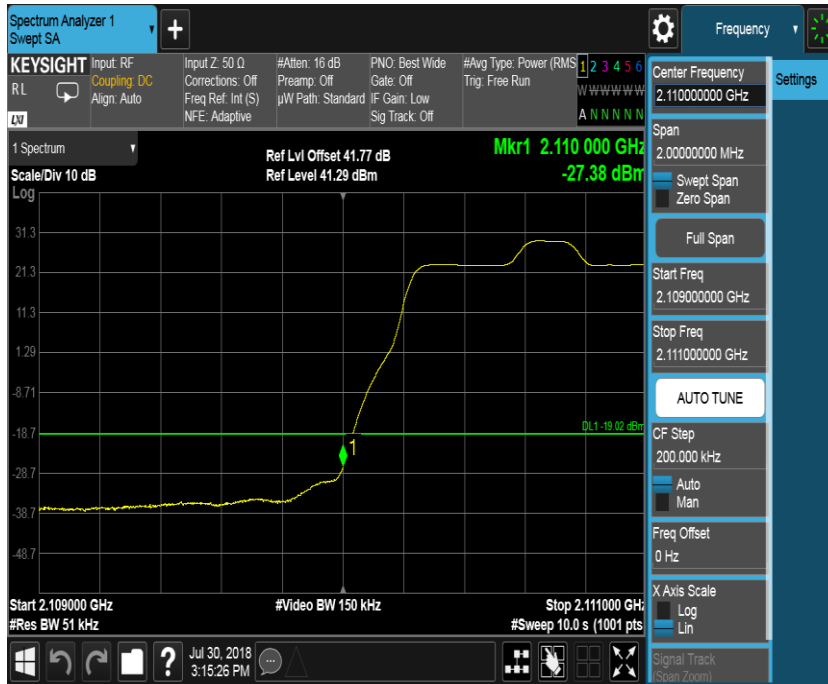

Configuration NB-IoT-IB+WCDMA-MIMO-MC-2-BE, (1IB, QPSK +2WCDMA, 16QAM)

Band Edge Frequency	Channel Bandwidth	RBW (KHz)	Limit (dBm)
Channel Position B 2110.0MHz	(IB) 5.0MHz, (W) 5.0MHz	51	-19.02

Port D, Channel Position B

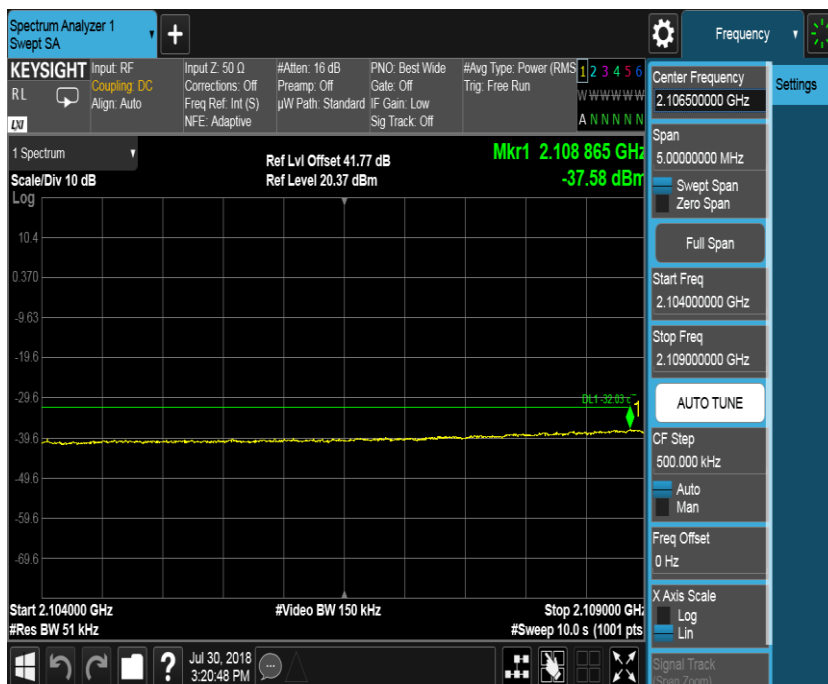

Configuration NB-IoT-GB+WCDMA-MIMO-MC-1-BE, (1GB, QPSK +1WCDMA, 16QAM)

Band Edge Frequency	Channel Bandwidth	RBW (KHz)	Limit (dBm)
Channel Position B 2110.0MHz	(GB) 10.0MHz, (W) 5.0MHz	51	-19.02

Port D, Channel Position B

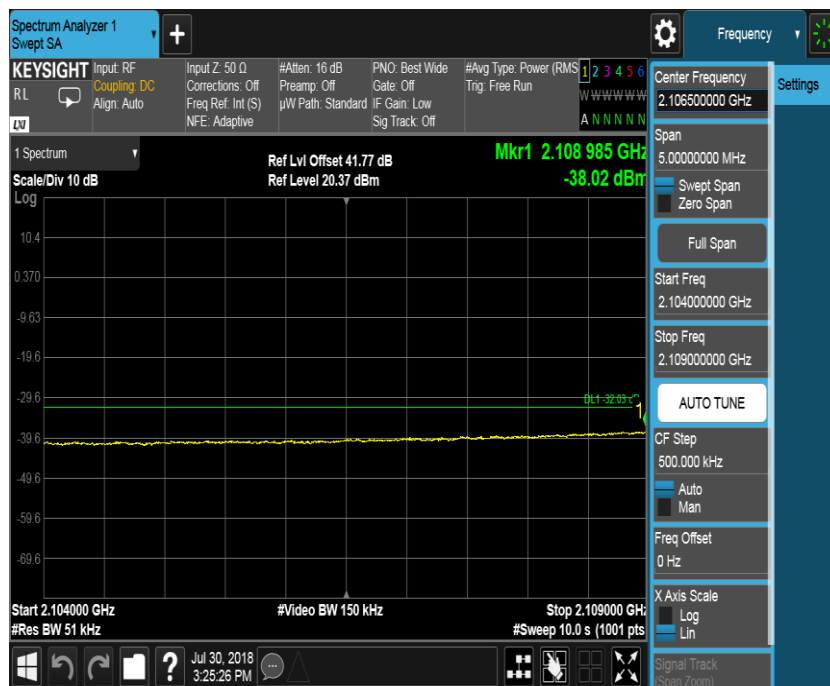

Configuration NB-IoT-GB+WCDMA-MIMO-MC-2-BE, (1GB, QPSK +2WCDMA, 16QAM)

Band Edge Frequency	Channel Bandwidth	RBW (KHz)	Limit (dBm)
Channel Position B 2110.0MHz	(GB)10.0MHz, (W) 5.0MHz	51	-19.02

Port D, Channel Position B

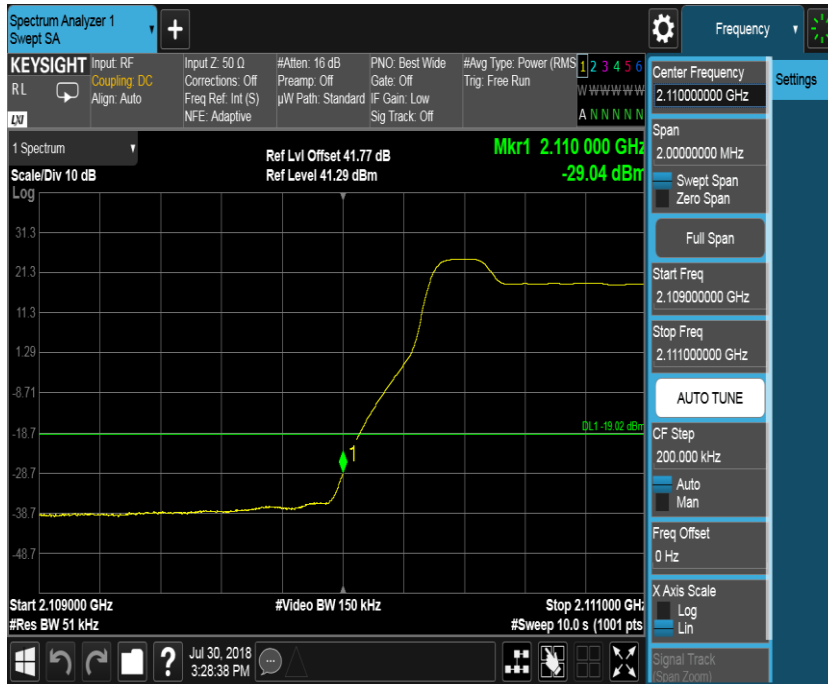

Configuration NB-IoT-IB+LTE-MIMO -MC-1-BE, (1IB, QPSK +1LTE, QPSK)

Band Edge Frequency	Channel Bandwidth	RBW (KHz)	Limit (dBm)
Channel Position B 2110.0MHz	(IB) 5.0MHz, (L) 5.0MHz	51	-19.02
Channel Position T 2180.0MHz	(IB) 5.0MHz, (L) 5.0MHz	51	-19.02

Port D, Channel Position B

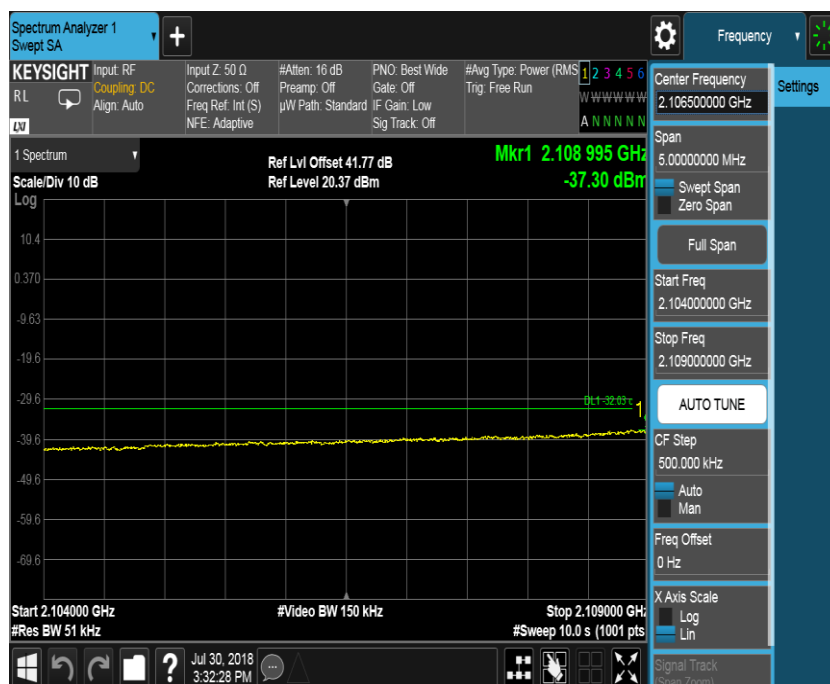

Port D, Channel Position T

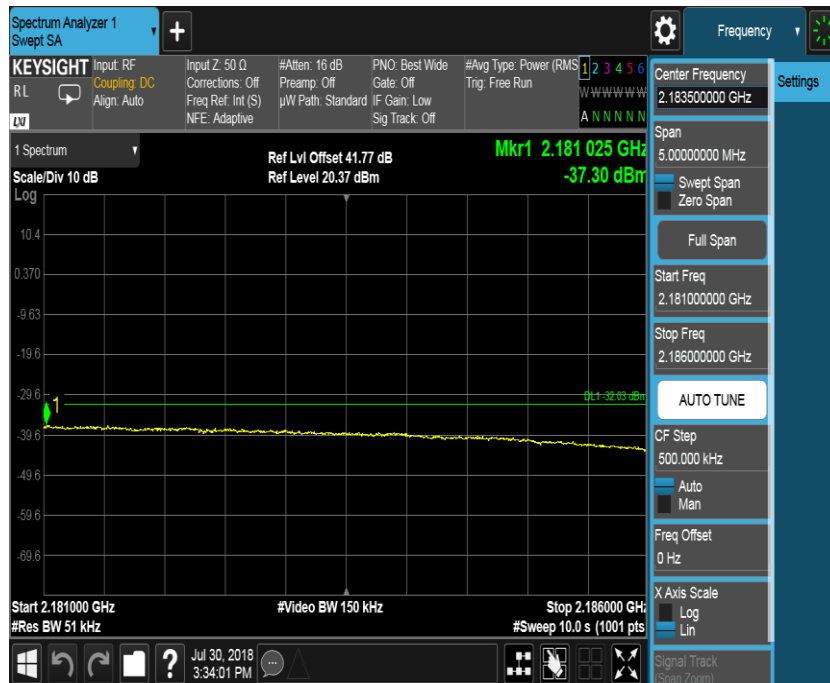

Configuration NB-IoT-IB+LTE-MIMO-MC-2-BE, (1IB, QPSK +2LTE, QPSK)

Band Edge Frequency	Channel Bandwidth	RBW (KHz)	Limit (dBm)
Channel Position B 2110.0MHz	(IB) 5.0MHz, (L) 5.0MHz	51	-19.02
Channel Position T 2180.0MHz	(IB) 5.0MHz, (L) 5.0MHz	51	-19.02

Port D, Channel Position B

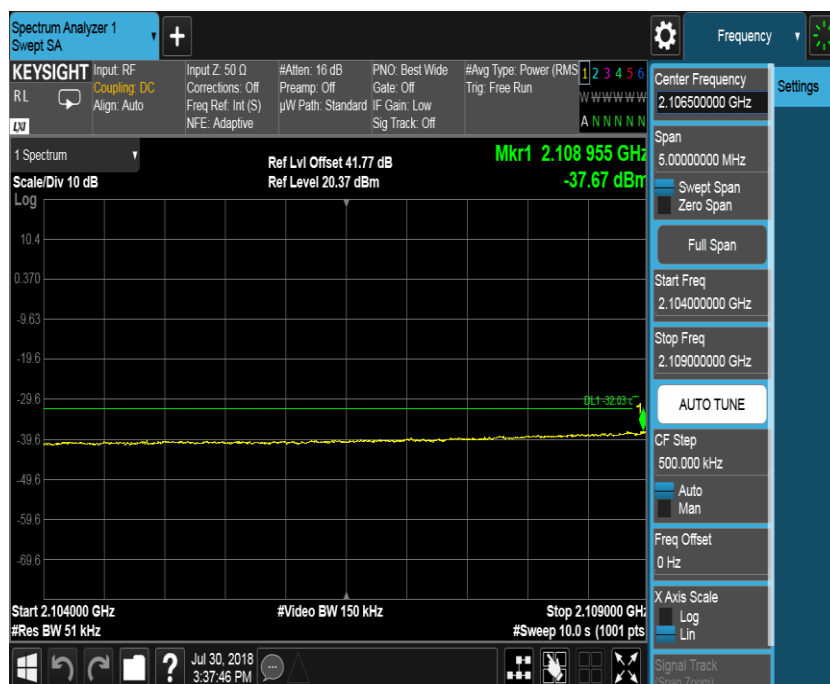

Port D, Channel Position T

