



Add value.
Inspire trust.



Report On

FCC and IC Testing of the
Ericsson KRC 161 636/1 (Radio 4415 B2 B25) (G3) NR (1900 MHz)
Base Station in accordance with FCC CFR 47 Part 2, FCC CFR 47 Part
24, Industry Canada RSS-GEN and Industry Canada RSS-133

COMMERCIAL-IN-CONFIDENCE

FCC ID: TA8FKRC161636

IC ID: 287AB-FS161636

PREPARED BY

Handwritten signature of Maggie Whiting.

Maggie Whiting
Key Account Manager

APPROVED BY

Handwritten signature of Steve Scarfe.

Steve Scarfe
Authorised Signatory

DATED

29 August 2019

Document 75946096 Report 03 Issue 1

August 2019



CONTENTS

Section	Page No
1	REPORT INFORMATION 2
1.1	Report Details 3
1.2	Brief Summary of Results 4
1.3	Configuration Description 5
1.4	Declaration of Build Status 6
1.5	Product Information 7
1.6	Test Setup 8
1.7	Test Conditions 9
1.8	Deviation From The Standard 9
1.9	Modification Record 9
2	TEST DETAILS 10
2.1	Maximum Peak Output Power and Peak to Average Ratio - Conducted 11
2.2	Occupied Bandwidth 16
2.3	Band Edge 28
2.4	Transmitter Spurious Emissions 40
3	TEST EQUIPMENT USED 50
3.1	Test Equipment Used 51
3.2	Measurement Uncertainty 53
4	ACCREDITATION, DISCLAIMERS AND COPYRIGHT 54
4.1	Accreditation, Disclaimers and Copyright 55
ANNEX A	Module Lists A.2



SECTION 1

REPORT INFORMATION



1.1 REPORT DETAILS

Manufacturer	Ericsson
Address	Torshamnsgatan 23 Kista SE-16480 Stockholm Sweden
Product Name & Product Number	Radio 4415 B2 B25 (G3) & KRC 161 636/3
Non-Tested Variants	Radio 4415 B2 B25 (G3) & KRC 161 636/1
IC Model Name	FS1616361, FS1616363
Serial Number(s)	D828110337
Software Version	CXP9013268/15 Revisions R80BL
Hardware Version	R5C
Test Specification/Issue/Date	FCC CFR 47 Part 2: 2018 FCC CFR 47 Part 24: 2018 Industry Canada RSS-GEN: Issue 5 Amdt 1: 2019 Industry Canada RSS-133: Issue 6: 2013, Amdt Jan 2018
Start of Test	13 August 2019
Finish of Test	13 August 2019
Name of Engineer(s)	Neil Rousell
Related Document(s)	KDB 971168 D01 v02r02 KDB 662911 D01 v02r01

ENGINEERING STATEMENT

The measurements shown in this report were made in accordance with the procedures described on test pages. All reported testing was carried out on a sample equipment to demonstrate compliance with FCC CFR 47 Part 24. The sample tested was found to comply with the requirements defined in the applied rules.

Test Engineer(s);

A handwritten signature in black ink, appearing to read 'Neil Rousell', written over a horizontal line.

Neil Rousell



1.2 BRIEF SUMMARY OF RESULTS

A brief summary of results for each configuration, in accordance with FCC CFR 47 Part 2, FCC CFR 47 Part 24, Industry Canada RSS-GEN and Industry Canada RSS-133 is shown below.

Section	Specification Clause				Test Description	Result
	FCC CFR 47 Part 2	FCC CFR 47 Part 24	RSS-GEN	RSS-133		
2.1	2.1046	24.232 (a)	-	6.4	Maximum Peak Output Power and Peak to Average Ratio - Conducted	Pass
2.2	2.1049	24.238 (b)	6.6	-	Occupied Bandwidth	Pass
2.3	2.1051	24.238 (b)	-	6.5	Band Edge	Pass
2.4	2.1051	24.238 (a)	-	6.5	Transmitter Spurious Emissions	Pass

Measurement Uncertainty Decision Statement

Determination of conformity with the specification limits is based on the results of the compliance measurement and does not take into account measurement instrumentation uncertainty as defined in ANSI C63.26:2015 Clause 1.3.



1.3 CONFIGURATION DESCRIPTION

Configuration	RAT	No. Of carriers	Carrier Bandwidth	Carrier Frequency Configuration (MHz)		
				Bottom	Middle	Top
A	NR	1	5 MHz – SCS 15kHz	1932.5	-	1987.5
	NR	1	10 MHz – SCS 15kHz	1935.0	-	1985.0
	NR	1	15 MHz – SCS 15kHz	1937.5	-	1982.5
	NR	1	20 MHz – SCS 15kHz	1940.0	-	1980.0
	NR	1	20 MHz – SCS 60kHz	1940.0	-	1980.0
B	NR	1	5 MHz – SCS 15kHz	1932.5	-	1992.5
	NR	1	10 MHz – SCS 15kHz	1935.0	-	1990.0
	NR	1	15 MHz – SCS 15kHz	1937.5	-	1987.5
	NR	1	20 MHz – SCS 15kHz	1940.0	-	1985.0
	NR	1	20 MHz – SCS 60kHz	1940.0	-	1985.0



1.4 DECLARATION OF BUILD STATUS

DECLARATION OF BUILD STATUS

MAIN EUT	
MANUFACTURING DESCRIPTION	Radio Unit
MANUFACTURER	Ericsson AB
PRODUCT NAME	Radio 4415 B2/B25
PART NUMBER	KRC161636/1 KRC161636/3 ¹
IC Model Name	FS1616361, FS1616363
SERIAL NUMBER	D828110337
HARDWARE VERSION	R5C
SOFTWARE VERSION	CXP9013268/15-R80BL
TRANSMITTER OPERATING RANGE	B2: 1930 - 1990 MHz B25: 1930 - 1995 MHz
MODULATIONS	GSM: GMSK, AQPSK, 8PSK WCDMA: QPSK, 16QAM, 64QAM LTE & NR: QPSK, 16QAM, 64QAM, 256QAM
ITU DESIGNATION OF EMISSION	GSM: 245KGXW GSM: 245KG7W NB-IoT SA channel: 200KG7D WCDMA 5 MHz BW channel: 5M00F9W LTE 1,4 MHz BW channel: 1M40F9W LTE 3 MHz BW channel: 3M00F9W LTE 5 MHz BW channel: 5M00F9W LTE 10 MHz BW channel: 10M0F9W LTE 15 MHz BW channel: 15M0F9W LTE 20 MHz BW channel: 20M0F9W NR 5 MHz BW channel: 4M47W7D NR 10 MHz BW channel: 9M29W7D NR 15 MHz BW channel: 14M1W7D NR 20 MHz BW channel: 18M9W7D
OUTPUT POWER (RMS) (W or dBm)	4 ports, 40W per port NB-IoT SA 1 x 20W per port
FCC ID	TA8FKRC161636
IC ID	287AB-FS161636
TECHNICAL DESCRIPTION (a brief description of the intended use and operation)	Base station radio

¹ KRC161636/3 is the test object, both variants are electrically equivalent, with only mechanical differences in the enclosure.

² Both band support NB IoT IB, GB & SA.

Signature Audun B Helle
Audun Helle

Date 2019-08-28

No responsibility will be accepted by TÜV SÜD Product Service UK Limited as to the accuracy of the information declared in this document by the manufacturer.

1.5 PRODUCT INFORMATION

1.5.1 Technical Description

The Equipment Under Test (EUT) Radio 4415 B2 B25 is an Ericsson AB Radio Unit working in the public mobile service 1900 MHz band which provides communication connections to 1900 MHz network. The Radio 4415 B2 B25 operates from a -48V DC supply.

The Equipment Under Test (EUT) is shown in the photograph below. A full technical description can be found in the Manufacturer's documentation.

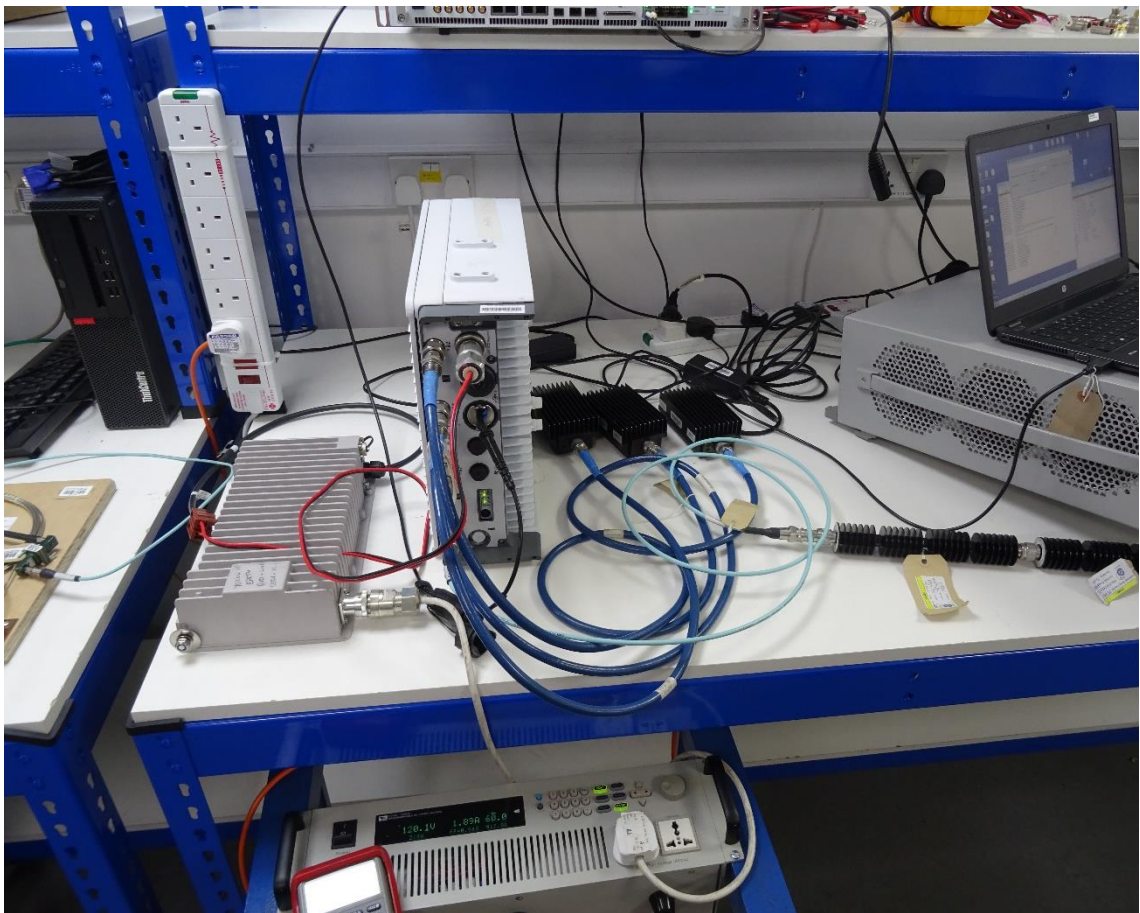

Equipment Under Test



1.6 TEST SETUP

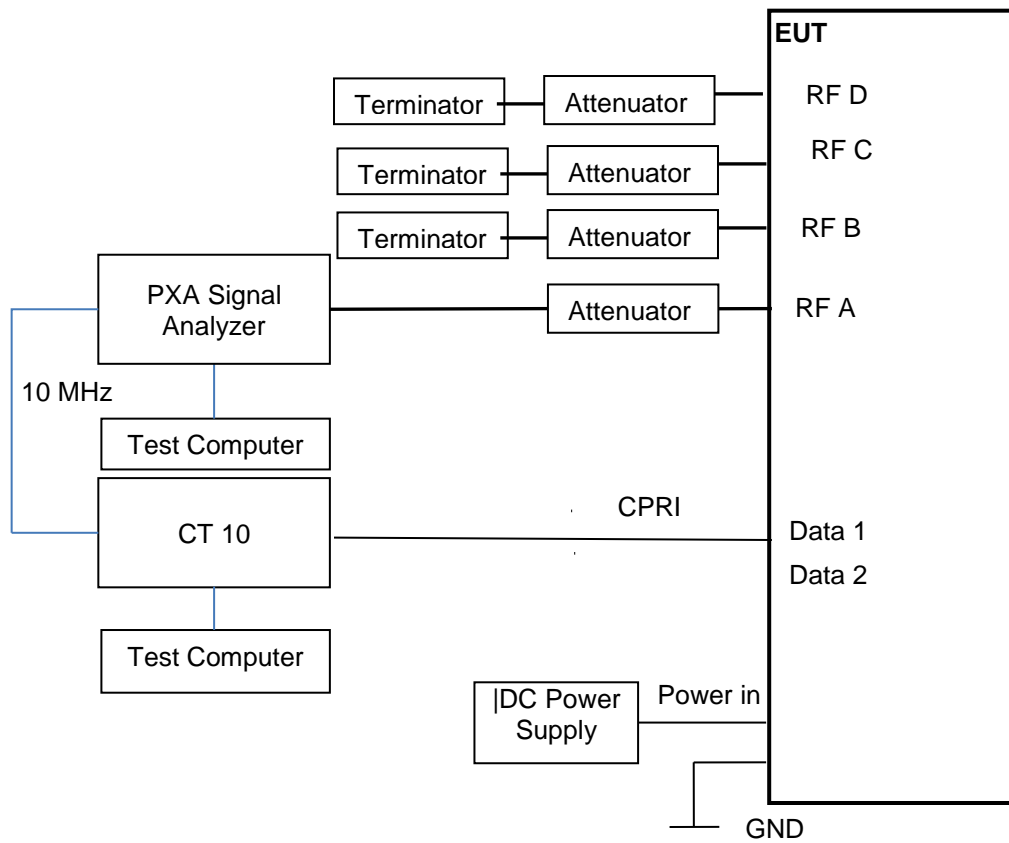



1.7 TEST CONDITIONS

For all tests the EUT was set up in accordance with the relevant test standard and to represent typical operating conditions. Tests were applied with the EUT situated in a shielded enclosure, test laboratories or a chamber as appropriate.

The EUT was powered from a -48V DC supply.

FCC Measurement Facility Registration Number
90987 Octagon House, Fareham Test Laboratory

Industry Canada Accreditation
IC2932B-1 Octagon House, Fareham Test Laboratory

1.8 DEVIATION FROM THE STANDARD

No deviations from the applicable test standards or test plan were made during testing.

1.9 MODIFICATION RECORD

No modifications were made to the EUT during testing.



SECTION 2

TEST DETAILS



2.1 MAXIMUM PEAK OUTPUT POWER AND PEAK TO AVERAGE RATIO - CONDUCTED

2.1.1 Specification Reference

FCC CFR 47 Part 2, Clause 2.1046
 FCC CFR 47 Part 24, Clause 24.232 (a)
 Industry Canada RSS-133, Clause 6.4

2.1.2 Date of Test and Modification State

13 August 2019 - Modification State 0

2.1.3 Test Equipment Used

The major items of test equipment used for the above tests are identified in Section 3.1.

2.1.4 Environmental Conditions

Ambient Temperature 24.2°C
 Relative Humidity 47.9%

2.1.5 Test Method

All measurements were made in accordance with FCC KDB 971168 D01, clause 5.2.1 and summed in accordance with FCC KDB 662911 D01.

2.1.6 Test Results

Configuration A

Maximum Output Power 46 dBm

Antenna	NR Modulation	NR Carrier Bandwidth	Peak to Average Ratio (PAR) / Output Power		
			PAR (dB)	Channel Position B	
				Average Power	
				dBm	dBm/MHz
A	QPSK	5.0 MHz 15 kHz SCS	7.46	45.59	39.52
A	QPSK	10.0 MHz 15 kHz SCS	-	45.69	-
A	QPSK	15.0 MHz 15 kHz SCS	-	45.64	-
A	QPSK	20.0 MHz 15 kHz SCS	-	45.50	-
A	QPSK	20.0 MHz 60 kHz SCS	-	45.63	-



Antenna A - NR Modulation QPSK - NR Carrier Bandwidth 5.0 MHz 15 kHz SCS - Channel Position B

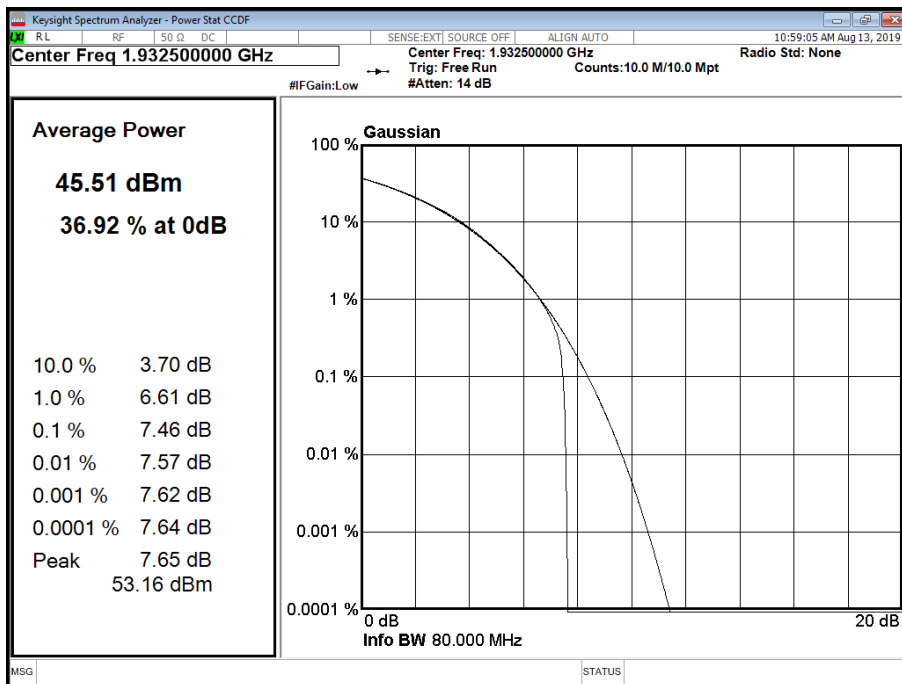

Configuration A

Maximum Output Power 46 dBm

Antenna	NR Modulation	NR Carrier Bandwidth	Peak to Average Ratio (PAR) / Output Power		
			Channel Position T		
			PAR (dB)	Average Power	
dBm	dBm/MHz				
A	QPSK	5.0 MHz 15 kHz SCS	7.49	45.61	39.74
A	QPSK	10.0 MHz 15 kHz SCS	-	45.81	-
A	QPSK	15.0 MHz 15 kHz SCS	-	45.75	-
A	QPSK	20.0 MHz 15 kHz SCS	-	45.80	-
A	QPSK	20.0 MHz 60 kHz SCS	-	45.82	-



Antenna A - NR Modulation QPSK - NR Carrier Bandwidth 5.0 MHz 15 kHz SCS - Channel Position T

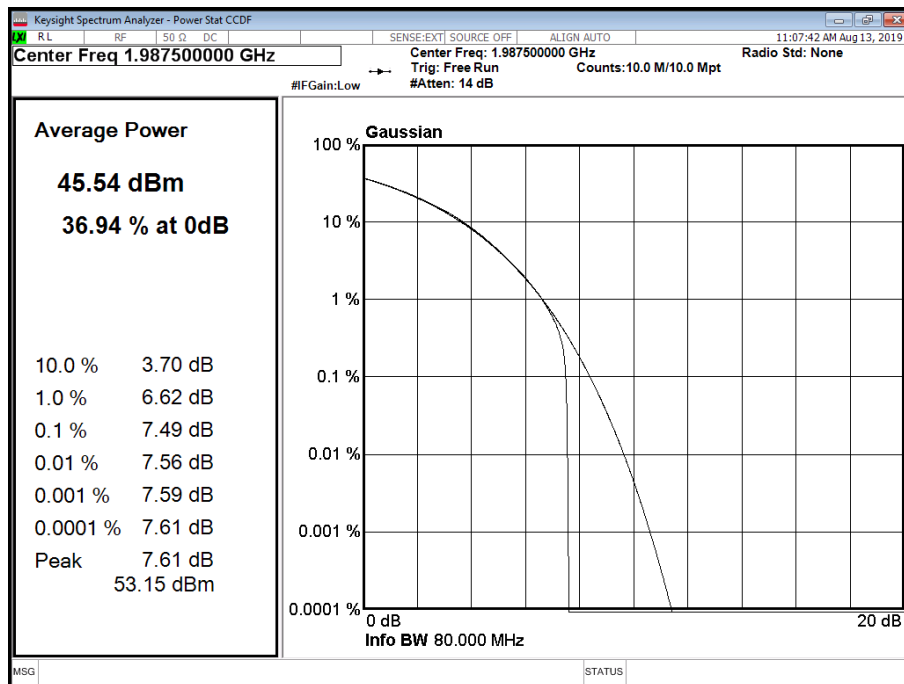

Configuration B

Maximum Output Power 46 dBm

Antenna	NR Modulation	NR Carrier Bandwidth	Peak to Average Ratio (PAR) / Output Power		
			Channel Position B		
			PAR (dB)	Average Power	
dBm	dBm/MHz				
A	QPSK	5.0 MHz 15 kHz SCS	7.46	45.59	39.52
A	QPSK	10.0 MHz 15 kHz SCS	-	45.69	-
A	QPSK	15.0 MHz 15 kHz SCS	-	45.64	-
A	QPSK	20.0 MHz 15 kHz SCS	-	45.50	-
A	QPSK	20.0 MHz 60 kHz SCS	-	45.63	-



Antenna A - NR Modulation QPSK - NR Carrier Bandwidth 5.0 MHz 15 kHz SCS - Channel Position B

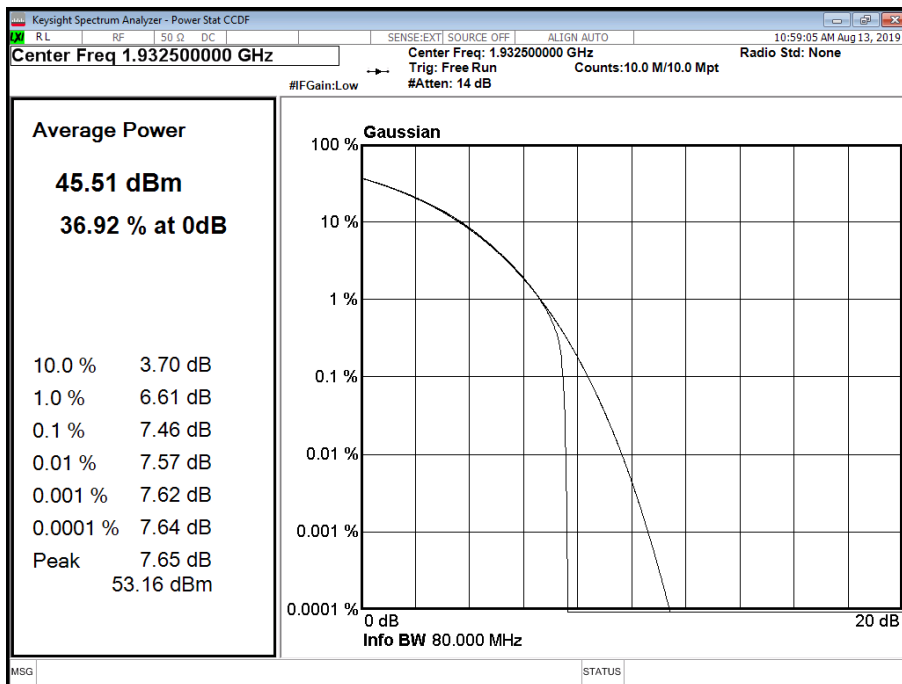

Configuration B

Maximum Output Power 46 dBm

Antenna	NR Modulation	NR Carrier Bandwidth	Peak to Average Ratio (PAR) / Output Power		
			Channel Position T		
			PAR (dB)	Average Power	
dBm	dBm/MHz				
A	QPSK	5.0 MHz 15 kHz SCS	7.50	45.27	39.39
A	QPSK	10.0 MHz 15 kHz SCS	-	45.42	-
A	QPSK	15.0 MHz 15 kHz SCS	-	45.60	-
A	QPSK	20.0 MHz 15 kHz SCS	-	45.61	-
A	QPSK	20.0 MHz 60 kHz SCS	-	45.69	-



Antenna A - NR Modulation QPSK - NR Carrier Bandwidth 5.0 MHz 15 kHz SCS - Channel Position T

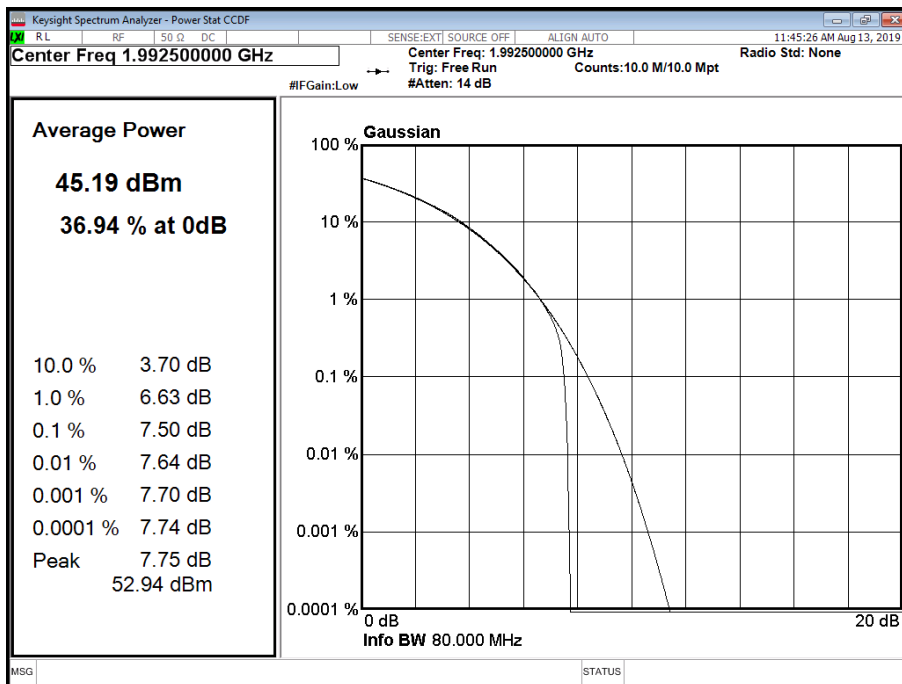

Limit	
Peak Power	≤500 W or ≤+57 dBm
Peak to Average Ratio	13 dB



2.2 OCCUPIED BANDWIDTH

2.2.1 Specification Reference

FCC CFR 47 Part 2, Clause 2.1049
 FCC CFR 47 Part 24, Clause 24.238 (b)
 Industry Canada RSS-GEN, Clause 6.6

2.2.2 Date of Test and Modification State

13 August 2019 - Modification State 0

2.2.3 Test Equipment Used

The major items of test equipment used for the above tests are identified in Section 3.1.

2.2.4 Environmental Conditions

Ambient Temperature 24.2°C
 Relative Humidity 47.9%

2.2.5 Test Method

All measurements were made in accordance with FCC KDB 971168 D01.

2.2.6 Test Results

Configuration A

Maximum Output Power 46 dBm

Antenna	NR Modulation	NR Carrier Bandwidth	Result (KHz)					
			Channel Position B		Channel Position M		Channel Position T	
			Occupied Bandwidth	-26 dB Bandwidth	Occupied Bandwidth	-26 dB Bandwidth	Occupied Bandwidth	-26 dB Bandwidth
A	QPSK	5.0 MHz 15 kHz SCS	4,464.49	4,826.84	-	-	4,466.19	4,829.26
A	QPSK	10.0 MHz 15 kHz SCS	9,288.90	9,784.91	-	-	9,284.37	9,782.41
A	QPSK	15.0 MHz 15 kHz SCS	14,094.44	14,730.26	-	-	14,104.67	14,713.57
A	QPSK	20.0 MHz 15 kHz SCS	18,923.77	19,778.50	-	-	18,910.61	19,756.50
A	QPSK	20.0 MHz 60 kHz SCS	17,248.44	19,617.39	-	-	17,274.15	19,530.49



Antenna A - NR Modulation QPSK - NR Carrier Bandwidth 5.0 MHz 15 kHz SCS - Channel Position B

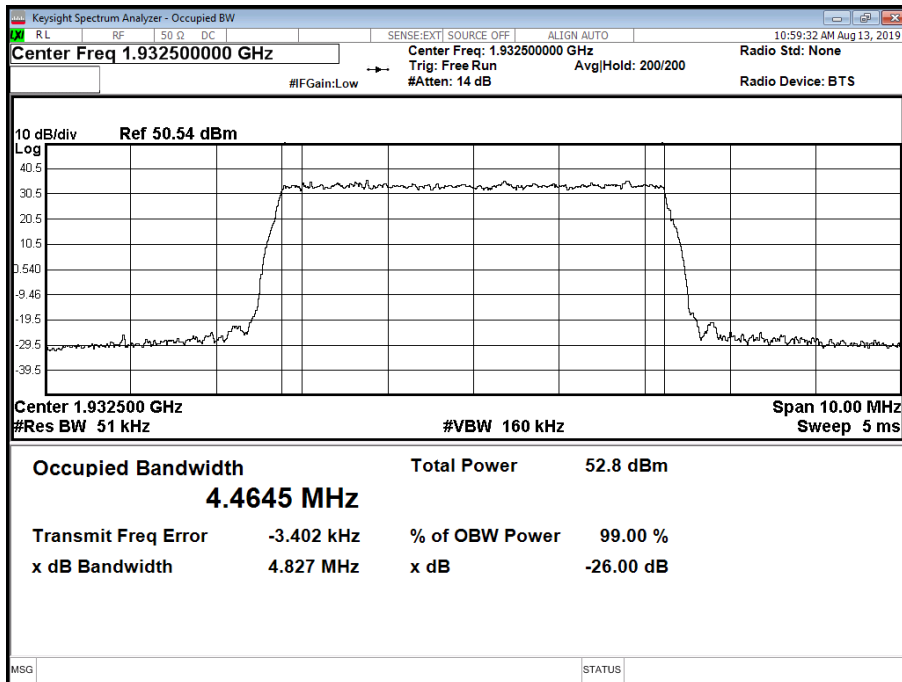

Antenna A - NR Modulation QPSK - NR Carrier Bandwidth 5.0 MHz 15 kHz SCS - Channel Position T

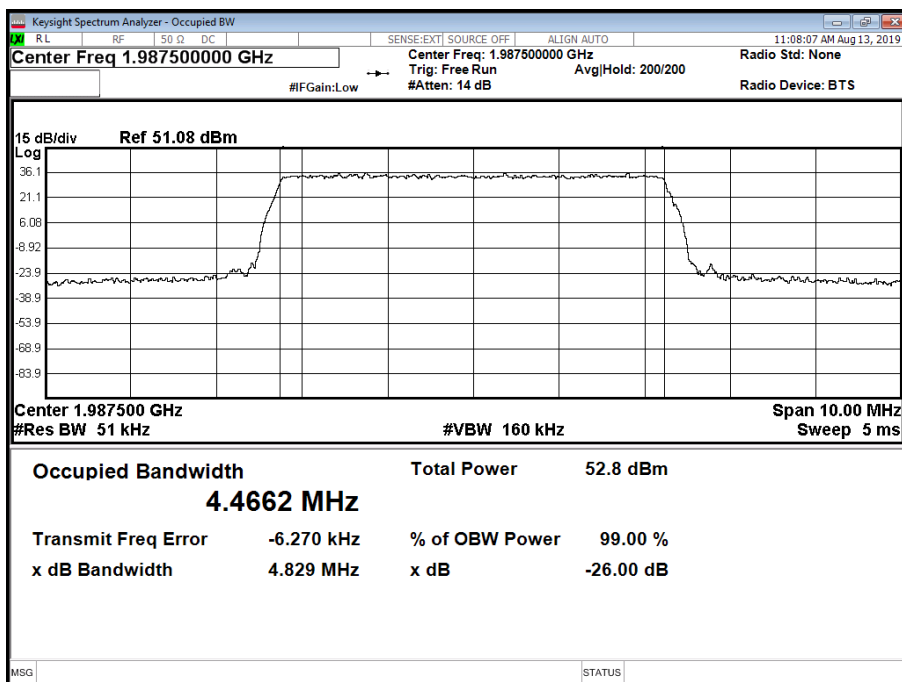



Antenna A - NR Modulation QPSK - NR Carrier Bandwidth 10.0 MHz 15 kHz SCS - Channel Position B

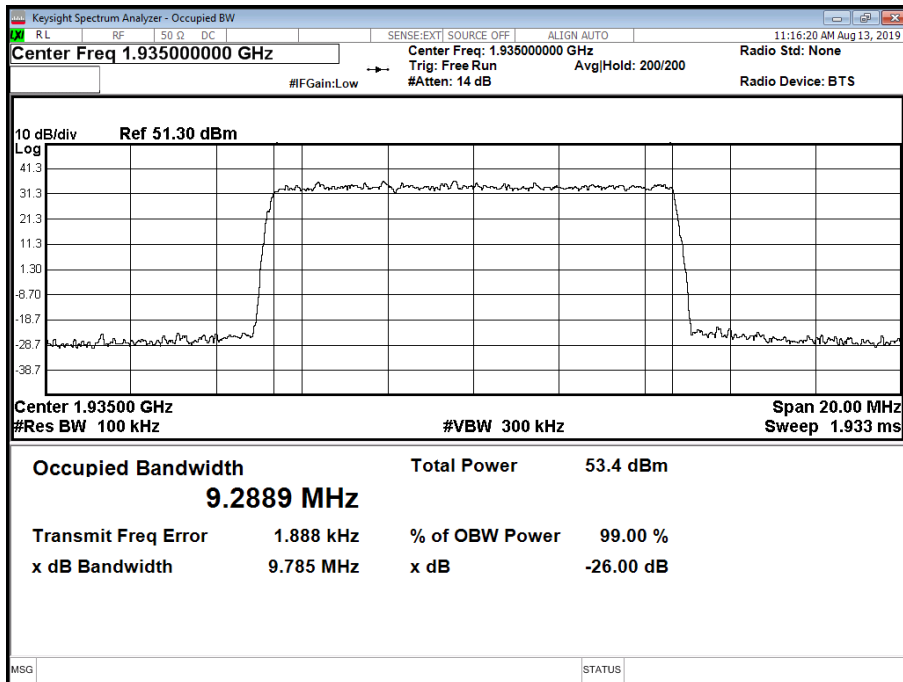

Antenna A - NR Modulation QPSK - NR Carrier Bandwidth 10.0 MHz 15 kHz SCS - Channel Position T

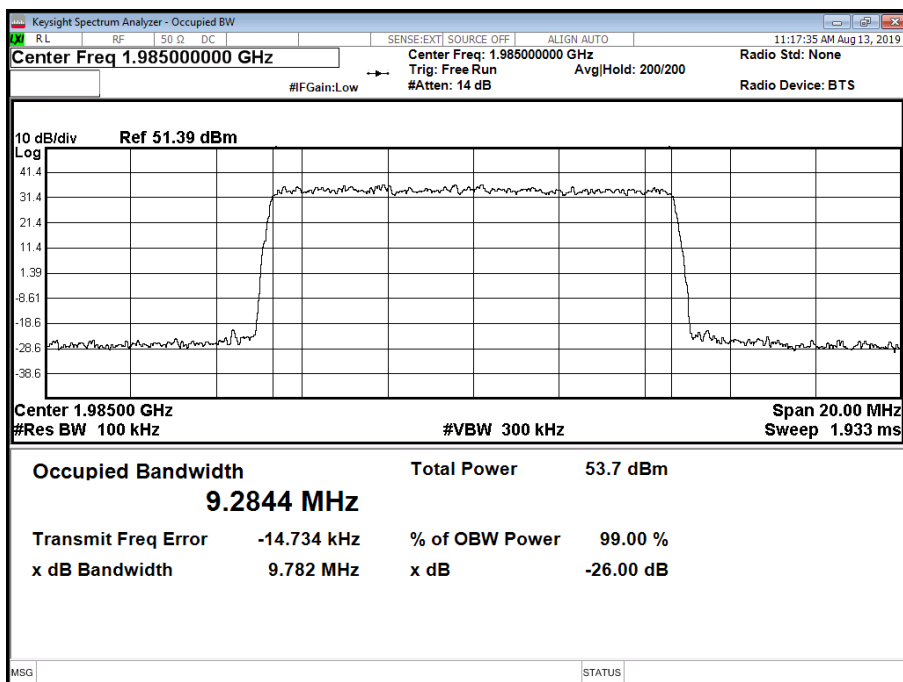



Antenna A - NR Modulation QPSK - NR Carrier Bandwidth 15.0 MHz 15 kHz SCS - Channel Position B

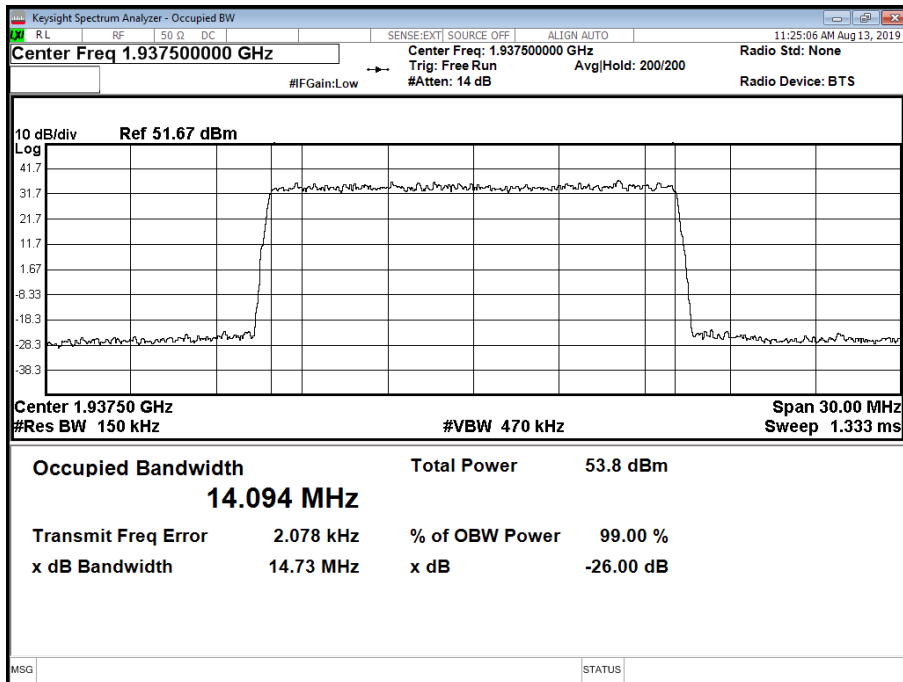

Antenna A - NR Modulation QPSK - NR Carrier Bandwidth 15.0 MHz 15 kHz SCS - Channel Position T

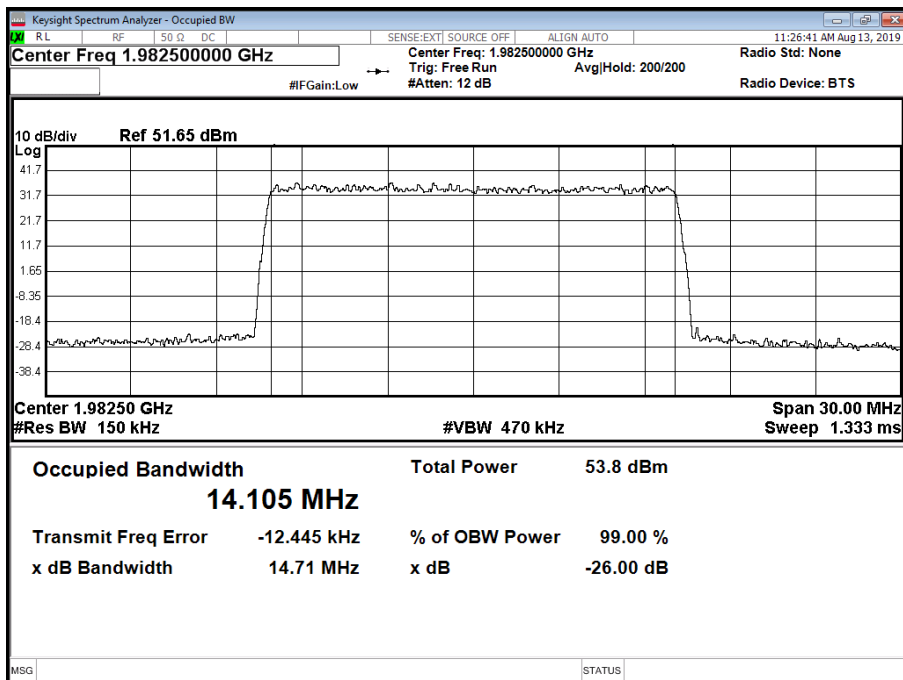



Antenna A - NR Modulation QPSK - NR Carrier Bandwidth 20.0 MHz 15 kHz SCS - Channel Position B

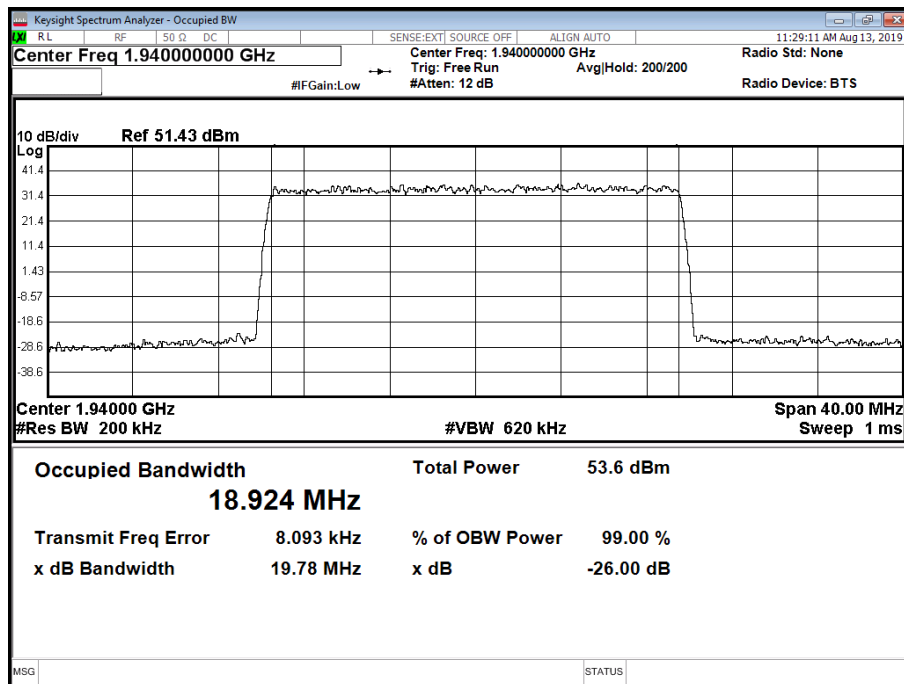

Antenna A - NR Modulation QPSK - NR Carrier Bandwidth 20.0 MHz 15 kHz SCS - Channel Position T

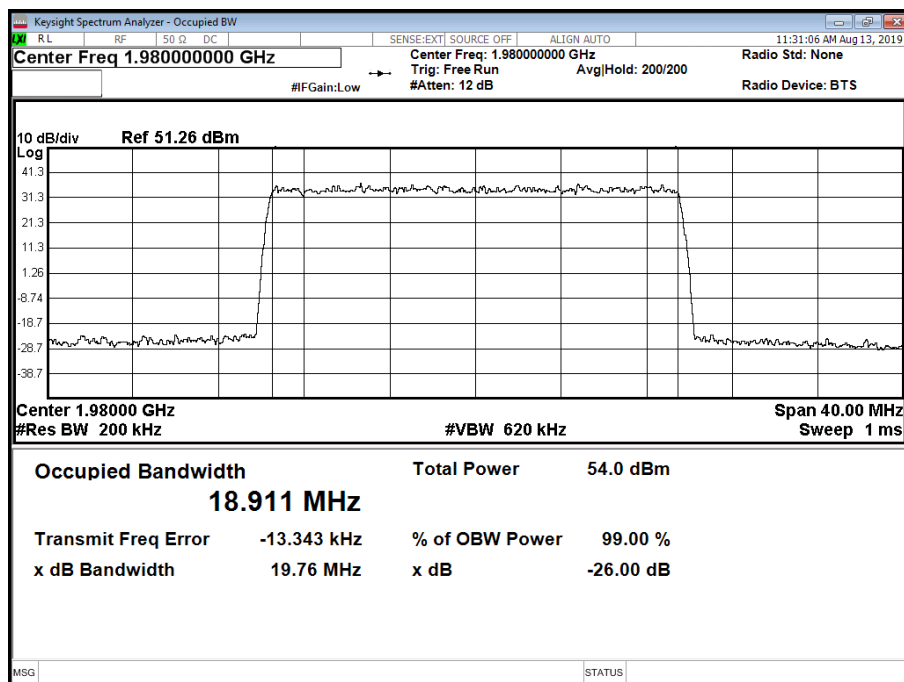



Antenna A - NR Modulation QPSK - NR Carrier Bandwidth 20.0 MHz 60 kHz SCS - Channel Position B

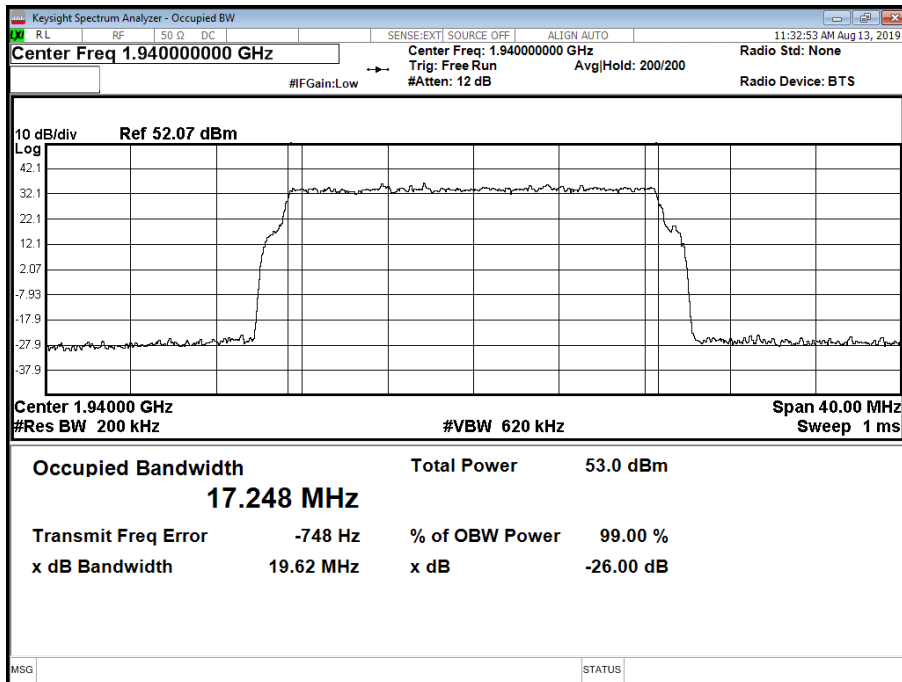

Antenna A - NR Modulation QPSK - NR Carrier Bandwidth 20.0 MHz 60 kHz SCS - Channel Position T

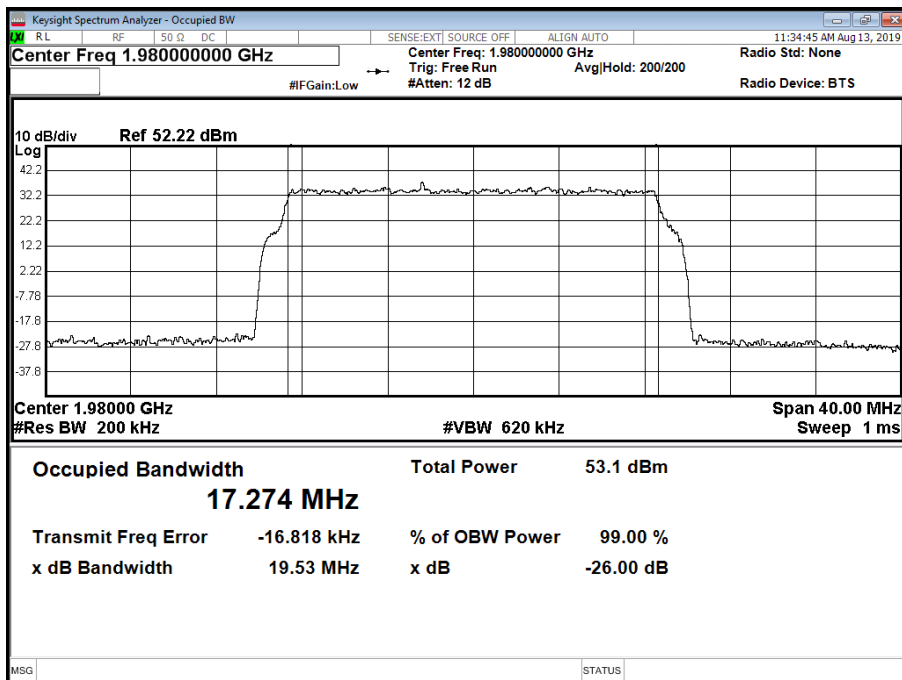



Configuration B

Maximum Output Power 46 dBm

Antenna	NR Modulation	NR Carrier Bandwidth	Result (KHz)					
			Channel Position B		Channel Position M		Channel Position T	
			Occupied Bandwidth	-26 dB Bandwidth	Occupied Bandwidth	-26 dB Bandwidth	Occupied Bandwidth	-26 dB Bandwidth
A	QPSK	5.0 MHz 15 kHz SCS	4,464.49	4,826.84	-	-	4,462.59	4,828.42
A	QPSK	10.0 MHz 15 kHz SCS	9,288.90	9,784.91	-	-	9,271.98	9,757.45
A	QPSK	15.0 MHz 15 kHz SCS	14,094.44	14,730.26	-	-	14,077.30	14,758.81
A	QPSK	20.0 MHz 15 kHz SCS	18,923.77	19,778.50	-	-	18,922.92	19,756.48
A	QPSK	20.0 MHz 60 kHz SCS	17,248.44	19,617.39	-	-	17,263.30	19,508.60

Antenna A - NR Modulation QPSK - NR Carrier Bandwidth 5.0 MHz 15 kHz SCS - Channel Position B

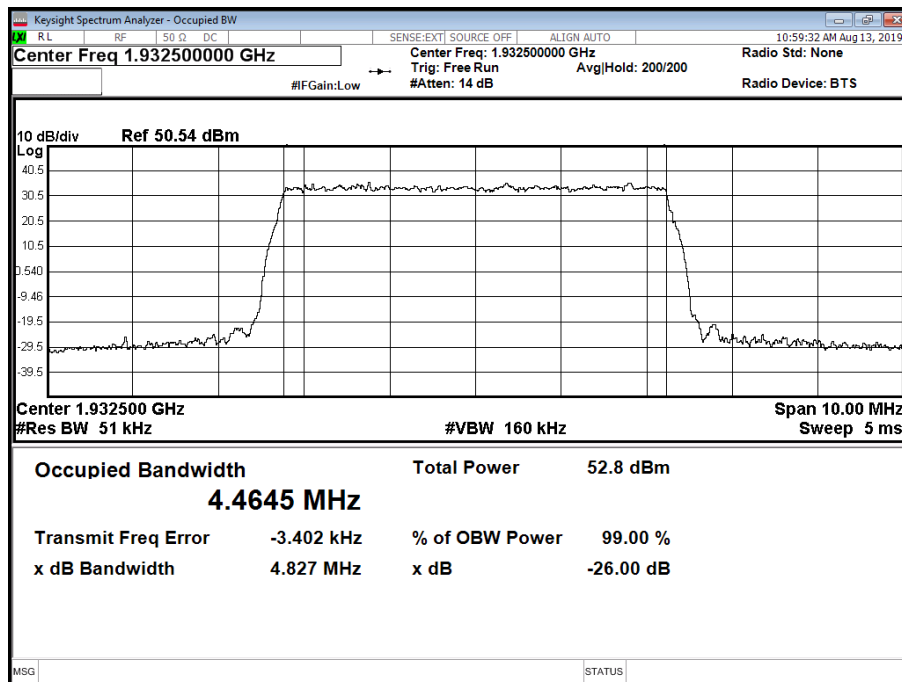



Antenna A - NR Modulation QPSK - NR Carrier Bandwidth 5.0 MHz 15 kHz SCS - Channel Position T

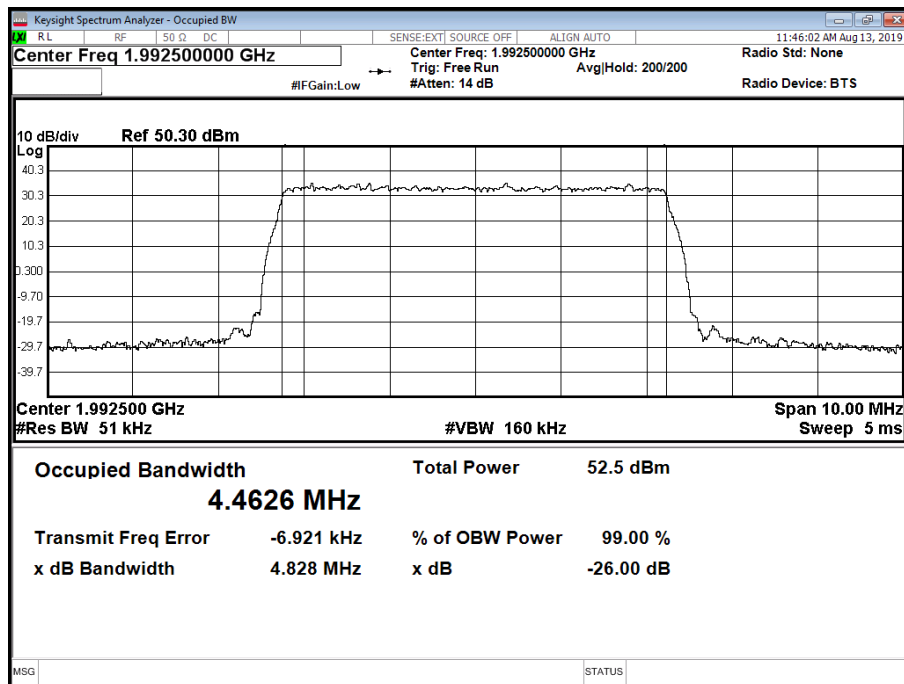

Antenna A - NR Modulation QPSK - NR Carrier Bandwidth 10.0 MHz 15 kHz SCS - Channel Position B

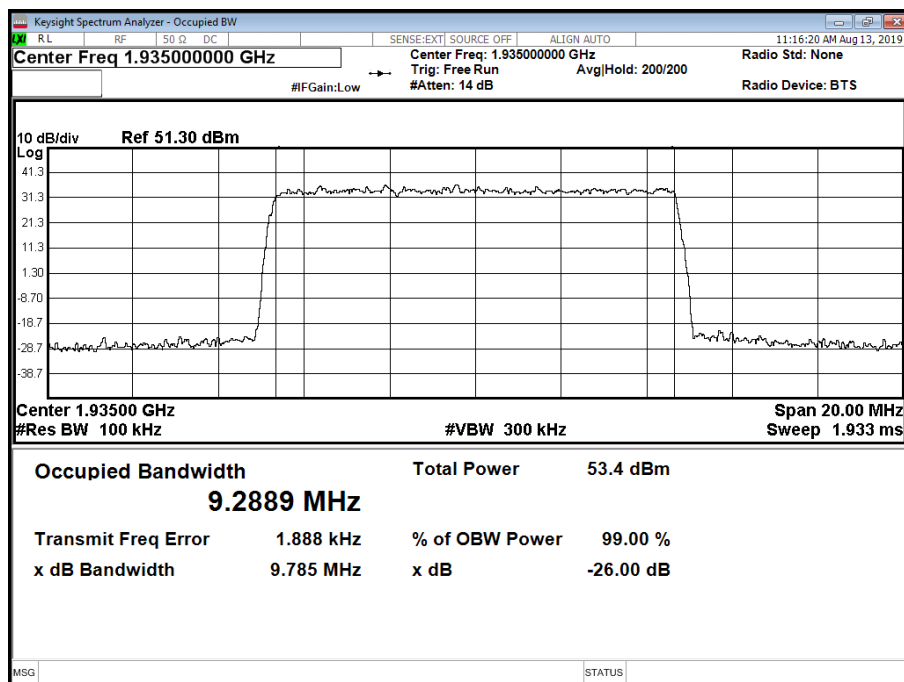



Antenna A - NR Modulation QPSK - NR Carrier Bandwidth 10.0 MHz 15 kHz SCS - Channel Position T

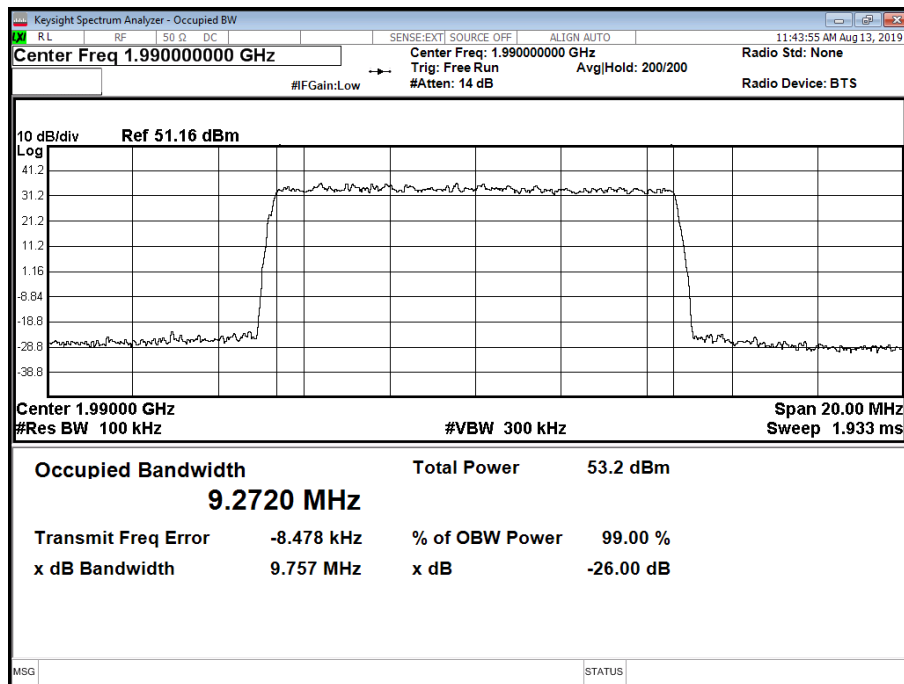

Antenna A - NR Modulation QPSK - NR Carrier Bandwidth 15.0 MHz 15 kHz SCS - Channel Position B

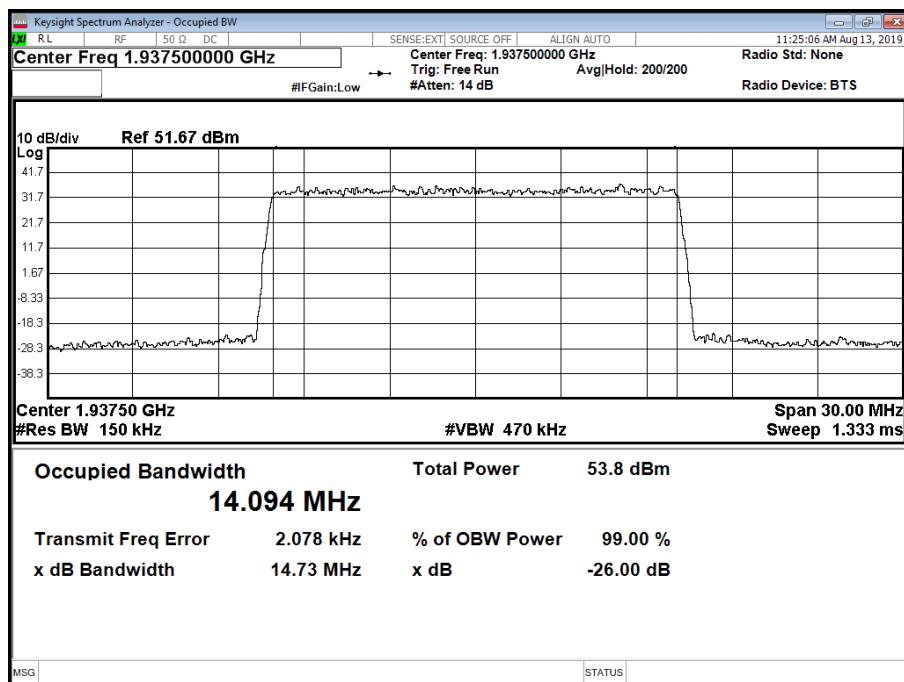



Antenna A - NR Modulation QPSK - NR Carrier Bandwidth 15.0 MHz 15 kHz SCS - Channel Position T

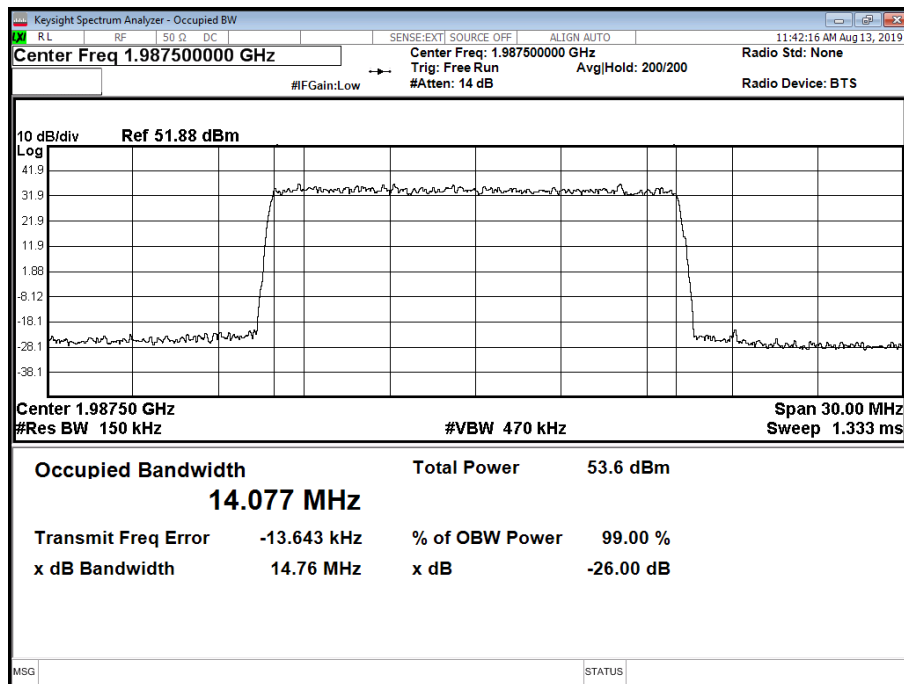

Antenna A - NR Modulation QPSK - NR Carrier Bandwidth 20.0 MHz 15 kHz SCS - Channel Position B

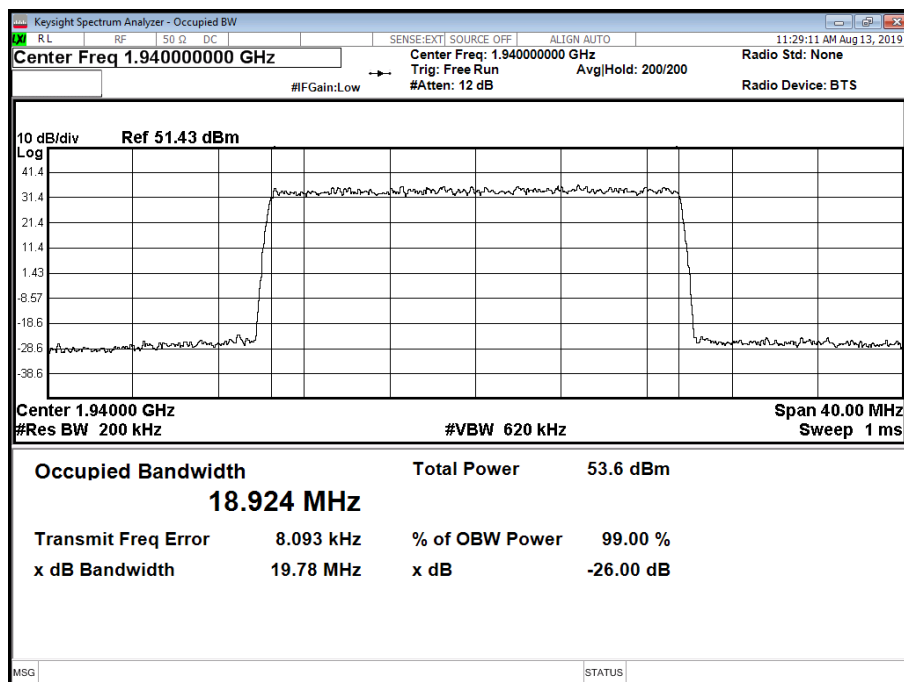



Antenna A - NR Modulation QPSK - NR Carrier Bandwidth 20.0 MHz 15 kHz SCS - Channel Position T

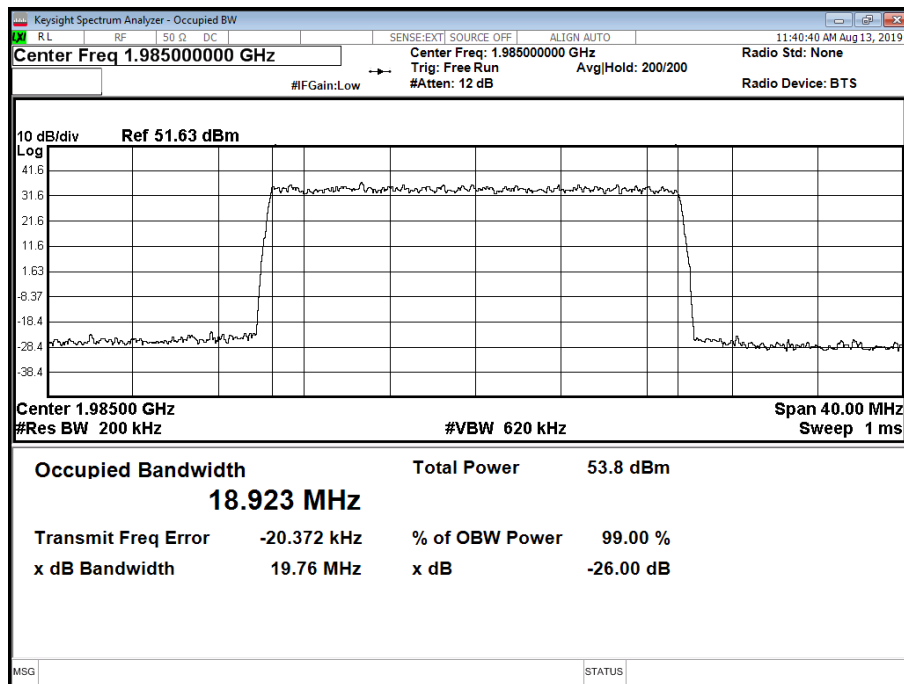

Antenna A - NR Modulation QPSK - NR Carrier Bandwidth 20.0 MHz 60 kHz SCS - Channel Position B

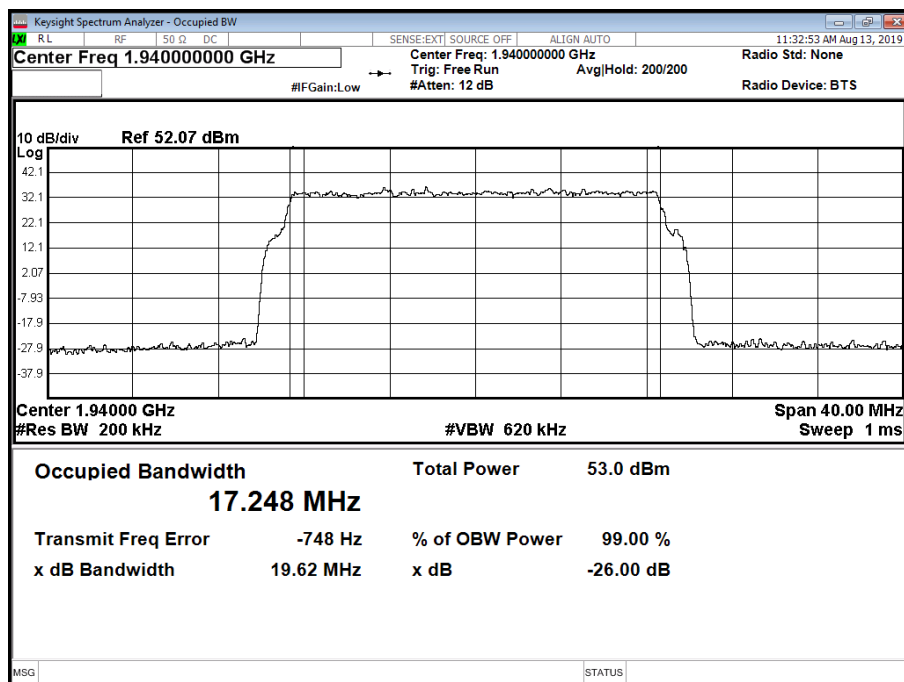



Antenna A - NR Modulation QPSK - NR Carrier Bandwidth 20.0 MHz 60 kHz SCS - Channel Position T

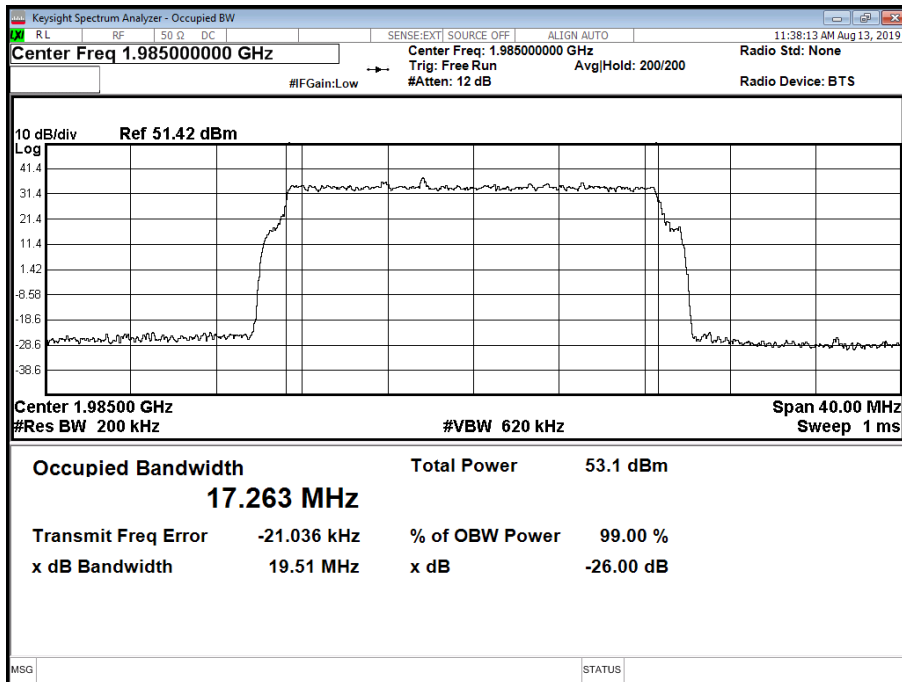



2.3 BAND EDGE

2.3.1 Specification Reference

FCC CFR 47 Part 2, Clause 2.1051
 FCC CFR 47 Part 24, Clause 24.238 (b)
 Industry Canada RSS-133, Clause 6.5

2.3.2 Date of Test and Modification State

13 August 2019 - Modification State 0

2.3.3 Test Equipment Used

The major items of test equipment used for the above tests are identified in Section 3.1.

2.3.4 Environmental Conditions

Ambient Temperature 24.2°C
 Relative Humidity 47.9%

2.3.5 Test Method

All measurements were made in accordance with FCC KDB 971168 D01.

Each antenna port has been declared as being equivalent, therefore measurements were made on one antenna port only. To account for this, the limit was tightened by $10 * \text{Log}(N)$, where N is equal to the number of MIMO antenna ports.

For single Port, the limit is calculated as being $-13 \text{ dBm} - 10 * \text{Log}(1) = -13 \text{ dBm}$.

For four Ports, the limit was calculated as being $-13 \text{ dBm} - 10 * \text{Log}(4) = -19 \text{ dBm}$.

2.3.6 Test Results

Configuration A

Maximum Output Power 46 dBm

Antenna	NR Modulation	NR Carrier Bandwidth	Band Edge (MHz)	
			Channel Position B	Channel Position T
A	QPSK	5.0 MHz 15 kHz SCS	1,932.5	1,987.5
A	QPSK	10.0 MHz 15 kHz SCS	1,935.0	1,985.0
A	QPSK	15.0 MHz 15 kHz SCS	1,937.5	1,982.5
A	QPSK	20.0 MHz 15 kHz SCS	1,940.0	1,980.0
A	QPSK	20.0 MHz 60 kHz SCS	1,940.0	1,980.0



Antenna A - NR Modulation QPSK - NR Carrier Bandwidth 5.0 MHz 15 kHz SCS - Channel Position B

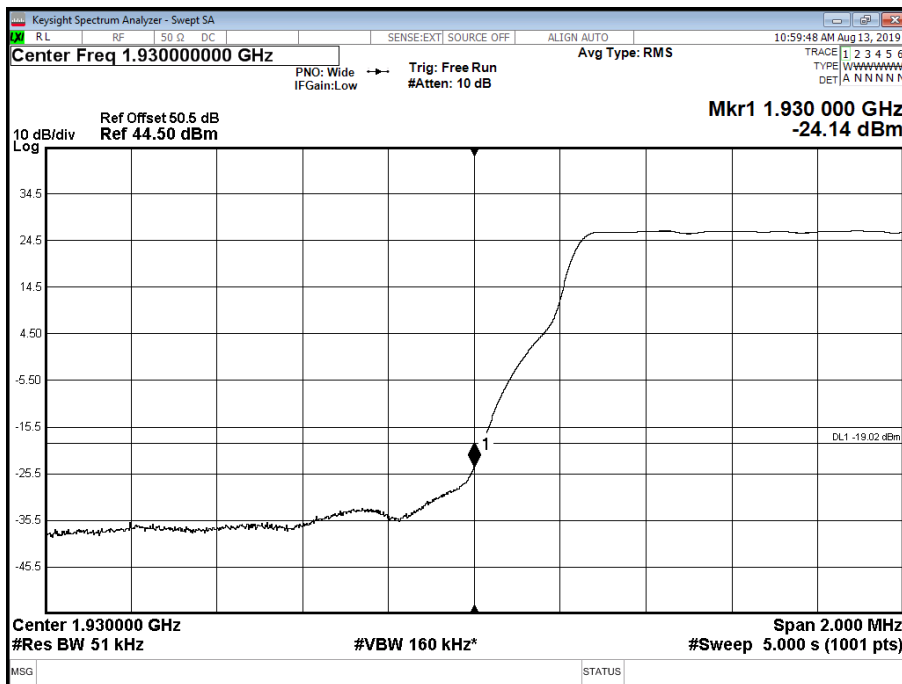

Antenna A - NR Modulation QPSK - NR Carrier Bandwidth 5.0 MHz 15 kHz SCS - Channel Position T

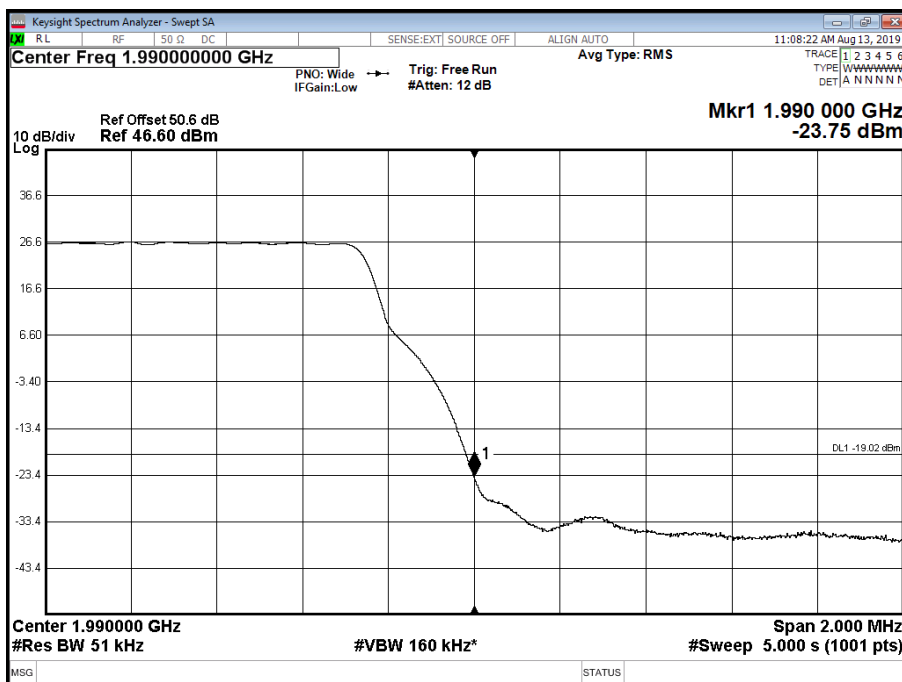



Antenna A - NR Modulation QPSK - NR Carrier Bandwidth 10.0 MHz 15 kHz SCS - Channel Position B

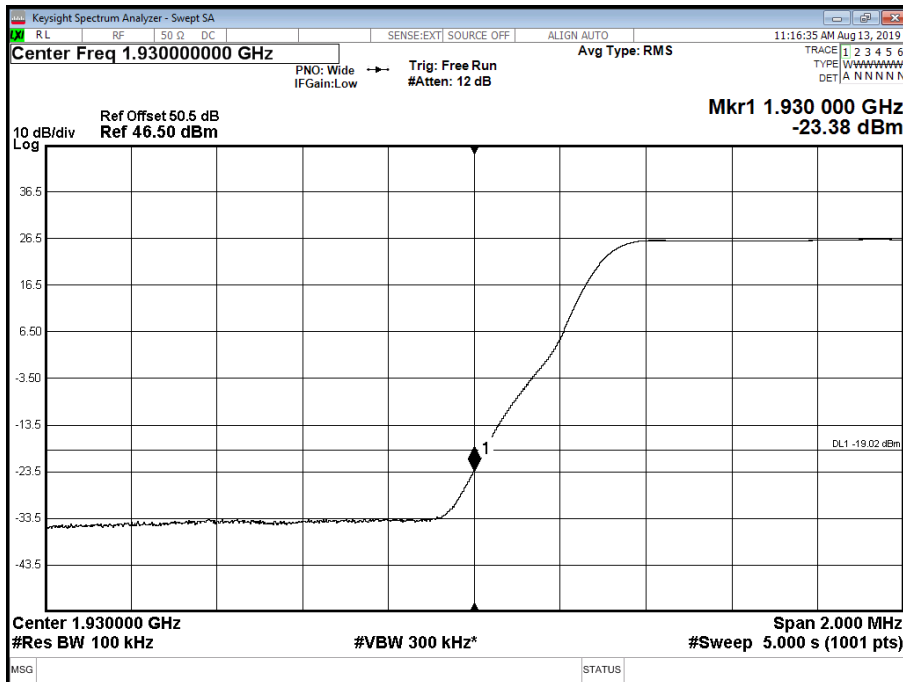

Antenna A - NR Modulation QPSK - NR Carrier Bandwidth 10.0 MHz 15 kHz SCS - Channel Position T

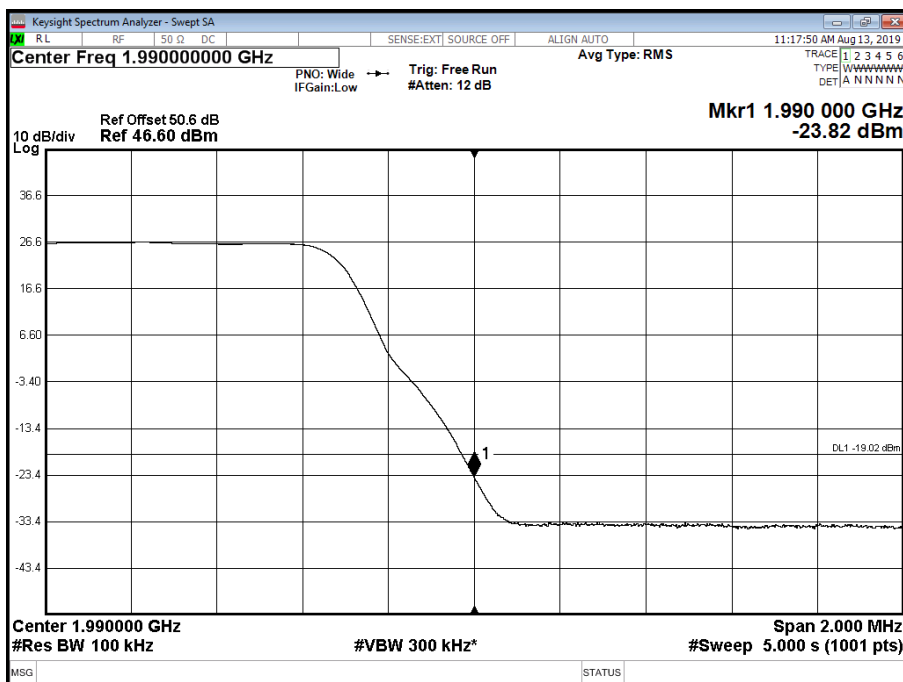



Antenna A - NR Modulation QPSK - NR Carrier Bandwidth 15.0 MHz 15 kHz SCS - Channel Position B

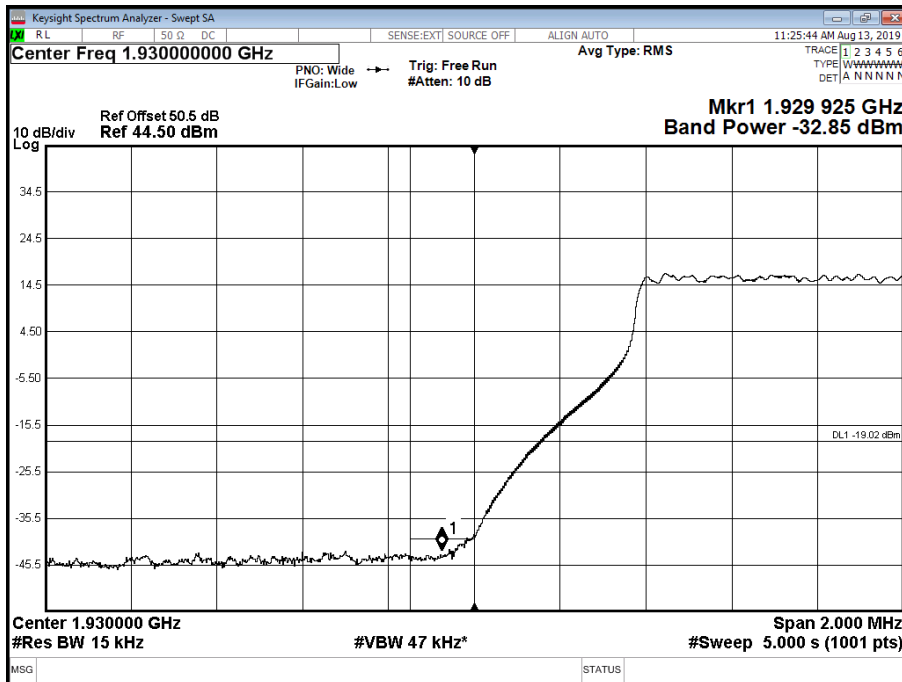

Antenna A - NR Modulation QPSK - NR Carrier Bandwidth 15.0 MHz 15 kHz SCS - Channel Position T

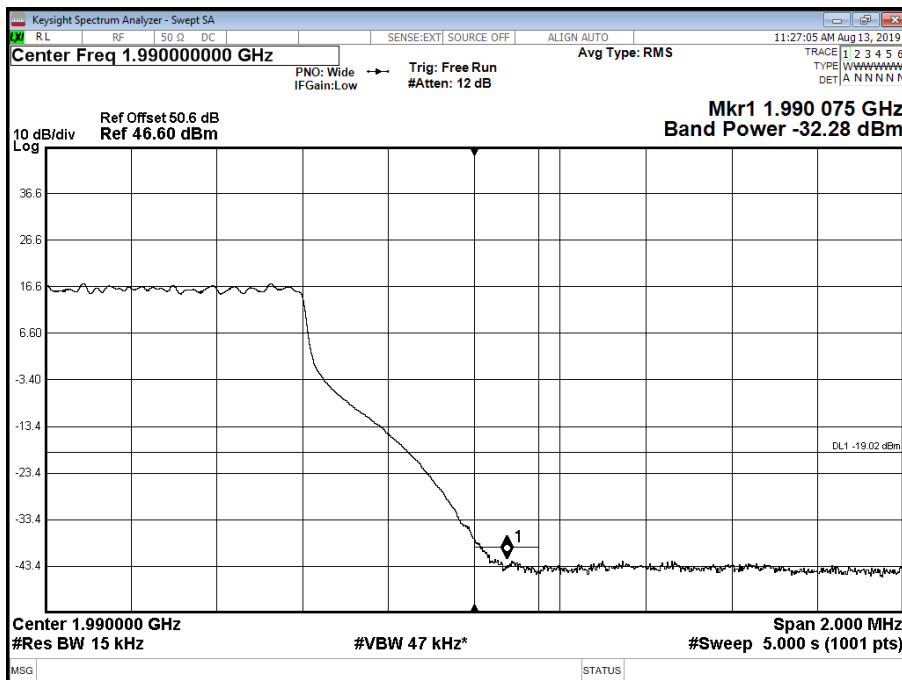



Antenna A - NR Modulation QPSK - NR Carrier Bandwidth 20.0 MHz 15 kHz SCS - Channel Position B

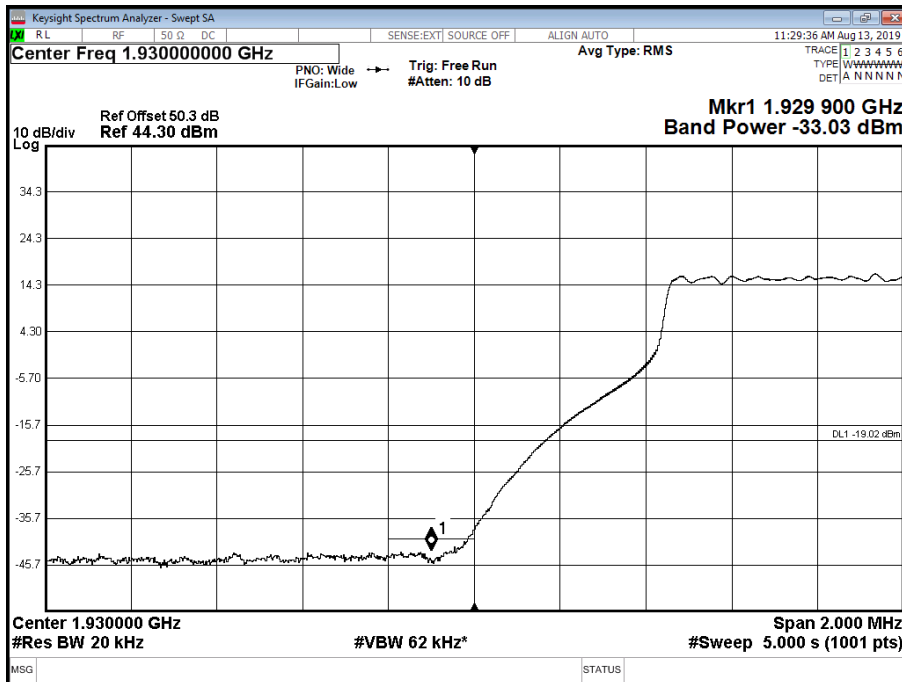

Antenna A - NR Modulation QPSK - NR Carrier Bandwidth 20.0 MHz 15 kHz SCS - Channel Position T

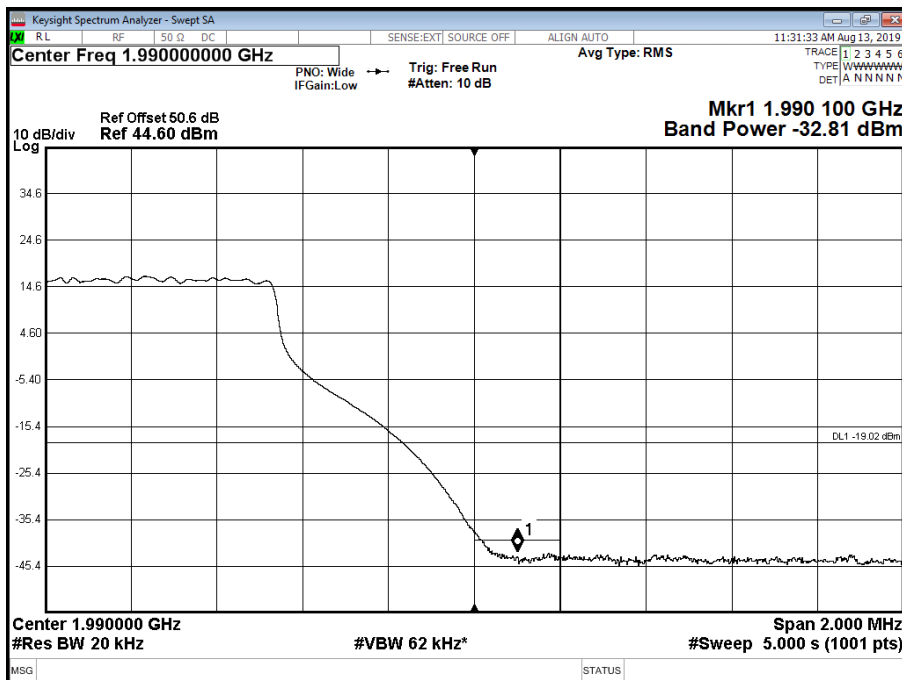



Antenna A - NR Modulation QPSK - NR Carrier Bandwidth 20.0 MHz 60 kHz SCS - Channel Position B

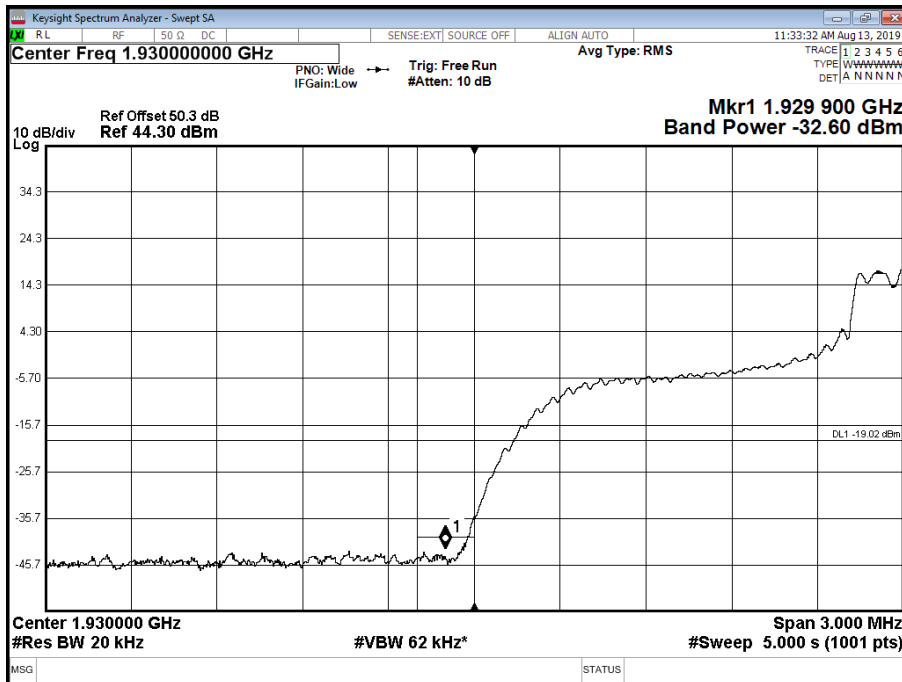

Antenna A - NR Modulation QPSK - NR Carrier Bandwidth 20.0 MHz 60 kHz SCS - Channel Position T

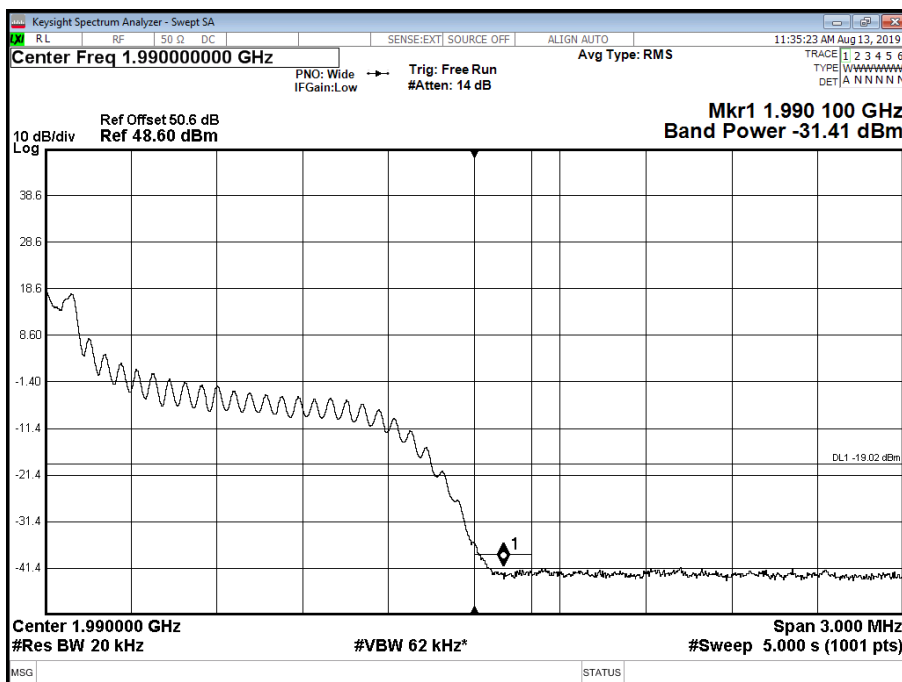



Configuration B

Maximum Output Power 46 dBm

Antenna	NR Modulation	NR Carrier Bandwidth	Band Edge (MHz)	
			Channel Position B	Channel Position T
A	QPSK	5.0 MHz 15 kHz SCS	1,932.5	1,992.5
A	QPSK	10.0 MHz 15 kHz SCS	1,935.0	1,990.0
A	QPSK	15.0 MHz 15 kHz SCS	1,937.5	1,987.5
A	QPSK	20.0 MHz 15 kHz SCS	1,940.0	1,985.0
A	QPSK	20.0 MHz 60 kHz SCS	1,940.0	1,985.0

Antenna A - NR Modulation QPSK - NR Carrier Bandwidth 5.0 MHz 15 kHz SCS - Channel Position B

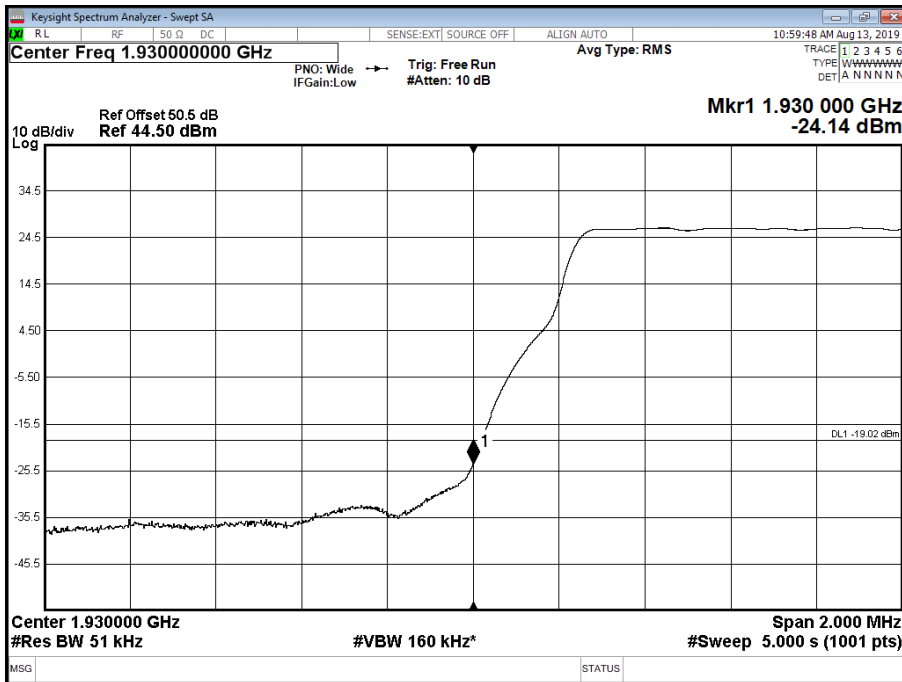



Antenna A - NR Modulation QPSK - NR Carrier Bandwidth 5.0 MHz 15 kHz SCS - Channel Position T

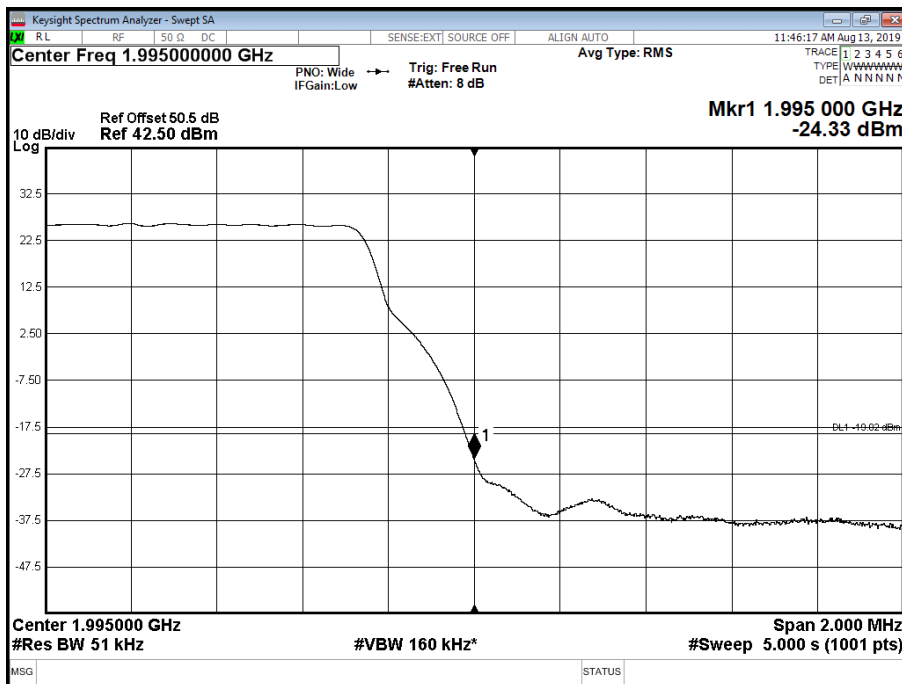

Antenna A - NR Modulation QPSK - NR Carrier Bandwidth 10.0 MHz 15 kHz SCS - Channel Position B

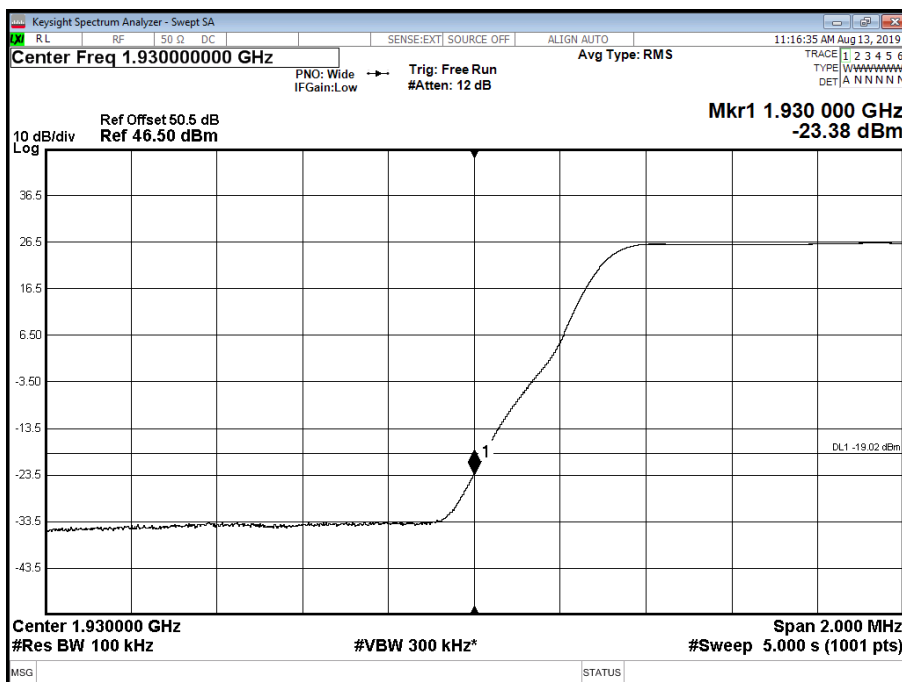



Antenna A - NR Modulation QPSK - NR Carrier Bandwidth 10.0 MHz 15 kHz SCS - Channel Position T

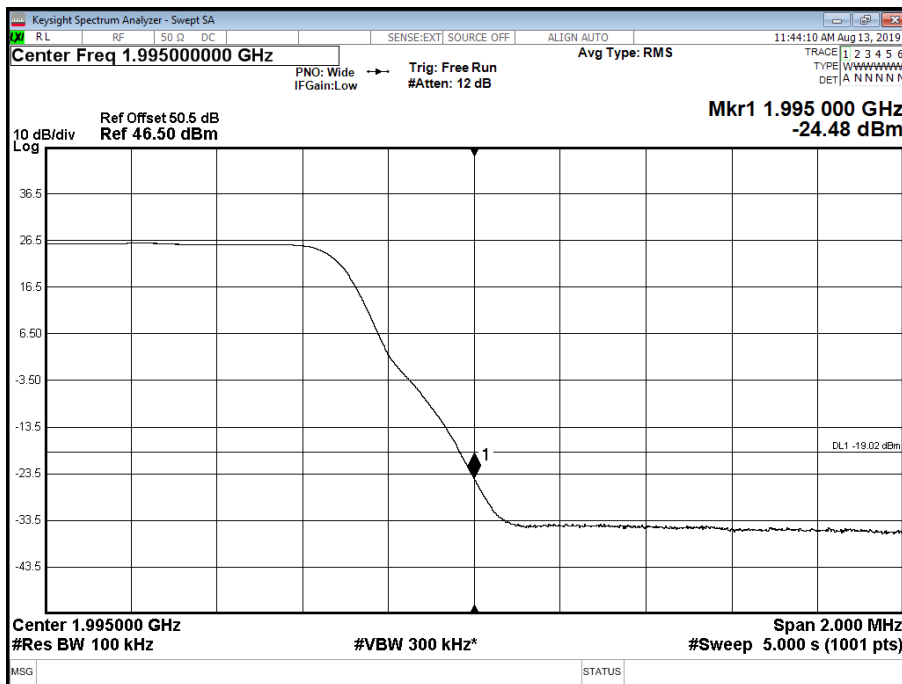

Antenna A - NR Modulation QPSK - NR Carrier Bandwidth 15.0 MHz 15 kHz SCS - Channel Position B

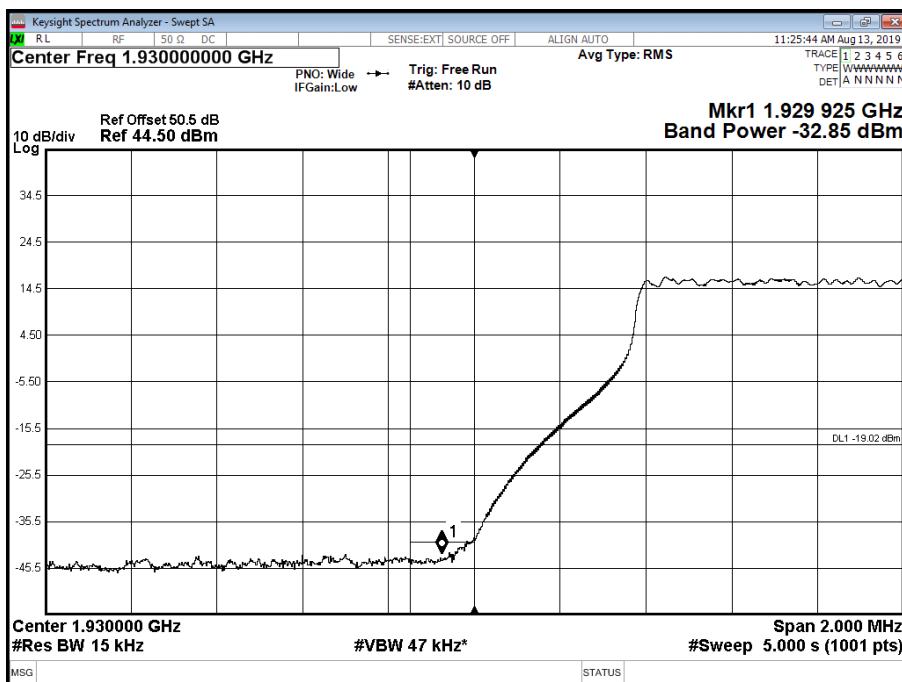



Antenna A - NR Modulation QPSK - NR Carrier Bandwidth 15.0 MHz 15 kHz SCS - Channel Position T

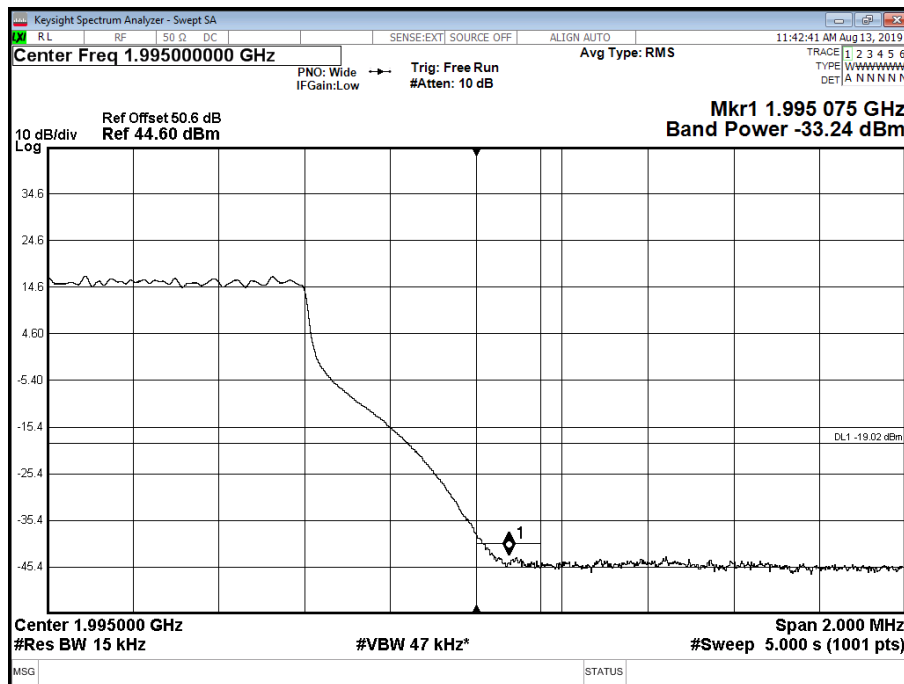

Antenna A - NR Modulation QPSK - NR Carrier Bandwidth 20.0 MHz 15 kHz SCS - Channel Position B

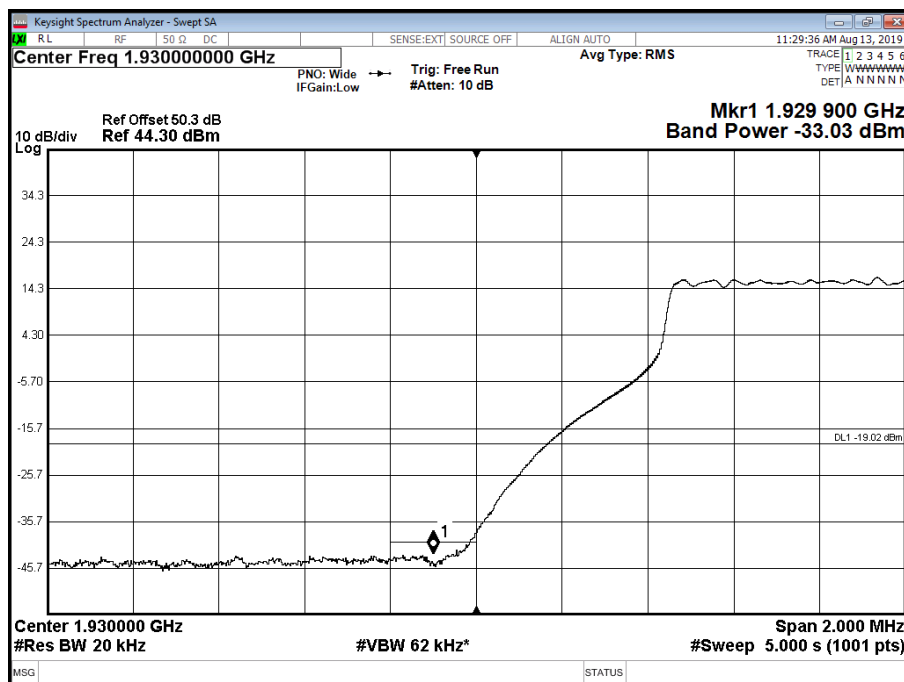



Antenna A - NR Modulation QPSK - NR Carrier Bandwidth 20.0 MHz 15 kHz SCS - Channel Position T

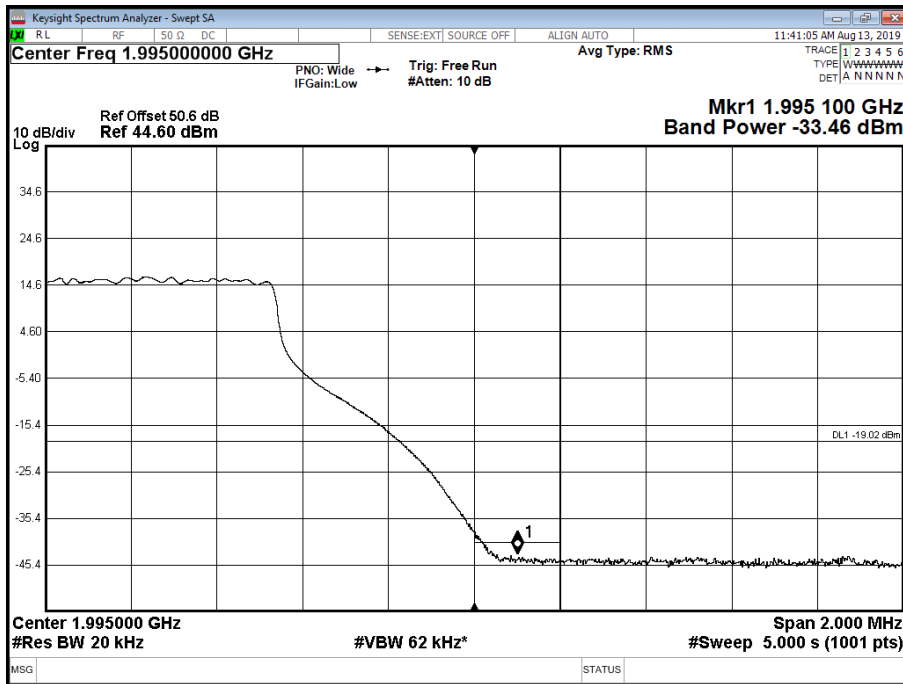

Antenna A - NR Modulation QPSK - NR Carrier Bandwidth 20.0 MHz 60 kHz SCS - Channel Position B

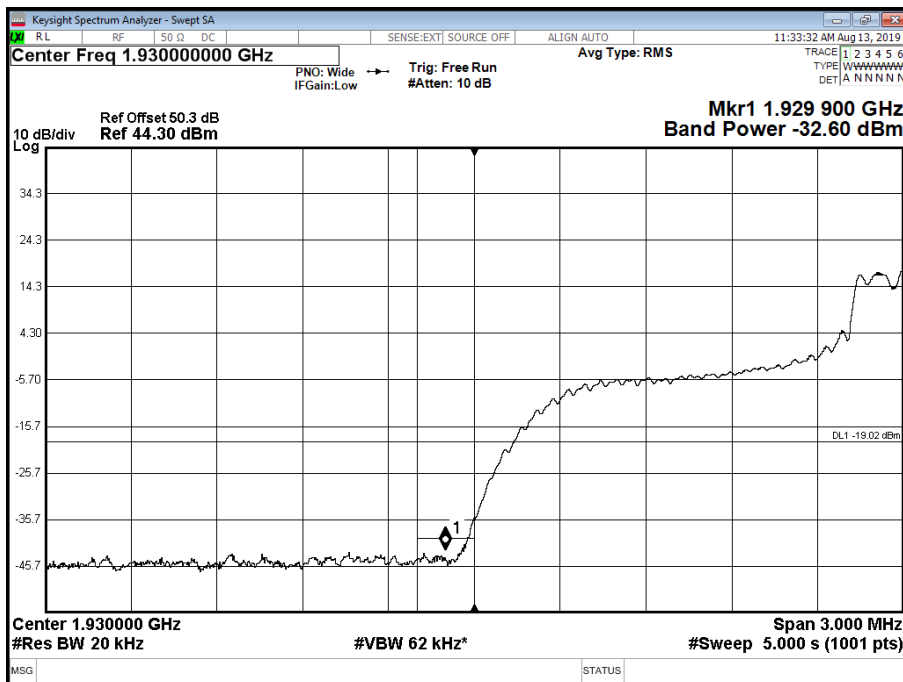



Antenna A - NR Modulation QPSK - NR Carrier Bandwidth 20.0 MHz 60 kHz SCS - Channel Position T

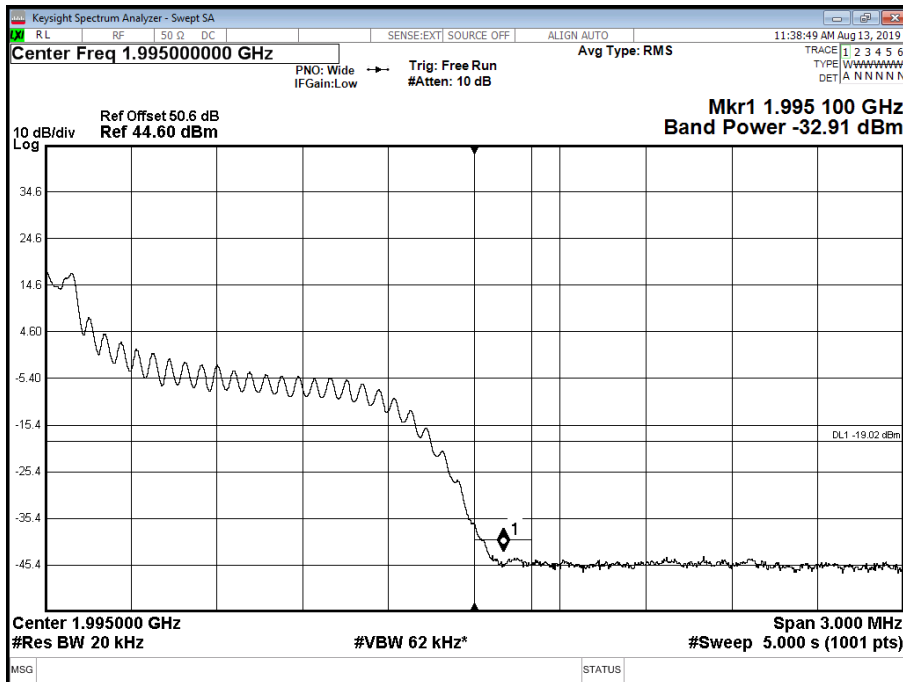

Limit	-19 dBm
-------	---------



2.4 TRANSMITTER SPURIOUS EMISSIONS

2.4.1 Specification Reference

FCC CFR 47 Part 2, Clause 2.1051
FCC CFR 47 Part 24, Clause 24.238 (a)
Industry Canada RSS-133, Clause 6.5

2.4.2 Date of Test and Modification State

13 August 2019 - Modification State 0

2.4.3 Test Equipment Used

The major items of test equipment used for the above tests are identified in Section 3.1.

2.4.4 Environmental Conditions

Ambient Temperature	24.2°C
Relative Humidity	47.9%

2.4.5 Test Method

All measurements were made in accordance with FCC KDB 971168 D01.

Each antenna port has been declared as being equivalent, therefore measurements were made on one antenna port only. To account for this, the limit was tightened by $10 * \text{Log}(N)$, where N is equal to the number of MIMO antenna ports.

For single Port, the limit was calculated as being $-13 \text{ dBm} - 10 * \text{Log}(1) = -13 \text{ dBm}$.

For four Ports, the limit was calculated as being $-13 \text{ dBm} - 10 * \text{Log}(2) = -19 \text{ dBm}$.

2.4.6 Test Results

Configuration A

Maximum Output Power 46 dBm



Antenna A - NR Modulation QPSK - NR Carrier Bandwidth 5.0 MHz 15 kHz SCS - Channel Position B - Band 1 - Range 0.009 to 3500 MHz

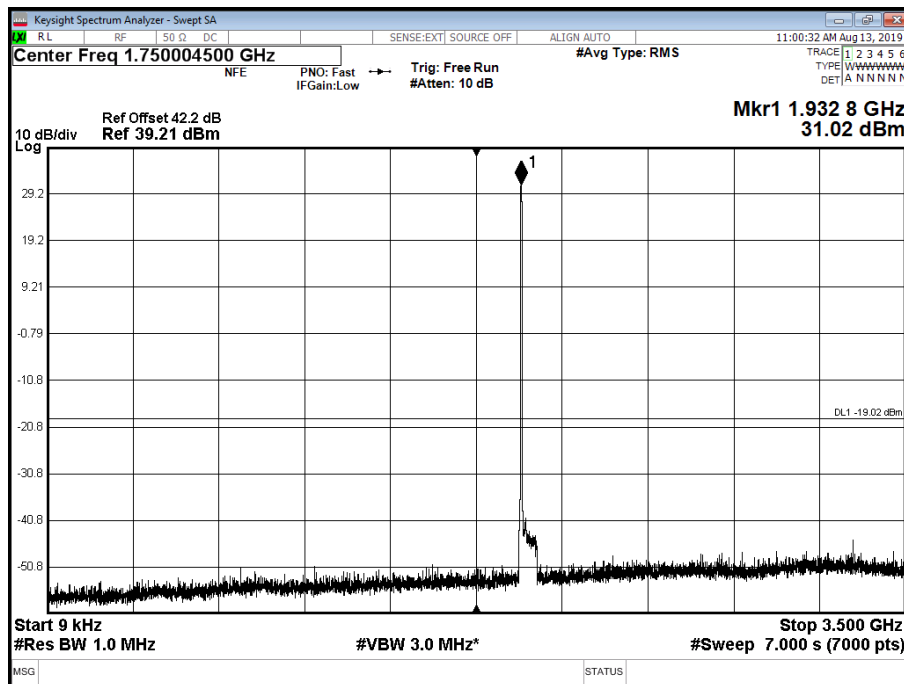

Antenna A - NR Modulation QPSK - NR Carrier Bandwidth 5.0 MHz 15 kHz SCS - Channel Position B - Band 2 - Range 3500 to 12000 MHz

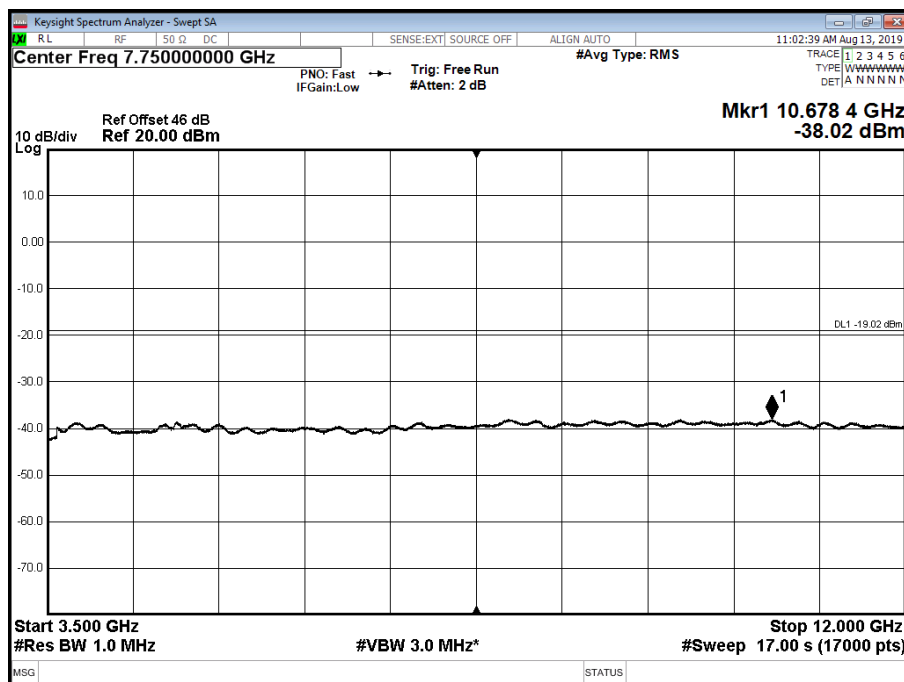



Antenna A - NR Modulation QPSK - NR Carrier Bandwidth 5.0 MHz 15 kHz SCS - Channel Position B - Band 3 - Range 12000 to 18000 MHz

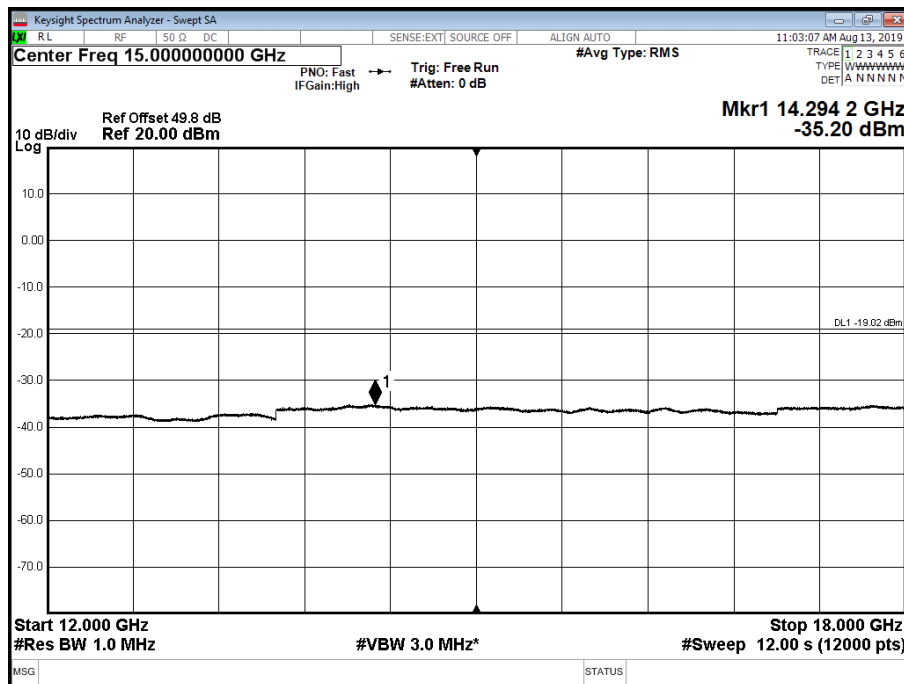

Antenna A - NR Modulation QPSK - NR Carrier Bandwidth 5.0 MHz 15 kHz SCS - Channel Position B - Band 4 - Range 18000 to 20000 MHz

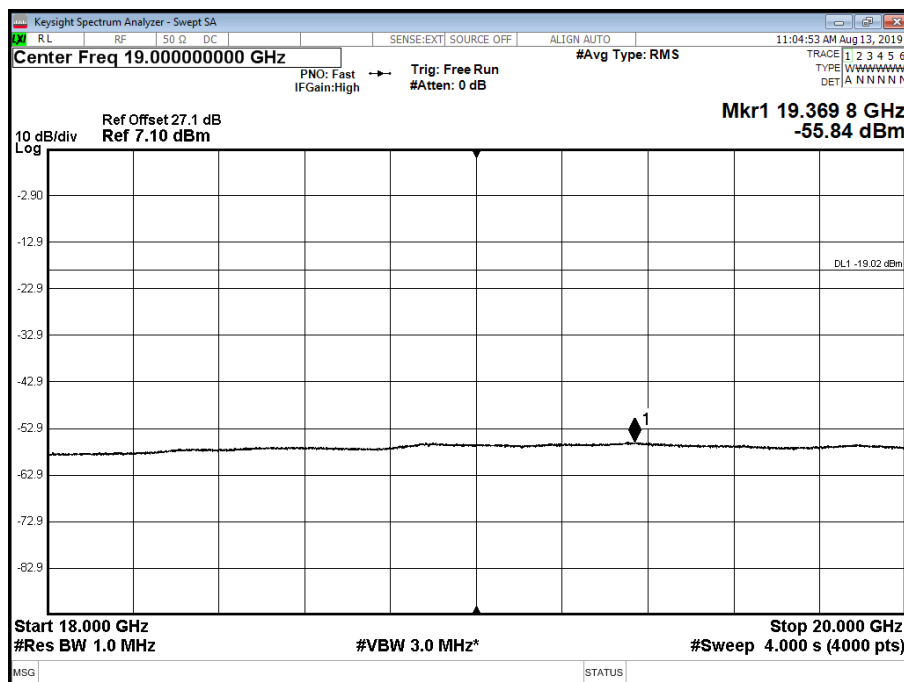



Antenna A - NR Modulation QPSK - NR Carrier Bandwidth 5.0 MHz 15 kHz SCS - Channel Position T - Band 1 - Range 0.009 to 3500 MHz

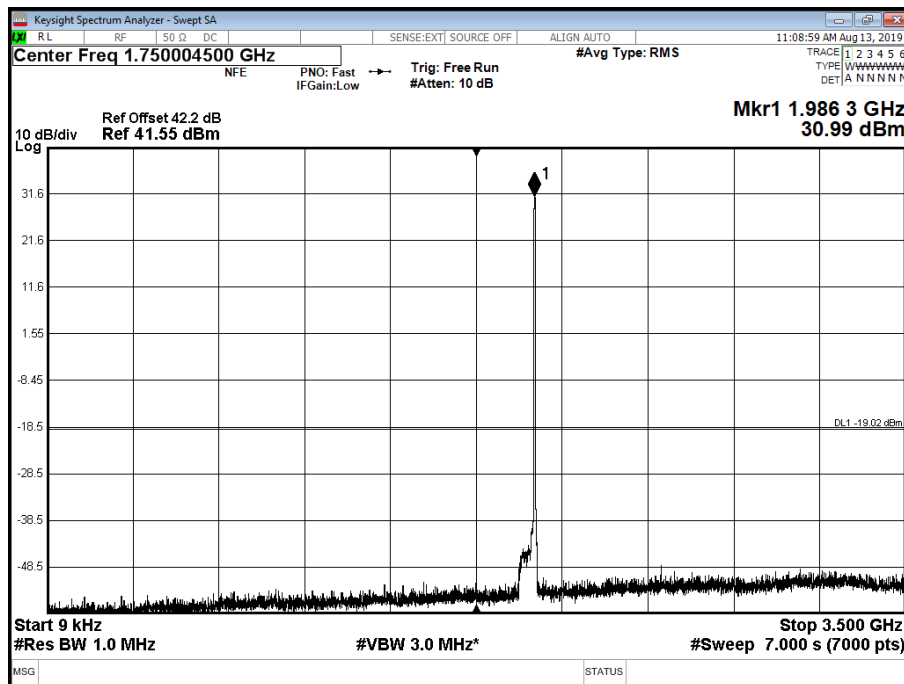

Antenna A - NR Modulation QPSK - NR Carrier Bandwidth 5.0 MHz 15 kHz SCS - Channel Position T - Band 2 - Range 3500 to 12000 MHz

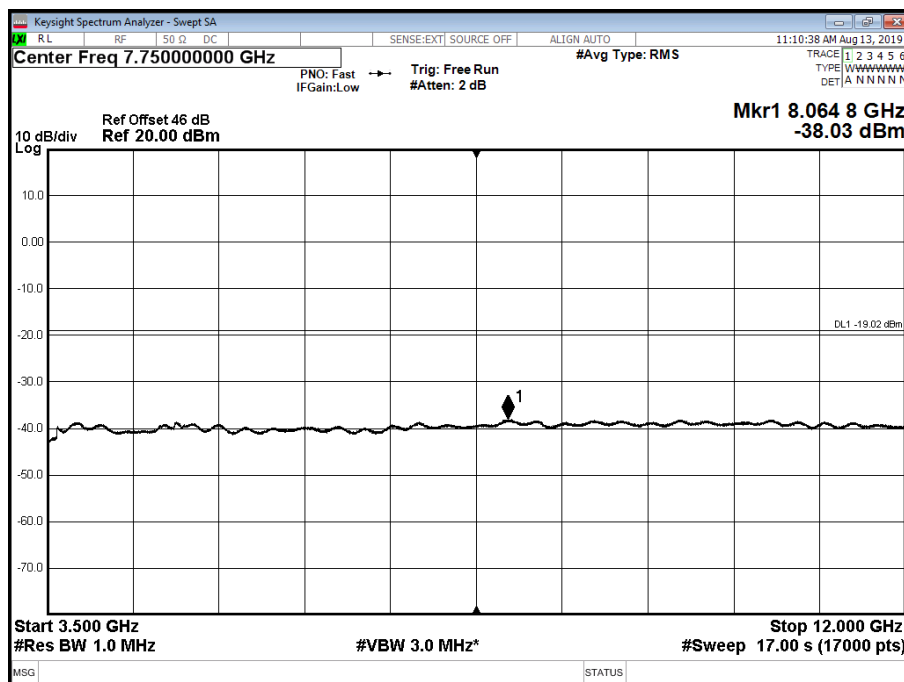



Antenna A - NR Modulation QPSK - NR Carrier Bandwidth 5.0 MHz 15 kHz SCS - Channel Position T - Band 3 - Range 12000 to 18000 MHz

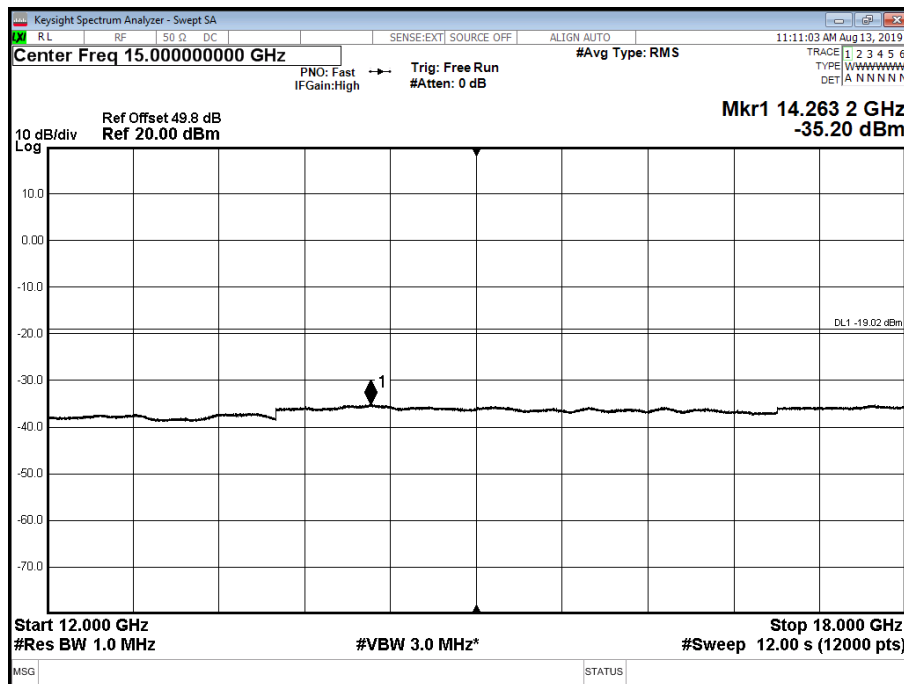

Antenna A - NR Modulation QPSK - NR Carrier Bandwidth 5.0 MHz 15 kHz SCS - Channel Position T - Band 4 - Range 18000 to 20000 MHz

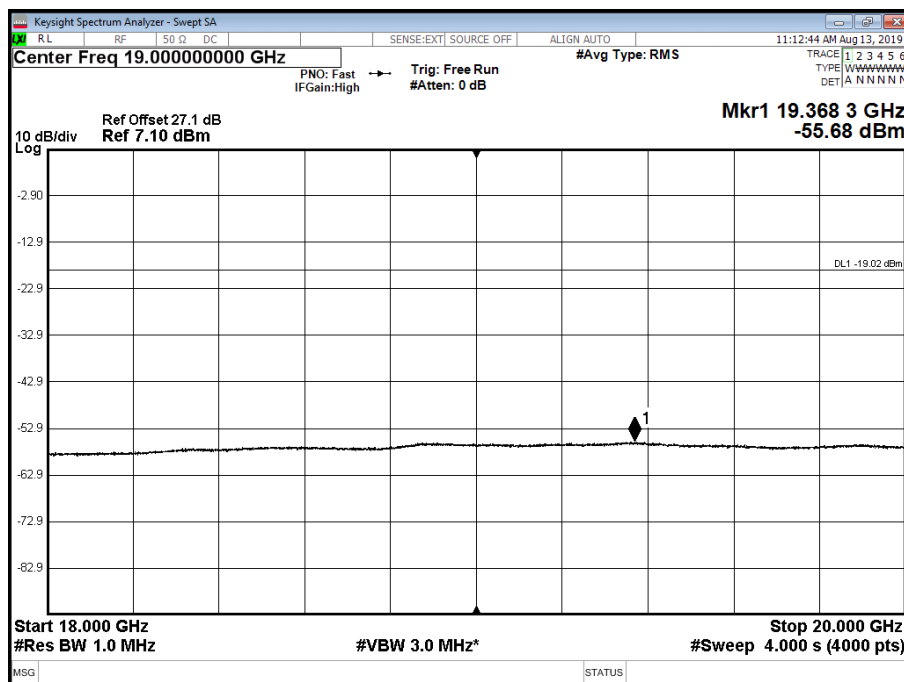



Configuration B

Maximum Output Power 46 dBm

Antenna A - NR Modulation QPSK - NR Carrier Bandwidth 5.0 MHz 15 kHz SCS - Channel Position B - Band 1 - Range 0.009 to 3500 MHz

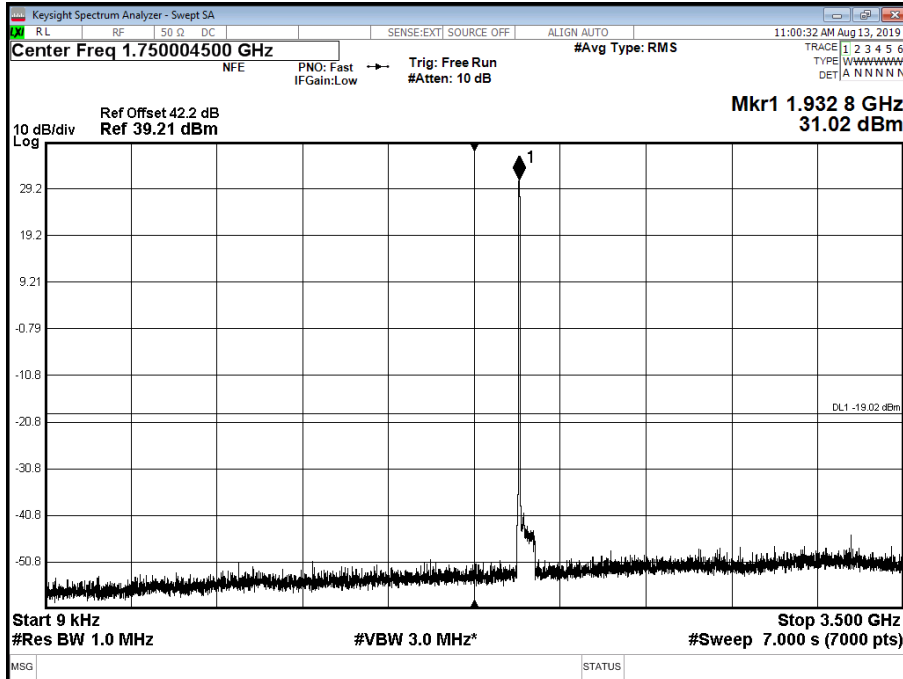



Antenna A - NR Modulation QPSK - NR Carrier Bandwidth 5.0 MHz 15 kHz SCS - Channel Position B - Band 2 - Range 3500 to 12000 MHz

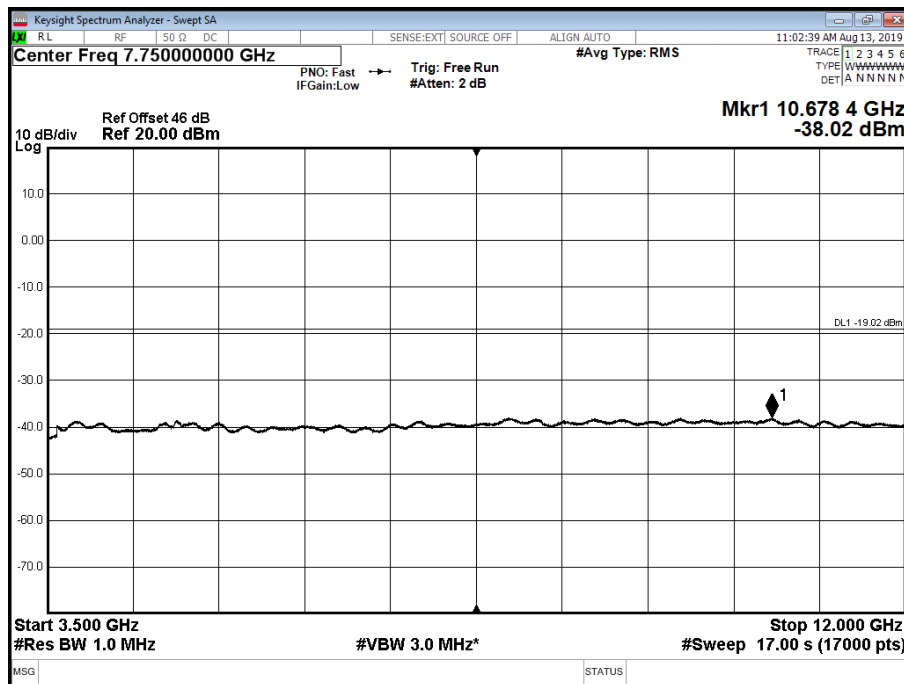

Antenna A - NR Modulation QPSK - NR Carrier Bandwidth 5.0 MHz 15 kHz SCS - Channel Position B - Band 3 - Range 12000 to 18000 MHz

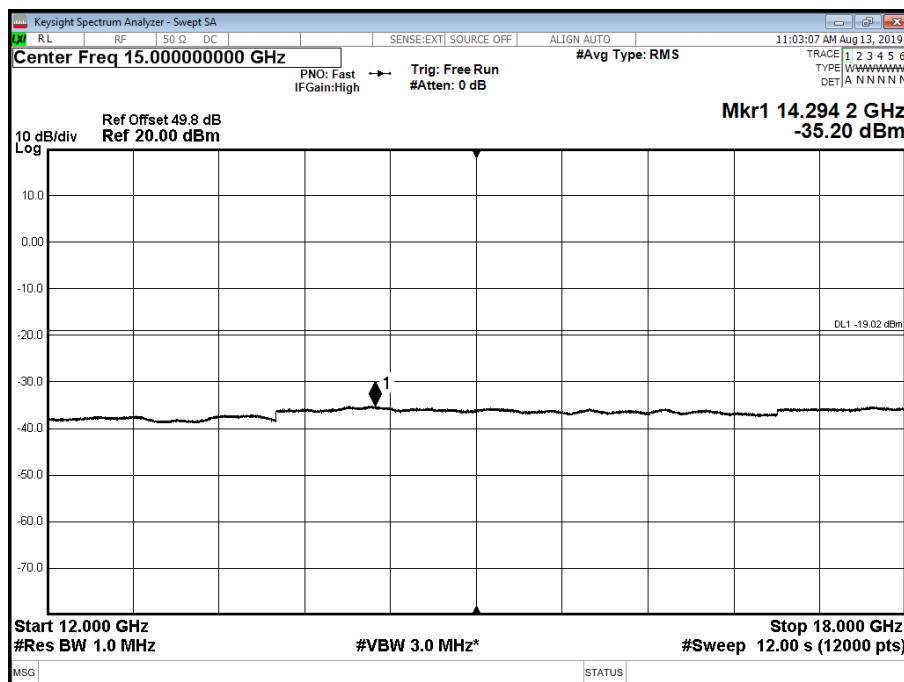



Antenna A - NR Modulation QPSK - NR Carrier Bandwidth 5.0 MHz 15 kHz SCS - Channel Position B - Band 4 - Range 18000 to 20000 MHz

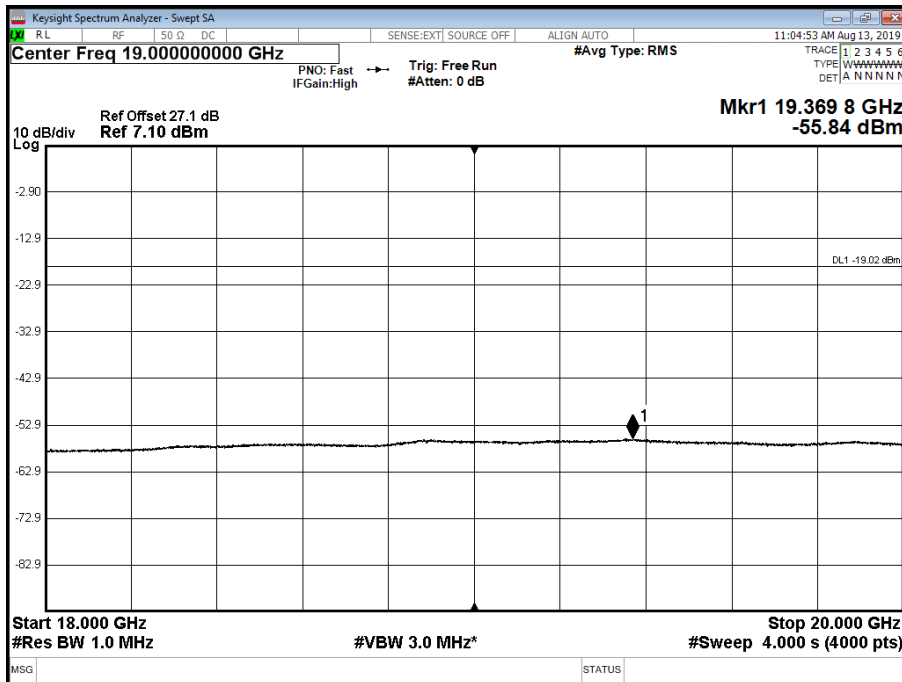

Antenna A - NR Modulation QPSK - NR Carrier Bandwidth 5.0 MHz 15 kHz SCS - Channel Position T - Band 1 - Range 0.009 to 3500 MHz

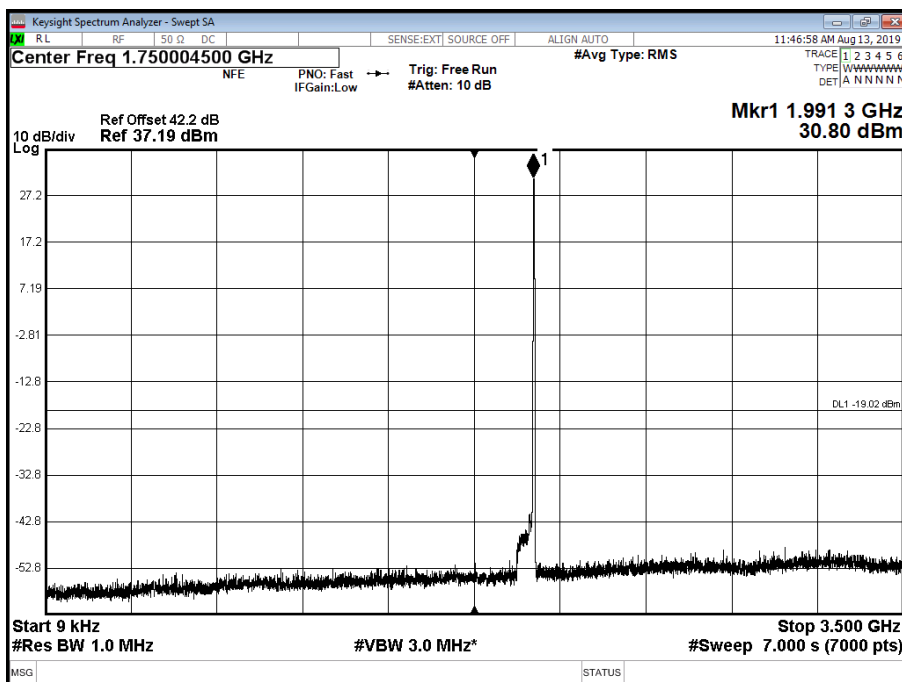



Antenna A - NR Modulation QPSK - NR Carrier Bandwidth 5.0 MHz 15 kHz SCS - Channel Position T - Band 2 - Range 3500 to 12000 MHz

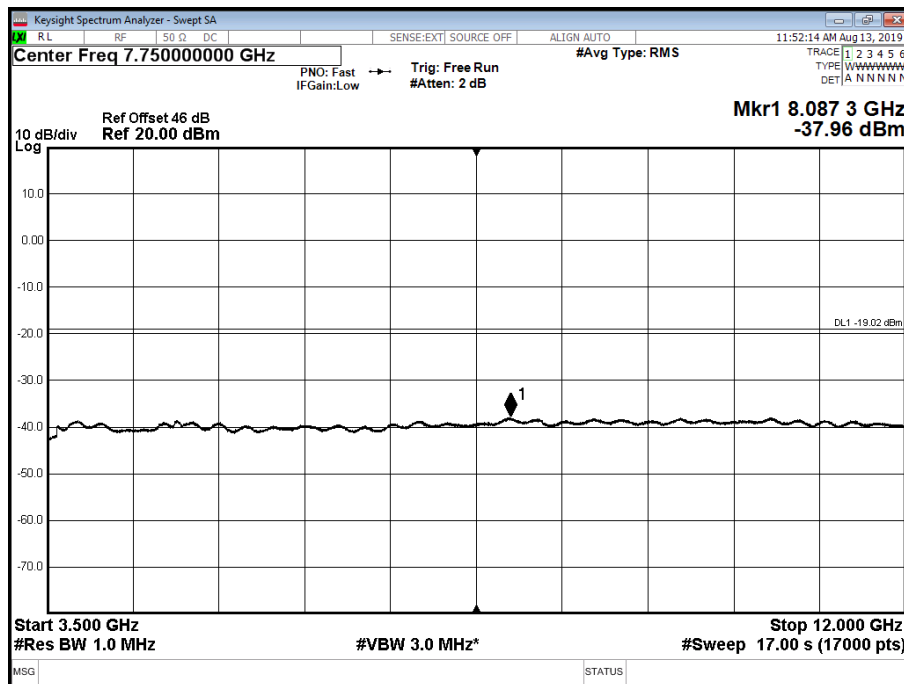

Antenna A - NR Modulation QPSK - NR Carrier Bandwidth 5.0 MHz 15 kHz SCS - Channel Position T - Band 3 - Range 12000 to 18000 MHz

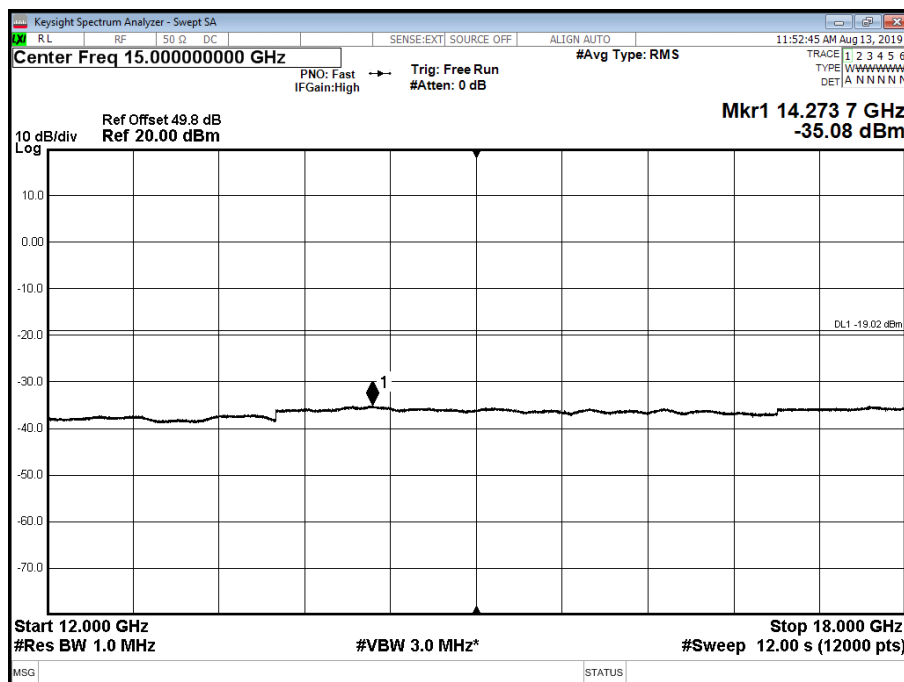



Antenna A - NR Modulation QPSK - NR Carrier Bandwidth 5.0 MHz 15 kHz SCS - Channel
 Position T - Band 4 - Range 18000 to 20000 MHz

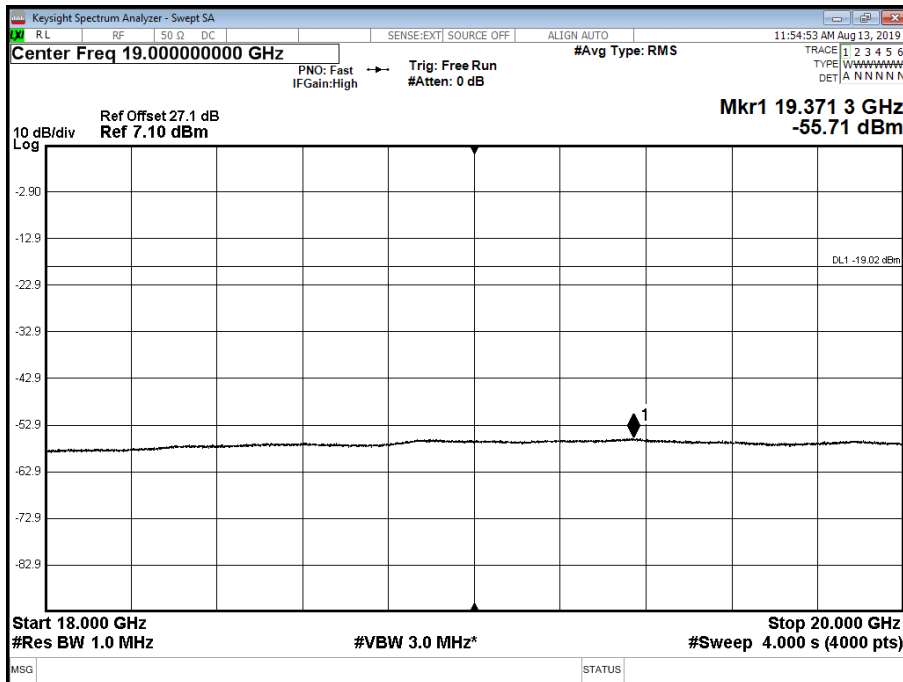

Limit	-19dBm
-------	--------



SECTION 3

TEST EQUIPMENT USED



3.1 TEST EQUIPMENT USED

List of absolute measuring and other principal items of test equipment.

Instrument	Manufacturer	Type No.	TE No.	Calibration Period (months)	Calibration Due
Maximum Peak Output Power and Peak to Average Ratio - Conducted					
Hygrometer	Rotronic	A1	2138	12	05-Mar-2020
Signal Analyser	N9030A	Keysight	4654	12	08-Oct-2019
PSU	ITECH	IT7324	5225	-	O/P Mon
DMM	ISOTECH	TDM101	2424	12	12-Dec-2019
Attenuator	Weinschel	48-40-43 LIM	5134	12	07-Nov-2019
Attenuator	Weinschel	48-10-43	4867	12	06-Nov-2019
Cable	Rosenberger	LU7-071-1000	5099	-	O/P Mon
Cable	Rosenberger	LU7-036-2000	5039	-	O/P Mon
Time and Frequency Synchronisation	Spectracom	SecureSync 1200-0408-0601	4393	6	15-Oct-2019
Rubidium Standard	R&S	XSRM	1316	6	15-Oct-2019
Network Analyser	Keysight	E5063A	5018	12	20-May-2020
Calibration unit	Keysight	85093C	5188	12	21-May-2020
Occupied Bandwidth					
Hygrometer	Rotronic	A1	2138	12	05-Mar-2020
Signal Analyser	N9030A	Keysight	4654	12	08-Oct-2019
PSU	ITECH	IT7324	5225	-	O/P Mon
DMM	ISOTECH	TDM101	2424	12	12-Dec-2019
Attenuator	Weinschel	48-40-43 LIM	5134	12	07-Nov-2019
Attenuator	Weinschel	48-10-43	4867	12	06-Nov-2019
Cable	Rosenberger	LU7-071-1000	5099	-	O/P Mon
Cable	Rosenberger	LU7-036-2000	5039	-	O/P Mon
Time and Frequency Synchronisation	Spectracom	SecureSync 1200-0408-0601	4393	6	15-Oct-2019
Rubidium Standard	R&S	XSRM	1316	6	15-Oct-2019
Network Analyser	Keysight	E5063A	5018	12	20-May-2020
Calibration unit	Keysight	85093C	5188	12	21-May-2020
Band Edge					
Hygrometer	Rotronic	A1	2138	12	05-Mar-2020
Signal Analyser	N9030A	Keysight	4654	12	08-Oct-2019
PSU	ITECH	IT7324	5225	-	O/P Mon
DMM	ISOTECH	TDM101	2424	12	12-Dec-2019
Attenuator	Weinschel	48-40-43 LIM	5134	12	07-Nov-2019
Attenuator	Weinschel	48-10-43	4867	12	06-Nov-2019
Cable	Rosenberger	LU7-071-1000	5099	-	O/P Mon
Cable	Rosenberger	LU7-036-2000	5039	-	O/P Mon
Time and Frequency Synchronisation	Spectracom	SecureSync 1200-0408-0601	4393	6	15-Oct-2019
Rubidium Standard	R&S	XSRM	1316	6	15-Oct-2019
Network Analyser	Keysight	E5063A	5018	12	20-May-2020
Calibration unit	Keysight	85093C	5188	12	21-May-2020



Instrument	Manufacturer	Type No.	TE No.	Calibration Period (months)	Calibration Due
Transmitter Spurious Emissions					
Hygrometer	Rotronic	A1	2138	12	05-Mar-2020
Signal Analyser	N9030A	Keysight	4654	12	08-Oct-2019
PSU	ITECH	IT7324	5225	-	O/P Mon
DMM	ISOTECH	TDM101	2424	12	12-Dec-2019
Attenuator	Weinschel	48-40-43 LIM	5134	12	07-Nov-2019
Attenuator	Weinschel	48-10-43	4867	12	06-Nov-2019
Cable	Rosenberger	LU7-071-1000	5099	-	O/P Mon
Cable	Rosenberger	LU7-036-2000	5039	-	O/P Mon
Time and Frequency Synchronisation	Spectracom	SecureSync 1200-0408-0601	4393	6	15-Oct-2019
Rubidium Standard	R&S	XSRM	1316	6	15-Oct-2019
Network Analyser	R&S	ZVA 40	3548	12	17-Oct-2019
Calibration unit	R&S	ZV Z53	4368	12	21-Oct-2019
Network Analyser	Keysight	E5063A	5018	12	20-May-2020
Calibration unit	Keysight	85093C	5188	12	21-May-2020
HPF	Wainwright	WHKX12-2580-3000-18000-80SS	5220	12	15-Feb-2020
Cable	Aralab	CSF6767C-C2S6500	5175	-	O/P Mon
Cable	Rosenberger	LU1-001-1000	5022	-	O/P Mon
Cable	IW Microwave	KPS-1501-394	5214	12	11-Jun-2020
Cable	Rosenberger	LU1-001-2000	5020	-	O/P Mon
Waveguide	FMI UK	18-25 GHz	-	-	O/P Mon

N/A – Not Applicable

O/P Mon – Output Monitored with Calibrated Equipment



3.2 MEASUREMENT UNCERTAINTY

For a 95% confidence level, the measurement uncertainties for defined systems are:-

Test Discipline	Frequency / Parameter	MU	
Conducted Maximum Peak Output Power	30 MHz to 20 GHz Amplitude	± 0.7 dB	
Conducted Emissions	30 MHz to 20 GHz Amplitude	± 2.6 dB	
Occupied Bandwidth	Up to 20 MHz Bandwidth	5 MHz Bandwidth	± 11547 Hz
		10 MHz Bandwidth	± 23094 Hz
		15 MHz Bandwidth	± 34641 Hz
		20 MHz Bandwidth	± 46188 Hz
Band Edge	30 MHz to 20 GHz Amplitude	±0.8 dB	



SECTION 4

ACCREDITATION, DISCLAIMERS AND COPYRIGHT



4.1 ACCREDITATION, DISCLAIMERS AND COPYRIGHT



This report relates only to the actual item/items tested.

Our UKAS Accreditation does not cover opinions and interpretations and any expressed are outside the scope of our UKAS Accreditation.

Results of tests not covered by our UKAS Accreditation Schedule are marked NUA (Not UKAS Accredited).

© 2019 TÜV SÜD



ANNEX A

MODULE LIST



Configuration A and B			
Product	Product No	R-State	Serial No
Radio 4415 B2 B25	KRC 161 636/3	R5C	D828110337
Software Version:	CXP9013268/15	Revision:	R80BL