



No.I21Z60784-WMD01



TEST REPORT

No.I21Z60784-WMD01

for

Ericsson AB Remote Radio Unit

AIR 6488 B41

FCC ID: TA8CKRD901108

In accordance with FCC CFR 47 Part 27

Issued Date: 2021-06-17

Note:

The test results in this test report relate only to the devices specified in this report. This report shall not be reproduced except in full without the written approval of CTTL.

The report must not be used by the client to claim product certification, approval, or endorsement by NVLAP, NIST, or any agency of the U.S.Government.

Test Laboratory:

CTTL, Telecommunication Technology Labs, CAICT

No. 52, Huayuan North Road, Haidian District, Beijing, P. R. China 100191.

Tel: +86(0)10-62304633-2512, Fax: +86(0)10-62304633-2504

Email: ctl_terminals@caict.ac.cn, website: www.caict.ac.cn



REPORT HISTORY

Report Number	Revision	Description	Issue Date
I21Z60784-WMD01	Rev.0	1 st edition	2021-06-17

Note: the latest revision of the test report supersedes all previous version.

CONTENTS

1. TEST LABORATORY	4
1.1. INTRODUCTION & ACCREDITATION.....	4
1.2. TESTING LOCATION	4
1.3. PROJECT DATE	5
1.4. SIGNATURE.....	5
2. CLIENT INFORMATION.....	6
2.1. APPLICANT INFORMATION	6
2.2. MANUFACTURER INFORMATION	6
3. EQUIPMENT UNDER TEST (EUT).....	7
3.1. ABOUT EUT	7
3.2. GENERAL DESCRIPTION	8
3.3. CONFIGURATION DESCRIPTION	9
4. REFERENCE DOCUMENTS	10
4.1. REFERENCE DOCUMENTS FOR TESTING	10
5. TEST SETUP	11
6. LABORATORY ENVIRONMENT	12
7. SUMMARY OF TEST RESULTS	13
8. TEST EQUIPMENT UTILIZED	14
9. MEASUREMENT UNCERTAINTY	14
ANNEX A: MEASUREMENT RESULTS.....	15
A.1 MAXIMUM OUTPUT POWER AND PEAK TO AVERAGE POWER RATIO - EIRP CALCULATION	15
A.2 OCCUPIED BANDWIDTH	23
A.3 SPURIOUS EMISSIONS AT BAND EDGE	27
A.4 CONDUCTED SPURIOUS EMISSION.....	33
A.5 FREQUENCY STABILITY	44
ANNEX B: ACCREDITATION CERTIFICATE.....	46



1. Test Laboratory

1.1. Introduction & Accreditation

Telecommunication Technology Labs, CAICT is an ISO/IEC 17025:2005 accredited test laboratory under NATIONAL VOLUNTARY LABORATORY ACCREDITATION PROGRAM (NVLAP) with lab code 600118-0, and is also an FCC accredited test laboratory (CN5017), and ISED accredited test laboratory (ISED#: 24849). The detail accreditation scope can be found on NVLAP website.

1.2. Testing Location

Location 1: CTTL(huayuan North Road)

Address: No. 52, Huayuan North Road, Haidian District, Beijing,
P. R. China 100191

1.3. Project date

Testing Start Date: 2021-06-01

Testing End Date: 2021-06-10

1.4. Signature

Dong Yuan**(Prepared this test report)**

Zhou Yu**(Reviewed this test report)**

Zhao Hui Lin**(Approved this test report)**



2. Client Information

2.1. Applicant Information

Company Name: Ericsson (China) Communications Company Ltd.
Address /Post: Ericsson Tower, No.5 Lize East Street, Chaoyang District, Beijing
100102, P.R.China
Contact: Shuang Qi
Email: Shuang.qi@ericsson.com
Telephone: +86 13911788711

2.2. Manufacturer Information

Company Name: Ericsson AB
Address /Post: Isafjordsgatan 10, 164 80 Stockholm
Sweden
Contact: /
Email: /
Telephone: /

3. Equipment Under Test (EUT)

3.1. About EUT

Description	Remote Radio Unit
Product Name	AIR 6488 B41
Product Number	KRD 901 108/2, KRD 901 108/21, KRD 901 108/1, KRD 901 108/11 (note)
FCC ID	TA8CKRD901108
Antenna	YES
Antenna Gain	23dBi
Output power	Maximum 34.95 dBm (3.125 W) per port for all modes. Maximum 17.96 dBm/MHz (0.0625 W/MHz) per port for all modes.
Power source	-48V DC
Serial Number	D828782502
Hardware Version	R1E
Software Version	UP: CXP2010174/1_R20A171, PIS: CXP2020171%5_R57A257
Frequency range	RX: 2496MHz-2690MHz, TX: 2496MHz-2690MHz (LTE, NR)
Number of Antenna ports	64TX /64 RX
Maximum RF bandwidth (IBW)	100MHz
Maximum Number of supported carriers per port	3 carriers (LTE up to 2 carriers, NR 1 carrier)
Supported modulations	LTE: QPSK, 16QAM, 64QAM and 256QAM NR: QPSK, 16QAM, 64QAM and 256QAM
Supported Channel bandwidth	LTE: 10 MHz, 20MHz NR:70MHz
Date of receipt	2021-06-01

Note: The differences between the 4 variants are as below, and others are same.

KRD 901 108/2 with un-security software and RDNB board for testing purpose

KRD 901 108/21 with security software and RDNB board for testing purpose

KRD 901 108/1 with un-security software and antenna

KRD 901 108/11 with security software and antenna



3.2. General Description

The Equipment Under Test (EUT) AIR 6488 B41 is an Ericsson Radio Unit working in the public mobile service 2496-2690 MHz band which provides communication connections to 2496-2690 MHz network. The AIR 6488 B41 operates from a -48V DC supply.

The EUT includes 64 TX/RX ports. It can operate in NR single RAT and LTE+NR mix mode. It can be configured to transmit in MIMO mode which was used for measurements as the worst configuration. The complete testing was performed with the EUT transmitting at maximum RF power unless otherwise stated.

A full technical description can be found in the Manufacturer's documentation.

3.3. Configuration Description

The following settings were used to represent all traffic scenarios. The output power was measured on the bottom, middle and top channel of all applicable antenna ports. By measuring the output power of QPSK, 16QAM, 64QAM and 256QAM for NR on one of the antenna ports, it was determined that 16QAM was the worst case modulation scheme and was used for all testing.

Complete testing was carried out on the worst case antenna port which was established as being the highest output power from the applicable measured ports on worst case modulation scheme. This antenna port was Port 10 for NR single RAT and LTE+NR mix mode.

The settings below were used for all measurements unless otherwise noted:

NR

Configuration	Carrier	Carrier Bandwidth	Carrier Frequency Configuration (MHz)		
			Bottom	Middle	Top
NR-MIMO-1C	1NR	70MHz	2531.01	2593.02	2655.00

LTE+NR

Configuration	Carrier	Carrier Bandwidth	Carrier Frequency Configuration (MHz)		
			Bottom	Middle	Top
LTE+NR-MIMO-MC-1	1L+1NR	10MHz+70MHz	(NR)2531.01+(L)2591	(NR)2578.02+(L)2638	(NR)2625+(L)2685
	1L+1NR	20MHz+70MHz	(NR)2531.01+(L)2586	(NR)2578.02+(L)2633	(NR)2625+(L)2680
LTE+NR-MIMO-MC-BE-1	1L+1NR	10MHz+70MHz	(L)2501+(NR)2541	N/A	(NR)2645.01+(L)2685
	1L+1NR	20MHz+70MHz	(L)2506+(NR)2551.02	N/A	(NR)2635.02+(L)2680

N/A – Not Applicable

4. Reference Documents

4.1. Reference Documents for testing

The following documents listed in this section are referred for testing.

Reference	Title	Version
FCC Part 27	MISCELLANEOUS WIRELESS COMMUNICATIONS SERVICES	10-1-19 Edition
FCC Part 2	FREQUENCY ALLOCATIONS AND RADIO TREATY MATTERS; GENERAL RULES AND REGULATIONS	10-1-19 Edition
ANSI 63.26	American National Standard for Compliance Testing of Transmitters Used in Licensed Radio Services	2015
ANSI/TIA-603-E	Land Mobile FM or PM Communications Equipment Measurement and Performance Standards	2016
KDB 971168 D01	MEASUREMENT GUIDANCE FOR CERTIFICATION OF LICENSED DIGITAL TRANSMITTERS	v03r01
KDB 662911 D01	Emissions Testing of Transmitters with Multiple Outputs in the Same Band	v02r01

5. TEST SETUP

Test Setup, Conducted Measurement:

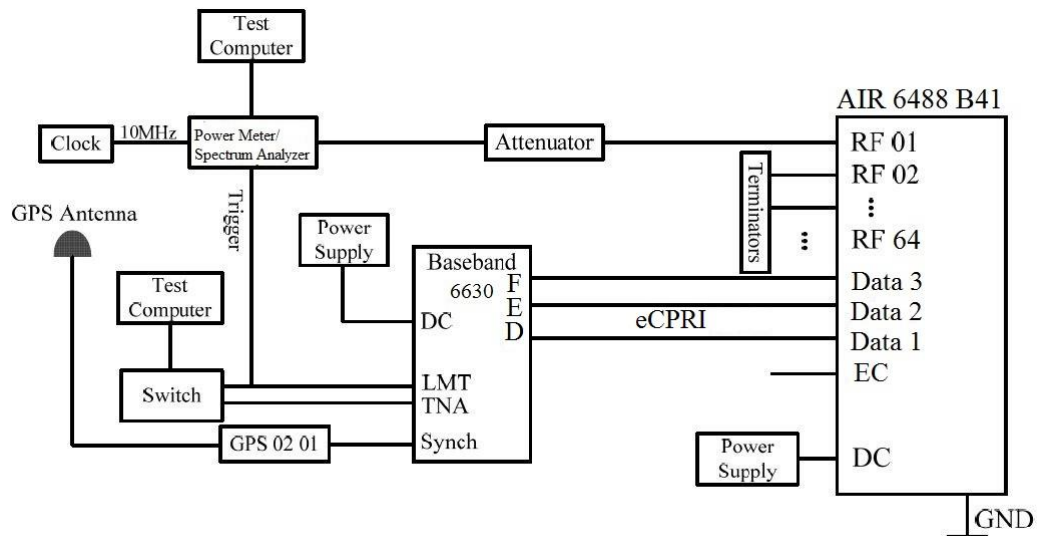

No.	Auxiliary Equipment	Model Type	Version
1	Test Computer	HP EliteBook 8540w	-
2	Baseband 6630	KDU 137 848/1	R2C
3	Power supply unit	PCR2000M	-
4	Terminator	SHX 6G	-
5	Attenuator	Aeroflex / Weinschel	-

Test Setup, Radiated Measurement:

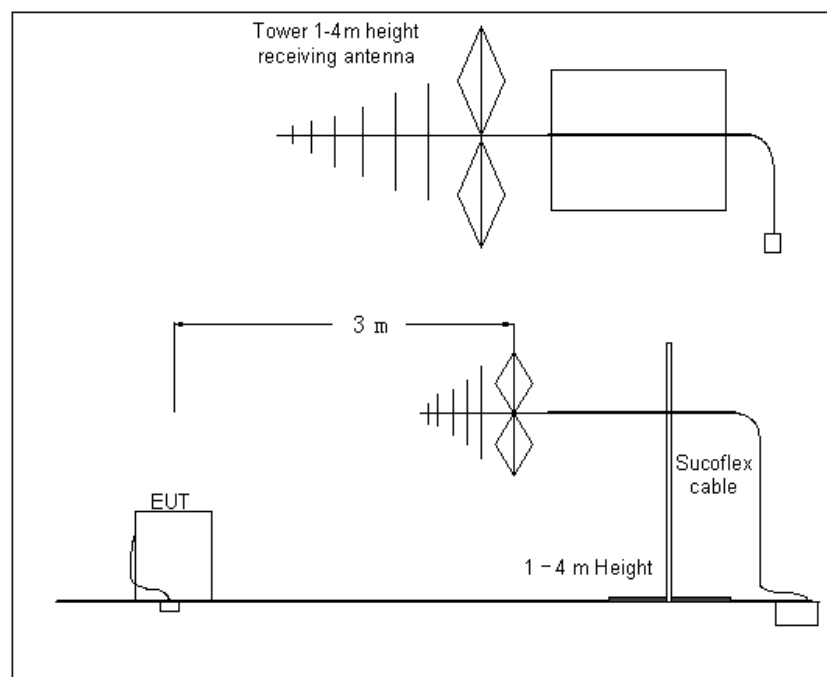

6. LABORATORY ENVIRONMENT

Control room / conducted chamber did not exceed following limits along the EMC testing:

Temperature	Min. = 15 °C, Max. = 35 °C
Relative humidity	Min. =20 %, Max. = 80 %
Shielding effectiveness	> 110 dB
Electrical insulation	>2 M Ω
Ground system resistance	< 0.5 Ω

Semi-anechoic chamber(10 meters×6.7 meters×6.15 meters) did not exceed following limits along the EMC testing:

Temperature	Min. = 15 °C, Max. = 30 °C
Relative humidity	Min. = 35 %, Max. = 60 %
Shielding effectiveness	> 100 dB
Electrical insulation	>2 M Ω
Ground system resistance	< 0.5 Ω
Normalised site attenuation (NSA)	< \pm 3.5 dB, 3 m distance
Site voltage standing-wave ratio (S_{VSWR})	Between 0 and 6 dB, from 1GHz to 18GHz
Uniformity of field strength	Between 0 and 6 dB, from 80 to 3000 MHz

7. SUMMARY OF TEST RESULTS

Items	Test Name	Clause in FCC rules	Verdict
1	Maximum Output Power and Peak to Average Power Ratio - EIRP calculation	27.50(h), 2.1046	Pass
2	Occupied Bandwidth	27.53(m), 2.1049	Pass
3	Spurious Emissions at Band Edge	27.53(m), 2.1051	Pass
4	Conducted Spurious Emission	27.53(m), 2.1051	Pass
5	Radiated Spurious Emission	27.53(m), 2.1053	NT
6	Frequency Stability	27.54, 2.1055	Pass

NT - Not tested in this configuration. Passed in an equivalently tested configuration shown in Document: I19Z61573-WMD01, I18Z62307-WMD02 and I20Z60290-WMD01.

8. Test Equipment Utilized

NO.	Description	TYPE	series number	MANUFACTURE	CAL DUE DATE
1	AC Power Supply	PCR2000M	PJ000583	Kikusui	2022-05-12
2	40dB Attenuator	66-40-33	CD4019	Aeroflex / Weinschel	-
3	40dB Attenuator	TSG150R-4-40N11	1511040001	Nanjing Jiexi Technologies	-
4	Spectrum Analyzer	N9030	MY57142378	Keysight	2022-03-01
5	Spectrum Analyzer	FSW	104038-dC	Rohde-schwarz	2021-06-30
6	Climate Chamber	GPS-4	0010-003512	Espec	2021-08-02

9. MEASUREMENT UNCERTAINTY

For a 95% confidence level, the measurement uncertainties for defined systems are:

Test Discipline	Measurement Uncertainty
Conducted Maximum Peak Output Power	0.5dB
Occupied Bandwidth	1.1Hz
Conducted Spurious Emissions	2.3dB
Band Edge	2.3dB
Radiated Spurious Emissions	5.4dB
Frequency Stability	$<\pm 1 \times 10^{-7}$

ANNEX A: MEASUREMENT RESULTS

A.1 Maximum Output Power and Peak to Average Power Ratio - EIRP calculation

A.1.1 Reference

FCC CFR 47 Part 2, Clause 2.1046

FCC CFR 47 Part 27, Clause 27.50(h)

A.1.2 Method of Measurements

During the process of testing, the EUT was configured to transmit on maximum power and proper modulation. The transmitter power shall be measured in terms of a root-mean-square (RMS) average value. In case of the EUT was configured to MIMO mode, since the EUT transmits on all antennas simultaneously in the same frequency range, using the Measure-and-Sum approach, the output power at all antennas were tested, and the total output power were then summed mathematically in linear power units according to FCC KDB 662911 D01.

A peak to average ratio measurement is performed at the conducted ports of the EUT for single carrier for single RAT mode. The spectrum analyzers Complementary Cumulative Distribution Function (CCDF) was used and 0.1% probability value recorded.

Two polarizations are generated for the beam, 32 ports are used to create each polarization. The antenna gain for each polarization is declared as 23 dBi, therefore the EIRP for each polarization is calculated as the sum of the power over 32 ports plus the antenna gain. This calculation is applied for each polarization and then each polarization EIRP is summed to calculate the overall EIRP.

A.1.3 Limit

Output Power:

$$\text{EIRP} \leq 33 \text{ dBW} + 10\log(X/Y) \text{ dBW} + 10 \log(360/\text{Beamwidth}) \text{ dBW} = 83 \text{ dBm}$$

X = 20MHz channel bandwidth

Y = 5.5 or 6 MHz

Beamwidth = 12°

Peak to Average Ratio: ≤ 13 dB

A.1.4 Measurement result

Configuration NR-MIMO-1C 70.0M

Maximum Output Power 34.95dBm per port for NR Channel Bandwidth 70MHz

Port	Modulation/ Carrier Bandwidth (MHz)	Output Power / Peak to Average Ratio (PAR)								
		Channel position B			Channel position M			Channel position T		
		POWER (dBm)	POWER (dBm/MHz)	PAR (db)	POWER (dBm)	POWER (dBm/MHz)	PAR (db)	POWER (dBm)	POWER (dBm/MHz)	PAR (db)
1	16QAM/70.0	34.84	19.13	7.69	34.85	19.11	7.25	34.91	19.10	7.66
2	16QAM/70.0	34.88	19.08	7.63	34.86	18.91	7.27	34.85	18.97	7.62
3	16QAM/70.0	34.88	19.06	7.71	34.89	18.86	7.26	34.92	19.15	7.65
4	16QAM/70.0	34.97	19.21	7.65	34.99	19.00	7.25	34.87	18.99	7.63
5	16QAM/70.0	34.75	19.02	7.69	34.73	18.77	7.27	34.71	18.95	7.68
6	16QAM/70.0	34.73	18.96	7.68	34.74	18.72	7.25	34.66	18.83	7.69
7	16QAM/70.0	34.68	18.94	7.66	34.63	18.78	7.26	34.68	18.88	7.67
8	16QAM/70.0	34.92	19.12	7.68	34.84	18.82	7.27	34.84	19.09	7.66
9	16QAM/70.0	34.96	19.30	7.68	34.95	18.95	7.26	34.91	19.31	7.71
10	16QAM/70.0	34.72	18.91	7.64	34.68	18.70	7.27	35.09	19.36	7.69
11	16QAM/70.0	34.85	19.13	7.65	34.81	18.87	7.26	34.85	19.02	7.69
12	16QAM/70.0	34.87	19.18	7.66	34.82	18.94	7.27	34.89	19.20	7.66
13	16QAM/70.0	34.78	19.11	7.71	34.79	18.89	7.28	34.72	18.85	7.63
14	16QAM/70.0	34.87	19.10	7.73	34.76	18.81	7.26	34.74	18.92	7.62
15	16QAM/70.0	34.83	19.15	7.69	34.73	18.73	7.28	34.64	18.90	7.65
16	16QAM/70.0	34.80	19.06	7.72	34.71	18.70	7.26	34.79	19.08	7.68
17	16QAM/70.0	35.05	19.27	7.65	35.02	19.03	7.28	34.97	19.13	7.67
18	16QAM/70.0	35.01	19.25	7.64	34.95	19.10	7.25	34.86	19.11	7.66
19	16QAM/70.0	34.87	19.08	7.66	34.91	18.96	7.27	34.89	19.12	7.72
20	16QAM/70.0	34.92	19.12	7.67	34.82	18.92	7.27	34.78	19.07	7.69
21	16QAM/70.0	34.86	19.11	7.68	34.84	18.87	7.27	34.94	19.19	7.65
22	16QAM/70.0	34.77	19.07	7.63	34.75	18.89	7.28	34.71	18.92	7.67
23	16QAM/70.0	34.97	19.21	7.71	34.93	19.00	7.24	34.87	19.18	7.69
24	16QAM/70.0	34.88	19.25	7.67	34.82	18.89	7.25	34.78	18.99	7.66
25	16QAM/70.0	34.85	19.12	7.66	34.77	18.92	7.28	34.87	19.11	7.65
26	16QAM/70.0	34.96	19.23	7.71	34.94	19.14	7.27	34.91	19.13	7.68
27	16QAM/70.0	34.92	19.15	7.68	34.83	18.82	7.26	34.86	19.08	7.66
28	16QAM/70.0	34.90	19.12	7.67	34.81	18.85	7.26	34.87	19.13	7.69
29	16QAM/70.0	34.81	19.09	7.65	34.72	18.68	7.25	34.79	18.89	7.62
30	16QAM/70.0	34.74	19.14	7.67	34.68	18.71	7.26	34.76	18.92	7.72
31	16QAM/70.0	34.85	19.06	7.72	34.80	18.83	7.26	34.83	19.08	7.71
32	16QAM/70.0	34.85	19.09	7.69	34.71	18.75	7.27	34.85	19.04	7.72
Total Power 1-32		49.91	34.17	-	49.87	33.93	-	49.88	34.11	-
Total Power 1-32+23 dBi		72.91	57.17	-	72.87	56.93	-	72.88	57.11	-

Port	Modulation/ Carrier Bandwidth (MHz)	Output Power / Peak to Average Ratio (PAR)								
		Channel position B			Channel position M			Channel position T		
		POWER (dBm)	POWER (dBm/MHz)	PAR (db)	POWER (dBm)	POWER (dBm/MHz)	PAR (db)	POWER (dBm)	POWER (dBm/MHz)	PAR (db)
33	16QAM/70.0	34.93	19.22	7.67	34.86	18.96	7.27	34.90	19.03	7.67
34	16QAM/70.0	34.93	19.26	7.65	34.86	18.95	7.26	34.91	19.19	7.69
35	16QAM/70.0	34.99	19.28	7.61	34.87	18.92	7.26	34.77	18.98	7.63
36	16QAM/70.0	35.00	19.23	7.69	34.98	19.06	7.26	34.92	19.23	7.64
37	16QAM/70.0	34.93	19.30	7.67	34.90	18.96	7.27	34.85	19.11	7.65
38	16QAM/70.0	34.93	19.21	7.62	34.87	18.89	7.27	34.96	19.24	7.63
39	16QAM/70.0	34.73	18.91	7.63	34.65	18.88	7.27	34.74	18.96	7.73
40	16QAM/70.0	34.88	19.17	7.58	34.72	18.79	7.26	34.78	18.91	7.62
41	16QAM/70.0	34.95	19.18	7.67	34.94	18.94	7.27	34.94	19.16	7.72
42	16QAM/70.0	34.76	19.09	7.68	34.79	18.82	7.26	34.75	19.10	7.68
43	16QAM/70.0	35.03	19.20	7.68	34.94	19.00	7.26	34.94	19.31	7.68
44	16QAM/70.0	35.03	19.27	7.63	34.93	19.00	7.27	35.00	19.18	7.67
45	16QAM/70.0	34.68	18.89	7.66	34.66	18.70	7.27	34.70	18.96	7.65
46	16QAM/70.0	34.79	19.09	7.64	34.79	18.84	7.27	34.74	19.00	7.65
47	16QAM/70.0	34.72	19.17	7.70	34.74	18.78	7.25	34.62	18.90	7.67
48	16QAM/70.0	35.02	19.38	7.64	34.86	18.89	7.27	34.75	18.92	7.76
49	16QAM/70.0	34.88	19.08	7.63	34.83	18.85	7.27	34.87	19.11	7.70
50	16QAM/70.0	34.90	19.08	7.66	34.84	18.93	7.26	34.93	19.11	7.69
51	16QAM/70.0	34.93	19.23	7.68	34.84	18.92	7.27	34.81	19.08	7.71
52	16QAM/70.0	34.88	19.09	7.61	34.84	18.84	7.25	34.87	18.97	7.60
53	16QAM/70.0	34.67	18.88	7.65	34.63	18.64	7.26	34.76	18.88	7.63
54	16QAM/70.0	34.77	19.03	7.74	34.78	18.93	7.27	34.85	19.03	7.62
55	16QAM/70.0	34.77	19.06	7.65	34.80	18.83	7.26	34.73	18.93	7.70
56	16QAM/70.0	34.80	19.06	7.73	34.68	18.78	7.28	34.76	18.97	7.65
57	16QAM/70.0	34.94	19.24	7.63	34.74	18.81	7.29	34.80	18.91	7.65
58	16QAM/70.0	34.64	18.87	7.67	34.59	18.66	7.25	34.50	18.69	7.59
59	16QAM/70.0	34.98	19.14	7.65	34.94	18.97	7.25	34.98	19.15	7.73
60	16QAM/70.0	34.91	19.17	7.65	34.95	18.94	7.28	34.88	19.11	7.68
61	16QAM/70.0	34.89	19.15	7.61	34.83	18.92	7.26	34.90	19.21	7.60
62	16QAM/70.0	34.83	19.08	7.65	34.81	18.95	7.27	34.82	19.02	7.65
63	16QAM/70.0	34.85	19.08	7.60	34.86	18.84	7.27	34.76	18.97	7.63
64	16QAM/70.0	34.86	19.11	7.64	34.70	18.78	7.28	34.77	18.93	7.68
Total Power 33-64		49.92	34.18	-	49.87	33.93	-	49.87	34.09	-
Total Power 33-64+23 dBi		72.92	57.18	-	72.87	56.93	-	72.87	57.09	-
EIRP		75.93	60.19	-	75.88	59.94	-	75.89	60.11	-



Port	Modulation/ Carrier Bandwidth (MHz)	Output Power / Peak to Average Ratio (PAR)								
		Channel position B			Channel position M			Channel position T		
		POWER (dBm)	POWER (dBm/MHz)	PAR (db)	POWER (dBm)	POWER (dBm/MHz)	PAR (db)	POWER (dBm)	POWER (dBm/MHz)	PAR (db)
10	QPSK/70.0	34.72	17.45	7.70	34.70	16.92	7.37	34.99	17.35	7.72
10	64QAM/70.0	34.96	17.58	7.72	34.68	17.25	7.37	34.94	17.49	7.65
10	256QAM/70.0	35.00	17.53	7.73	34.69	17.16	7.37	34.89	17.57	7.61



Configuration LTE+NR-MIMO-MC-1 (1LTE 10M QPSK+1NR 70M 16QAM)

Maximum Output Power 34.95dBm per port

Port	LTE BW/ NR BW (MHz)	Output Power / Peak to Average Ratio (PAR)								
		Channel position B			Channel position M			Channel position T		
		POWER (dBm)	POWER (dBm/MHz)	PAR (db)	POWER (dBm)	POWER (dBm/MHz)	PAR (db)	POWER (dBm)	POWER (dBm/MHz)	PAR (db)
1	10.0/70.0	34.46	18.09	-	34.46	18.01	-	34.62	18.22	-
2	10.0/70.0	34.51	18.15	-	34.49	18.05	-	34.63	18.23	-
3	10.0/70.0	34.45	18.17	-	34.57	18.10	-	34.75	18.32	-
4	10.0/70.0	34.49	18.19	-	34.61	18.25	-	34.63	18.31	-
5	10.0/70.0	34.11	17.67	-	34.02	17.53	-	34.18	17.84	-
6	10.0/70.0	34.38	18.06	-	34.37	17.86	-	34.46	18.14	-
7	10.0/70.0	34.29	17.87	-	34.30	17.71	-	34.49	18.17	-
8	10.0/70.0	34.37	17.93	-	34.43	17.87	-	34.55	18.24	-
9	10.0/70.0	34.56	18.21	-	34.55	18.04	-	34.74	18.42	-
10	10.0/70.0	34.64	18.33	-	34.58	18.11	-	34.75	18.46	-
11	10.0/70.0	34.45	18.14	-	34.48	18.05	-	34.54	18.21	-
12	10.0/70.0	34.57	18.18	-	34.53	18.03	-	34.57	18.25	-
13	10.0/70.0	34.35	18.04	-	34.43	17.91	-	34.54	18.04	-
14	10.0/70.0	34.48	18.05	-	34.37	17.85	-	34.52	18.14	-
15	10.0/70.0	34.32	17.93	-	34.28	17.83	-	34.37	17.89	-
16	10.0/70.0	34.34	17.89	-	34.28	17.77	-	34.46	18.04	-
17	10.0/70.0	34.52	18.18	-	34.55	18.05	-	34.67	18.25	-
18	10.0/70.0	34.56	18.24	-	34.52	18.08	-	34.60	18.18	-
19	10.0/70.0	34.45	18.11	-	34.60	18.07	-	34.66	18.34	-
20	10.0/70.0	34.52	18.09	-	34.51	18.03	-	34.58	18.18	-
21	10.0/70.0	34.44	18.15	-	34.48	18.04	-	34.67	18.33	-
22	10.0/70.0	34.35	18.01	-	34.36	17.95	-	34.50	18.05	-
23	10.0/70.0	34.59	18.41	-	34.53	18.04	-	34.64	18.31	-
24	10.0/70.0	34.53	18.22	-	34.43	17.98	-	34.56	18.27	-
25	10.0/70.0	34.60	18.19	-	34.53	18.09	-	34.71	18.29	-
26	10.0/70.0	34.72	18.30	-	34.52	18.02	-	34.70	18.36	-
27	10.0/70.0	34.47	18.14	-	34.44	18.02	-	34.60	18.26	-
28	10.0/70.0	34.47	18.07	-	34.38	17.88	-	34.56	18.23	-
29	10.0/70.0	34.39	18.15	-	34.38	17.93	-	34.50	18.18	-
30	10.0/70.0	34.29	17.93	-	34.22	17.87	-	34.43	18.11	-
31	10.0/70.0	34.36	18.11	-	34.46	17.99	-	34.56	18.20	-
32	10.0/70.0	34.18	17.83	-	34.24	17.84	-	34.56	18.14	-
Total Power 1-32		49.50	33.15	-	49.49	33.02	-	49.63	33.26	-
Total Power 1-32+23 dBi		72.50	56.15	-	72.49	56.02	-	72.63	56.26	-

Port	LTE BW/ NR BW (MHz)	Output Power / Peak to Average Ratio (PAR)								
		Channel position B			Channel position M			Channel position T		
		POWER (dBm)	POWER (dBm/MHz)	PAR (db)	POWER (dBm)	POWER (dBm/MHz)	PAR (db)	POWER (dBm)	POWER (dBm/MHz)	PAR (db)
33	10.0/70.0	34.56	18.09	-	34.64	18.03	-	34.62	18.22	-
34	10.0/70.0	34.54	18.14	-	34.60	18.13	-	34.70	18.30	-
35	10.0/70.0	34.67	18.25	-	34.57	18.11	-	34.72	18.36	-
36	10.0/70.0	34.65	18.17	-	34.60	18.24	-	34.75	18.39	-
37	10.0/70.0	34.32	18.05	-	34.36	18.02	-	34.49	18.19	-
38	10.0/70.0	34.31	18.24	-	34.32	17.88	-	34.58	18.22	-
39	10.0/70.0	34.22	17.94	-	34.30	17.91	-	34.42	18.08	-
40	10.0/70.0	34.26	17.86	-	34.18	17.83	-	34.37	18.00	-
41	10.0/70.0	34.65	18.23	-	34.61	18.12	-	34.77	18.43	-
42	10.0/70.0	34.44	18.10	-	34.46	17.95	-	34.61	18.21	-
43	10.0/70.0	34.59	18.12	-	34.61	18.30	-	34.75	18.33	-
44	10.0/70.0	34.57	18.28	-	34.59	18.21	-	34.78	18.41	-
45	10.0/70.0	34.32	18.06	-	34.19	17.74	-	34.33	18.00	-
46	10.0/70.0	34.20	18.07	-	34.19	17.79	-	34.37	18.03	-
47	10.0/70.0	34.35	18.18	-	34.35	17.86	-	34.50	18.36	-
48	10.0/70.0	34.31	18.11	-	34.39	18.04	-	34.48	18.24	-
49	10.0/70.0	34.40	18.14	-	34.45	18.03	-	34.63	18.33	-
50	10.0/70.0	34.40	18.16	-	34.35	17.96	-	34.63	18.34	-
51	10.0/70.0	34.41	18.13	-	34.44	18.07	-	34.58	18.22	-
52	10.0/70.0	34.39	18.18	-	34.36	17.97	-	34.61	18.29	-
53	10.0/70.0	34.18	17.79	-	34.34	17.88	-	34.52	18.17	-
54	10.0/70.0	34.40	18.00	-	34.40	17.93	-	34.58	18.20	-
55	10.0/70.0	34.47	18.00	-	34.43	17.91	-	34.60	18.13	-
56	10.0/70.0	34.41	18.10	-	34.37	17.85	-	34.58	18.21	-
57	10.0/70.0	34.39	18.04	-	34.23	17.89	-	34.42	18.16	-
58	10.0/70.0	34.27	17.99	-	34.18	17.76	-	34.21	17.99	-
59	10.0/70.0	34.47	18.13	-	34.50	18.12	-	34.62	18.35	-
60	10.0/70.0	34.50	18.16	-	34.46	18.06	-	34.58	18.20	-
61	10.0/70.0	34.51	18.05	-	34.49	18.01	-	34.66	18.33	-
62	10.0/70.0	34.55	18.19	-	34.38	17.84	-	34.52	18.07	-
63	10.0/70.0	34.53	18.16	-	34.45	18.04	-	34.54	18.08	-
64	10.0/70.0	34.46	18.11	-	34.38	17.97	-	34.56	18.24	-
Total Power 33-64		49.98	33.15	-	49.47	33.04	-	49.62	33.27	-
Total Power 33-64+23 dBi		72.98	56.15	-	72.47	56.04	-	72.62	56.27	-
EIRP		75.76	59.16	-	75.49	59.04	-	75.64	59.28	-



No.I21Z60784-WMD01

Configuration LTE+NR-MIMO-MC-1 (1LTE 20M QPSK+1NR 70M 16QAM)

Maximum Output Power 34.95dBm per port

Port	LTE BW/ NR BW (MHz)	Output Power / Peak to Average Ratio (PAR)								
		Channel position B			Channel position M			Channel position T		
		POWER (dBm)	POWER (dBm/MHz)	PAR (db)	POWER (dBm)	POWER (dBm/MHz)	PAR (db)	POWER (dBm)	POWER (dBm/MHz)	PAR (db)
1	20.0/70.0	34.13	17.31	-	34.09	17.22	-	34.28	17.49	-
2	20.0/70.0	34.27	17.45	-	34.29	17.33	-	34.20	17.47	-
3	20.0/70.0	34.13	17.30	-	34.16	17.28	-	34.31	17.53	-
4	20.0/70.0	34.15	17.32	-	34.25	17.35	-	34.20	17.44	-
5	20.0/70.0	34.15	17.28	-	34.06	17.13	-	34.12	17.24	-
6	20.0/70.0	34.14	17.20	-	34.02	16.99	-	34.14	17.27	-
7	20.0/70.0	34.09	17.11	-	34.08	17.10	-	34.22	17.29	-
8	20.0/70.0	34.14	17.14	-	34.12	17.12	-	34.23	17.36	-
9	20.0/70.0	34.29	17.37	-	34.19	17.33	-	34.32	17.53	-
10	20.0/70.0	34.32	17.46	-	34.16	17.22	-	34.42	17.60	-
11	20.0/70.0	34.20	17.44	-	34.11	17.15	-	34.17	17.37	-
12	20.0/70.0	34.24	17.48	-	34.17	17.21	-	34.26	17.49	-
13	20.0/70.0	34.12	17.28	-	34.15	17.18	-	34.21	17.29	-
14	20.0/70.0	34.19	17.32	-	34.06	17.12	-	34.11	17.23	-
15	20.0/70.0	34.15	17.23	-	34.05	17.08	-	34.10	17.19	-
16	20.0/70.0	34.22	17.22	-	34.15	17.18	-	34.31	17.40	-
17	20.0/70.0	34.25	17.40	-	34.26	17.25	-	34.35	17.48	-
18	20.0/70.0	34.31	17.50	-	34.28	17.27	-	34.32	17.39	-
19	20.0/70.0	34.21	17.44	-	34.29	17.37	-	34.25	17.42	-
20	20.0/70.0	34.24	17.35	-	34.23	17.31	-	34.23	17.42	-
21	20.0/70.0	34.09	17.35	-	34.16	17.29	-	34.32	17.53	-
22	20.0/70.0	34.00	17.19	-	34.04	17.08	-	34.05	17.27	-
23	20.0/70.0	34.25	17.48	-	34.24	17.34	-	34.24	17.51	-
24	20.0/70.0	34.13	17.33	-	34.04	17.16	-	34.16	17.38	-
25	20.0/70.0	34.16	17.27	-	34.10	17.19	-	34.24	17.38	-
26	20.0/70.0	34.21	17.32	-	34.15	17.17	-	34.25	17.32	-
27	20.0/70.0	34.13	17.37	-	34.14	17.14	-	34.21	17.43	-
28	20.0/70.0	34.19	17.30	-	34.13	17.23	-	34.26	17.48	-
29	20.0/70.0	34.00	17.23	-	33.98	17.19	-	34.09	17.31	-
30	20.0/70.0	33.99	17.18	-	33.86	17.00	-	34.06	17.27	-
31	20.0/70.0	34.04	17.17	-	34.04	17.11	-	34.13	17.33	-
32	20.0/70.0	33.99	17.10	-	34.00	16.98	-	34.17	17.35	-
Total Power 1-32		49.21	32.36	-	49.18	32.24	-	49.27	32.44	-
Total Power 1-32+23 dBi		72.21	55.36	-	72.18	55.24	-	72.27	55.44	-

Port	LTE BW/ NR BW Bandwidth (MHz)	Output Power / Peak to Average Ratio (PAR)								
		Channel position B			Channel position M			Channel position T		
		POWER (dBm)	POWER (dBm/MHz)	PAR (db)	POWER (dBm)	POWER (dBm/MHz)	PAR (db)	POWER (dBm)	POWER (dBm/MHz)	PAR (db)
33	20.0/70.0	34.21	17.27	-	34.23	17.21	-	34.25	17.41	-
34	20.0/70.0	34.22	17.24	-	34.17	17.23	-	34.23	17.36	-
35	20.0/70.0	34.35	17.38	-	34.32	17.35	-	34.37	17.47	-
36	20.0/70.0	34.35	17.51	-	34.30	17.45	-	34.40	17.53	-
37	20.0/70.0	33.94	17.23	-	33.99	17.20	-	34.12	17.43	-
38	20.0/70.0	34.24	17.38	-	34.06	17.26	-	34.28	17.62	-
39	20.0/70.0	33.92	17.24	-	33.93	17.10	-	34.04	17.38	-
40	20.0/70.0	33.99	17.25	-	33.90	17.02	-	34.00	17.27	-
41	20.0/70.0	34.36	17.44	-	34.33	17.37	-	34.46	17.62	-
42	20.0/70.0	34.21	17.36	-	34.14	17.19	-	34.28	17.39	-
43	20.0/70.0	34.35	17.41	-	34.37	17.44	-	34.46	17.66	-
44	20.0/70.0	34.32	17.36	-	34.33	17.36	-	34.40	17.57	-
45	20.0/70.0	33.81	17.06	-	33.74	16.97	-	33.93	17.15	-
46	20.0/70.0	33.87	17.18	-	33.81	16.99	-	33.84	17.09	-
47	20.0/70.0	34.02	17.32	-	33.97	17.18	-	34.01	17.39	-
48	20.0/70.0	33.90	17.18	-	34.06	17.16	-	34.10	17.43	-
49	20.0/70.0	33.97	17.20	-	33.94	17.12	-	34.16	17.46	-
50	20.0/70.0	34.01	17.25	-	34.01	17.17	-	34.22	17.57	-
51	20.0/70.0	34.05	17.39	-	34.07	17.25	-	34.12	17.42	-
52	20.0/70.0	34.08	17.39	-	33.97	17.19	-	34.15	17.41	-
53	20.0/70.0	33.96	17.13	-	34.02	17.21	-	34.22	17.39	-
54	20.0/70.0	34.05	17.29	-	34.03	17.06	-	34.28	17.39	-
55	20.0/70.0	34.15	17.39	-	34.08	17.12	-	34.21	17.40	-
56	20.0/70.0	34.13	17.26	-	34.09	17.13	-	34.26	17.37	-
57	20.0/70.0	33.97	17.15	-	34.08	17.11	-	34.05	17.26	-
58	20.0/70.0	33.91	17.16	-	33.81	16.99	-	33.82	17.20	-
59	20.0/70.0	34.05	17.37	-	34.10	17.33	-	34.11	17.48	-
60	20.0/70.0	34.08	17.42	-	34.10	17.28	-	34.12	17.36	-
61	20.0/70.0	34.23	17.31	-	34.23	17.23	-	34.33	17.43	-
62	20.0/70.0	34.19	17.28	-	34.05	17.17	-	34.13	17.25	-
63	20.0/70.0	34.25	17.31	-	34.17	17.26	-	34.19	17.39	-
64	20.0/70.0	34.15	17.30	-	34.09	17.13	-	34.23	17.32	-
Total Power 33-64		49.16	32.35	-	49.16	32.25	-	49.23	32.46	-
Total Power 33-64+23 dBi		72.16	55.35	-	72.16	55.25	-	72.23	55.46	-
EIRP		75.20	58.37	-	75.18	58.26	-	75.26	58.46	-

A.2 Occupied Bandwidth

A.2.1 Reference

FCC CFR 47 Part 2, Clause 2.1049

FCC CFR 47 Part 27, Clause 27.53 (m)

A.2.2 Method of Measurements

The EUT was set to transmit at maximum power and testing was carried out on bottom, middle and top channels. Using the Occupied Bandwidth measurement function in the spectrum analyzer, the 26dB bandwidth was measured in accordance with ANSI 63.26.

The measurement method is from ANSI 63.26:

- a) The spectrum analyzer center frequency is set to the nominal EUT channel center frequency. The frequency span for the spectrum analyzer shall be set wide enough to capture all modulation products including the emission skirts (i.e., two to five times the OBW).
- b) The nominal IF filter bandwidth (3 dB RBW) shall be in the range of 1 to 5 % of the anticipated OBW, and the VBW shall be at least 3 times the RBW.
- c) Set the reference level of the instrument as required to keep the signal from exceeding the maximum input mixer level for linear operation. In general, the peak of the spectral envelope must be at least $10\log(\text{OBW} / \text{RBW})$ below the reference level.
- d) Set the detection mode to peak, and the trace mode to max hold.
- e) Use the 99 % power bandwidth function of the spectrum analyzer and report the measured bandwidth.

A.2.3 Measurement result

Configuration NR-MIMO-1C 70.0M
-26dBc Occupied Bandwidth

Port	Modulation / Bandwidth	Occupied Bandwidth (MHz)		
		Channel Position B	Channel Position M	Channel Position T
10	16QAM/ 70.0 MHz	69.59	69.62	69.60

-26dBc Occupied Bandwidth

Port	Bandwidth	Occupied Bandwidth (MHz)		
		Modulation QPSK/ Channel position M	Modulation 64QAM/ Channel position M	Modulation 256QAM/ Channel position M
10	70.0MHz	69.66	69.65	69.66

99% Occupied Bandwidth

Port	Modulation / Bandwidth	Occupied Bandwidth (MHz)		
		Channel Position B	Channel Position M	Channel Position T
10	16QAM/ 70.0 MHz	67.467	67.541	67.509

99% Occupied Bandwidth

Port	Bandwidth	Occupied Bandwidth (MHz)		
		Modulation QPSK/ Channel position M	Modulation 64QAM/ Channel position M	Modulation 256QAM/ Channel position M
10	70.0MHz	67.419	67.430	67.427

Port 10, 16QAM 70.0M Channel position B

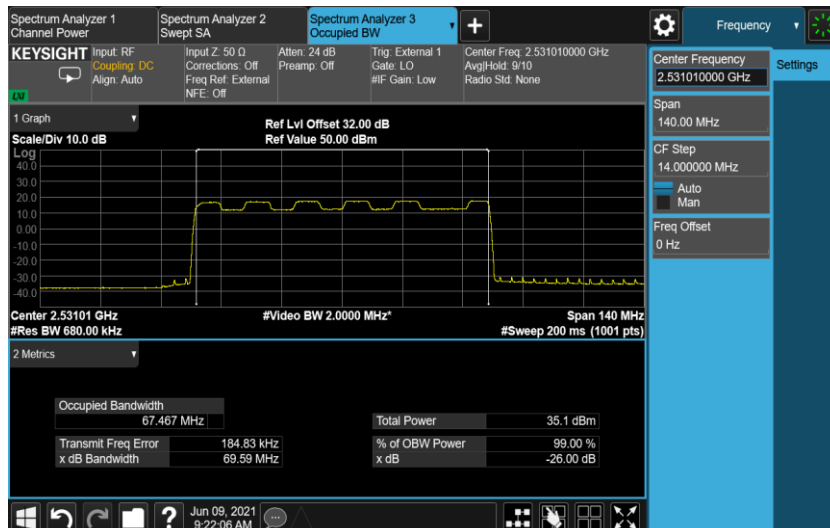

Port 10, 16QAM 70.0M Channel position M

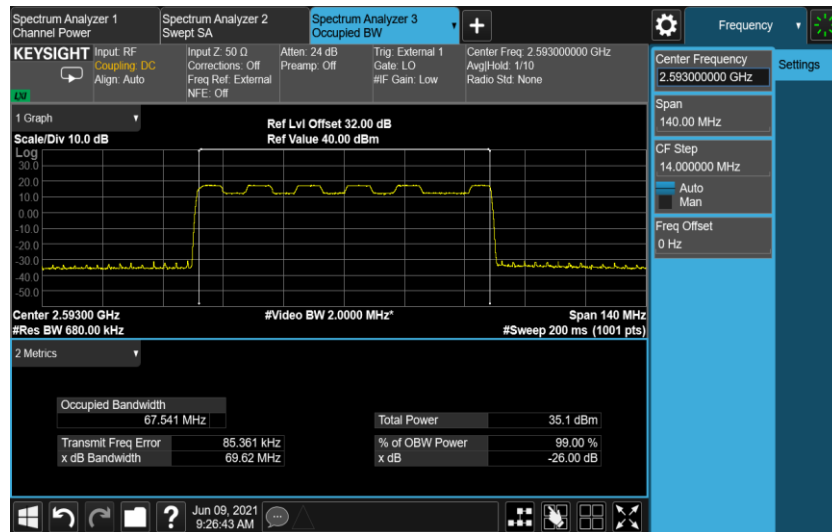

Port 10, 16QAM 70.0M Channel position T

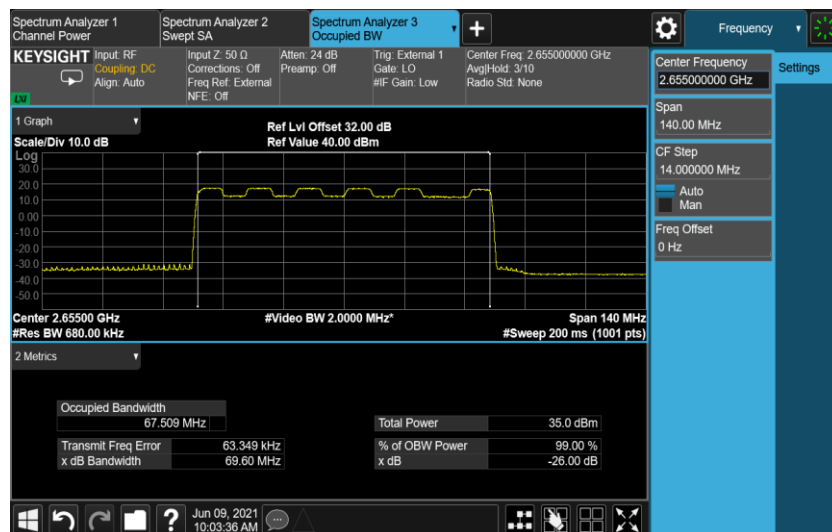

Port 10, QPSK 70.0M Channel position M

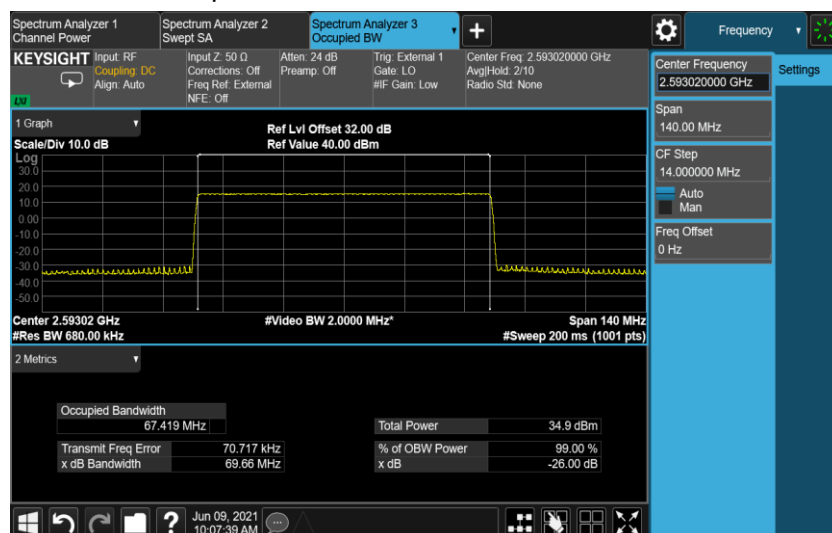

Port 10, 64QAM 70.0M Channel position M

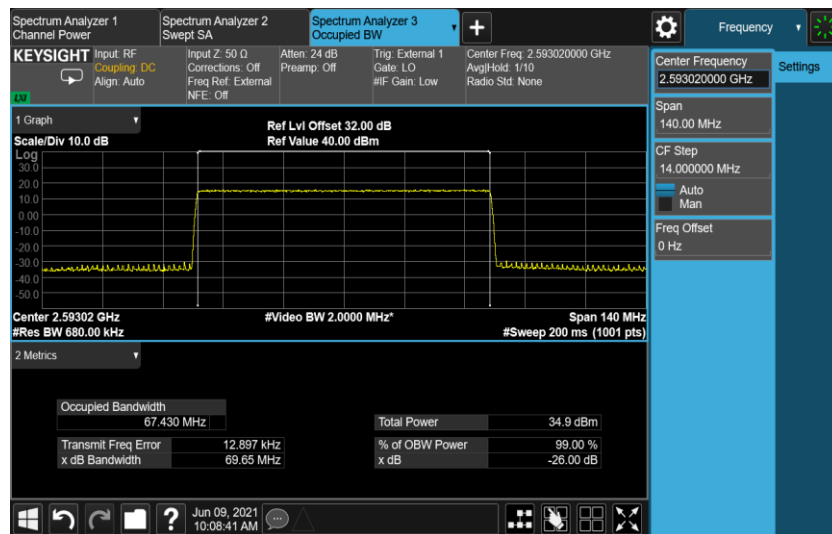

Port 10, 256QAM 70.0M Channel position M

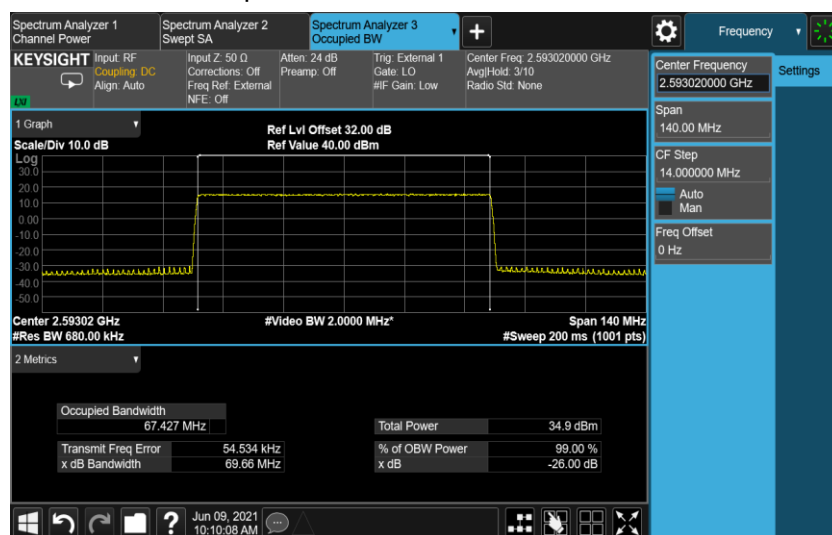

A.3 Spurious Emissions at Band Edge

A.3.1 Reference

FCC CFR 47 Part 2, Clause 2.1051

FCC CFR 47 Part 27, Clause 27.53(m)

A.3.2 Method of measurement

The power of any emission outside of the authorized operating frequency ranges must be attenuated below the transmitting power (P) by a factor of at least $43 + 10\log(P)$ dB.

For MIMO mode configurations, the limit was adjusted with a correction of -18.06dB [$10\log(1/64)$] by using the Measure and Add $10\log(N)$ dB technique according to KDB 662911 D01 Multiple Transmitter Output accounting for simultaneous transmission from antenna ports . Then the limit was adjust to -31.06dBm .

In the 1 MHz bands immediately outside and adjacent to the frequency block, a resolution bandwidth of at least one percent of the emission bandwidth of the fundamental emission of the transmitter may be employed and a RBW of 1MHz for measurements of emissions > 1MHz away from the band edges.

The limit was adjusted with -13.01dB [$10\log(50/1000)$] to compensate for the reduced measurement bandwidth 50KHz for emission more than 1MHz away from the band edges. For MIMO mode, the limit of -44.07dBm was used for emission more than 1MHz away from the band edges. Spectrum analyzer detector was set as RMS.

A.3.3 Measurement limit

The power of any emission outside of the authorized operating frequency ranges must be attenuated below the transmitting power (P) by a factor of at least $43 + 10\log(P)$ dB.

A.3.4 Measurement result

Configuration NR-MIMO-1C, 16QAM

Band Edge Frequency	Channel Bandwidth	RBW(KHz)	Limit(dBm)
Channel Position B 2496MHz	NR 70.0 MHz	50/50	-42.52/-44.07
Channel Position T 2690MHz	NR 70.0 MHz	50/50	-42.52/-44.07

Port 10, Channel Position B, 70.0MHz

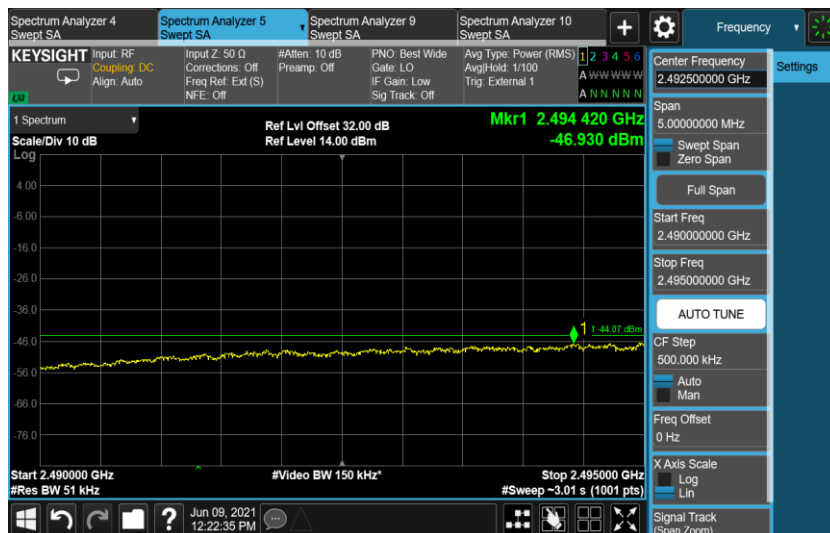

Port 10, Channel Position T, 70.0MHz

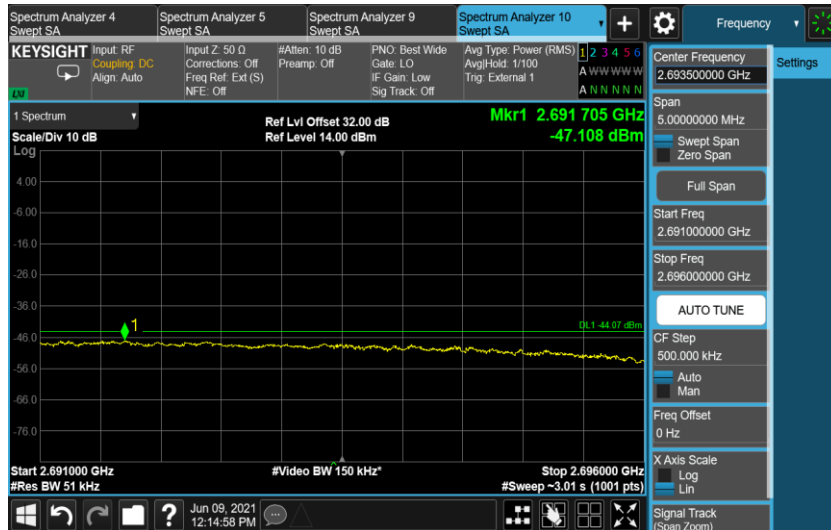
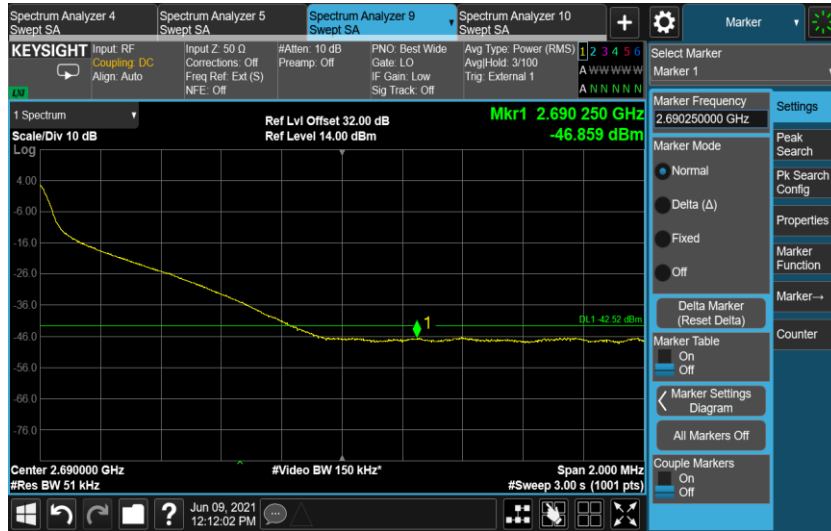

Configuration LTE+NR-MIMO-MC-BE-1(1LTE QPSK+1NR 16QAM)

Band Edge Frequency	Channel Bandwidth	RBW (KHz)	Limit (dBm)
Channel Position B	(L) 10.0MHz, (NR) 70.0MHz	100/51	-31.06/-44.07
	(L) 20.0MHz, (NR) 70.0MHz	200/51	-31.06/-44.07
Channel Position T	(L) 10.0MHz, (NR) 70.0 MHz	100/51	-31.06/-44.07
	(L) 20.0MHz, (NR) 70.0 MHz	200/51	-31.06/-44.07

Port 10, Channel Position B, LTE 10.0MHz, NR 70.0 MHz

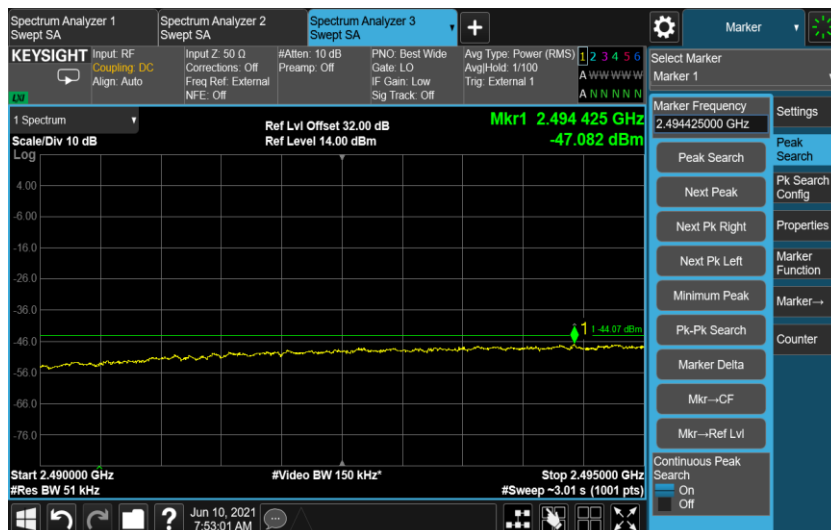
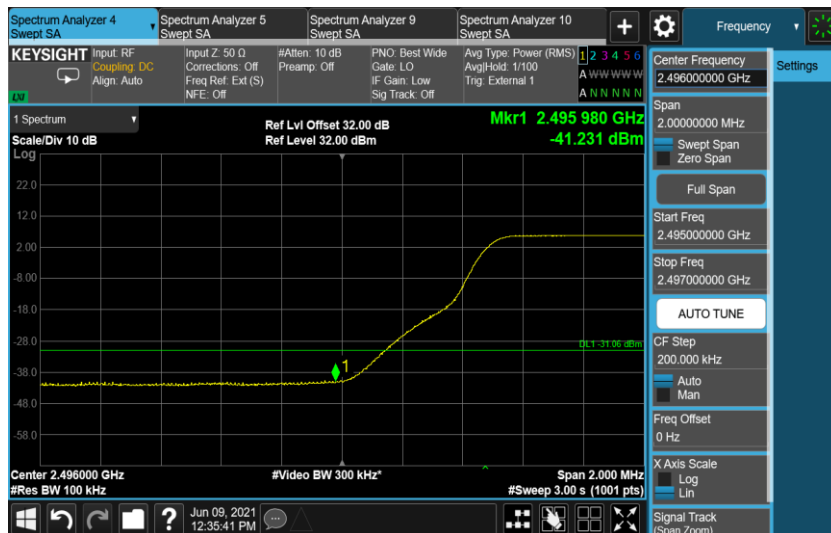

Port 10, Channel Position T, LTE 10.0MHz, NR 70.0 MHz

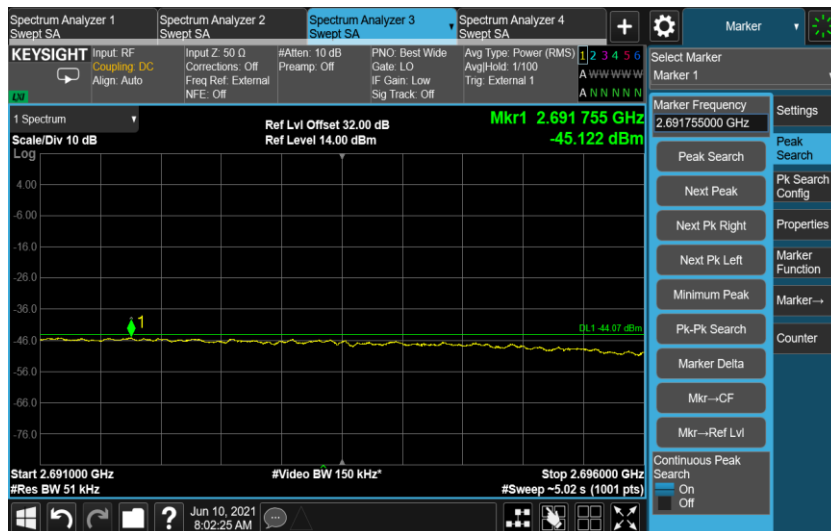

Port 10, Channel Position B, LTE 20.0MHz, NR 70.0 MHz

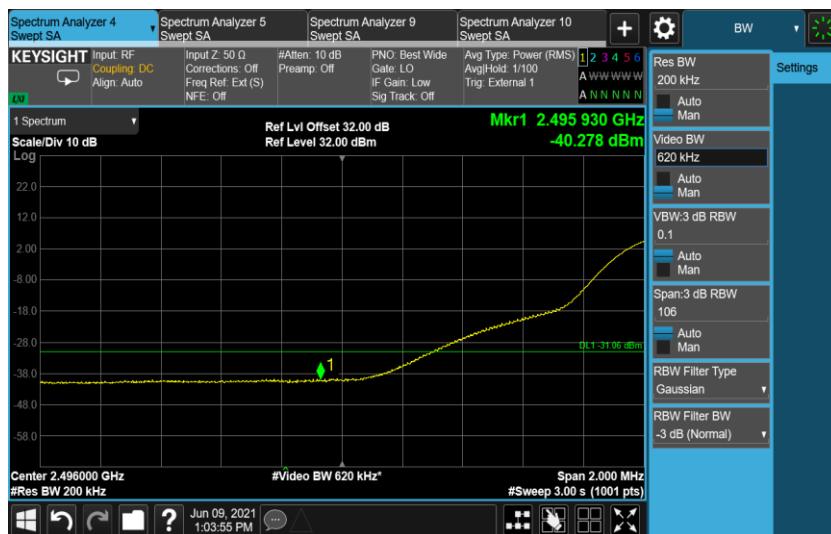

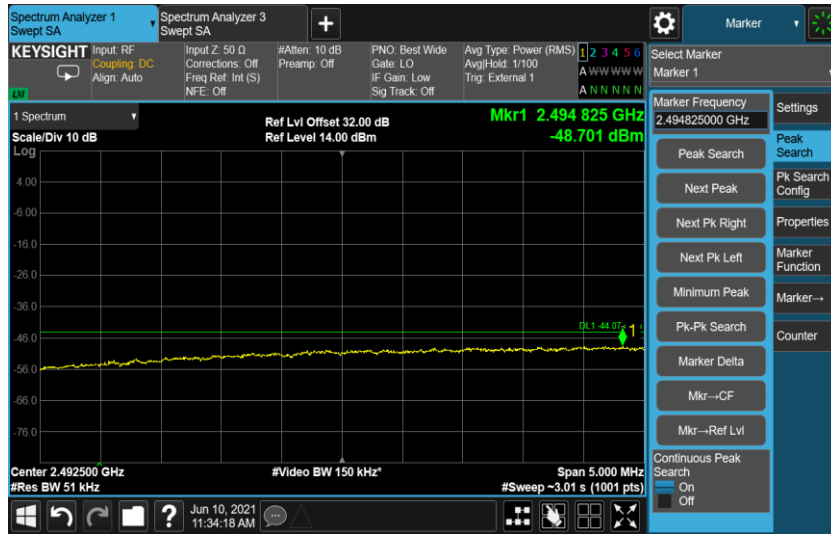

Port 10, Channel Position T, LTE 20.0MHz, NR 70.0 MHz

