



Choose Scandinavian trust

# Radio Test report – Dot 2256 B48B41B25B66 and Dot 2266 B48B41B25B66

Report ID  
**REP039916**

Project ID  
**PRJ0057904**

Type of assessment:  
**Class II Permissive Change**

Applicant:  
**Ericsson AB**

Product description:  
**Remote Radio Unit which supports WCDMA, LTE, NBIoT, and NR**

Model (PMN):  
**Dot 2256 B48B41B25B66 and Dot 2266 B48B41B25B66**

Part number:  
**KRY 901 537/1 and KRY 901 537/2**

FCC Identifier  
**FCC ID: TA8BKRY901537-1 and TA8BKRY901537-2**

Requirements/Summary:

Standard	Environmental phenomenon	Compliance
FCC 47 CFR Part 27	Miscellaneous wireless communications services	Yes
FCC 47 CFR Part 24, Subpart E	Broadband Personal Communications Services (PCS)	Yes

Date of issue: May 24, 2024

**Nimish Kapoor, EMC/RF Test Specialist**

Tested by

Signature

**Kevin Rose, Wireless/EMC Specialist**

Reviewed by

Signature

Nemko Canada Inc., a testing laboratory, is accredited by ANSI National Accreditation Board (ANAB). The tests included in this report are within the scope of this accreditation. The ANAB symbol is an official symbol of the ANSI National Accreditation Board, used under licence.

ANAB File Number: AT-3195 (Ottawa/Almonte); AT-3193 (Pointe-Claire); AT-3194 (Cambridge)



#### Two test locations

---

Company name	Nemko Canada Inc.	
Address	303 River Road	349 Terry Fox
City	Ottawa	Ottawa
Province	Ontario	Ontario
Postal code	K1V 1H2	K2K 2V6
Country	Canada	Canada
Telephone	+1 613 737 9680	+1 613 963 8000
Facsimile	+1 613 737 9691	
Toll free	+1 800 563 6336	
Website	www.nemko.com	
Site number	FCC test site registration number: CA2040, IC: 2040A-4 (3 m semi anechoic chamber)	

#### Limits of responsibility

---

Note that the results contained in this report relate only to the items tested and were obtained in the period between the date of initial receipt of samples and the date of issue of the report.

This test report has been completed in accordance with the requirements of ISO/IEC 17025. All results contain in this report are within Nemko Canada's ISO/IEC 17025 accreditation.

#### Copyright notification

---

Nemko Canada Inc. authorizes the applicant to reproduce this report provided it is reproduced in its entirety and for use by the company's employees only. Any use which a third party makes of this report, or any reliance on or decisions to be made based on it, are the responsibility of such third parties.

Nemko Canada Inc. accepts no responsibility for damages, if any, suffered by any third party as a result of decisions made or actions based on this report.

© Nemko Canada Inc.

## Table of contents

<b>Table of contents .....</b>	<b>3</b>
<b>Section 1. Report summary .....</b>	<b>4</b>
1.1 Applicant .....	4
1.2 Manufacturer .....	4
1.3 Test specifications .....	4
1.4 Test method .....	4
1.5 Statement of compliance .....	4
1.6 Test report revision history .....	4
<b>Section 2. Summary of test results.....</b>	<b>5</b>
2.1 Testing location .....	5
2.2 Testing period .....	5
2.3 Sample information.....	5
2.4 FCC Part 27/24 test results .....	5
<b>Section 3. Equipment under test (EUT) details .....</b>	<b>6</b>
3.1 EUT information .....	6
3.2 Product description and theory of operation .....	8
3.3 EUT test details.....	9
3.4 EUT setup diagram .....	12
3.5 Setup photographs .....	13
<b>Section 4. Engineering considerations.....</b>	<b>14</b>
4.1 Modifications incorporated in the EUT.....	14
4.2 Technical judgment .....	14
4.3 Model variant declaration .....	14
4.4 Deviations from laboratory tests procedures .....	14
<b>Section 5. Test conditions.....</b>	<b>15</b>
5.1 Atmospheric conditions .....	15
5.2 Power supply range.....	15
<b>Section 6. Measurement uncertainty .....</b>	<b>16</b>
6.1 Uncertainty of measurement .....	16
<b>Section 7. Test equipment .....</b>	<b>17</b>
7.1 Test equipment list.....	17
<b>Section 8. Testing data .....</b>	<b>18</b>
8.1 Maximum output power at RF antenna connector (Band 66).....	18
8.2 Transmitter output power (EIRP) and antenna height (Band 2/25).....	24
8.3 Spurious emissions at RF antenna connector (Band 66).....	29
8.4 Spurious out-of-band emissions (Band 2/25) .....	36
8.5 Occupied bandwidth (Band 66) .....	41
8.6 Occupied bandwidth (Band 2/25).....	42
<b>Section 9. Block diagrams of test setups .....</b>	<b>43</b>
9.1 Antenna port set-up .....	43

## Section 1. Report summary

---

### 1.1 Applicant

---

Company name	Ericsson AB
Address	Torshamnsgatan 23, Stockholm, Sweden, 164 80

### 1.2 Manufacturer

---

Company name	Ericsson Canada Inc.
Address	349 Terry Fox Drive, Ottawa, ON, Canada, K2K 2V6

### 1.3 Test specifications

---

FCC 47 CFR Part 2	Frequency Allocations and Radio Treaty Matters; General Rules and Regulations
FCC 47 CFR Part 24, Subpart E	Broadband Personal Communications Services (PCS)
FCC 47 CFR Part 27	Miscellaneous wireless communications services (2110–2200 MHz)

### 1.4 Test method

---

ANSI C63.26-2015	American National Standard for Compliance Testing of Transmitters Used in Licensed Radio Services
KDB 662911 D01	Multiple Transmitter Output v02r01
KDB 662911 D02	MIMO with Cross-Polarized Antennas v01

### 1.5 Statement of compliance

---

In the configuration tested, the EUT was found compliant. Testing was completed against customer test plan. Results obtained indicate that the product under test complies in full with the requirements tested.

This test report (**REP039916**) applies to the *Dot 2256 B48B41B25B66 and Dot 2266 B48B41B25B66* with part number *KRC KRY 901 537/1 and KRY 901 537/2*. See “Summary of test results” for full details.

### 1.6 Test report revision history

---

**Table 1.6-1:** Test report revision history

Report ID	Date of issue	Details of changes made to test report
REP039916	May 24, 2024	Original report issued

## Section 2. Summary of test results

---

### 2.1 Testing location

---

Test location (s) Ottawa

### 2.2 Testing period

---

Test start date May 2, 2024 Test end date May 2, 2024

### 2.3 Sample information

---

Receipt date May 2, 2024 Nemko sample ID number PRJ00579040001

### 2.4 FCC Part 27/24 test results

---

**Table 2.4-1: FCC results summary**

Part	Test description	Verdict
§27.50(b)	Maximum output power at RF antenna connector	Pass
§27.53	Spurious emissions at RF antenna connector	Pass
§24.232(a)(2)	Power and antenna height limits for base stations with BW greater than 1 MHz	Pass
§24.238(a)	Emission limitations for Broadband PCS equipment – out of band emissions (conducted)	Pass
§2.1049	Occupied bandwidth	Pass

Notes: Only tests applicable to the assessment have been performed and reported in this test report

## Section 3. Equipment under test (EUT) details

### 3.1 EUT information

Product name	Radio Dot		
Model	Dot 2256 B48B41B25B66 and Dot 2266 B48B41B25B66		
Part number	KRY 901 537/1 and KRY 901 537/2		
Revision	R1B		
Serial number	TD3W388627		
Antenna ports	2T2R B48, 2T2R B41, 2T2R B25, 2T2R B66		
RF BW / IBW	B48: 150 MHz B41: 194 MHz B25: 65 MHz B66: 90/70 MHz (DL/UL)		
Frequency	Tx:	Rx:	
	B48: 3550-3700 MHz	B48: 3550-3700 MHz	
	B41: 2496-2690 MHz	B41: 2496-2690 MHz	
	B25: 1930-1995 MHz	B25: 1850-1915 MHz	
	B66: 2110-2200 MHz	B66: 1710-1780 MHz	
Nominal O/P per Antenna port per Band	B48: 26 dBm per branch B41: 26 dBm per branch B25: 23 dBm per branch B66: 23 dBm per branch		
Accuracy (nominal)	±0.1 ppm		
Nominal voltage	56Vdc (CAT6A POE or Hybrid cable)		
RAT	B48: NR, LTE, NR+LTE (TDD) B41: NR, LTE, NR+LTE (TDD) B25: NR, LTE, NR+LTE (FDD) B66: NR, LTE, NR+LTE (FDD)		
Modulation	LTE: QPSK, 16 QAM, 64 QAM, 256 QAM NR: QPSK, 16 QAM, 64 QAM, 256 QAM		
Channel bandwidth	B48: NR: 10, 20, 30, 40, 50, 60, 70, 80, 90, 100 MHz LTE: 10, 20 MHz B41: NR: 10, 20, 30, 40, 50, 60, 70, 80, 90, 100 MHz LTE: 5, 10, 15, 20 MHz B25/B66: NR: 5, 25, 30, 35, 40 MHz LTE: 5, 10, 15, 20 MHz		
Channel bandwidth LTE + NB-IoT	B25/B66: LTE+NB-IoT: 5, 10, 15, 20 MHz		
CPRI	10.1 Gbps		

Channel raster	LTE: 100 kHz NR: 100 kHz
Regulatory requirements	FCC Part 2, 24, 27, 96
Emission Designator	B48 NR: 10M0F9W, 20M0F9W, 30M0F9W, 40M0F9W, 50M0F9W, 60M0F9W, 70M0F9W, 80M0F9W, 90M0F9W, 100MF9W B48 LTE: 10M0W7D, 20M0W7D B41 NR: 10M0F9W, 20M0F9W, 30M0F9W, 40M0F9W, 50M0F9W, 60M0F9W, 70M0F9W 80M0F9W, 90M0F9W, 100MF9W B41 LTE: 5M00W7D, 10M0W7D, 15M0W7D, 20M0W7D B25 NR: 5M00F9W, 25M0F9W, 30M0F9W, 35M0F9W, 40M0F9W B25 LTE+NBloT: 5M00W7D, 10M0W7D, 15M0W7D, 20M0W7D B66 NR: 5M00F9W, 25M0F9W, 30M0F9W, 35M0F9W, 40M0F9W B66 LTE+NBloT: 5M00W7D, 10M0W7D, 15M0W7D, 20M0W7D
Supported Configurations	Single Antenna, TX Diversity, MIMO, Carrier Aggregation, Ericsson Spectral Sharing (ESS)
Operating temperature	+5°C to +40°C
Max RF Power	B48: 2 x 0.4W (26dBm) (1 carrier limited to 24dBm) B41: 2 x 0.4W (26dBm) (1 carrier limited to 24dBm) B25: 2 x 0.2W (23dBm) B66: 2 x 0.2W (23dBm)
Supported carriers /band/ port SRO/MRO	Up to 6 carriers. LTE: Max 6 NR: Max 6 LTE + NB-IoT: GB Max 2, IB Max 2
Carrier Configuration:	SRO: LTE, NR MRO: NR+LTE Contiguous and Non-contiguous

### 3.2 Product description and theory of operation

**EUT description of the methods used to exercise the EUT and all relevant ports:**

Description/theory of operation	Dot 2256 B48B41B25B66 (KRY 901 537/1) and Dot 2266 B48B41B25B66 (KRY 901 537/2) are Remote Radio Units forming part of the Ericsson Radio Base Station (RBS) equipment. The Dot provides radio access for mobile and fixed devices and is intended for the indoor environment. The radio operates over 8 Transmit ports in MRO (NR+LTE); Single, Multi-Carrier, and MIMO transmission with a maximum rated RF Output up to 0.4W per port over an operational temperature of 5°C to +40°C. The unit is designed to be ceiling or wall mounted. The 2256 and 2266 radios are identical except that Dot 2256 has internal antennas and Dot 2266 has external RF ports.																							
Ports/Interface	RJ45: Digital RDI / DC Power Input SFP+: Digital RDI, Optical SFP+ 3A, 3B: RF to antenna B48 4A, 4B: RF to antenna B41 2A, 2B: RF to antenna B25 1A, 1B: RF to antenna B66																							
Physical	<table border="1"> <thead> <tr> <th data-bbox="464 716 634 751">Radio Dot Type</th> <th data-bbox="634 716 805 751">Height (mm)</th> <th data-bbox="805 716 976 751">Width (mm)</th> <th data-bbox="976 716 1146 751">Depth (mm)</th> <th data-bbox="1146 716 1317 751">Weight (g)<sup>(1)</sup></th> <th data-bbox="1317 716 1487 751">Color</th> </tr> </thead> <tbody> <tr> <td data-bbox="464 751 634 787">Dot 2256</td> <td data-bbox="634 751 805 787">78</td> <td data-bbox="805 751 976 787">230</td> <td data-bbox="976 751 1146 787">230</td> <td data-bbox="1146 751 1317 787">2300</td> <td data-bbox="1317 751 1487 787">off-white</td> </tr> <tr> <td data-bbox="464 787 634 825">Dot 2266</td> <td data-bbox="634 787 805 825">78</td> <td data-bbox="805 787 976 825">230</td> <td data-bbox="976 787 1146 825">230</td> <td data-bbox="1146 787 1317 825">2300</td> <td data-bbox="1317 787 1487 825">off-white</td> </tr> </tbody> </table>						Radio Dot Type	Height (mm)	Width (mm)	Depth (mm)	Weight (g) <sup>(1)</sup>	Color	Dot 2256	78	230	230	2300	off-white	Dot 2266	78	230	230	2300	off-white
Radio Dot Type	Height (mm)	Width (mm)	Depth (mm)	Weight (g) <sup>(1)</sup>	Color																			
Dot 2256	78	230	230	2300	off-white																			
Dot 2266	78	230	230	2300	off-white																			
Software details	CXP2030045/26_R20A823																							
Product Identification / Markings and Labels																								



### 3.3 EUT test details

#### EUT setup/configuration rationale for Down link:

RAT	Modulation	Test Model / Configuration
LTE	QPSK	TM1.1
LTE	16QAM	TM3.2
LTE	64QAM	TM3.1
LTE	256QAM	TM3.1a
NR	QPSK	TM1.1
NR	16QAM	TM3.2
NR	64QAM	TM3.1
NR	256QAM	TM3.1a

#### NR 35MHz Single Carrier B25

Bandwidth, MHz	Transmit / DL, MHz					
	B	NR-ARFCN	M	NR-ARFCN	T	NR-ARFCN
35	1947.5	389500	1962.5	392500	1977.5	395500

Bandwidth, MHz	Receive / UL, MHz					
	B	NR-ARFCN	M	NR-ARFCN	T	NR-ARFCN
35	1867.5	373500	1882.5	376500	1897.5	379500

#### NR 35MHz Single Carrier B66

Bandwidth, MHz	Transmit / DL, MHz					
	B	NR-ARFCN	M	NR-ARFCN	T	NR-ARFCN
35	2127.5	425500	2155.0	431000	2182.5	436500

Bandwidth, MHz	Receive / UL, MHz					
	B	NR-ARFCN	M	NR-ARFCN	T	NR-ARFCN
35	1727.5	345500	1755.0	351000	1782.5	356500

EUT test details, continued

---

**B25 NR Configurations Tested:**

Carrier configurations	Transmit / DL, MHz
SC, 35MHz, Bottom	1947.5
SC, 35MHz, Middle	1962.5
SC, 35MHz, Top	1977.5

**B25 Mixed Mode Configurations Tested:**

Carrier configurations	Transmit / DL, MHz
2C, N35+L5, Bottom	1947.5+1967.5
2C, N35+L5, Middle	1960.0+1980.0
2C, N35+L5, Top	1972.5+1992.5

EUT test details, continued

---

**B66 NR Configurations Tested:**

Carrier configurations	Transmit / DL, MHz
SC, 35MHz, Bottom	2127.5
SC, 35MHz, Middle	2155.0
SC, 35MHz, Top	2182.5
2C, 35MHz, Bottom	2127.5+2162.5
2C, 35MHz, Middle	2137.5+2172.5
2C, 35MHz, Top	2147.5+2182.5

**B66 Mixed Mode Configurations Tested:**

Carrier configurations	Transmit / DL, MHz
2C, N35+L5, Bottom	2127.5+2147.5
2C, N35+L5, Middle	2152.5+2172.5
2C, N35+L5, Top	2177.5+2197.5

### 3.4 EUT setup diagram

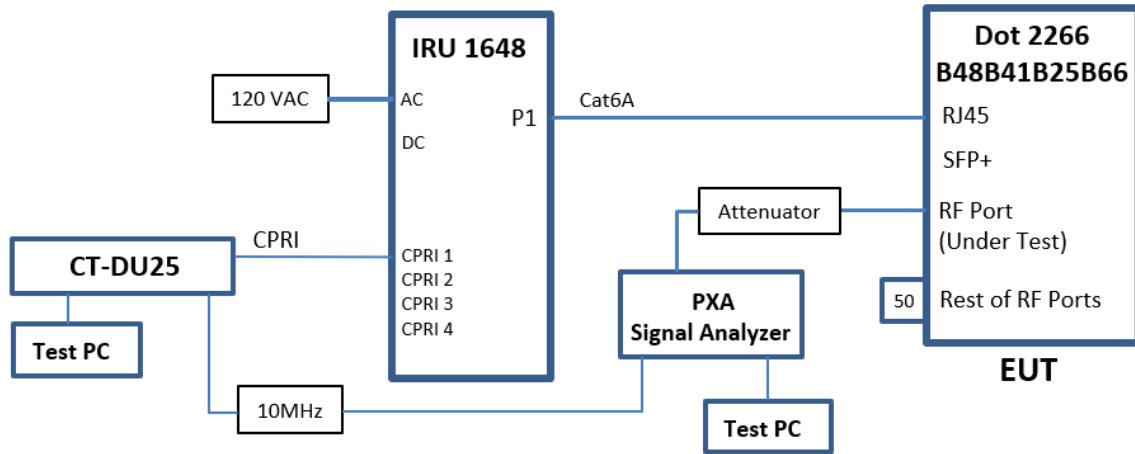
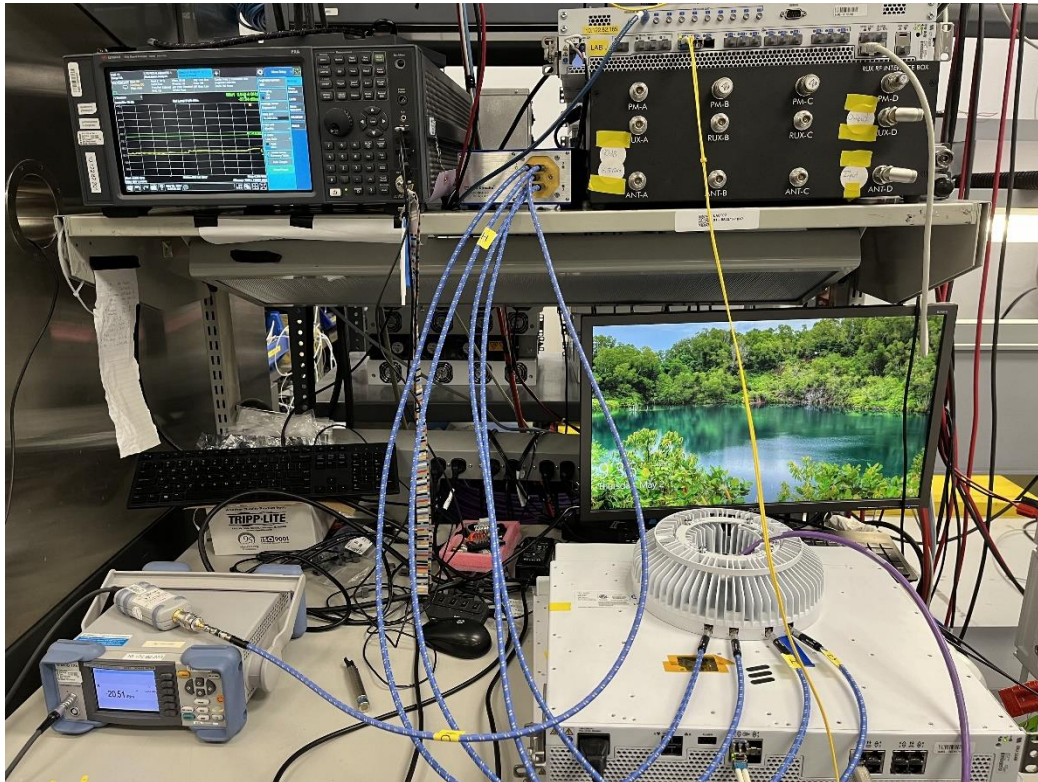

Figure 3.4-1: Setup diagram – Radio Compliance

### 3.5 Setup photographs



**Figure 3.5-1:** Set up photo for Radio Compliance Testing

## Section 4. Engineering considerations

---

---

### 4.1 Modifications incorporated in the EUT

---

There were no modifications performed to the EUT during this assessment.

### 4.2 Technical judgment

---

---

None

### 4.3 Model variant declaration

---

As declared by the applicant, the EUT model Dot 2266 B48B41B25B66 (Part Number: KRY 901 537/2) has been chosen to be representative for all other similar products: Dot 2256 B48B41B25B66 (Part Number: KRY 901 537/1)

The Dot 2256 B48B41B25B66 (Part Number: KRY 901 537/1) and Dot 2266 B48B41B25B66 (Part Number: KRY 901 537/2) models represent the same hardware, with the exception that the KRY 901 537/1 has internal antenna(s) and the KRY 901 537/2 provides for antenna's to be remoted externally. Antenna port conducted testing was performed on the external antenna version and these same test results are also used to demonstrate compliance for the internal antenna version.

### 4.4 Deviations from laboratory tests procedures

---

No deviations were made from laboratory procedures.

## Section 5. Test conditions

---

### 5.1 Atmospheric conditions

---

Temperature	15–30 °C
Relative humidity	20–75 %
Air pressure	860–1060 mbar

When it is impracticable to carry out tests under these conditions, a note to this effect stating the ambient temperature and relative humidity during the tests shall be recorded and stated.

### 5.2 Power supply range

---

The normal test voltage for equipment to be connected to the mains shall be the nominal mains voltage. For the purpose of the present document, the nominal voltage shall be the declared voltage, or any of the declared voltages  $\pm 5\%$ , for which the equipment was designed.

## Section 6. Measurement uncertainty

---

### 6.1 Uncertainty of measurement

---

Measurement	Measurement uncertainty, $\pm$ dB
Radiated spurious emissions (30 MHz to 1 GHz)	5.8
Radiated spurious emissions (1 GHz to 6 GHz)	4.7
Radiated spurious emissions (6 GHz to 18 GHz)	5.0
Radiated spurious emissions (18 GHz to 26 GHz)	5.0
Radiated spurious emissions (18 GHz to 40 GHz)	5.2
RF Output power measurement using Spectrum Analyzer <sup>1</sup>	0.69
RF Output power measurement using Power Meter	0.54
Conducted spurious emissions	0.94
Occupied Bandwidth	0.36%

Notes: UKAS Lab 34, TIA-603 and ETSI TR 100 028-1&2 have been used as guidance for measurement uncertainty reasonable estimations with regards to previous experience and validation of data. Nemko Canada Inc. follows these test methods in order to satisfy ISO/IEC 17025 requirements for estimation of uncertainty of measurement for wireless products. Measurement uncertainty calculations assume a coverage factor of  $K = 2$  with 95% certainty.



## Section 7. Test equipment

---

### 7.1 Test equipment list

---

*Table 7.1-1: Equipment list*

Equipment	Manufacturer	Model no.	Asset no.	Cal cycle	Next cal.
PXA Signal Analyzer	Keysight	N9030B	MY57144347	1 year	April 3, 2025
Power Meter	Rohde & Schwarz	NRP2	101814	2 years	March 21, 2025
Power Sensor	Rohde & Schwarz	NRP-Z11	100070	2 years	March 31, 2025
CT-DU25*	Ericsson	LPC 102 500/1	T01G525053	—	NCR
IRU 1648*	Ericsson	KRC 161 842/1	TD3F105259	—	NCR
ENA Network Analyzer	Keysight	E5080B	MY59202549	1 year	April 4, 2025

Notes: NCR - no calibration required

\* Radio Supporting equipment (CT-DU25) is the test equipment that drives the radios traffic.

## Section 8. Testing data

---

### 8.1 Maximum output power at RF antenna connector (Band 66)

---

#### 8.1.1 Definitions and limits

---

##### **FCC §27.50(d) Operation within the bands: 2110–2155 MHz and 2155–2180 MHz.**

(1) The power of each fixed or base station transmitting in the 1995–2000 MHz, 2110–2155 MHz, 2155–2180 MHz or 2180–2200 MHz band and located in any county with population density of 100 or fewer persons per square mile, based upon the most recently available population statistics from the Bureau of the Census, is limited to:

(i) An equivalent isotropically radiated power (EIRP) of 3280 watts when transmitting with an emission bandwidth of 1 MHz or less;

(ii) An EIRP of 3280 watts/MHz when transmitting with an emission bandwidth greater than 1 MHz.

(2) The power of each fixed or base station transmitting in the 1995–2000 MHz, the 2110–2155 MHz 2155–2180 MHz band, or 2180–2200 MHz band and situated in any geographic location other than that described in paragraph (d)(1) of this section is limited to:

(i) An equivalent isotropically radiated power (EIRP) of 1640 watts when transmitting with an emission bandwidth of 1 MHz or less;

(ii) An EIRP of 1640 watts/MHz when transmitting with an emission bandwidth greater than 1 MHz.

(3) A licensee operating a base or fixed station in the 2110–2155 MHz band utilizing a power greater than 1640 watts EIRP and greater than 1640 watts/MHz EIRP must coordinate such operations in advance with all Government and non-Government satellite entities in the 2025–2110 MHz band. A licensee operating a base or fixed station in the 2110–2180 MHz band utilizing power greater than 1640 watts EIRP and greater than 1640 watts/MHz EIRP must be coordinated in advance with the following licensees authorized to operate within 120 kilometers (75 miles) of the base or fixed station operating in this band: All Broadband Radio Service (BRS) licensees authorized under this part in the 2155–2160 MHz band and all advanced wireless services (AWS) licensees authorized to operate on adjacent frequency blocks in the 2110–2180 MHz band.

(5) Equipment employed must be authorized in accordance with the provisions of §24.51. Power measurements for transmissions by stations authorized under this section may be made either in accordance with a Commission-approved average power technique or in compliance with paragraph (d)(6) of this section. In measuring transmissions in this band using an average power technique, the peak-to-average ratio (PAR) of the transmission may not exceed 13 dB.

(6) Peak transmit power must be measured over any interval of continuous transmission using instrumentation calibrated in terms of an rms-equivalent voltage. The measurement results shall be properly adjusted for any instrument limitations, such as detector response times, limited resolution bandwidth capability when compared to the emission bandwidth, sensitivity, etc., so as to obtain a true peak measurement for the emission in question over the full bandwidth of the channel.

### 8.1.2 Test summary

---

Test date	May 2, 2024
Test engineer	Nimish Kapoor

---

### 8.1.3 Observations, settings, and special notes

---

Output power was measured with RMS power meter per ANSI C63.26 Paragraph 5.2.4.2 method. PSD was measured using method described in paragraph 5.2.4.4.

- Randomly selected sample plots provided for information and settings only
- Total MIMO PSD was calculated as follows: PSD from one antenna port +  $10 \times \text{Log}_{10}(2)$
- RBS (Radio Base Station) EIRP Limits are deployment dependent. To ensure compliance with legal limits detailed in section 8.1.1, RBS set up and carrier configurations are addressed during site commissioning.
- Report results are compiled for the maximum output rated power for worst case emission assessment. EIRP, based on possible beam configuration, indicate the maximum power / worst case beam configuration based on ideal antenna parameters. Customer carrier configuration and power will be limited to comply with legal limits of 1640 W/MHz or 3280 W/MHz during RBS site set up and commissioning. Non-compliant configurations will be restricted to lower carrier power to ensure compliance.
- **To ensure compliance under worst case conditions with maximum output power based on a MIMO configuration, the maximum antenna gain for an RBS (Radio Base Station) system with Dot 2256 and 2266 B48B41B25B66 is 4.7 dBi with 0 dB path loss. Maximum measured PSD to EIRP margin 44.36 dB.**

Observations, settings, and special notes, continued

Spectrum analyzer settings for PSD:

Detector mode	RMS
Resolution bandwidth	1 MHz
Video bandwidth	>RBW
Measurement mode	Power over emission bandwidth
Trace mode	Averaging
Measurement time	Auto

8.1.4 Test data

*Table 8.1-1: EIRP calculation based on the worst-case PSD measurement*

Frequency, MHz	RF power density, dBm/MHz	Total MIMO PSD, dBm/MHz	Cable loss, dB	Antenna gain, dBi	EIRP PSD, dBm/MHz	EIRP limit, dBm/MHz	Margin, dB
2155.0	10.08	13.09	0.00	4.70	17.79	62.15	44.36

*Table 8.1-2: RF power density measurement results of a single-carrier operation for NR on 35 MHz channel*

Frequency, MHz	RF power density, dBm/MHz	Total MIMO PSD, dBm/MHz	EIRP limit, dBm/MHz	Margin, dB
2127.5	9.73	12.74	62.15	49.41
2155.0	<b>10.08</b>	13.09	62.15	49.06
2182.5	10.04	13.05	62.15	49.10

*Table 8.1-3: RF power density measurement results of a multi-carrier operation for NR on 35 MHz channel [Contiguous]*

Notes	Channel	RF power density, dBm/MHz	Total MIMO PSD, dBm/MHz	EIRP limit, dBm/MHz	Margin, dB
2 carriers	Bottom	6.93	9.94	62.15	52.21
	Middle	<b>6.98</b>	9.99	62.15	52.16
	Top	6.84	9.85	62.15	52.30

*Table 8.1-4: RF power density measurement results of a multi-RAT operation*

Notes	RF power density, dBm/MHz	Total MIMO PSD, dBm/MHz	EIRP limit, dBm/MHz	Margin, dB
NR 35 MHz + LTE with IoT15 MHz, Low Channel	15.67	18.68	62.15	43.47
NR 35 MHz + LTE with IoT15 MHz, Mid Channel	<b>16.51</b>	19.52	62.15	42.63
NR 35 MHz + LTE with IoT15 MHz, High Channel	16.46	19.47	62.15	42.68

Note: "and": non-contiguous channels; "+": contiguous channels

Test data, continued

**Table 8.1-5:** RF total channel power measurement results for NR [35 MHz]

Remarks	35 MHz channel (XX W)
Low channel, 64QAM	22.91
Mid channel, 64QAM	22.99
Top channel, 64QAM	22.89

Note: all results in the table are in dBm units

**Table 8.1-6:** RF total channel power measurement results for NR Multi-carrier [35 MHz bandwidth Contiguous]

Carriers	Channel	35 MHz channel (XX W)
2 Carriers, 64QAM	Low Channel	22.90
	Middle Channel	22.87
	Top Channel	22.87

Note: all results in the table are in dBm units

**Table 8.1-7:** RF total channel power measurement results for multi-RAT operation

Remarks	Power (dBm)
NR 35 MHz + LTE with IoT1 5 MHz, Low Channel	22.93
NR 35 MHz + LTE with IoT1 5 MHz, Mid Channel	22.87
NR 35 MHz + LTE with IoT1 5 MHz, High Channel	22.84

Note: "and": non-contiguous channels; "+": contiguous channels

Test data, continued

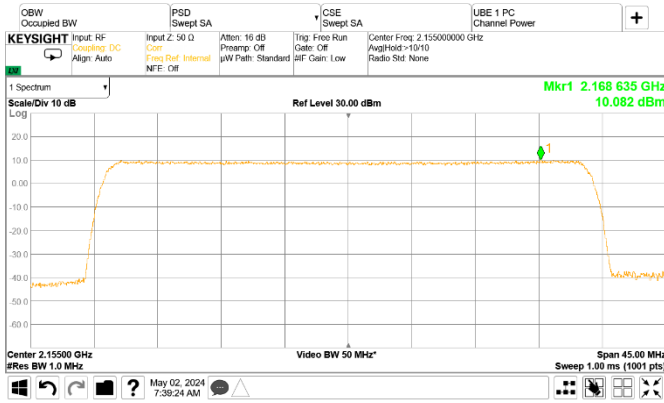

Figure 8.1-1: PSD of NR 35 MHz channel bandwidth, single carrier operation, sample plot

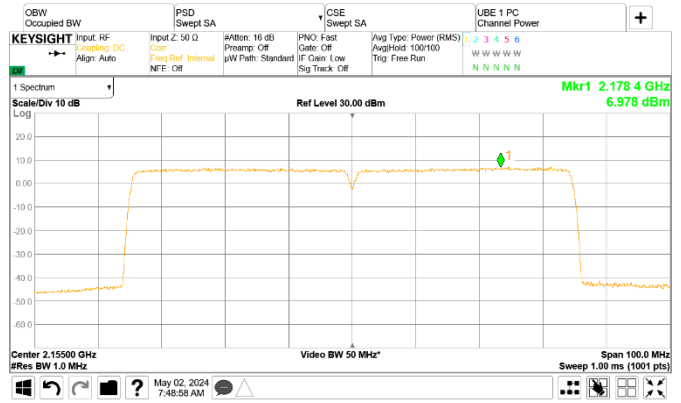

Figure 8.1-2: PSD of NR 35 MHz channel bandwidth, multi-carrier operation, sample plot, Contiguous

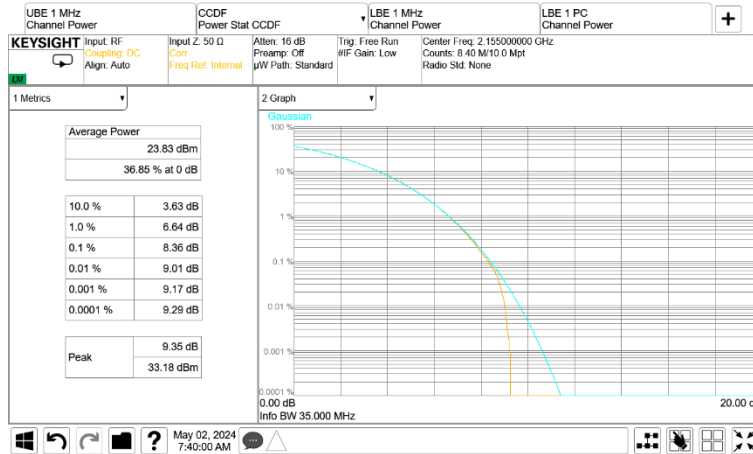

Figure 8.1-3: PSD of multi-RAT operation, NR 35 MHz + LTE with IoT1 5 MHz, Sample plot, Contiguous

Test data, continued

**Table 8.1-8:** Complementary Cumulative Distribution Function (CCDF) of the PAPR reduction measurement results for single carrier operation for NR 35 MHz

Remarks	Frequency, MHz	0.1% CCDF, dB	PAPR reduction limit, dB	Margin, dB
35 MHz, Low channel	2127.5	8.36	13.00	4.64
35 MHz, Mid channel	2155.0	8.36	13.00	4.64
35 MHz, Top channel	2182.5	8.31	13.00	4.69



**Figure 8.1-4:** CCDF sample plot, NR



## 8.2 Transmitter output power (EIRP) and antenna height (Band 2/25)

### 8.2.1 Definitions and limits

#### FCC §24.232(a)(2):

Base stations with an emission bandwidth greater than 1 MHz are limited to 1640 watts/MHz equivalent isotropically radiated power (EIRP) with an antenna height up to 300 meters HAAT, except as described in paragraph (b) below.

(2) Base station antenna heights may exceed 300 meters HAAT with a corresponding reduction in power; see table below.

(b)(1) Base stations that are located in counties with population densities of 100 persons or fewer per square mile, based upon the most recently available population statistics from the Bureau of the Census, with an emission bandwidth of 1 MHz or less are limited to 3280 watts equivalent isotropically radiated power (EIRP) with an antenna height up to 300 meters HAAT.

(d) Power measurements for transmissions by stations authorized under this section may be made either in accordance with a Commission-approved average power technique or in compliance with paragraph (e) of this section. In both instances, equipment employed must be authorized in accordance with the provisions of §24.51. In measuring transmissions in this band using an average power technique, the peak-to-average ratio (PAR) of the transmission may not exceed 13 dB.

**Table 8.2-1: Reduction to Maximum Allowable E.I.R.P. for HAAT > 300 m**

HAAT (m)	Maximum EIRP, W/MHz
HAAT ≤ 300	1640
300 < HAAT ≤ 500	1070
500 < HAAT ≤ 1000	490
1000 < HAAT ≤ 1500	270
1500 < HAAT ≤ 2000	160

### 8.2.2 Test summary

Test date	May 2, 2024
Test engineer	Nimish Kapoor



### 8.2.3 Observations, settings, and special notes

---

Output power was measured with RMS power meter per ANSI C63.26 Paragraph 5.2.4.2 method. PSD was measured using method described in paragraph 5.2.4.4.

- Randomly selected sample plots provided for information and settings only
- Total MIMO PSD was calculated as follows: PSD from one antenna port +  $10 \times \text{Log}_{10}(2)$
- RBS (Radio Base Station) EIRP Limits are deployment dependent. To ensure compliance with legal limits detailed in section 8.1.2, RBS set up and carrier configurations are addressed during site commissioning.
- Report results are compiled for the maximum output rated power for worst case emission assessment. EIRP, based on possible beam configuration, indicate the maximum power / worst case beam configuration based on ideal antenna parameters. Customer carrier configuration and power will be limited to comply with legal limits of 1640 W/MHz or 3280 W/MHz during RBS site set up and commissioning. Non-compliant configurations will be restricted to lower carrier power to ensure compliance.
- **To ensure compliance under worst case conditions with maximum output power based on a MIMO configuration, the maximum antenna gain for an RBS (Radio Base Station) system with Dot 2256 and 2266 B48B41B25B66 is 4.2 dBi with 0 dB path loss. Maximum measured PSD to EIRP margin 45.35 dB.**

Spectrum analyzer settings for PSD:

Detector mode	RMS
Resolution bandwidth	1 MHz
Video bandwidth	>RBW
Measurement mode	Power over emission bandwidth
Trace mode	Averaging

8.2.1 Test data

**Table 8.2-2: EIRP calculation based on the worst-case PSD measurement.**

Frequency, MHz	RF power density, dBm/MHz	Total MIMO PSD, dBm/MHz	Cable loss, dB	Antenna gain, dBi	EIRP PSD, dBm/MHz	EIRP limit, dBm/MHz	Margin, dB
1947.5	9.59	12.60	0.00	4.20	16.80	62.15	45.35

**Table 8.2-3: RF power density measurement results of a single-carrier operation for NR on 35 MHz channel**

Frequency, MHz	RF power density, dBm/MHz	Total MIMO PSD, dBm/MHz	EIRP limit, dBm/MHz	Margin, dB
1947.5	<b>9.59</b>	12.60	62.15	49.55
1962.5	9.58	12.59	62.15	49.56
1977.5	9.52	12.53	62.15	49.62

**Table 8.2-4: RF power density measurement results of a multi-RAT operation**

Notes	RF power density, dBm/MHz	Total MIMO PSD, dBm/MHz	EIRP limit, dBm/MHz	Margin, dB
NR 35 MHz + LTE with IoT15 MHz, Low Channel	15.18	18.19	62.15	43.96
NR 35 MHz + LTE with IoT15 MHz, Mid Channel	<b>15.79</b>	18.80	62.15	43.35
NR 35 MHz + LTE with IoT15 MHz, High Channel	15.25	18.26	62.15	43.89

Note: "and": non-contiguous channels; "+": contiguous channels

Test data, continued

**Table 8.2-5:** RF total channel power measurement results for NR [35 MHz]

Remarks	35 MHz channel (XX W)
Low channel, 64QAM	22.90
Mid channel, 64QAM	22.91
Top channel, 64QAM	22.89

Note: all results in the table are in dBm units

**Table 8.2-6:** RF total channel power measurement results for multi-RAT operation

Remarks	Power (dBm)
NR 35 MHz + LTE with IoT1 5 MHz, Low Channel	22.87
NR 35 MHz + LTE with IoT1 5 MHz, Mid Channel	22.90
NR 35 MHz + LTE with IoT1 5 MHz, High Channel	22.86

Note: "and": non-contiguous channels; "+": contiguous channels



**Figure 8.2-1:** PSD of NR 35 MHz channel bandwidth, single carrier operation, sample plot

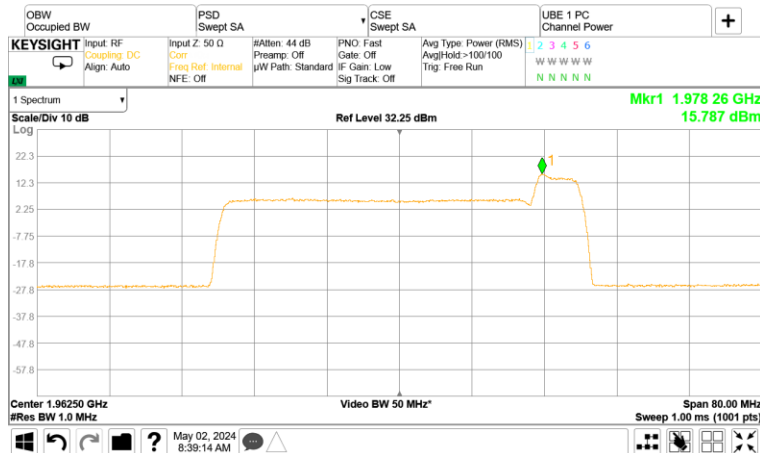
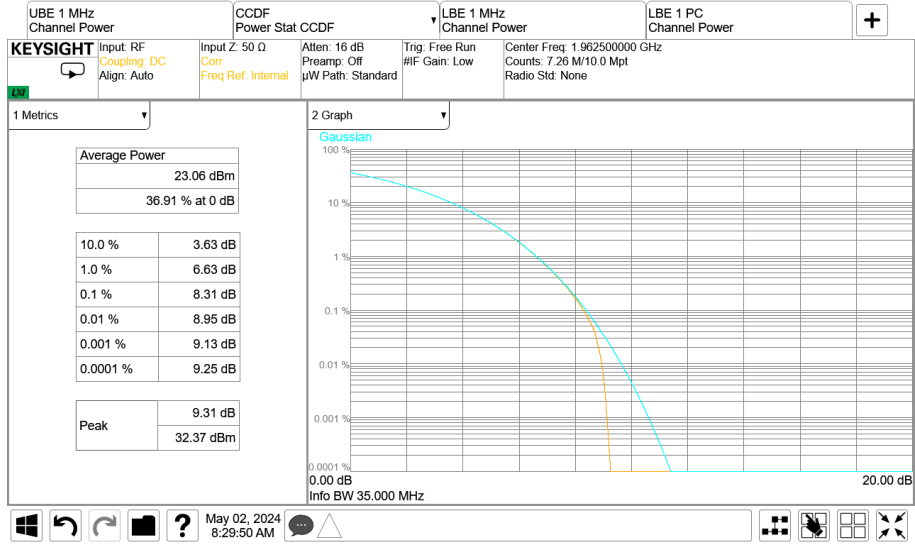

**Figure 8.2-2:** PSD of multi-RAT operation, NR 35 MHz and LTE with IoT1 5 MHz, sample plot, contiguous

Test data, continued

**Table 8.2-7:** Complementary Cumulative Distribution Function (CCDF) of the PAPR reduction measurement results for single carrier operation for NR 35 MHz

Remarks	Frequency, MHz	0.1% CCDF, dB	PAPR reduction limit, dB	Margin, dB
Low channel	1947.5	8.30	13.00	4.70
Mid channel	1962.5	8.31	13.00	4.69
Top channel	1977.5	8.29	13.00	4.71



**Figure 8.2-3:** CCDF sample plot, NR

## 8.3 Spurious emissions at RF antenna connector (Band 66)

---

### 8.3.1 Definitions and limits

---

#### FCC §27.53:

(h) AWS emission limits

(1) General protection levels. Except as otherwise specified below, for operations in the 1695–1710 MHz, 1710–1755 MHz, 1755–1780 MHz, 1915–1920 MHz, 1995–2000 MHz, 2000–2020 MHz, 2110–2155 MHz, 2155–2180 MHz, and 2180–2200 bands, the power of any emission outside a licensee's frequency block shall be attenuated below the transmitter power (P) in watts by at least  $43 + 10 \log_{10}(P)$  dB.

(3) Measurement procedure.

(i) Compliance with this provision is based on the use of measurement instrumentation employing a resolution bandwidth of 1 megahertz or greater. However, in the 1-megahertz bands immediately outside and adjacent to the licensee's frequency block, a resolution bandwidth of at least one percent of the emission bandwidth of the fundamental emission of the transmitter may be employed. The emission bandwidth is defined as the width of the signal between two points, one below the carrier center frequency and one above the carrier center frequency, outside of which all emissions are attenuated at least 26 dB below the transmitter power.

(ii) When measuring the emission limits, the nominal carrier frequency shall be adjusted as close to the licensee's frequency block edges, both upper and lower, as the design permits.

(iii) The measurements of emission power can be expressed in peak or average values, provided they are expressed in the same parameters as the transmitter power.

### 8.3.2 Test summary

---

Test date	May 7, 2024
Test engineer	Nimish Kapoor

---

### 8.3.3 Observations, settings and special notes

---

- The spectrum was searched from 30 MHz to the 10<sup>th</sup> harmonic.
- All measurements were performed using an average (RMS) detector per ANSI C63.26 Paragraph 5.7.2 method.
- Limit line ( $43 + 10 \log_{10}(P)$  or  $-13$  dBm) was adjusted for MIMO operation by 3 dB\*:  $-13$  dBm  $- 3$  dB =  $-13$  dBm  
\*MIMO correction factor for 2 antenna ports:  $10 \times \log_{10}(2) = 3$  dB
- RBW 1 MHz, VBW was wider than RBW.

8.3.4 Test data

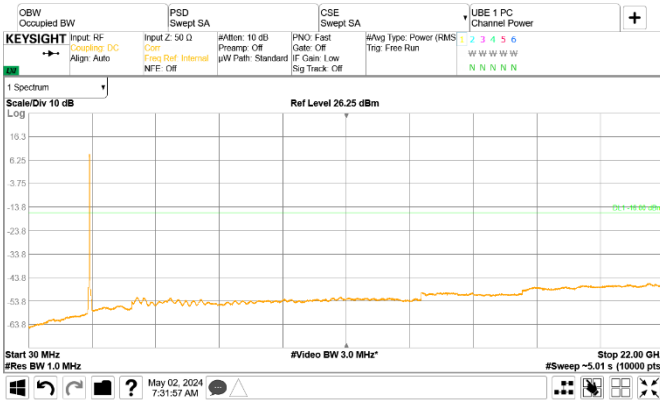

Figure 8.3-1: Conducted spurious emissions of NR 35 MHz low channel, single-carrier operation

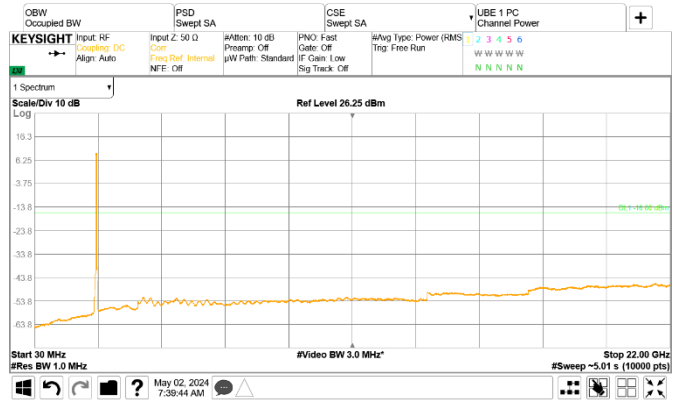

Figure 8.3-2: Conducted spurious emissions of NR 35 MHz mid channel, single-carrier operation

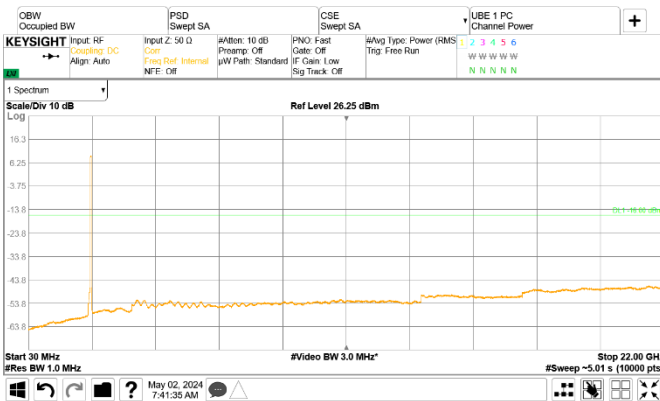

Figure 8.3-3: Conducted spurious emissions of NR 35 MHz high channel, single-carrier operation

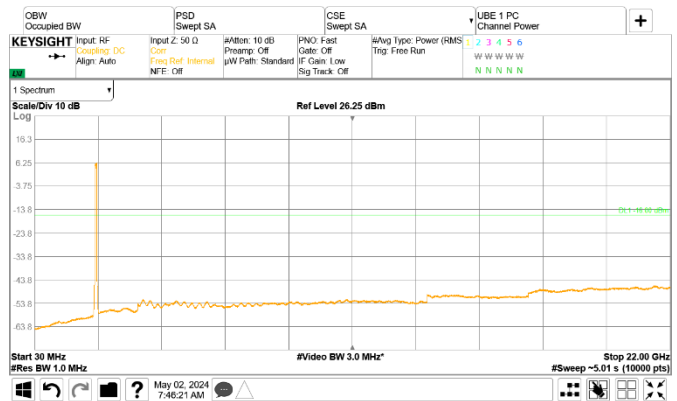

Figure 8.3-4: Conducted spurious emissions of NR 35 MHz two contiguous low channels, two-carrier operation

Test data, continued

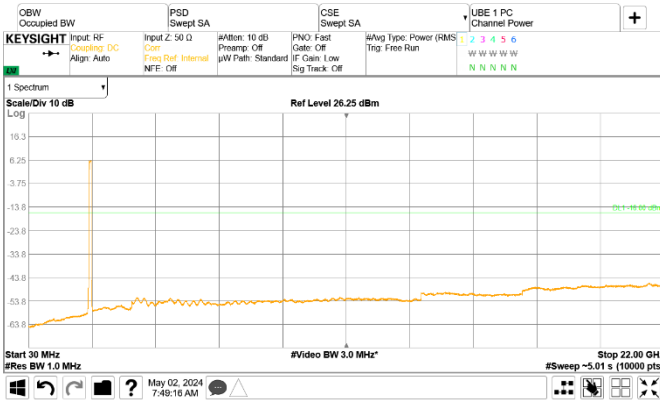

Figure 8.3-5: Conducted spurious emissions of NR 35 MHz two contiguous mid channels, two-carrier operation

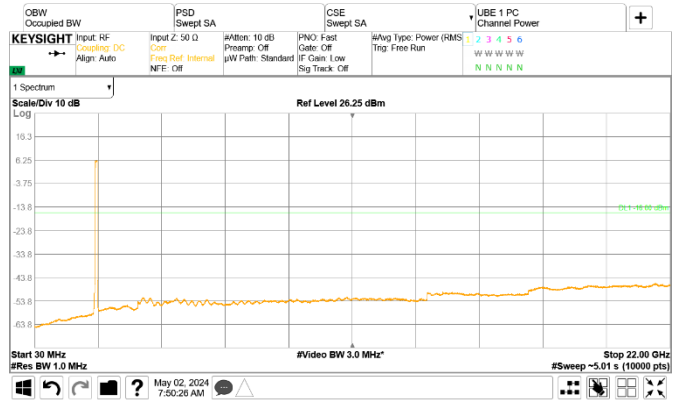

Figure 8.3-6: Conducted spurious emissions of NR 35 MHz two contiguous high channels, two-carrier operation

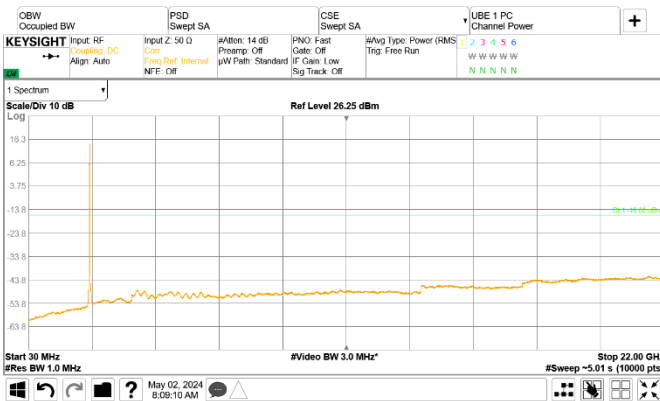

Figure 8.3-7: Conducted spurious emissions of multi-RAT operation, NR 35 MHz and LTE with loT1 5 MHz, low channel

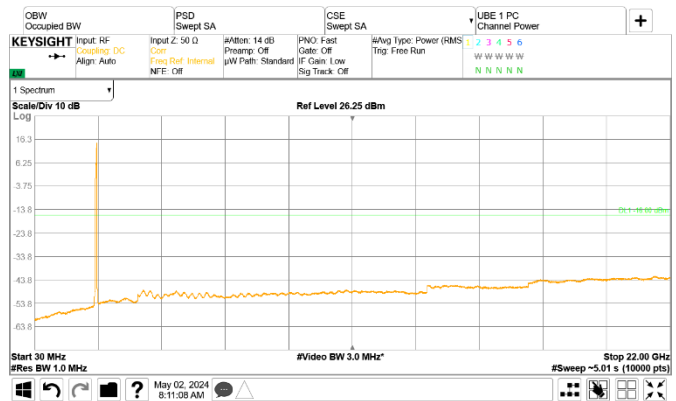

Figure 8.3-8: Conducted spurious emissions of multi-RAT operation, NR 35 MHz and LTE with loT1 5 MHz, mid channel

Note: “and”: non-contiguous channels; “+”: contiguous channels

Test data, continued

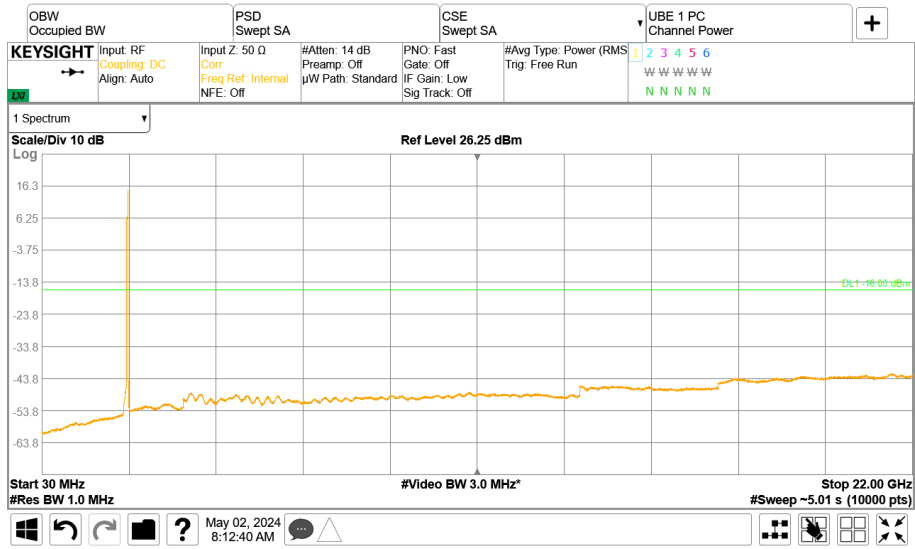

Figure 8.3-9: Conducted spurious emissions of multi-RAT operation, NR 35 MHz and LTE with IoT1 5 MHz, high channel

Note: "and": non-contiguous channels; "+": contiguous channels



Test data, continued

On the plots below the measured *Channel Power* value in the “*Total Channel Power*” column must be  $-16$  dBm and lower.



Figure 8.3-10: Conducted emission at the lower band edge

Frequency: 2110 MHz Mode: Single-carrier operation  
 Meas. BW: 1% of EBW Tech.: NR 35 MHz  
 Limit:  $-16$  dBm/350 kHz Notes: None



Figure 8.3-11: Conducted emission 1 MHz away from the lower band edge

Frequency: 2109 MHz Mode: Single-carrier operation  
 Meas. BW: 1 MHz Tech.: NR 35 MHz  
 Limit:  $-16$  dBm/MHz Notes: None



Figure 8.3-12: Conducted emission at the upper band edge

Frequency: 2200 MHz Mode: Single-carrier operation  
 Meas. BW: 1% of EBW Tech.: NR 35 MHz  
 Limit:  $-16$  dBm/350 kHz Notes: None

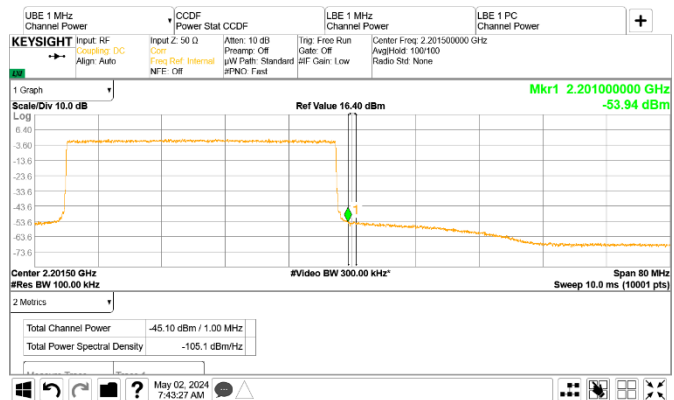

Figure 8.3-13: Conducted emission 1 MHz away from the upper band edge

Frequency: 2201 MHz Mode: Single-carrier operation  
 Meas. BW: 1 MHz Tech.: NR 35 MHz  
 Limit:  $-16$  dBm/MHz Notes: None

Test data, continued

On the plots below the measured *Channel Power* value in the “*Total Channel Power*” column must be  $-16$  dBm and lower.



Figure 8.3-14: Conducted emission at the lower band edge

Frequency: 2110 MHz Mode: Multi-carrier operation  
 Meas. BW: 1% of EBW Tech.:  $2 \times NR$  35 MHz  
 Limit:  $-16$  dBm/350 kHz Notes: None



Figure 8.3-15: Conducted emission 1 MHz away from the lower band edge

Frequency: 2109 MHz Mode: Multi-carrier operation  
 Meas. BW: 1 MHz Tech.:  $2 \times NR$  35 MHz  
 Limit:  $-16$  dBm/MHz Notes: None



Figure 8.3-16: Conducted emission at the upper band edge

Frequency: 2200 MHz Mode: Multi-carrier operation  
 Meas. BW: 1% of EBW Tech.:  $2 \times NR$  35 MHz  
 Limit:  $-16$  dBm/350 kHz Notes: None

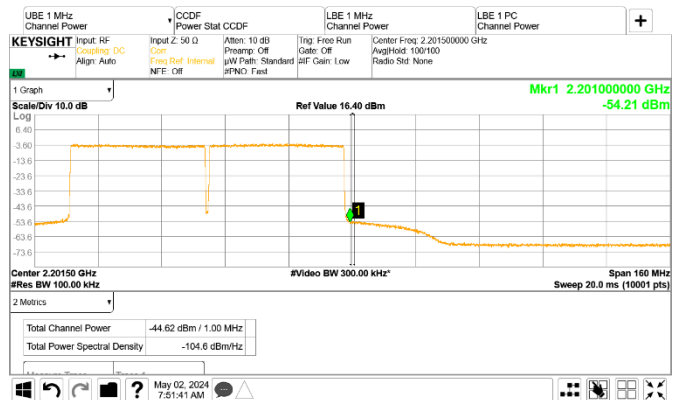

Figure 8.3-17: Conducted emission 1 MHz away from the upper band edge

Frequency: 2201 MHz Mode: Multi-carrier operation  
 Meas. BW: 1 MHz Tech.:  $2 \times NR$  35 MHz  
 Limit:  $-16$  dBm/MHz Notes: None

Test data, continued

On the plots below the measured *Channel Power* value in the “*Total Channel Power*” column must be  $-16$  dBm and lower.



Figure 8.3-18: Conducted emission at the lower band edge

Frequency: 2110 MHz  
 Meas. BW: 1% of EBW  
 Limit:  $-16$  dBm/350 kHz  
 Mode: Multi-RAT operation  
 Tech.: NR 35 MHz + LTE with IoT1 5 MHz  
 Notes: None



Figure 8.3-19: Conducted emission 1 MHz away from the lower band edge

Frequency: 2109 MHz  
 Meas. BW: 1 MHz  
 Limit:  $-16$  dBm/MHz  
 Mode: Multi-RAT operation  
 Tech.: NR 35 MHz + LTE with IoT1 5 MHz  
 Notes: None



Figure 8.3-20: Conducted emission at the upper band edge

Frequency: 2200 MHz  
 Meas. BW: 1% of EBW  
 Limit:  $-16$  dBm/50 kHz  
 Mode: Multi-RAT operation  
 Tech.: NR 35 MHz + LTE with IoT1 5 MHz  
 Notes: None

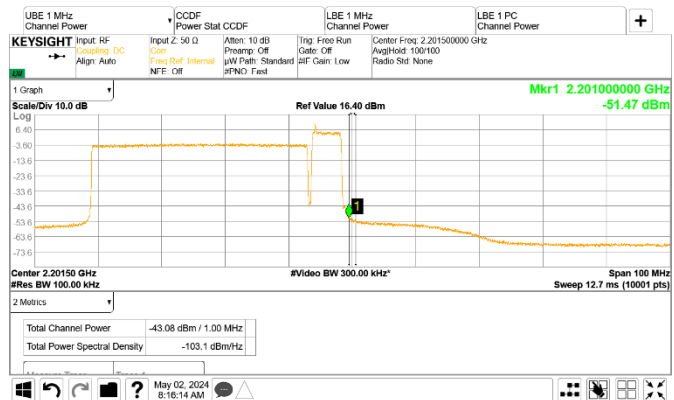

Figure 8.3-21: Conducted emission 1 MHz away from the upper band edge

Frequency: 2201 MHz  
 Meas. BW: 1 MHz  
 Limit:  $-16$  dBm/MHz  
 Mode: Multi-RAT operation  
 Tech.: NR 35 MHz + LTE with IoT1 5 MHz  
 Notes: None

Note: “and”: non-contiguous channels; “+”: contiguous channels

## 8.4 Spurious out-of-band emissions (Band 2/25)

---

### 8.4.1 Definitions and limits

---

**FCC §24.238(a):**

Out of band emissions. The power of any emission outside of the authorized operating frequency ranges must be attenuated below the transmitting power (P) by a factor of at least  $43 + 10 \log(P)$  dB.

(b) Measurement procedure. Compliance with these rules is based on the use of measurement instrumentation employing a resolution bandwidth of 1 MHz or greater. However, in the 1 MHz bands immediately outside and adjacent to the frequency block a resolution bandwidth of at least one percent of the emission bandwidth of the fundamental emission of the transmitter may be employed. A narrower resolution bandwidth is permitted in all cases to improve measurement accuracy provided the measured power is integrated over the full required measurement bandwidth (i.e. 1 MHz or 1 percent of emission bandwidth, as specified). The emission bandwidth is defined as the width of the signal between two points, one below the carrier center frequency and one above the carrier center frequency, outside of which all emissions are attenuated at least 26 dB below the transmitter power.

### 8.4.2 Test summary

---

Test date	May 2, 2024
Test engineer	Nimish Kapoor

---

### 8.4.3 Observations, settings and special notes

---

- The spectrum was searched from 30 MHz to the 10<sup>th</sup> harmonic.
- All measurements were performed using an average (RMS) detector per ANSI C63.26 Paragraph 5.7.2 method.
- Limit line ( $43 + 10 \log_{10}(P)$  or -13 dBm) was adjusted for MIMO operation by 3 dB\*: -13 dBm - 3 dB = -16 dBm  
\*MIMO correction factor for 2 antenna ports:  $10 \times \log_{10}(2) = 3$  dB
- RBW 1 MHz, VBW was wider than RBW.

8.4.4 Test data

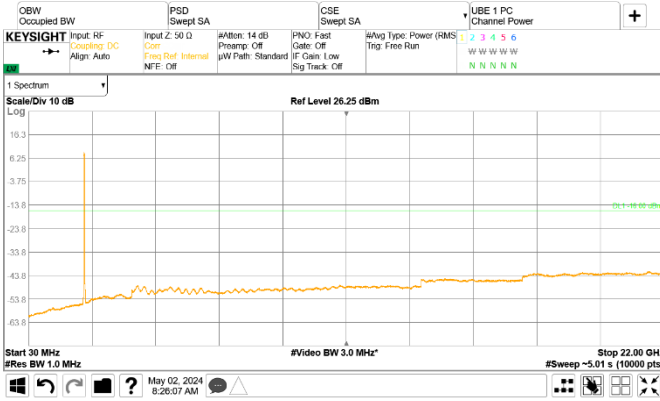

Figure 8.4-1: Conducted spurious emissions of NR 35 MHz low channel, single-carrier operation

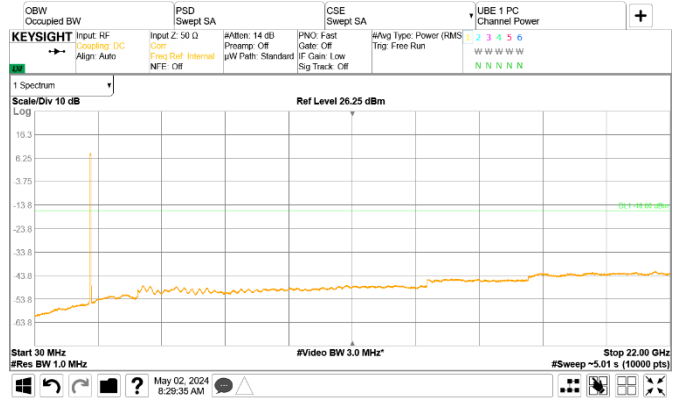

Figure 8.4-2: Conducted spurious emissions of NR 35 MHz mid channel, single-carrier operation

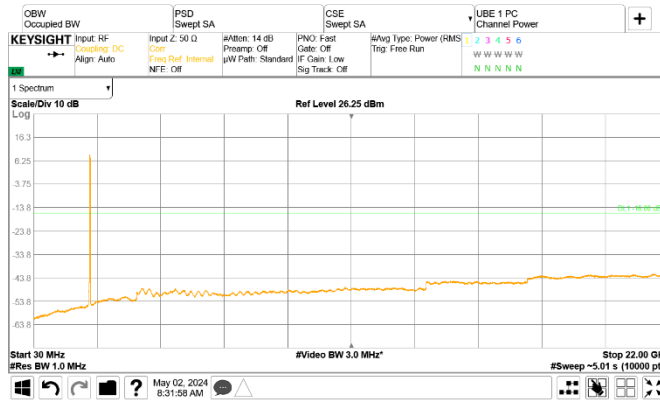

Figure 8.4-3: Conducted spurious emissions of NR 35 MHz top channel, single-carrier operation

Test data, continued

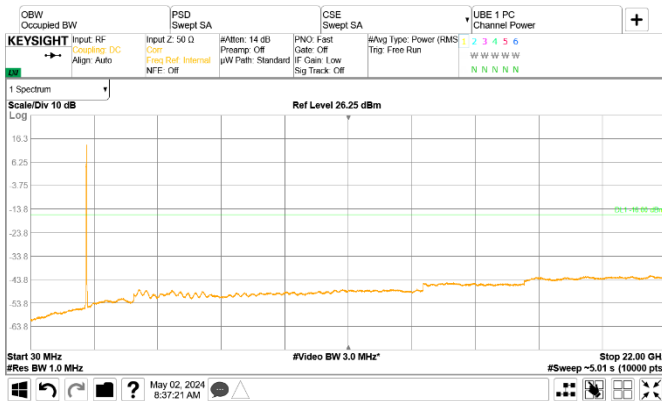

Figure 8.4-4: Conducted spurious emissions of multi-RAT operation, NR 35 MHz + LTE with IoT1 5 MHz, Low Channel

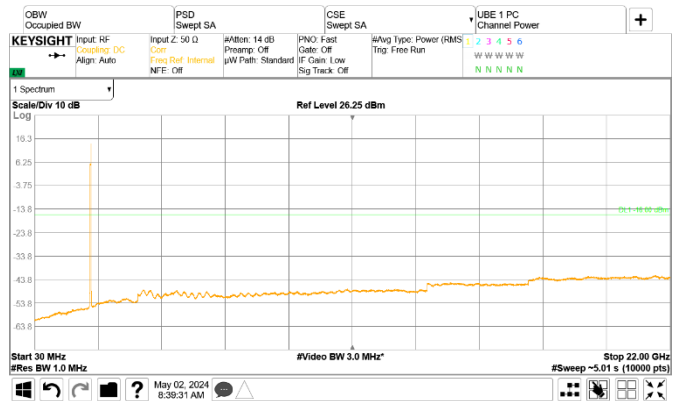

Figure 8.4-5: Conducted spurious emissions of multi-RAT operation, NR 35 MHz + LTE with IoT1 5 MHz, Mid Channel

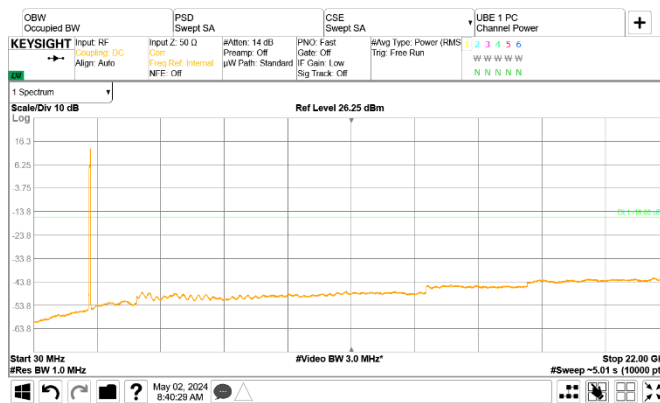

Figure 8.4-6: Conducted spurious emissions of multi-RAT operation, NR 35 MHz + LTE with IoT1 5 MHz, High Channel

Note: "and": non-contiguous channels; "+": contiguous channels

Test data, continued

On the plots below the measured *Channel Power* value in the “*Total Channel Power*” column must be  $-16$  dBm and lower.



Figure 8.4-7: Conducted emission at the lower band edge

Frequency: 1930 MHz Mode: Single carrier operation  
 Meas. BW: 1% of EBW Tech.: NR 35 MHz  
 Limit:  $-16$  dBm/350 kHz Notes: None



Figure 8.4-8: Conducted emission 1 MHz away from the lower band edge

Frequency: 1929 MHz Mode: Single carrier operation  
 Meas. BW: 1 MHz Tech.: NR 35 MHz  
 Limit:  $-16$  dBm/MHz Notes: None



Figure 8.4-9: Conducted emission at the upper band edge

Frequency: 1995 MHz Mode: Single carrier operation  
 Meas. BW: 1% of EBW Tech.: NR 35 MHz  
 Limit:  $-16$  dBm/350 kHz Notes: None

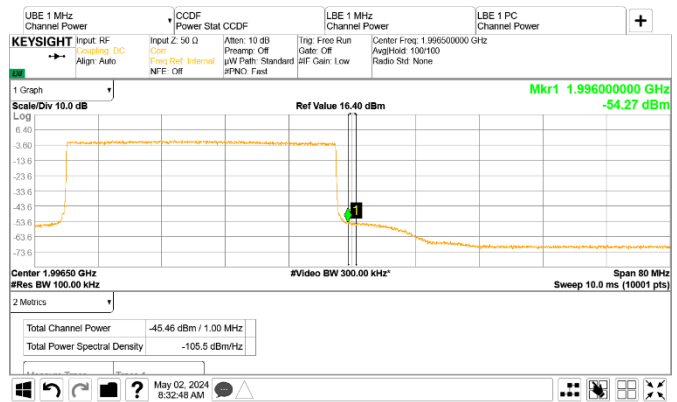

Figure 8.4-10: Conducted emission 1 MHz away from the upper band edge

Frequency: 1996 MHz Mode: Single carrier operation  
 Meas. BW: 1 MHz Tech.: NR 35 MHz  
 Limit:  $-16$  dBm/MHz Notes: None

Test data, continued

On the plots below the measured *Channel Power* value in the “*Total Channel Power*” column must be  $-16$  dBm and lower.



Figure 8.4-11: Conducted emission at the lower band edge

Frequency: 1930 MHz      Mode: Multi-RAT operation  
 Meas. BW: 1% of EBW      Tech.: NR 35 MHz + LTE with IoT1 5 MHz  
 Limit:  $-16$  dBm/350 kHz      Notes: None



Figure 8.4-12: Conducted emission 1 MHz away from the lower band edge

Frequency: 1929 MHz      Mode: Multi-RAT operation  
 Meas. BW: 1 MHz      Tech.: NR 35 MHz + LTE with IoT1 5 MHz  
 Limit:  $-16$  dBm/MHz      Notes: None



Figure 8.4-13: Conducted emission at the upper band edge

Frequency: 1930 MHz      Mode: Multi-RAT operation  
 Meas. BW: 1% of EBW      Tech.: NR 35 MHz + LTE with IoT1 5 MHz  
 Limit:  $-16$  dBm/50 kHz      Notes: None

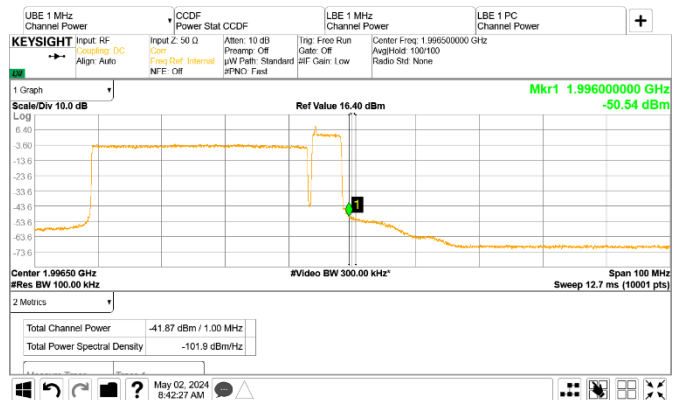

Figure 8.4-14: Conducted emission 1 MHz away from the upper band edge

Frequency: 1929 MHz      Mode: Multi-RAT operation  
 Meas. BW: 1 MHz      Tech.: NR 35 MHz + LTE with IoT1 5 MHz  
 Limit:  $-16$  dBm/MHz      Notes: None

Note: “and”: non-contiguous channels; “+”: contiguous channels



## 8.5 Occupied bandwidth (Band 66)

### 8.5.1 Definitions and limits

#### FCC §2.1049:

The occupied bandwidth, that is the frequency bandwidth such that, below its lower and above its upper frequency limits, the mean powers radiated are each equal to 0.5 percent of the total mean power radiated by a given emission

### 8.5.2 Test summary

Test date	May 2, 2024
Test engineer	Nimish Kapoor

### 8.5.3 Observations, settings and special notes

Testing was performed per ANSI C63.26 Paragraphs 5.4.3 and 5.4.4 methods.

Spectrum analyzer settings:

Detector mode	Peak
Resolution bandwidth	$\geq 1\%$ of EBW
Video bandwidth	RBW $\times 3$
Trace mode	Max Hold

### 8.5.4 Test data

**Table 8.5-1: Occupied bandwidth results for NR 35 MHz channel**

Remarks	Frequency, MHz	26 dB BW, MHz	99% OBW, MHz
35 MHz, Low channel	2127.5	34.760	33.403
35 MHz, Mid channel	2155.0	34.800	33.478
35 MHz, Top channel	2182.5	34.740	33.490

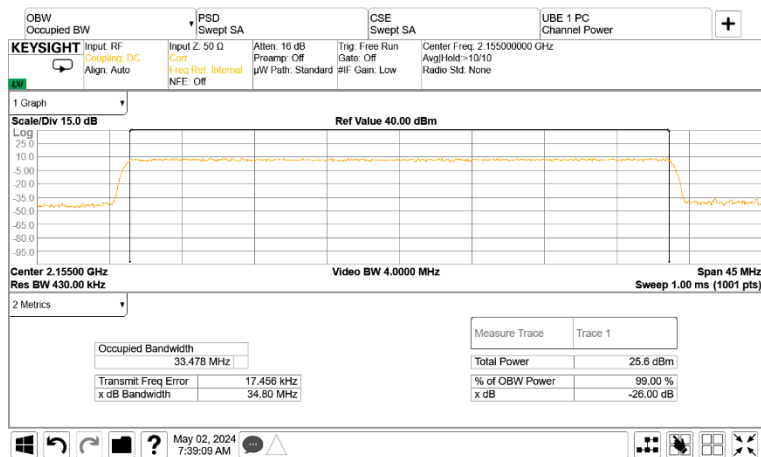

**Figure 8.5-1: Sample plot for NR 40 MHz channel**

## 8.6 Occupied bandwidth (Band 2/25)

### 8.6.1 Definitions and limits

#### FCC §2.1049:

The occupied bandwidth, that is the frequency bandwidth such that, below its lower and above its upper frequency limits, the mean powers radiated are each equal to 0.5 percent of the total mean power radiated by a given emission

### 8.6.2 Test summary

Test date	May 2, 2024
Test engineer	Nimish Kapoor

### 8.6.3 Observations, settings and special notes

Testing was performed per ANSI C63.26 Paragraphs 5.4.3 and 5.4.4 methods.

Spectrum analyzer settings:

Detector mode	Peak
Resolution bandwidth	$\geq 1\%$ of EBW
Video bandwidth	RBW $\times 3$
Trace mode	Max Hold

### 8.6.4 Test data

**Table 8.6-1: Occupied bandwidth results for NR 35 MHz channel**

Remarks	Frequency, MHz	26 dB BW, MHz	99% OBW, MHz
35 MHz, Low channel	1947.5	34.770	33.425
35 MHz, Mid channel	1962.5	34.790	33.517
35 MHz, Top channel	1977.5	34.790	33.465

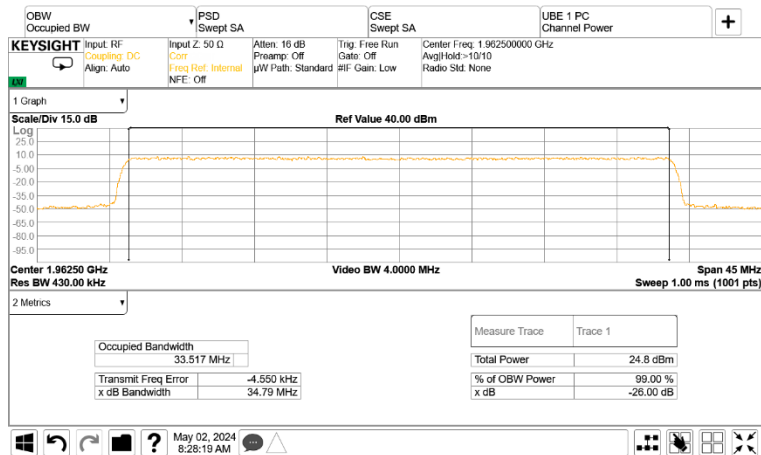

**Figure 8.6-1: Sample plot for NR 35 MHz channel**

## Section 9. Block diagrams of test setups

---

### 9.1 Antenna port set-up

---

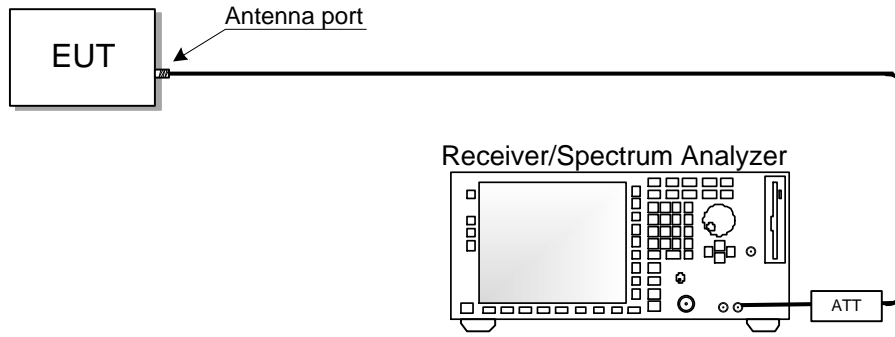

End of the test report