



Product Service

**Choose certainty.
Add value.**

Report On

FCC and Industry Canada Testing of the
Ericsson RRUS 11 B4 / KRC 161 254/2

COMMERCIAL-IN-CONFIDENCE

FCC ID: TA8BKRC161254-2

IC ID: 287AB-BS1612542

Document 75924767 Report 03 Issue 1

February 2014



Product Service

TÜV SÜD Product Service, Octagon House, Concorde Way, Segensworth North,
Fareham, Hampshire, United Kingdom, PO15 5RL
Tel: +44 (0) 1489 558100. Website: www.tuv-sud.co.uk

COMMERCIAL-IN-CONFIDENCE

REPORT ON FCC and Industry Canada Testing of the
Ericsson RRUS 11 B4 / KRC 161 254/2

Document 75924767 Report 03 Issue 1

February 2014

PREPARED FOR Ericsson AB
Isafjordsgatan 10
SE-164 80
Stockholm
Sweden

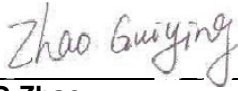
PREPARED BY 
G Zhao
Test Engineer

APPROVED BY 
Simon Bennett
Authorised Signatory

DATED 21 February 2014

ENGINEERING STATEMENT

The measurements shown in this report were made in accordance with the procedures described on test pages. All reported testing was carried out on a sample equipment to demonstrate compliance with FCC CFR 47: Part 27 and Industry Canada RSS-139. The sample tested was found to comply with the requirements defined in the applied rules.

Test Engineer(s);

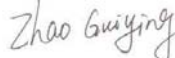
G Zhao

X Zhang





CONTENTS

Section	Page No
1	REPORT SUMMARY 3
1.1	Introduction 4
1.2	Brief Summary of Results 5
1.3	Declaration of Build Status 7
1.4	Product Information 8
1.5	Test Conditions 13
1.6	Deviations From the Standard 13
1.7	Modification Record 13
1.8	Alternative Test Site 13
2	TEST DETAILS 14
2.1	RF Output Power - Conducted 15
2.2	Peak – Average Ratio 18
2.3	Modulation Characteristics 29
2.4	Occupied Bandwidth 32
2.5	Spurious Emissions at Antenna Terminals (± 1 MHz) 38
2.6	Radiated Spurious Emissions 52
2.7	Conducted Spurious Emissions 57
2.8	Frequency Stability Under Temperature Variations 65
2.9	Frequency Stability Under Voltage Variations 67
3	TEST EQUIPMENT USED 69
3.1	Test Equipment Used 70
3.2	Measurement Uncertainty 72
4	ACCREDITATION, DISCLAIMERS AND COPYRIGHT 73
4.1	Accreditation, Disclaimers and Copyright 74



SECTION 1

REPORT SUMMARY

FCC and Industry Canada Testing of the
Ericsson RRUS 11 B4 / KRC 161 254/2



1.1 INTRODUCTION

The information contained in this report is intended to show verification of the Ericsson RRUS 11 B4 / KRC 161 254/2 to the requirements of FCC CFR 47 Part 27 and Industry Canada RSS-139.

Testing was carried out in support of an application for Grant of RRUS 11 B4 / KRC 161 254/2 in CDMA mode.

Objective	To perform FCC and Industry Canada Testing to determine the Equipment Under Test's (EUT's) compliance with the Test Specification, for the series of tests carried out.
Manufacturer	Ericsson AB
Product Name	RRUS 11 B4
Part Number	KRC 161 254/2
IC Model Number	BS1612542
Serial Number(s)	CF81442849
RBS Software	CXP102051/16 Rev R32BD
PIS Software	CXP9017316/1 Rev R39UL
Hardware Version	R2B
Number of Samples Tested	1
Test Specification/Issue/Date	FCC CFR 47 Part 27: 2013 Industry Canada RSS-139 Issue 2: 2009
Incoming Release Date	Declaration of Build Status 21 October 2013
Order Number Date	PTP 19 October 2013
Start of Test	04 November 2013
Finish of Test	13 February 2014
Name of Engineer(s)	G Zhao X Zhang
Related Document(s)	ANSI C63.4: 2009 FCC CFR 47 Part 2: 2013 Industry Canada RSS-GEN Issue 3: 2010 Industry Canada SRSP513 Issue 2: 2009



1.2 BRIEF SUMMARY OF RESULTS

A brief summary of results in accordance with FCC CFR 47 Part 27 and Industry Canada RSS-139, is shown below.

Configuration 1 – Remote Radio Equipment							
Section	Spec Clause		Test Description	Mode	Mod State	Result	Comments
	FCC Part 2 and 27	RSS-139 and RSS-GEN					
	27.50 (d)	6.4	Effective Radiated Power	2111.25MHz		N/A	No integral antenna.
				2132.50MHz		N/A	
				2153.75MHz		N/A	
				2111.25MHz+2112.50MHz		N/A	
				2132.50MHz+2133.75MHz		N/A	
				2152.50MHz+2153.75MHz		N/A	
2.1	2.1046, 27.50 (d)	6.4	RF Output Power - Conducted	2111.25MHz	0	Pass	-
				2132.50MHz	0	Pass	
				2153.75MHz	0	Pass	
				2111.25MHz+2112.50MHz	0	Pass	
				2132.50MHz+2133.75MHz	0	Pass	
				2152.50MHz+2153.75MHz	0	Pass	
2.2	27.50 (i)	6.4	Peak – Average Ratio	2111.25MHz	0	Pass	-
				2132.50MHz	0	Pass	
				2153.75MHz	0	Pass	
				2111.25MHz+2112.50MHz	0	Pass	
				2132.50MHz+2133.75MHz	0	Pass	
				2152.50MHz+2153.75MHz	0	Pass	
2.3	2.1047 (d)	6.2	Modulation Characteristics	2132.50MHz	0	Pass	-
2.4	2.1049, 27.53 (h)	RSS-Gen 4.6.1	Occupied Bandwidth	2111.25MHz	0	Pass	-
				2132.50MHz	0	Pass	
				2153.75MHz	0	Pass	
				2111.25MHz+2112.50MHz		N/A	
				2132.50MHz+2133.75MHz		N/A	
				2152.50MHz+2153.75MHz		N/A	



Configuration 1 – Remote Radio Equipment							
Section	Spec Clause		Test Description	Mode	Mod State	Result	Comments
	FCC Part 2 and 27	RSS-139 and RSS-GEN					
2.5	2.1051, 27.53 (h)	6.5	Spurious Emissions at Antenna Terminals (± 1 MHz)	2111.25MHz	0	Pass	-
				2132.50MHz		N/A	
				2153.75MHz	0	Pass	
				2111.25MHz+2112.50MHz	0	Pass	
				2132.50MHz+2133.75MHz		N/A	
				2152.50MHz+2153.75MHz	0	Pass	
2.6	2.1053, 27.53 (h)	6.5	Radiated Spurious Emissions	2111.25MHz	0	Pass	-
				2132.50MHz	0	Pass	
				2153.75MHz	0	Pass	
				2111.25MHz+2112.50MHz	0	Pass	
2.7	2.1051, 27.53 (h)	6.5	Conducted Spurious Emissions	2111.25MHz	0	Pass	-
				2132.50MHz	0	Pass	
				2153.75MHz	0	Pass	
				2123.15MHz+2141.85MHz	0	Pass	
2.8	2.1055, 27.54	6.3	Frequency Stability Under Temperature Variations	2132.50MHz	0	Pass	-
2.9	2.1055, 27.54	6.3	Frequency Stability Under Voltage Variations	2132.50MHz	0	Pass	-

N/A – Not Applicable



1.3 DECLARATION OF BUILD STATUS

MAIN EUT	
MANUFACTURING DESCRIPTION	Remote Radio Equipment
MANUFACTURER	Ericsson AB
PRODUCT NAME	RRUS 11 B4
PART NUMBER	KRC 161 254/2
IC Model Number	BS1612542
SERIAL NUMBER(s)	CF81442849
HARDWARE VERSION	R2B
RBS SOFTWARE	CXP102051/16 Rev R32BD
PIS SOFTWARE	CXP9017316/1 Rev R39UL
TRANSMITTER OPERATING RANGE	TX: 2110MHz - 2155MHz RX: 1710MHz - 1755MHz
MODULATIONS	QPSK, 8PSK, 16QAM
ITU DESIGNATION OF EMISSION	1M25F9W
CHANNEL BANDWIDTH	1.25 MHz
OUTPUT POWER (RMS) (W or dBm)	Single Carrier: 1 x 46.0dBm per port (1 x 40W per port) Multi Carrier (x 2): 2 x 43.0.dBm per port (2 x 20W per port)
OUTPUT POWER TOLERANCE	± 2.0dB
ANTENNA	No dedicated antenna, handled during licensing
NUMBER OF ANTENNA PORTS	2 TX/ RX ports
SUPPORTED CONFIGURATION	Dual Single Carrier or Multi Carrier. Both RF chains are identical.
FCC ID	TA8BKRC161254-2
IC ID	287AB-BS1612542
TECHNICAL DESCRIPTION (a brief description of the intended use and operation)	The equipment is the Radio Part of CDMA Base Station.

Signature

Date

15 November 2013

D of B S Serial No

75924767/03

No responsibility will be accepted by TÜV SÜD Product Service as to the accuracy of the information declared in this document by the manufacturer.



Product Service

1.4 PRODUCT INFORMATION

1.4.1 Technical Description

The Equipment Under Test (EUT) RRUS 11 B4 / KRC 161 254/2 is an Ericsson Radio Equipment working in the public mobile service 2100MHz band which provides communication connections to CDMA network. The RRUS 11 B4 / KRC 161 254/2 operates from a -48V DC supply.

The Equipment Under Test (EUT) is shown in the photograph below. A full technical description can be found in the Manufacturers documentation.



Equipment Under Test



1.4.2 Test Configuration

Configuration 1: Radio Equipment

The EUT was configured in accordance with FCC CFR 47 Part 27 and Industry Canada RSS-139.

The RRUS 11 B4 / KRC 161 254/2 supports CDMA with QPSK, 8PSK and 16QAM modulations at 2100MHz. The settings below were found to be representative for all traffic scenarios when several settings, with different modulations and number of carriers, were tested to find the worst case settings. After the measured results were compared, the following settings were used for all measurements unless otherwise noted:

- Single carrier:
QPSK Modulation
Forward Traffic Channel using Spreading Rate 1 (1X), Voice
User Channels: 6
Channel rate: 9.6kbps
Channel bandwidth: 1.25MHz

For other modulations, the settings are as follows:

- 8PSK Modulation: High Rate Packet Data
User Channels: 14
Channel rate: 921.6kbps
- 16QAM Modulation: High Rate Packet Data
User Channels: 14
Channel rate: 2457.6kbps

Channel bandwidth: 1.25MHz

The EUT has two TX/RX ports and it can be configured to transmit with 2100MHz single or multi carrier at both RF output connectors. All TX measurements were performed on the combined TX/RX output connector RF A. Limited complementary TX measurements were done at connector RF B to verify identical performance for both transmitter chains. The complete testing was performed with the EUT transmitting at maximum RF power unless otherwise stated.

The EUT was powered by a -48V DC Power supply.



Test Setup, Conducted Measurement:

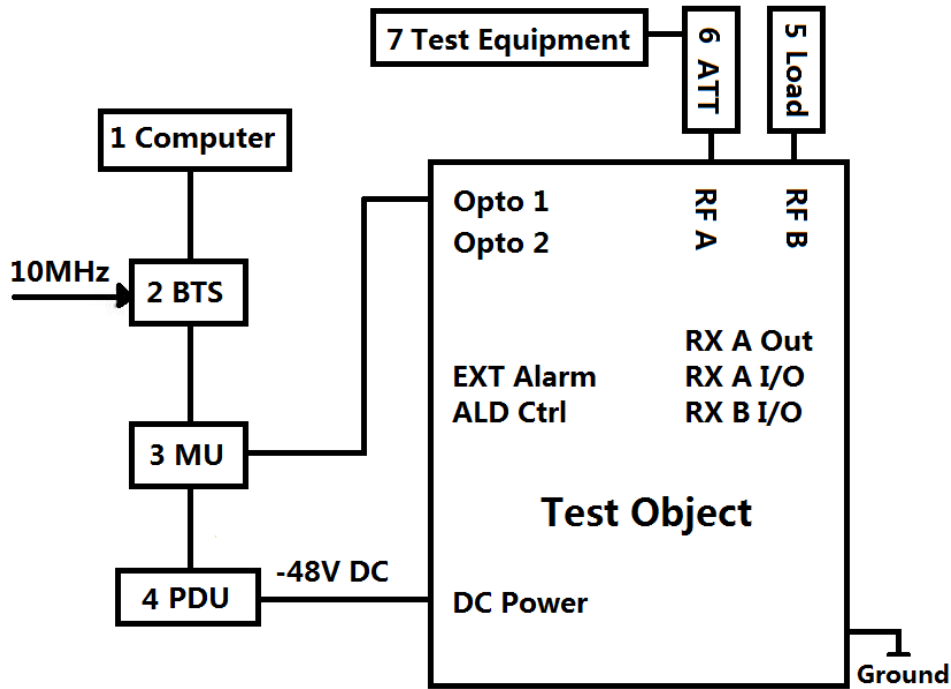

Product Name	Product Number	Version	Serial Number
RRUS 11 B4	KRC 161 254/2	R2B	CF81442849

No.	Auxiliary Equipment	Part Number / Model Type	Version	Serial Number
1	Computer	HP EliteBook 8460p	--	AP523464
2	DBA	NTLK90AAE5	09	NNTMPX00VD94
	XCEM-A	NTLK79AAE5	01	NNTMPX00JCKF
	AEM1302	NTLK85GAE5	07	NNTMPX00VRY4
	AEM1302	NTLK85GAE5	07	NNTMPX00RV3M
3	RBS 6601	BFL 901 009/1	--	--
	XMU 02 01	KDU137 745/1	R2A	C825513800
	SUP 6601	1/BFL 901 009/1	R3B	BR81262578
4	Power Supply	DH1716-5D	--	2008040041
	Power Supply	DH1716-5D	--	2008040050
5	Load	TF100	--	09121648
6	40dB Attenuator	48-40-43-LIM	--	BR5020
7	Power Meter	Rohde & Schwarz NRP2	--	101593
	Power Sensor	Rohde & Schwarz NRP-Z51	--	102123
	Spectrum Analyzer	FSQ26	--	101127
	Spectrum Analyzer	FSQ26	--	100253



Test Setup, Radiated Measurement:

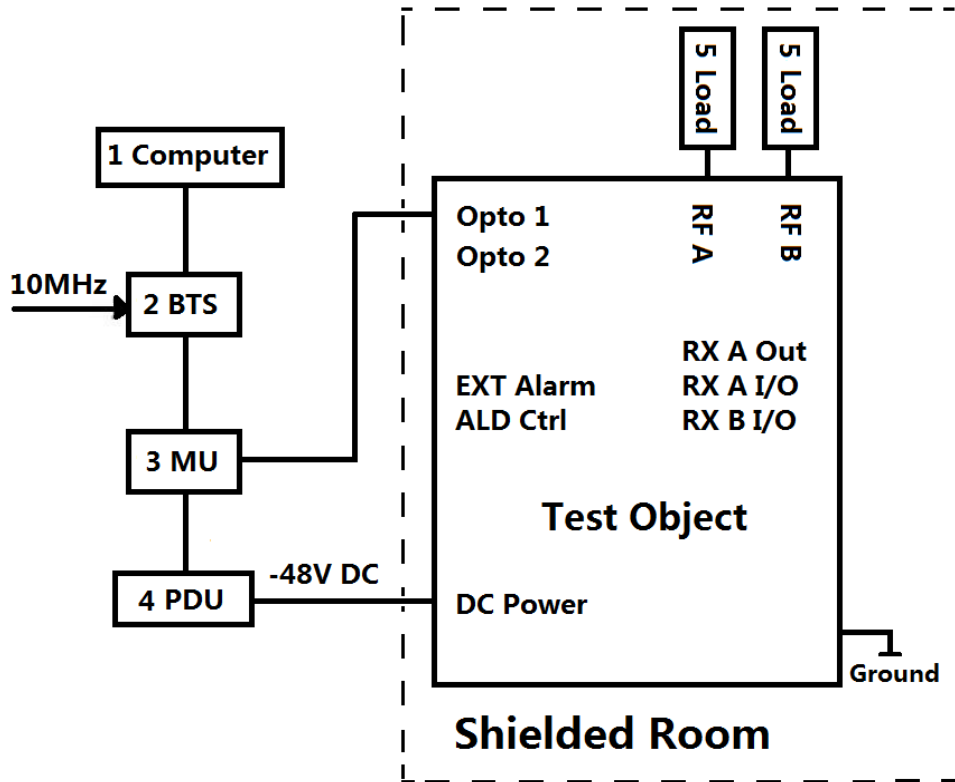

Product Name	Product Number	Version	Serial Number
RRUS 11 B4	KRC 161 254/2	R2B	CF81442849

No.	Auxiliary Equipment	Part Number / Model Type	Version	Serial Number
1	Computer	HP EliteBook 8460p	--	AP523464
2	DBA	NTLK90AAE5	09	NNTMPX00VD94
	XCEM-A	NTLK79AAE5	01	NNTMPX00JCKF
	AEM1302	NTLK85GAE5	07	NNTMPX00VRY4
	AEM1302	NTLK85GAE5	07	NNTMPX00RV3M
3	RBS 6601	BFL 901 009/1	--	--
	XMU 02 01	KDU137 745/1	R2A	C825513800
	SUP 6601	1/BFL 901 009/1	R3B	BR81262578
4	Power Supply	DH1716-5D	--	2008040041
	Power Supply	DH1716-5D	--	2008040050
5	Load	TF100	--	09121648
	Load	TF100	--	09121605



1.4.3 Modes of Operation

Modes of operation of each EUT during testing were as follows:

Mode 1 - Channel No. 25: 2111.25MHz (Bottom Channel)

Mode 2 - Channel No. 450: 2132.50MHz (Middle Channel)

Mode 3 - Channel No. 875: 2153.75MHz (Top Channel)

Mode 4 - Channel No. 25 + 50: 2111.25MHz + 2112.50MHz (B and B+1.25MHz)

Mode 5 - Channel No. 450 + 475: 2132.50MHz + 2133.75MHz (M and M+1.25MHz)

Mode 6 - Channel No. 850 + 875: 2152.50MHz + 2153.75MHz (T-1.25MHz and T)

Mode 7 - Channel No. 263 + 637: 2123.15MHz + 2141.85MHz (M-9.35MHz and M+9.35MHz)

Information on the specific test modes utilised are detailed in the test procedure for each individual test.



1.5 TEST CONDITIONS

For all tests the EUT was set up in accordance with the relevant test standard and to represent typical operating conditions. Tests were applied with the EUT situated in a shielded enclosure, test laboratories or an open test area as appropriate.

The EUT was powered from a -48V DC supply.

1.6 DEVIATIONS FROM THE STANDARD

No deviations from the applicable test standards or test plan were made during testing.

1.7 MODIFICATION RECORD

Mod State 0 - No modifications were made to the EUT during testing.

1.8 ALTERNATIVE TEST SITE

Under our group UKAS Accreditation, TÜV SÜD Product Service conducted the following tests at Ericsson in Beijing, China:

- RF Output Power – Conducted
- Peak - Average Ratio
- Modulation Characteristics
- Occupied Bandwidth
- Spurious Emissions at Antenna Terminals (± 1 MHz)
- Conducted Spurious Emissions
- Frequency Stability

Only Radiated Spurious Emission Testing has been performed under the following site registrations:

FCC Accreditation 910917:

The State Radio Monitoring Centre, No.80 Beilishi Road Xicheng District Beijing, China.

Industry Canada Accreditation 7308A-1:

The State Radio Monitoring Centre, No.80 Beilishi Road Xicheng District Beijing, China.



Product Service

SECTION 2

TEST DETAILS

FCC and Industry Canada Testing of the
Ericsson RRUS 11 B4 / KRC 161 254/2



Product Service

2.1 RF OUTPUT POWER - CONDUCTED

2.1.1 Specification Reference

FCC CFR 47 Part 2, Clause 2.1046
 FCC CFR 47 Part 27, Clause 27.50 (d)
 Industry Canada RSS-139, Clause 6.4

2.1.2 Equipment Under Test

RRUS 11 B4 / KRC 161 254/2, S/N: CF81442849

2.1.3 Date of Test and Modification State

04, 05 and 06 November 2013 – Modification State 0

2.1.4 Test Equipment Used

The major items of test equipment used for the below tests are identified in Section 3.1.

2.1.5 Test Method and Operating Modes

The test was applied in accordance with the test method requirements of FCC CFR 47 Part 2 and Part 27 and Industry Canada RSS-139.

Using a power meter and attenuator(s), the output power of the EUT was measured at the antenna terminal. The carrier power was measured with QPSK, 8PSK and 16QAM modulations.

The path loss was measured and entered to the power meter as a reference level offset to get the output power value directly.

The test was performed with the EUT in the following configurations and modes of operation:

Configuration 1 - Mode 1
 - Mode 2
 - Mode 3
 - Mode 4
 - Mode 5
 - Mode 6

2.1.6 Environmental Conditions

	04 November 2013	05 November 2013	06 November 2013
Ambient Temperature	23.5°C	23.0°C	23.5°C
Relative Humidity	41.0%	47.0%	46.0%



2.1.7 Test Results

For the period of test the EUT met the requirements of FCC CFR 47 Part 2 and Part 27 and Industry Canada RSS-139 for RF Output Power.

The test results are shown below

Single Carrier

Configuration 1 - Mode 1, 2 and 3

QPSK

Channel No.	Frequency (MHz)	Result (dBm) RMS	Result (dBm/MHz ¹) RMS	Result (W) RMS
25 (Bottom)	2111.25	45.61	44.64	36.39
450 (Middle)	2132.50	45.96	44.99	39.45
875 (Top)	2153.75	45.95	44.98	39.36

Note 1:

1 MHz Power =Output Power - 10lg(OBW/1)=Output Power - 10lg(1.25) =Output Power - 0.97

8PSK

Channel No.	Frequency (MHz)	Result (dBm) RMS	Result (dBm/MHz ¹) RMS	Result (W) RMS
25 (Bottom)	2111.25	45.51	44.54	35.56
450 (Middle)	2132.50	46.00	45.03	39.81
875 (Top)	2153.75	45.91	44.94	38.99

Note 1:

1 MHz Power =Output Power - 10lg(OBW/1)=Output Power - 10lg(1.25) =Output Power - 0.97

16QAM

Channel No.	Frequency (MHz)	Result (dBm) RMS	Result (dBm/MHz ¹) RMS	Result (W) RMS
25 (Bottom)	2111.25	45.57	44.60	36.06
450 (Middle)	2132.50	46.02	45.05	39.99
875 (Top)	2153.75	45.96	44.99	39.45

Note 1:

1 MHz Power =Output Power - 10lg(OBW/1)=Output Power - 10lg(1.25) =Output Power - 0.97

**Multi Carrier (1x2)**Configuration 1 - Mode 4, 5 and 6QPSK

Channel No.	Frequency (MHz)	Result (dBm) RMS	Result (W) RMS
25 & 50	2111.25 & 2112.50	45.60	36.31
450 & 475	2132.50 & 2133.75	45.99	39.72
850 & 875	2152.50 & 2153.75	45.96	39.45

8PSK

Channel No.	Frequency (MHz)	Result (dBm) RMS	Result (W) RMS
25 & 50	2111.25 & 2112.50	45.61	36.39
450 & 475	2132.50 & 2133.75	46.02	39.99
850 & 875	2152.50 & 2153.75	45.94	39.26

16QAM

Channel No.	Frequency (MHz)	Result (dBm) RMS	Result (W) RMS
25 & 50	2111.25 & 2112.50	45.60	36.31
450 & 475	2132.50 & 2133.75	46.03	40.09
850 & 875	2152.50 & 2153.75	46.01	39.90

This unit was tested without an antenna. ERP/EIRP compliance is addressed at the time of licensing, as required by the responsible FCC/IC Bureau(s). Licensees are required to take into account maximum allowed antenna gain used in combination with above power settings to prevent the radiated output power to exceed the limits.

Limit	$\leq 1640\text{W/MHz}$ or $\leq +62.1\text{dBm/MHz}$
-------	---

Remarks

The EUT does not exceed 1640W/MHz or 62.1dBm/MHz at the measured frequencies.



2.2 PEAK – AVERAGE RATIO

2.2.1 Specification Reference

FCC CFR 47 Part 27, Clause 27.50 (d)(5)
Industry Canada RSS-139, Clause 6.4

2.2.2 Equipment Under Test

RRUS 11 B4 / KRC 161 254/2, S/N: CF81442849

2.2.3 Date of Test and Modification State

04, 05 and 06 November 2013 – Modification State 0

2.2.4 Test Equipment Used

The major items of test equipment used for the below tests are identified in Section 3.1.

2.2.5 Test Method and Operating Modes

The test was applied in accordance with the test method requirements of FCC CFR 47 Part 27 and Industry Canada RSS-139.

A peak to average ratio measurement is performed at the conducted port of the EUT. The spectrum analyzers Complementary Cumulative Distribution Function (CCDF) measurement profile is used to determine the largest deviation between the average and the peak power of the EUT in given bandwidth. The CCDF curve shows how much time the peak waveform spends at or above a given average power level. The percent of time the signal spends at or above the level defines the probability for that particular power level.

The Peak to Average was measured with QPSK, 8PSK, 16QAM using the test models described.

The spectrum analyzer Measurement bandwidth was set 50MHz for single and multi carrier, and the path loss measured was entered as a reference level offset.

The test was performed with the EUT in the following configurations and modes of operation:

- Configuration 1 - Mode 1
- Mode 2
- Mode 3
- Mode 4
- Mode 5
- Mode 6

2.2.6 Environmental Conditions

	04 November 2013	05 November 2013	06 November 2013
Ambient Temperature	23.5°C	23.0°C	23.5°C
Relative Humidity	41.0%	47.0%	46.0%



Product Service

2.2.7 Test Results

For the period of test the EUT met the requirements of FCC CFR 47 Part 27 for Peak – Average Ratio.

The test results are shown below.

Single Carrier

Configuration 1 - Mode 1

QPSK

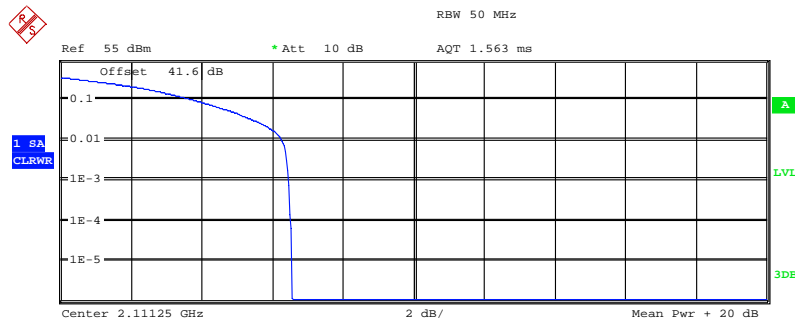

Complementary Cumulative Distribution Function
 NOF samples: 100000, Usable BW: 37.9MHz

Trace 1	
Mean	45.67 dBm
Peak	52.22 dBm
Crest	6.55 dB
10 %	3.78 dB
1 %	6.25 dB
.1 %	6.47 dB
.01 %	6.51 dB

Date: 4.NOV.2013 08:55:55



Product Service

8PSK

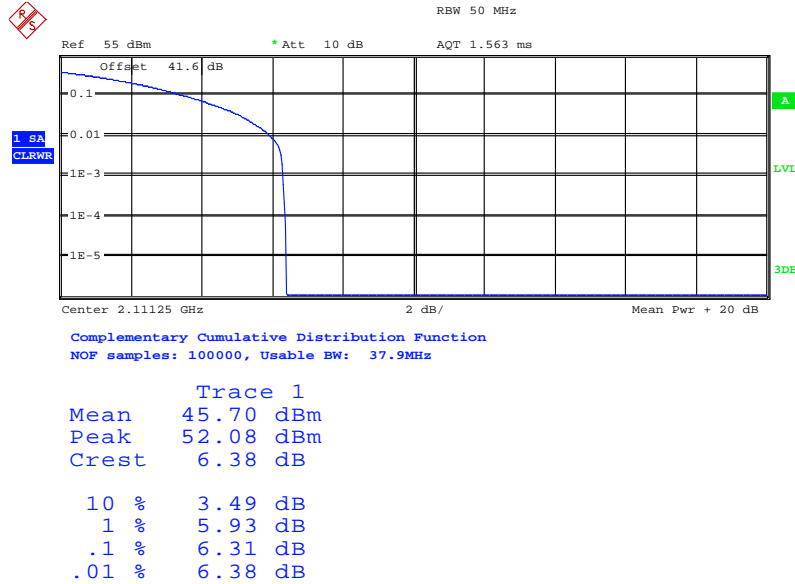

Date: 4.NOV.2013 15:15:00

16QAM

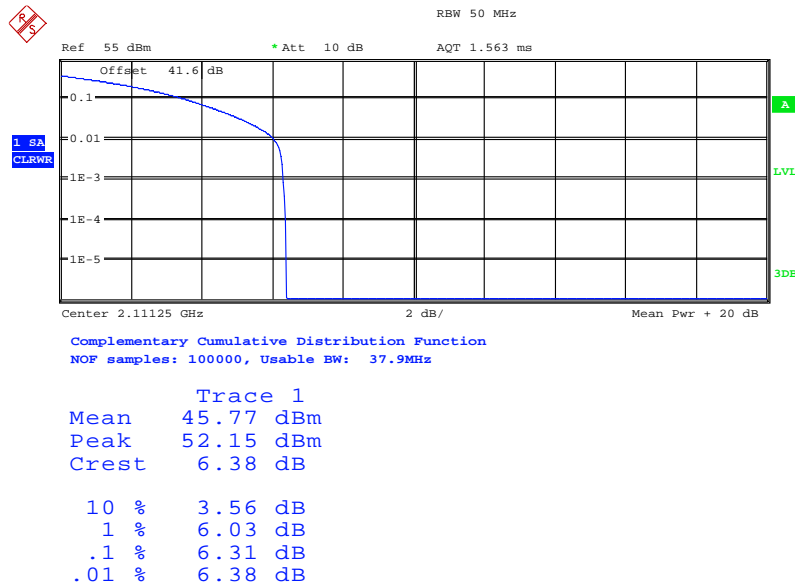

Date: 4.NOV.2013 15:53:03



Product Service

Configuration 1 - Mode 2

QPSK

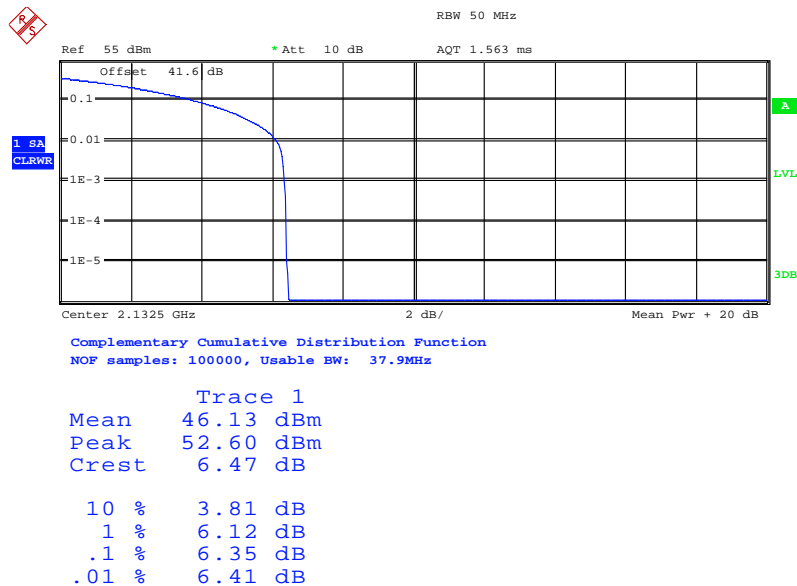

Date: 4.NOV.2013 10:16:20

8PSK

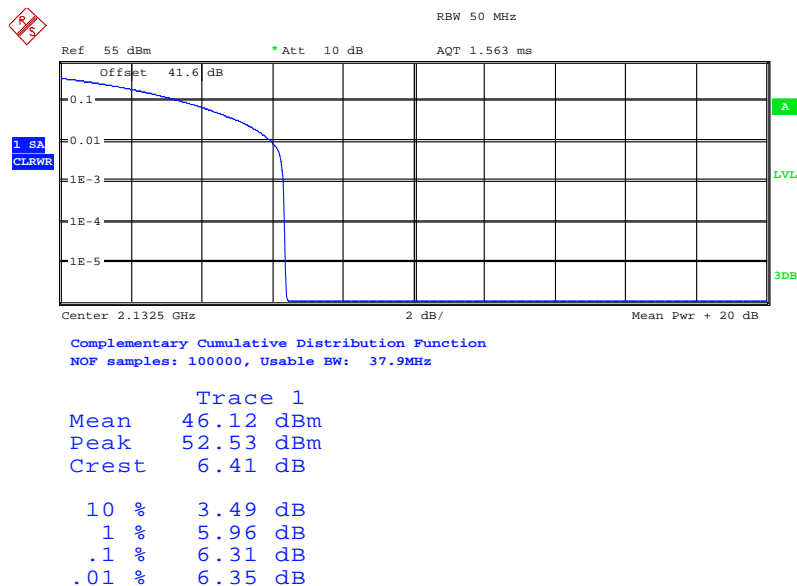

Date: 5.NOV.2013 08:53:40



Product Service

16QAM

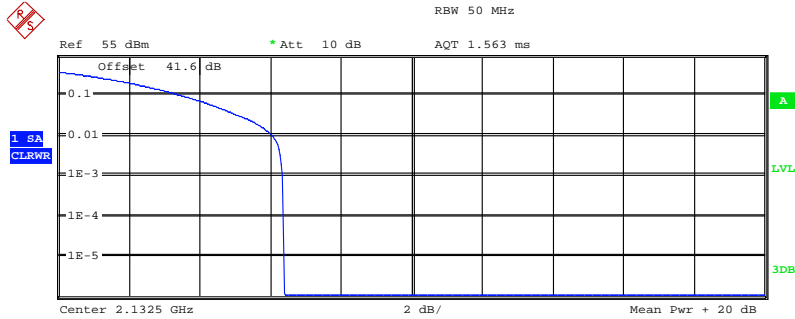

Complementary Cumulative Distribution Function
 NOF samples: 100000, Usable BW: 37.9MHz

Trace 1	
Mean	46.16 dBm
Peak	52.53 dBm
Crest	6.37 dB
10 %	3.49 dB
1 %	6.06 dB
.1 %	6.35 dB
.01 %	6.38 dB

Date: 5.NOV.2013 09:13:32

Configuration 1 - Mode 3

QPSK

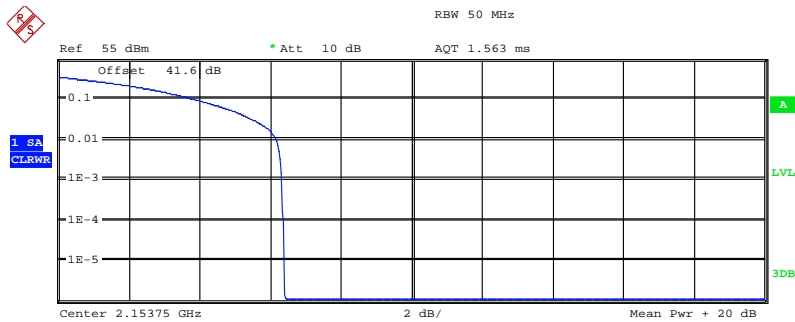

Complementary Cumulative Distribution Function
 NOF samples: 100000, Usable BW: 37.9MHz

Trace 1	
Mean	46.22 dBm
Peak	52.62 dBm
Crest	6.40 dB
10 %	3.88 dB
1 %	6.15 dB
.1 %	6.31 dB
.01 %	6.38 dB

Date: 4.NOV.2013 13:24:35



Product Service

8PSK

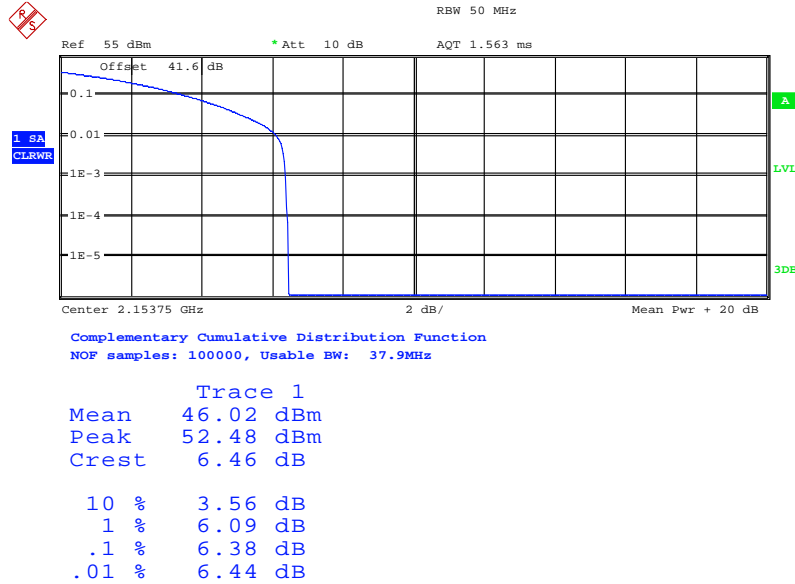

Date: 5.NOV.2013 10:01:24

16QAM

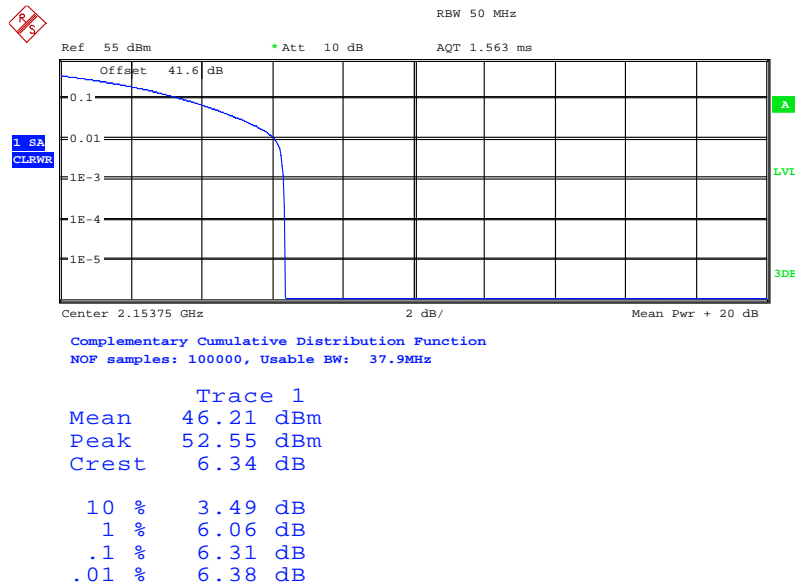

Date: 5.NOV.2013 10:34:35



Multi Carrier (1x2):

Configuration 1 - Mode 4

QPSK

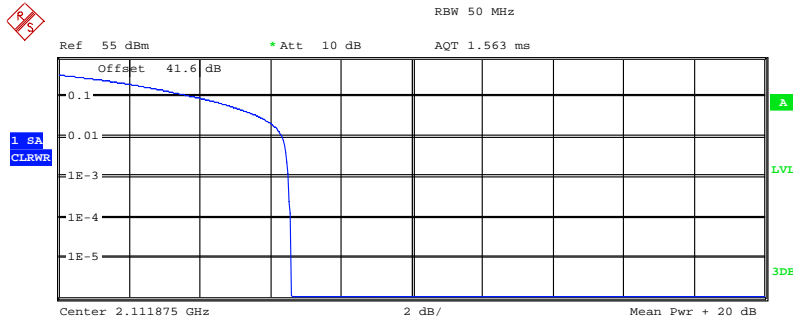

Complementary Cumulative Distribution Function
 NOF samples: 100000, Usable BW: 37.9MHz

Trace 1	
Mean	45.70 dBm
Peak	52.29 dBm
Crest	6.59 dB
10 %	3.91 dB
1 %	6.35 dB
.1 %	6.51 dB
.01 %	6.57 dB

Date: 5.NOV.2013 12:15:03

8PSK

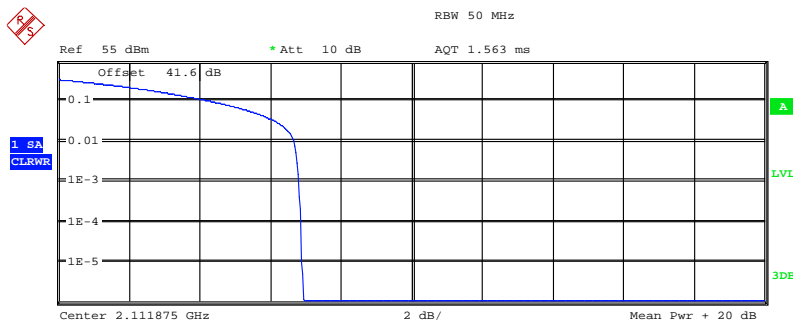

Complementary Cumulative Distribution Function
 NOF samples: 100000, Usable BW: 37.9MHz

Trace 1	
Mean	45.63 dBm
Peak	52.58 dBm
Crest	6.95 dB
10 %	4.33 dB
1 %	6.67 dB
.1 %	6.79 dB
.01 %	6.89 dB

Date: 5.NOV.2013 15:10:17



Product Service

16QAM

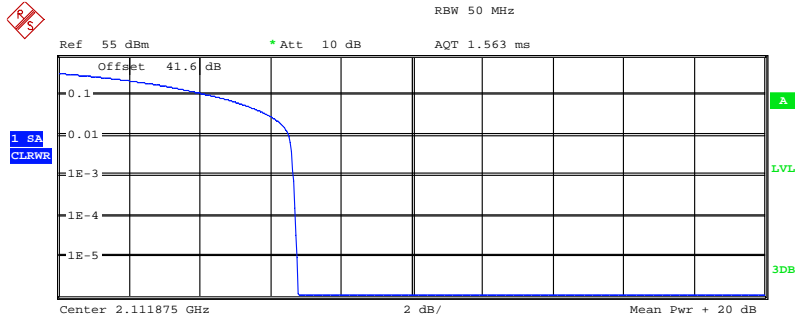

Complementary Cumulative Distribution Function
 NOF samples: 100000, Usable BW: 37.9MHz

Trace 1	
Mean	45.81 dBm
Peak	52.58 dBm
Crest	6.76 dB
10 %	4.33 dB
1 %	6.51 dB
.1 %	6.63 dB
.01 %	6.70 dB

Date: 5.NOV.2013 15:22:12

Configuration 1 - Mode 5

QPSK

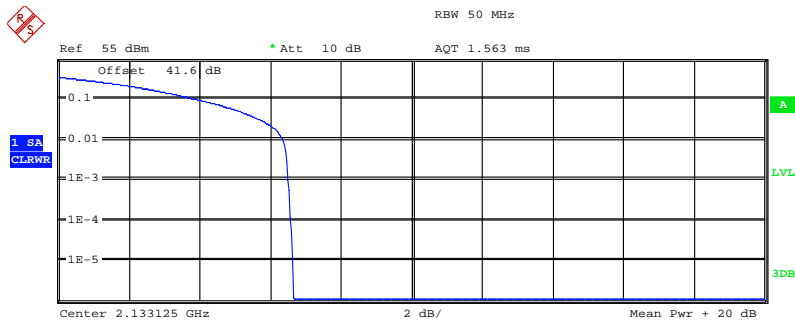

Complementary Cumulative Distribution Function
 NOF samples: 100000, Usable BW: 37.9MHz

Trace 1	
Mean	46.11 dBm
Peak	52.74 dBm
Crest	6.63 dB
10 %	3.94 dB
1 %	6.35 dB
.1 %	6.51 dB
.01 %	6.57 dB

Date: 5.NOV.2013 13:03:23



Product Service

8PSK

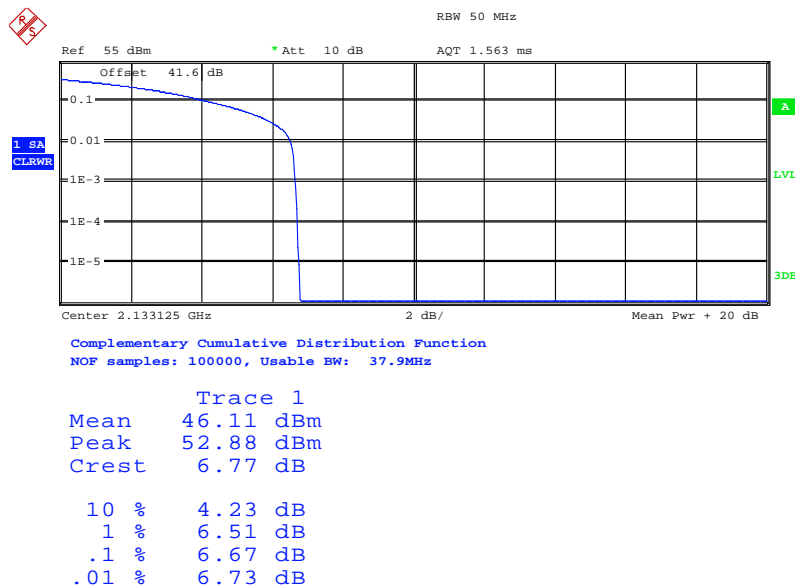

Date: 6.NOV.2013 09:08:12

16QAM

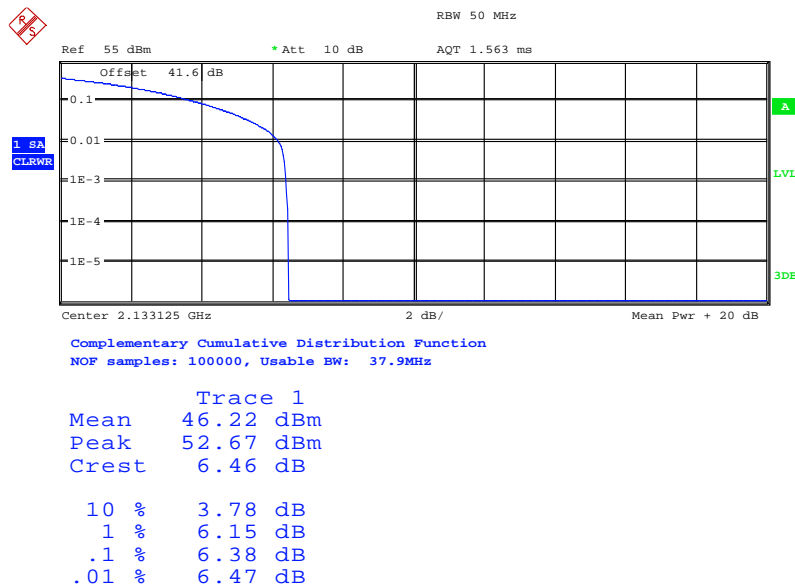

Date: 6.NOV.2013 09:28:40



Product Service

Configuration 1 - Mode 6

QPSK

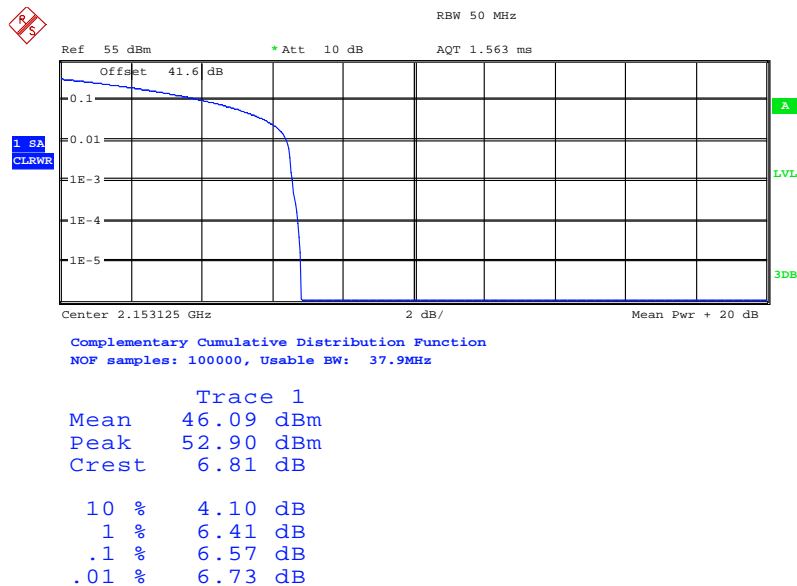

Date: 5.NOV.2013 13:27:47

8PSK

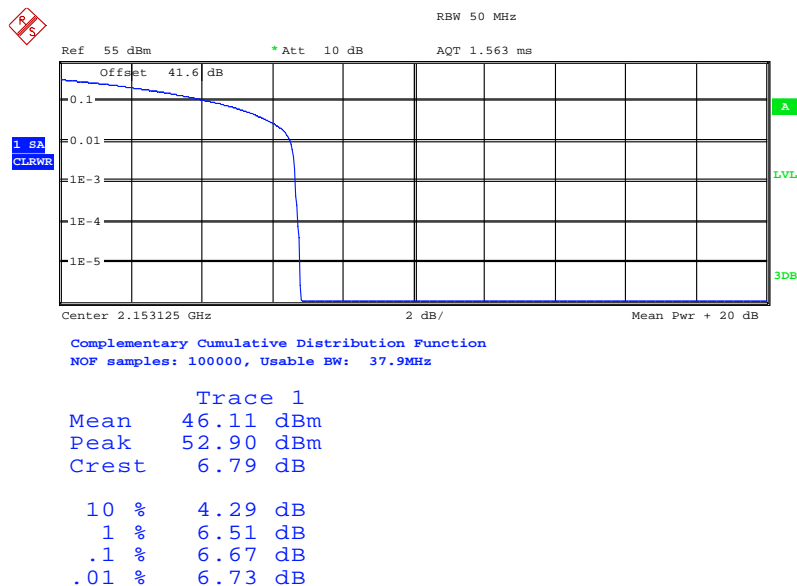

Date: 6.NOV.2013 10:34:57



Product Service

16QAM

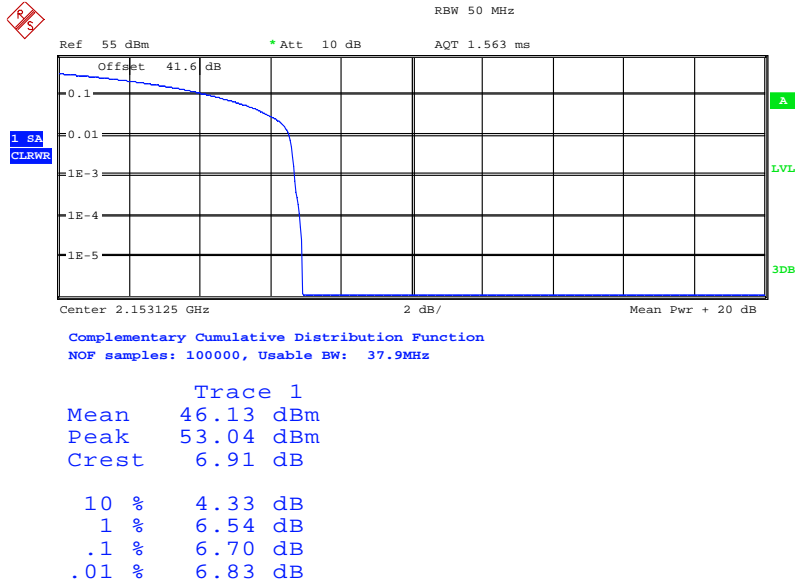

Date: 6.NOV.2013 10:12:11

Limit	13dB
-------	------

Remarks

The Peak – Average ratio does not exceed 13dB at the measured frequencies.



Product Service

2.3 MODULATION CHARACTERISTICS

2.3.1 Specification Reference

FCC CFR 47 Part 2, Clause 2.1047 (d)
Industry Canada RSS-139, Clause 6.2

2.3.2 Equipment Under Test

RRUS 11 B4 / KRC 161 254/2, S/N: CF81442849

2.3.3 Date of Test and Modification State

04 and 05 November 2013 – Modification State 0

2.3.4 Test Method and Operating Modes

The test was applied in accordance with the test method requirements of FCC CFR 47 Part 2 and Industry Canada RSS-139.

Connect the TX output connector RF A to a spectrum analyzer with an attenuator. The other connector RF B was connected to match load. The EUT was controlled to transmit maximum power. Measure and record the constellation of the EUT by the spectrum analyzer.

The EUT supports QPSK, 8PSK and 16QAM modulations.

The test was performed with the EUT in the following configuration and mode of operation:

Configuration 1 - Mode 2

2.3.5 Environmental Conditions

	04 November 2013	05 November 2013
Ambient Temperature	23.5°C	23.0°C
Relative Humidity	41.0%	47.0%

2.3.6 Test Result

Plots are shown on the following showing the EUT transmitting with all of the modulations:

The test results are shown below

Single Carrier

Configuration 1 - Mode 2

EUT transmitting with QPSK modulation:

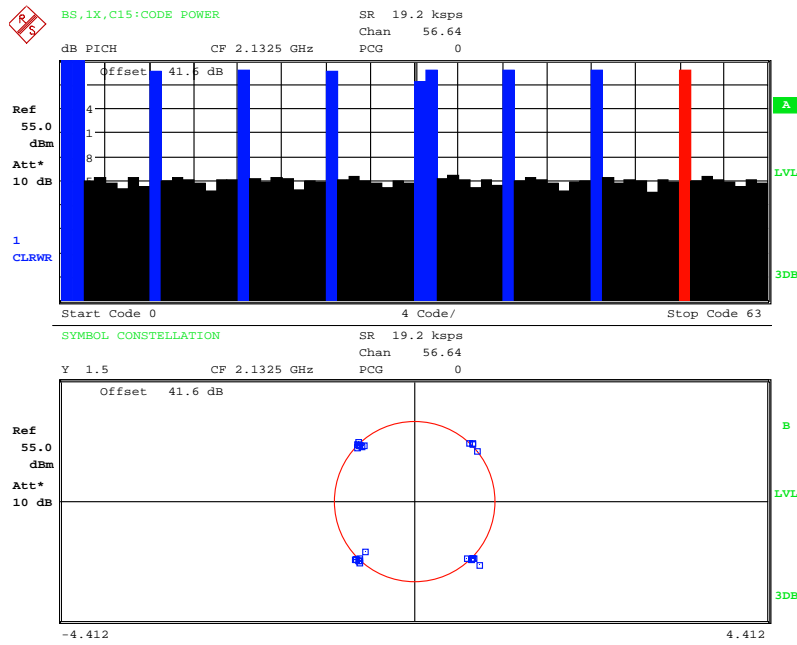

Date: 4.NOV.2013 10:15:09



EUT transmitting with 8PSK modulation:

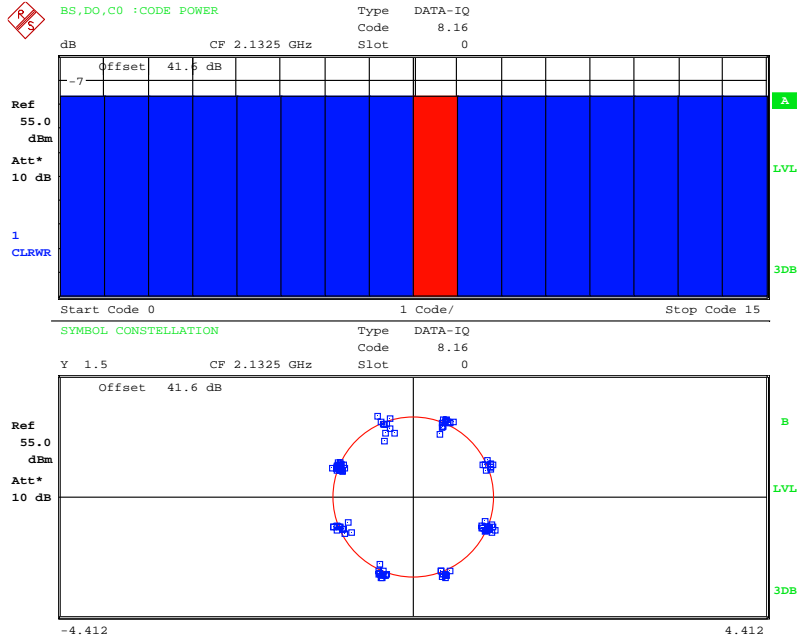

Date: 5.NOV.2013 09:02:42

EUT transmitting with 16QAM modulation:

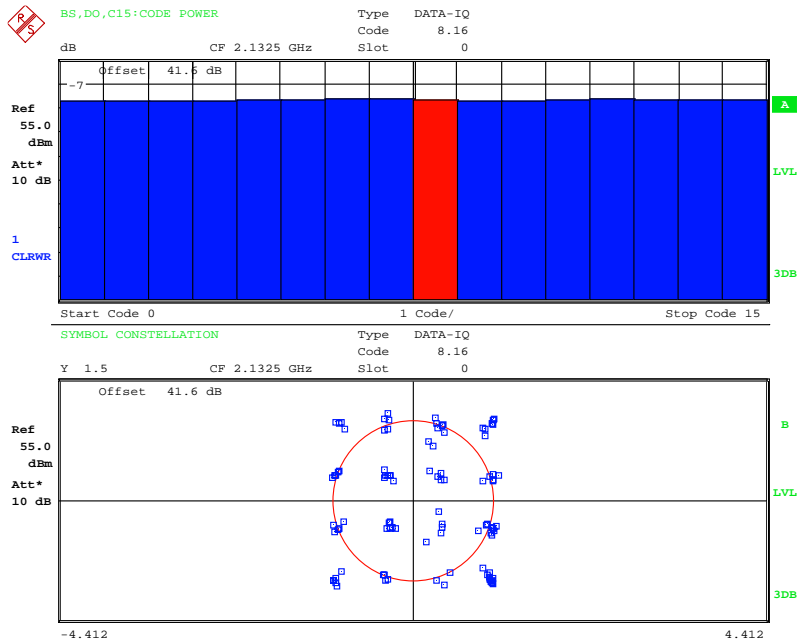

Date: 5.NOV.2013 09:33:33



2.4 OCCUPIED BANDWIDTH

2.4.1 Specification Reference

FCC CFR 47 Part 2, Clause 2.1049
 FCC CFR 47 Part 27, Clause 27.53 (h)
 Industry Canada RSS-GEN, Clause 4.6.1

2.4.2 Equipment Under Test

RRUS 11 B4 / KRC 161 254/2, S/N: CF81442849

2.4.3 Date of Test and Modification State

04, 05 November 2013 and 09 January 2014 – Modification State 0

2.4.4 Test Equipment Used

The major items of test equipment used for the below tests are identified in Section 3.1.

2.4.5 Test Method and Operating Modes

The test was applied in accordance with the test method requirements of FCC CFR 47 Part 2 and Part 27 and Industry Canada RSS-GEN.

The EUT was transmitting at maximum power, modulated using QPSK as the representative test modulation. A resolution bandwidth of 20kHz and a video bandwidth of 200kHz were used for test.

The occupied bandwidth, that is the frequency bandwidth such that, below its lower and above its upper frequency limits, the mean powers radiated are each equal to 0.5 percent of the total mean power radiated by a given emission.

The test was performed with the EUT in the following configurations and modes of operation:

Configuration 1 - Mode 1
 - Mode 2
 - Mode 3

2.4.6 Environmental Conditions

	04 November 2013	05 November 2013	09 January 2014
Ambient Temperature	23.5°C	23.0°C	24.5°C
Relative Humidity	41.0%	47.0%	28.5%

2.4.7 Test Results

For the period of test the EUT met the requirements of FCC CFR 47 Part 2 and Part 27 and Industry Canada RSS-GEN for Occupied Bandwidth.

The test results are shown below



Product Service

Single Carrier

QPSK

Configuration 1 - Mode 1

-26dB Occupied Bandwidth

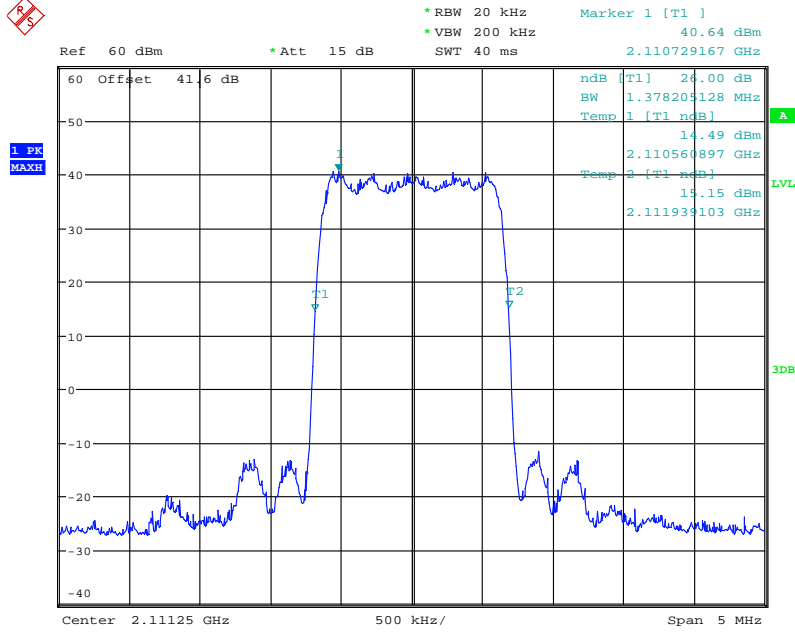

Date: 9.JAN.2014 10:22:50

99% Occupied Bandwidth

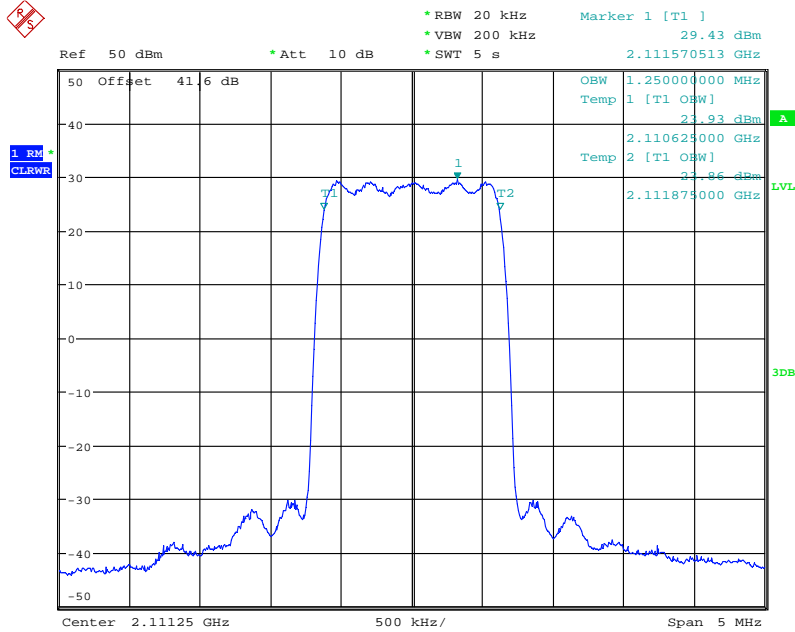

Date: 4.NOV.2013 09:05:41



Product Service

Configuration 1 - Mode 2

-26dB Occupied Bandwidth

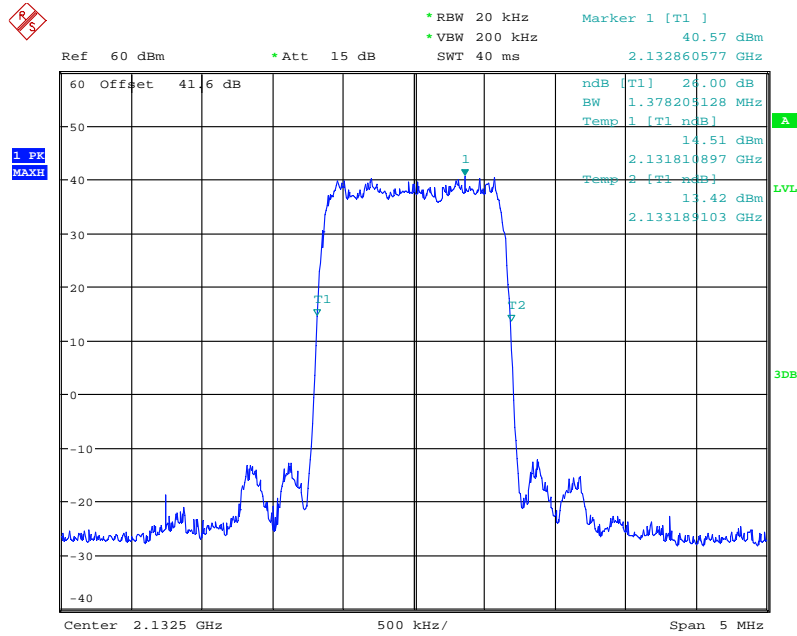

Date: 9.JAN.2014 10:45:12

99% Occupied Bandwidth

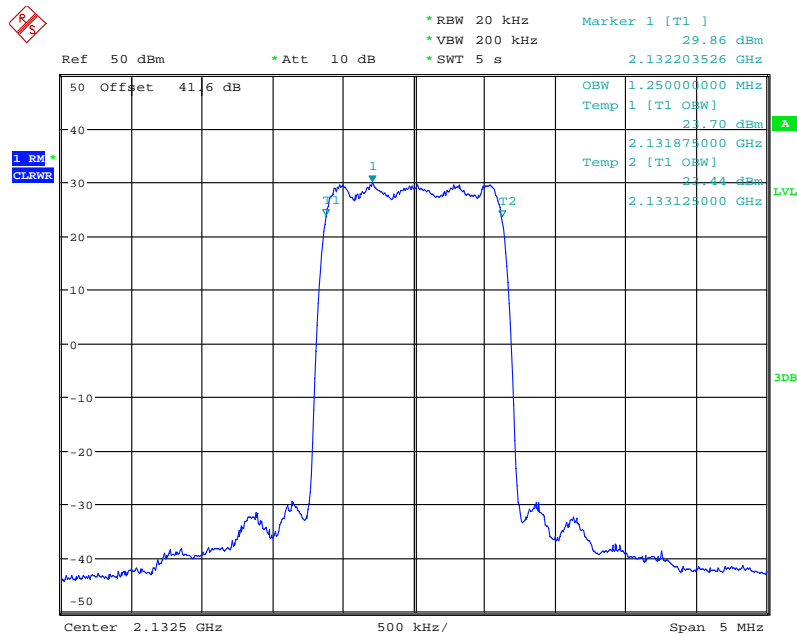

Date: 4.NOV.2013 10:21:16



Product Service

Configuration 1 - Mode 3

-26dB Occupied Bandwidth

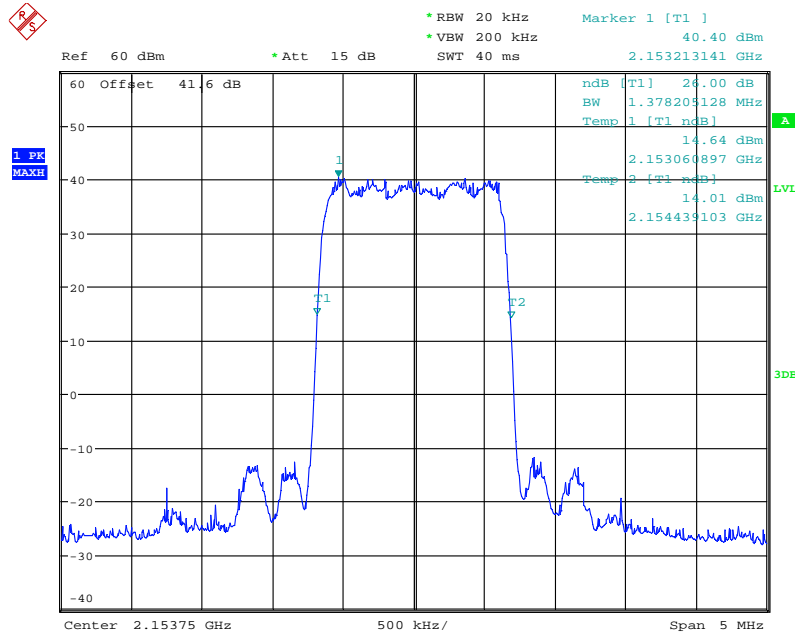

Date: 9.JAN.2014 11:04:08

99% Occupied Bandwidth

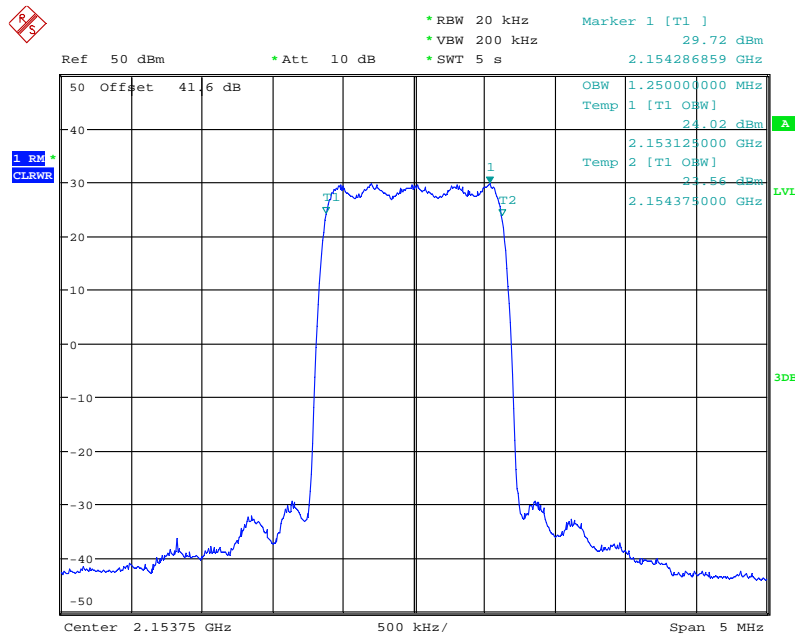

Date: 4.NOV.2013 13:23:52



Product Service

8PSK

Configuration 1 - Mode 2

-26dB Occupied Bandwidth

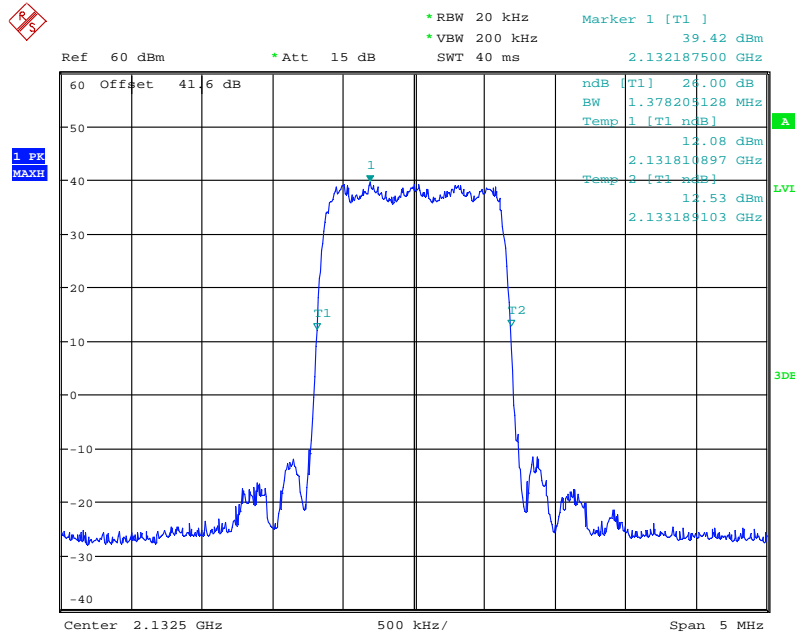

Date: 9.JAN.2014 15:02:24

99% Occupied Bandwidth

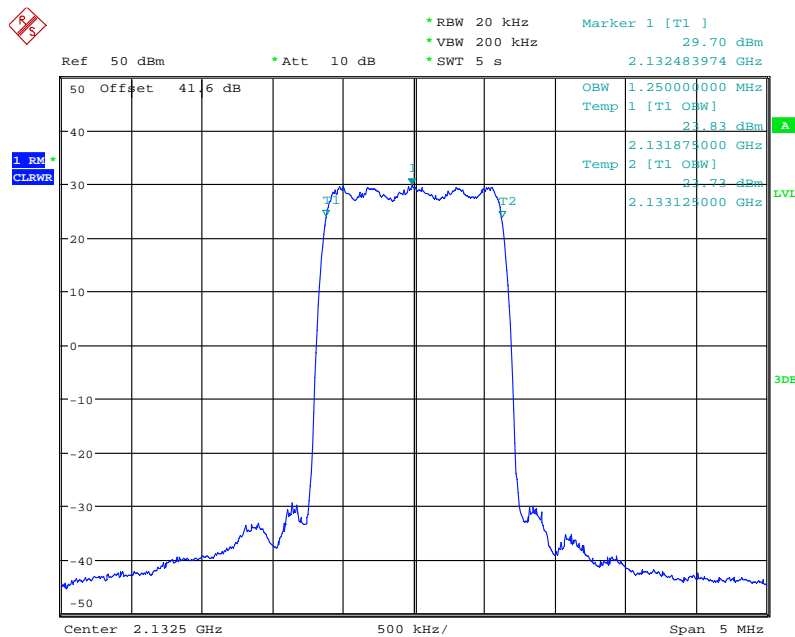

Date: 5.NOV.2013 08:55:07



16QAM

Configuration 1 - Mode 2

-26dB Occupied Bandwidth

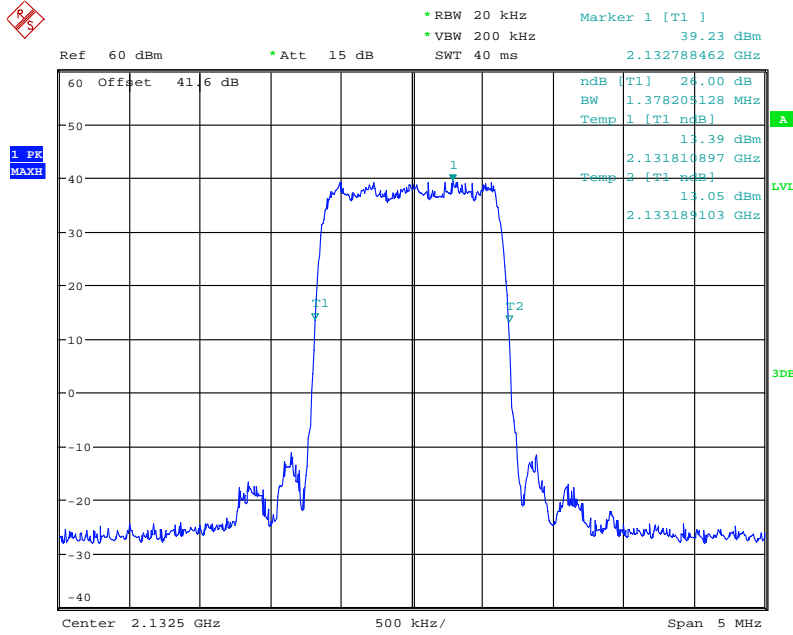

Date: 9.JAN.2014 15:08:03

99% Occupied Bandwidth

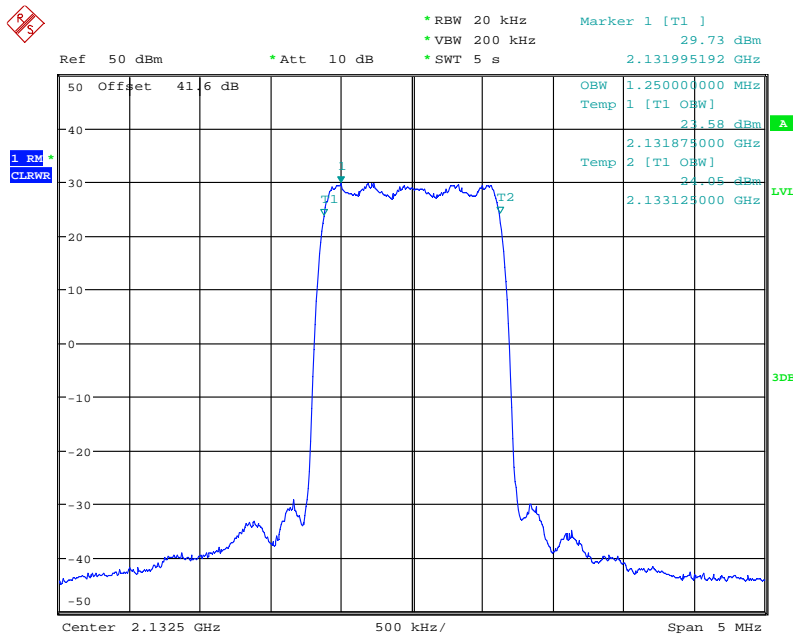

Date: 5.NOV.2013 09:12:51



2.5 SPURIOUS EMISSIONS AT ANTENNA TERMINALS (± 1 MHz)

2.5.1 Specification Reference

FCC CFR 47 Part 2, Clause 2.1051
 FCC CFR 47 Part 27, Clause 27.53 (h)
 Industry Canada RSS-139, Clause 6.5

2.5.2 Equipment Under Test

RRUS 11 B4 / KRC 161 254/2, S/N: CF81442849

2.5.3 Date of Test and Modification State

04, 05 and 06 November 2013 – Modification State 0

2.5.4 Test Equipment Used

The major items of test equipment used for the below tests are identified in Section 3.1.

2.5.5 Test Method and Operating Modes

The test was applied in accordance with the test method requirements of FCC CFR 47 Part 2 and Part 27 and Industry Canada RSS-139.

In accordance with FCC Part 27.53(h)(1), at least 1% of the emission bandwidth should be used for the frequencies offset up to 1MHz away from the block edge. A resolution bandwidth of 20kHz was used up to 1MHz away from the band edges. According to the FCC rules, a RBW of 1MHz should be used for measurements of emissions > 1MHz away from the band edges. A resolution bandwidth of 50kHz was used for the tests of emissions > 1MHz away from the band edges, so the limit was adjusted with -13dBm to -26dBm to compensated for the reduce measurement bandwidth. Spectrum analyser detector was set as RMS.

The EUT was tested at it's maximum power level, all the modulations were test. The path loss measured and entered as a reference level offset.

The test was performed with the EUT in the following configurations and modes of operation:

Configuration 1 - Mode 1
 - Mode 3
 - Mode 4
 - Mode 6

2.5.6 Environmental Conditions

	04 November 2013	05 November 2013	06 November 2013
Ambient Temperature	23.5°C	23.0°C	23.5°C
Relative Humidity	41.0%	47.0%	46.0%



2.5.7 Test Results

For the period of test the EUT met the requirements of FCC CFR 47 Part 2 and Part 27 and Industry Canada RSS-139 for Spurious Emissions Antenna Terminals (± 1 MHz)

Below are the Frequencies the EUT was tested against along with the tested channels.

QPSK, 8PSK and 16QAM

Single Carrier

Configuration 1 - Mode 1 and 3

Band Edge Frequency	Edge Test with QPSK modulation Channel No./Frequencies
Bottom 2110 MHz	Channel: 25 Frequency: 2111.25 MHz
Top 2155 MHz	Channel: 875 Frequency: 2153.75 MHz

Multi Carrier (1x2)

Configuration 1 - Mode 7 and 8

Band Edge Frequency	Edge Test with QPSK modulation Channel No./Frequencies
Bottom 2110 MHz	Channel: 25 & 50 Frequency: 2111.25 & 2112.50 MHz
Top 2155 MHz	Channel: 850 & 875 Frequency: 2152.50 & 2153.75 MHz

The channels shown in the table above are the minimum and maximum channels that can be used in the authorised frequency ranges to maintain compliance. Channels used outside of those stated and power levels used beyond those stated in the table exceed the specification limits, thus they cannot be used.

The channels outside of those shown in the table above were not tested at lower power levels to determine a level at which compliance would be achieved. Therefore, to maintain compliance, only the channels shown in the table above shall be used.



Product Service

The test results are shown below

Single Carrier

QPSK

Configuration 1 - Mode 1

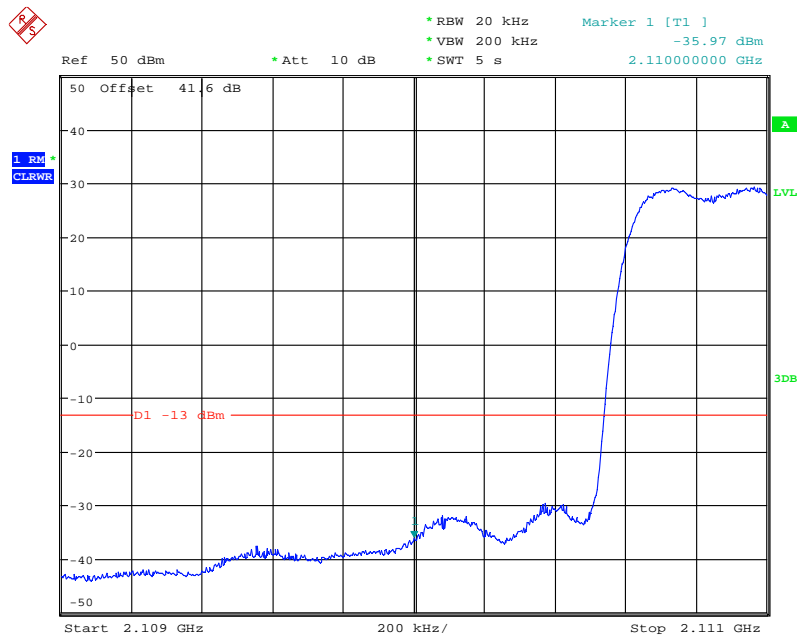

Date: 4.NOV.2013 09:08:09

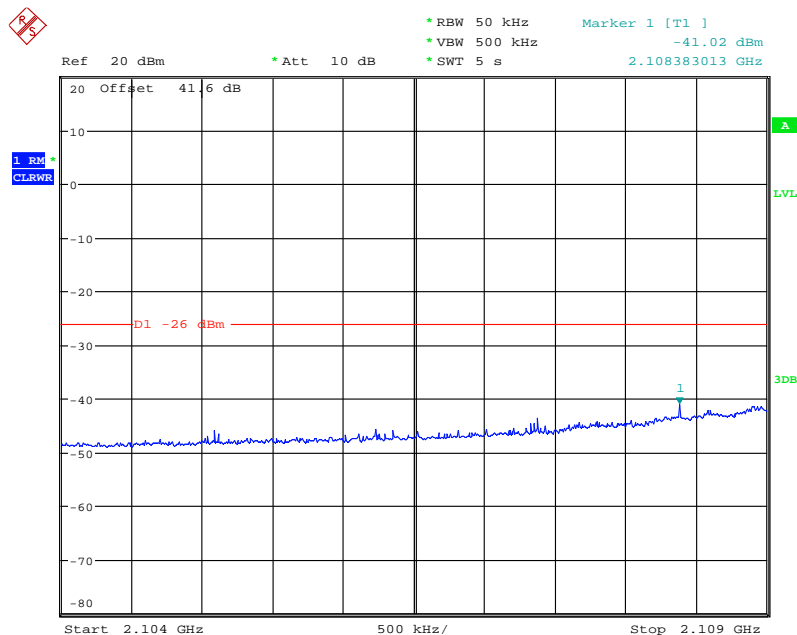

Date: 4.NOV.2013 13:51:50



Configuration 1 - Mode 3

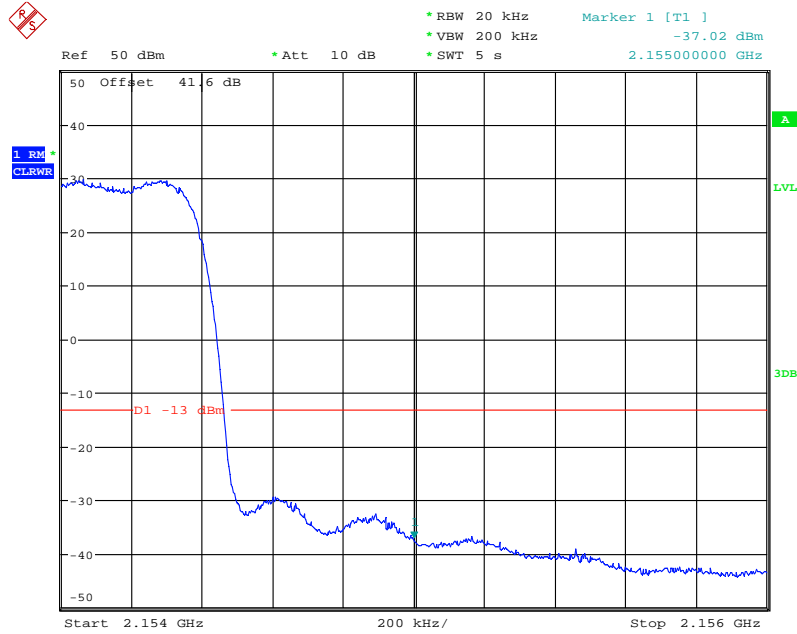

Date: 4.NOV.2013 13:26:02

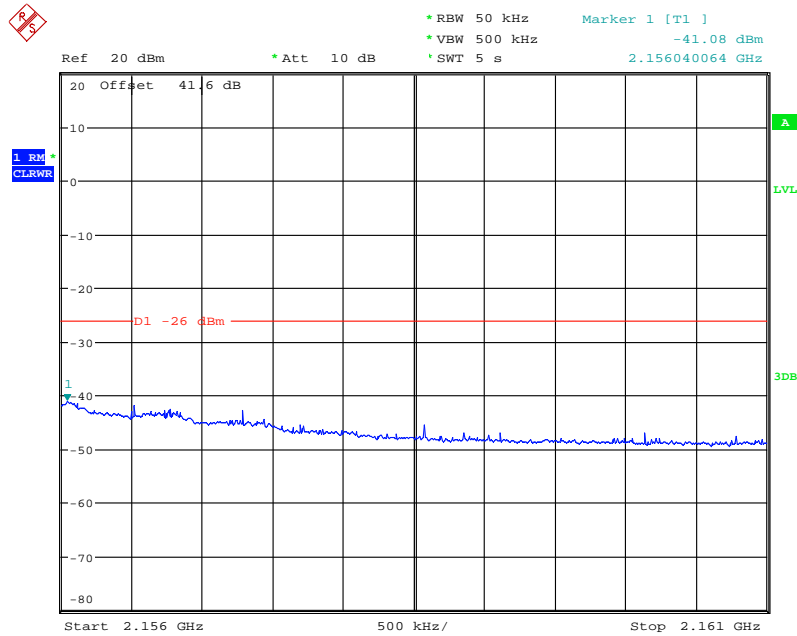

Date: 4.NOV.2013 13:33:16



Product Service

8PSK

Configuration 1 - Mode 1

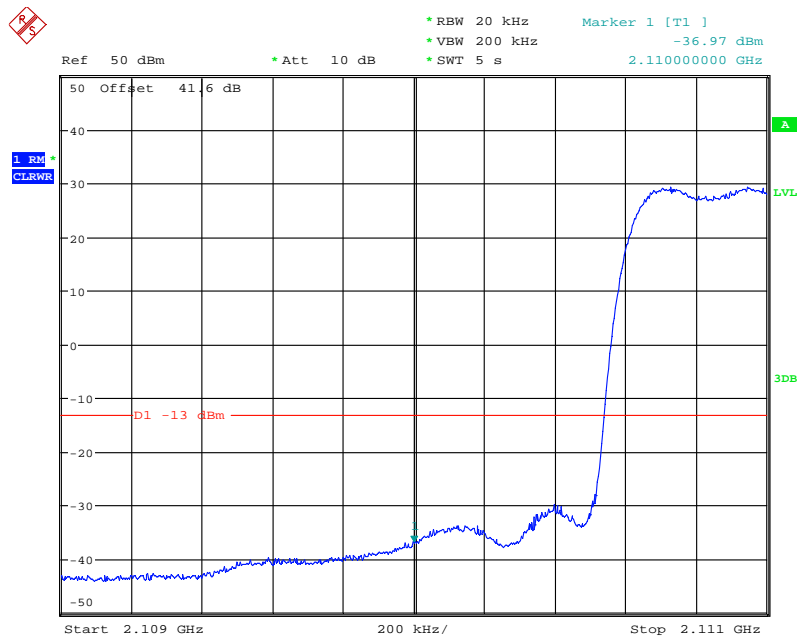

Date: 4.NOV.2013 15:12:47

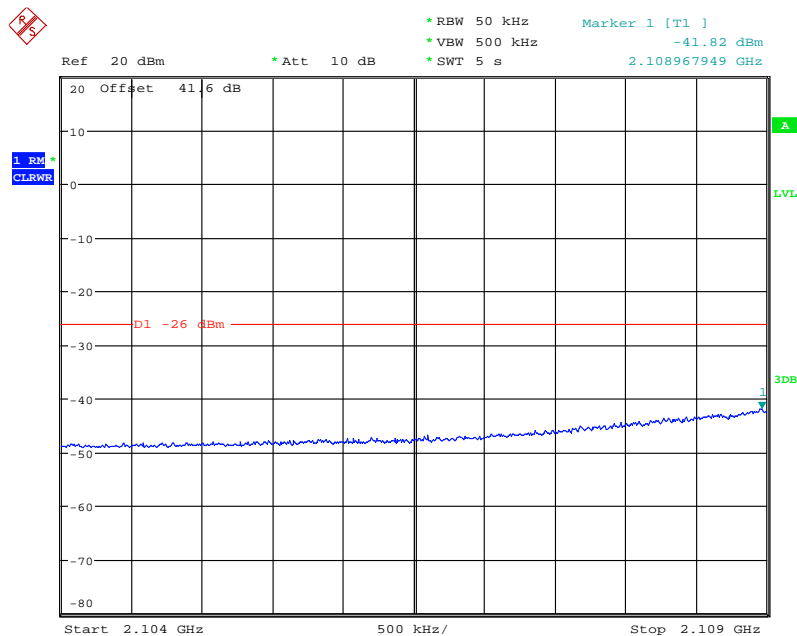

Date: 4.NOV.2013 15:11:20



Product Service

Configuration 1 - Mode 3

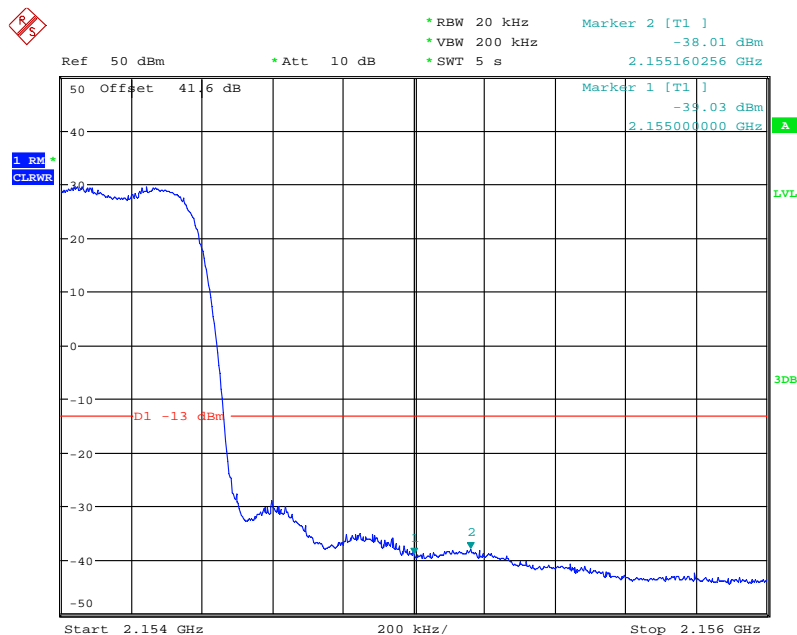

Date: 5.NOV.2013 10:03:42

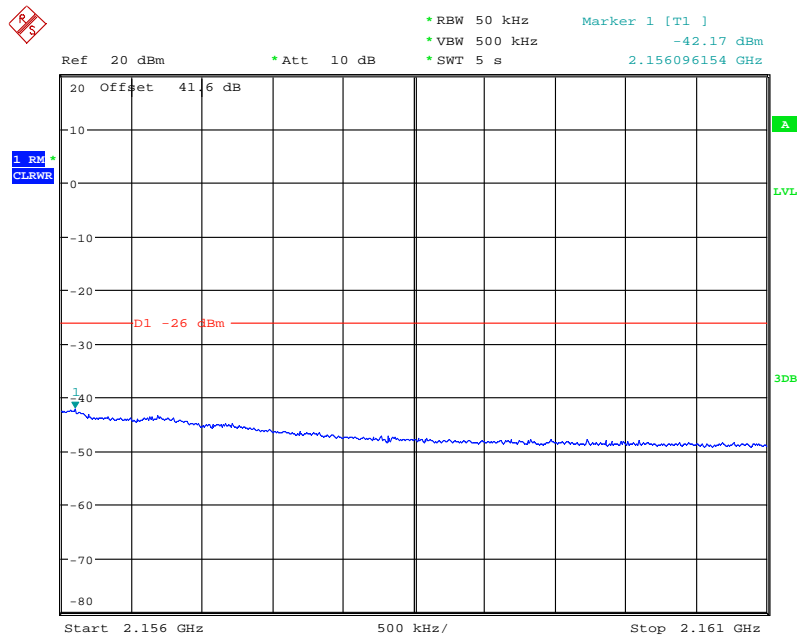

Date: 5.NOV.2013 10:05:24



16QAM

Configuration 1 - Mode 1

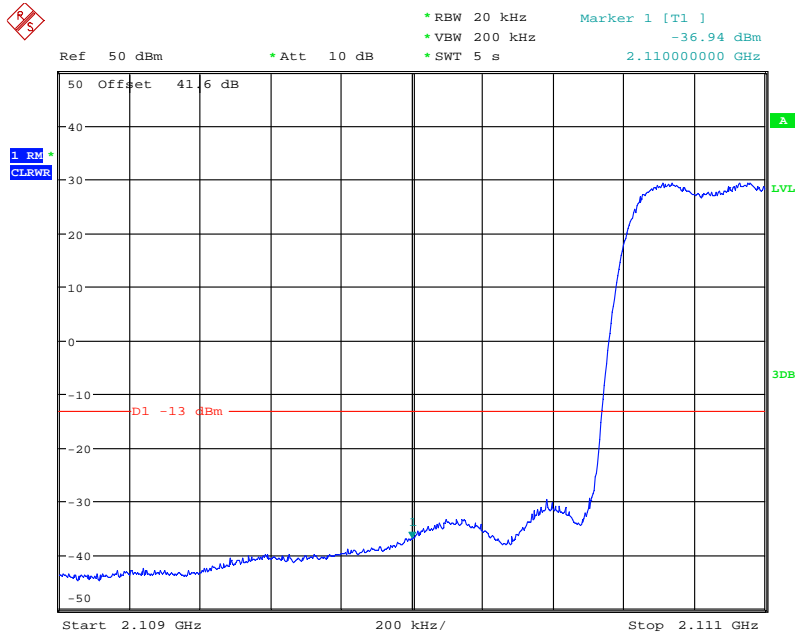

Date: 4.NOV.2013 15:54:38

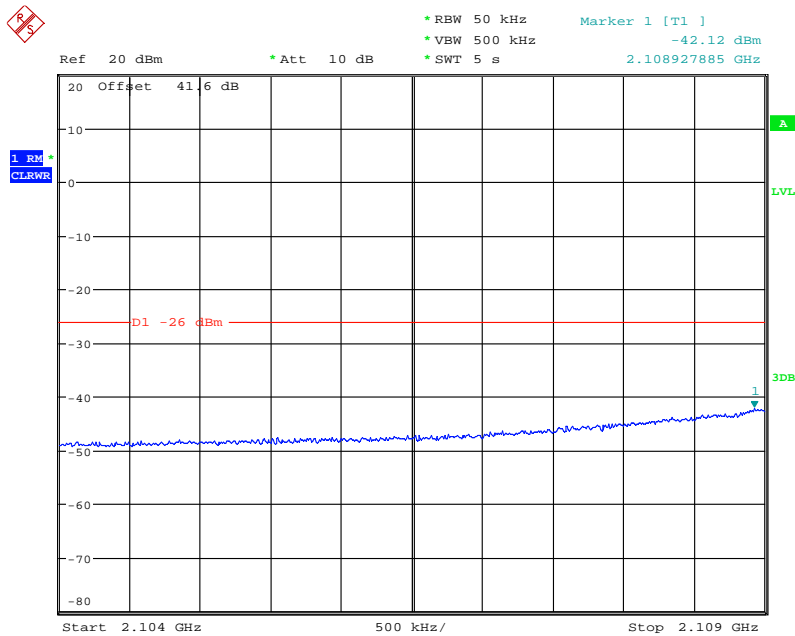

Date: 4.NOV.2013 15:56:05



Product Service

Configuration 1 - Mode 3

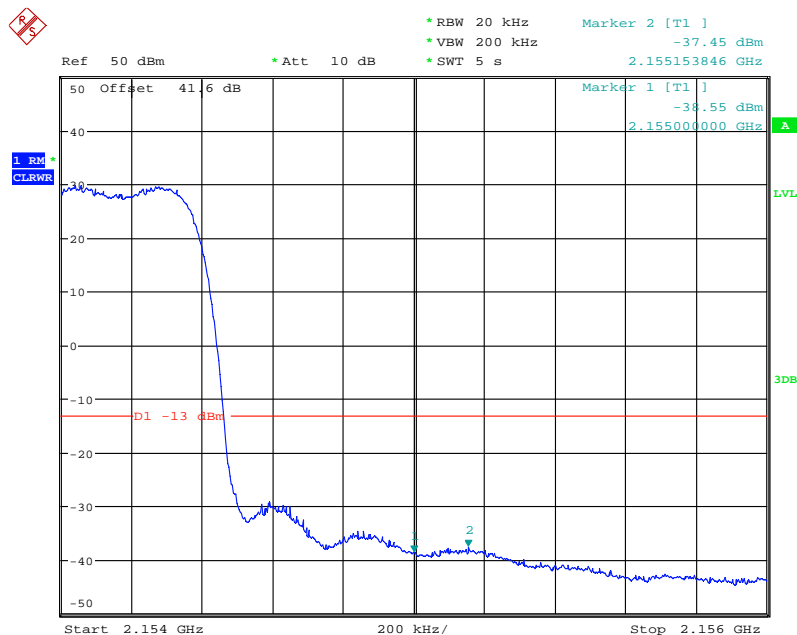

Date: 5.NOV.2013 10:32:18

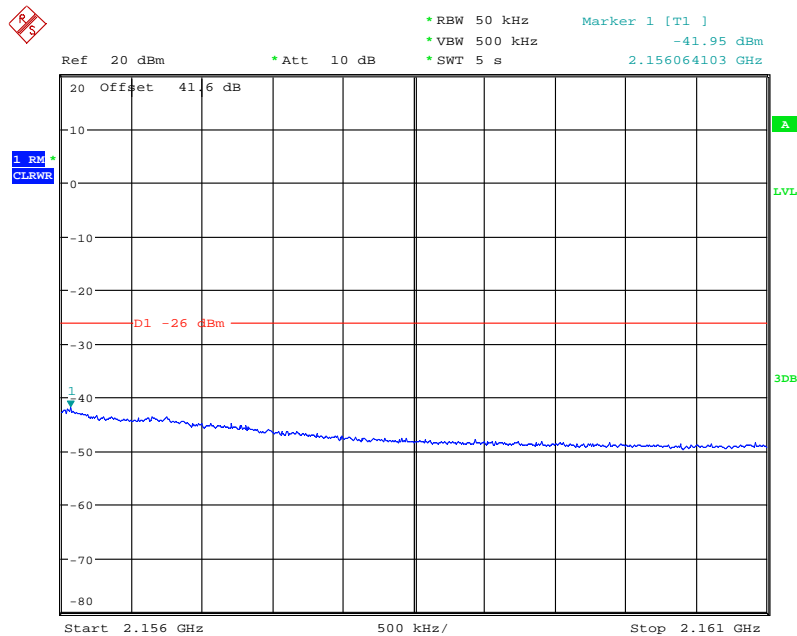

Date: 5.NOV.2013 10:30:41



Product Service

Multi Carrier (1x2)

QPSK

Configuration 1 - Mode 4

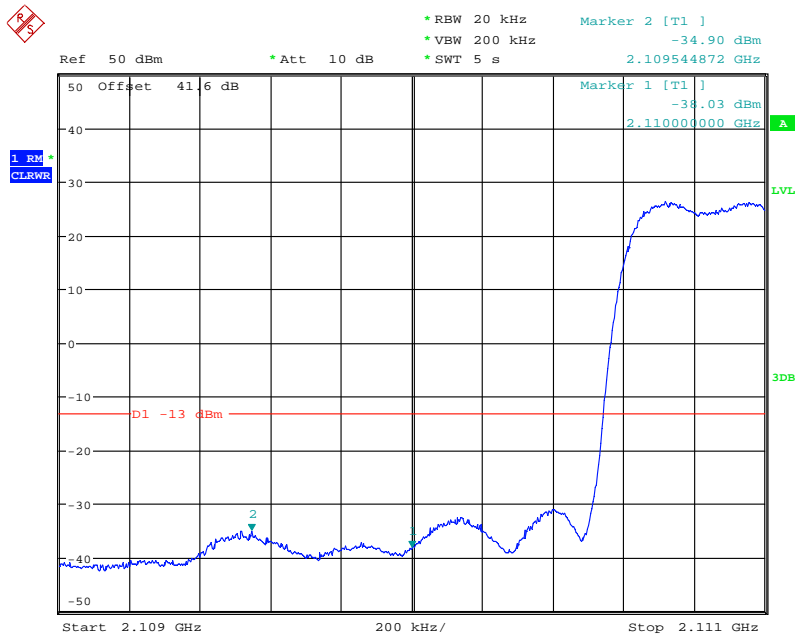

Date: 5.NOV.2013 12:23:16

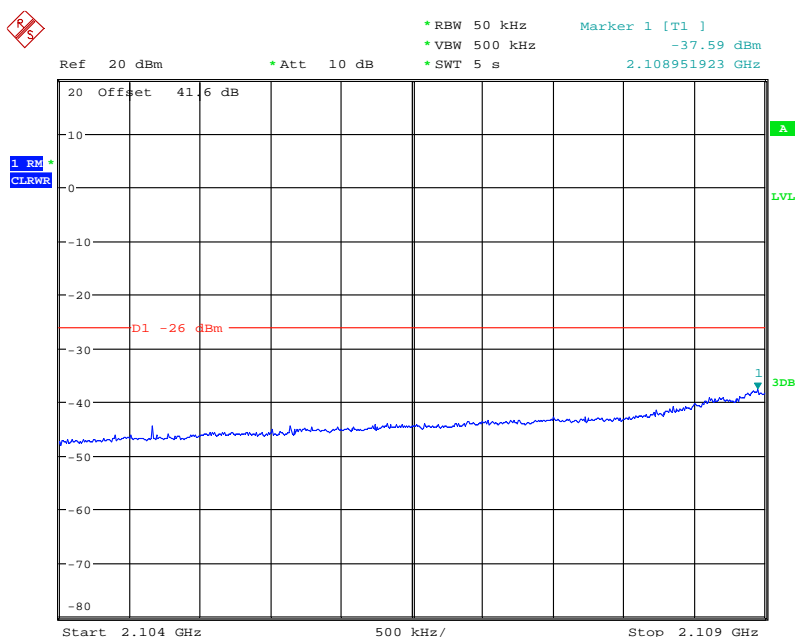

Date: 5.NOV.2013 12:24:22



Product Service

Configuration 1- Mode 6

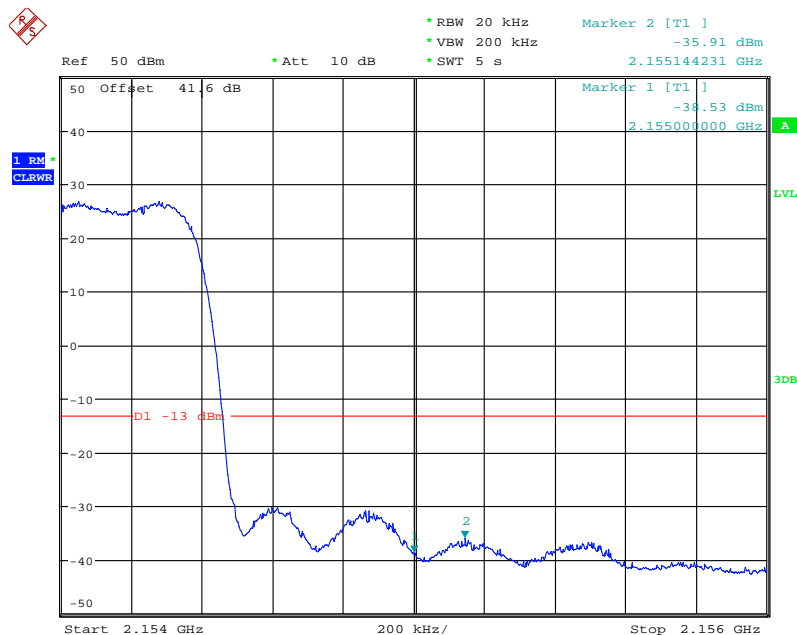

Date: 5.NOV.2013 13:32:30

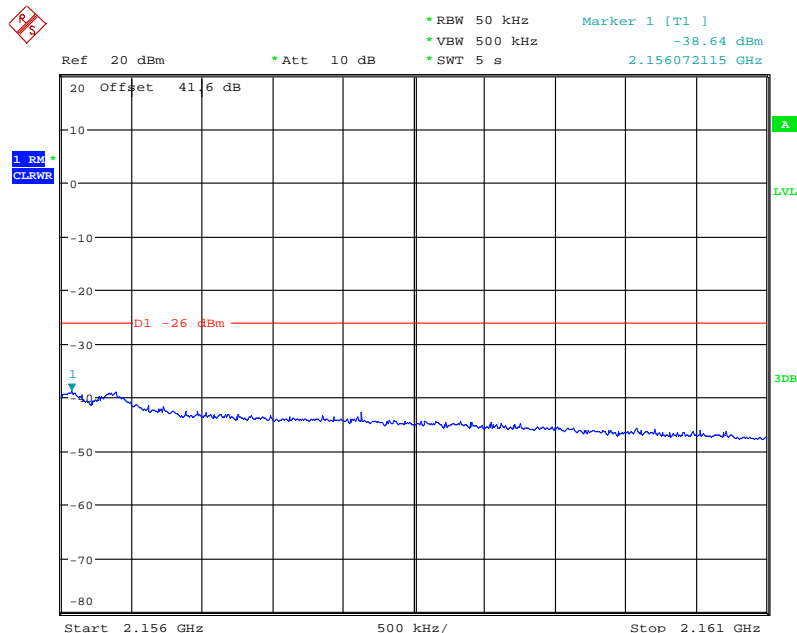

Date: 5.NOV.2013 13:28:59



Product Service

8PSK

Configuration 1 - Mode 4

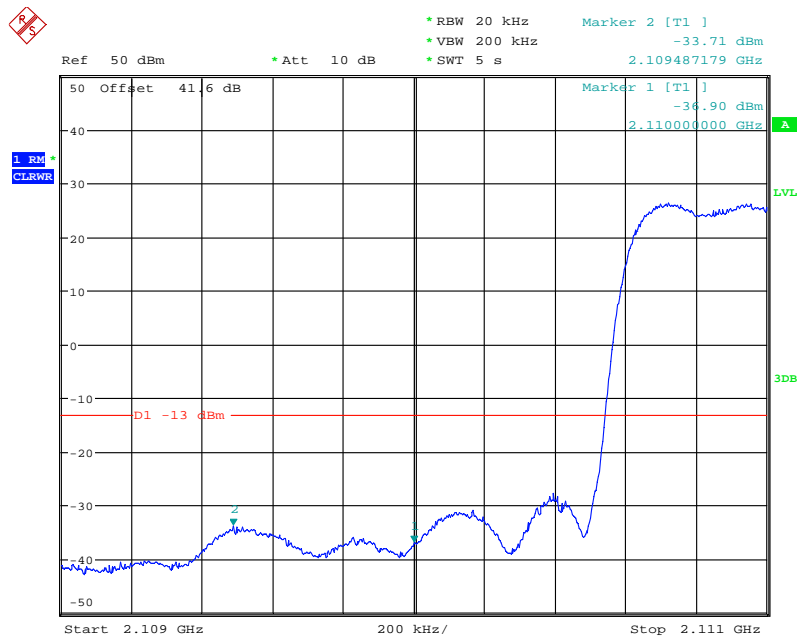

Date: 5.NOV.2013 15:08:14

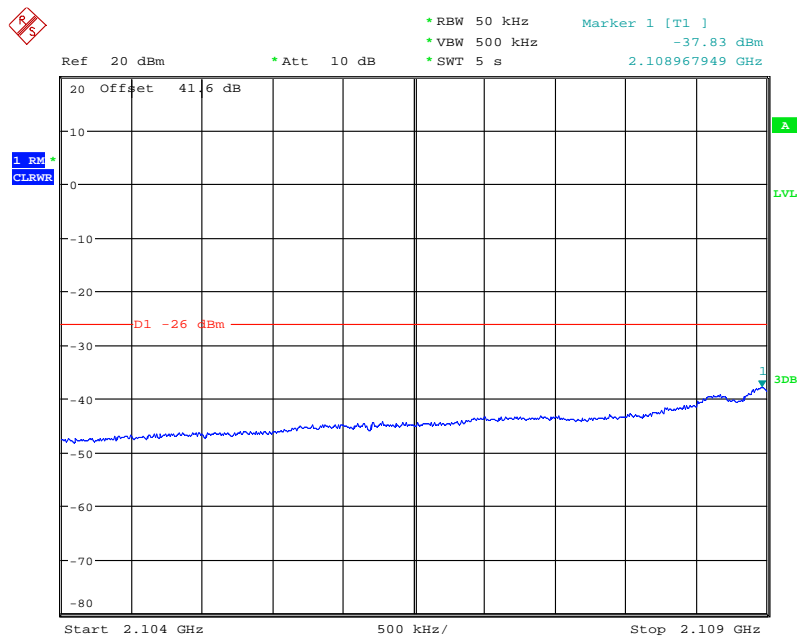

Date: 5.NOV.2013 15:09:08



Product Service

Configuration 1 - Mode 6

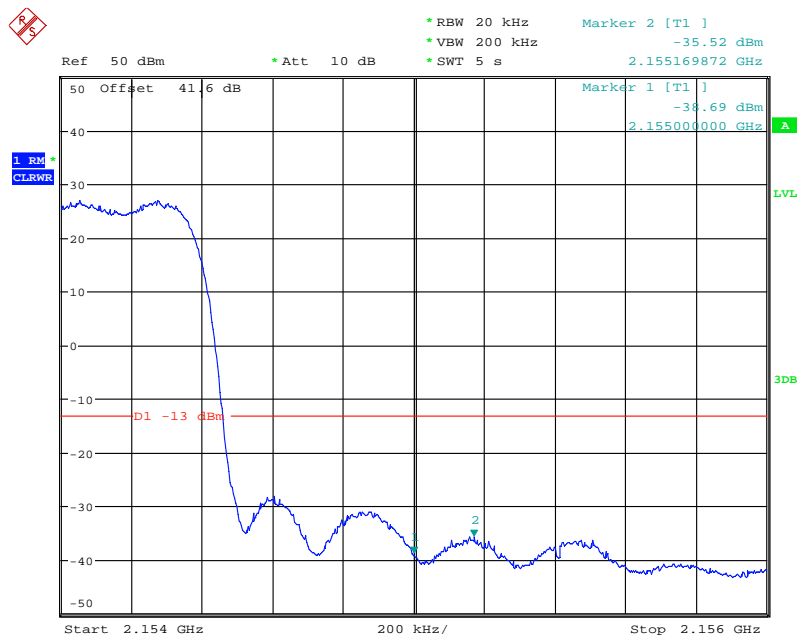

Date: 6.NOV.2013 10:34:18

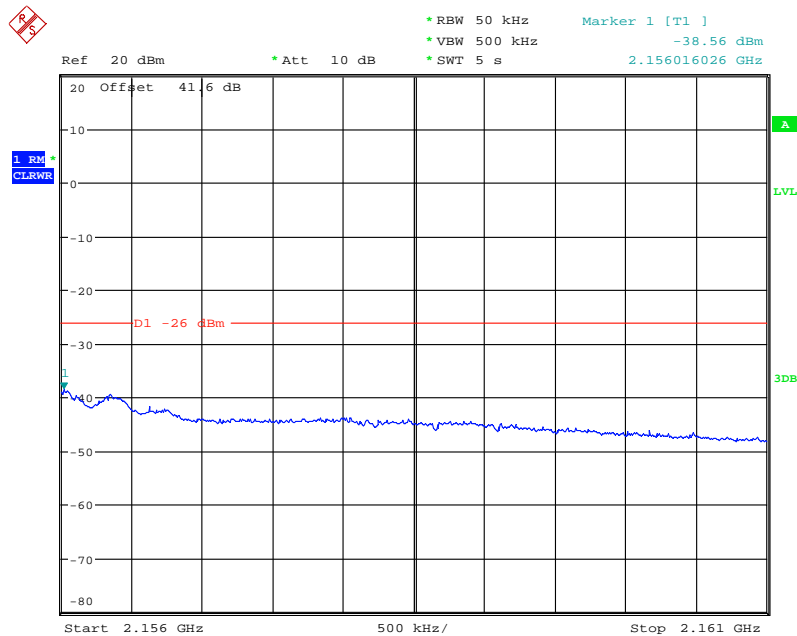

Date: 6.NOV.2013 10:32:25



Product Service

16QAM

Configuration 1 - Mode 4

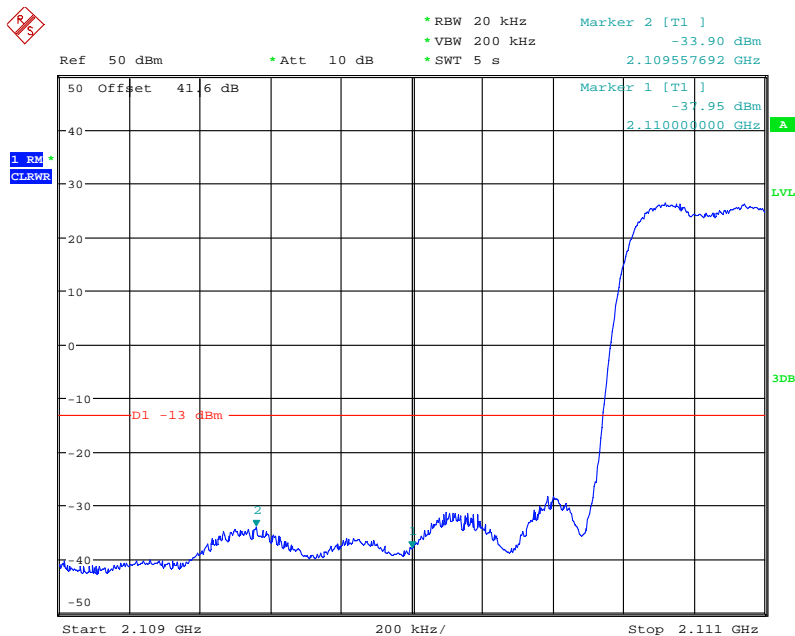

Date: 5.NOV.2013 15:25:06

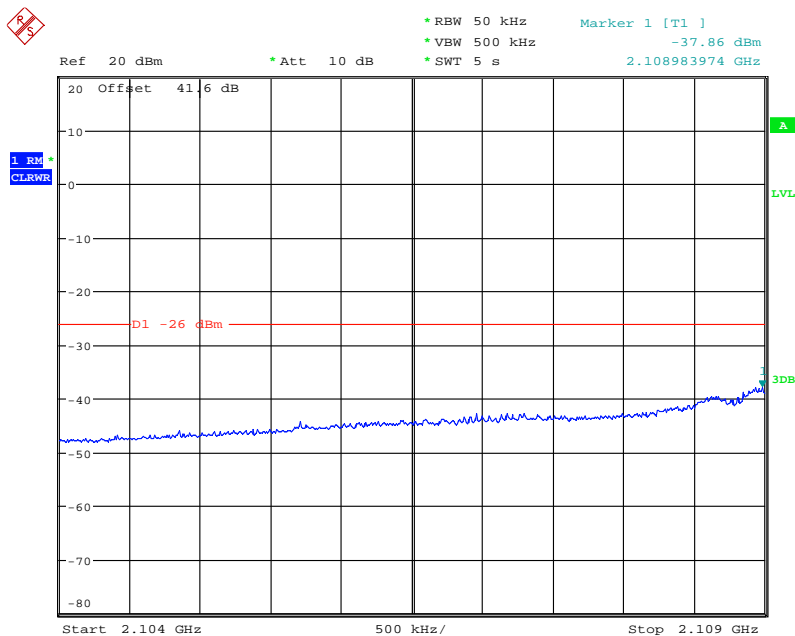

Date: 5.NOV.2013 15:23:19



Configuration 1 - Mode 6

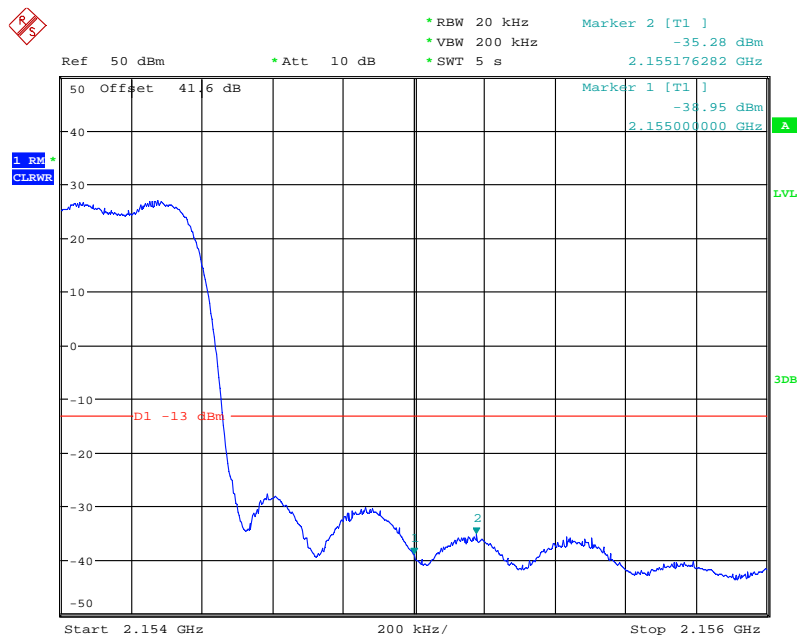

Date: 6.NOV.2013 10:13:18

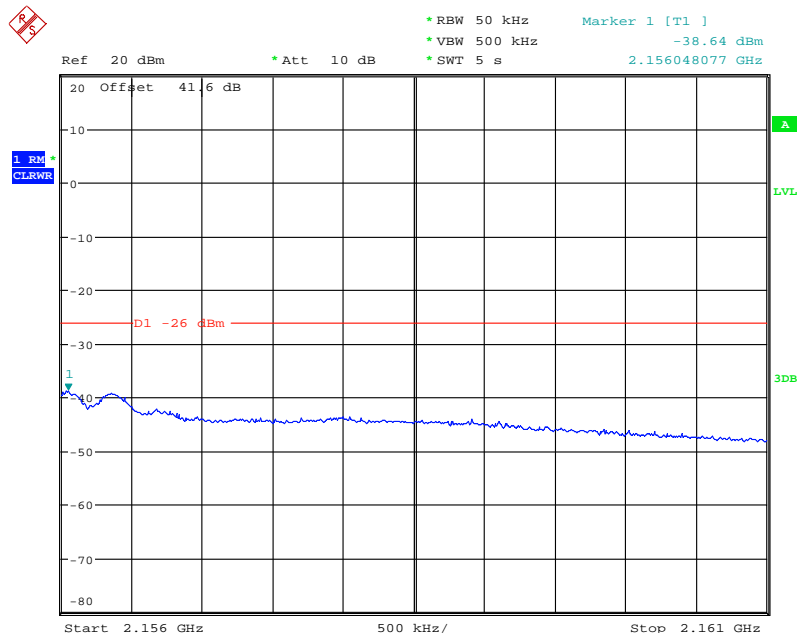

Date: 6.NOV.2013 10:14:59

Limit

The power of any emission outside the frequency band shall be attenuated below the transmitter power (P) by at least $43 + 10\log P$ dB.



2.6 RADIATED SPURIOUS EMISSIONS

2.6.1 Specification Reference

FCC CFR 47 Part 2, Clause 2.1053
FCC CFR 47 Part 27, Clause 27.53 (h)
Industry Canada RSS-139, Clause 6.5

2.6.2 Equipment Under Test

RRUS 11 B4 / KRC 161 254/2, S/N: CF81442849

2.6.3 Date of Test and Modification State

20, 22 and 26 November 2013 – Modification State 0

2.6.4 Test Equipment Used

The major items of test equipment used for the below tests are identified in Section 3.1.

2.6.5 Test Method and Operating Modes

The test was applied in accordance with the test method requirements of FCC CFR 47 Part 2 and Part 27 and Industry Canada RSS-139.

A preliminary profile of the Spurious Radiated Emissions was obtained by operating the EUT on a remotely controlled turntable within the chamber. Measurements of emissions from the EUT were obtained with the measurement antenna in both horizontal and vertical polarisations.

Emissions identified within the range 30MHz – 25GHz were then formally measured using a Peak detector as the worst case.

In the frequency Range 30MHz – 25GHz, the measurement was performed with a resolution bandwidth of 1MHz.

The measurements were performed at a 3m distance unless otherwise stated.

The limits for Spurious Emissions have been calculated, as shown below using the following formula:

Field Strength of Carrier - $(43 + 10\text{Log}(P))$ dB

Where:

Field Strength is measured in dB μ V/m

P is measured Transmitter Power in Watts



Determination of Spurious Emission Limit

As the EUT does not have an integral antenna, the field strength of the carrier has been calculated assuming that the power is to be fed to a half-wave tuned dipole as per 2.1053 (a).

$$E_{(v/m)} = (30 \times G_i \times P_o)^{0.5} / d$$

Where G_i is the antenna gain of ideal half-wave dipoles,
 P_o is the power out of the transceiver in W,
 d is the measurement distance in meters.

Therefore at 3m measurement distance the field strength using the lowest transceiver output power would be:

$$E_{(v/m)} = (30 \times 1.64 \times 35.56)^{0.5} / 3 = 13.94V/m = 142.89dB\mu V/m$$

As per 27.53 (h) the spurious emission must be attenuated by $43 + 10\log(P_o)$ dB this gives:

$$43 + 10\log(35.56) = 58.51dB$$

Therefore the limit at 3m measurement distance is:

$$142.89 - 58.51 = 84.4 \text{ dB}\mu V/m$$

This limit has been used to determine Pass or Fail for the harmonics measured and detailed in the following results.

The test was performed with the EUT operating on all modes in section 1.4.3 and record the result of the following configurations and modes of operation for worst case:

- Configuration 1 - Mode 1
 - Mode 2
 - Mode 3
 - Mode 4

2.6.6 Environmental Conditions

	20 November 2013	22 November 2013	26 November 2013
Ambient Temperature	24.0°C	24.5°C	23.0°C
Relative Humidity	40.0%	44.0%	35.0%



2.6.7 Test Results

For the period of test the EUT met the requirements of FCC CFR 47 Part 2 & Part 27 and Industry Canada RSS-139 for Radiated Spurious Emissions.

The test results are shown below

Note: Only the worst case results plots have been included as all of the emissions are greater than 20dB below the limit. A set of plots have been included to show the measurement system noise floor.

Single Carrier

QPSK

Configuration 1 - Mode 2

No emissions were detected within 20dB of the limit.

8PSK

Configuration 1 - Mode 1

30MHz to 3GHz

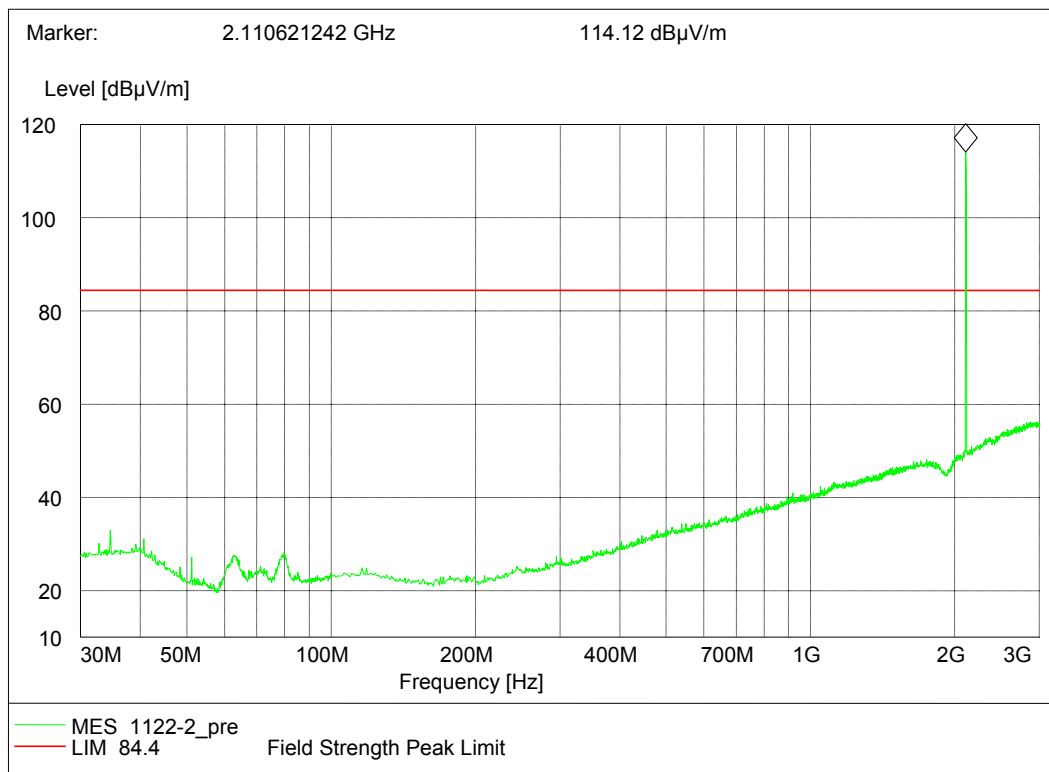

Note: The emission marked is the operating frequency.



3GHz to 18GHz

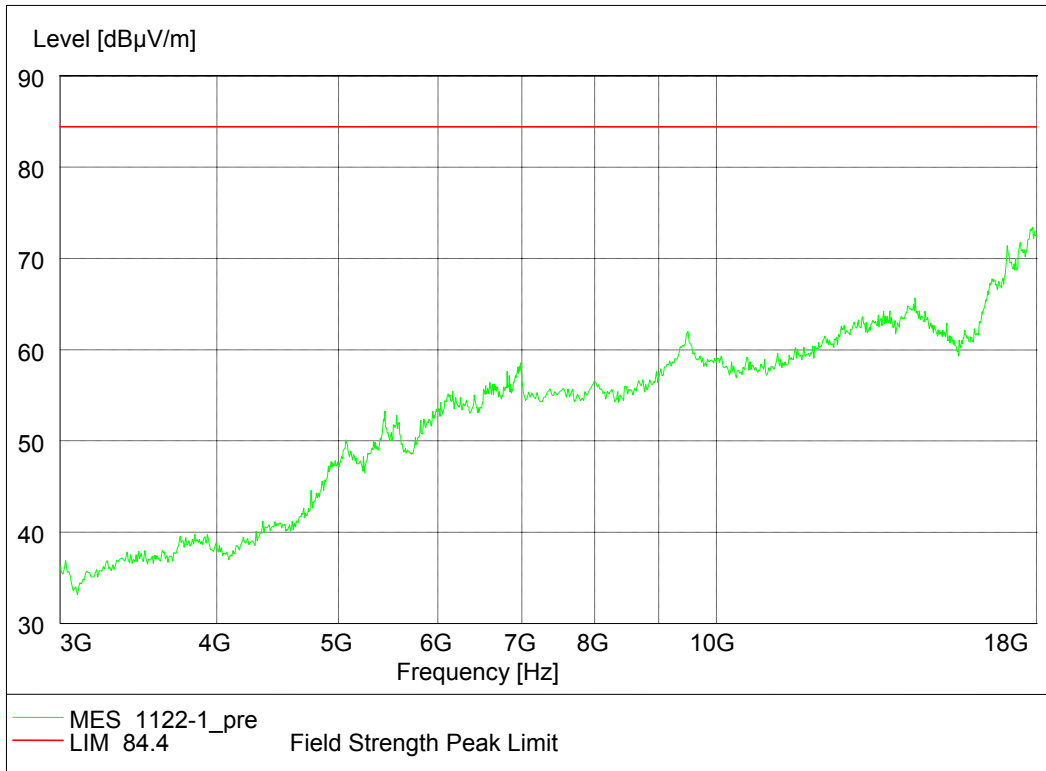

18GHz to 25GHz

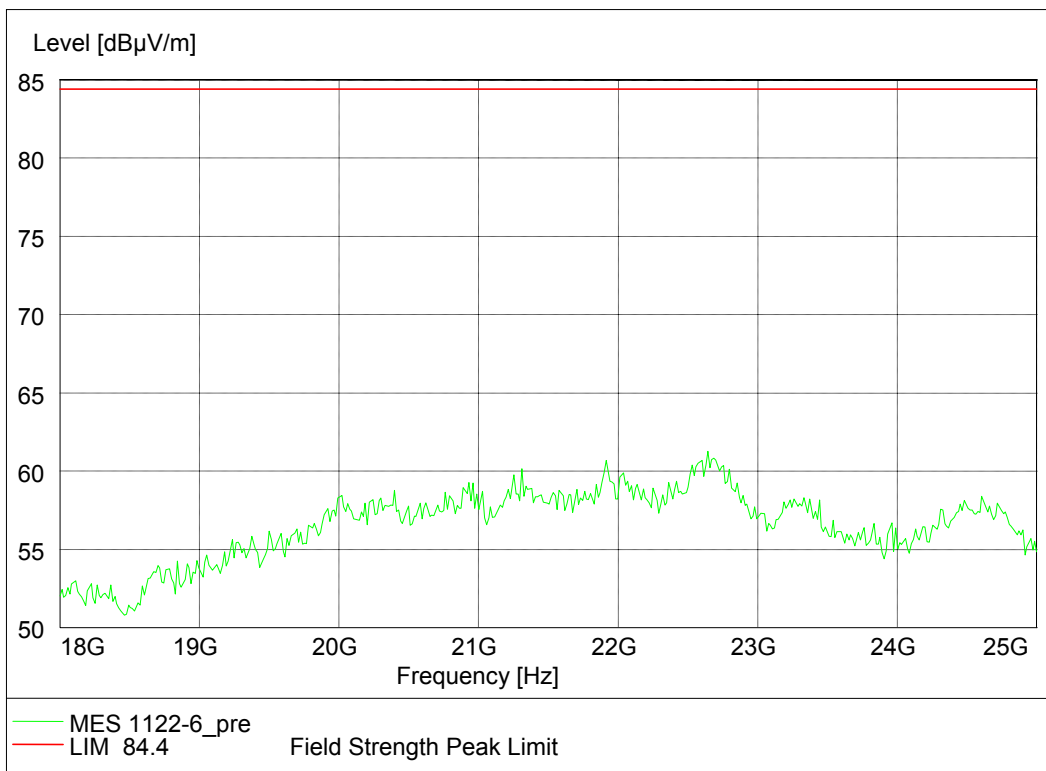



Configuration 1 - Mode 2

No emissions were detected within 20dB of the limit.

Configuration 1 - Mode 3

No emissions were detected within 20dB of the limit.

16QAM

Configuration 1 - Mode 2

No emissions were detected within 20dB of the limit.

Multi Carrier (1x2)

8PSK

Configuration 1 - Mode 4

No emissions were detected within 20dB of the limit.

Limit	-13dBm / 84.4dB μ V/m
-------	---------------------------

Remarks

The EUT does not exceed -13dBm / 84.4dB μ V/m at the measured frequencies.



Product Service

2.7 CONDUCTED SPURIOUS EMISSIONS

2.7.1 Specification Reference

FCC CFR 47 Part 2, Clause 2.1051
 FCC CFR 47 Part 27, Clause 27.53 (h)
 Industry Canada RSS-139, Clause 6.5

2.7.2 Equipment Under Test

RRUS 11 B4 / KRC 161 254/2, S/N: CF81442849

2.7.3 Date of Test and Modification State

04, 05 November 2013 and 13 February 2014 – Modification State 0

2.7.4 Test Equipment Used

The major items of test equipment used for the below tests are identified in Section 3.1.

2.7.5 Test Method and Operating Modes

The test was applied in accordance with the test method requirements of FCC CFR 47 Part 2 and Part 27 and Industry Canada RSS-139.

In accordance with Part 2.1051, the spurious emissions from the antenna terminal were measured. The transmitter output power was attenuated using an attenuator and the frequency spectrum investigated from 9kHz to 22GHz. The EUT was set to transmit on maximum power. The EUT was tested on Bottom, Middle and Top channels. The resolution was set to 1MHz for 9kHz to 22GHz thus meeting the requirements of FCC CFR 47 Part 27, Clause 27.53 (h) and Industry Canada RSS-139, Clause 6.5. The spectrum analyser detector was set to peak and trace was kept on Max Hold.

The maximum path loss across the measurement band was used as the reference level offset to ensure worst case.

Measurements were made up to the 10th harmonic of the highest carrier frequency at least.

The test was performed with the EUT in the following configurations and modes of operation:

Configuration 1 - Mode 1
 - Mode 2
 - Mode 3
 - Mode 7

2.7.6 Environmental Conditions

	04 November 2013	05 November 2013	13 February 2014
Ambient Temperature	23.5°C	23.0°C	22.5°C
Relative Humidity	41.0%	47.0%	38.0%



Product Service

2.7.7 Test Results

For the period of test the EUT met the requirements of FCC CFR 47 Part 2 and Part 27 and Industry Canada RSS-139 for Conducted Spurious Emissions.

The test results are shown below

Remark:

The emissions at 9kHz on the plots was not generated by the test object. A complementary measurement with a smaller span showed that it was related to the LO feedthrough.

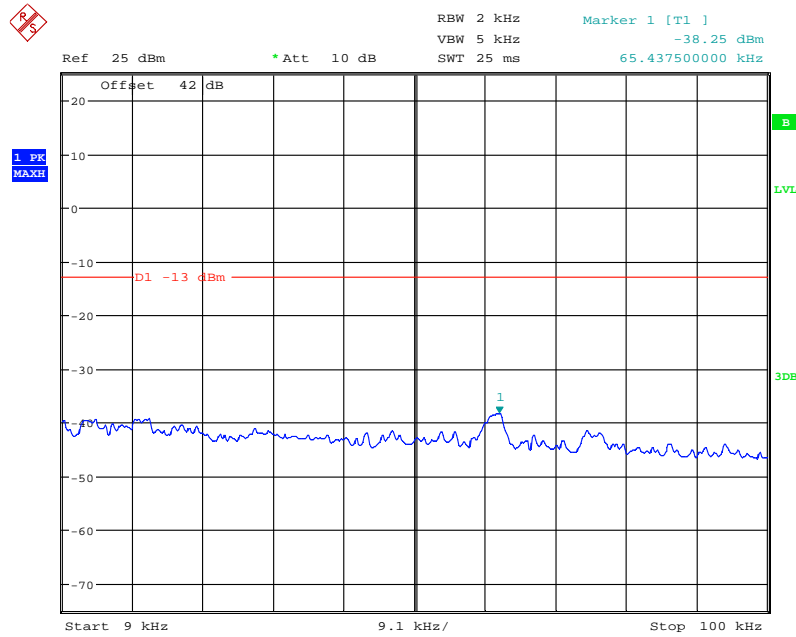

Date: 4.NOV.2013 09:22:12



Product Service

QPSK

Single Carrier

Configuration - Mode 1

9kHz to 3GHz

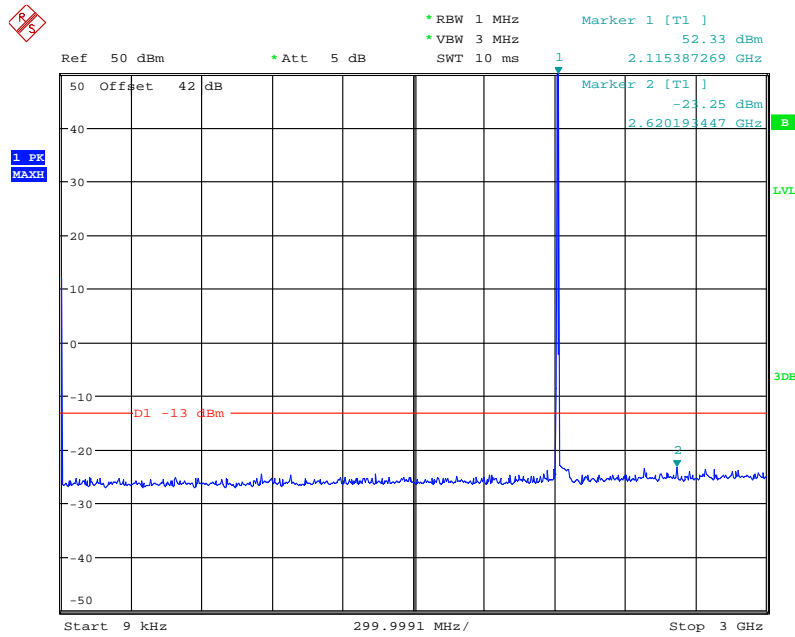

Date: 4.NOV.2013 09:19:38

Note: The emission beyond the limit is the operating frequency.



3GHz to 22GHz

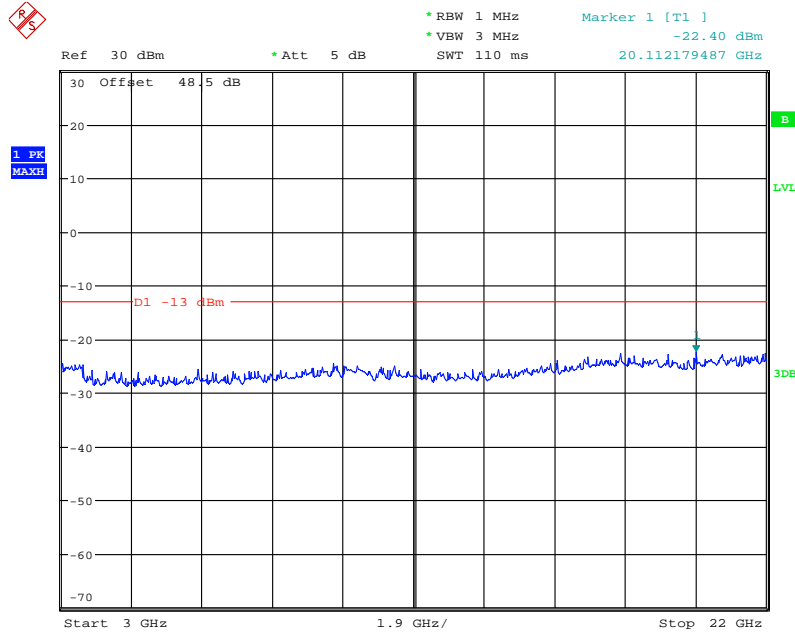

Date: 4.NOV.2013 09:14:10

Configuration 1 - Mode 2

9kHz to 3GHz

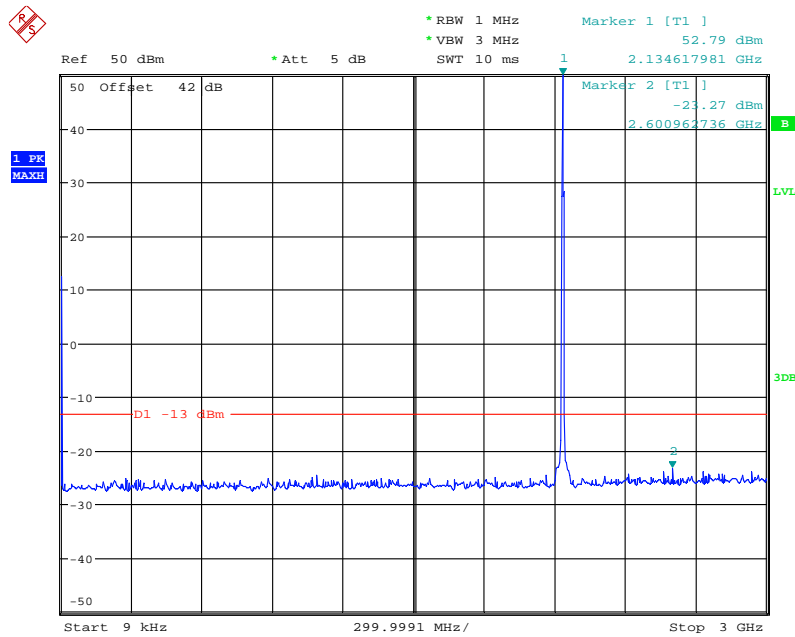

Date: 4.NOV.2013 10:23:59

Note: The emission beyond the limit is the operating frequency.



3GHz to 22GHz

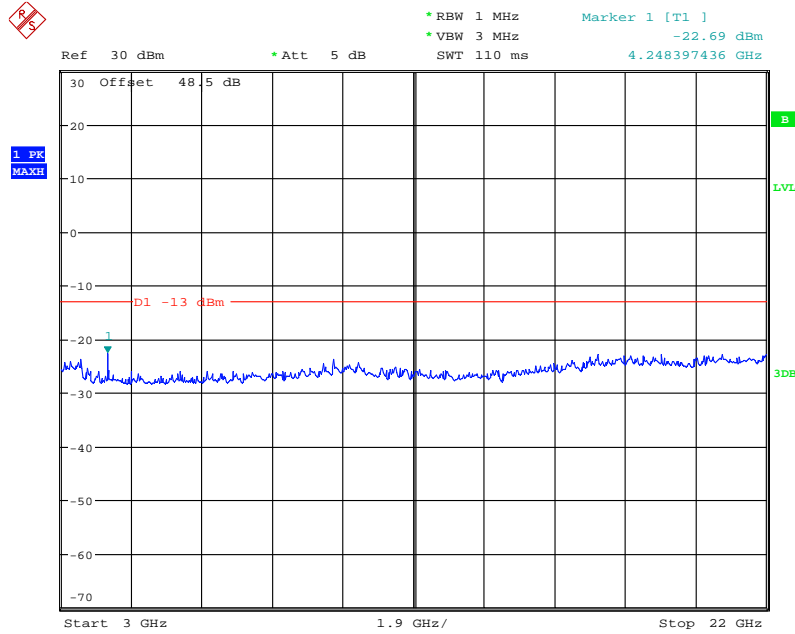

Date: 4.NOV.2013 10:26:44

Configuration 1 - Mode 3

9kHz to 3GHz

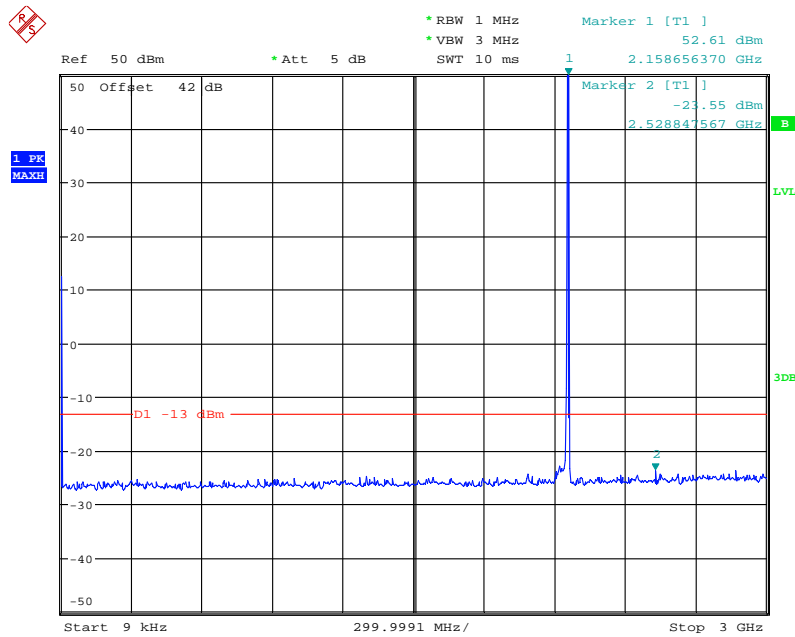

Date: 4.NOV.2013 13:21:58

Note: The emission beyond the limit is the operating frequency.



3GHz to 22GHz

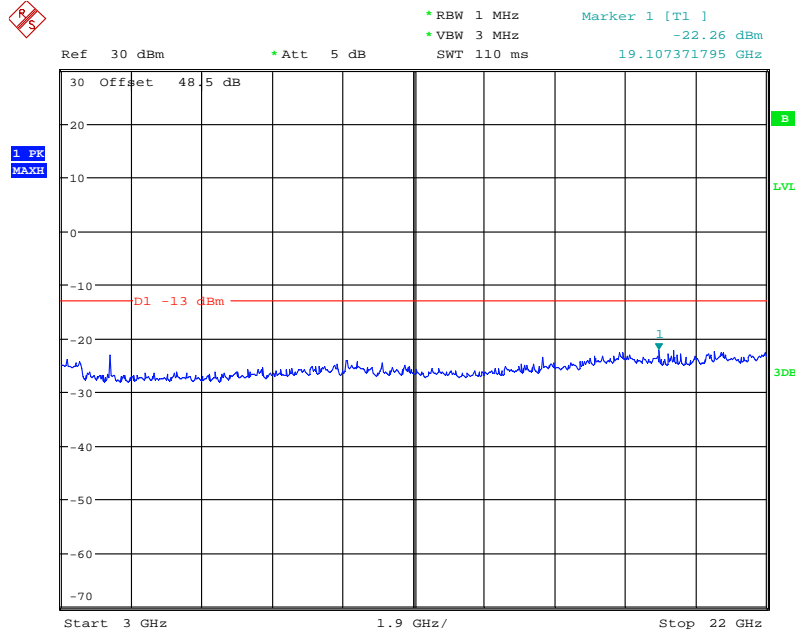

Date: 4.NOV.2013 13:18:11

Multi Carrier (1x2)

Configuration 1 - Mode 7

9kHz to 3GHz

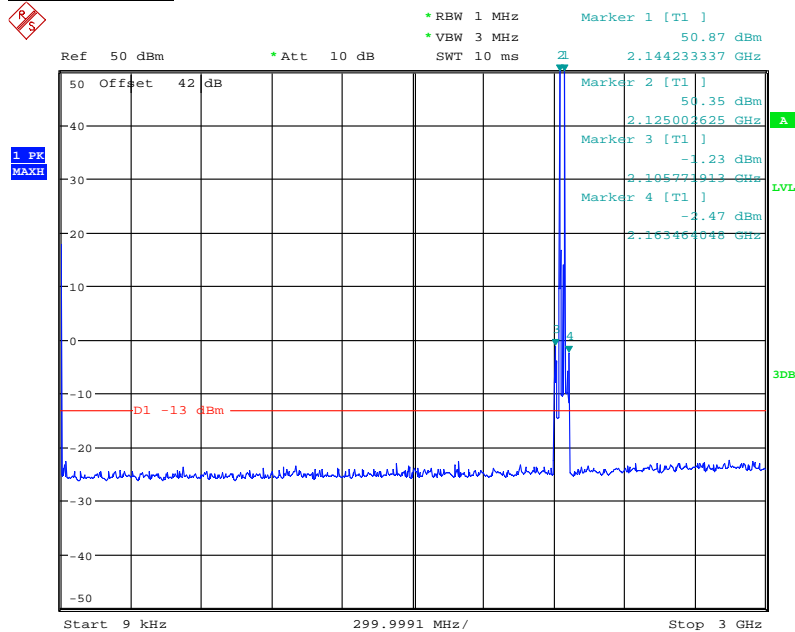

Date: 13.FEB.2014 16:31:29

Note: The emissions above the limit are measured in a smaller bandwidth and using a RMS detector, see the plot on page 63 of 74.



Product Service

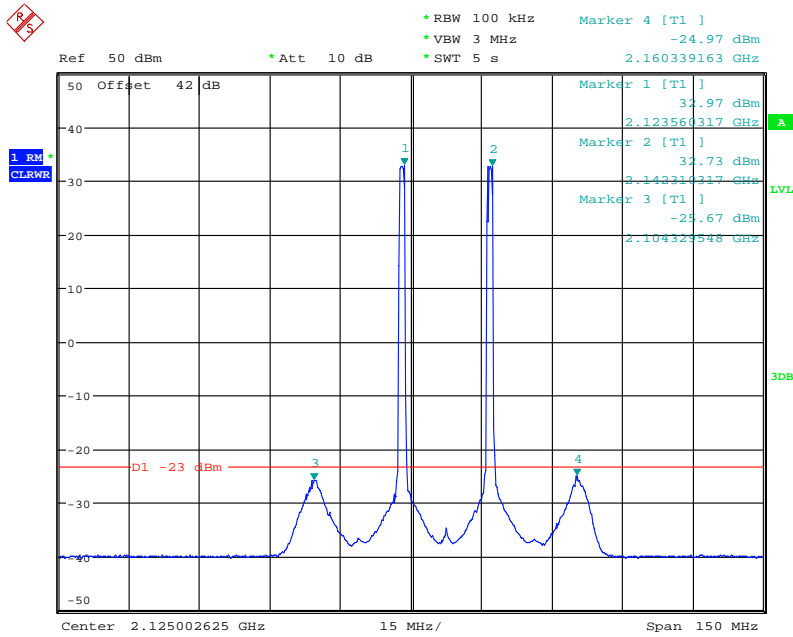

Date: 13.FEB.2014 16:33:29

Note: The limit has been reduced by 10dB to account for the reduction in measurement bandwidth.

3GHz to 22GHz

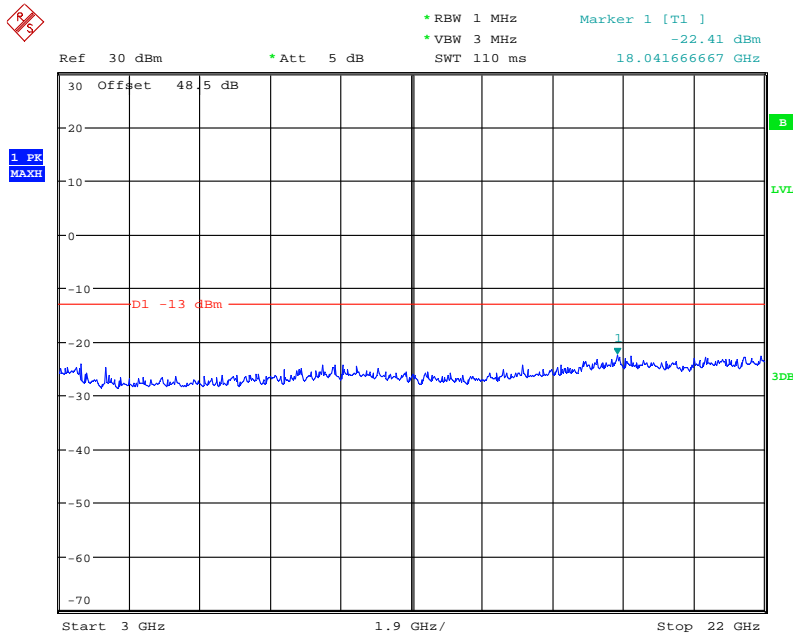

Date: 5.NOV.2013 13:04:23



Product Service

Limit	-13dBm
-------	--------

Remarks

The EUT does not exceed -13dBm at the frequency range of 9kHz to 22GHz.



2.8 FREQUENCY STABILITY UNDER TEMPERATURE VARIATIONS

2.8.1 Specification Reference

FCC CFR 47 Part 2, Clause 2.1055
 FCC CFR 47 Part 27, Clause 27.54
 Industry Canada RSS-139, Clause 6.3

2.8.2 Equipment Under Test

RRUS 11 B4 / KRC 161 254/2, S/N: CF81442849

2.8.3 Date of Test and Modification State

09, 10 and 11 December 2013 – Modification State 0

2.8.4 Test Equipment Used

The major items of test equipment used for the below tests are identified in Section 3.1.

2.8.5 Test Method and Operating Modes

The test was applied in accordance with the test method requirements of FCC CFR 47 Part 2 and Part 27 and Industry Canada RSS-139.

The EUT was set to transmit on maximum power. A Spectrum Analyser was used to measure the frequency error. The temperature was adjusted between -30°C and +50°C in 10° steps as per FCC Part 2.1055.

The EUT was tested at its maximum power level, modulation using QPSK as the representative test modulation. The path loss measured and entered as a reference level offset.

The test was performed with the EUT in the following configurations and modes of operation:

Configuration 1 - Mode 2

2.8.6 Environmental Conditions

	09 December 2013	10 December 2013	11 December 2013
Ambient Temperature	24.5°C	24.0°C	24.5°C
Relative Humidity	49.0%	45.0%	46.0%



Product Service

2.8.7 Test Results

For the period of test the EUT met the requirements of FCC CFR 47 Part 2 and Part 27 and Industry Canada RSS-139 for Frequency Stability Under Temperature Variations.

The test results are shown below

Power Supply: -48V DC

Single Carrier

QPSK

Configuration 1 - Mode 2

Temperature Interval (°C)	Deviation (Hz)
-30	-22.02
-20	-19.87
-10	-24.27
0	+25.50
+10	-25.59
+20	-23.65
+30	-27.99
+40	+33.77
+50	-23.00

Limit	± 0.05 ppm or ± 102.63 Hz*
-------	------------------------------------

Remarks

* Limit according to 3GPP2 C.S0032-C Ver.1.0.

The frequency stability of the EUT is sufficient to keep it within the authorised frequency ranges at any temperature interval across the measured range.



2.9 FREQUENCY STABILITY UNDER VOLTAGE VARIATIONS

2.9.1 Specification Reference

FCC CFR 47 Part 2, Clause 2.1055
FCC CFR 47 Part 27, Clause 27.54
Industry Canada RSS-139, Clause 6.3

2.9.2 Equipment Under Test

RRUS 11 B4 / KRC 161 254/2, S/N: CF81442849

2.9.3 Date of Test and Modification State

10 December 2013 – Modification State 0

2.9.4 Test Equipment Used

The major items of test equipment used for the below tests are identified in Section 3.1.

2.9.5 Test Method and Operating Modes

The test was applied in accordance with the test method requirements of FCC CFR 47 Part 2 and Part 27 and Industry Canada RSS-139.

The EUT was set to transmit on maximum power. A Spectrum Analyser was used to measure the frequency error. The supplied voltage was varied from 85 to 115 percent of the nominal value.

The EUT was tested at its maximum power level, modulation using QPSK as the representative test modulation. The path loss measured and entered as a reference level offset.

The test was performed with the EUT in the following configuration and mode of operation:

Configuration 1 - Mode 2

2.9.6 Environmental Conditions

	10 December 2013
Ambient Temperature	24.0°C
Relative Humidity	45.0%



2.9.7 Test Results

For the period of test the EUT met the requirements of FCC CFR 47 Part 2 and Part 27 and Industry Canada RSS-139 for Frequency Stability Under Voltage Variations.

The test results are shown below

Temperature: 20°C

Single Carrier

QPSK

Configuration 1 - Mode 2

DC Voltage (V)	Deviation (Hz)
-40.8	-22.73
-48.0	-23.65
-55.2	+27.86

Limit	± 0.05 ppm or ± 102.63 Hz*
-------	------------------------------------

Remarks

* Limit according to 3GPP2 C.S0032-C Ver.1.0.

The frequency stability of the EUT is sufficient to keep it within the authorised frequency ranges under voltage variations across the measured range.



Product Service

SECTION 3

TEST EQUIPMENT USED



3.1 TEST EQUIPMENT USED

List of absolute measuring and other principal items of test equipment.

Instrument	Manufacturer	Type No.	Serial No.	Calibration Period (months)	Calibration Due
Section 2.1, 2.2, 2.3, 2.4, 2.5, 2.7– Maximum Conducted Output Power, Peak – Average Ratio, Modulation Characteristics, Occupied Bandwidth, Spurious Emissions at Antenna Terminals (± 1MHz) and Conducted Spurious Emissions.					
Spectrum Analyser	Rohde & Schwarz	FSQ26	101127	12	04-Aug-2014
Spectrum Analyser	Rohde & Schwarz	FSQ26	100253	12	04-Aug-2014
Power Meter	Rohde & Schwarz	NRP2	101593	12	04-Aug-2014
Power Sensor	Rohde & Schwarz	NRP-Z51	102123	12	04-Aug-2014
Network Analyzer	Agilent	8720D	US36140166	12	26-Sep-2014
40dB Attenuator	Aeroflex / Weinschel	48-40-43-LIM	BR5020	-	O/P MON
Pass Filter	K&L	ULK 904 098/2	16	-	O/P MON
Load	Shanghai Huaxiang	TF100	09121648	-	O/P MON
Power Supply	Dahua	DH1716-5D	2008040041	-	O/P MON
Power Supply	Dahua	DH1716-5D	2008040050	-	O/P MON
Digital Multimeter	FLUKE	179	91820401	12	13-Dec-2013
Thermo-hygrometer	AZ Instruments	8705	9151665	12	16-Dec-2013
Digital Multimeter	FLUKE	179	91820401	12	24-Dec-2014
Thermo-hygrometer	AZ Instruments	8705	9151665	12	12-Dec-2014
Section 2.6 – Radiated Spurious Emissions					
Load	Shanghai Huaxiang	TF100	09121648	-	O/P MON
Load	Shanghai Huaxiang	TF100	09121605	-	O/P MON
EMI Receiver	Rohde & Schwarz	ESI 40	100015	12	19-Aug-2014
Ultra log test antenna	Rohde & Schwarz	HL562	100167	12	19-Aug-2014
Double-Ridged Waveguide Horn Antenna	Rohde & Schwarz	HF 906	100029	12	19-Aug-2014
Pyramidal Horn Antenna	EMCO	3160-09	-	-	-
Antenna master	Frankonia	MA 260	-	12	19-Aug-2014
Relay Switch Unit	Rohde & Schwarz	331.1601.31	338965002	-	TU
Semi Anechoic Chamber	Frankonia	23.18m×16.88 m×9.60m	-	12	19-Aug-2014
Power Supply	Dahua	DH1716-5D	2008040041	-	O/P MON
Power Supply	Dahua	DH1716-5D	2008040050	-	O/P MON
Digital Multimeter	FLUKE	179	91820401	12	24-Dec-2014
Thermo-hygrometer	AZ Instruments	8705	9151665	12	12-Dec-2014



Product Service

Instrument	Manufacturer	Type No.	Serial No.	Calibration Period (months)	Calibration Due
Section 2.8 and 2.9 – Frequency Stability Under Temperature and Voltage Variations					
Spectrum Analyser	Rohde & Schwarz	FSQ26	100253	12	04-Aug-2014
40dB Attenuator	Aeroflex / Weinschel	48-40-43-LIM	BR5020	-	O/P MON
Temperature Chamber	ZUNDAR	ZT1000	10080064	-	O/P MON
Power Supply	Dahua	DH1716-5D	2008040041	-	O/P MON
Digital Multimeter	FLUKE	179	91820401	12	24-Dec-2014
Thermo-hygrometer	AZ Instruments	8705	9151665	12	12-Dec-2014

O/P MON Output monitored with calibration equipment
 TU Traceability Unscheduled



Product Service

3.2 MEASUREMENT UNCERTAINTY

For a 95% confidence level, the measurement uncertainties for defined systems are:-

Test Discipline	Frequency / Parameter	MU
Conducted RF Output Power	30MHz to 10GHz Amplitude	0.5dB*
Conducted Emissions	30MHz to 40GHz Amplitude	3.0dB*
Frequency Stability		$<1 \times 10^{-7}$
Radiated Emissions, Bilog Antenna, AOATS	30MHz to 1GHz Amplitude	5.1dB*
Radiated Emissions, Horn Antenna, AOATS	1GHz to 40GHz Amplitude	6.3dB*
Worst case error for both Time and Frequency measurement 12 parts in 10^6		

* In accordance with CISPR 16-4



Product Service

SECTION 4

ACCREDITATION, DISCLAIMERS AND COPYRIGHT



4.1 ACCREDITATION, DISCLAIMERS AND COPYRIGHT



This report relates only to the actual item/items tested.

Our UKAS Accreditation does not cover opinions and interpretations and any expressed are outside the scope of our UKAS Accreditation.

Results of tests not covered by our UKAS Accreditation Schedule are marked NUA
(Not UKAS Accredited).

This report must not be reproduced, except in its entirety, without the written permission of
TÜV SÜD Product Service

© 2014 TÜV SÜD SÜD Product Service