

Handled by, department
Jonas Bremholt
Electronics
+46 (0)33 16 54 38, jonas.bremholt@sp.se

ERICSSON AB
RTG/I Mats Falk
Lindholmospiren 11
417 56 GÖTEBORG

Equipment authorization measurements on WCDMA Base Station Transceiver Unit with FCC ID: TA8AROJ1192289-1 (8 appendices)

Test object

Transceiver unit ROJ 119 2289/1

Summary

Standard	Compliant	Appendix	Remarks
FCC CFR 47			
2.1046 RF power output	Yes	2	-
2.1049 Occupied bandwidth	Yes	3	-
2.1051 Band edge	Yes	4	-
2.1051 Spurious emission at antenna terminals	Yes	5	-
2.1053 Field strength of spurious radiation	Yes	6	-
2.1055 Frequency stability	Yes	7	-

SP Swedish National Testing and Research Institute Electronics - EMC



Lasse Bergsten
Deputy Technical Manager



Jonas Bremholt
Technical Officer

SP Swedish National Testing and Research Institute

Postal address
SP
Box 857
SE-501 15 Borås
SWEDEN

Office location
Västeråsen
Brinellgatan 4
Borås

Phone / Fax / E-mail
+46 33 16 50 00
+46 33 13 55 02
info@sp.se

Laboratories are accredited by the Swedish Board for Accreditation and Conformity Assessment (SWEDAC) under the terms of Swedish legislation. This report may not be reproduced other than in full, except with the prior written approval of the issuing laboratory.



FCC ID: TA8AROJ1192289-1

Table of contents

Description of the test object	Appendix 1
Operation mode during measurements	Appendix 1
Test setups	Appendix 1
Purpose of test	Appendix 1
RF power output	Appendix 2
Occupied bandwidth	Appendix 3
Band edge	Appendix 4
Spurious emission at antenna terminals	Appendix 5
Field strength of spurious radiation	Appendix 6
Frequency stability	Appendix 7
Photos	Appendix 8



FCC ID: TA8AROJ1192289-1

Appendix 1

Description – Test object

Equipment: WCDMA Transceiver unit (sTRX) 1900 MHz, single carrier

Tx Frequency range: 1932.5-1987.5 MHz

Modulations: QPSK and 16QAM

Maximum output power: 42.4 dBm (17.4 W)

Nominal power voltage: -48 VDC

Tested channels

ARFCN	Frequency
412	1932.5 MHz
537	1957.5 MHz
687	1987.5 MHz

Operation mode during measurements**Test models**

All measurements were performed with the test object configured with the Test models 1 and 5 as defined in 3GPP TS 25.141. Test model 1 use the QPSK modulation only, and Test model 5 includes the 16QAM modulation.

Test model 1: 64 DPCH:s at 30 ksps (SF=128)

Test model 5: 6 DPCH:s at 30 ksps (SF=128) and 2 HS-PDSCH:s at 240 ksps (SF=16)

Conducted measurements

All RF conducted measurements were performed with the test object installed in a RBS 3303 cabinet powered with -48 VDC. All measurements were done at the output connector (Ant A) of the single Antenna Interface Unit (sAIU) KRY 112 123/1. All measurements were performed at maximum output power with both modulations.

Radiated measurements

All radiated measurements were performed with the test object installed in a RBS 3303 cabinet powered with -48 VDC.

The sTRX was activated for maximum transmit power. The sTRX was sequentially allocated to UARFCN 412 (1932.5 MHz) and 687 (1987.5 MHz) for downlink and to UARFCN 12 (1852.5 MHz) and 287 (1907.5 MHz) for uplink.

Purpose of test

The purpose of the tests is to verify compliance to the performance characteristics specified in FCC CFR 47.



FCC ID: TA8AR0J1192289-1

Appendix 1

References

Measurements were done according to relevant parts of the following standards:

ANSI/TIA/EIA-603-B-2002

3GPP TS 25.141

Reservation

The test results in this report apply only to the particular test object as declared in the report.

Delivery of test object

The test object was delivered: 2005-06-13

Manufacturer's representative

Jan-Olof Karlsson, Ericsson AB

Test engineers

Reinhold Reul and Jonas Bremholt

Test witness

Ronny Hansson, Ericsson AB

Test set-up, conducted measurements

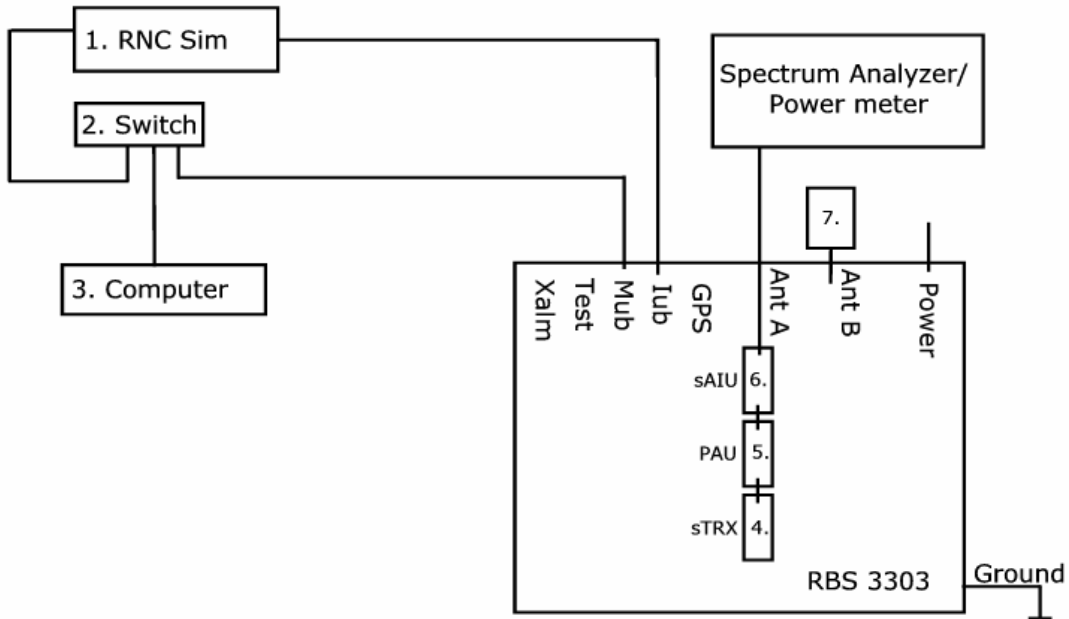

RBS 3303: FAR 102 123/6, R-state R1A with software CXP 901 0810 rev. P9BA
Enclosure: BDE 202 85/1, R-state: R1C, Serial No: S781303814

1. RNC Sim CES 4780BA Mini-sim#14, Serial no.: 02101
2. Switch, Netgear Ethernet switch DS108
3. Computer, Naturetech, ETE ASSET ID: 207505
4. ROJ 119 2289/1 Rev. R1H, Serial No: AE51888840 (FCC ID: TA8AROJ1192289-1)
5. KRB 901 17/1 Rev. R1C, Serial no: BN60000215 (FCC ID: TA8AKRB90117-1)
6. KRY 112 123/1, Rev. R2A, Serial no: A400240185
7. 50 ohm terminator

Interfaces:

Power, -48 VDC
Iub, configured as T1 by CBU, shielded multi-wire with RJ-45 connector
Mub, shielded multi-wire with RJ-45 connector
Test, no cable attached
Xalm, no cable attached.
GPS, no cable attached.

Type of port:

DC power
Telecom
Test purpose
Test purpose
Signal
Signal

Test set-up, radiated measurements

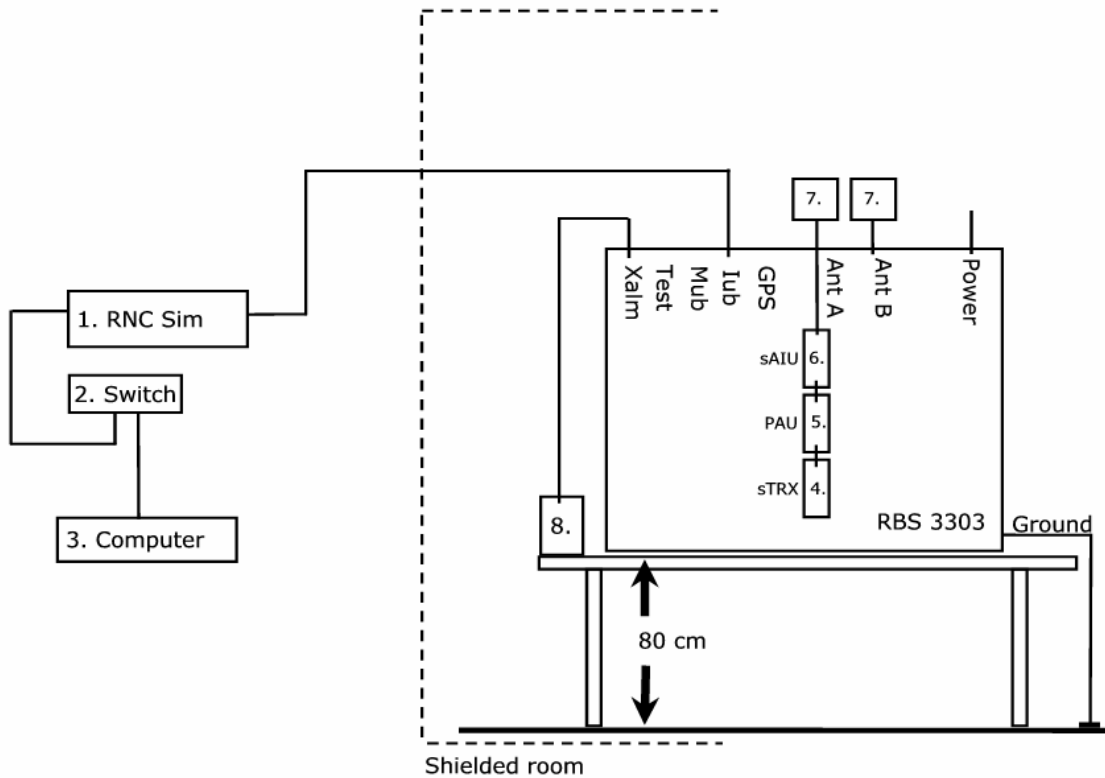

RBS 3303: FAR 102 123/6, R-state R1A with software CXP 901 0810 rev. P9BA
Enclosure: BDE 202 85/1, R-state: R1C, Serial No: S781303814

1. RNC Sim CES 4780BA Mini-sim#14, Serial no.: 0210
2. Switch, Netgear Ethernet switch DS108
3. Computer, Naturetech, ETE ASSET ID: 207505
4. ROJ 119 2289/1 Rev. R1H, Serial No: AE51888841 (FCC ID: TA8AROJ1192289-1)
5. KRB 901 17/1 Rev. R1C, Serial no: BN60000215 (FCC ID: TA8AKRB90117-1)
6. KRY 112 123/1, Rev. R2A, Serial no: A400240185
7. 50 ohm terminators
8. Xalm connection box

Interfaces:

Power, -48 VDC
Iub, configured as T1 by CBU, shielded multi-wire with RJ-45 connector
Mub, no cable attached
Test, no cable attached
Xalm, Multi-wire TEL 431 01/013
GPS, no cable attached

Type of port:

DC power
Telecom
Test purpose
Test purpose
Signal
Signal



RF power output measurements according to 47 CFR 2.1046

Date 2005-06-17	Temperature 22 °C ± 3 °C	Humidity 64 % ± 5 %
--------------------	-----------------------------	------------------------

Test set-up and procedure

The output was connected to a Peak power analyzer. The transmitter was set up according to Test model 1 and Test model 5 during the measurements.

Measurement equipment	Calibration Due	SP number
Boonton RF Peak power meter/analyzer	2005-08	503 144
Boonton Power sensor 56518-S/4	2005-08	503 145
Multimeter Fluke 87	2005-11	502 190
Testo 610, Temperature and humidity meter	2006-12	502 658

Measurement uncertainty: 0.5 dB

Results

Rated output power level after sAIU (maximum): 42.4 dBm

Test conditions T _{nom} 22 °C/ V _{nom} -48 V DC	Transmitter power (dBm) Average		
	Frequency 1932.5	Frequency 1957.5	Frequency 1987.5
QPSK	42.6	42.9	42.6
16QAM	42.6	43.0	42.7

Limit

§24.232: Maximum output power shall not exceed 100W (50dBm).

Complies?	Yes
-----------	-----

Occupied bandwidth measurements according to 47 CFR 2.1049

Date 2005-06-17	Temperature 22 °C ± 3 °C	Humidity 64 % ± 5 %
--------------------	-----------------------------	------------------------

Test set-up and procedure

The measurements were made per definition in §2.1049. The output was connected to a spectrum analyzer. The spectrum analyzer was connected to an external 10 MHz reference standard during the measurements. The transmitter was set up according to Test model 1 and Test model 5 during the measurements.

Measurement equipment	Calibration Due	SP number
R&S FSIQ	2005-07	503 738
Testo 610, Temperature and humidity meter	2006-12	502 658

Measurement uncertainty: 3.7 dB

Results

The results are shown in appendix 3.1

QPSK

OBW 4.2 MHz

Diagram 1 1957.5 MHz

16QAM

OBW 4.2 MHz

Diagram 2 1957.5 MHz



FCC ID: TA8AROJ1192289-1

Appendix 3.1

Diagram 1

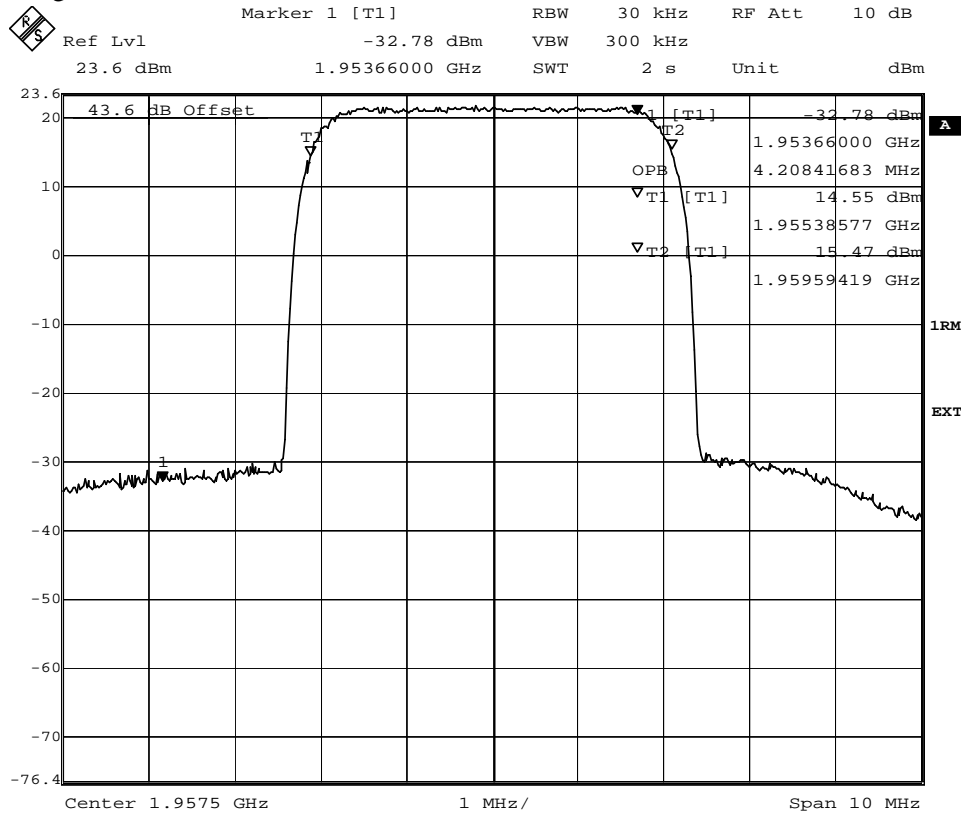

Date: 17.JUN.2005 09:09:13

Diagram 2

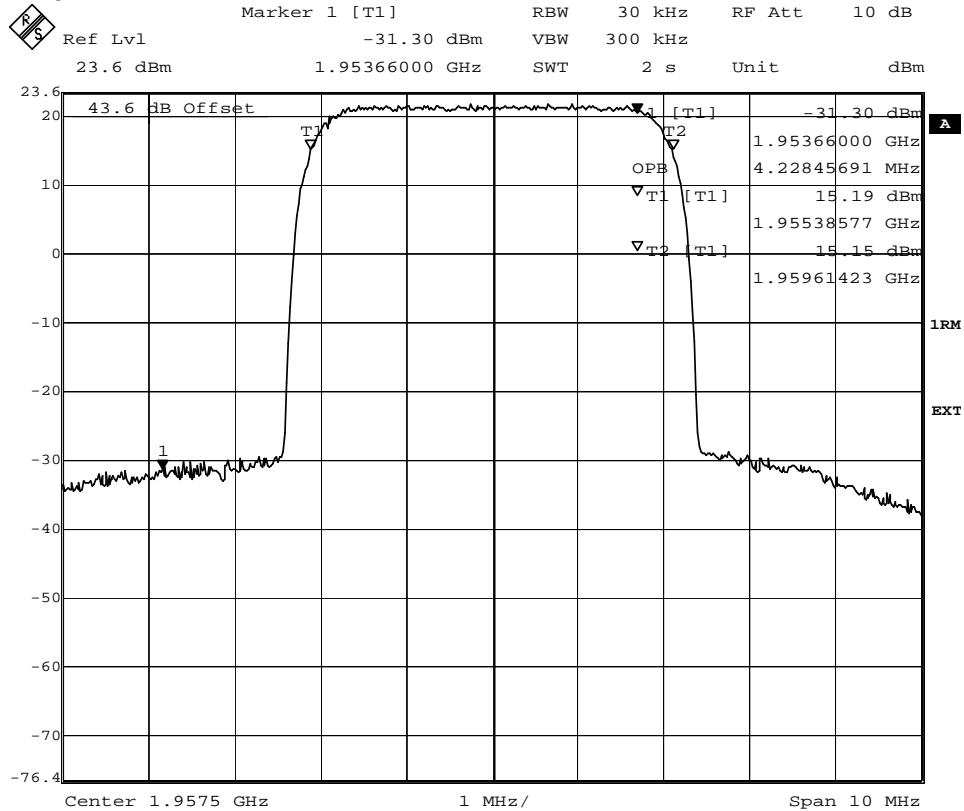

Date: 17.JUN.2005 09:04:59

**Band edge measurements according to 47 CFR 2.1051**

Date 2005-06-17	Temperature 22 °C ± 3 °C	Humidity 64 % ± 5 %
--------------------	-----------------------------	------------------------

Test set-up and procedure

The measurements were made per definition in §24.238. The output was connected to a spectrum analyzer with the RMS detector activated. The spectrum analyzer was connected to an external 10 MHz reference standard during the measurements. A resolution bandwidth of 50 kHz (1% of Emission BW) was used up to 5 MHz away from the band edges. As the FCC rules specify a RBW of 1 MHz for measurements of emissions >1 MHz away from the band edges, the limit was adjusted with 13 dB to -26 dBm to compensate for the reduced measurement bandwidth. The transmitter was set up according to Test model 1 and Test model 5 during the measurements.

Measurement equipment	Calibration Due	SP number
R&S FSIQ	2005-07	503 738
Testo 610, Temperature and humidity meter	2006-12	502 658

Measurement uncertainty: 3.7 dB

Results

The results are shown in appendix 4.1

QPSK

- Diagram 1 1932.5 MHz Band edge
- Diagram 2 1987.5 MHz Band edge

16QAM

- Diagram 3 1932.5 MHz Band edge
- Diagram 4 1987.5 MHz Band edge

Limits

The power of any emission outside the frequency band shall be attenuated below the transmitter power (P) by at least $43 + 10 \log P$ dB.

Complies?	Yes
-----------	-----



FCC ID: TA8AROJ1192289-1

Appendix 4.1

Diagram 1

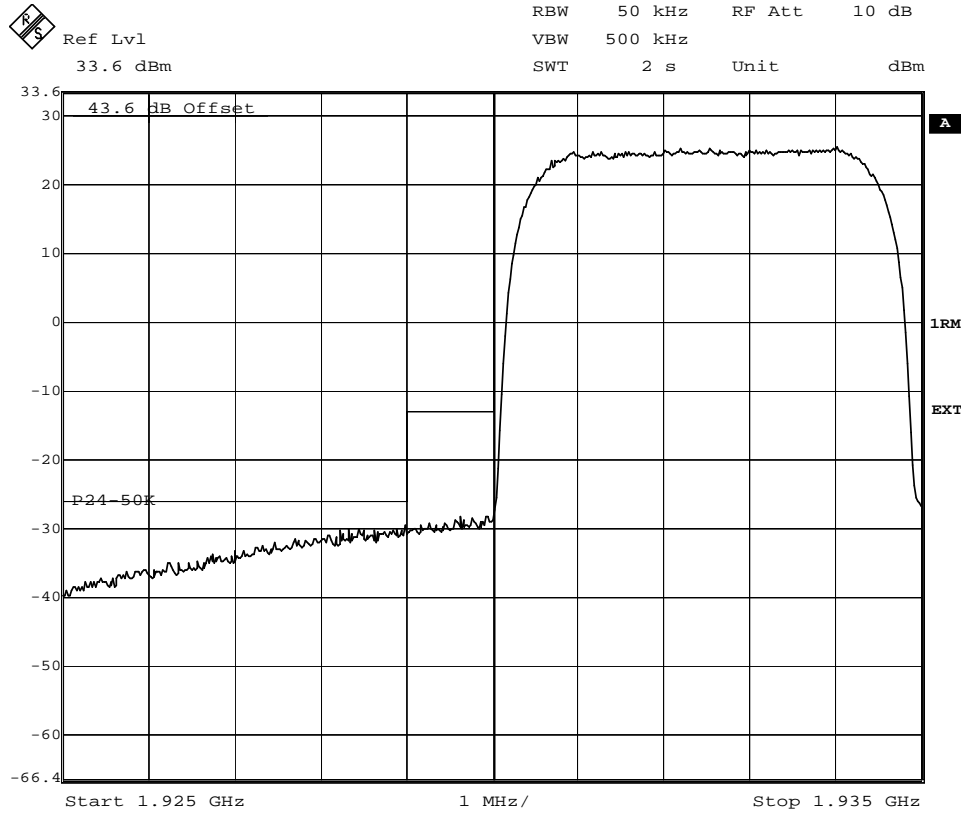

Date: 17.JUN.2005 11:15:41

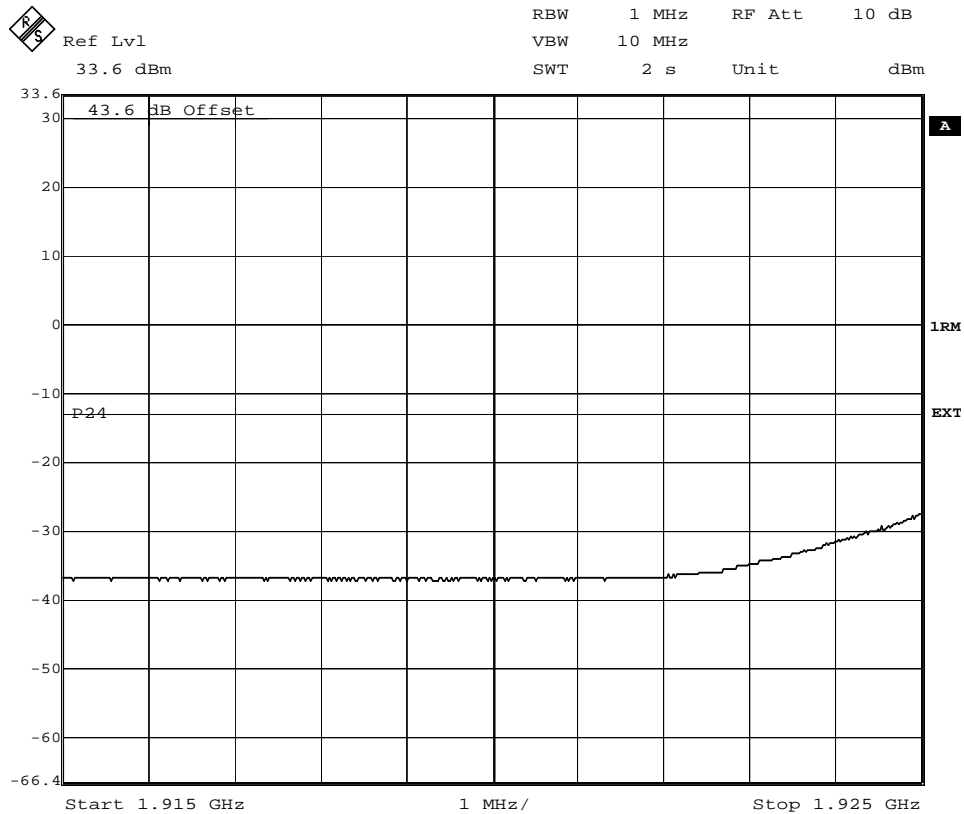

Date: 17.JUN.2005 11:14:17



FCC ID: TA8AROJ1192289-1

Appendix 4.1

Diagram 2

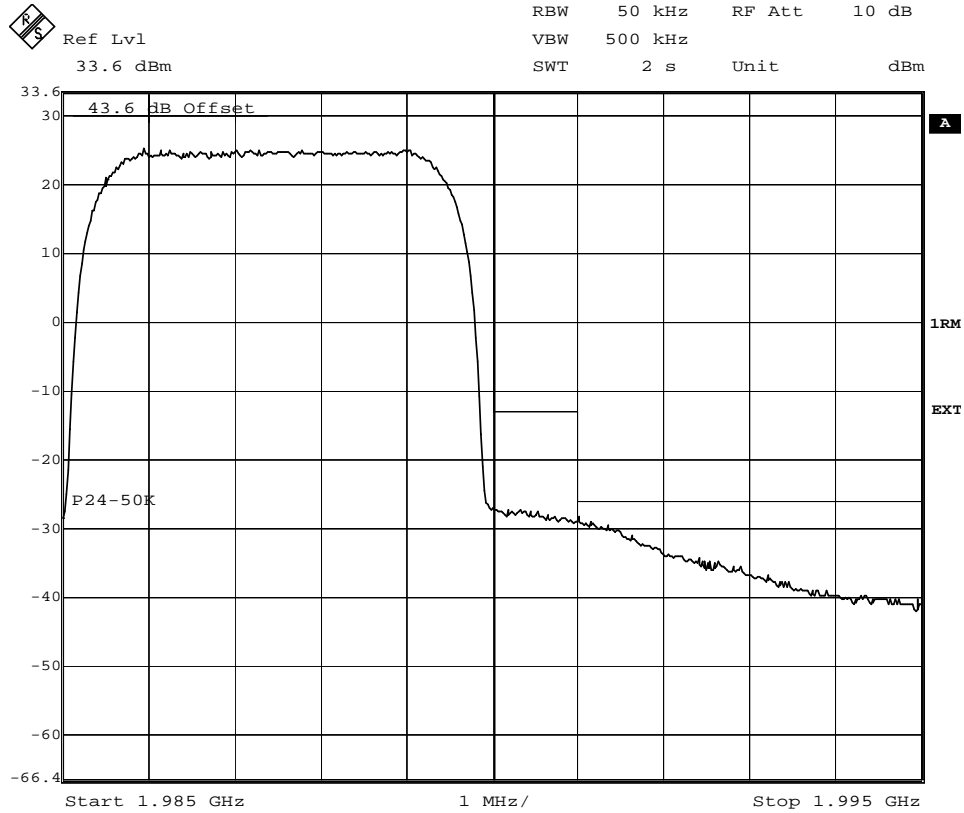

Date: 17.JUN.2005 12:05:03

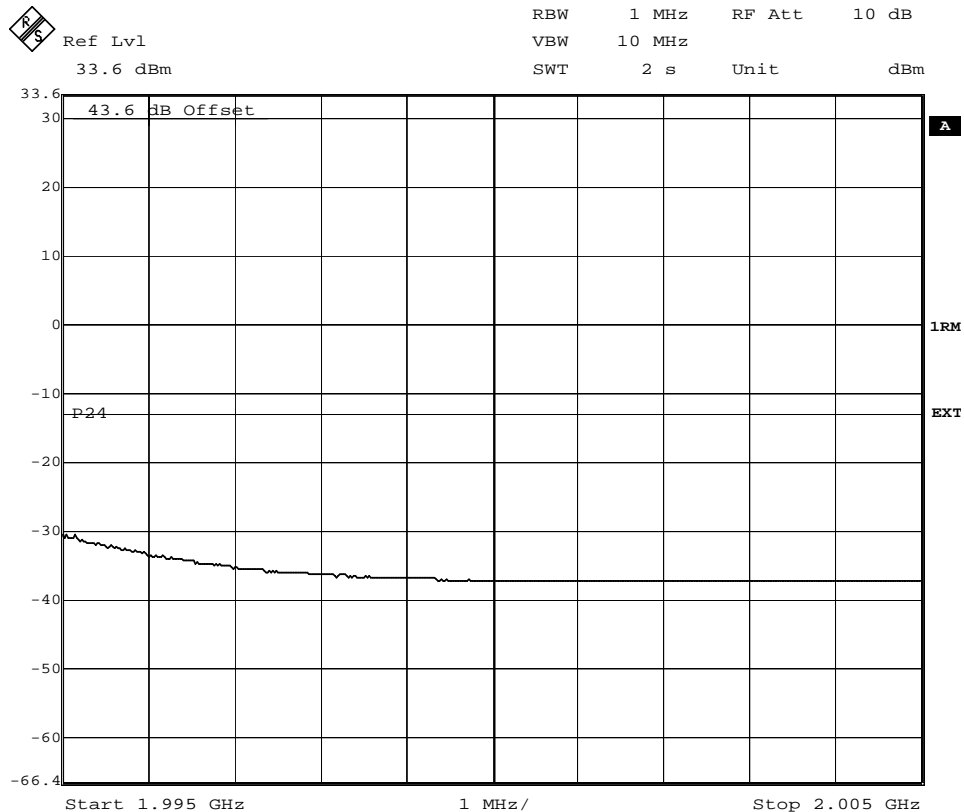

Date: 17.JUN.2005 12:06:47



FCC ID: TA8AROJ1192289-1

Appendix 4.1

Diagram 3

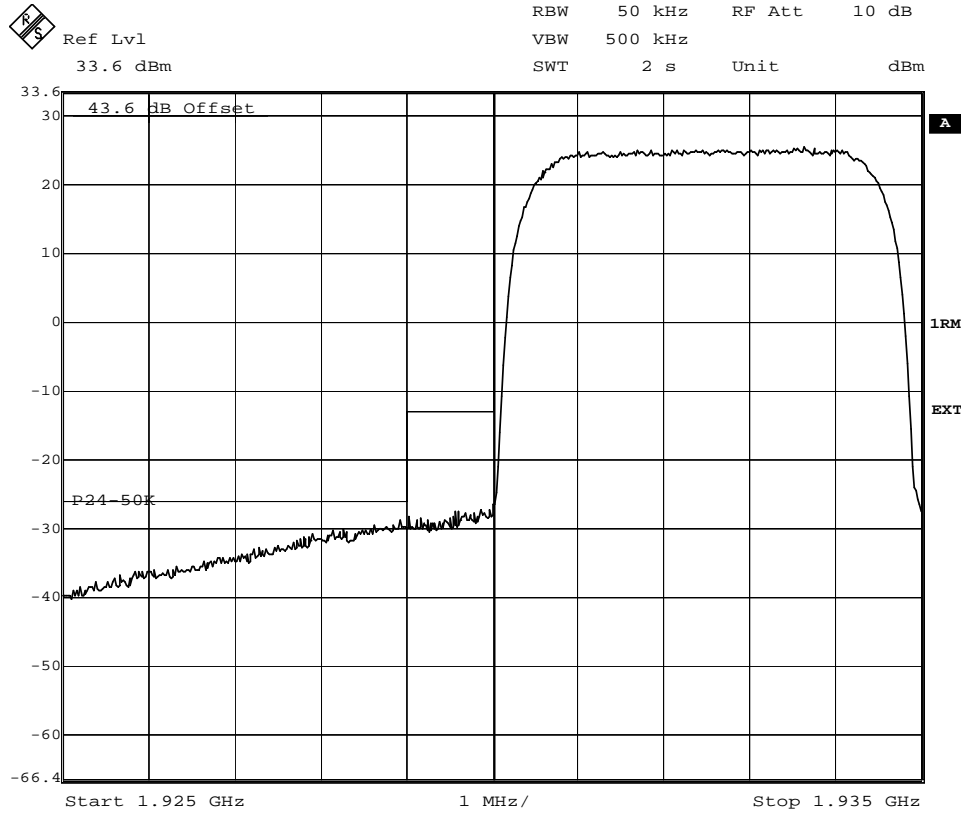

Date: 17.JUN.2005 11:04:26

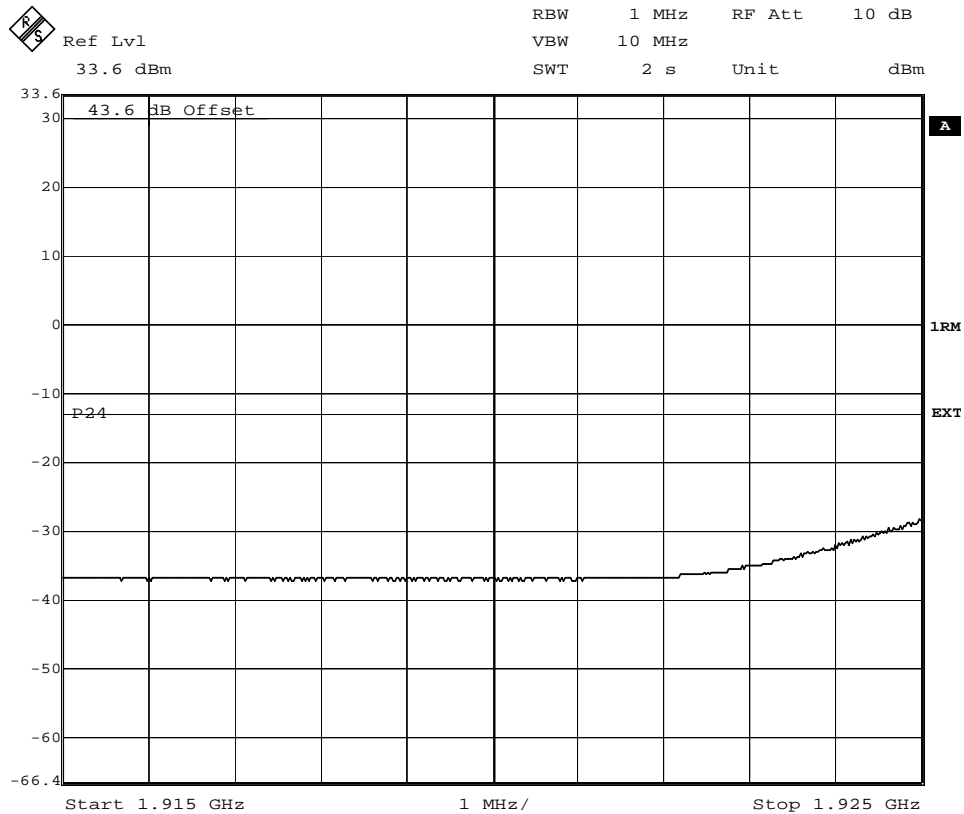

Date: 17.JUN.2005 11:08:24



FCC ID: TA8AROJ1192289-1

Appendix 4.1

Diagram 4

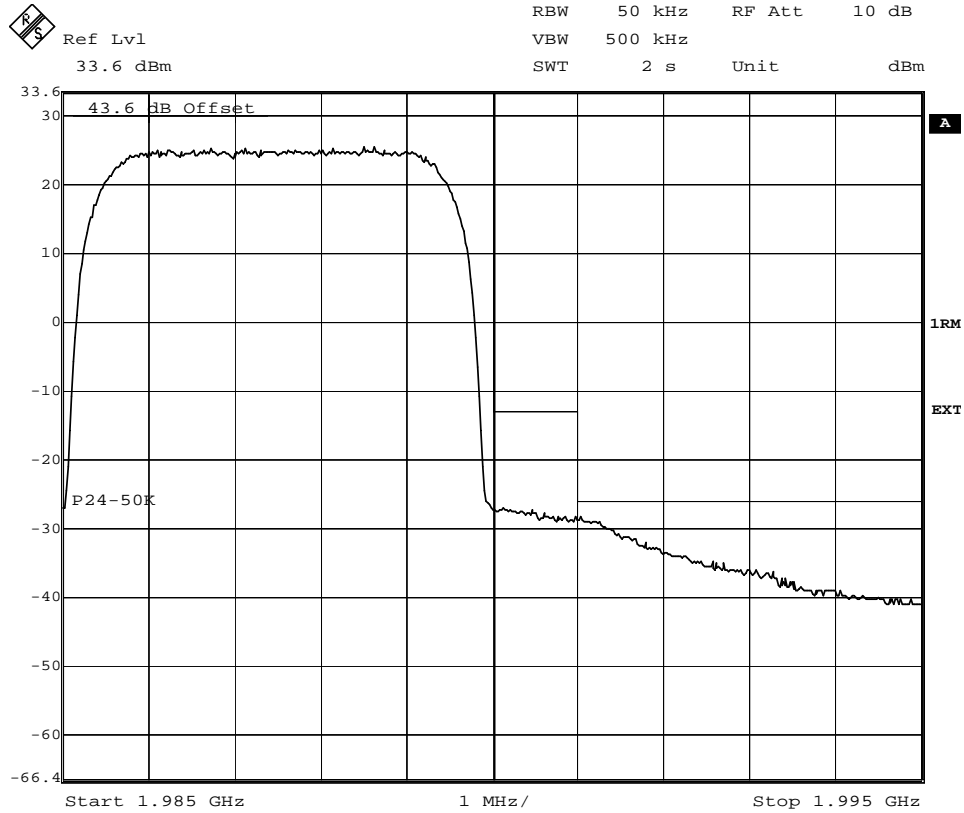

Date: 17.JUN.2005 12:11:51

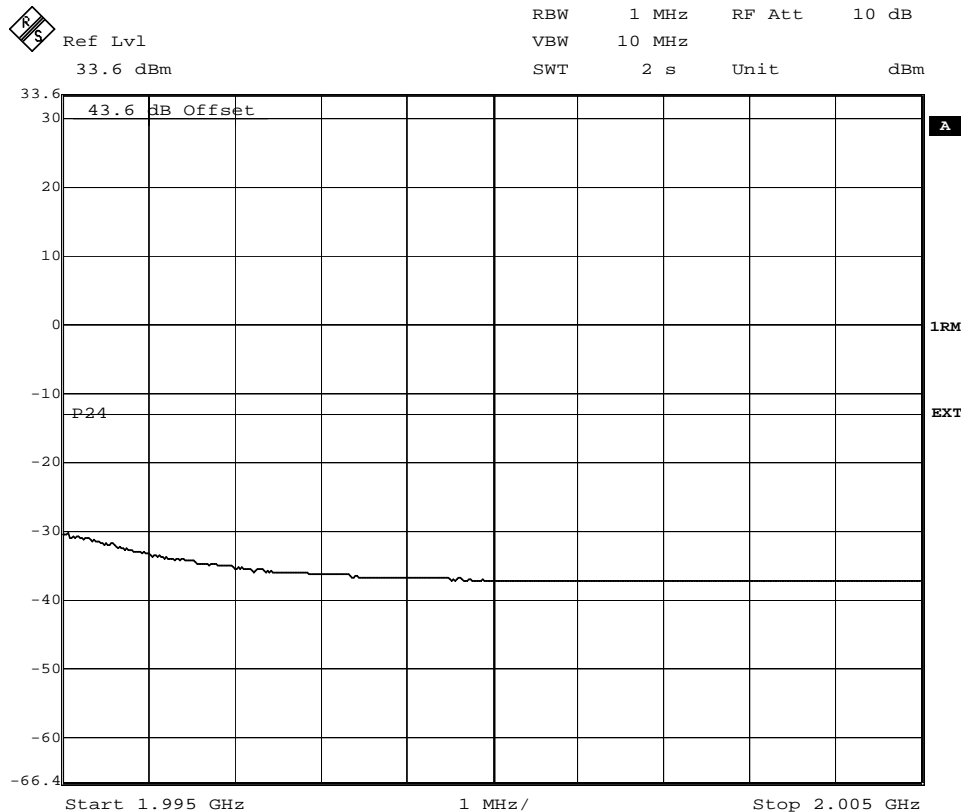

Date: 17.JUN.2005 12:10:39

**Conducted spurious emission measurements according to 47 CFR 2.1051**

Date 2005-06-23	Temperature 22 °C ± 3 °C	Humidity 55 % ± 5 %
--------------------	-----------------------------	------------------------

Test set-up and procedure

The measurements were made per definition in §24.238. The output was connected to a spectrum analyzer. The spectrum analyzer was connected to an external 10 MHz reference standard during the measurements. The transmitter was set up according to Test model 1 and Test model 5 during the measurements. A pre-measurement is first performed with peak detector, spurious emissions closer than 10 dB to the limit is measured with the RMS detector.

Measurement equipment	Calibration Due	SP number
R&S FSIQ	2005-07	503 738
HP filter	2006-04	502 739
Testo 610, Temperature and humidity meter	2006-12	502 658

Measurement uncertainty: 3.7 dB

Results

The results are shown in appendix 5.1

QPSK

Diagram 1: 1932.5 MHz

Diagram 2: 1987.5 MHz

16QAM

Diagram 3: 1932.5 MHz

Diagram 4: 1987.5 MHz

Limits

The power of any emission outside the frequency band shall be attenuated below the transmitter power (P) by at least $43 + 10 \log P$ dB.

Complies?	Yes
-----------	-----



FCC ID: TA8AROJ1192289-1

Appendix 5.1

Diagram 1

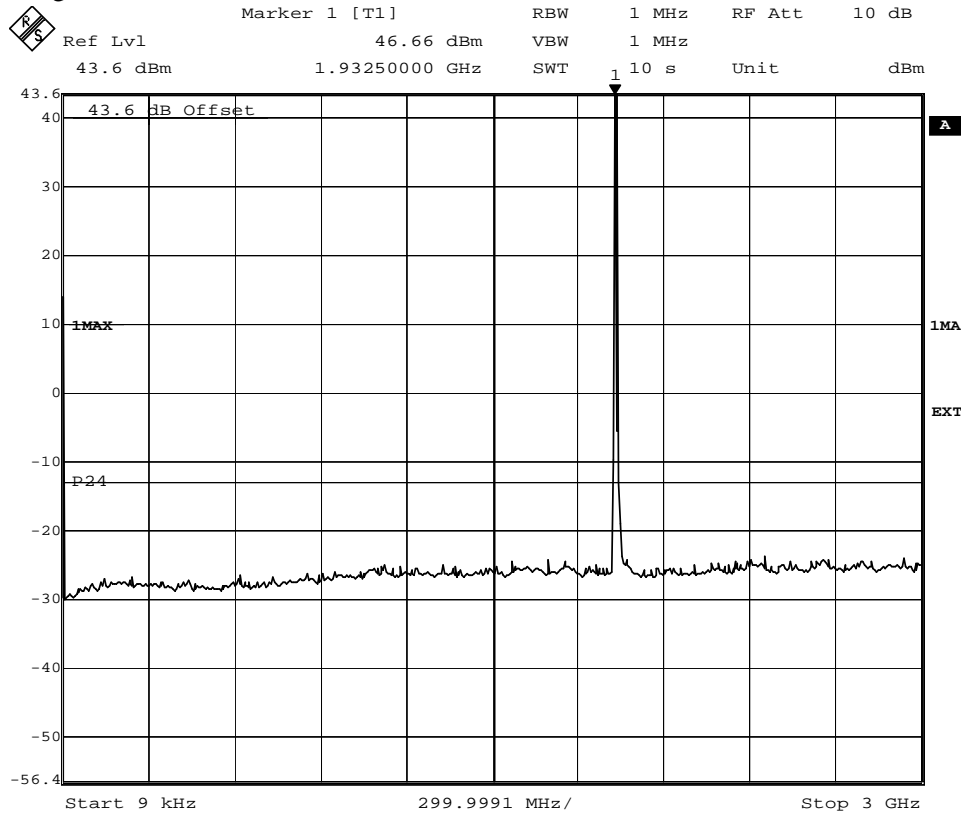

Date: 23.JUN.2005 13:59:39

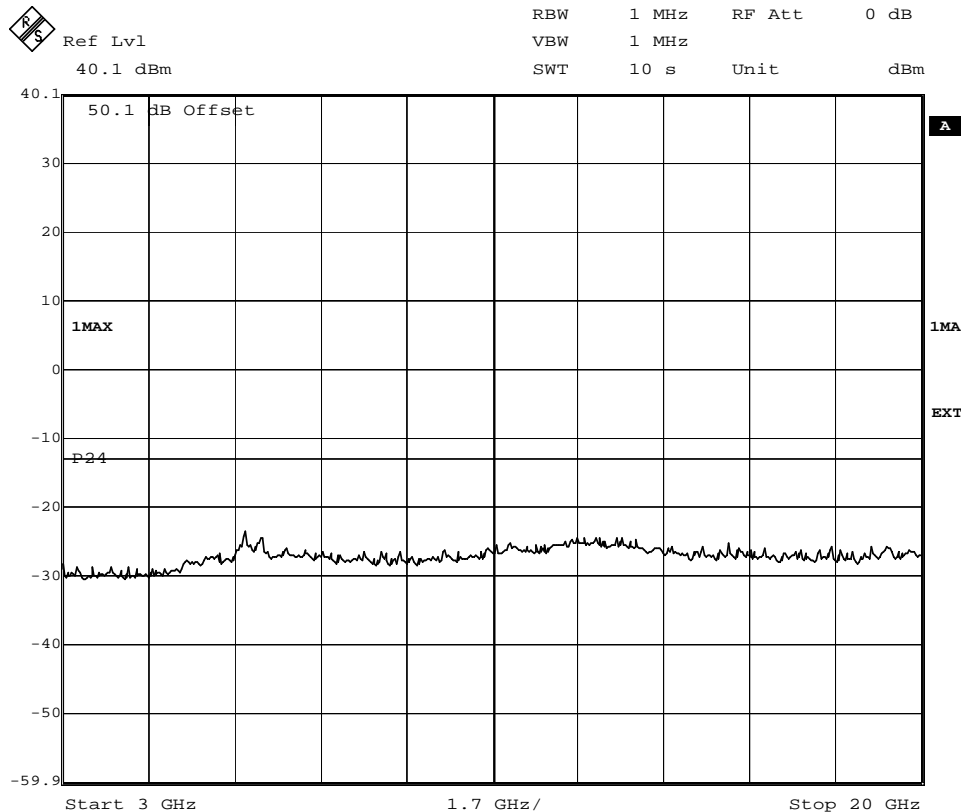

Date: 23.JUN.2005 14:01:24



FCC ID: TA8AROJ1192289-1

Appendix 5.1

Diagram 2

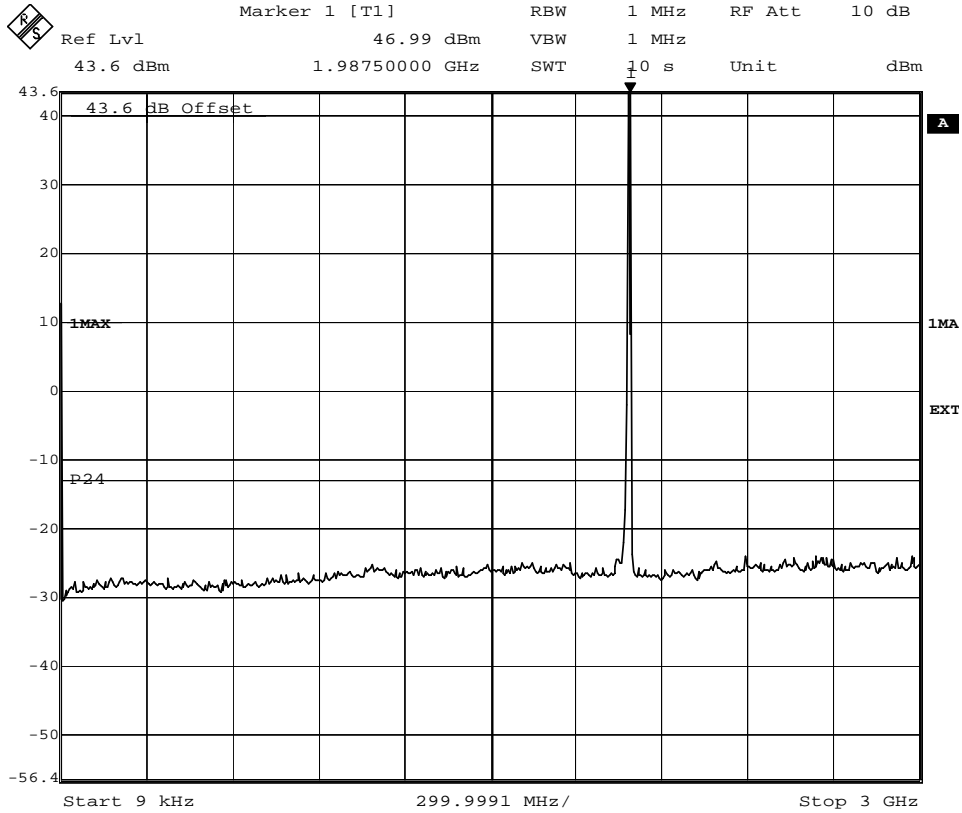

Date: 23.JUN.2005 14:21:23

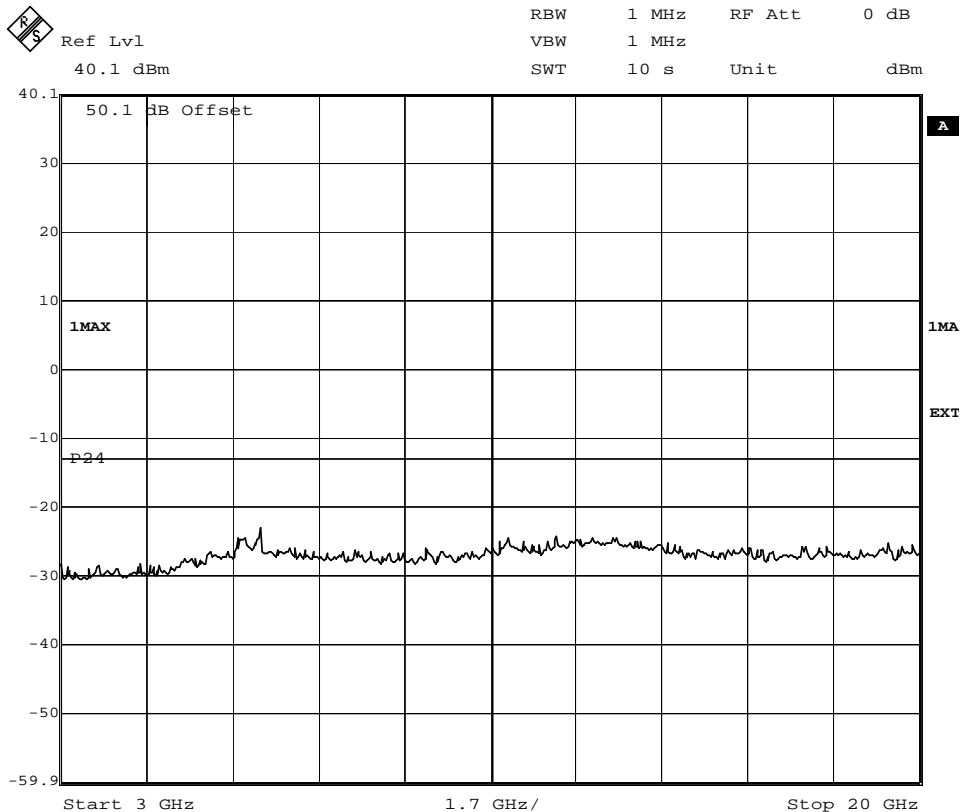

Date: 23.JUN.2005 14:18:51



FCC ID: TA8AR0J1192289-1

Appendix 5.1

Diagram 3

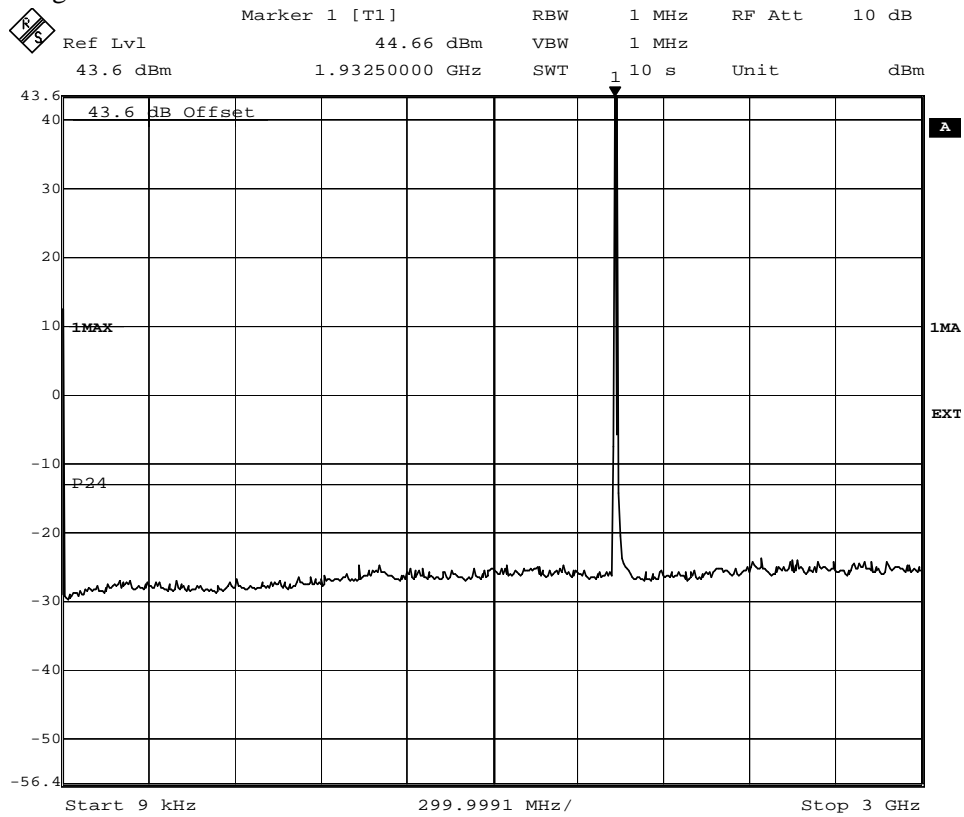

Date: 23.JUN.2005 14:09:31

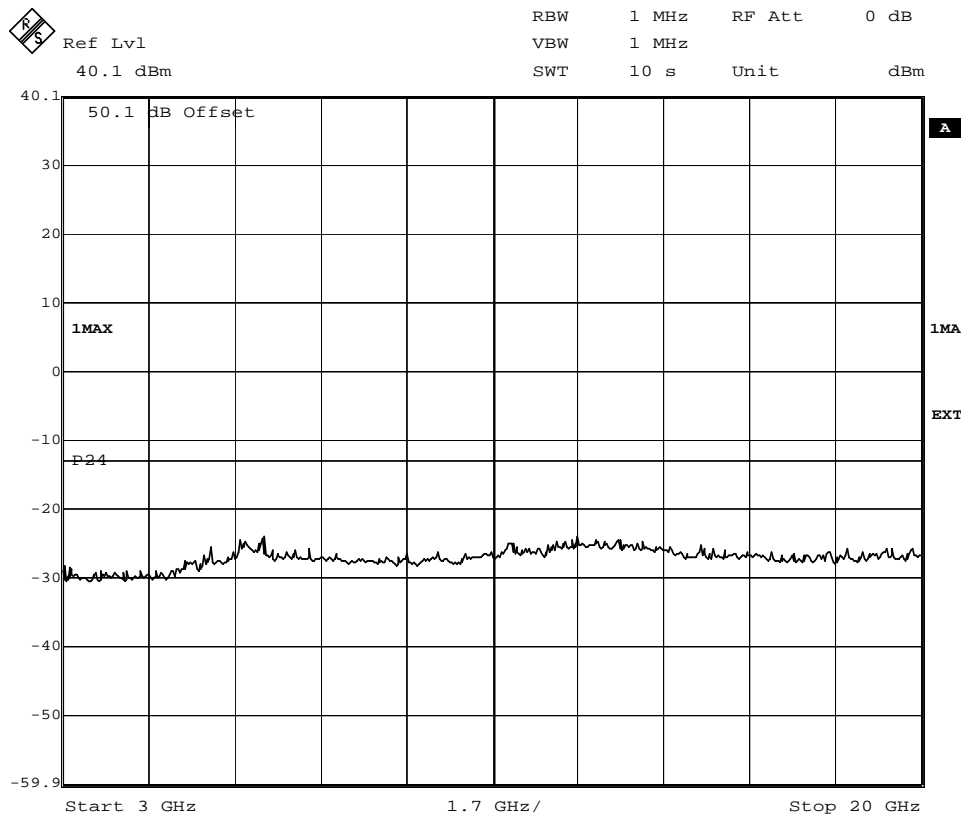

Date: 23.JUN.2005 14:07:04



FCC ID: TA8AROJ1192289-1

Appendix 5.1

Diagram 4

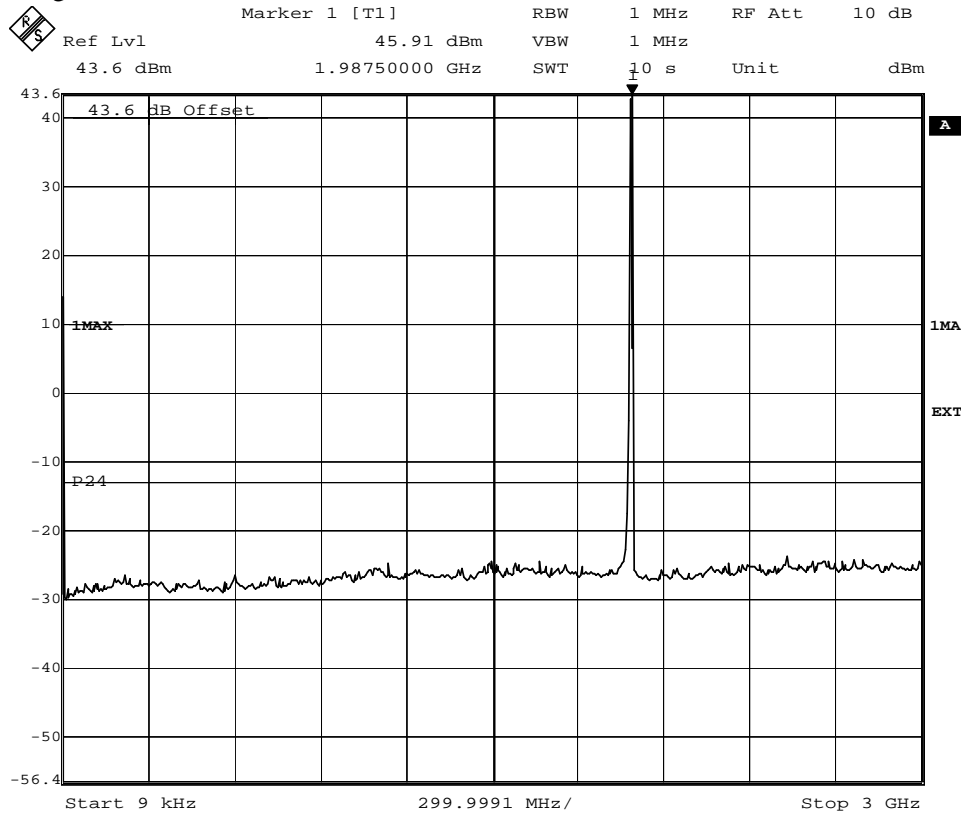

Date: 23.JUN.2005 14:11:54

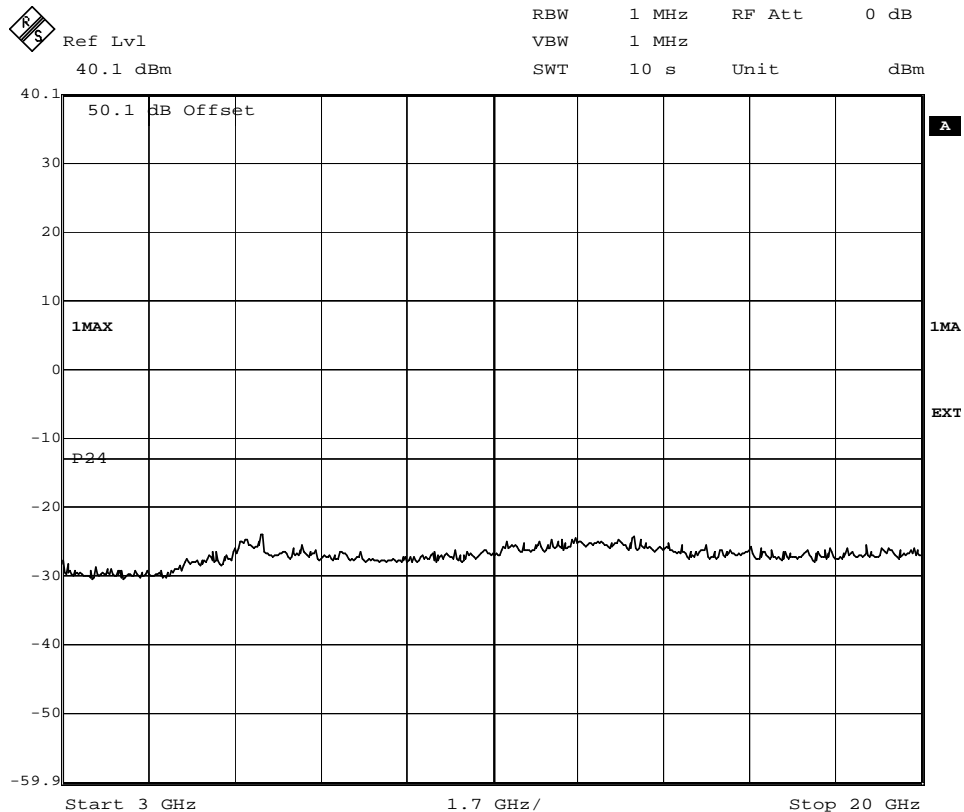

Date: 23.JUN.2005 14:13:27



Field strength of spurious radiation measurements according to 47 CFR 2.1053

Date	Temperature	Humidity
2005-06-20	20 °C ± 3 °C	53 % ± 5 %
2005-06-21	20 °C ± 3 °C	56 % ± 5 %
2005-06-22	21 °C ± 3 °C	54 % ± 5 %
2005-06-23	22 °C ± 3 °C	55 % ± 5 %

Test set-up and procedure

The chamber is listed at FCC, Columbia with registration number: 93866. The test site also complies with RSS 212, Issue 1, Industry Canada file no.:IC 3482.

The transmitter was modulated with pseudorandom data during the measurements. The antenna ports were terminated with 50 ohm loads.

The measurements were performed with both horizontal and vertical polarization of the antenna. The antenna distance was 3 m in the frequency range 30 MHz – 18 GHz and 1m in the frequency range 18-20 GHz.

A pre-measurement was first performed:

In the frequency range 30 MHz-20 GHz the measurement was performed in power with a RBW of 1 MHz. A propagation loss in free space was calculated. The used formula was,

$$\gamma = 20 \log \left(\frac{4\pi D}{\lambda} \right), \gamma \text{ is the propagation loss and } D \text{ is the antenna distance.}$$

The measurement procedure was as the following:

1. The pre-measurement was first performed with peak detector. The EUT was measured in eight directions and with the antenna at three heights, 1.0 m, 1.5 m and 2.0 m.
2. Spurious radiation on frequencies closer than 20 dB to the limit is scanned 0-360 degrees and the antenna is scanned 1-4 m for maximum response. The emission is then measured with the average detector and the average value is reported, frequencies closer than 10 dB to the limit measured with the average detector was measured with the substitution method according to the standard.

Measurement equipment	Calibration Due	SP number
Anechoic chamber	-	15:115
R&S ESI 26	2005-08	503 292
R&S FSIQ 40	2005-07	503 738
Control computer	-	503 479
Software: R&S ES-K1, ver. 1.60	-	-
Chase Bilog antenna CBL 6111A	2006-08	503 182
EMCO Horn Antenna 3115	2006-11	502 548
EMCO Horn Antenna 3116	2007-11	503 279
MITEQ Low Noise Amplifier	2006-04	503 285
Testo 615, Temperature and humidity meter	2005-09	503 505



The test set-ups during the spurious radiation measurements are shown in the picture below.



Results

Frequency (MHz)	Spurious emission level (dBm)	
	Vertical	Horizontal
30-20 000	All other emission > 20 dB below limit	All other emission > 20 dB below limit
Measurement uncertainty		4.7 dB

Limits

The power of any emission outside the frequency band shall be attenuated below the transmitter power (P) by at least $43 + 10 \log P$ dB.

Complies?	Yes
-----------	-----

Frequency stability measurements according to 47 CFR 2.1055

Date 2005-06-13 to 2005 04-29	Temperature (test equipment) 21 °C ± 3 °C	Humidity (test equipment) 35 % ± 5 %
----------------------------------	--	---

Test set-up and procedure

The measurement was made per 3GPP TS 25.141. The output was connected to a spectrum analyzer. The spectrum analyzer was connected to an external 10 MHz reference standard during the measurements. The transmitter was set up according to Test model 1 and Test model 5 during the measurements.

Measurement equipment	Calibration Due	SP number
Climate chamber	2006-02	501 031
R&S FSIQ	2005-07	503 738
Multimeter Fluke 87	2005-09	502 190
Testo 610, Temperature and humidity meter	2006-12	502 658



Results

Nominal Voltage -48 V DC

Nominal 42.4 dBm output power at 1957.5 MHz

Test conditions		Frequency error (Hz)	
Supply voltage DC (V)	T (°C)	QPSK	16QAM
-48.0	+20	-19	+13
-55.2	+20	-19	+13
-40.8	+20	-12	-5
-48.0	+30	+11	-14
-48.0	+40	-16	-11
-48.0	+50	-15	-19
-48.0	+10	-20	-27
-48.0	0	-30	-19
-48.0	-10	-23	-27 (Note 1)
-48.0	-20	-29	-26 (Note 2)
-48.0	-30	-18	-28 (Note 3)
Maximum freq. error (Hz)		-30	
Measurement uncertainty		$< \pm 1 \times 10^{-7}$	

Note 1: after initial power up the EUTs internal temperature control delayed activation of the communication interface for 15 minutes during which the build-in heating element was active. The TX was disabled for a total of 20 minutes after initial power up.

Note 2: after initial power up the EUTs internal temperature control delayed activation of the communication interface for 44 minutes during which the build-in heating element was active. The TX was disabled for a total of 48 minutes after initial power up.

Note 3: after initial power up the EUTs internal temperature control delayed activation of the communication interface for 81 minutes during which the build-in heating element was active. The TX was disabled for a total of 86 minutes after initial power up.

Limits (according to 3GPP TS 25.141)

The frequency Error shall be within ± 0.05 PPM (97,875 Hz).

Complies?	Yes
-----------	-----

FCC ID: TA8AROJ1192289-1

Appendix 8

Photos
sTRX ROJ 119 2289/1 Rev. R1H

Front side



Rear side

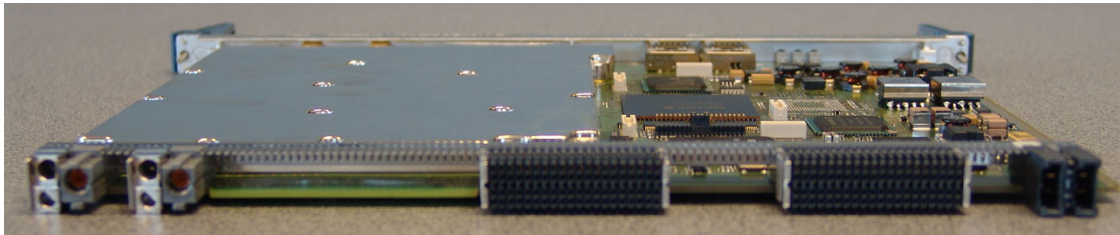

FCC ID

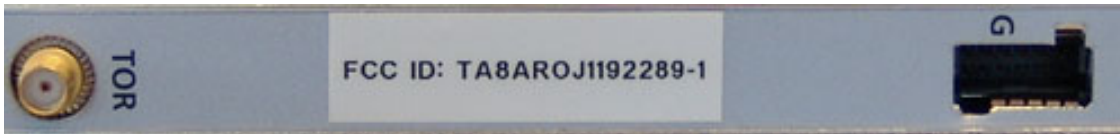

FCC ID: TA8AROJ1192289-1

Appendix 8

RBS 3303

Front side



FCC ID: TA8AR0J1192289-1

Appendix 8

Left side



FCC ID: TA8AROJ1192289-1

Appendix 8

Right side

