

Handled by, department
Jonas Bremholt
Electronics
+46 (0)10 516 5438, jonas.bremholt@sp.se

Ericsson AB
FJB/SV Mats Falk
Lindholmospiren 11
417 56 Göteborg

Permissive change measurements on WCDMA 1900 MHz Transceiver unit with FCC ID: TA8AROJ1192289-1 and IC: 287AB-AW922891

(7 appendices)

Test object

Transceiver unit ROJ 119 2289/1 rev R1K

Appendix 1 provides information about the test object and the test set-up.
Appendix 7 provides external photos of the test object.

Summary

Standard	Compliant	Appendix
FCC CFR 47 / IC RSS-133		
2.1046 / RSS-133 6.4 RF power output	Yes	2
2.1049 / RSS-Gen 4.6.1 Occupied bandwidth	Yes	3
2.1051 / RSS-133 6.5 Band edge	Yes	4
2.1051 / RSS-133 6.5 Spurious emission at antenna terminals	Yes	5
2.1053 / RSS-133 6.5 Field strength of spurious radiation	Yes	6

Note: Above RSS-133 items are given as cross-reference only. Measurements were performed according to ANSI procedures referenced by FCC and covered by SP's accreditation.

SP Technical Research Institute of Sweden Electronics - EMC



Christer Karlsson
Technical Manager



Jonas Bremholt
Technical Officer

SP Technical Research Institute of Sweden

<i>Postal address</i>	<i>Office location</i>	<i>Phone / Fax / E-mail</i>
SP Box 857 SE-501 15 Borås SWEDEN	Västeråsen Brinellgatan 4 Borås	+46 105 16 50 00 +46 33 13 55 02 info@sp.se

Laboratories are accredited by the Swedish Board for Accreditation and Conformity Assessment (SWEDAC) under the terms of Swedish legislation. This report may not be reproduced other than in full, except with the prior written approval of the issuing laboratory.



REPORT

FCC ID: TA8AROJ1192289-1
IC: 287AB-AW922891

Table of contents

Description of the test object	Appendix 1
Operation mode during measurements	Appendix 1
Test setups	Appendix 1
Purpose of test	Appendix 1
RF power output	Appendix 2
Occupied bandwidth	Appendix 3
Band edge	Appendix 4
Spurious emission at antenna terminals	Appendix 5
Field strength of spurious radiation	Appendix 6
External photos	Appendix 7

FCC ID: TA8AROJ1192289-1
IC: 287AB-AW922891

Appendix 1

Description – Test object

Equipment: WCDMA single Transceiver unit (sTRX) 1900 MHz

Tx Frequency range: 1932.4-1987.6 MHz

Modulations: QPSK, 16QAM and 64QAM

Maximum output power: 42.4 dBm (17.4 W)

Nominal power voltage: -48 VDC

Tested channelsUARFCN Frequency
9662 1932.4 MHz**Operation mode during measurements**

All measurements were performed with the test object configured with the Test models 1 and 6 as defined in 3GPP TS 25.141. Test model 1 uses the QPSK modulation only, and Test model 6 includes the 64QAM modulation as follows:

Test model 1 (TM1): 64 DPCHs with at 30 ksps (SF=128) with QPSK modulation
Test model 6 (TM6): 30 DPCHs at 30 ksps (SF=128) with QPSK modulation and
8 HS-PDSCHs at 240 ksps (SF=16) with 64QAM modulation

Conducted measurements

All RF conducted measurements were performed with the test object installed in a RBS 3303 powered with -48 VDC. All measurements were done at the output connector (Ant A) of the single Antenna Interface Unit (sAIU) KRY 112 123/1. The measurements were performed at maximum output power with both Test models.

FCC ID: TA8AROJ1192289-1
IC: 287AB-AW922891

Appendix 1

Radiated measurements

All radiated measurements were performed with the test object installed in a RBS 3303 cabinet powered with -48 VDC.

The test object was activated at maximum output power (42.4 dBm). The RF output power port was via a RF attenuator connected to functional test equipment for supervision.

The RU unit were allocated to the following UARFCN:

Downlink	9662 (1932.4 MHz)	9662 (1932.4 MHz)
Uplink	9262 (1852.4 MHz)	9262 (1852.4 MHz)
	TM1 with only QPSK	TM6 incl. 64QAM

Purpose of test

The purpose of this test is to justify a Class II permissive change of the test object to include the use of 64QAM modulation. This report verifies maintained performance characteristics of affected items according FCC CFR47 by re-testing the updated equipment with QPSK, using Test model 1, and with a combination of QPSK and 64QAM, using Test model 6.

Summary of results

Measurement results for both set-ups are near identical and Test model 1 can be considered a worst case set-up.

References

Measurements were done according to relevant parts of the following standards:

ANSI 63.4-2003
ANSI/TIA/EIA-603-B-2002
3GPP TS 25.141

FCC ID: TA8AROJ1192289-1
IC: 287AB-AW922891

Appendix 1

Measurement equipment

Measurement equipment	Calibration Due	SP number
Test site Tesla	2010-10	503 881
R&S FSIQ	2009-08	503 738
R&S ESI 26	2009-07	503 292
High pass filter	2010-06	503 739
Boonton RF Peak power meter/analyzer	2009-09	503 144
Boonton Power sensor 56518-S/4	2009-09	503 145
Chase Bilog antenna CBL 6111A	2011-11	502 181
EMCO Horn Antenna 3115	2011-01	502 175
Flann Standard gain horn 20240-20	-	503 674
MITEQ Low Noise Amplifier	2009-06	503 285
Multimeter Fluke 87	2009-04	502 190
Testo 610, Temperature and humidity meter	2009-04	502 658

Reservation

The test results in this report apply only to the particular test object as declared in the report.

Delivery of test object

The test object was delivered: 2008-11-07

Manufacturer's representative

Christer Hjort, Ericsson AB.

Test engineers

Jonas Bremholt, Jörgen Wassholm and Andreas Johnson

Test witnesses

Christer Hjort and Ove Nilsson, Ericsson AB.

FCC ID: TA8AROJ1192289-1
 IC: 287AB-AW922891

Appendix 1

Test set-up, conducted measurements

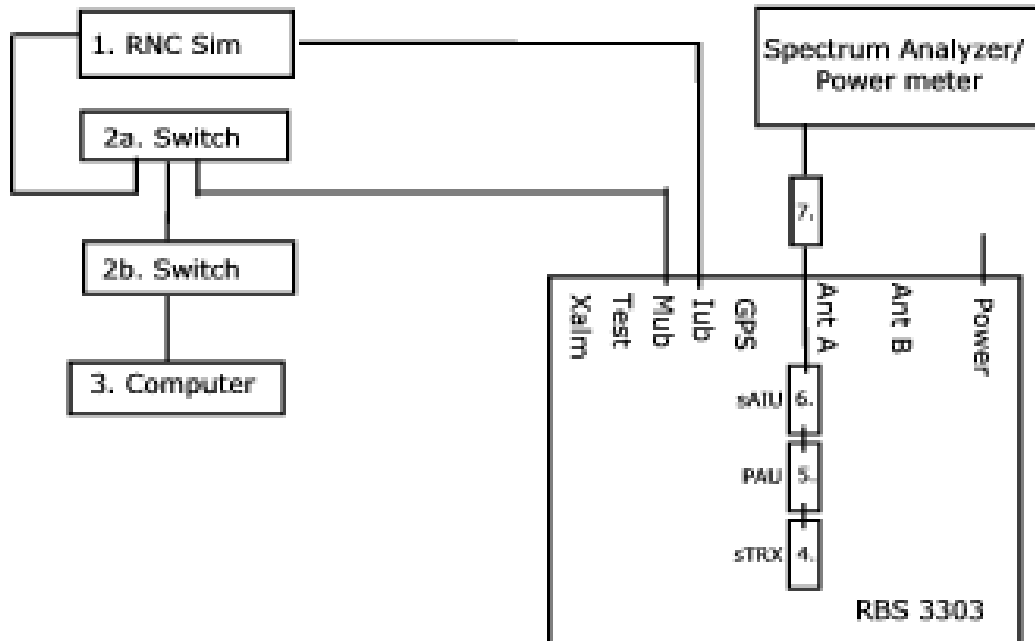

RBS 3303: BFM 901 087/2 with software CXP 901 3008 Rev. R6Y07. More information about the RBS hardware units are shown in SP document F820809-H

Test object

- 4. Transceiver unit ROJ 119 2289/1, rev. R1K, Serial No: AE54212226 (FCC ID: TA8AROJ1192289-1)

Functional test equipment

- 1. RNC: Mini-SIM#60 4780 DA S/N 0210 REV BAA
- 2a Switch Netgear model FS 726
- 2b Switch Netgear model FS 726
- 3. Computer: Sun ULTRA45, BAMS 1000655787
- 5. PAU KRB 901 17/1, rev. R1D, Serial No. BN200002YG (FCC ID: TA8AKRB90117-1)
- 6. sAIU 1900, KRY 112 123/1, rev. R2A, Serial No. A400606622
- 7. Attenuator

Test set-up, radiated measurements

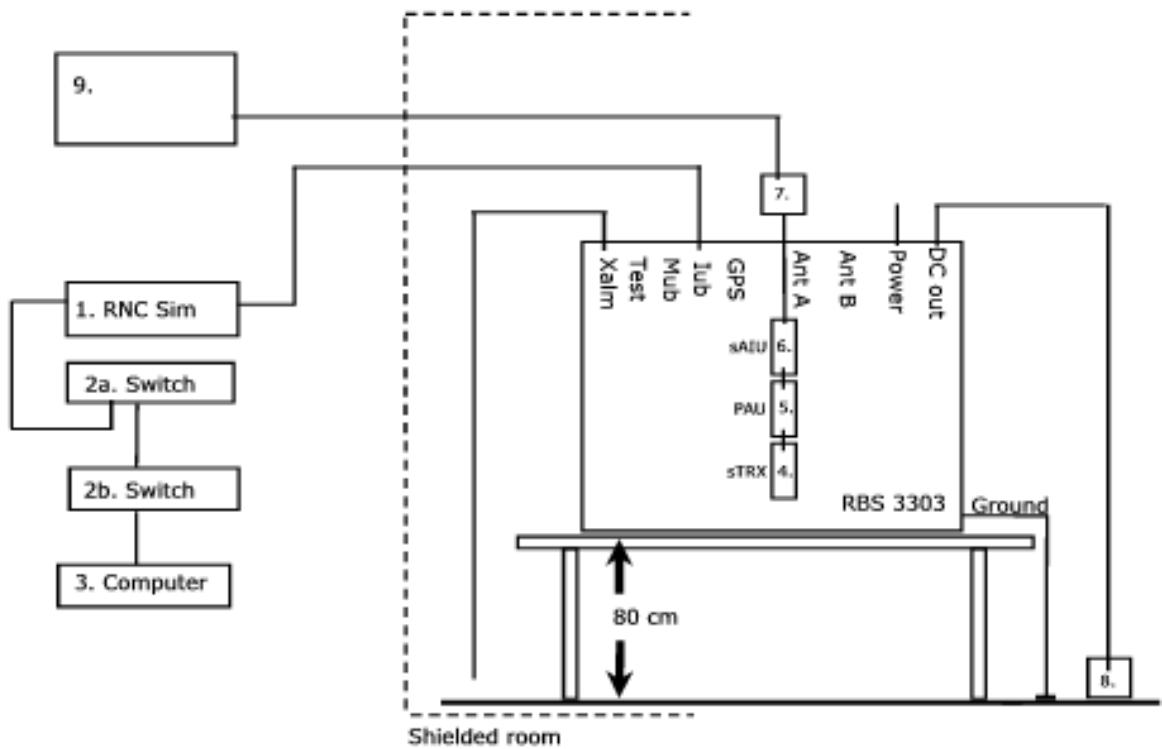

RBS 3303: BFM 901 087/2 with software CXP 901 3008 Rev. R6Y07. More information about the RBS hardware units are shown in SP document F820809-H

Test object

- 4. Transceiver unit ROJ 119 2289/1, rev. R1K, Serial No: AE54212226 (FCC ID: TA8AROJ1192289-1)

Functional test equipment

- 1 RNC: Mini-SIM#60 4780 DA S/N 0210 REV BAA
- 2a Switch Netgear model FS 726
- 2b Switch Netgear model FS 726
- 3. Computer: Sun ULTRA45, BAMS 1000655787
- 5. PAU KRB 901 17/1, rev. R1D, Serial No. BN200002YG (FCC ID: TA8AKRB90117-1)
- 6. sAIU 1900, KRY 112 123/1, rev. R2A, Serial No. A400606622
- 7. Attenuator, Weinschel model 48-30-33
- 8. DC load
- 9. Anritsu Signal Analyzer, MS2691A, SN 6200750255



FCC ID: TA8AROJ1192289-1
IC: 287AB-AW922891

Appendix 2

RF power output measurements according to 47 CFR 2.1046/ RSS-133 6.4

Date 2008-11-27	Temperature 23 °C ± 3 °C	Humidity 30 % ± 5 %
--------------------	-----------------------------	------------------------

Test set-up and procedure

The output was connected to a peak power analyzer with the CDF mode activated.

Measurement equipment	SP number
Boonton RF Peak power meter/analyzer	503 144
Boonton Power sensor 56518-S/4	503 145
Multimeter Fluke 87	502 190
Testo 610, Temperature and humidity meter	502 658

Measurement uncertainty: 0.5 dB

Results

Rated output power level at Ant 1 connector (maximum): 42.4 dBm

Test conditions V _{nom} -48 V DC	Transmitter power (dBm/ dB) RMS/ PAR
	Frequency 1932.4 MHz
TM1 with only QPSK	42.4/ 7.5
TM6 incl. 64QAM	42.2/ 7.5

Limit

§24.232 **Federal Register** / Vol. 73, No. 86
The maximum output power may not exceed 1640 W (EIRP)
The Peak to Average Ratio (PAR) may not exceed 13 dB.

RSS-133 Maximum conducted output power shall not exceed 100W (50 dBm).

Complies?	Yes
-----------	-----



FCC ID: TA8AR0J1192289-1
IC: 287AB-AW922891

Appendix 3

Occupied bandwidth measurements according to 47 CFR 2.1049/ RSS-Gen 6.5.1

Date 2008-11-27	Temperature 23 °C ± 3 °C	Humidity 30 % ± 5 %
--------------------	-----------------------------	------------------------

Test set-up and procedure

The measurements were made as defined in §2.1049. The output was connected to a spectrum analyzer. The spectrum analyzer was connected to an external 10 MHz reference standard during the measurements.

Measurement equipment	SP number
R&S FSIQ	503 738
Testo 610, Temperature and humidity meter	502 658

Measurement uncertainty: 3.7 dB

Results

The results are shown in appendix 3.1

	TM1 with only QPSK	
	Frequency	OBW
Diagram 1	1932.4 MHz	4.2 MHz
	TM6 incl. 64QAM	
	Frequency	OBW
Diagram 2	1932.4 MHz	4.2 MHz



FCC ID: TA8AROJ1192289-1
IC: 287AB-AW922891

Appendix 3.1

Diagram 1

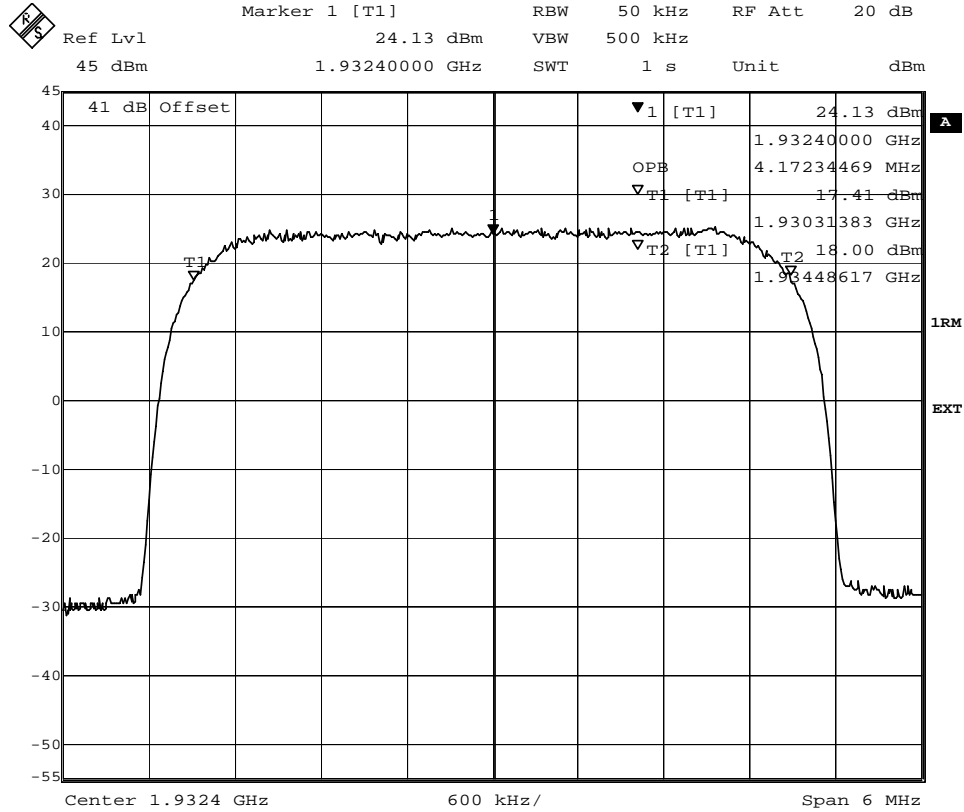

Date: 27.NOV.2008 11:12:34

Diagram 2

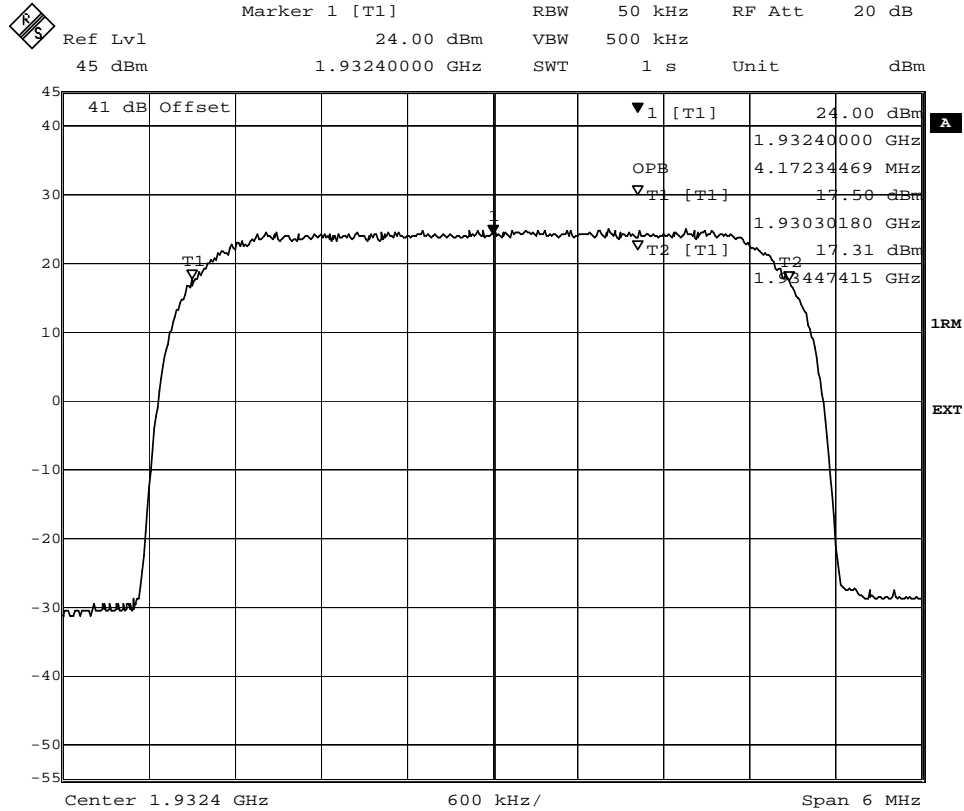

Date: 27.NOV.2008 14:44:00



FCC ID: TA8AROJ1192289-1
IC: 287AB-AW922891

Appendix 4

Band edge measurements according to 47 CFR 2.1051/ RSS-133 6.5

Date 2008-11-27	Temperature 23 °C ± 3 °C	Humidity 30 % ± 5 %
--------------------	-----------------------------	------------------------

Test set-up and procedure

The measurements were made as defined in §24.238. The output was connected to a spectrum analyzer with the RMS detector activated. The spectrum analyzer was connected to an external 10 MHz reference standard during the measurements. A resolution bandwidth of 30 kHz was used up to 3.25 MHz away from the band edges. 30 kHz is <1% of the Emission BW(4.25 MHz between the 26 dB points). To compensate for the reduced measurement band width, the limit was adjusted with 1.5 dB to -14.5 dBm up to 1 MHz away from the band edges and with 15.2 dB to -28.2 dBm between 1 MHz to 3.25 MHz away from the band edges.

Measurement equipment	SP number
R&S FSIQ	503 738
Testo 610, Temperature and humidity meter	502 658

Measurement uncertainty: 3.7 dB

Results

The results are shown in appendix 4.1

TM1 with only QPSK
Diagram 1: 1932.4 MHz

TM6 incl. 64QAM
Diagram 2: 1932.4 MHz

Limits

The power of any emission outside the frequency band shall be attenuated below the transmitter power (P) by at least 43 + 10 log P dB.

Complies?	Yes
-----------	-----



FCC ID: TA8AROJ1192289-1
IC: 287AB-AW922891

Appendix 4.1

Diagram 1

Marker 1 [T1] RBW 30 kHz RF Att 10 dB
Ref Lvl -25.20 dBm VBW 300 kHz
40 dBm 1.93000000 GHz SWT 2 s Unit dBm

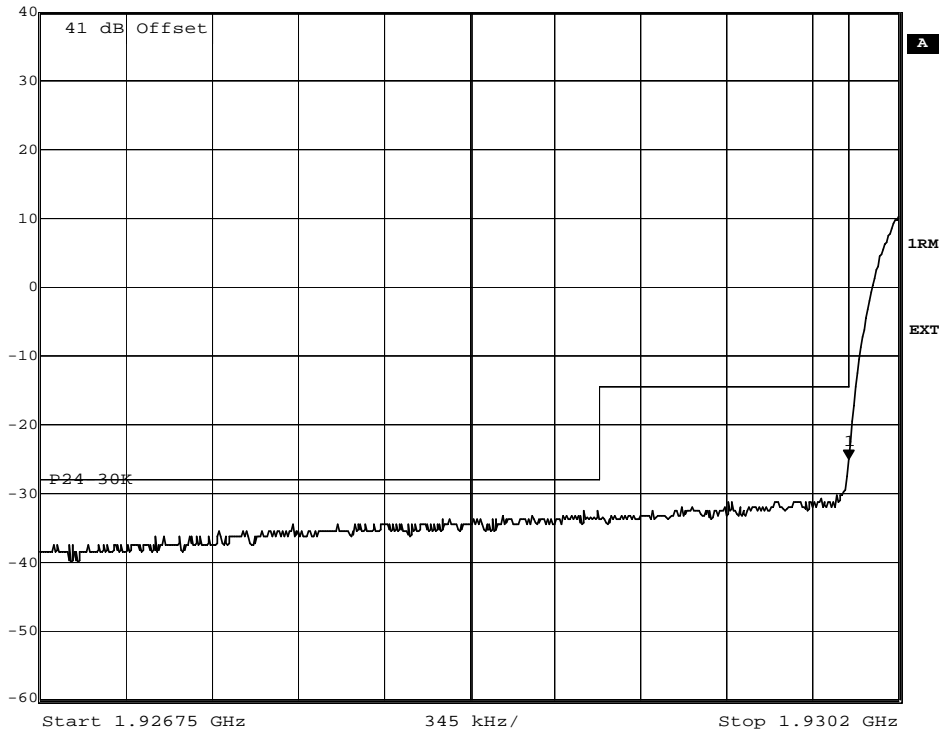

Date: 27.NOV.2008 11:14:15

Marker 1 [T1] RBW 1 MHz RF Att 10 dB
Ref Lvl -23.10 dBm VBW 10 MHz
40 dBm 1.92672996 GHz SWT 2 s Unit dBm

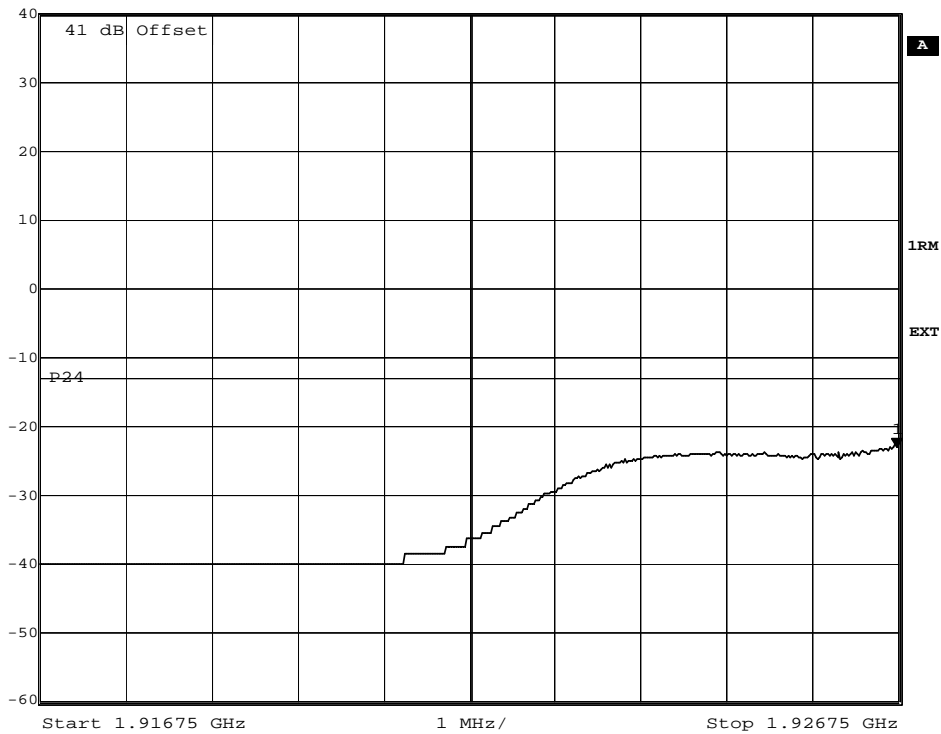

Date: 27.NOV.2008 11:23:00



FCC ID: TA8AROJ1192289-1
IC: 287AB-AW922891

Appendix 4.1

Diagram 2

Marker 1 [T1] RBW 30 kHz RF Att 10 dB
Ref Lvl -25.74 dBm VBW 300 kHz
40 dBm 1.93000000 GHz SWT 2 s Unit dBm

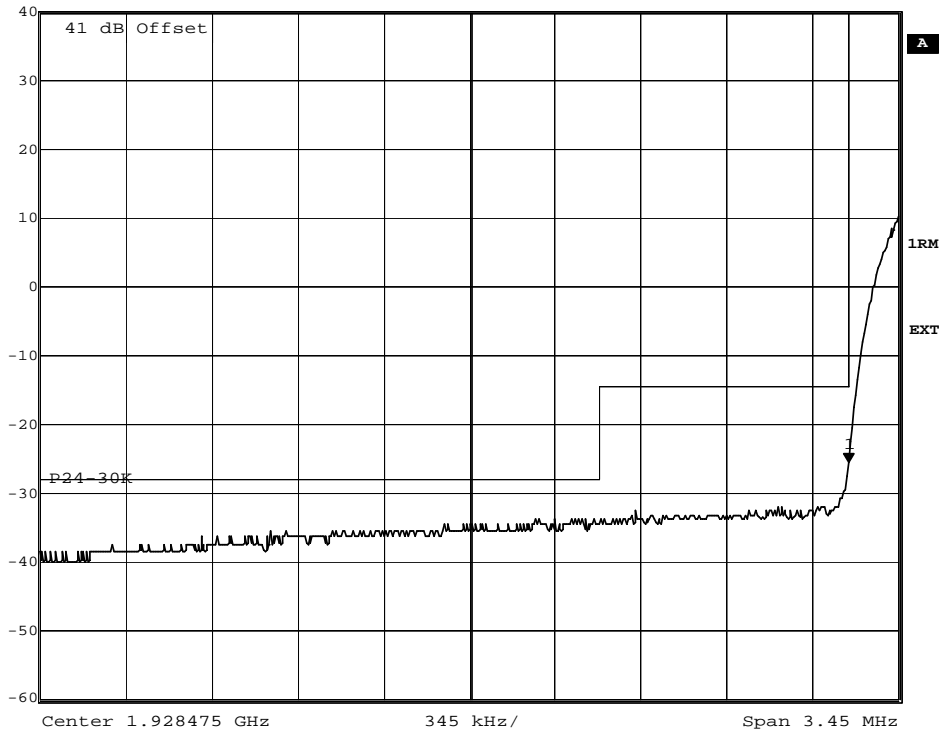

Date: 27.NOV.2008 14:44:52

Marker 1 [T1] RBW 1 MHz RF Att 10 dB
Ref Lvl -23.52 dBm VBW 10 MHz
40 dBm 1.92672996 GHz SWT 2 s Unit dBm

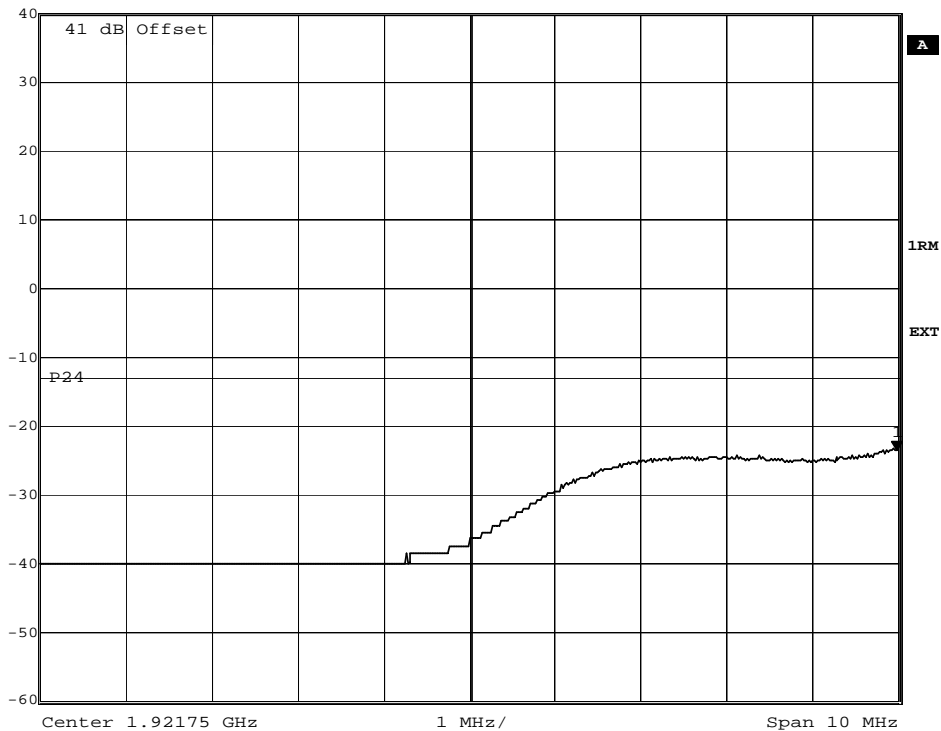

Date: 27.NOV.2008 14:45:29



FCC ID: TA8AROJ1192289-1
IC: 287AB-AW922891

Appendix 5

**Conducted spurious emission measurements according to 47 CFR 2.1051/
RSS-133 6.5**

Date 2008-11-27	Temperature 23 °C ± 3 °C	Humidity 30 % ± 5 %
--------------------	-----------------------------	------------------------

Test set-up and procedure

The measurements were made as defined in §24.238. The output was connected to a spectrum analyzer. First a pre-measurement with activated peak detector was performed. Emissions close to or above the limit is measured with activated RMS detector and the RMS measurement result is noted. The spectrum analyzer was connected to an external 10 MHz reference standard during the measurements.

Measurement equipment	SP number
R&S FSIQ	503 738
High pass filter	503 739
Testo 610, Temperature and humidity meter	502 658

Measurement uncertainty: 3.7 dB

Results

The results are shown in appendix 5.1

Diagram 1: TM1 with only QPSK
1932.4 MHz

Diagram 2: TM6 incl. 64QAM
1932.4 MHz

Remark

The emission at 9 kHz on the plots was not generated by the test object. A complementary measurement with a smaller RBW showed that it was related to the LO feedthrough.

Limits

The power of any emission outside the frequency band shall be attenuated below the transmitter power (P) by at least 43 + 10 log P dB.

Complies?	Yes
-----------	-----



FCC ID: TA8AROJ1192289-1
IC: 287AB-AW922891

Appendix 5.1

Diagram 1

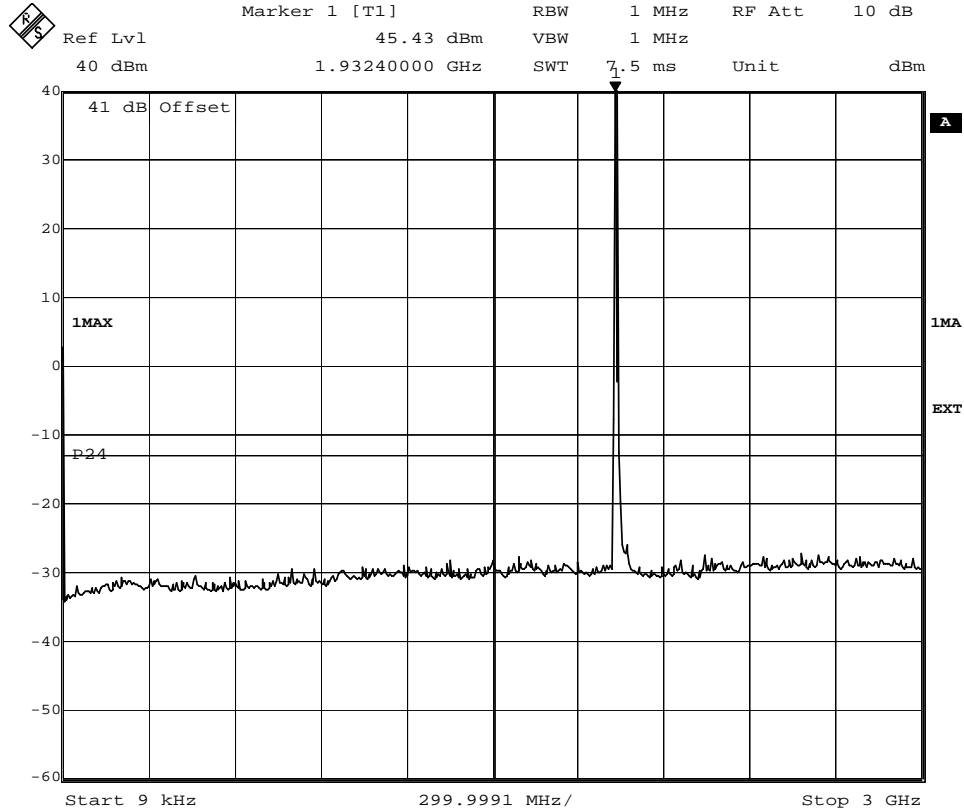

Date: 27.NOV.2008 11:25:01

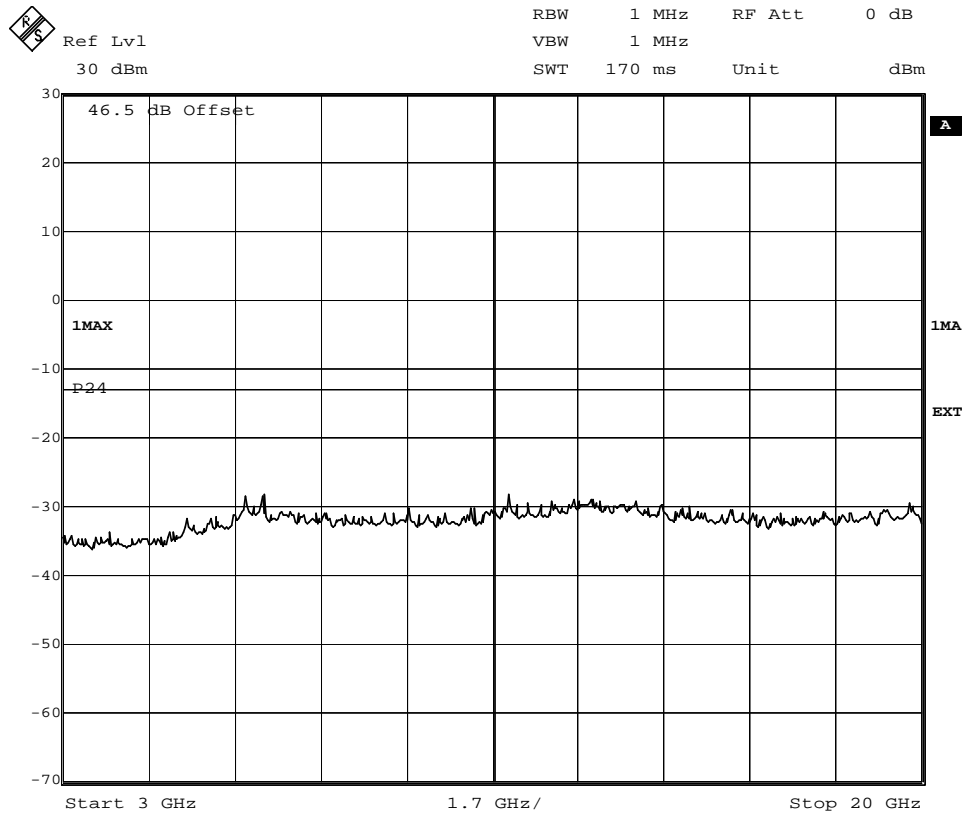

Date: 27.NOV.2008 12:35:51



FCC ID: TA8AROJ1192289-1
IC: 287AB-AW922891

Appendix 5.1

Diagram 2

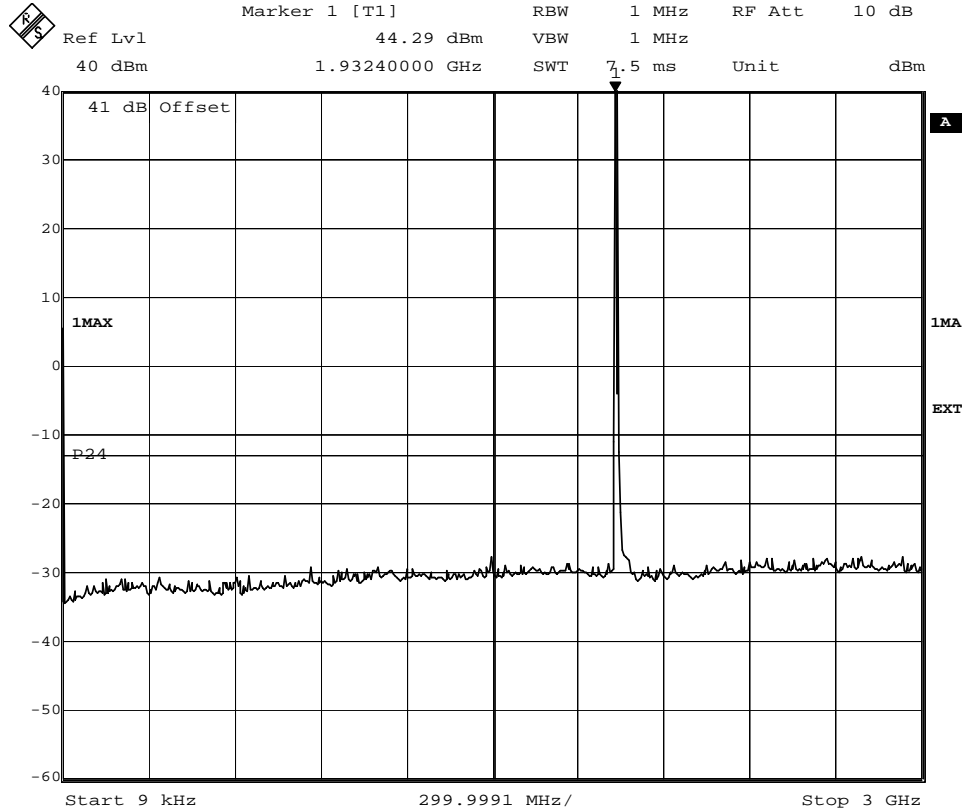

Date: 27.NOV.2008 14:50:38

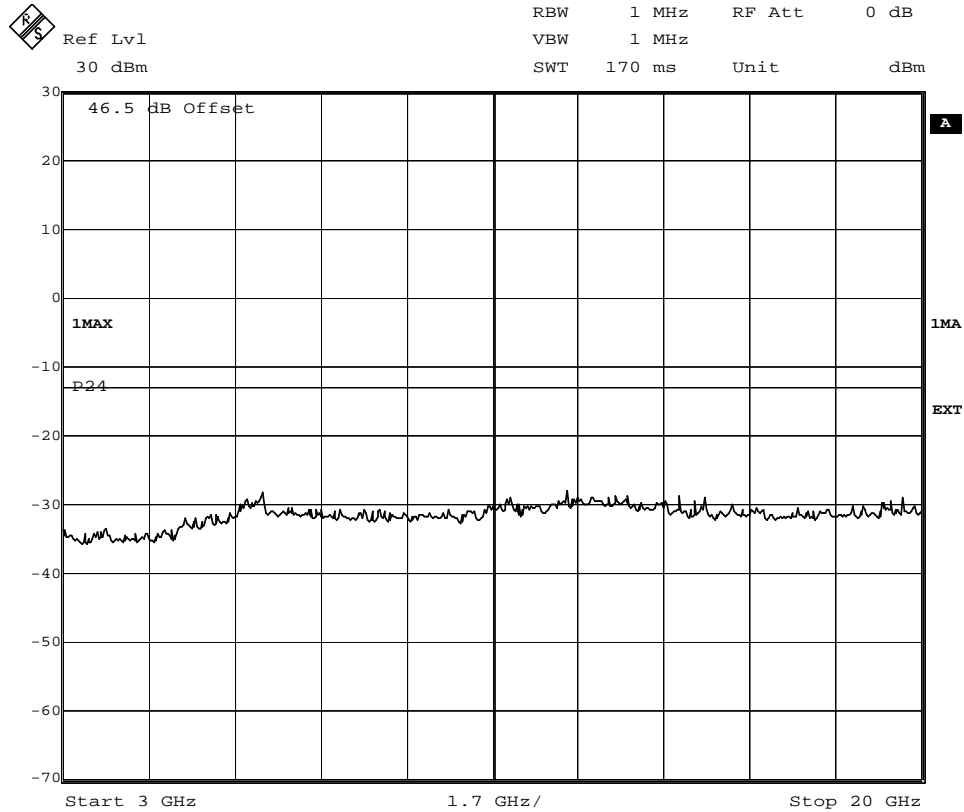

Date: 27.NOV.2008 14:49:33

FCC ID: TA8AROJ1192289-1
 IC: 287AB-AW922891

Appendix 6

Field strength of spurious radiation measurements according to 47 CFR 2.1053/ RSS-133 6.5

Date 2008-11-13	Temperature 23 °C ± 3 °C	Humidity 32 % ± 5 %
--------------------	-----------------------------	------------------------

Test set-up and procedure

The test site is listed at FCC, Columbia with registration number: 93866. The test site also complies with RSS-Gen, Industry Canada file no.:IC 3482.

The transmitter was modulated with pseudorandom data during the measurements. The antenna ports were terminated with 50 ohm loads.

The measurements were performed with both horizontal and vertical polarization of the antenna. The antenna distance was 3 m in the frequency range 30 MHz – 18 GHz and 1m in the frequency range 18-20 GHz.

A pre-measurement was first performed:

In the frequency range 30 MHz-20 GHz the measurement was performed in power with a RBW of 1 MHz. A propagation loss in free space was calculated. The used formula was,

$$\gamma = 20 \log \left(\frac{4\pi D}{\lambda} \right), \gamma \text{ is the propagation loss and } D \text{ is the antenna distance.}$$

The measurement procedure was as the following:

1. The pre-measurement was first performed with peak detector. The EUT was measured in eight directions and with the antenna at three heights, 1.0 m, 1.5 m and 2.0 m.
2. Spurious radiation on frequencies closer than 20 dB to the limit is scanned 0-360 degrees and the antenna is scanned 1-4 m for maximum response. The emission is then measured with the RMS detector and the RMS value is reported, frequencies closer than 10 dB to the limit measured with the RMS detector were measured with the substitution method according to the standard.

Measurement equipment	SP number
Test site Tesla	503 881
R&S ESI 26	503 292
R&S FSIQ	503 738
Control computer	503 479
Software: R&S EMC32, ver. 6.30.10	-
Chase Bilog antenna CBL 6111A	502 181
EMCO Horn Antenna 3115	502 175
MITEQ Low Noise Amplifier	503 285
High pass filter	503 739
Testo 610, Temperature and humidity meter	502 658

FCC ID: TA8AROJ1192289-1
 IC: 287AB-AW922891

Appendix 6

The test set-ups during the spurious radiation measurements are shown in the picture below:

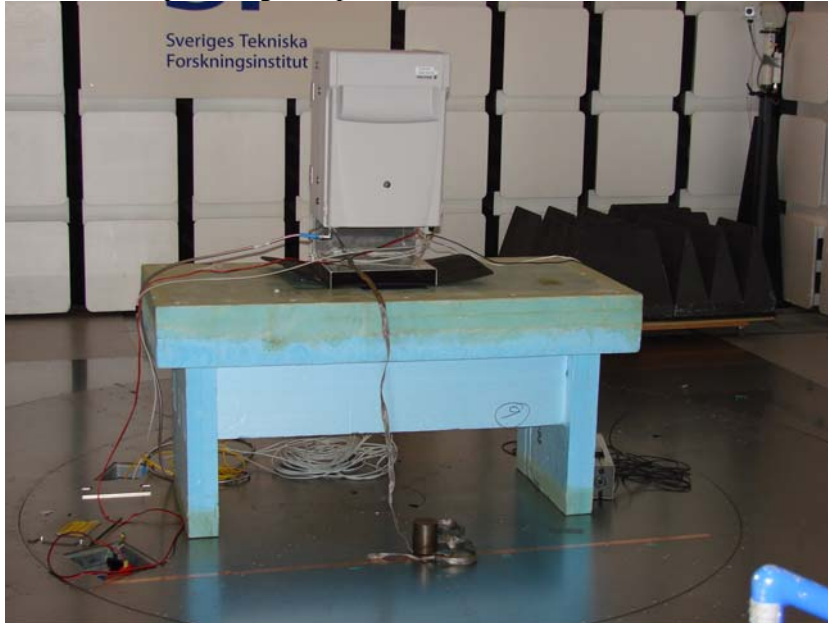

Results

TM1 with only QPSK

Frequency (MHz)	Spurious emission level (dBm)	
	Vertical	Horizontal
30-20 000	All emission > 20 dB below limit	All emission > 20 dB below limit
Measurement uncertainty 4.7 dB		

TM6 incl. 64QAM

Frequency (MHz)	Spurious emission level (dBm)	
	Vertical	Horizontal
30-20 000	All emission > 20 dB below limit	All emission > 20 dB below limit
Measurement uncertainty 4.7 dB		

Limits

The power of any emission outside the frequency band shall be attenuated below the transmitter power (P) by at least $43 + 10 \log P$ dB.

Complies?	Yes
-----------	-----

FCC ID: TA8AROJ1192289-1
IC: 287AB-AW922891

Appendix 7

Photos

sTRX ROJ 119 2289/1 R1K

Front side



Back side

