



Add value.
Inspire trust.

FCC and Testing of the
Ericsson Remote Radio Unit Dot 4455/4465 B77DB77GB41 KRY 901
551/1, KRY 901 551/2 NR (3700-3980 MHz) Base Station in
accordance with FCC CFR 47 Part 2, FCC CFR 47 Part 27

COMMERCIAL-IN-CONFIDENCE

FCC: TA8AKRY901551-1 & TA8AKRY901551-2

PREPARED BY

Handwritten signature of Glen Westwell in black ink.

Glen Westwell
Senior Test Engineer

APPROVED BY

Handwritten signature of Scott Drysdale in black ink.

Scott Drysdale
Authorised Signatory

DATED

07-November-2022

Document 75959061 B77D Report 01 Issue 1

02-November-2022



CONTENTS

Section	Page No
1	REPORT INFORMATION 2
1.1	Report Details 3
1.2	Brief Summary of Results 4
1.3	Test Rationale..... 5
1.4	Configuration Description 6
1.5	Declaration of Build Status 8
1.6	Product Information 9
1.7	Test Setup 11
1.8	Deviation From The Standard 13
1.9	Modification Record 13
1.10	Additional Information 13
2	TEST DETAILS 14
2.1	Maximum Peak Output Power and Peak to Average Ratio - Conducted..... 15
2.2	Occupied Bandwidth..... 45
2.3	Band Edge 52
2.4	Transmitter Spurious Emissions 75
2.5	Frequency Stability 90
3	TEST EQUIPMENT USED 92
3.1	Test Equipment Used 93
3.2	Measurement Uncertainty 94
4	ACCREDITATION, DISCLAIMERS AND COPYRIGHT..... 95
4.1	Accreditation, Disclaimers and Copyright..... 96
ANNEX A	Module Lists.....A.2



SECTION 1

REPORT INFORMATION



1.1 REPORT DETAILS

Manufacturer	Ericsson
Address	Torshamnsgatan 23 Kista SE-16480 Stockholm Sweden
Product Name & Product Number	Dot 4465 B77DB77GB41 KRY 901 551/2
Serial Number(s)	E96A102435
Software Version	CXP 203 0045/26 - R17B569
Hardware Version	R1A
Non-Tested Variant (See Section 1.10 Additional Information)	Dot 4455 B77DB77GB41 KRY 901 551/1 Dot 4455 B77DB77GB41 KRY 901 551/2
Test Specification/Issue/Date	FCC CFR 47 Part 2: 2021 FCC CFR 47 Part 27: 2022
Test Plan	RA FCC Test Plan for Dot 4455_4465 B77DB77GB41
Start of Test	3-October-2022
Finish of Test	7-October-2022
Name of Engineer(s)	Glen Westwell
Related Document(s)	KDB 971168 D01 v02r02 KDB 662911 D01 v02r01 ANSI C63.26-2015

ENGINEERING STATEMENT

The measurements shown in this report were made in accordance with the procedures described on test pages. All reported testing was carried out on a sample equipment to demonstrate compliance with and FCC CFR 47 Part 2: 2021, FCC CFR 47 Part 27: 2021. The sample tested was found to comply with the requirements defined in the applied rules.

Test Engineer(s);

Glen Westwell



1.2 BRIEF SUMMARY OF RESULTS

The tests that have been selected are detailed in the customer Test Plan as defined in section 1.1 of this report. The Test Plan is based on the TÜV SÜD FCC Test Plan Rationale, available on request.

A brief summary of results for each configuration, in accordance with FCC CFR 47 Part 2, FCC CFR 47 Part 27 is shown below.

Section	Specification Clause		Test Description	Result
	FCC CFR 47 Part 2	FCC CFR 47 Part 27		
2.1	2.1046	27.50	Maximum Peak Output Power and Peak to Average Ratio - Conducted	Pass
2.2	2.1049	27.53	Occupied Bandwidth	Pass
2.3	2.1051	27.53	Band Edge	Pass
2.4	2.1051	27.53	Transmitter Spurious Emissions	Pass
2.5	2.1055	27.54	Frequency Stability	Pass

Testing in this Report covers only B77D (3700-3980 MHz)



1.3 TEST RATIONALE

The tests that have been selected are detailed in the customer Test Plan as defined in section 1.1 of this report. The Test Plan is based on the TÜV SÜD FCC Test Plan Rationale, available on request.



1.4 CONFIGURATION DESCRIPTION

Configuration A					
RAT	No. of Carriers	Carrier Bandwidth	Carrier Frequency Configuration (MHz)		
			Bottom	Middle	Top
NR	1	10 MHz	3705.0	3840.0	3975.0
		15 MHz	3707.5	3840.0	3972.5
		20 MHz	3710.0	3840.0	3970.0
		30 MHz	3715.0	3840.0	3965.0
		40 MHz	3720.0	3840.0	3960.0
		50 MHz	3725.0	3840.0	3955.0
		60 MHz	3730.0	3840.0	3950.0
		70 MHz	3735.0	3840.0	3945.0
		80 MHz	3740.0	3840.0	3940.0
		90 MHz	3745.0	3840.0	3935.0
		100 MHz	3750.0	3840.0	3930.0

Configuration B Contiguous Channel Allocations					
RAT	No. of Carriers	Carrier Bandwidth	Carrier Frequency Configuration (MHz)		
			Bottom	Middle	Top
NR	2	10+10 MHz	3705.0+3715.0	3835.0+3845.0	3965.0+3975.0
		100+100 MHz	3750 + 3850	3790 +3890	3830 +3930

Configuration B Non-Contiguous Channel Allocations					
RAT	No. of Carriers	Carrier Bandwidth	Carrier Frequency Configuration (MHz)		
			Bottom	Middle	Top
NR	2	10+10 MHz	3705.0+3895.0	3745.0+3935.0	3785.0+3975.0
		90+90 MHz	3745.0+3855.0	3785.0+3895.0	3825.0+3935.0



Configuration C Contiguous Channel Allocations					
RAT	No. of Carriers	Carrier BW	Carrier Frequency Configuration (MHz)		
			Bottom	Middle	Top
NR	6	10 MHz	3705+3715+3725+	3815+3825+3835+	3925+3935+3945+
			3735+3745+3755	3845+3855+3865	3955+3965+3975
NR	6	20 MHz	3710+3730+3750+	3790+3810+3830+	3870+3890+3910+
			3770+3790+3810	3850+3870+3890	3930+3950+3970

Configuration C Non-Contiguous Channel Allocations					
RAT	No. of Carriers	Carrier BW	Carrier Frequency Configuration (MHz)		
			Bottom	Middle	Top
NR	6	10 MHz	3705+3715+3725+	3745+3755+3765+	3785+3795+3805+
			3875+3885+3895	3915+3925+3935	3955+3965+3975
NR	6	20 MHz	3710+3730+3750+	3750+3770+3790	3790+3810+3830+
			3850+3870+3890	3890+3910+3930	3930+3950+3970



1.5 DECLARATION OF BUILD STATUS

MAIN EUT	
MANUFACTURING DESCRIPTION	Radio Dot
MANUFACTURER	Ericsson
TYPE	Remote Radio Base Station
PART NUMBER	KRY 901 551/1 and KRY 901 551/2
SERIAL NUMBER	E96A102435 for Dot 4465 B77DB77GB41 TD3W340089 for Dot 4465 B77DB25B66
HARDWARE VERSION	R1A for Dot 4465 B77DB77GB41 (used for B77G & B41 tests) R1A modified as R1B for Dot 4465 B77DB25B66 (used for B77D tests)
SOFTWARE VERSION	CXP 203 0045/26 - R17B569 for Dot 4465 B77DB77GB41 CXP 203 0045/26 - R14BX12 for Dot 4465 B77DB25B66
TRANSMITTER OPERATING RANGE	B77D: 3700-3980MHz B77G: 3450-3550MHz B41: 2496-2690MHz
RECEIVER OPERATING RANGE	B77D: 3700-3980MHz B77G: 3450-3550MHz B41: 2496-2690MHz
COUNTRY OF ORIGIN	Poland
INTERMEDIATE FREQUENCIES	None
EMISSION DESIGNATOR(S): (i.e. G1D, GXW)	B77D NR: 10M0F9W, 15M0F9W, 20M0F9W, 30M0F9W, 40M0F9W, 50M0F9W, 60M0F9W, 70M0F9W 80M0F9W, 90M0F9W, 100MF9W B77G NR: 10M0F9W, 20M0F9W, 30M0F9W, 40M0F9W, 50M0F9W, 60M0F9W, 70M0F9W 80M0F9W, 90M0F9W, 100MF9W B41 NR: 10M0F9W, 15M0F9W, 20M0F9W, 30M0F9W, 40M0F9W, 50M0F9W, 60M0F9W, 70M0F9W 80M0F9W, 90M0F9W, 100MF9W B41 LTE: 5M00W7D, 10M0W7D, 15M0W7D, 20M0W7D
MODULATION TYPES: (i.e. GMSK, QPSK)	NR: QPSK, 16QAM, 64QAM, 256QAM LTE: QPSK, 16QAM, 64QAM, 256QAM
HIGHEST INTERNALLY GENERATED FREQUENCY	3.98 GHz
OUTPUT POWER (W or dBm)	B77D: 4 x 0.4W (26dBm) (1 carrier limited to 24dBm) B77G: 2 x 0.4W (26dBm) (1 carrier limited to 24dBm) B41: 2 x 0.4W (26dBm) (1 carrier limited to 24dBm)
Antenna gain (dBi)	B77D: 5.39 dBi B77G: 5.19 dBi B41: 5.65 dBi
FCC ID	TA8AKRY901551-1 & TA8AKRY901551-2
INDUSTRY CANADA ID	NA



TECHNICAL DESCRIPTION (a brief description of the intended use and operation)	Dot 4455 B77DB77GB41 (KRY 901 551/1) and Dot 4465 B77DB77GB41 (KRY 901 551/2) are Remote Radio Units forming part of the Ericsson Radio Base Station (RBS) equipment. The Dot provides radio access for mobile and fixed devices and is intended for the indoor environment. The radio operates over 8 Transmit ports in MRO (NR+LTE); Single, Multi-Carrier, and MIMO transmission with a maximum rated RF Output up to 0.4W per port over an operational temperature of 5°C to +40°C. The unit is designed to be ceiling or wall mounted. The 4455 and 4465 radios are identical except that Dot 4455 has internal antennas and Dot 4465 has external RF ports.
--	---

Signature

Denis Lalonde

Date: 9 August 2023

Declaration of Build Status Serial Number: E96A102435



1.6 PRODUCT INFORMATION

1.6.1 Technical Description

The Equipment Under Test (EUT) Dot 4465 B77DB77GB41 KRY 901 551/2 is an Ericsson AB Radio Unit working in the public mobile service Band 77G band which provides communication connections to Band 77G network.

The EUT is declared as operating from a nominal -48V DC supply.

The Equipment Under Test (EUT) is shown in the photograph below. A full technical description can be found in the Manufacturer's documentation.

Equipment Under Test





1.7 TEST SETUP

Conducted Test Set Up

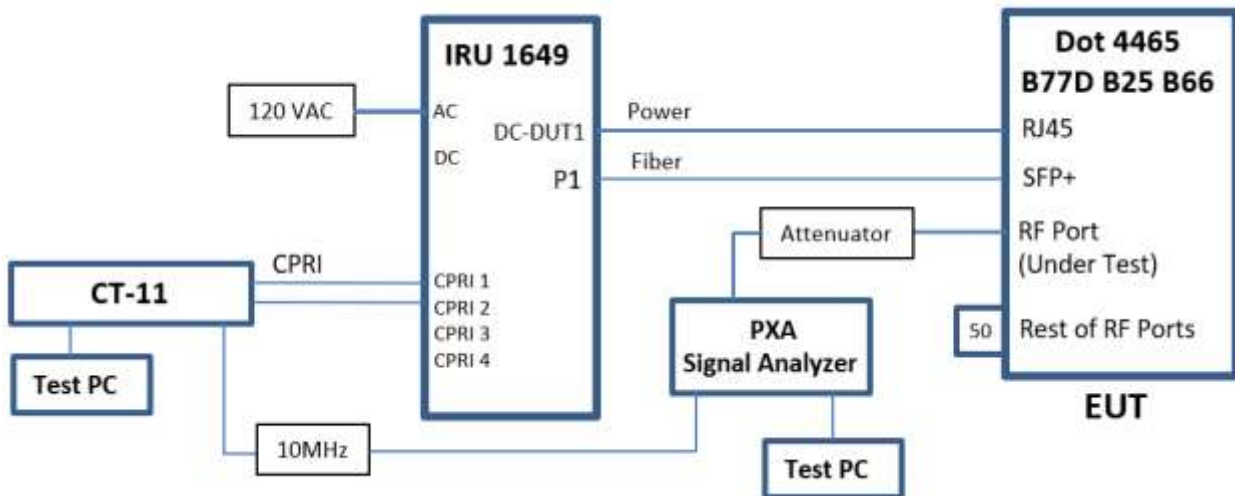
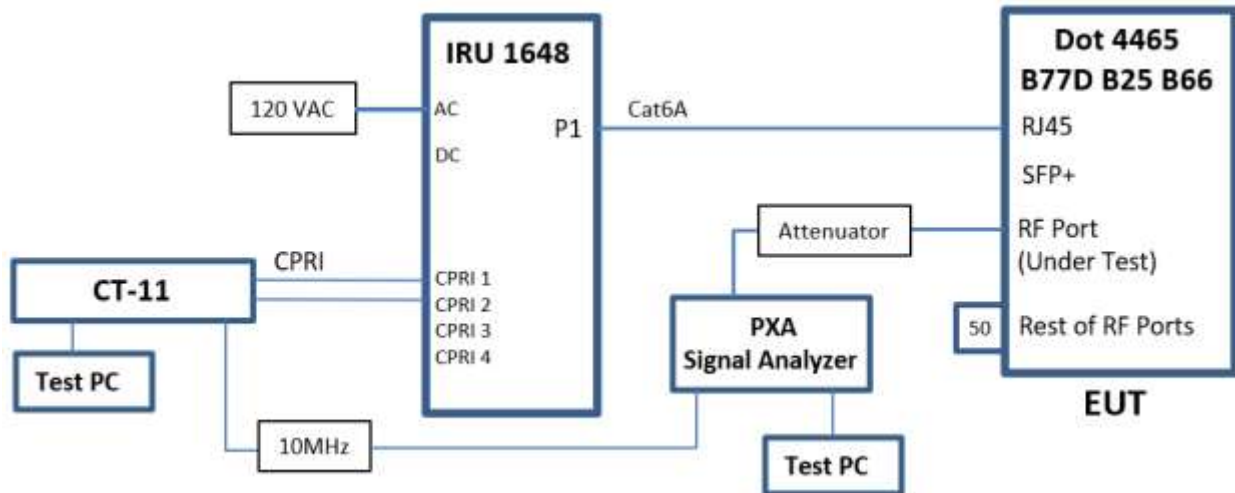



Conducted Test Set Up – Frequency Stability

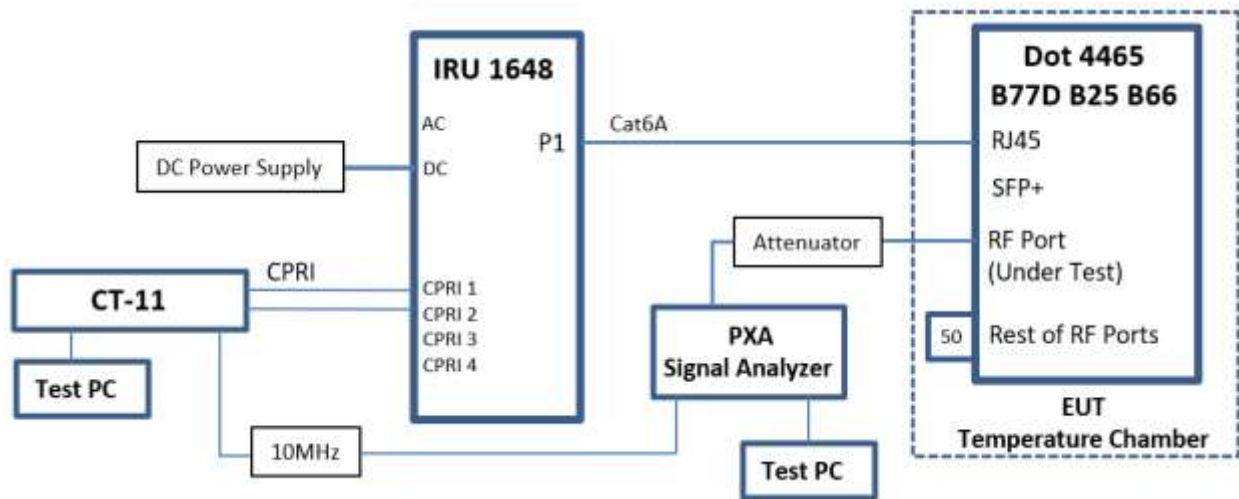



Test Conditions

For all tests the EUT was set up in accordance with the relevant test standard and to represent typical operating conditions. Tests were applied with the EUT situated as described in the Test Method for each Test.

The EUT was powered from a -54V DC supply unless otherwise stated.

FCC Measurement Facility Registration Number
CA4810 TUV SUD Canada, 1280 Teron Rd., Kanata On.

Under our A2LA Accreditation, TÜV SÜD Canada conducted the following tests Ericsson, Ottawa Laboratory: 349 Terry Fox Dr, Kanata, ON.

Test Name	Name of Engineer(s)
Maximum Peak Output Power and Peak to Average Ratio - Conducted	Glen Westwell
Occupied Bandwidth	Glen Westwell
Band Edge	Glen Westwell
Transceiver Spurious Emissions	Glen Westwell
Freq. Stab.	Glen Westwell

1.8 DEVIATION FROM THE STANDARD

No deviations from the applicable test standards or test plan were made during testing.

1.9 MODIFICATION RECORD

The R1A unit under test was modified to be identical to the R1B build of this product

1. The C62T3A8 component was changed
 - a. from a RJC 545 1110/4C, 0.4pF +/-0.1pF 0201 100V HQ C0/CAPACITOR
 - b. To a REG 724 5182/33PJ, 33nH 5% 0201/INDUCTOR
2. The C62T4A8 component was changed
 - a. from a RJC 545 1110/4C, 0.4pF +/-0.1pF 0201 100V HQ C0/CAPACITOR
 - b. To a REG 724 5182/33PJ, 33nH 5% 0201/INDUCTOR
3. Added RF Absorber Material (2/MPP 901 158/2) inside EMC cover

1.10 ADDITIONAL INFORMATION

1. This filing is for a Radio Certification for use in the USA under the following FCC ID's:

FCC ID: TA8AKRY901551-1 & TA8AKRY901551-2

2. Transmitter performance was measured for top, mid & bottom channels for contiguous and non-contiguous (NC) operation, where applicable, across all antenna ports as presented in the average power measurement tables. Typical performance is presented. All configuration data is on file and available upon request.

3. The Dot 4465 B77DB77GB41 product has identical B77D circuits as used in Dot 4465 B77DB25B66.

For this reason, B77D tests performed on Dot 4465 B77DB25B66 are now used to demonstrate B77D FCC compliance on Dot 4465 B77DB77GB41.

The Dot 4455 B77DB77GB41 and Dot 4465 B77DB77GB41 radios are identical except that Dot 4455 has internal antennas and Dot 4465 has external RF ports.



SECTION 2

TEST DETAILS



2.1 MAXIMUM PEAK OUTPUT POWER AND PEAK TO AVERAGE RATIO - CONDUCTED

2.1.1 Specification Reference

FCC CFR 47 Part 27, Clause 27.50
FCC CFR 47 Part 2, Clause 2.1046

2.1.2 Date of Test and Modification State

04-October-2022 - Modification State 0

2.1.3 Test Equipment Used

The major items of test equipment used for the above tests are identified in Section 3.1.

2.1.4 Environmental Conditions

Ambient Temperature	24.3°C
Relative Humidity	31.0%

2.1.5 Test Method

All measurements were made in accordance with FCC KDB 971168 D01, clause 5.2.1 and summed in accordance with FCC KDB 662911 D01.



2.1.6 Test Results

Configuration A

Maximum Output Power 24.00 dBm / Port

Antenna Gain (dBi)	Modulation	Carrier Bandwidth	Peak to Average Ratio (PAR) / Output Power				
			Channel Position B				
5.39	Antenna Port	PAR (dB)	Average Power				
			dBm	EIRP (dBm)	dBm/MHz	EIRP dBm/MHz	
A	NR: QPSK	10.0 MHz	-	23.91	29.30	14.47	19.86
B	NR: QPSK	10.0 MHz	-	23.99	29.38	14.47	19.86
C	NR: QPSK	10.0 MHz	-	24.00	29.39	14.47	19.86
D	NR: QPSK	10.0 MHz	9.65	24.10	29.49	14.47	19.86
Total			-	30.02	35.41	20.49	25.88
A	NR: QPSK	15.0 MHz	-	23.51	28.90	13.66	19.05
B	NR: QPSK	15.0 MHz	-	24.06	29.45	13.66	19.05
C	NR: QPSK	15.0 MHz	-	24.39	29.78	13.66	19.05
D	NR: QPSK	15.0 MHz	9.74	24.38	29.77	13.66	19.05
Total			-	30.12	35.51	19.68	25.07
A	NR: QPSK	20.0 MHz	-	24.21	29.60	12.40	17.79
B	NR: QPSK	20.0 MHz	-	24.09	29.48	12.40	17.79
C	NR: QPSK	20.0 MHz	-	23.50	28.89	12.40	17.79
D	NR: QPSK	20.0 MHz	9.39	23.55	28.94	12.40	17.79
Total			-	29.87	35.26	18.42	23.81
A	NR: QPSK	30.0 MHz	-	23.69	29.08	10.74	16.13
B	NR: QPSK	30.0 MHz	-	23.57	28.96	10.74	16.13
C	NR: QPSK	30.0 MHz	-	23.52	28.91	10.74	16.13
D	NR: QPSK	30.0 MHz	9.26	23.61	29.00	10.74	16.13
Total			-	29.62	35.01	16.76	22.15
A	NR: QPSK	40.0 MHz	-	23.54	28.93	9.28	14.67
B	NR: QPSK	40.0 MHz	-	23.38	28.77	9.28	14.67
C	NR: QPSK	40.0 MHz	-	23.75	29.14	9.28	14.67
D	NR: QPSK	40.0 MHz	9.27	23.86	29.25	9.28	14.67
Total			-	29.66	35.05	15.30	20.69
A	NR: QPSK	50.0 MHz	-	23.81	29.20	8.35	13.74
B	NR: QPSK	50.0 MHz	-	23.80	29.19	8.35	13.74
C	NR: QPSK	50.0 MHz	-	23.86	29.25	8.35	13.74
D	NR: QPSK	50.0 MHz	9.34	23.75	29.14	8.35	13.74
Total			-	29.83	35.22	14.37	19.76



A	NR: QPSK	60.0 MHz	-	23.55	28.94	7.54	12.93
B	NR: QPSK	60.0 MHz	-	23.60	28.99	7.54	12.93
C	NR: QPSK	60.0 MHz	-	23.65	29.04	7.54	12.93
D	NR: QPSK	60.0 MHz	9.37	23.66	29.05	7.54	12.93
Total			-	29.64	35.03	13.56	18.95
A	NR: QPSK	70.0 MHz	-	23.60	28.99	6.94	12.33
B	NR: QPSK	70.0 MHz	-	23.63	29.02	6.94	12.33
C	NR: QPSK	70.0 MHz	-	23.71	29.10	6.94	12.33
D	NR: QPSK	70.0 MHz	9.50	23.86	29.25	6.94	12.33
Total			-	29.72	35.11	12.96	18.35
A	NR: QPSK	80.0 MHz	-	23.63	29.02	6.14	11.53
B	NR: QPSK	80.0 MHz	-	23.56	28.95	6.14	11.53
C	NR: QPSK	80.0 MHz	-	23.83	29.22	6.14	11.53
D	NR: QPSK	80.0 MHz	9.37	23.90	29.29	6.14	11.53
Total			-	29.75	35.14	12.16	17.55
A	NR: QPSK	90.0 MHz	-	23.60	28.99	5.64	11.03
B	NR: QPSK	90.0 MHz	-	23.65	29.04	5.64	11.03
C	NR: QPSK	90.0 MHz	-	23.75	29.14	5.64	11.03
D	NR: QPSK	90.0 MHz	9.51	23.80	29.19	5.64	11.03
Total			-	29.72	35.11	11.66	17.05
A	NR: QPSK	100.0 MHz	-	23.62	29.01	5.05	10.44
B	NR: QPSK	100.0 MHz	-	23.60	28.99	5.05	10.44
C	NR: QPSK	100.0 MHz	-	23.81	29.20	5.05	10.44
D	NR: QPSK	100.0 MHz	9.47	23.85	29.24	5.05	10.44
Total			-	29.74	35.13	11.07	16.46



Antenna Gain (dBi)	Modulation	Carrier Bandwidth	Peak to Average Ratio (PAR) / Output Power					
			Antenna Port	PAR (dB)	Channel Position M			
					Average Power			
5.39				dBm	EIRP (dBm)	dBm/MHz	EIRP dBm/MHz	
A	NR: QPSK	10.0 MHz	-	24.16	29.55	14.78	20.17	
B	NR: QPSK	10.0 MHz	-	24.08	29.47	14.78	20.17	
C	NR: QPSK	10.0 MHz	-	24.18	29.57	14.78	20.17	
D	NR: QPSK	10.0 MHz	9.56	24.22	29.61	14.78	20.17	
Total			-	30.18	35.57	20.80	26.19	
A	NR: QPSK	15.0 MHz	-	24.23	29.62	13.52	18.91	
B	NR: QPSK	15.0 MHz	-	24.35	29.74	13.52	18.91	
C	NR: QPSK	15.0 MHz	-	24.46	29.85	13.52	18.91	
D	NR: QPSK	15.0 MHz	9.98	24.45	29.84	13.52	18.91	
Total			-	30.39	35.78	19.54	24.93	
A	NR: QPSK	20.0 MHz	-	23.51	28.90	12.14	17.53	
B	NR: QPSK	20.0 MHz	-	23.68	29.07	12.14	17.53	
C	NR: QPSK	20.0 MHz	-	23.59	28.98	12.14	17.53	
D	NR: QPSK	20.0 MHz	9.53	24.36	29.75	12.14	17.53	
Total			-	29.82	35.21	18.16	23.55	
A	NR: QPSK	30.0 MHz	-	23.42	28.81	10.47	15.86	
B	NR: QPSK	30.0 MHz	-	23.74	29.13	10.47	15.86	
C	NR: QPSK	30.0 MHz	-	23.89	29.28	10.47	15.86	
D	NR: QPSK	30.0 MHz	9.71	23.91	29.30	10.47	15.86	
Total			-	29.76	35.15	16.49	21.88	
A	NR: QPSK	40.0 MHz	-	23.77	29.16	9.09	14.48	
B	NR: QPSK	40.0 MHz	-	23.91	29.30	9.09	14.48	
C	NR: QPSK	40.0 MHz	-	23.94	29.33	9.09	14.48	
D	NR: QPSK	40.0 MHz	9.33	23.82	29.21	9.09	14.48	
Total			-	29.88	35.27	15.11	20.50	
A	NR: QPSK	50.0 MHz	-	23.82	29.21	8.10	13.49	
B	NR: QPSK	50.0 MHz	-	23.81	29.20	8.10	13.49	
C	NR: QPSK	50.0 MHz	-	23.95	29.34	8.10	13.49	
D	NR: QPSK	50.0 MHz	9.50	23.87	29.26	8.10	13.49	
Total			-	29.88	35.27	14.12	19.51	
A	NR: QPSK	60.0 MHz	-	23.62	29.01	7.33	12.72	
B	NR: QPSK	60.0 MHz	-	23.67	29.06	7.33	12.72	
C	NR: QPSK	60.0 MHz	-	23.70	29.09	7.33	12.72	
D	NR: QPSK	60.0 MHz	9.33	23.69	29.08	7.33	12.72	
Total			-	29.69	35.08	13.35	18.74	



A	NR: QPSK	70.0 MHz	-	23.63	29.02	6.69	12.08
B	NR: QPSK	70.0 MHz	-	23.62	29.01	6.69	12.08
C	NR: QPSK	70.0 MHz	-	23.74	29.13	6.69	12.08
D	NR: QPSK	70.0 MHz	9.62	23.79	29.18	6.69	12.08
Total			-	29.72	35.11	12.71	18.10
A	NR: QPSK	80.0 MHz	-	23.68	29.07	5.91	11.30
B	NR: QPSK	80.0 MHz	-	23.69	29.08	5.91	11.30
C	NR: QPSK	80.0 MHz	-	23.77	29.16	5.91	11.30
D	NR: QPSK	80.0 MHz	9.54	23.80	29.19	5.91	11.30
Total			-	29.76	35.15	11.93	17.32
A	NR: QPSK	90.0 MHz	-	23.66	29.05	5.42	10.81
B	NR: QPSK	90.0 MHz	-	23.66	29.05	5.42	10.81
C	NR: QPSK	90.0 MHz	-	23.71	29.10	5.42	10.81
D	NR: QPSK	90.0 MHz	9.42	23.81	29.20	5.42	10.81
Total			-	29.73	35.12	11.44	16.83
A	NR: QPSK	100.0 MHz	-	23.53	28.92	4.94	10.33
B	NR: QPSK	100.0 MHz	-	23.58	28.97	4.94	10.33
C	NR: QPSK	100.0 MHz	-	23.78	29.17	4.94	10.33
D	NR: QPSK	100.0 MHz	9.45	23.73	29.12	4.94	10.33
Total			-	29.68	35.07	10.96	16.35



Antenna Gain (dBi)	Modulation	Carrier Bandwidth	Peak to Average Ratio (PAR) / Output Power				
			Antenna Port	PAR (dB)	Channel Position T		
Average Power							
5.39				dBm	EIRP (dBm)	dBm/MHz	EIRP dBm/MHz
A	NR: QPSK	10.0 MHz	-	23.87	29.26	14.95	20.34
B	NR: QPSK	10.0 MHz	-	23.76	29.15	14.95	20.34
C	NR: QPSK	10.0 MHz	-	23.99	29.38	14.95	20.34
D	NR: QPSK	10.0 MHz	9.69	24.07	29.46	14.95	20.34
Total			-	29.94	35.33	20.97	26.36
A	NR: QPSK	15.0 MHz	-	24.21	29.60	13.84	19.23
B	NR: QPSK	15.0 MHz	-	24.85	30.24	13.84	19.23
C	NR: QPSK	15.0 MHz	-	24.15	29.54	13.84	19.23
D	NR: QPSK	15.0 MHz	9.62	23.86	29.25	13.84	19.23
Total			-	30.30	35.69	19.86	25.25
A	NR: QPSK	20.0 MHz	-	23.75	29.14	12.65	18.04
B	NR: QPSK	20.0 MHz	-	23.70	29.09	12.65	18.04
C	NR: QPSK	20.0 MHz	-	23.67	29.06	12.65	18.04
D	NR: QPSK	20.0 MHz	9.31	24.44	29.83	12.65	18.04
Total			-	29.92	35.31	18.67	24.06
A	NR: QPSK	30.0 MHz	-	23.66	29.05	10.77	16.16
B	NR: QPSK	30.0 MHz	-	23.60	28.99	10.77	16.16
C	NR: QPSK	30.0 MHz	-	23.73	29.12	10.77	16.16
D	NR: QPSK	30.0 MHz	9.73	23.82	29.21	10.77	16.16
Total			-	29.72	35.11	16.79	22.18
A	NR: QPSK	40.0 MHz	-	23.76	29.15	9.70	15.09
B	NR: QPSK	40.0 MHz	-	23.88	29.27	9.70	15.09
C	NR: QPSK	40.0 MHz	-	23.86	29.25	9.70	15.09
D	NR: QPSK	40.0 MHz	9.63	23.98	29.37	9.70	15.09
Total			-	29.89	35.28	15.72	21.11
A	NR: QPSK	50.0 MHz	-	23.73	29.12	8.63	14.02
B	NR: QPSK	50.0 MHz	-	23.52	28.91	8.63	14.02
C	NR: QPSK	50.0 MHz	-	23.78	29.17	8.63	14.02
D	NR: QPSK	50.0 MHz	9.38	23.92	29.31	8.63	14.02
Total			-	29.76	35.15	14.65	20.04
A	NR: QPSK	60.0 MHz	-	23.60	28.99	8.16	13.55
B	NR: QPSK	60.0 MHz	-	23.69	29.08	8.16	13.55
C	NR: QPSK	60.0 MHz	-	23.68	29.07	8.16	13.55
D	NR: QPSK	60.0 MHz	9.51	23.96	29.35	8.16	13.55
Total			-	29.76	35.15	14.18	19.57



A	NR: QPSK	70.0 MHz	-	23.53	28.92	7.52	12.91
B	NR: QPSK	70.0 MHz	-	23.59	28.98	7.52	12.91
C	NR: QPSK	70.0 MHz	-	23.68	29.07	7.52	12.91
D	NR: QPSK	70.0 MHz	9.28	23.96	29.35	7.52	12.91
Total			-	29.71	35.10	13.54	18.93
A	NR: QPSK	80.0 MHz	-	23.59	28.98	6.78	12.17
B	NR: QPSK	80.0 MHz	-	23.61	29.00	6.78	12.17
C	NR: QPSK	80.0 MHz	-	23.73	29.12	6.78	12.17
D	NR: QPSK	80.0 MHz	9.24	23.96	29.35	6.78	12.17
Total			-	29.75	35.14	12.80	18.19
A	NR: QPSK	90.0 MHz	-	23.47	28.86	6.19	11.58
B	NR: QPSK	90.0 MHz	-	23.48	28.87	6.19	11.58
C	NR: QPSK	90.0 MHz	-	23.63	29.02	6.19	11.58
D	NR: QPSK	90.0 MHz	9.63	23.84	29.23	6.19	11.58
Total			-	29.63	35.02	12.21	17.60
A	NR: QPSK	100.0 MHz	-	23.56	28.95	5.59	10.98
B	NR: QPSK	100.0 MHz	-	23.59	28.98	5.59	10.98
C	NR: QPSK	100.0 MHz	-	23.71	29.10	5.59	10.98
D	NR: QPSK	100.0 MHz	9.25	23.90	29.29	5.59	10.98
Total			-	29.71	35.10	11.61	17.00

Remarks

1. Transmitter performance has been presented for top, mid, bottom channels across all antenna ports as represented in the following tables.
2. Typical performance and measurement plot data has been presented for reference.
3. All contiguous and non-contiguous (NC) plot data is on file and available upon request.



Antenna Port D Carrier Power - Modulation NR: QPSK - Carrier Bandwidth 10.0 MHz - Channel Position B



Antenna Port D Pk-Av Ratio - Modulation NR: QPSK - Carrier Bandwidth 10.0 MHz - Channel Position B

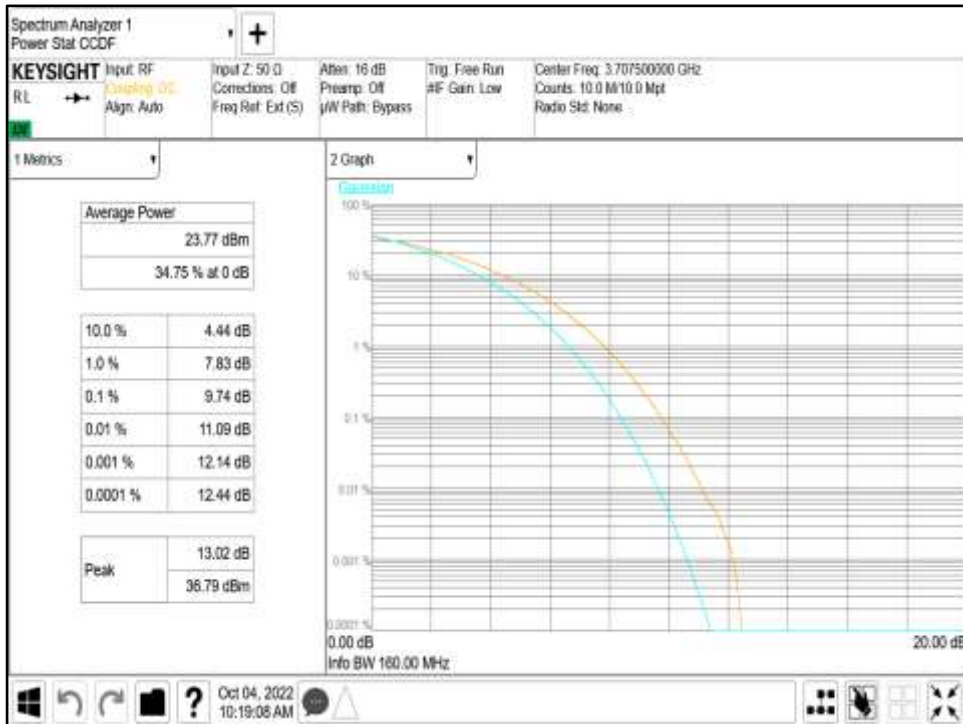



Antenna Port D PSD - Modulation NR: QPSK - Carrier Bandwidth 10.0 MHz - Channel Position B



Antenna Port D Carrier Power - Modulation NR: QPSK - Carrier Bandwidth 15.0 MHz - Channel Position B

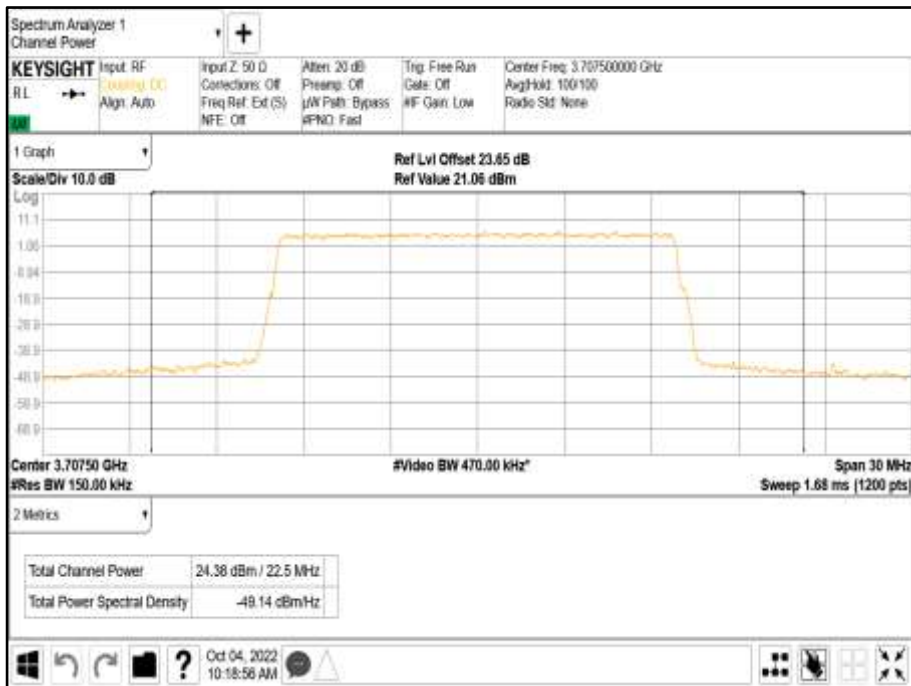



Antenna Port D Pk-Av Ratio - Modulation NR: QPSK - Carrier Bandwidth 15.0 MHz - Channel Position B



Antenna Port D PSD - Modulation NR: QPSK - Carrier Bandwidth 15.0 MHz - Channel Position B





Antenna Port D Carrier Power - Modulation NR: QPSK - Carrier Bandwidth 20.0 MHz - Channel Position B



Antenna Port D Pk-Av Ratio - Modulation NR: QPSK - Carrier Bandwidth 20.0 MHz - Channel Position B

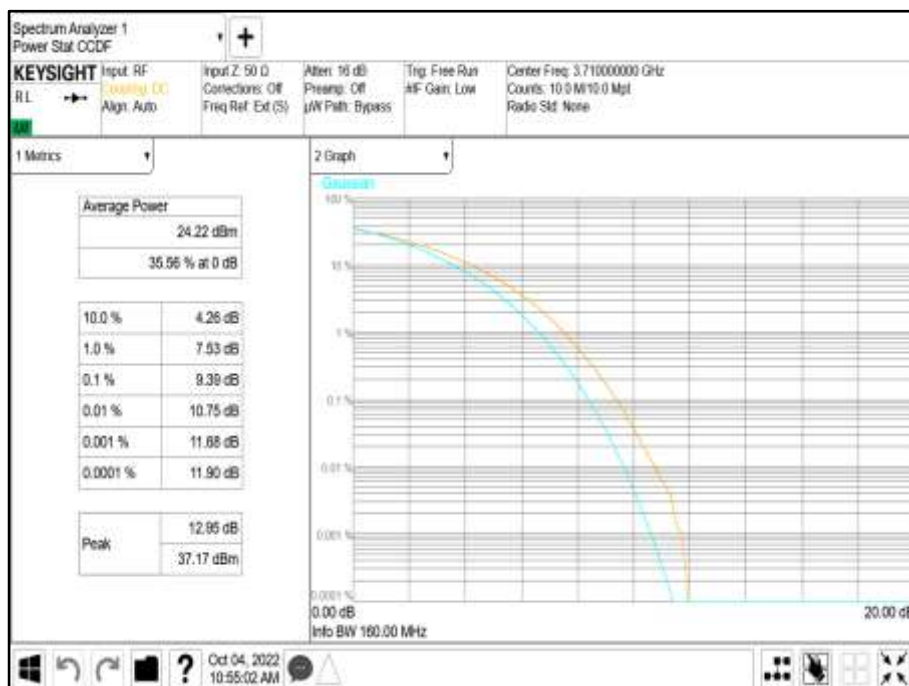



Antenna Port D PSD - Modulation NR: QPSK - Carrier Bandwidth 20.0 MHz - Channel Position B



Antenna Port D Carrier Power - Modulation NR: QPSK - Carrier Bandwidth 30.0 MHz - Channel Position B

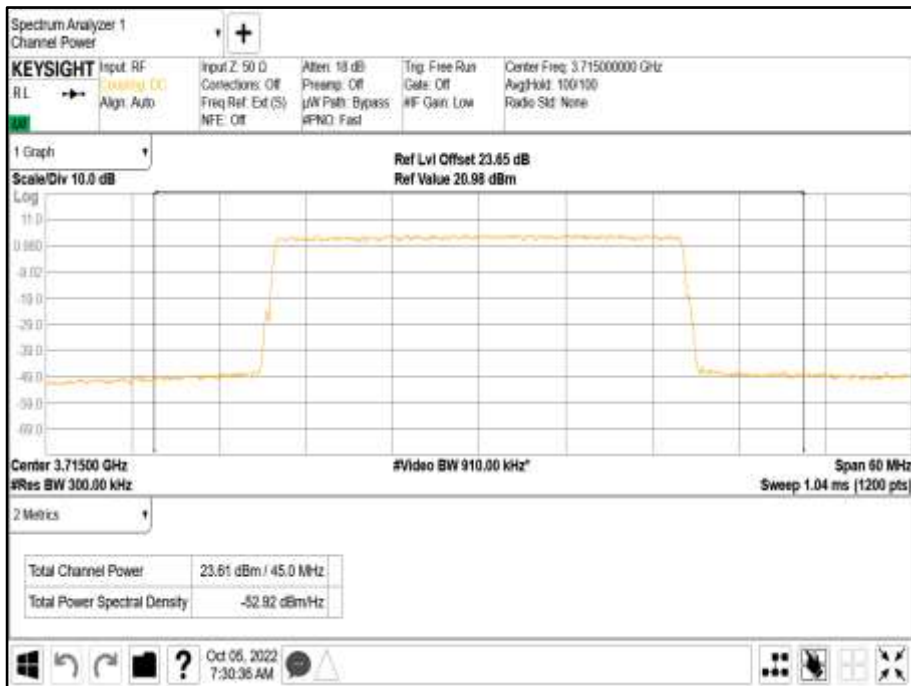

Antenna Port D Pk-Av Ratio - Modulation NR: QPSK - Carrier Bandwidth 30.0 MHz - Channel Position B

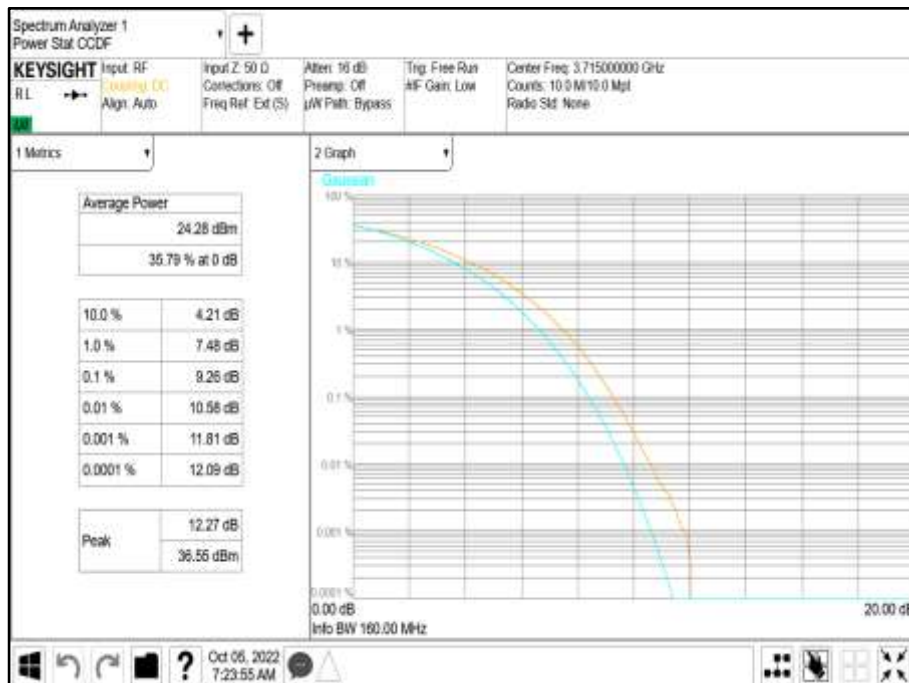

Antenna Port D PSD - Modulation NR: QPSK - Carrier Bandwidth 30.0 MHz - Channel Position B





Antenna Port D Carrier Power - Modulation NR: QPSK - Carrier Bandwidth 40.0 MHz - Channel Position B



Antenna Port D Pk-Av Ratio - Modulation NR: QPSK - Carrier Bandwidth 40.0 MHz - Channel Position B

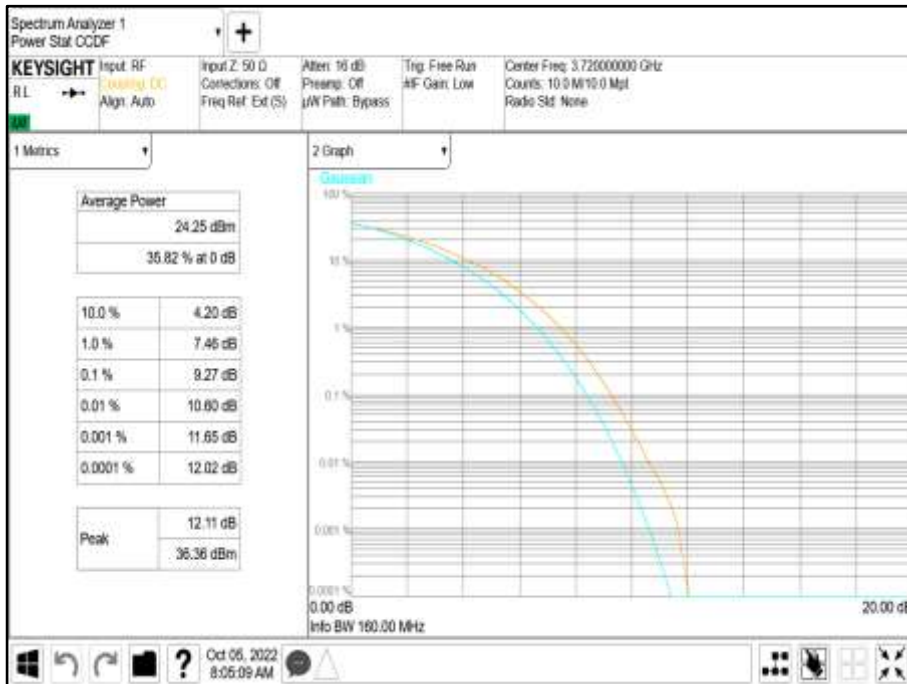



Antenna Port D PSD - Modulation NR: QPSK - Carrier Bandwidth 40.0 MHz - Channel Position B



Antenna Port D Carrier Power - Modulation NR: QPSK - Carrier Bandwidth 50.0 MHz - Channel Position B

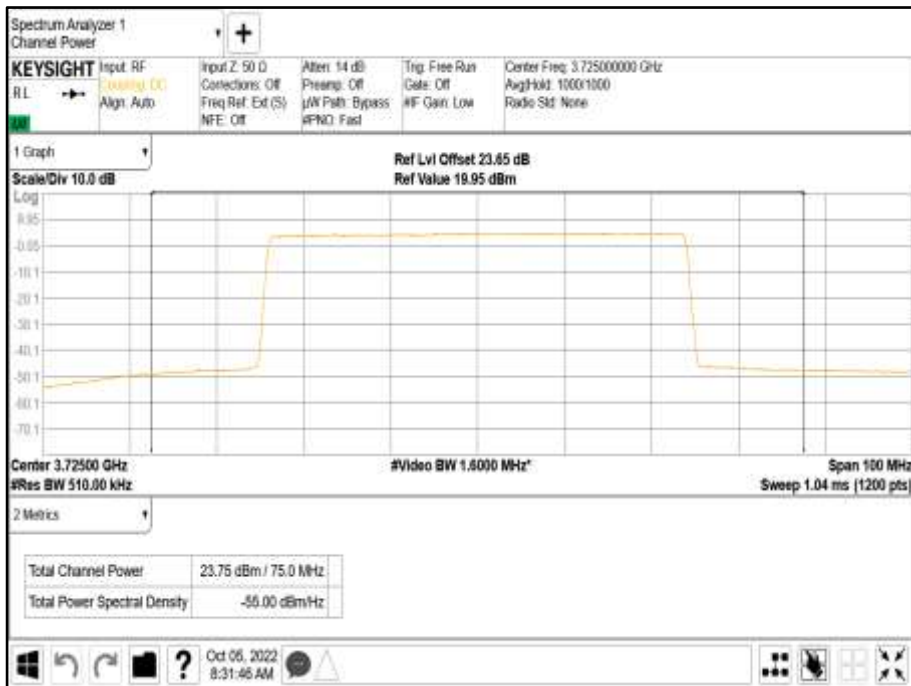



Antenna Port D Pk-Av Ratio - Modulation NR: QPSK - Carrier Bandwidth 50.0 MHz - Channel Position B

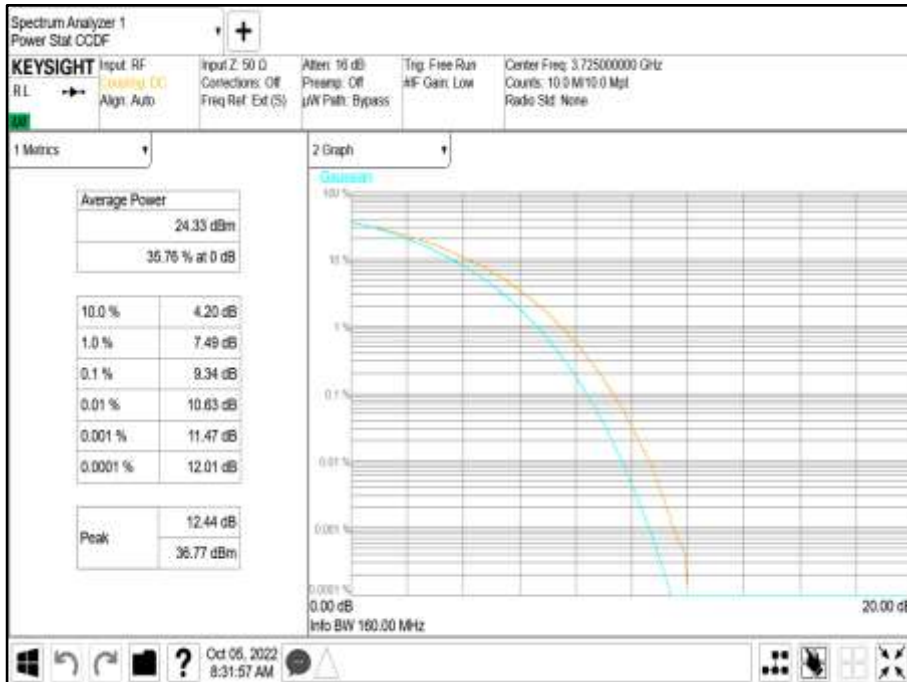

Antenna Port D PSD - Modulation NR: QPSK - Carrier Bandwidth 50.0 MHz - Channel Position B





Antenna Port D Carrier Power - Modulation NR: QPSK - Carrier Bandwidth 60.0 MHz - Channel Position B



Antenna Port D Pk-Av Ratio - Modulation NR: QPSK - Carrier Bandwidth 60.0 MHz - Channel Position B

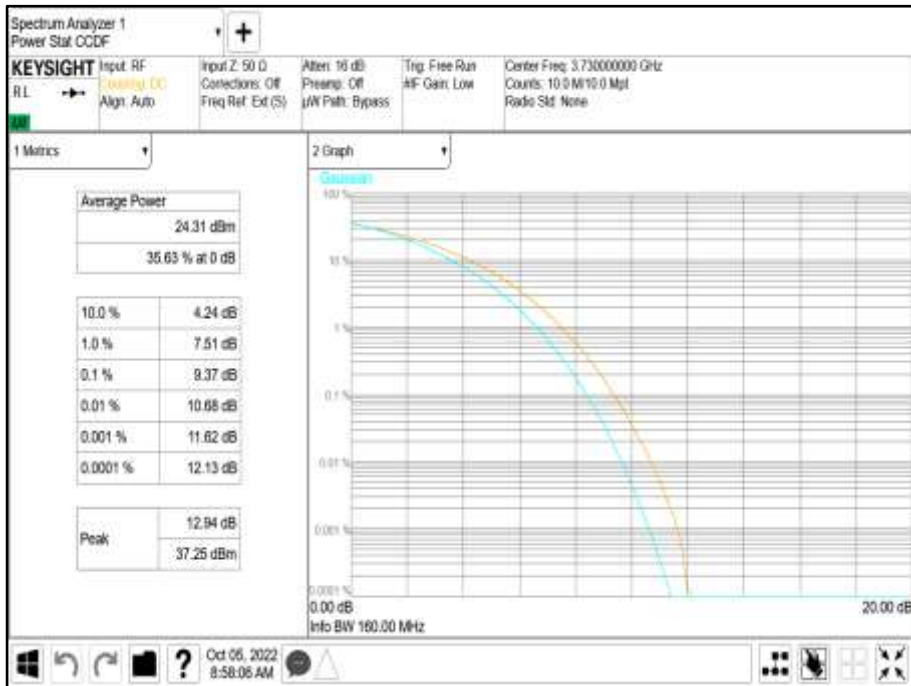



Antenna Port D PSD - Modulation NR: QPSK - Carrier Bandwidth 60.0 MHz - Channel Position B



Antenna Port D Carrier Power - Modulation NR: QPSK - Carrier Bandwidth 70.0 MHz - Channel Position B





Antenna Port D Pk-Av Ratio - Modulation NR: QPSK - Carrier Bandwidth 70.0 MHz - Channel Position B



Antenna Port D PSD - Modulation NR: QPSK - Carrier Bandwidth 70.0 MHz - Channel Position B





Antenna Port D Carrier Power - Modulation NR: QPSK - Carrier Bandwidth 80.0 MHz - Channel Position B



Antenna Port D Pk-Av Ratio - Modulation NR: QPSK - Carrier Bandwidth 80.0 MHz - Channel Position B

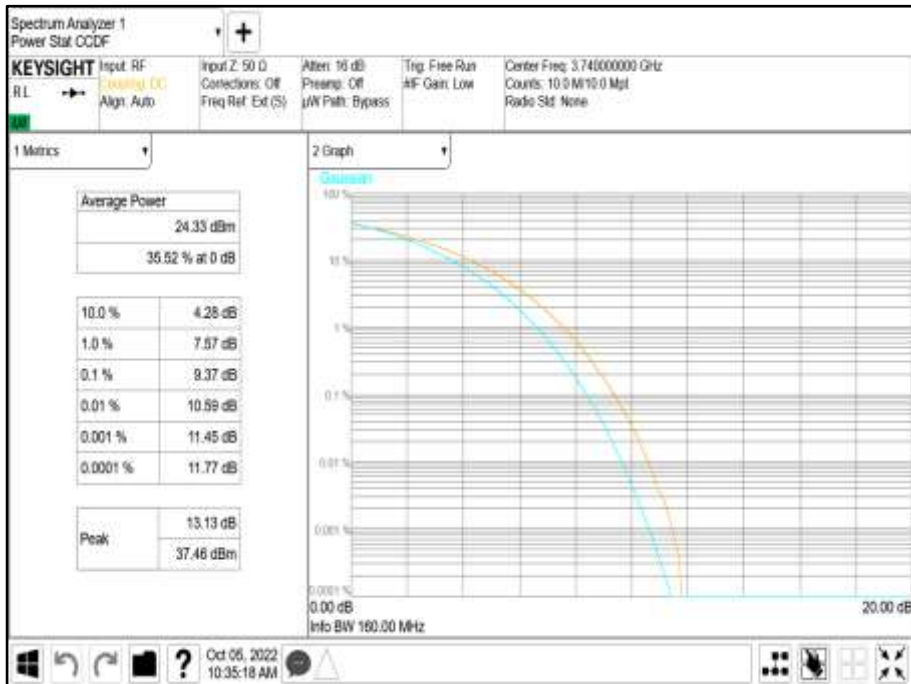



Antenna Port D PSD - Modulation NR: QPSK - Carrier Bandwidth 80.0 MHz - Channel Position B



Antenna Port D Carrier Power - Modulation NR: QPSK - Carrier Bandwidth 90.0 MHz - Channel Position B





Antenna Port D Pk-Av Ratio - Modulation NR: QPSK - Carrier Bandwidth 90.0 MHz - Channel Position B

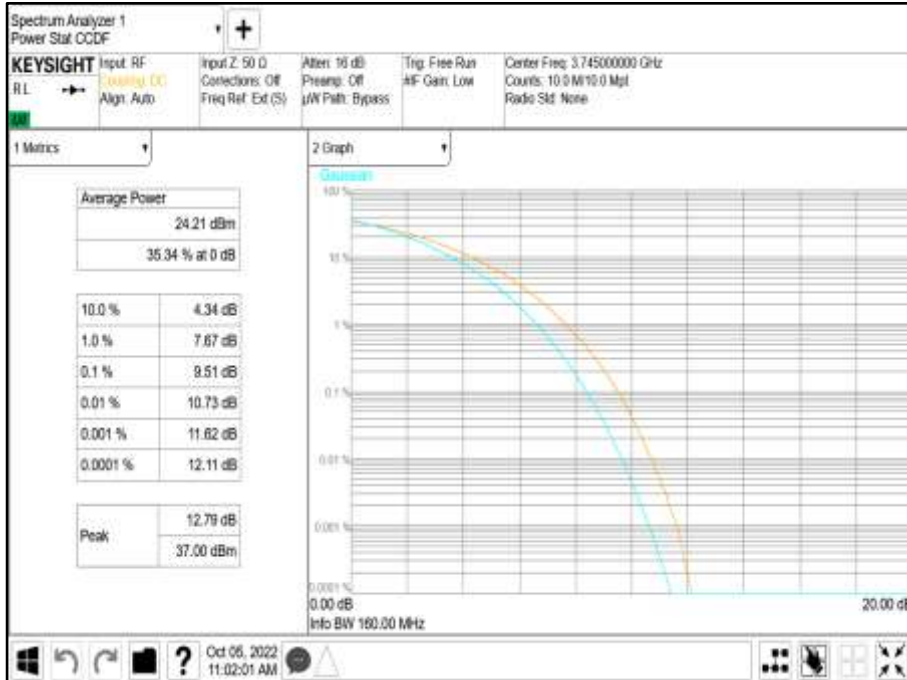

Antenna Port D PSD - Modulation NR: QPSK - Carrier Bandwidth 90.0 MHz - Channel Position B





Antenna Port D Carrier Power - Modulation NR: QPSK - Carrier Bandwidth 100.0 MHz - Channel Position B



Antenna Port D Pk-Av Ratio - Modulation NR: QPSK - Carrier Bandwidth 100.0 MHz - Channel Position B

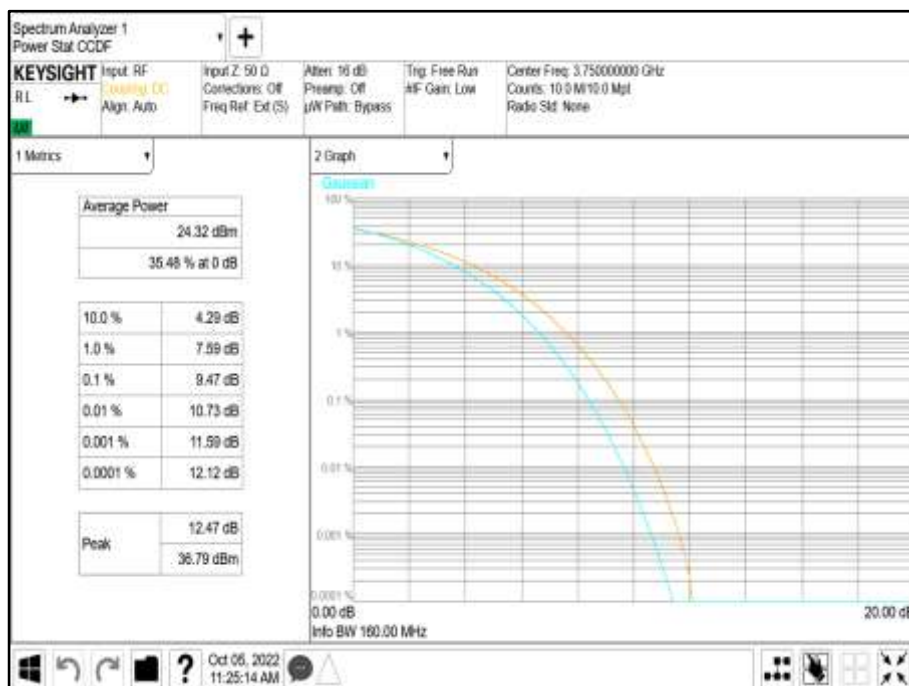



Antenna Port D PSD - Modulation NR: QPSK - Carrier Bandwidth 100.0 MHz - Channel Position B





Configuration B

Maximum Output Power 26.00 dBm / Port

Antenna Gain (dBi)	Modulation	Carrier Bandwidth	Output Power		Output Power		Output Power	
			Channel Position B		Channel Position M		Channel Position T	
			Average Power (dBm)		Average Power (dBm)		Average Power (dBm)	
			dBm	EIRP (dBm)	dBm	EIRP (dBm)	dBm	EIRP (dBm)
5.39								
Antenna Port								
A	NR10: QPSK	NR10.0+NR10.0 MHz	25.98	31.37	26.10	31.49	26.19	31.58
B	NR10: QPSK	NR10.0+NR10.0 MHz	25.94	31.33	26.20	31.59	26.18	31.57
C	NR10: QPSK	NR10.0+NR10.0 MHz	26.03	31.42	26.33	31.72	26.16	31.55
D	NR10: QPSK	NR10.0+NR10.0 MHz	26.21	31.60	26.20	31.59	26.28	31.67
Total			32.06	37.45	32.23	37.62	32.22	37.61
A	NR100: QPSK	NR100.0+NR100.0 MHz	25.58	30.97	25.35	30.74	25.31	30.70
B	NR100: QPSK	NR100.0+NR100.0 MHz	25.49	30.88	25.36	30.75	25.39	30.78
C	NR100: QPSK	NR100.0+NR100.0 MHz	25.62	31.01	25.54	30.93	25.38	30.77
D	NR100: QPSK	NR100.0+NR100.0 MHz	25.43	30.82	25.54	30.93	25.47	30.86
Total			31.55	36.94	31.47	36.86	31.41	36.80
A	NR10: QPSK (NC)	NR10.0+NR10.0 MHz	25.31	30.70	25.25	30.64	25.63	31.02
B	NR10: QPSK (NC)	NR10.0+NR10.0 MHz	25.35	30.74	25.46	30.85	25.41	30.80
C	NR10: QPSK (NC)	NR10.0+NR10.0 MHz	25.47	30.86	25.71	31.10	25.59	30.98
D	NR10: QPSK (NC)	NR10.0+NR10.0 MHz	25.49	30.88	25.72	31.11	25.56	30.95
Total			31.43	36.82	31.56	36.95	31.57	36.96
A	NR90: QPSK (NC)	NR90.0+NR90.0 MHz	25.36	30.75	25.28	30.67	25.42	30.81
B	NR90: QPSK (NC)	NR90.0+NR90.0 MHz	25.14	30.53	25.49	30.88	25.40	30.79
C	NR90: QPSK (NC)	NR90.0+NR90.0 MHz	25.45	30.84	25.59	30.98	25.70	31.09
D	NR90: QPSK (NC)	NR90.0+NR90.0 MHz	25.64	31.03	25.68	31.07	25.73	31.12
Total			31.42	36.81	31.53	36.92	31.59	36.98

Remarks

1. The table results are measured at all antenna ports. 2. The plot results represent typical radio performance across all channels. 3. Plot data performance for all transmitter ports and channels for both contiguous and non-contiguous (NC) operation are available on request.



Antenna Port D Carrier Power - Modulation NR10: QPSK - Carrier Bandwidth NR10.0+NR10.0 MHz - Channel Position M



Antenna Port D Carrier Power - Modulation NR100: QPSK - Carrier Bandwidth NR100.0+NR100.0 MHz - Channel Position M





Antenna Port D Carrier Power - Modulation NR10: QPSK (NC) - Carrier Bandwidth NR10.0+NR10.0 MHz - Channel Position M



Antenna Port D Carrier Power - Modulation NR90: QPSK (NC) - Carrier Bandwidth NR90.0+NR90.0 MHz - Channel Position M





Configuration C

Maximum Output Power 26.00 dBm / Port

Antenna Gain (dBi)	Antenna Port	Modulation	Carrier Bandwidth	Output Power		Output Power		Output Power	
				Channel Position B		Channel Position M		Channel Position T	
				Average Power (dBm)		Average Power (dBm)		Average Power (dBm)	
				dBm	EIRP (dBm)	dBm	EIRP (dBm)	dBm	EIRP (dBm)
5.39									
	A	NR10: QPSK	10+10+10+10+10+10 MHz	25.79	31.18	25.88	31.27	25.93	31.32
	B	NR10: QPSK	10+10+10+10+10+10 MHz	25.82	31.21	25.98	31.37	26.01	31.40
	C	NR10: QPSK	10+10+10+10+10+10 MHz	25.90	31.29	25.90	31.29	26.16	31.55
	D	NR10: QPSK	10+10+10+10+10+10 MHz	26.09	31.48	25.92	31.31	26.31	31.70
	Total			31.92	37.31	31.94	37.33	32.13	37.52
	A	NR20: QPSK	20+20+20+20+20+20 MHz	25.39	30.78	25.44	30.83	25.46	30.85
	B	NR20: QPSK	20+20+20+20+20+20 MHz	25.39	30.78	25.65	31.04	25.48	30.87
	C	NR20: QPSK	20+20+20+20+20+20 MHz	25.82	31.21	25.65	31.04	25.61	31.00
	D	NR20: QPSK	20+20+20+20+20+20 MHz	25.73	31.12	25.72	31.11	25.79	31.18
	Total			31.61	37.00	31.64	37.03	31.61	37.00
	A	NR10: QPSK (NC)	10+10+10+10+10+10 MHz	25.30	30.69	25.47	30.86	25.73	31.12
	B	NR10: QPSK (NC)	10+10+10+10+10+10 MHz	25.39	30.78	25.54	30.93	25.60	30.99
	C	NR10: QPSK (NC)	10+10+10+10+10+10 MHz	25.50	30.89	25.79	31.18	25.66	31.05
	D	NR10: QPSK (NC)	10+10+10+10+10+10 MHz	25.52	30.91	25.76	31.15	25.68	31.07
	Total			31.45	36.84	31.66	37.05	31.69	37.08
	A	NR20: QPSK (NC)	20+20+20+20+20+20 MHz	25.39	30.78	25.43	30.82	25.43	30.82
	B	NR20: QPSK (NC)	20+20+20+20+20+20 MHz	25.31	30.70	25.49	30.88	25.29	30.68
	C	NR20: QPSK (NC)	20+20+20+20+20+20 MHz	25.17	30.56	25.36	30.75	25.84	31.23
	D	NR20: QPSK (NC)	20+20+20+20+20+20 MHz	25.44	30.83	26.23	31.62	25.76	31.15
	Total			31.35	36.74	31.66	37.05	31.61	37.00

Remarks

1. The table results are measured at all antenna ports. 2. The plot results represent typical radio performance across all channels. 3. Plot data performance for all transmitter ports and channels for both contiguous and non-contiguous (NC) operation are available on request.



Antenna Port D Carrier Power - Modulation NR10: QPSK - Carrier Bandwidth 10+10+10+10+10+10 MHz - Channel Position M

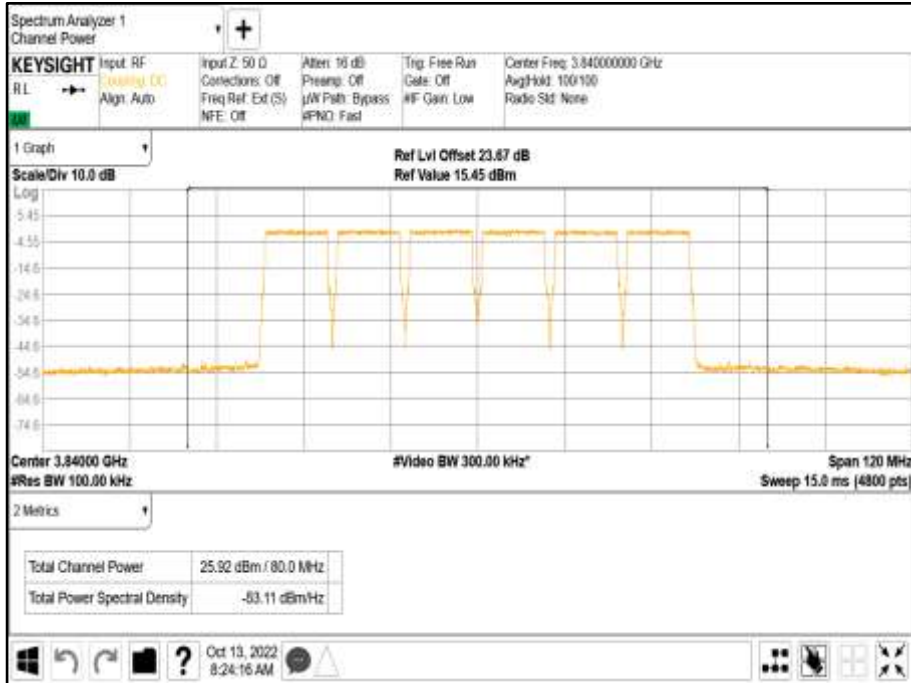

Antenna Port D Carrier Power - Modulation NR20: QPSK - Carrier Bandwidth 20+20+20+20+20+20 MHz - Channel Position M

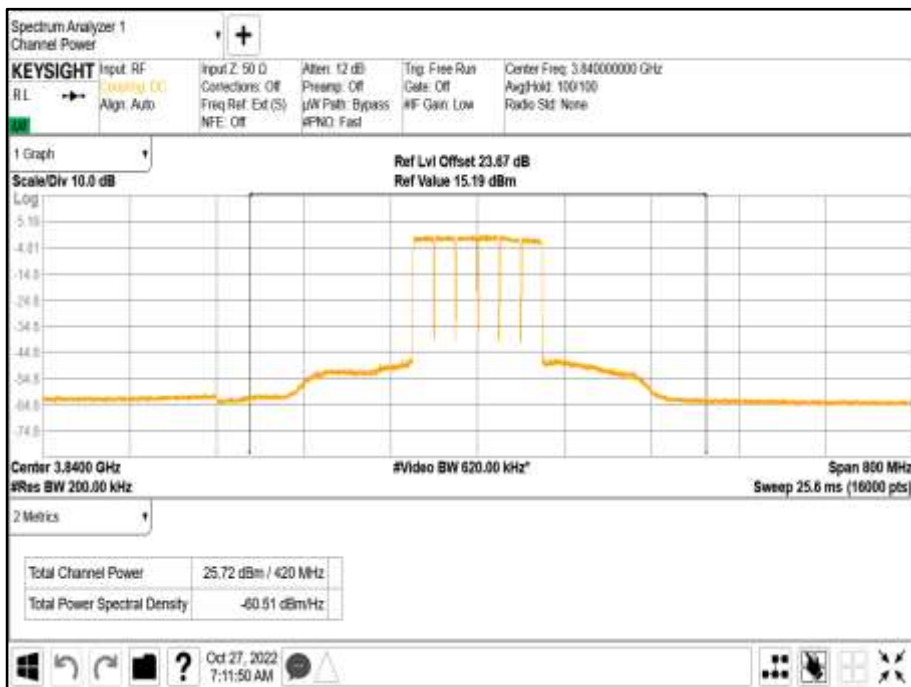



Antenna Port D Carrier Power - Modulation NR10: QPSK (NC) - Carrier Bandwidth 10+10+10+10+10+10 MHz - Channel Position M

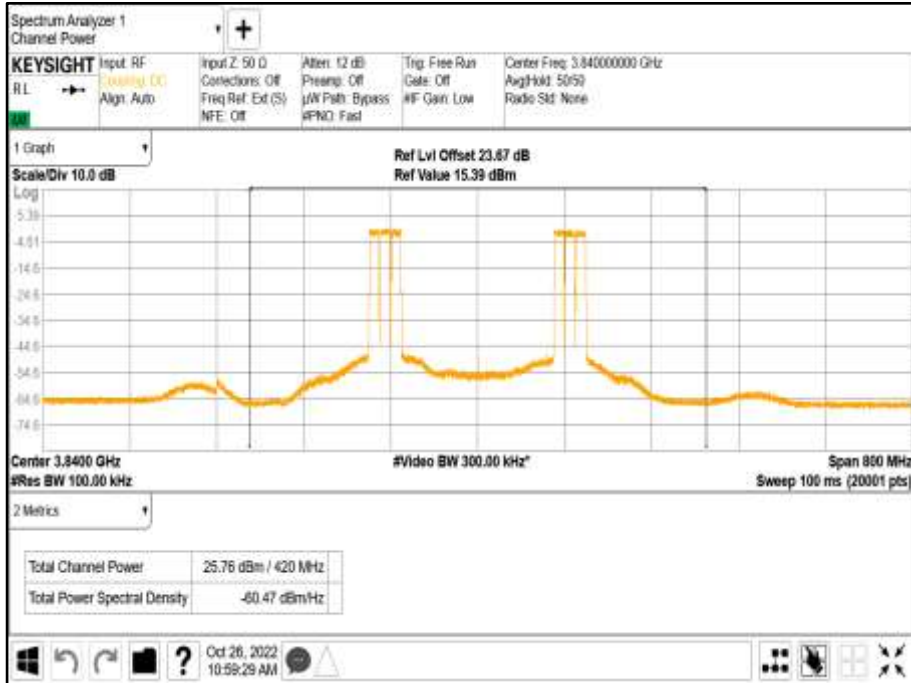

Antenna Port D Carrier Power - Modulation NR20: QPSK (NC) - Carrier Bandwidth 20+20+20+20+20+20 MHz - Channel Position M

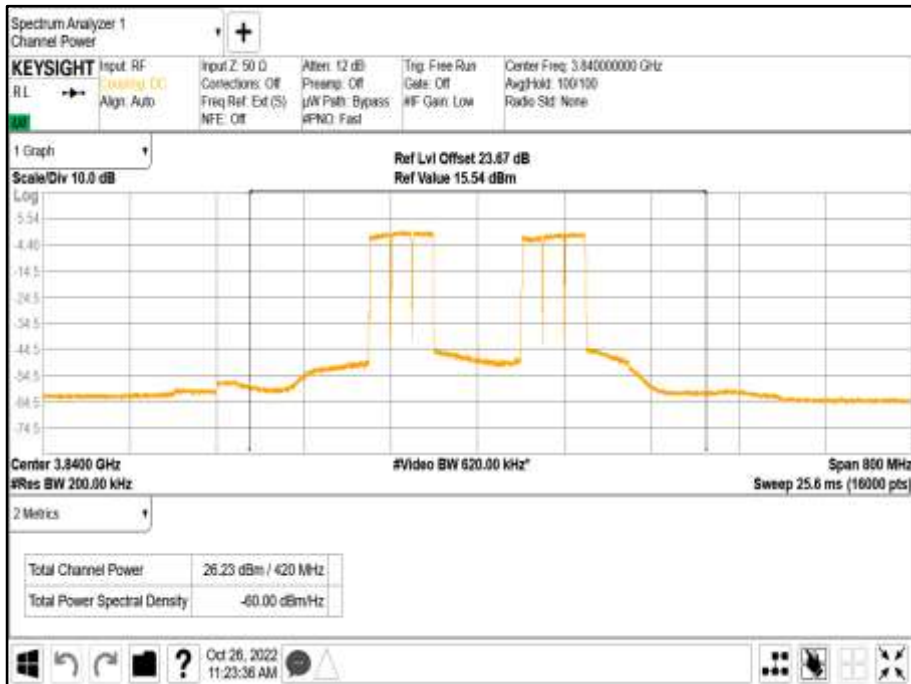



2.2 OCCUPIED BANDWIDTH

2.2.1 Specification Reference

FCC CFR 47 Part 27, Clause 27.53
 FCC CFR 47 Part 2, Clause 2.1049

2.2.2 Date of Test and Modification State

04-October-2022 - Modification State 0

2.2.3 Test Equipment Used

The major items of test equipment used for the above tests are identified in Section 3.1.

2.2.4 Environmental Conditions

Ambient Temperature 24.3°C
 Relative Humidity 31.0%

2.2.5 Test Method

All measurements were made in accordance with FCC KDB 971168 D01, Clause 4.2 and 4.3. The Spectrum Analyser RBW was configured to be at least 1% of the channel bandwidth of the carrier to be measured.

2.2.6 Test Results

Configuration A

Maximum Output Power 24.00 dBm / Port

Modulation	Carrier Bandwidth	Result (MHz)	
		Channel Bandwidth	
		99% Occupied Bandwidth	
NR: QPSK	NR: 10.0 MHz	8.6295	
NR: QPSK	NR: 15.0 MHz	13.5740	
NR: QPSK	NR: 20.0 MHz	18.2270	
NR: QPSK	NR: 30.0 MHz	27.9080	
NR: QPSK	NR: 40.0 MHz	37.8150	
NR: QPSK	NR: 50.0 MHz	47.4010	
NR: QPSK	NR: 60.0 MHz	57.7540	
NR: QPSK	NR: 70.0 MHz	67.3930	
NR: QPSK	NR: 80.0 MHz	77.2850	
NR: QPSK	NR: 90.0 MHz	87.2510	
NR: QPSK	NR: 100.0 MHz	97.2410	

Remarks

Representative occupied bandwidth performance results presented. Plot data performance for all transmitter ports and channel positions are on file and available on request.



Antenna D - Modulation NR: QPSK - LTE Carrier Bandwidth NR: 10.0 MHz - Channel Position B

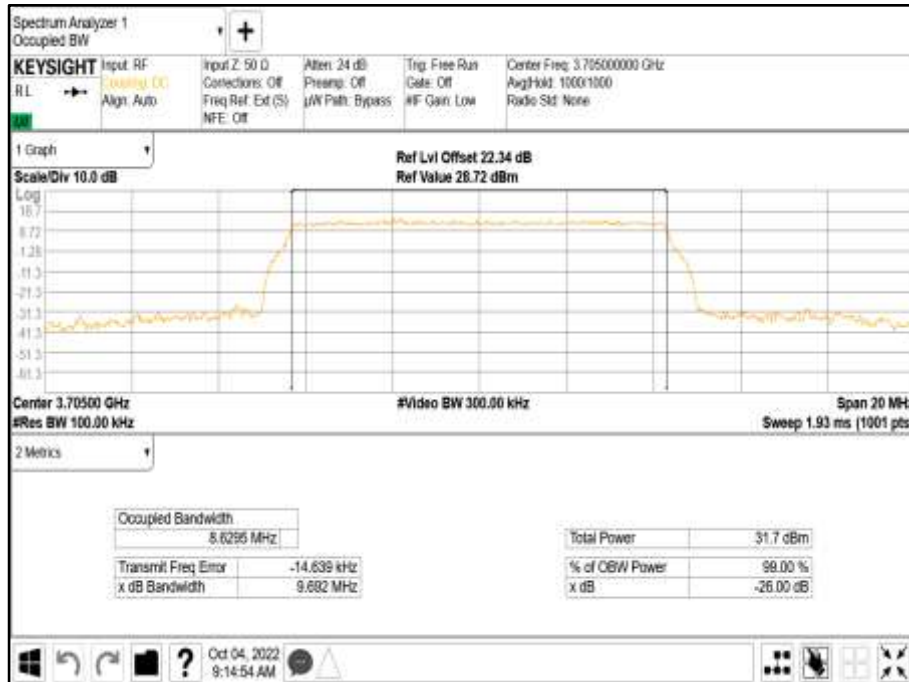

Antenna D - Modulation NR: QPSK - LTE Carrier Bandwidth NR: 15.0 MHz - Channel Position B

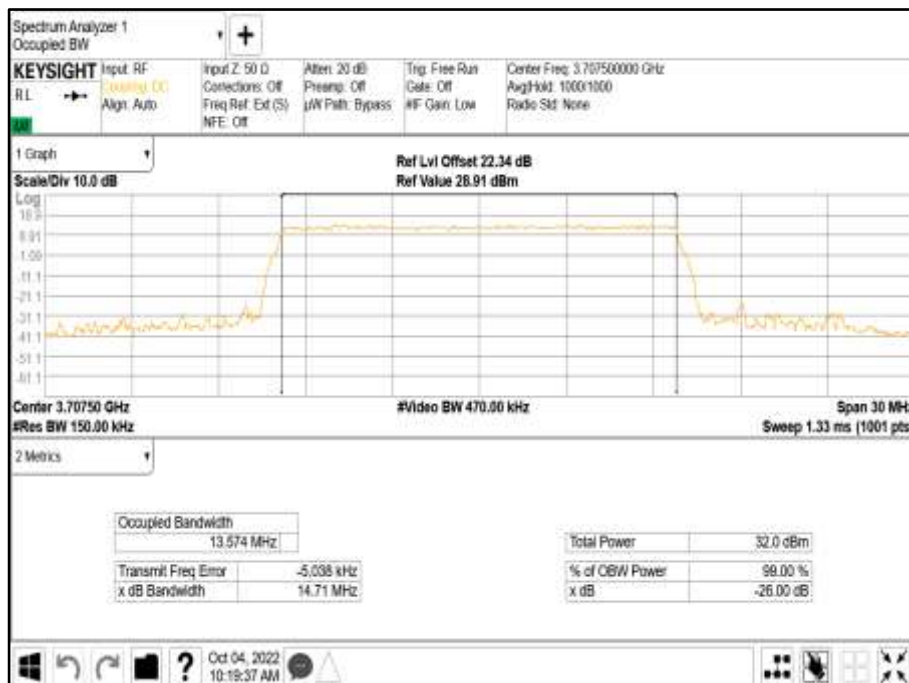



Antenna D - Modulation NR: QPSK - LTE Carrier Bandwidth NR: 20.0 MHz - Channel Position B

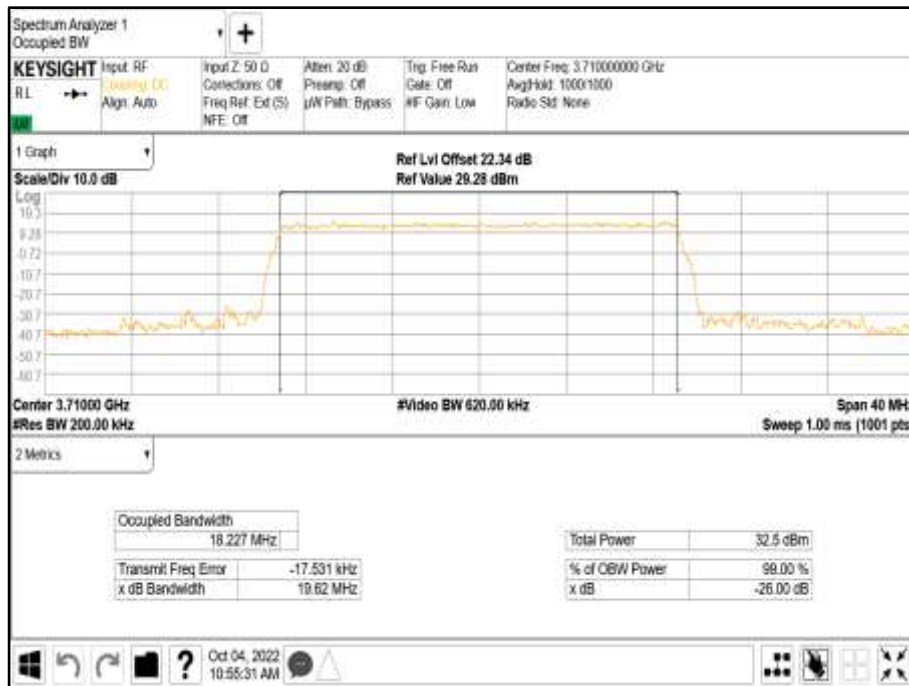

Antenna D - Modulation NR: QPSK - LTE Carrier Bandwidth NR: 30.0 MHz - Channel Position B

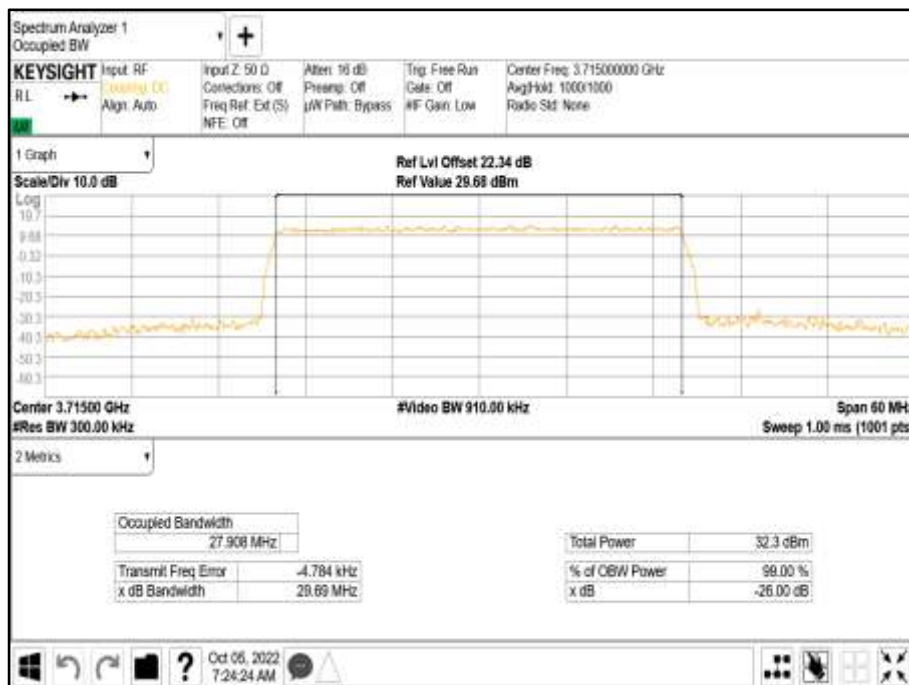



Antenna D - Modulation NR: QPSK - LTE Carrier Bandwidth NR: 40.0 MHz - Channel Position B

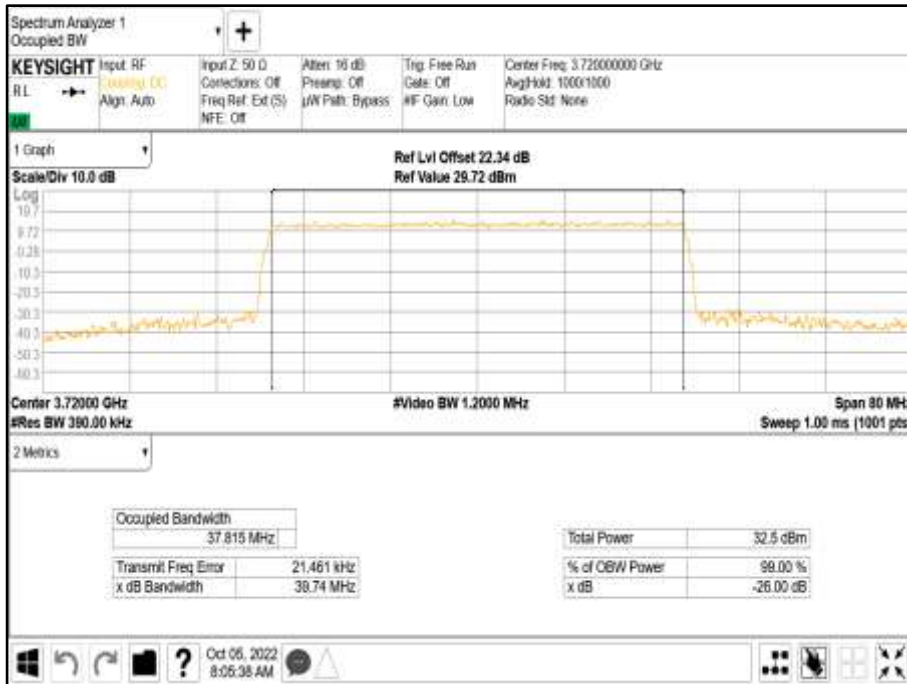

Antenna D - Modulation NR: QPSK - LTE Carrier Bandwidth NR: 50.0 MHz - Channel Position B

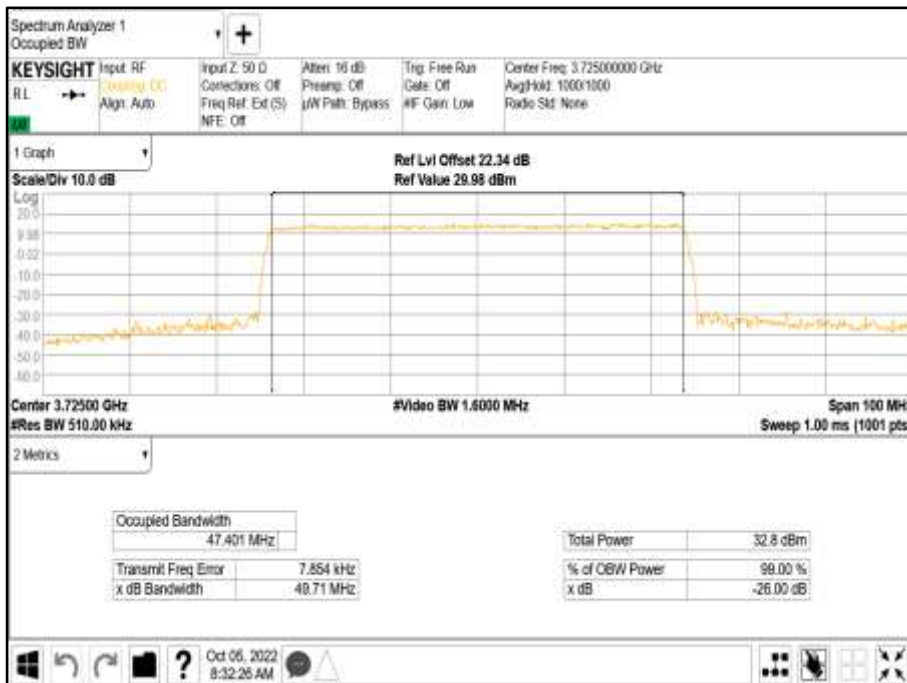



Antenna D - Modulation NR: QPSK - LTE Carrier Bandwidth NR: 60.0 MHz - Channel Position B

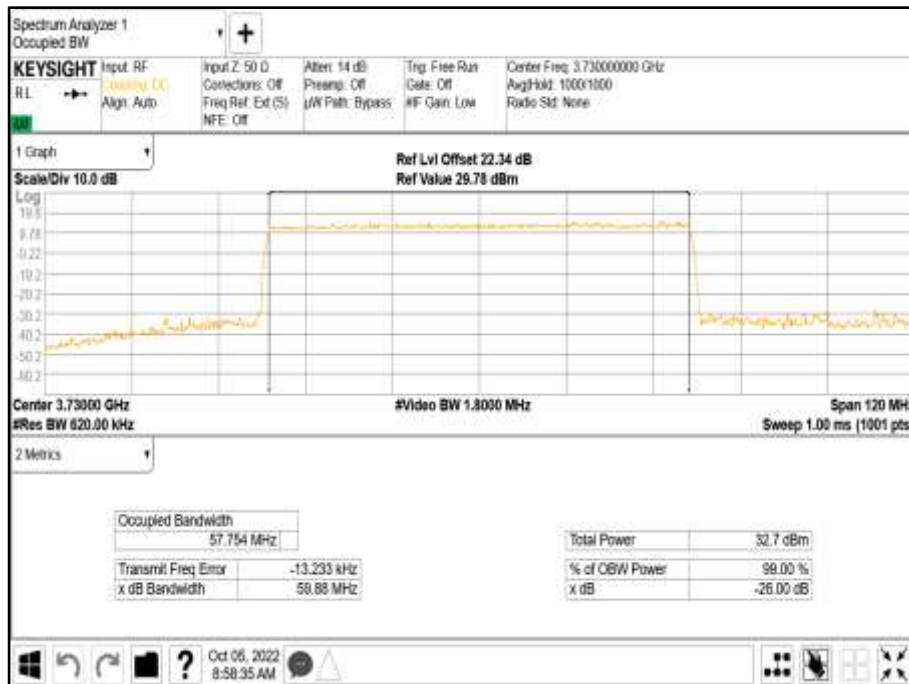

Antenna D - Modulation NR: QPSK - LTE Carrier Bandwidth NR: 70.0 MHz - Channel Position B

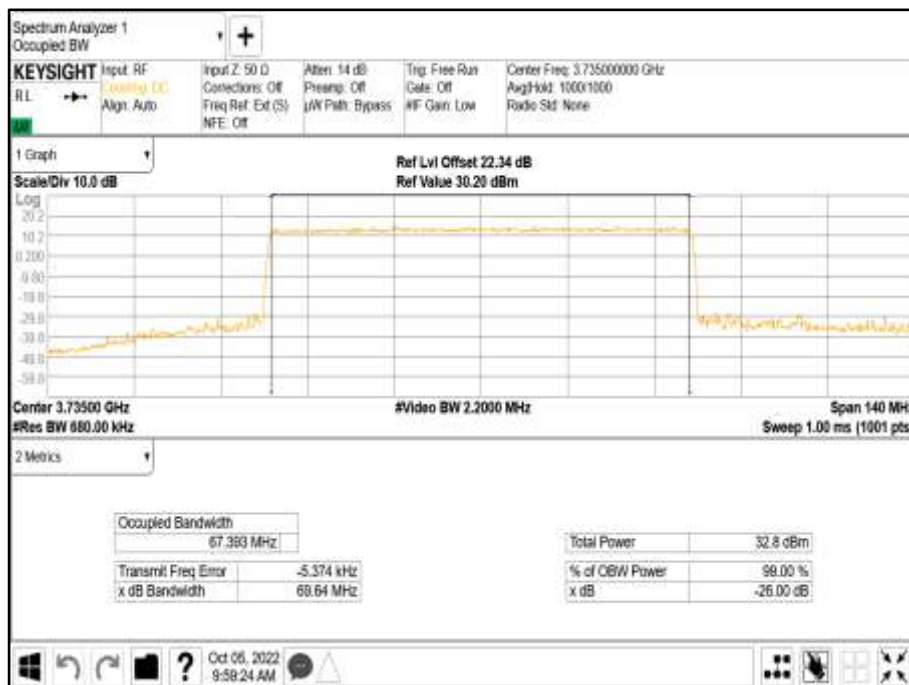



Antenna D - Modulation NR: QPSK - LTE Carrier Bandwidth NR: 80.0 MHz - Channel Position B

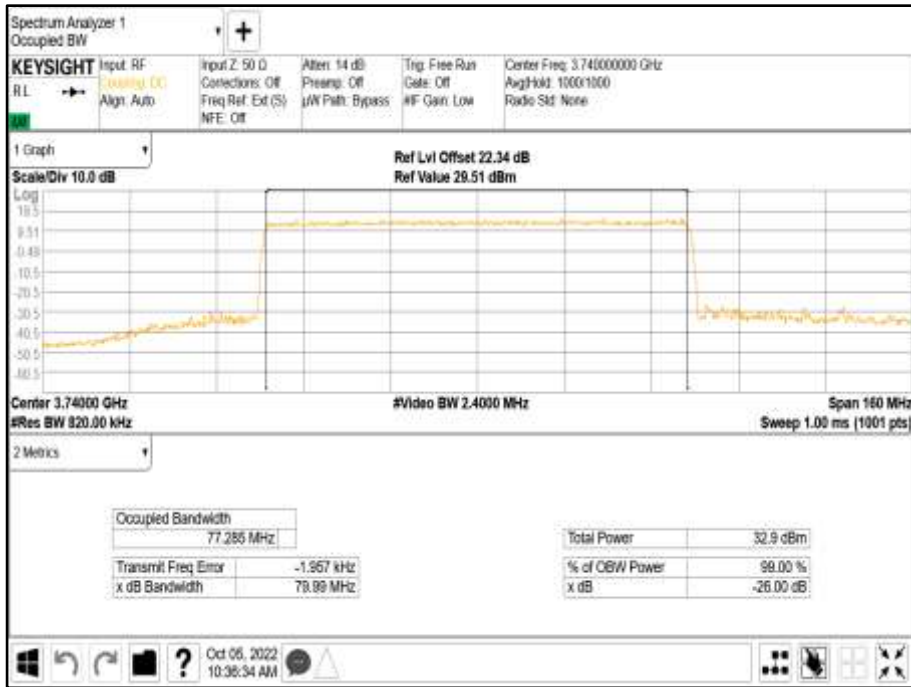

Antenna D - Modulation NR: QPSK - LTE Carrier Bandwidth NR: 90.0 MHz - Channel Position B

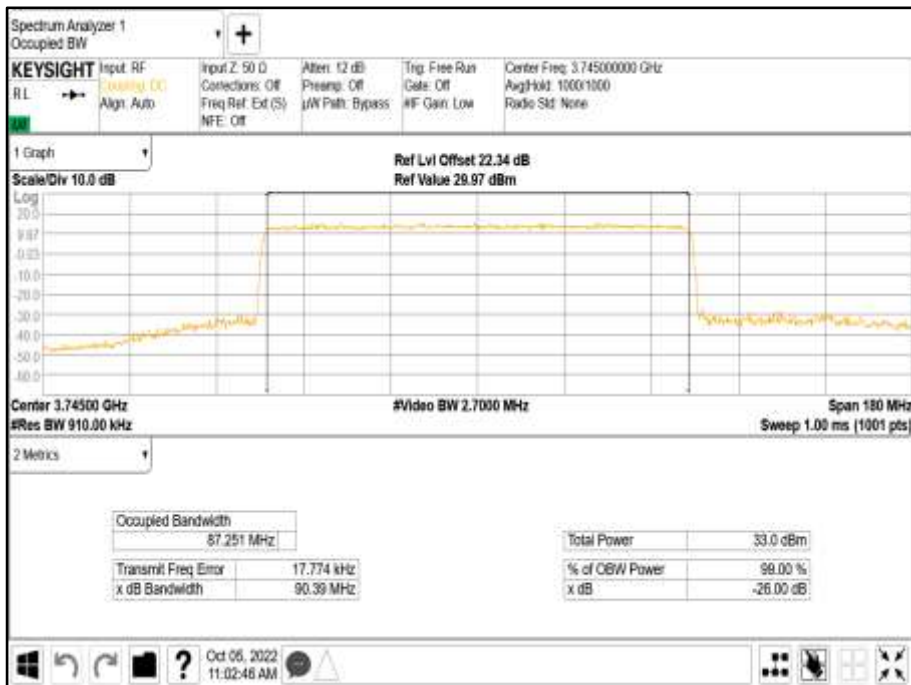



Antenna D - Modulation NR: QPSK - LTE Carrier Bandwidth NR: 100.0 MHz - Channel Position B

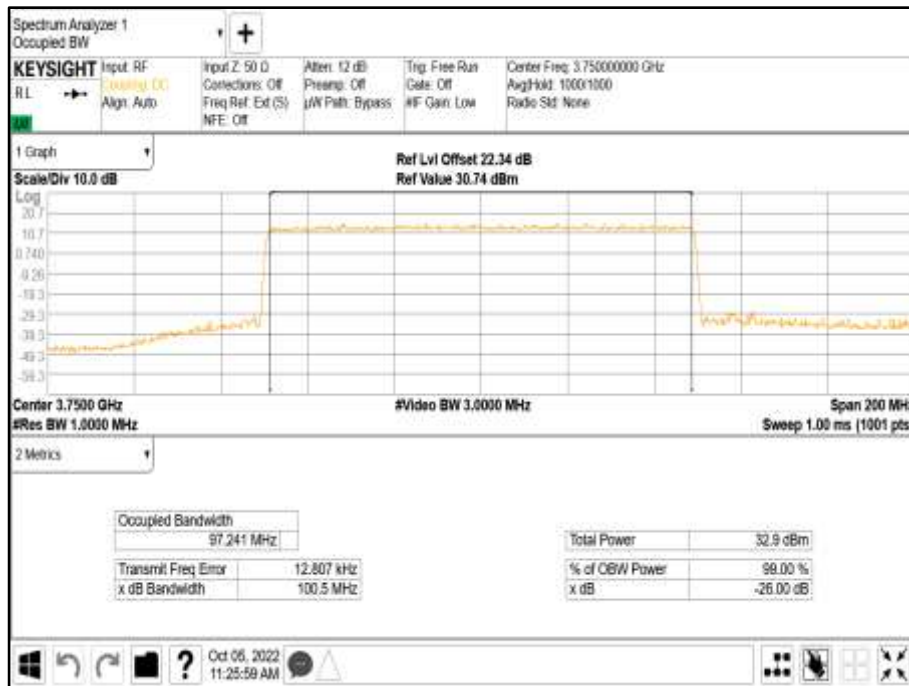



2.3 BAND EDGE

2.3.1 Specification Reference

FCC CFR 47 Part 27, Clause 27.53
FCC CFR 47 Part 2, Clause 2.1051

2.3.2 Date of Test and Modification State

04-October-2022 - Modification State 0

2.3.3 Test Equipment Used

The major items of test equipment used for the above tests are identified in Section 3.1.

2.3.4 Environmental Conditions

Ambient Temperature 24.3°C
Relative Humidity 31.0%

2.3.5 Test Method

All measurements were made in accordance with FCC KDB 971168 D01, Clause 6.0.

Band Edge measurements were done using an Integration Bandwidth of 1% or greater of the measured 26dB Bandwidth.

All 4 antenna ports have been declared as being equivalent, therefore measurements were made on one antenna port only (worst-case). To account for this, the limit was integrated by $10 * \text{Log}(N)$, where N is equal to the number of MIMO antenna ports as per below.

For multi-port, the limit was calculated as being $-13 \text{ dBm} - 10 * \text{Log}(4) = -19 \text{ dBm}$.

2.3.6 Test Results

Configuration A

Maximum Output Power 24.00 dBm / Port



Antenna Port A	Modulation	Carrier Bandwidth	Band Edge (MHz)	
			Channel Position B	Channel Position T
D	NR: QPSK	NR: 10.0 MHz	3,705.0	3,840.0
D	NR: QPSK	NR: 15.0 MHz	3,707.5	3,972.5
D	NR: QPSK	NR: 20.0 MHz	3,710.0	3,970.0
D	NR: QPSK	NR: 30.0 MHz	3,715.0	3,965.0
D	NR: QPSK	NR: 40.0 MHz	3,720.0	3,960.0
D	NR: QPSK	NR: 50.0 MHz	3,725.0	3,955.0
D	NR: QPSK	NR: 60.0 MHz	3,730.0	3,950.0
D	NR: QPSK	NR: 70.0 MHz	3,735.0	3,945.0
D	NR: QPSK	NR: 80.0 MHz	3,740.0	3,940.0
D	NR: QPSK	NR: 90.0 MHz	3,745.0	3,935.0
D	NR: QPSK	NR: 100.0 MHz	3,750.0	3,930.0

Remarks

1. Bandedge data was captured from the transmit port with maximum measured power. 2. Worst case bandedge data presented.



Antenna Port D - Modulation NR: QPSK - Carrier Bandwidth NR: 10.0 MHz - Channel Position B

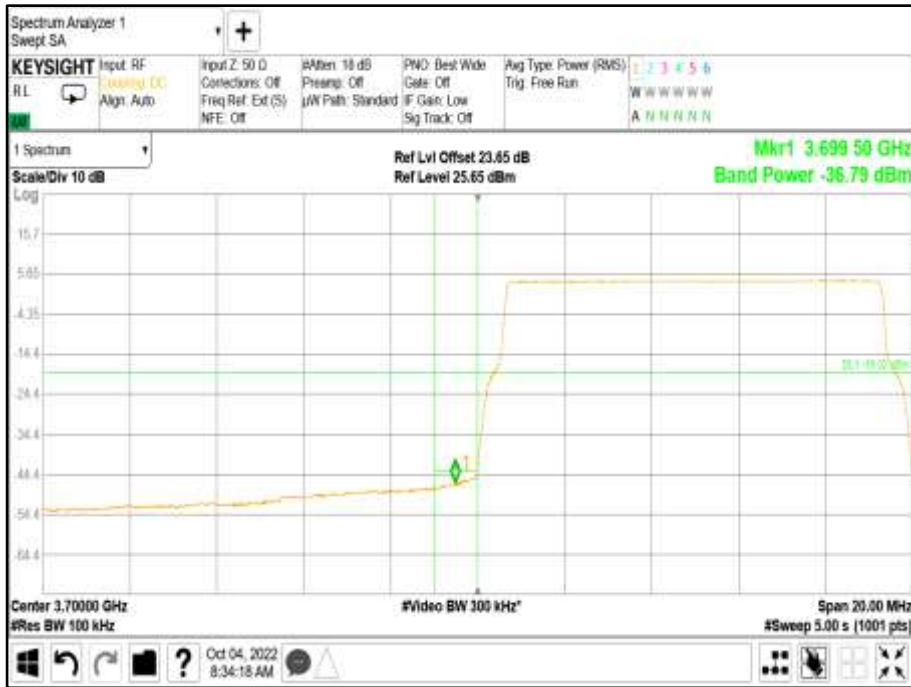

Antenna Port D - Modulation NR: QPSK - Carrier Bandwidth NR: 10.0 MHz - Channel Position T





Antenna Port D - Modulation NR: QPSK - Carrier Bandwidth NR: 15.0 MHz - Channel Position B

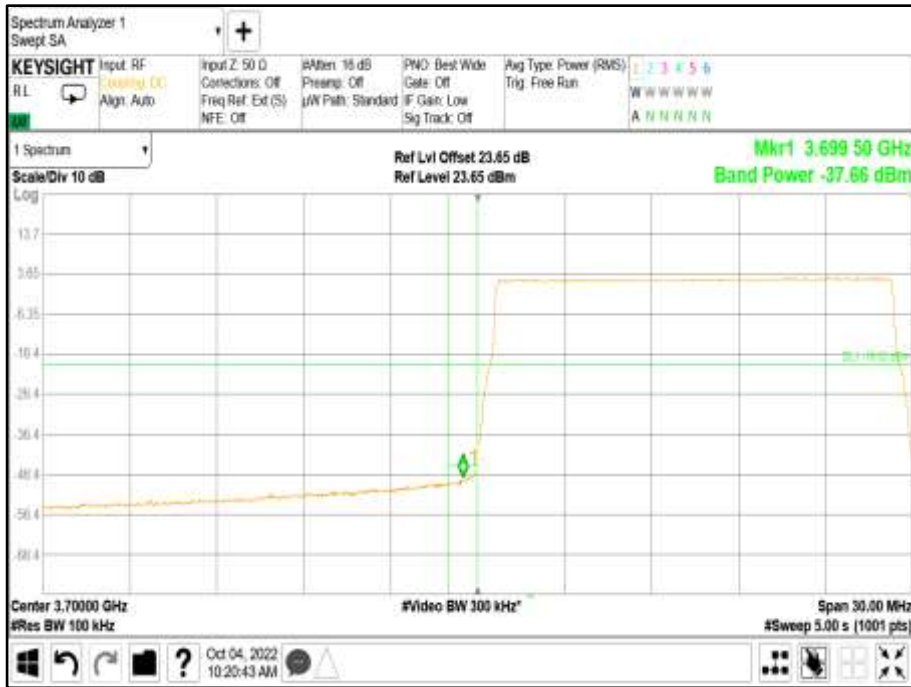

Antenna Port D - Modulation NR: QPSK - Carrier Bandwidth NR: 15.0 MHz - Channel Position T





Antenna Port D - Modulation NR: QPSK - Carrier Bandwidth NR: 20.0 MHz - Channel Position B



Antenna Port D - Modulation NR: QPSK - Carrier Bandwidth NR: 20.0 MHz - Channel Position T





Antenna Port D - Modulation NR: QPSK - Carrier Bandwidth NR: 30.0 MHz - Channel Position B



Antenna Port D - Modulation NR: QPSK - Carrier Bandwidth NR: 30.0 MHz - Channel Position T





Antenna Port D - Modulation NR: QPSK - Carrier Bandwidth NR: 40.0 MHz - Channel Position B



Antenna Port D - Modulation NR: QPSK - Carrier Bandwidth NR: 40.0 MHz - Channel Position T





Antenna Port D - Modulation NR: QPSK - Carrier Bandwidth NR: 50.0 MHz - Channel Position B



Antenna Port D - Modulation NR: QPSK - Carrier Bandwidth NR: 50.0 MHz - Channel Position T





Antenna Port D - Modulation NR: QPSK - Carrier Bandwidth NR: 60.0 MHz - Channel Position B



Antenna Port D - Modulation NR: QPSK - Carrier Bandwidth NR: 60.0 MHz - Channel Position T





Antenna Port D - Modulation NR: QPSK - Carrier Bandwidth NR: 70.0 MHz - Channel Position B



Antenna Port D - Modulation NR: QPSK - Carrier Bandwidth NR: 70.0 MHz - Channel Position T





Antenna Port D - Modulation NR: QPSK - Carrier Bandwidth NR: 80.0 MHz - Channel Position B



Antenna Port D - Modulation NR: QPSK - Carrier Bandwidth NR: 80.0 MHz - Channel Position T





Antenna Port D - Modulation NR: QPSK - Carrier Bandwidth NR: 90.0 MHz - Channel Position B

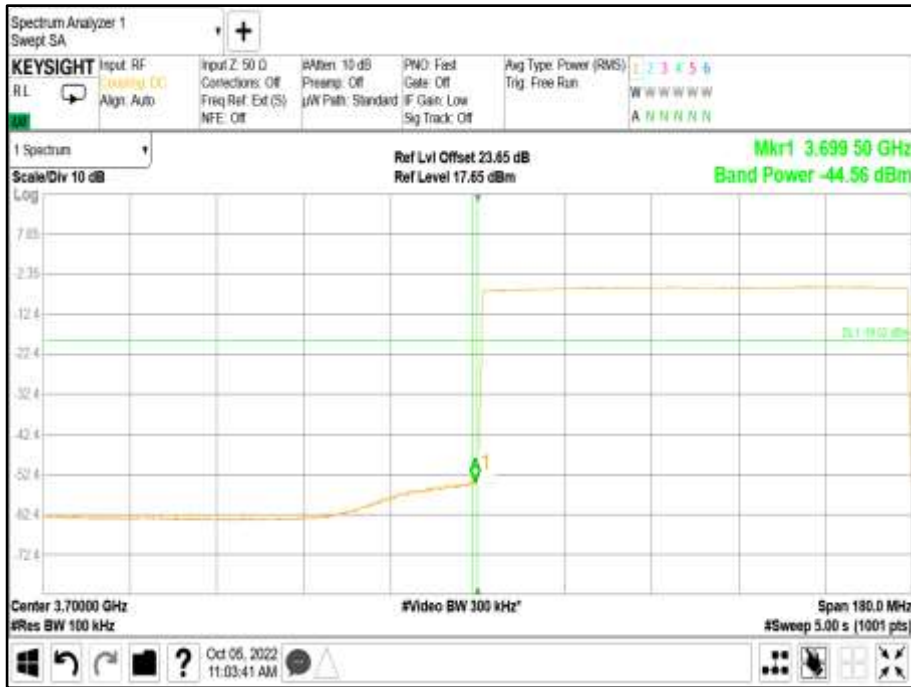

Antenna Port D - Modulation NR: QPSK - Carrier Bandwidth NR: 90.0 MHz - Channel Position T





Antenna Port D - Modulation NR: QPSK - Carrier Bandwidth NR: 100.0 MHz - Channel Position B

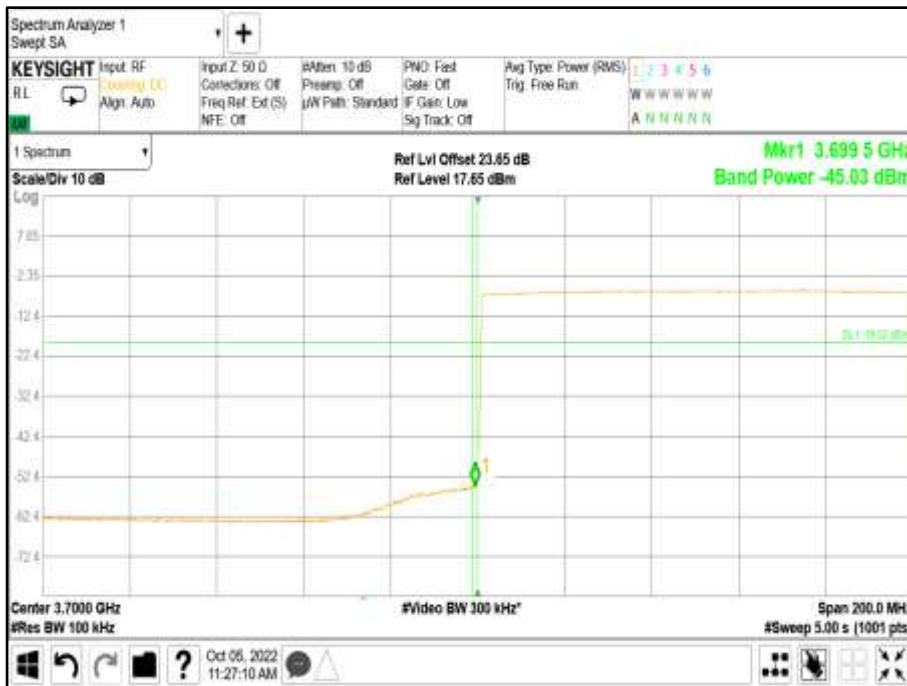

Antenna Port D - Modulation NR: QPSK - Carrier Bandwidth NR: 100.0 MHz - Channel Position T





Configuration B

Maximum Output Power 26.00 dBm / Port

Antenna	Modulation	Carrier Bandwidth	Band Edge (MHz)	
			Channel Position B	Channel Position T
A	NR10: QPSK	NR10.0+NR10.0 MHz	3705.0+3715.0	3965.0+3975.0
A	NR100: QPSK	NR100.0+NR100.0 MHz	3750.0+3850.0	3830.0+3930.0
A	NR10: QPSK (NC)	NR10.0+NR10.0 MHz	3705.0+3895.0	3785.0+3975.0
A	NR90: QPSK (NC)	NR90.0+NR90.0 MHz	3745.0+3855.0	3825.0+3935.0

Remarks

The plot results represent typical radio performance.



Antenna Port A - Modulation NR10: QPSK - Carrier Bandwidth NR10.0+NR10.0 MHz - Channel Position B



Antenna Port A - Modulation NR10: QPSK - Carrier Bandwidth NR10.0+NR10.0 MHz - Channel Position T





Antenna Port A - Modulation NR100: QPSK - Carrier Bandwidth NR100.0+NR100.0 MHz - Channel Position B



Antenna Port A - Modulation NR100: QPSK - Carrier Bandwidth NR100.0+NR100.0 MHz - Channel Position T





Antenna Port A - Modulation NR10: QPSK (NC) - Carrier Bandwidth NR10.0+NR10.0 MHz - Channel Position B



Antenna Port A - Modulation NR10: QPSK (NC) - Carrier Bandwidth NR10.0+NR10.0 MHz - Channel Position T





Antenna Port A - Modulation NR90: QPSK (NC) - Carrier Bandwidth NR90.0+NR90.0 MHz - Channel Position B

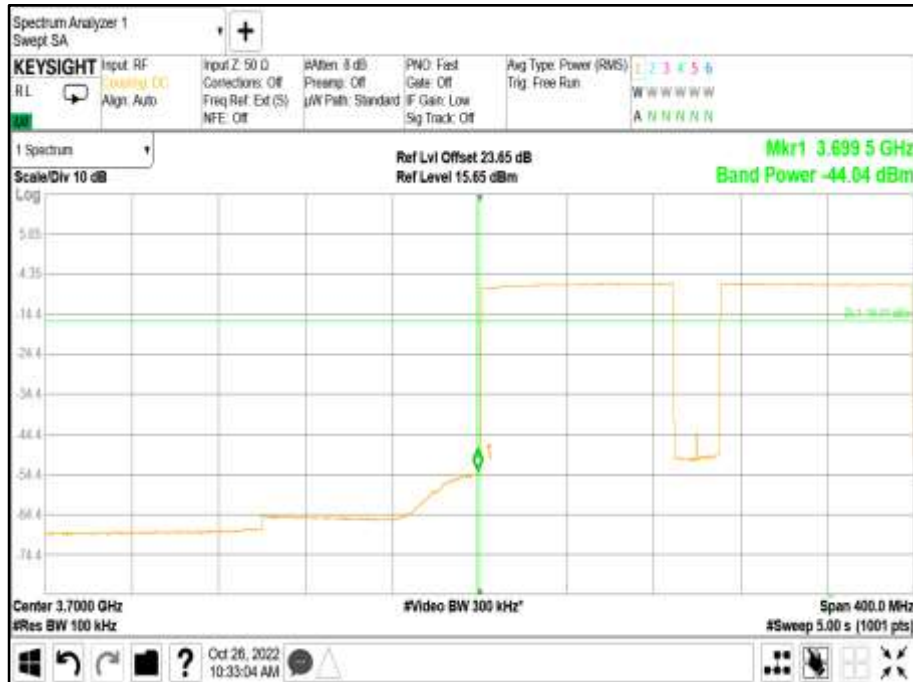

Antenna Port A - Modulation NR90: QPSK (NC) - Carrier Bandwidth NR90.0+NR90.0 MHz - Channel Position T





Configuration C

Maximum Output Power 26.00 dBm / Port

Antenna	Modulation	Carrier Bandwidth	Band Edge (MHz)	
			Channel Position B	Channel Position T
D	NR10: QPSK	10+10+10+10+10+10 MHz	3705+3715+3725+3735+3745+3755	3925+3935+3945+3955+3965+3975
D	NR20: QPSK	20+20+20+20+20+20 MHz	3710+3730+3750+3770+3790+3810	3870+3890+3910+3930+3950+3970
D	NR10: QPSK (NC)	10+10+10+10+10+10 MHz	3705+3715+3725+3775+3785+3795	3885+3895+3905+3955+3965+3975
D	NR20: QPSK (NC)	20+20+20+20+20+20 MHz	3710+3730+3750+3850+3870+3890	3790+3810+3830+3930+3950+3970

Antenna Port D - Modulation NR10: QPSK - Carrier Bandwidth 10+10+10+10+10+10 MHz - Channel Position B





Antenna Port D - Modulation NR10: QPSK - Carrier Bandwidth 10+10+10+10+10+10 MHz - Channel Position T





Antenna Port D - Modulation NR20: QPSK - Carrier Bandwidth 20+20+20+20+20+20 MHz - Channel Position B

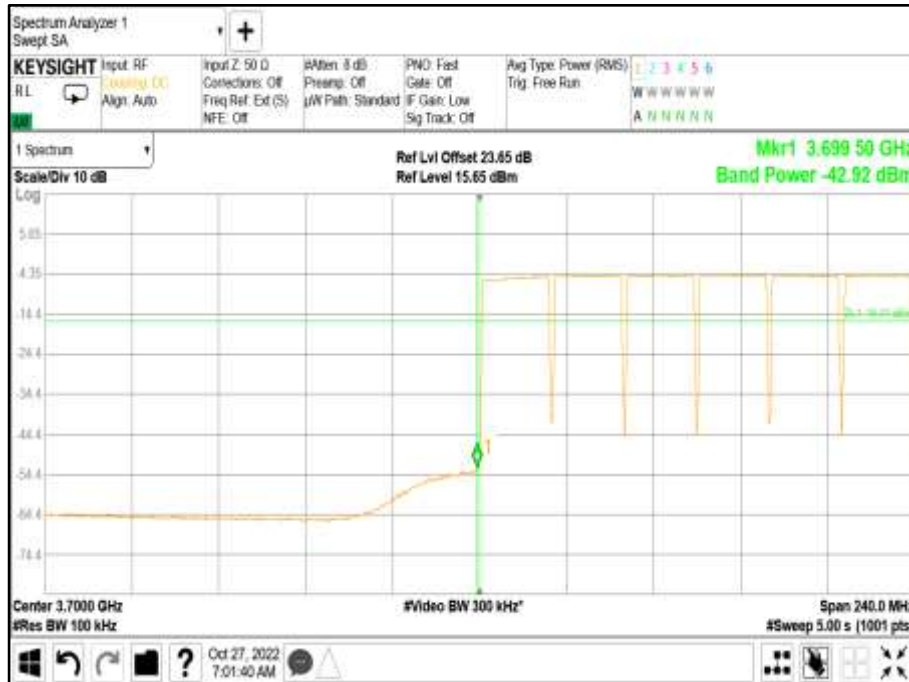

Antenna Port D - Modulation NR20: QPSK - Carrier Bandwidth 20+20+20+20+20+20 MHz - Channel Position T





Antenna Port D - Modulation NR10: QPSK (NC) - Carrier Bandwidth 10+10+10+10+10+10 MHz - Channel Position B

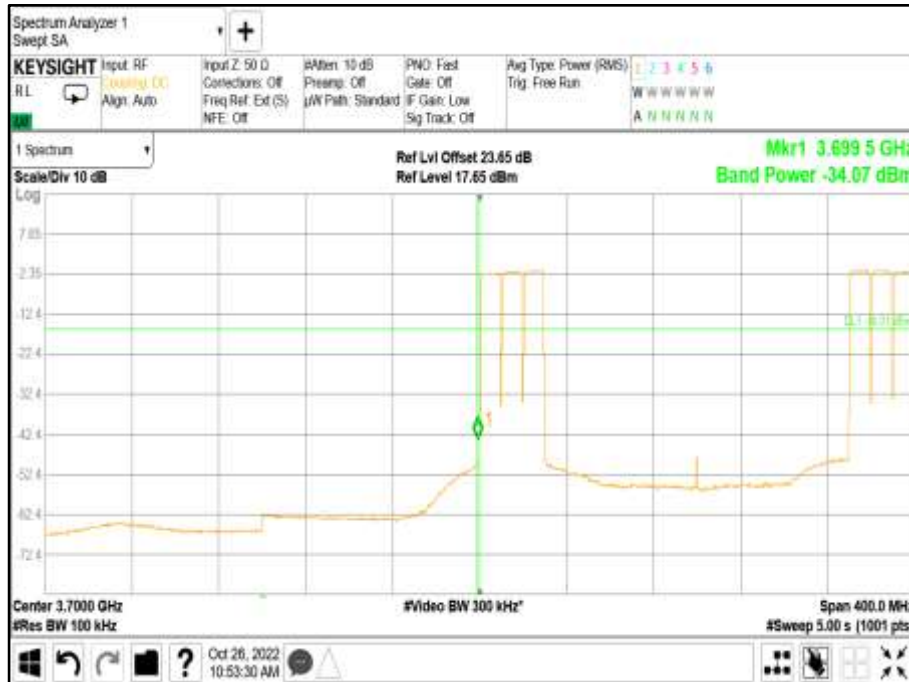

Antenna Port D - Modulation NR10: QPSK (NC) - Carrier Bandwidth 10+10+10+10+10+10 MHz - Channel Position T

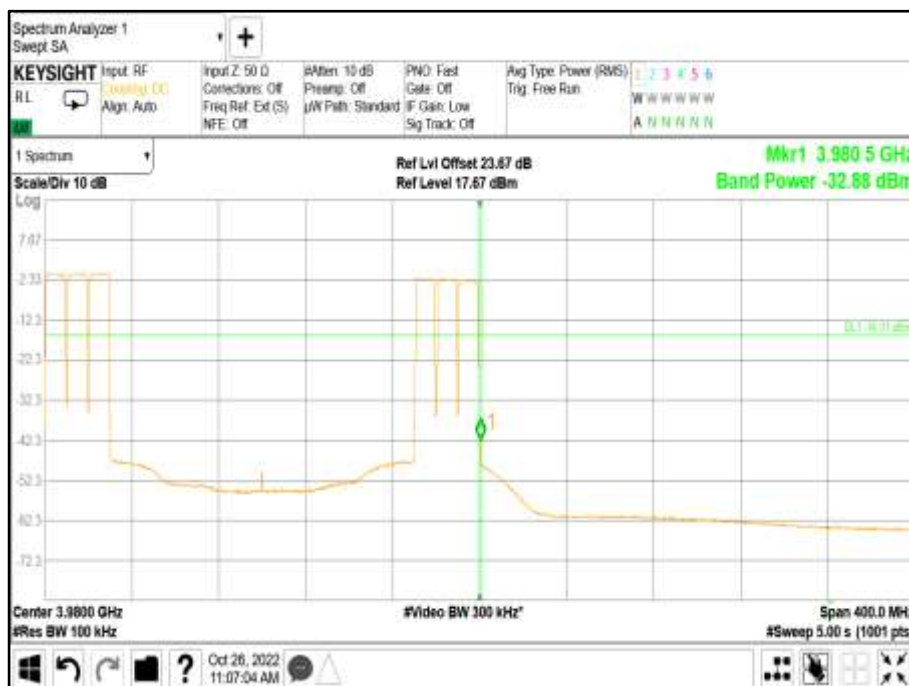



Antenna Port D - Modulation NR20: QPSK (NC) - Carrier Bandwidth 20+20+20+20+20+20 MHz - Channel Position B



Antenna Port A D - Modulation NR20: QPSK (NC) - Carrier Bandwidth 20+20+20+20+20+20 MHz - Channel Position T

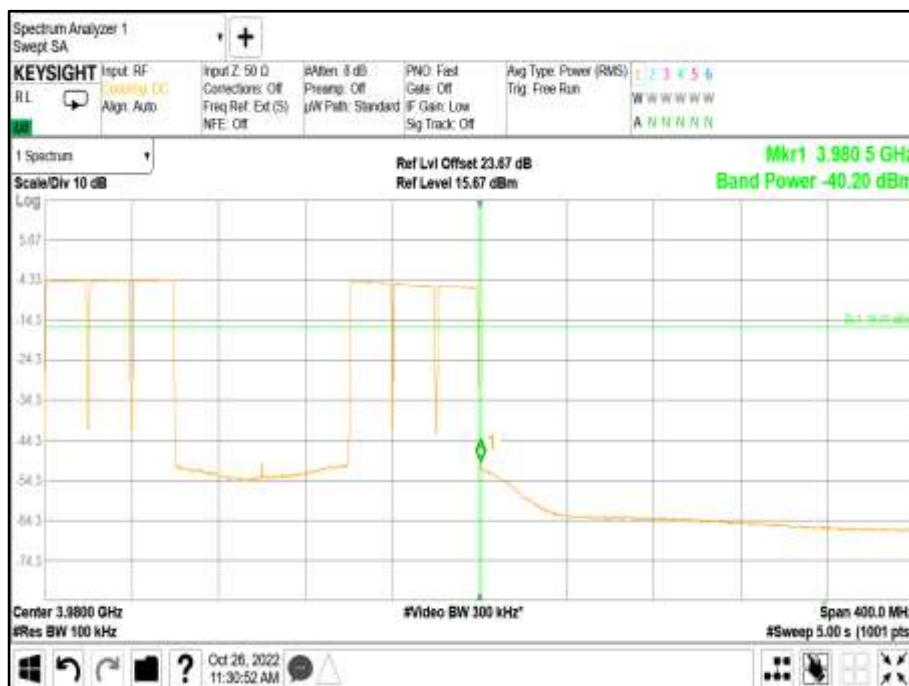

Limit	-19 dBm
-------	---------



2.4 TRANSMITTER SPURIOUS EMISSIONS

2.4.1 Specification Reference

FCC CFR 47 Part 27, Clause 27.53
FCC CFR 47 Part 2, Clause 2.1051

2.4.2 Date of Test and Modification State

05-October-2022 - Modification State 0

2.4.3 Test Equipment Used

The major items of test equipment used for the above tests are identified in Section 3.1.

2.4.4 Environmental Conditions

Ambient Temperature 23.9°C
Relative Humidity 32.0%

2.4.5 Test Method

All measurements were made in accordance with FCC KDB 971168 D01, Clause 6.1.

All 4 antenna ports have been declared as being equivalent, therefore measurements were made on one antenna port only (worst-case). To account for this, the limit was integrated by $10 * \text{Log}(N)$, where N is equal to the number of MIMO antenna ports as per below.

For multi-port, the limit was calculated as being $-13 \text{ dBm} - 10 * \text{Log}(4) = -19 \text{ dBm}$.

2.4.6 Test Results

Configuration A

Maximum Output Power 24.00 dBm / Port

Remarks

1. Transceiver spurious emissions have been searched for all channel bandwidths and antenna ports.
2. Representative spurious emissions performance using the worst-case channel bandwidth has been presented for all modulations.
3. Plot data performance for all channel bandwidths, and channel positions for both contiguous and non-contiguous (NC) operation are on file and available on request.



Antenna D - Modulation NR: QPSK - Carrier Bandwidth 20.0 MHz - Channel Position M - Band 1 - Range 0.009 to 4000 MHz

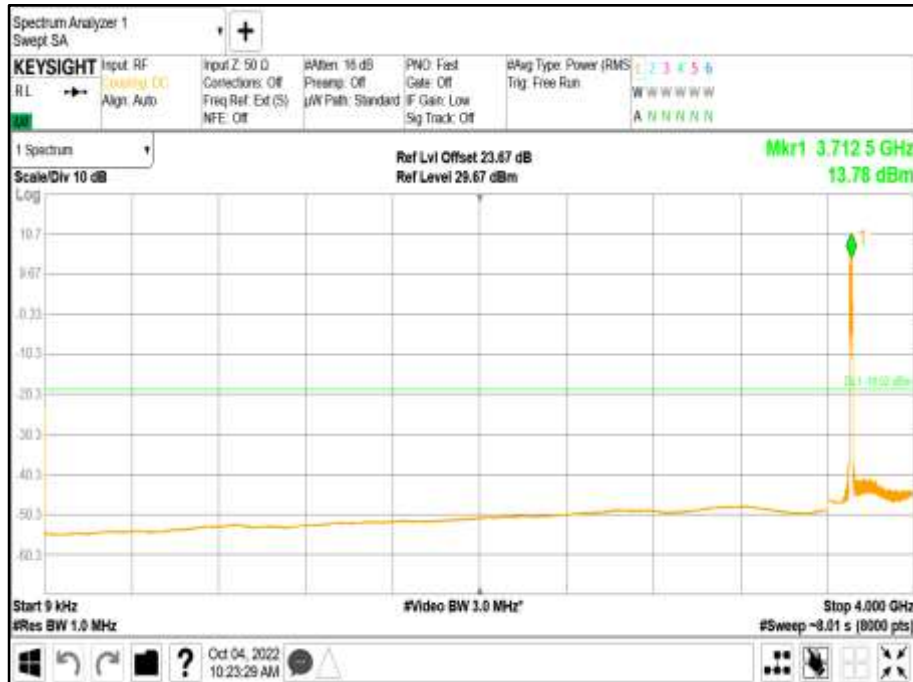

Antenna D - Modulation NR: QPSK - Carrier Bandwidth 20.0 MHz - Channel Position M - Band 2 - Range 4000 to 12000 MHz

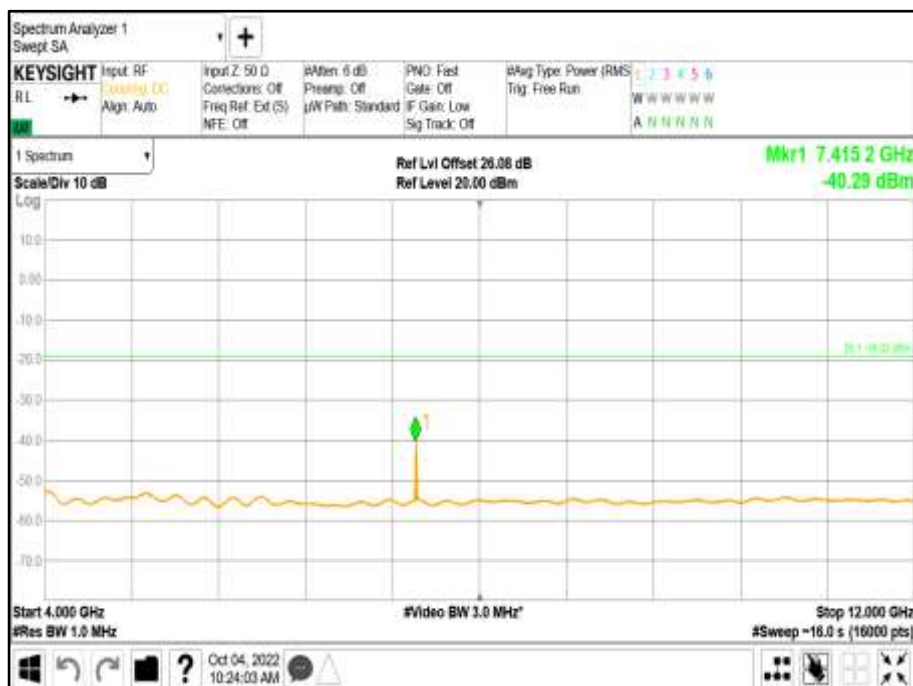



Antenna D - Modulation NR: QPSK - Carrier Bandwidth 20.0 MHz - Channel Position M - Band 3 - Range 12000 to 18000 MHz



Antenna D - Modulation NR: QPSK - Carrier Bandwidth 20.0 MHz - Channel Position M - Band 4 - Range 18000 to 39800 MHz

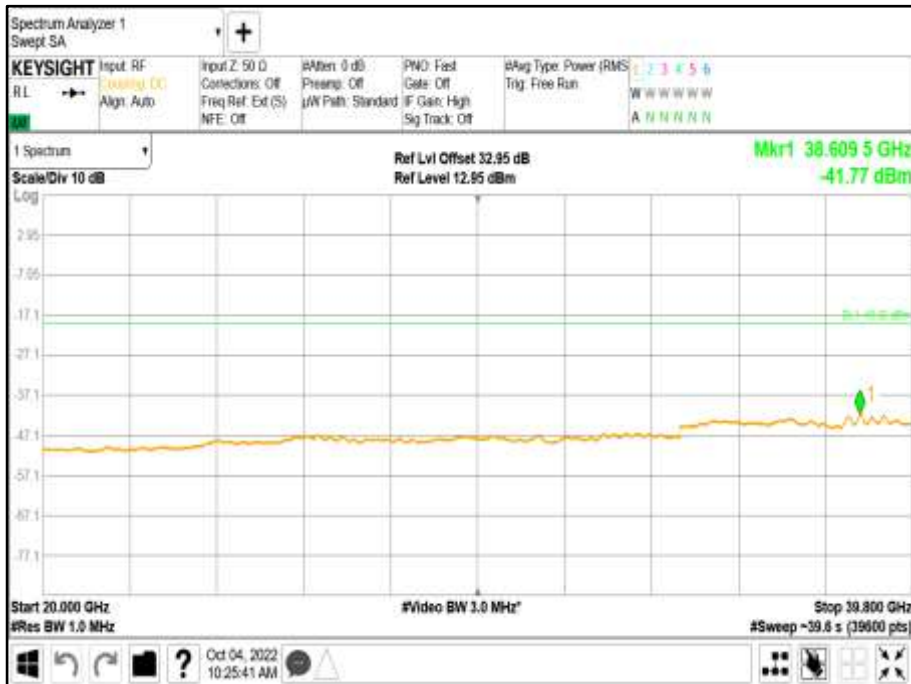



Configuration B

Maximum Output Power 26.00 dBm / Port

Remarks

1. Transceiver spurious emissions have been searched for all channel bandwidths and antenna ports.
2. Representative spurious emissions performance using the worst-case channel bandwidth has been presented for all modulations.
3. Plot data performance for all channel bandwidths, and channel positions for both contiguous and non-contiguous (NC) operation are on file and available on request.



Antenna A - Modulation NR10: QPSK - Carrier Bandwidth NR10.0+NR10.0 MHz - Channel Position B - Band 1 - Range 0.009 to 4000 MHz

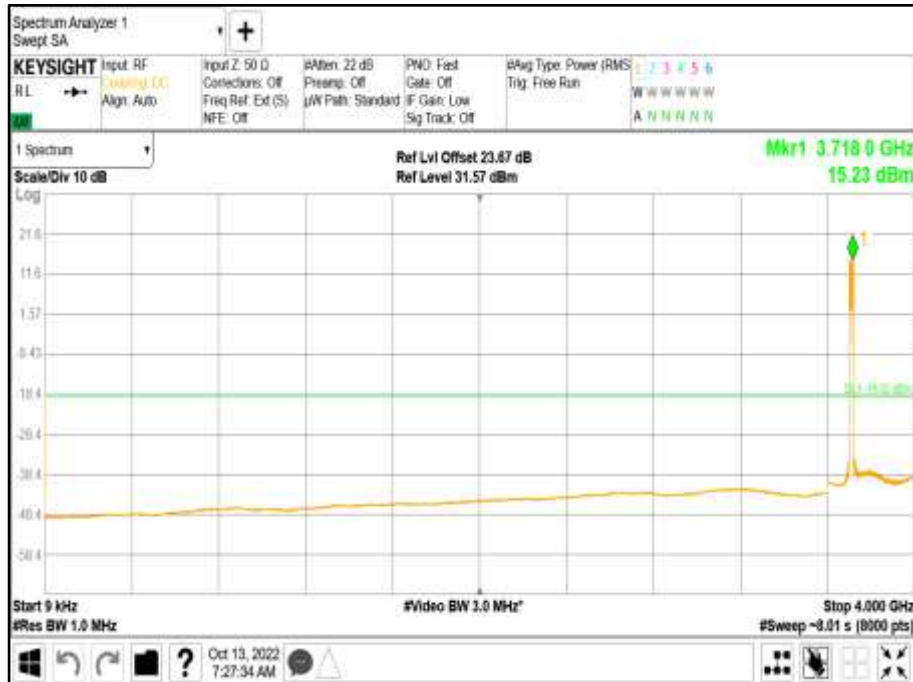

Antenna A - Modulation NR10: QPSK - Carrier Bandwidth NR10.0+NR10.0 MHz - Channel Position B - Band 2 - Range 4000 to 12000 MHz

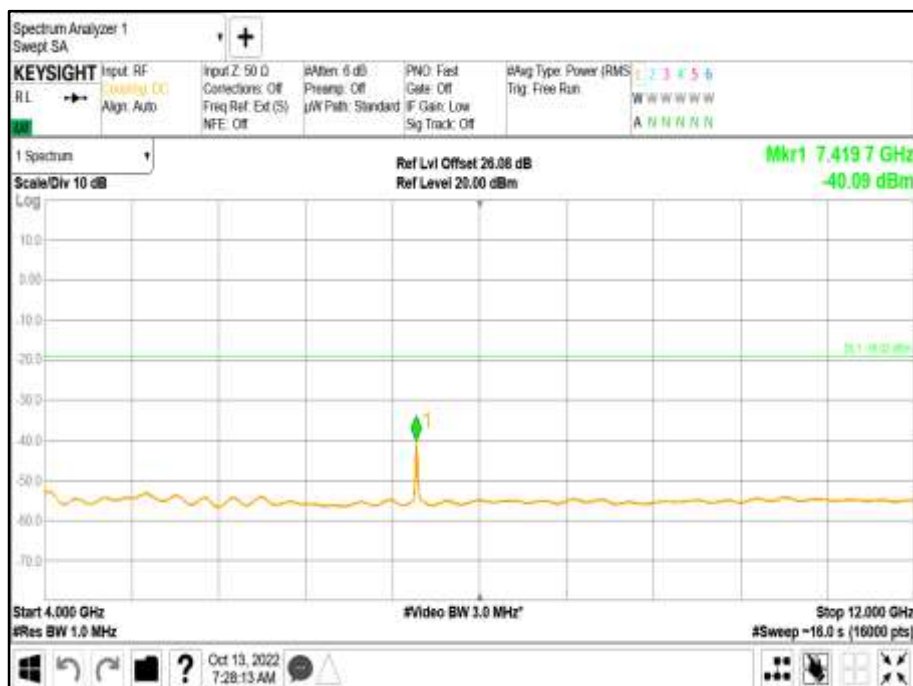



Antenna A - Modulation NR10: QPSK - Carrier Bandwidth NR10.0+NR10.0 MHz - Channel Position B - Band 3 - Range 12000 to 22000 MHz



Antenna A - Modulation NR10: QPSK - Carrier Bandwidth NR10.0+NR10.0 MHz - Channel Position B - Band 4 - Range 22000 to 39800 MHz

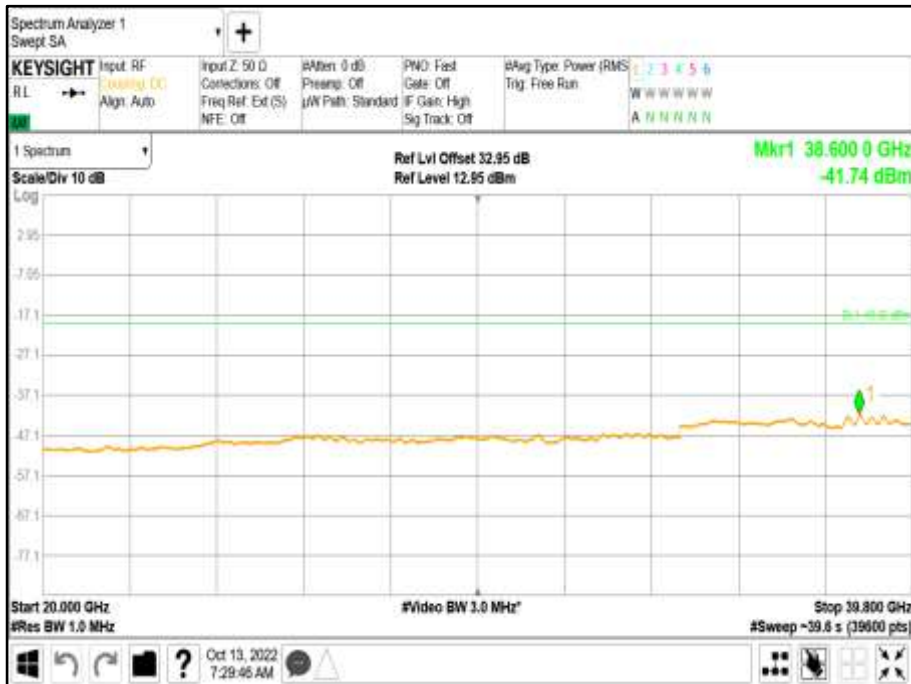



Antenna A - Modulation NR10: QPSK (NC) - Carrier Bandwidth NR10.0+NR10.0 MHz - Channel Position B - Band 1 - Range 0.009 to 4000 MHz

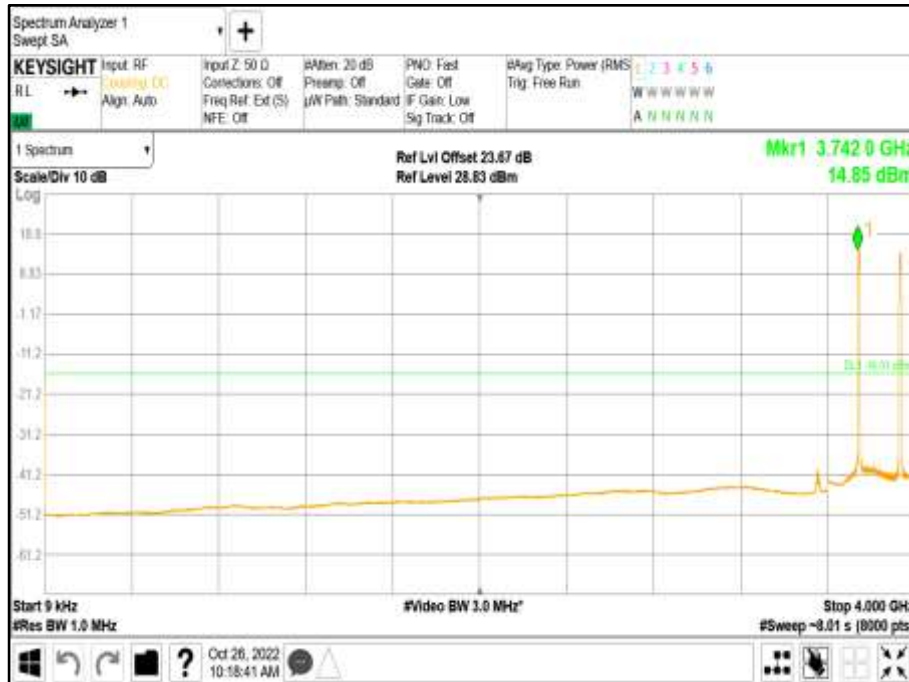

Antenna A - Modulation NR10: QPSK (NC) - Carrier Bandwidth NR10.0+NR10.0 MHz - Channel Position B - Band 2 - Range 4000 to 12000 MHz

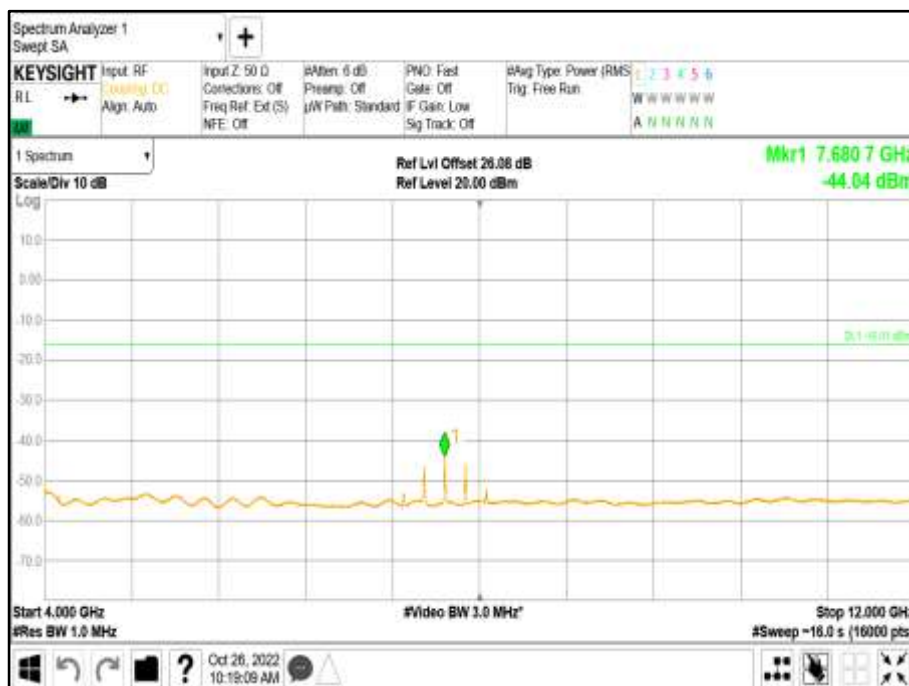



Antenna A - Modulation NR10: QPSK (NC) - Carrier Bandwidth NR10.0+NR10.0 MHz - Channel Position B - Band 3 - Range 12000 to 22000 MHz



Antenna A - Modulation NR10: QPSK (NC) - Carrier Bandwidth NR10.0+NR10.0 MHz - Channel Position B - Band 4 - Range 22000 to 39800 MHz

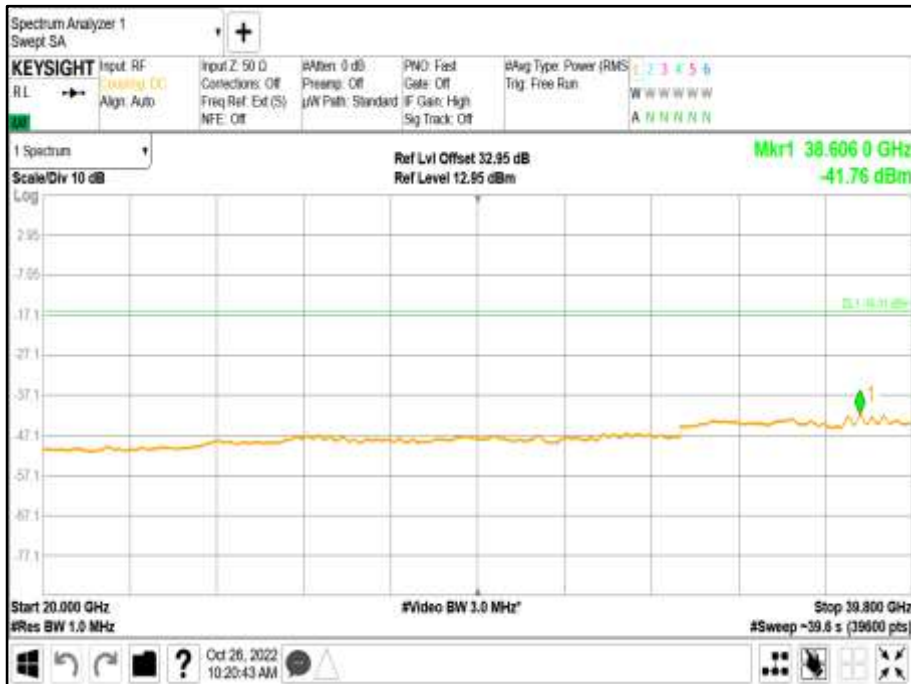



Antenna A - Modulation NR10: QPSK (NC) - Carrier Bandwidth NR10.0+NR10.0 MHz - Channel Position B - Band 3 - Range 12000 to 22000 MHz



Antenna A - Modulation NR10: QPSK (NC) - Carrier Bandwidth NR10.0+NR10.0 MHz - Channel Position B - Band 4 - Range 22000 to 39800 MHz

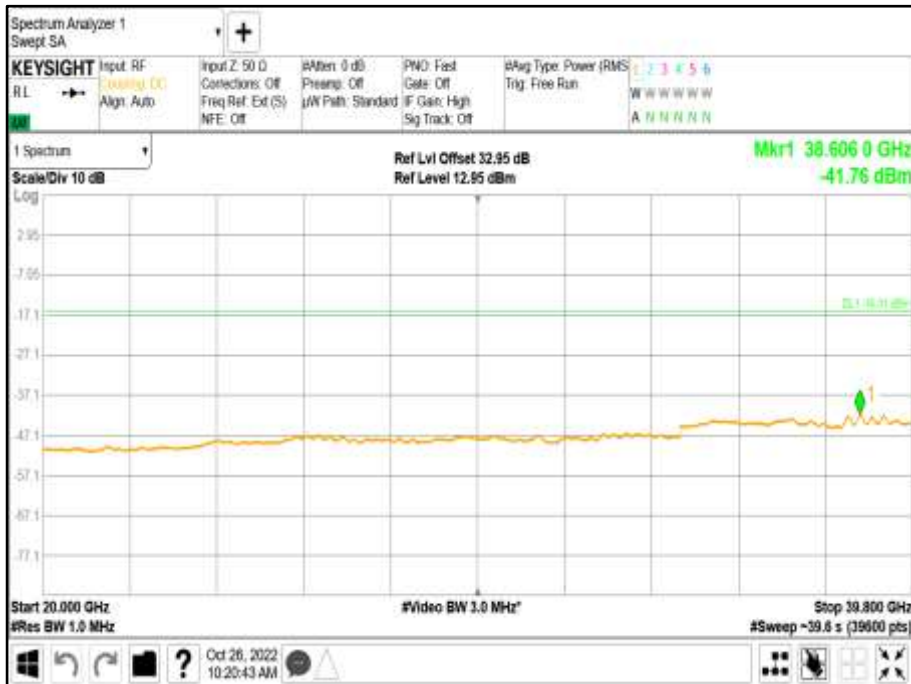



Configuration C

Maximum Output Power 26.00 dBm / Port

Remarks

1. Transceiver spurious emissions have been searched for all channel bandwidths and antenna ports.
2. Representative spurious emissions performance using the worst-case channel bandwidth has been presented for all modulations.
3. Plot data performance for all channel bandwidths, and channel positions for both contiguous and non-contiguous (NC) operation are on file and available on request.



Antenna D - Modulation NR10: QPSK - Carrier Bandwidth 10+10+10+10+10+10 MHz - Channel Position B - Band 1 - Range 0.009 to 4000 MHz



Antenna D - Modulation NR10: QPSK - Carrier Bandwidth 10+10+10+10+10+10 MHz - Channel Position B - Band 2 - Range 4000 to 12000 MHz

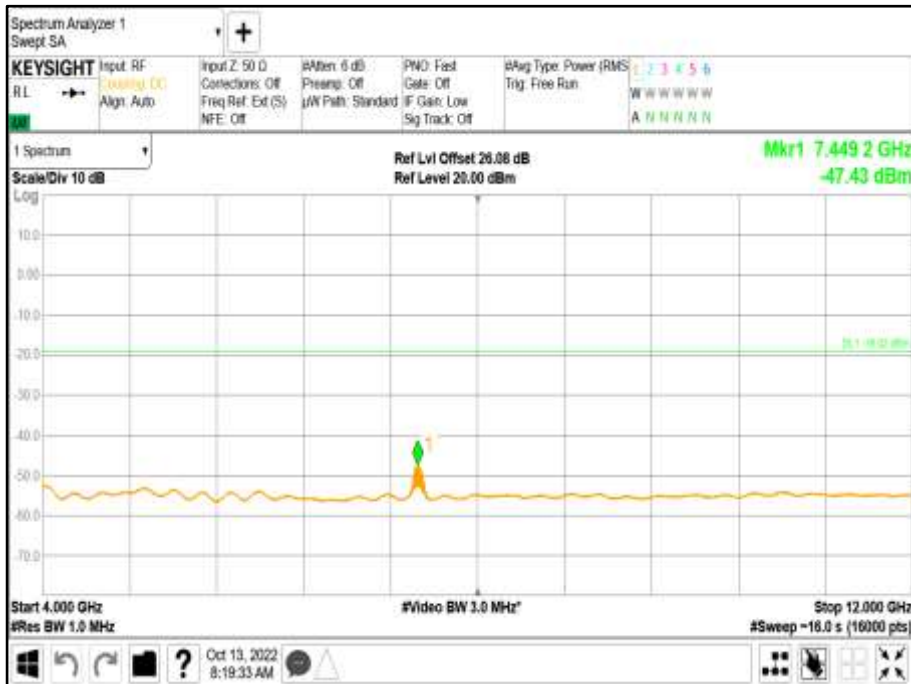



Antenna D - Modulation NR10: QPSK - Carrier Bandwidth 10+10+10+10+10+10 MHz - Channel Position B - Band 3 - Range 12000 to 20000 MHz



Antenna D - Modulation NR10: QPSK - Carrier Bandwidth 10+10+10+10+10+10 MHz - Channel Position B - Band 4 - Range 20000 to 38900 MHz





Antenna D - Modulation NR10: QPSK (NC) - Carrier Bandwidth 10+10+10+10+10+10 MHz - Channel Position B - Band 1 - Range 0.009 to 4000 MHz



Antenna D - Modulation NR10: QPSK (NC) - Carrier Bandwidth 10+10+10+10+10+10 MHz - Channel Position B - Band 2 - Range 4000 to 12000 MHz

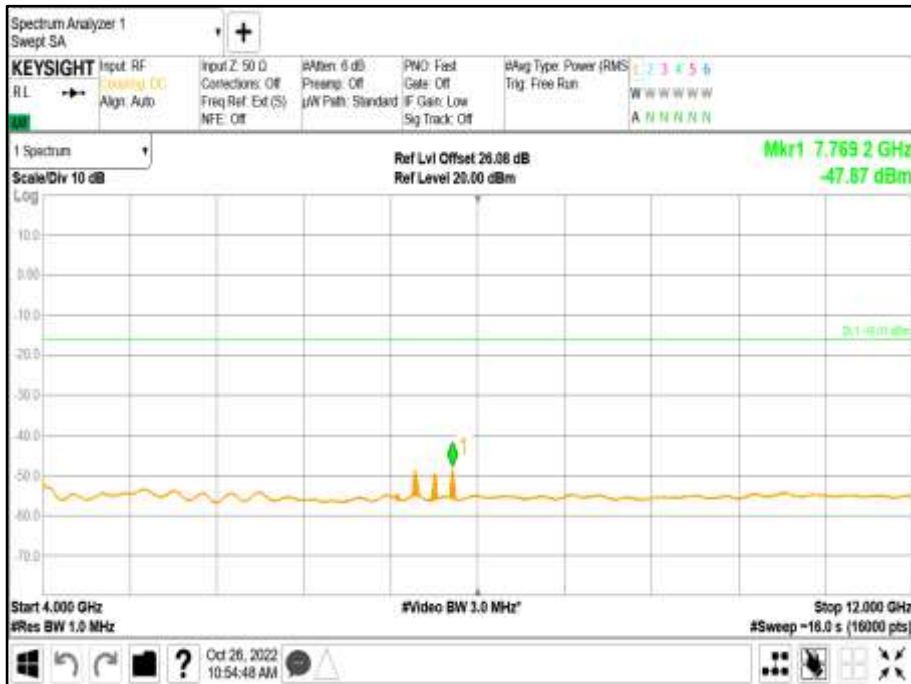



Antenna D - Modulation NR10: QPSK (NC) - Carrier Bandwidth 10+10+10+10+10+10 MHz - Channel Position B - Band 3 - Range 12000 to 20000 MHz



Antenna D - Modulation NR10: QPSK (NC) - Carrier Bandwidth 10+10+10+10+10+10 MHz - Channel Position B - Band 4 - Range 20000 to 38900 MHz



Limit FCC Part 27.53 (a – j)

Limit	The power of any emission outside of the authorized operating frequency ranges must be attenuated below the transmitting power (P) by a factor of at least $43 + 10 \log(P)$ db.
-------	--



2.5 FREQUENCY STABILITY

2.5.1 Specification Reference

FCC CFR 47 Part 2, Clause 2.1051

2.5.2 Date of Test and Modification State

6-October-2022 - Modification State 0

2.5.3 Test Equipment Used

The major items of test equipment used for the above tests are identified in Section 3.1.

2.5.4 Environmental Conditions

Ambient Temperature 24.6°C
Relative Humidity 30.8%

2.5.5 Test Method

All measurements were made in accordance with FCC KDB 971168 D01, Clause 9 and ANSI C63.26 Clause 5.6

2.5.6 Test Results

Configuration A

Temperature	Voltage	Frequency Error (Hz)
		Channel Position B (3 840 000 000 Hz)
-30°C	-48.0 V DC	Turns OFF
-20°C	-48.0 V DC	Turns OFF
-10°C	-48.0 V DC	2.700
0°C	-48.0 V DC	-1.7500
+10°C	-48.0 V DC	-4.8500
+20°C	-40.5 V DC	-1.6700
+20°C	-48.0 V DC	-1.8800
+20°C	-57.5 V DC	-1.1100
+30°C	-48.0 V DC	-3.1500
+40°C	-48.0 V DC	-1.2300
+50°C	-48.0 V DC	-2.7500

Remarks

Worst Case deviation at 4.8500 Hz = 0.001263 ppm



Limit	The frequency stability shall be sufficient to ensure that the fundamental emissions stay within the authorized bands of operation.
-------	---



SECTION 3

TEST EQUIPMENT USED



3.1 TEST EQUIPMENT USED

Instrument	Manufacturer	Type No.	TE No.	Calibration Period (months)	Calibration Due
Spectrum Analyzer	Keysight	PXA N9030B	MY57144347	12	25-Mar-2023
Thermometer / Refrigeration	VWR	89094-746	210697579	24	13-Aug-2023
PSU	Xantrex	XKW60-50	E00109862	N/A	O/P Mon
Attenuator (20dB)	Mini-Circuits	BW-K10-2W44+	-	N/A	O/P Mon
Climate Chamber	Burnsco	RTC-37P-3-3	-07-07	N/A	O/P Mon

N/A – Not Applicable

O/P Mon – Output Monitored with Calibrated Equipment



3.2 MEASUREMENT UNCERTAINTY

For a 95% confidence level, the measurement uncertainties for defined systems are:-

Test Discipline	Frequency / Parameter	MU	
Conducted Maximum Peak Output Power	30 MHz to 20 GHz Amplitude	± 0.7 dB	
Conducted Emissions	30 MHz to 20 GHz Amplitude	± 2.1 dB	
Frequency Stability	30 MHz to 2 GHz	± 5.0 Hz	
Occupied Bandwidth	Up to 20 MHz Bandwidth	5 MHz Bandwidth	± 11547 Hz
		10 MHz Bandwidth	± 23094 Hz
		15 MHz Bandwidth	± 34641 Hz
		20 MHz Bandwidth	± 46188 Hz
Band Edge	30 MHz to 20 GHz Amplitude	±0.8 dB	
Radiated Spurious Emissions	30 MHz to 1 GHz	± 5.2 dB	
	1 GHz to 40GHz	± 6.3 dB	

Measurement Uncertainty Decision Rule

Determination of conformity with the specification limits is based on the results of the compliance measurement and does not take into account measurement instrumentation uncertainty as defined in ANSI C63.26:2015 Clause 1.3.

Risk: The uncertainty of measurement about the measured result is negligible with regard to the final pass/fail decision. The measurement result can be directly compared with the test limit to determine conformance with the requirement (compare IEC Guide 115). The level of risk to falsely accept and falsely reject items is further described in ILAC-G8



SECTION 4

ACCREDITATION, DISCLAIMERS AND COPYRIGHT



4.1 ACCREDITATION, DISCLAIMERS AND COPYRIGHT



This report relates only to the actual item/items tested.

Our A2LA Accreditation does not cover opinions and interpretations and any expressed are outside the scope of our A2LA Accreditation.

© 2023 TÜV SÜD
TÜV SÜD
TUV SUD Canada, 1280 Teron Rd., Kanata On.

ANNEX A

MODULE LIST

Configuration A/B/C			
Product	Product No	R-State	Serial No
Dot 4465 B77DB25B66 (EUT)	KRY 901 523/2	R1A modified as R1B	TD3W340089
CT11	LPC 102 494/1	R2A	T01G495060
IRU 1648 (for Contig)	KRC 161 842/1	R1D	TD3F105259
IRU 1649 (for Non-contig)	KRC 161 842/2	R1E	TD3F109016
Software Version:	CXP 203 0045/26	Revision:	R14BX12