



Add value.
Inspire trust.

Report On

FCC Testing of the
Ericsson Remote Radio Unit Dot 4455/4465 B77DB25B66 KRY 901
523/1, KRY 901 523/2, NR + LTE (1900 MHz) Base Station in
accordance with FCC CFR 47 Part 2, FCC CFR 47 Part 24

COMMERCIAL-IN-CONFIDENCE

FCC: TA8AKRY901523-1 & TA8AKRY901523-2

PREPARED BY

Handwritten signature of Glen Westwell in black ink.

Glen Westwell
Senior Test Engineer

APPROVED BY

Handwritten signature of Scott Drysdale in black ink.

Scott Drysdale
Authorised Signatory

DATED

17-November-2022

Document 75956591 Report 02, Issue 1

17-November-2022



CONTENTS

Section	Page No
1	REPORT INFORMATION 2
1.1	Report Details 3
1.2	Brief Summary of Results 4
1.3	Test Rationale..... 5
1.4	Configuration Description 6
1.5	Declaration of Build Status 8
1.6	Product Information 10
1.7	Test Setup 11
1.8	Deviation From The Standard 13
1.9	Modification Record 13
1.10	Additional Information 13
2	TEST DETAILS 15
2.1	Maximum Peak Output Power and Peak to Average Ratio - Conducted..... 16
2.2	Occupied Bandwidth..... 47
2.3	Band Edge 54
2.4	Transmitter Spurious Emissions 81
2.5	Frequency Stability 96
3	TEST EQUIPMENT USED 97
3.1	Test Equipment Used 98
3.2	Measurement Uncertainty 99
4	ACCREDITATION, DISCLAIMERS AND COPYRIGHT 100
4.1	Accreditation, Disclaimers and Copyright..... 101
ANNEX A	Module Lists.....A.2



SECTION 1

REPORT INFORMATION



1.1 REPORT DETAILS

Manufacturer	Ericsson
Address	Torshamnsgatan 23 Kista SE-16480 Stockholm Sweden
Product Name & Product Number	Dot 4465 B77DB25B66 - KRY 901 523/2
Serial Number(s)	TD3W340089
Software Version	R1A modified as a R1B
Hardware Version	Dot 4465 B77DB25B66 - KRY 901 523/2
Non-Tested Variant (See Section 1.10 Additional Information)	Dot 4455 B77DB25B66 - KRY 901 523/1
Test Specification/Issue/Date	FCC CFR 47 Part 2: 2021 FCC CFR 47 Part 24: 2021
Test Plan	TP_RA-FCC_Dot_4465_B77DB25B66
Start of Test	7-October-2022
Finish of Test	13-October-2022
Name of Engineer(s)	Glen Westwell
Related Document(s)	KDB 971168 D01 v02r02 KDB 662911 D01 v02r01 ANSI C63.26-2015

ENGINEERING STATEMENT

The measurements shown in this report were made in accordance with the procedures described on test pages. All reported testing was carried out on a sample equipment to demonstrate compliance with and FCC CFR 47 Part 2: 2021, FCC CFR 47 Part 24: 2021. The sample tested was found to comply with the requirements defined in the applied rules.

Test Engineer(s);

Glen Westwell



1.2 BRIEF SUMMARY OF RESULTS

A brief summary of results for each configuration, in accordance with FCC CFR 47 Part 2, FCC CFR 47 Part 24 is shown below.

Section	Specification Clause		Test Description	Result
	FCC CFR 47 Part 2	FCC CFR 47 Part 24		
2.1	2.1046	24.232	Maximum Peak Output Power and Peak to Average Ratio - Conducted	Pass
2.2	2.1049	24.238 (b)	Occupied Bandwidth	Pass
2.3	2.1051	24.238 (b)	Band Edge	Pass
2.4	2.1051	24.238 (a)	Transmitter Spurious Emissions	Pass
2.5	2.1055	24.235	Frequency Stability	Pass



1.3 TEST RATIONALE

The tests that have been selected are detailed in the customer Test Plan as defined in section 1.1 of this report. The Test Plan is based on the TÜV SÜD FCC Test Plan Rationale, available on request.



1.4 CONFIGURATION DESCRIPTION

Configuration A					
RAT	No. of Carriers	Carrier Bandwidth	Carrier Frequency Configuration (MHz)		
			Bottom	Middle	Top
LTE	1	5 MHz	1932.5	1962.5	1992.5
		10 MHz	1935.0	1962.5	1990.0
		15 MHz	1937.5	1962.5	1987.5
		20 MHz	1940.0	1962.5	1985.0
NR	1	5 MHz	1932.5	1962.5	1992.5
		10 MHz	1935.0	1962.5	1990.0
		15 MHz	1937.5	1962.5	1987.5
		20 MHz	1940.0	1962.5	1985.0
		25 MHz	1942.5	1962.5	1982.5
		30 MHz	1945.0	1962.5	1980.0
		40 MHz	1950.0	1962.5	1975.0

Configuration B Contiguous Channel Allocations					
RAT	No. of Carriers	Carrier Bandwidth	Carrier Frequency Configuration (MHz)		
			Bottom	Middle	Top
LTE	2	5+5 MHz	1932.5+1937.5	1960+1965	1987.5+1992.5
		20+20 MHz	1940+1960	1952.5+1972.5	1965+1985
NR	2	5+5 MHz	1932.5+1937.5	1960+1965	1987.5+1992.5
		30+30 MHz	1945+1975	1947.5+1977.5	1950+1980
NR+LTE	2	5+5 MHz	1932.5+1937.5	1960+1965	1987.5+1992.5

Configuration B Non-Contiguous Channel Allocations					
RAT	No. of Carriers	Carrier Bandwidth	Carrier Frequency Configuration (MHz)		
			Bottom	Middle	Top
NR+LTE	2	5+5 MHz	1932.5	--	1992.5



Configuration C Contiguous Channel Allocations					
RAT	No. of Carriers	Carrier BW	Carrier Frequency Configuration (MHz)		
			Bottom	Middle	Top
NR	6	5 MHz	1932.5+1937.5+1942.5+	1950+1955+1960+	1967.5+1972.5+1977.5+
			1947.5+1952.5_1957.5	1965+1970+1975	1982.5+1987.5+1992.5
		10 MHz	1935+1945+1955+	1932.5+1942.5+1952.5	1940+1950+1960
			1965+1975+1985	1962.5+1972.5+1982.5	1970+1980+1990
LTE	6	5 MHz	1932.5+1937.5+1942.5+	1950+1955+1960+	1967.5+1972.5+1977.5+
			1947.5+1952.5_1957.5	1965+1970+1975	1982.5+1987.5+1992.5
		10 MHz	1935+1945+1955+	1932.5+1942.5+1952.5	1940+1950+1960
			1965+1975+1985	1962.5+1972.5+1982.5	1970+1980+1990
NR+LTE	6	5 MHz	1932.5+1937.5+1942.5+	1950+1955+1960+	1967.5+1972.5+1977.5+
			1947.5+1952.5_1957.5	1965+1970+1975	1982.5+1987.5+1992.5

Configuration C Non-Contiguous Channel Allocations					
RAT	No. of Carriers	Carrier BW	Carrier Frequency Configuration (MHz)		
			Bottom	Middle	Top
NR+LTE	6	5 MHz	1932.5+1937.5+1942.5+	--	1982.5+1987.5+1992.5



1.5 DECLARATION OF BUILD STATUS

MAIN EUT	
MANUFACTURING DESCRIPTION	Radio Dot
MANUFACTURER	Ericsson
TYPE	Remote Radio Base Station
PART NUMBER	KRY 901 523/1 and KRY 901 523/2
SERIAL NUMBER	TD3W340089
HARDWARE VERSION	R1A modified as R1B
SOFTWARE VERSION	CXP 203 0045/26 - R14BX12
TRANSMITTER OPERATING RANGE	B77D: 3700-3980 MHz B25: 1930-1995MHz B66: 2110-2200MHz
RECEIVER OPERATING RANGE	B77D: 3700-3980 MHz B25: 1850-1915MHz B66: 1710-1780MHz
COUNTRY OF ORIGIN	China
INTERMEDIATE FREQUENCIES	None
EMISSION DESIGNATOR(S): (i.e. G1D, GXW)	B77D NR: 10M0F9W, 15M0F9W, 20M0F9W, 30M0F9W, 40M0F9W, 50M0F9W, 60M0F9W, 70M0F9W 80M0F9W, 90M0F9W, 100MF9W B25 NR: 10M0F9W, 15M0F9W, 20M0F9W +NBloT B25 NR: 5M00F9W, 25M0F9W, 30M0F9W, 40M0F9W B25 LTE: 5M00W7D, 10M0W7D, 15M0W7D, 20M0W7D +NBloT B66 NR: 10M0F9W, 15M0F9W, 20M0F9W +NBloT B66 NR: 5M00F9W, 25M0F9W, 30M0F9W, 40M0F9W B66 LTE: 5M00W7D, 10M0W7D, 15M0W7D, 20M0W7D +NBloT
MODULATION TYPES: (i.e. GMSK, QPSK)	NR: QPSK, 16QAM, 64QAM, 256QAM LTE: QPSK, 16QAM, 64QAM, 256QAM
HIGHEST INTERNALLY GENERATED FREQUENCY	3.98 GHz
OUTPUT POWER (W or dBm)	B77D: 4 x 0.4W (26dBm) (1 carrier limited to 24dBm) B25: 2 x 0.2W (23dBm) B66: 2 x 0.2W (23dBm)
Antenna gain (dBi)	B77D: 4.3 dBi B25: 4.2 dBi B66: 4.3 dBi
FCC ID	TA8AKRY901523-1 & TA8AKRY901523-2
INDUSTRY CANADA ID	NA



TECHNICAL DESCRIPTION (a brief description of the intended use and operation)	The Dot 4455 B77DB25B66 (KRY 901 523/1) and the Dot 4465 B77DB25B66 (KRY 901 523/2) are Remote Radio Units forming part of the Ericsson Radio Base Station (RBS) equipment. The Dot provides radio access for mobile and fixed devices and is intended for the indoor environment. The radio operates over 8 Transmit ports in MRO (NR+LTE); Single, Multi-Carrier, and MIMO transmission with a maximum rated RF Output up to 0.4W per port over an operational temperature of 5°C to +40°C. The unit is designed to be ceiling or wall mounted. The 4455 and 4465 radios are identical except that Dot 4455 has internal antennas and Dot 4465 has external RF ports.
--	---

Signature

Denis Lalonde

Date: 3 November 2022

Declaration of Build Status Serial Number: TD3W340089



1.6 PRODUCT INFORMATION

1.6.1 Technical Description

The Equipment Under Test (EUT) Dot 4465 B77DB25B66 - KRY 901 523/2 is an Ericsson AB Radio Unit working in the public mobile service Band 25 which provides communication connections to Band 77D, Band 25, and Band 66 5G networks.

The EUT is declared as operating from a nominal -48V DC supply.

The Equipment Under Test (EUT) is shown in the photograph below. A full technical description can be found in the Manufacturer's documentation..

Equipment Under Test



1.7 TEST SETUP

Conducted Test Set Up

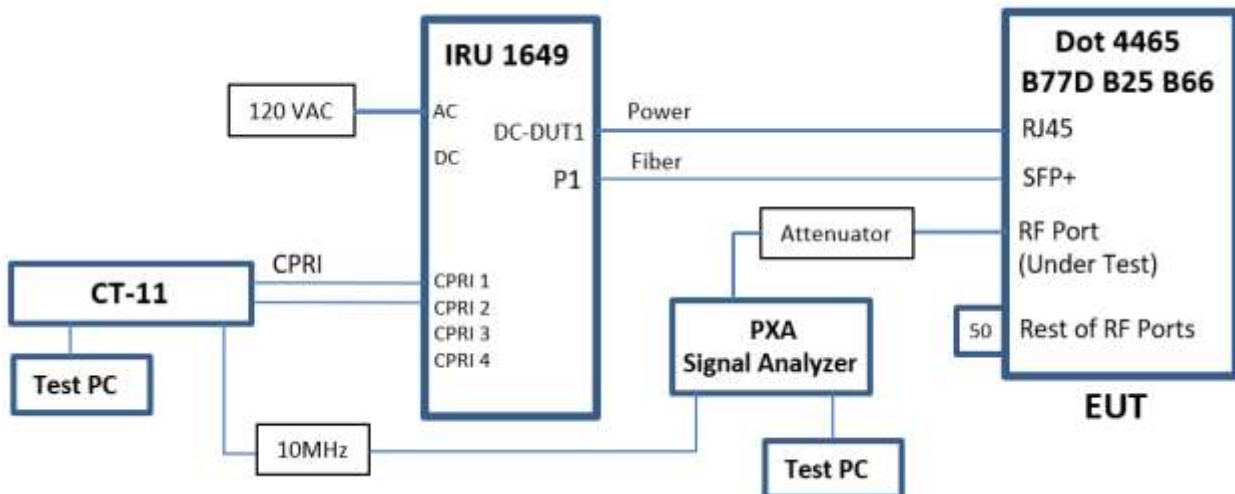
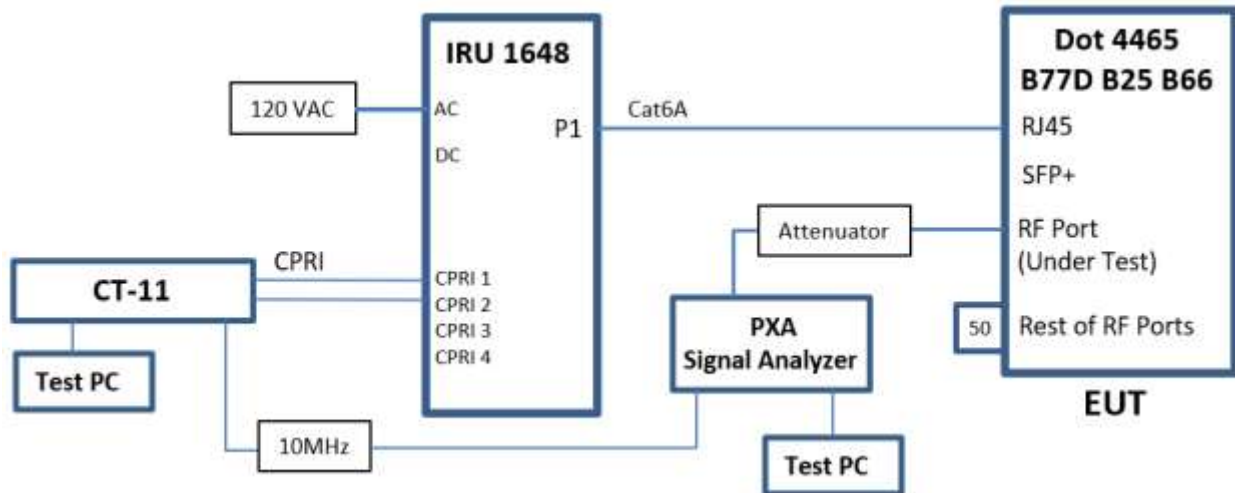

Conducted Test Set Up – Frequency Stability

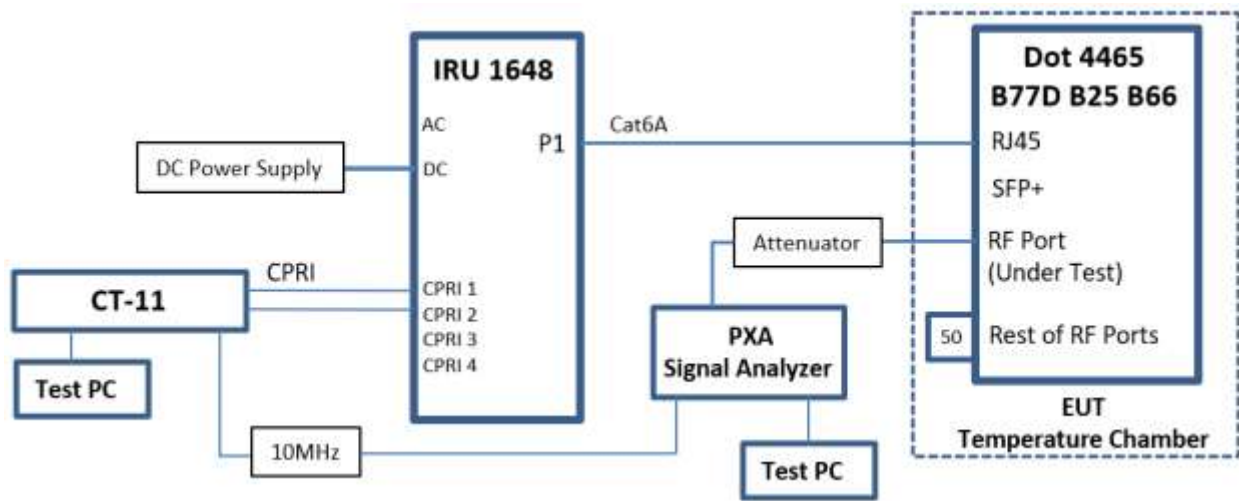

Dashed line indicates equipment inside the Temperature Chamber for testing



Test Conditions

For all tests the EUT was set up in accordance with the relevant test standard and to represent typical operating conditions. Tests were applied with the EUT situated as described in the Test Method for each Test.

The EUT was powered from a -48V DC supply unless otherwise stated.

FCC Measurement Facility Registration Number
CA4810 TUV SUD Canada, 1280 Teron Rd., Kanata On.

Under our A2LA Accreditation, TÜV SÜD Canada conducted the following tests Ericsson, Ottawa Laboratory: 349 Terry Fox Dr, Kanata, ON.

Test Name	Name of Engineer(s)
Maximum Peak Output Power and Peak to Average Ratio - Conducted	Glen Westwell
Occupied Bandwidth	Glen Westwell
Band Edge	Glen Westwell
Transmitter Spurious Emissions	Glen Westwell
Frequency Stability	Glen Westwell

1.8 DEVIATION FROM THE STANDARD

No deviations from the applicable test standards or test plan were made during testing.

1.9 MODIFICATION RECORD

The R1A unit under test was modified to be identical to the R1B build of this product

1. The C62T3A8 component was changed
 - a. from a RJC 545 1110/4C, 0.4pF +/-0.1pF 0201 100V HQ C0/CAPACITOR
 - b. To a REG 724 5182/33PJ, 33nH 5% 0201/INDUCTOR
2. The C62T4A8 component was changed
 - a. from a RJC 545 1110/4C, 0.4pF +/-0.1pF 0201 100V HQ C0/CAPACITOR
 - b. To a REG 724 5182/33PJ, 33nH 5% 0201/INDUCTOR
3. Added RF Absorber Material (2/MPP 901 158/2) inside EMC cover

1.10 ADDITIONAL INFORMATION

1. This filing is for a Radio Certification for use in the USA under the following ID's:

FCC ID: TA8AKRY901523-1 & TA8AKRY901523-2

2. Transmitter performance was measured for top, mid & bottom channels for contiguous and non-contiguous (NC) operation, where applicable, across all antenna ports as presented in the average power measurement tables. Typical performance is presented. All configuration data is on file and available upon request.



3. The Dot 4455 B77DB25B66 and Dot 4465 B77DB25B66 radios are identical except that Dot 4455 has internal antennas and Dot 4465 has external RF ports.



SECTION 2

TEST DETAILS



2.1 MAXIMUM PEAK OUTPUT POWER AND PEAK TO AVERAGE RATIO - CONDUCTED

2.1.1 Specification Reference

FCC CFR 47 Part 24, Clause 24.232
FCC CFR 47 Part 2, Clause 2.1046

2.1.2 Date of Test and Modification State

07, 10 and 12-October-2022 - Modification State 0

2.1.3 Test Equipment Used

The major items of test equipment used for the above tests are identified in Section 3.1.

2.1.4 Environmental Conditions

Ambient Temperature	32.0°C
Relative Humidity	22.1 - 23.3%

2.1.5 Test Method

All measurements were made in accordance with FCC KDB 971168 D01, clause 5.2.1 and summed in accordance with FCC KDB 662911 D01.



2.1.6 Test Results

Configuration A

Maximum Output Power 23.00 dBm / Port

Antenna	NR / LTE Modulation	NR / LTE Carrier Bandwidth	Peak to Average Ratio (PAR) / Output Power			
			Channel Position B			
			PAR (dB)	Average Power		
dBm	EIRP (dBm)	dBm/MHz				
C	LTE: QPSK	5.0 MHz	8.25	23.53	27.73	17.52
D	LTE: QPSK	5.0 MHz	-	23.23	27.43	17.52
Total			-	26.39	30.59	20.53
C	LTE: QPSK	10.0 MHz	8.33	23.32	27.52	14.15
D	LTE: QPSK	10.0 MHz	-	22.98	27.18	14.15
Total			-	26.16	30.36	17.16
C	LTE: QPSK	15.0 MHz	8.31	23.52	27.72	13.78
D	LTE: QPSK	15.0 MHz	-	23.21	27.41	13.78
Total			-	26.38	30.58	16.79
C	LTE: QPSK	20.0 MHz	8.31	23.60	27.80	13.16
D	LTE: QPSK	20.0 MHz	-	22.75	26.95	13.16
Total			-	26.21	30.41	16.17
C	NR: QPSK	5.0 MHz	8.30	23.92	28.12	17.82
D	NR: QPSK	5.0 MHz	-	23.63	27.83	17.82
Total			-	26.79	30.99	20.83
C	NR: QPSK	10.0 MHz	8.36	23.83	28.03	14.58
D	NR: QPSK	10.0 MHz	-	23.52	27.72	14.58
Total			-	26.69	30.89	17.59
C	NR: QPSK	15.0 MHz	8.42	23.91	28.11	15.35
D	NR: QPSK	15.0 MHz	-	23.68	27.88	15.35
Total			-	26.81	31.01	18.36
C	NR: QPSK	20.0 MHz	8.32	24.01	28.21	14.99
D	NR: QPSK	20.0 MHz	-	23.74	27.94	14.99
Total			-	26.89	31.09	18.00
C	NR: QPSK	25.0 MHz	8.26	23.57	27.77	11.94
D	NR: QPSK	25.0 MHz	-	23.72	27.92	11.94
Total			-	26.66	30.86	14.95
C	NR: QPSK	30.0 MHz	8.29	23.65	27.85	11.18
D	NR: QPSK	30.0 MHz	-	23.26	27.46	11.18
Total			-	26.47	30.67	14.19
C	NR: QPSK	40.0 MHz	8.27	23.60	27.80	9.48
D	NR: QPSK	40.0 MHz	-	23.29	27.49	9.48
Total			-	26.46	30.66	12.49



Maximum Output Power 23.00 dBm / Port

Antenna	NR / LTE Modulation	NR / LTE Carrier Bandwidth	Peak to Average Ratio (PAR) / Output Power			
			Channel Position M			
			PAR (dB)	Average Power		
dBm	EIRP (dBm)	dBm/MHz				
C	LTE: QPSK	5.0 MHz	8.25	23.67	27.87	17.71
D	LTE: QPSK	5.0 MHz	-	23.42	27.62	17.71
Total			-	26.56	30.76	20.72
C	LTE: QPSK	10.0 MHz	8.28	23.47	27.67	14.34
D	LTE: QPSK	10.0 MHz	-	23.22	27.42	14.34
Total			-	26.36	30.56	17.35
C	LTE: QPSK	15.0 MHz	8.32	23.65	27.85	13.72
D	LTE: QPSK	15.0 MHz	-	23.33	27.53	13.72
Total			-	26.50	30.70	16.73
C	LTE: QPSK	20.0 MHz	8.32	23.08	27.28	12.89
D	LTE: QPSK	20.0 MHz	-	22.77	26.97	12.89
Total			-	25.94	30.14	15.90
C	NR: QPSK	5.0 MHz	8.27	24.05	28.25	17.69
D	NR: QPSK	5.0 MHz	-	23.76	27.96	17.69
Total			-	26.92	31.12	20.70
C	NR: QPSK	10.0 MHz	8.31	24.01	28.21	14.69
D	NR: QPSK	10.0 MHz	-	23.73	27.93	14.69
Total			-	26.88	31.08	17.70
C	NR: QPSK	15.0 MHz	8.40	24.00	28.20	14.40
D	NR: QPSK	15.0 MHz	-	23.74	27.94	14.40
Total			-	26.88	31.08	17.41
C	NR: QPSK	20.0 MHz	8.36	24.04	28.24	14.43
D	NR: QPSK	20.0 MHz	-	23.71	27.91	14.43
Total			-	26.89	31.09	17.44
C	NR: QPSK	25.0 MHz	8.21	24.11	28.31	11.52
D	NR: QPSK	25.0 MHz	-	23.26	27.46	11.52
Total			-	26.72	30.92	14.53
C	NR: QPSK	30.0 MHz	8.27	23.64	27.84	10.78
D	NR: QPSK	30.0 MHz	-	23.32	27.52	10.78
Total			-	26.49	30.69	13.79
C	NR: QPSK	40.0 MHz	8.28	23.89	28.09	9.25
D	NR: QPSK	40.0 MHz	-	23.53	27.73	9.25
Total			-	26.72	30.92	12.26



Maximum Output Power 23.00 dBm / Port

Antenna	NR / LTE Modulation	NR / LTE Carrier Bandwidth	Peak to Average Ratio (PAR) / Output Power			
			Channel Position T			
			PAR (dB)	Average Power		
dBm	EIRP (dBm)	dBm/MHz				
C	LTE: QPSK	5.0 MHz	8.23	23.75	27.95	18.09
D	LTE: QPSK	5.0 MHz	-	23.39	27.59	18.09
Total			-	26.58	30.78	21.10
C	LTE: QPSK	10.0 MHz	8.27	23.62	27.82	14.95
D	LTE: QPSK	10.0 MHz	-	23.29	27.49	14.95
Total			-	26.47	30.67	17.96
C	LTE: QPSK	15.0 MHz	8.23	23.78	27.98	14.13
D	LTE: QPSK	15.0 MHz	-	23.48	27.68	14.13
Total			-	26.64	30.84	17.14
C	LTE: QPSK	20.0 MHz	8.29	23.79	27.99	13.03
D	LTE: QPSK	20.0 MHz	-	22.94	27.14	13.03
Total			-	26.40	30.60	16.04
C	NR: QPSK	5.0 MHz	8.28	24.17	28.37	18.01
D	NR: QPSK	5.0 MHz	-	23.86	28.06	18.01
Total			-	27.03	31.23	21.02
C	NR: QPSK	10.0 MHz	8.31	24.21	28.41	15.25
D	NR: QPSK	10.0 MHz	-	23.88	28.08	15.25
Total			-	27.06	31.26	18.26
C	NR: QPSK	15.0 MHz	8.32	24.14	28.34	14.96
D	NR: QPSK	15.0 MHz	-	23.87	28.07	14.96
Total			-	27.02	31.22	17.97
C	NR: QPSK	20.0 MHz	8.31	24.10	28.30	14.65
D	NR: QPSK	20.0 MHz	-	23.83	28.03	14.65
Total			-	26.98	31.18	17.66
C	NR: QPSK	25.0 MHz	8.19	23.76	27.96	12.08
D	NR: QPSK	25.0 MHz	-	23.43	27.63	12.08
Total			-	26.61	30.81	15.09
C	NR: QPSK	30.0 MHz	8.27	23.73	27.93	11.28
D	NR: QPSK	30.0 MHz	-	23.38	27.58	11.28
Total			-	26.57	30.77	14.29
C	NR: QPSK	40.0 MHz	8.22	23.84	28.04	9.45
D	NR: QPSK	40.0 MHz	-	23.33	27.53	9.45
Total			-	26.60	30.80	12.46

Remarks

1. Transmitter performance has been presented for top, mid, bottom channels across all antenna ports as represented in the following tables.
2. Typical performance and measurement plot data has been presented for reference.
3. All contiguous and non-contiguous (NC) plot data is on file and available upon request.



Antenna Carrier Power - Modulation LTE: QPSK - Carrier Bandwidth 5.0 MHz - Channel Position B



Antenna Pk-Av Ratio - Modulation LTE: QPSK - Carrier Bandwidth 5.0 MHz - Channel Position B

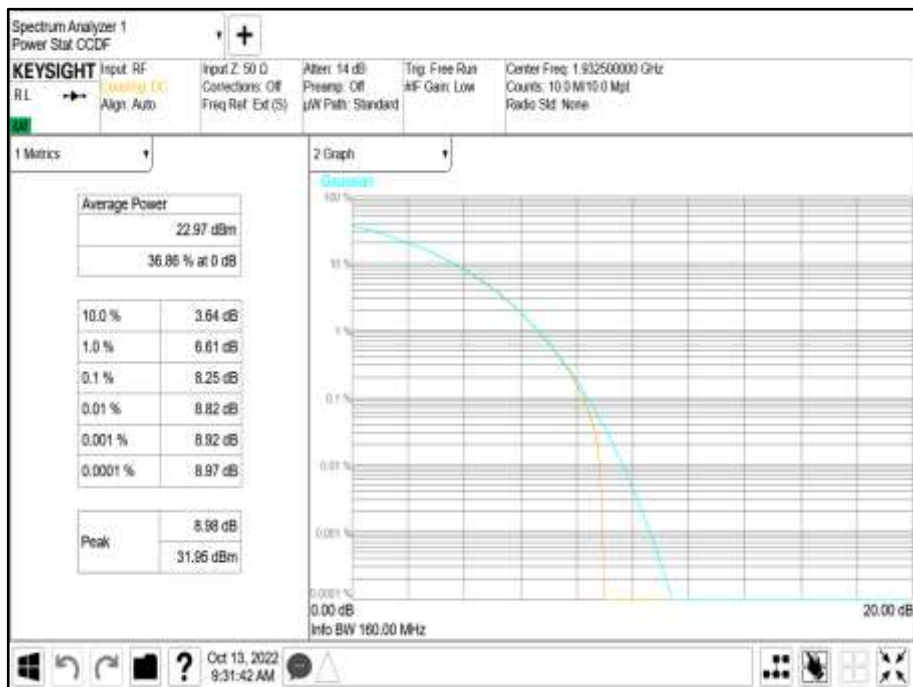



Antenna PSD - Modulation LTE: QPSK - Carrier Bandwidth 5.0 MHz - Channel Position B



Antenna Carrier Power - Modulation LTE: QPSK - Carrier Bandwidth 10.0 MHz - Channel Position B





Antenna Pk-Av Ratio - Modulation LTE: QPSK - Carrier Bandwidth 10.0 MHz - Channel Position B



Antenna PSD - Modulation LTE: QPSK - Carrier Bandwidth 10.0 MHz - Channel Position B





Antenna Carrier Power - Modulation LTE: QPSK - Carrier Bandwidth 15.0 MHz - Channel Position B



Antenna Pk-Av Ratio - Modulation LTE: QPSK - Carrier Bandwidth 15.0 MHz - Channel Position B

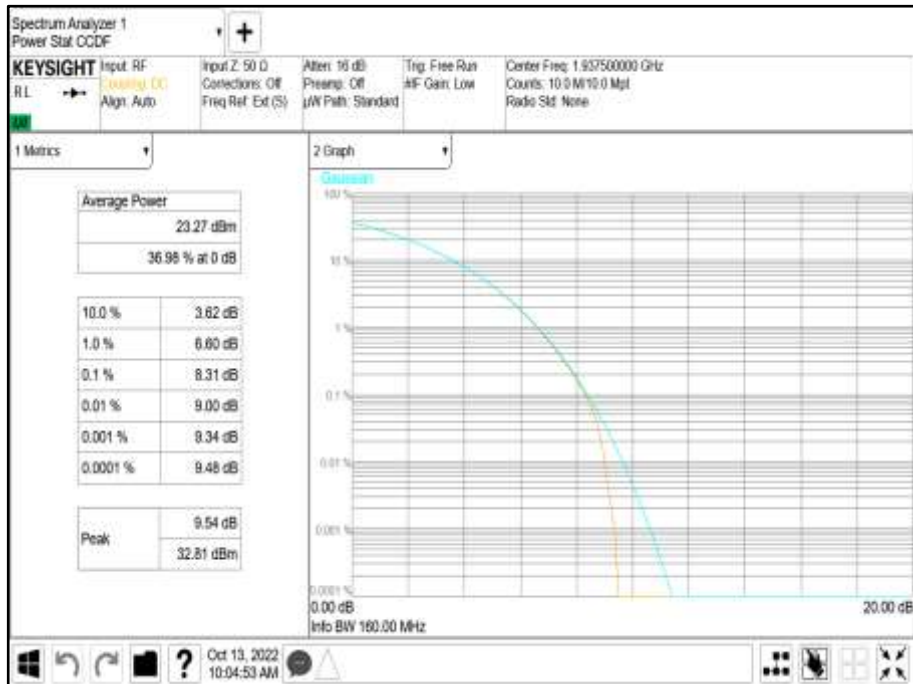



Antenna PSD - Modulation LTE: QPSK - Carrier Bandwidth 15.0 MHz - Channel Position B

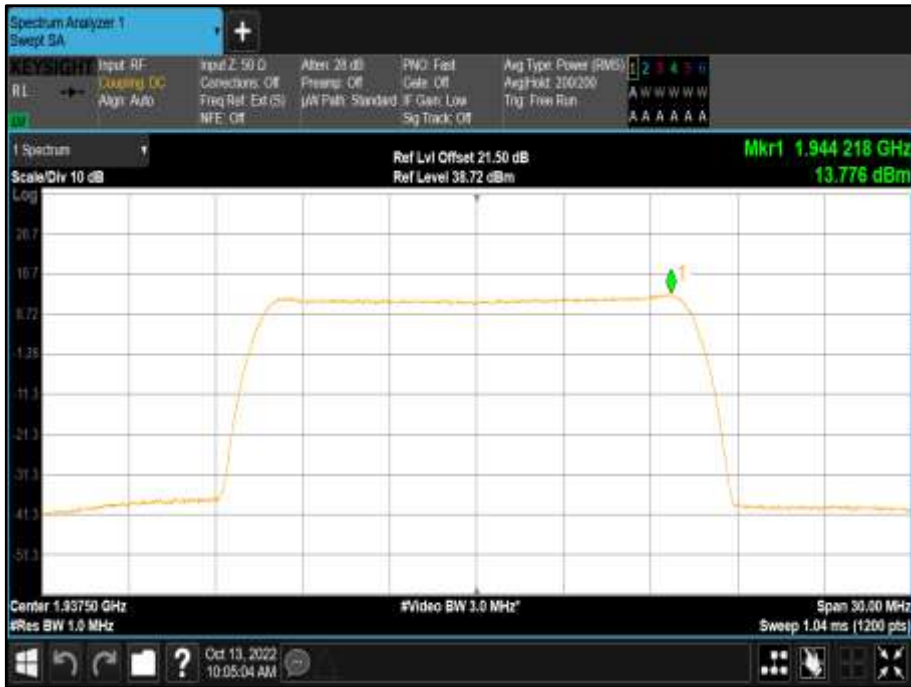

Antenna Carrier Power - Modulation LTE: QPSK - Carrier Bandwidth 20.0 MHz - Channel Position B





Antenna Pk-Av Ratio - Modulation LTE: QPSK - Carrier Bandwidth 20.0 MHz - Channel Position B



Antenna PSD - Modulation LTE: QPSK - Carrier Bandwidth 20.0 MHz - Channel Position B

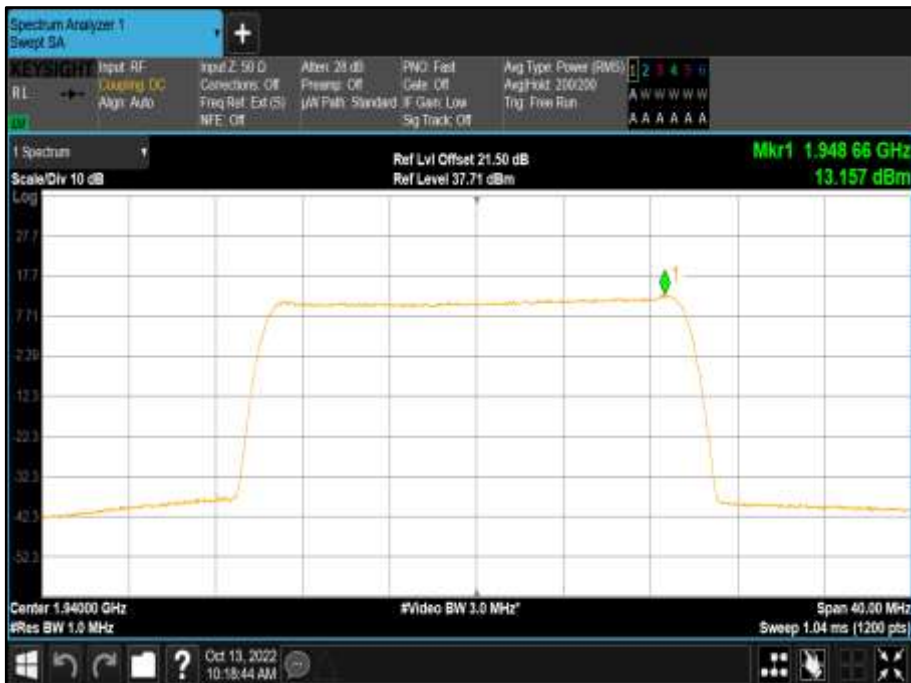



Antenna Carrier Power - Modulation NR: QPSK - Carrier Bandwidth 5.0 MHz - Channel Position B



Antenna Pk-Av Ratio - Modulation NR: QPSK - Carrier Bandwidth 5.0 MHz - Channel Position B

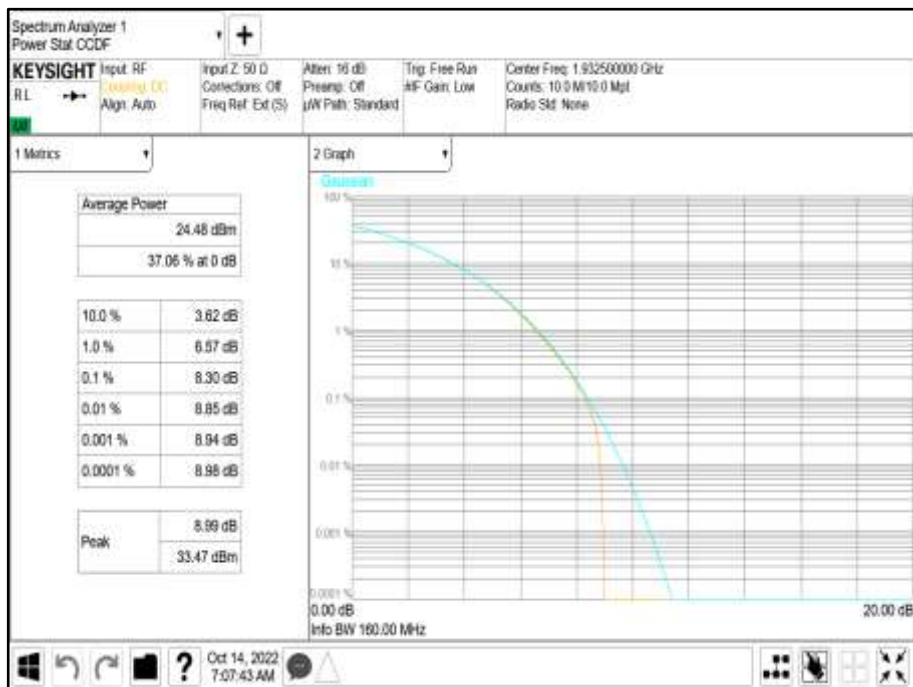



Antenna PSD - Modulation NR: QPSK - Carrier Bandwidth 5.0 MHz - Channel Position B



Antenna Carrier Power - Modulation NR: QPSK - Carrier Bandwidth 10.0 MHz - Channel Position B





Antenna Pk-Av Ratio - Modulation NR: QPSK - Carrier Bandwidth 10.0 MHz - Channel Position B



Antenna PSD - Modulation NR: QPSK - Carrier Bandwidth 10.0 MHz - Channel Position B

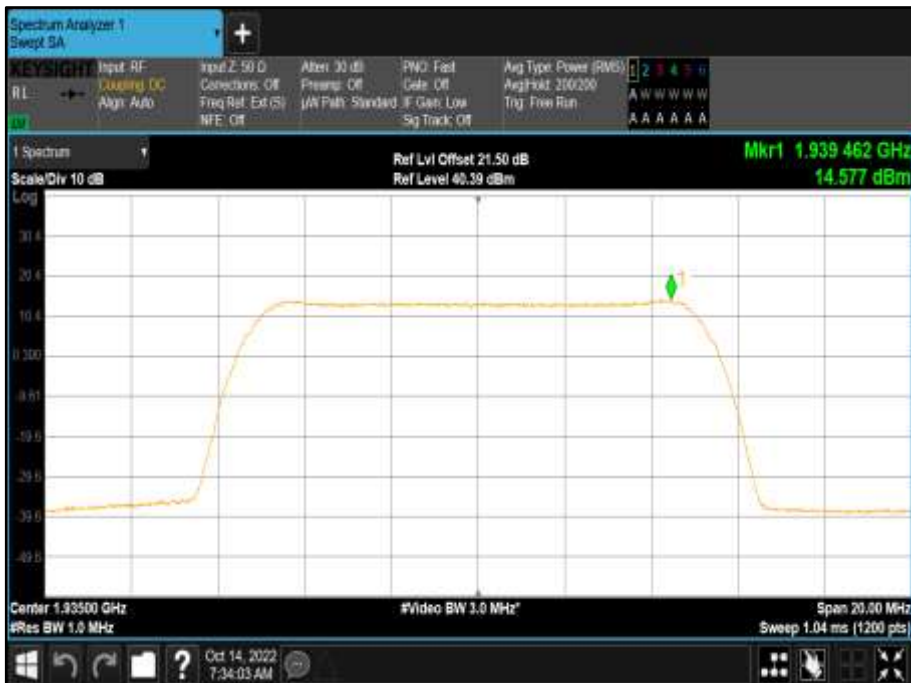



Antenna Carrier Power - Modulation NR: QPSK - Carrier Bandwidth 15.0 MHz - Channel Position B



Antenna Pk-Av Ratio - Modulation NR: QPSK - Carrier Bandwidth 15.0 MHz - Channel Position B





Antenna PSD - Modulation NR: QPSK - Carrier Bandwidth 15.0 MHz - Channel Position B

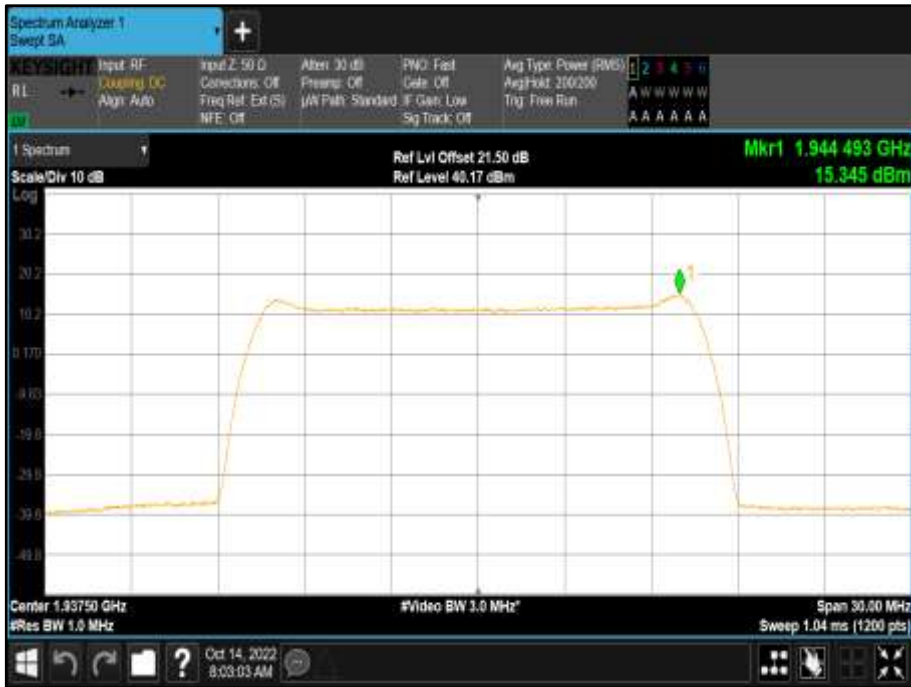

Antenna Carrier Power - Modulation NR: QPSK - Carrier Bandwidth 20.0 MHz - Channel Position B





Antenna Pk-Av Ratio - Modulation NR: QPSK - Carrier Bandwidth 20.0 MHz - Channel Position B



Antenna PSD - Modulation NR: QPSK - Carrier Bandwidth 20.0 MHz - Channel Position B





Antenna Carrier Power - Modulation NR: QPSK - Carrier Bandwidth 25.0 MHz - Channel Position B



Antenna Pk-Av Ratio - Modulation NR: QPSK - Carrier Bandwidth 25.0 MHz - Channel Position B





Antenna PSD - Modulation NR: QPSK - Carrier Bandwidth 25.0 MHz - Channel Position B



Antenna Carrier Power - Modulation NR: QPSK - Carrier Bandwidth 30.0 MHz - Channel Position B





Antenna Pk-Av Ratio - Modulation NR: QPSK - Carrier Bandwidth 30.0 MHz - Channel Position B



Antenna PSD - Modulation NR: QPSK - Carrier Bandwidth 30.0 MHz - Channel Position B

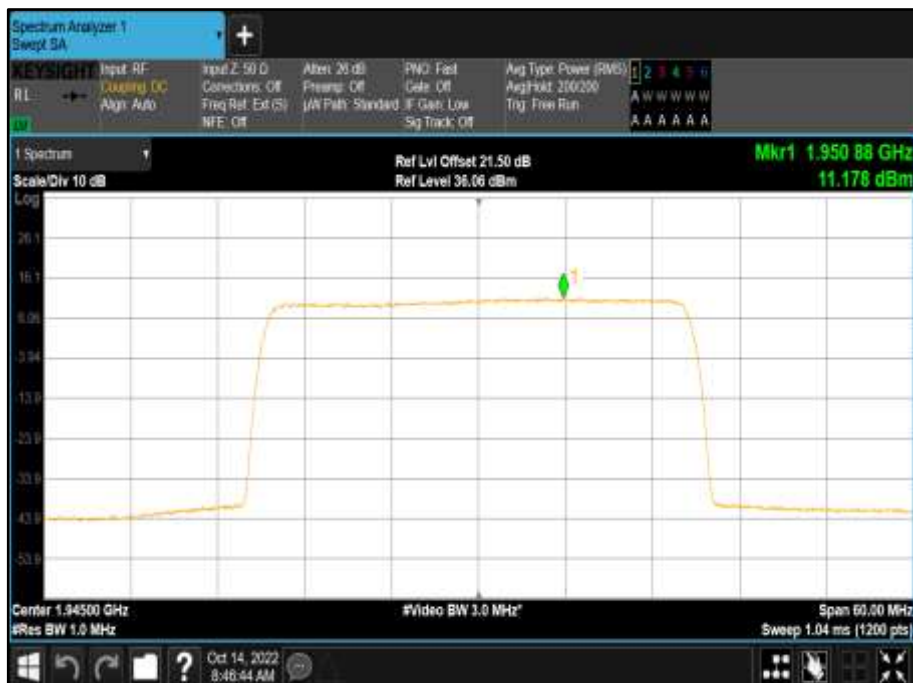



Antenna Carrier Power - Modulation NR: QPSK - Carrier Bandwidth 40.0 MHz - Channel Position B



Antenna Pk-Av Ratio - Modulation NR: QPSK - Carrier Bandwidth 40.0 MHz - Channel Position B





Antenna PSD - Modulation NR: QPSK - Carrier Bandwidth 40.0 MHz - Channel Position B





Configuration B

Maximum Output Power 23.00 dBm / Port

Antenna	NR / LTE Modulation	NR / LTE Carrier Bandwidth	Peak to Average Ratio (PAR) / Output Power	
			Channel Position B	
			Average Power	
			dBm	EIRP (dBm)
C	LTE	5.0+5.0 MHz	23.48	27.68
D	LTE	5.0+5.0 MHz	23.15	27.35
Total			26.33	30.53
C	LTE	20.0+20.0 MHz	23.15	27.35
D	LTE	20.0+20.0 MHz	23.00	27.20
Total			26.09	30.29
C	NR	5.0+5.0 MHz	23.88	28.08
D	NR	5.0+5.0 MHz	23.63	27.83
Total			26.77	30.97
C	NR	30.0+30.0 MHz	23.85	28.05
D	NR	30.0+30.0 MHz	23.47	27.67
Total			26.67	30.87
C	LTE + NR	5.0+5.0 MHz	23.39	27.59
D	LTE + NR	5.0+5.0 MHz	23.11	27.31
Total			26.26	30.46
C	LTE + NR (NC)	5.0+5.0 MHz	23.18	27.38
D	LTE + NR (NC)	5.0+5.0 MHz	22.87	27.07
Total			26.04	30.24

Maximum Output Power 23.00 dBm / Port

Antenna	NR / LTE Modulation	NR / LTE Carrier Bandwidth	Peak to Average Ratio (PAR) / Output Power	
			Channel Position M	
			Average Power	
			dBm	EIRP (dBm)
C	LTE	5.0+5.0 MHz	23.72	27.92
D	LTE	5.0+5.0 MHz	23.39	27.59
Total			26.57	30.77
C	LTE	20.0+20.0 MHz	23.44	27.64
D	LTE	20.0+20.0 MHz	23.09	27.29
Total			26.28	30.48
C	NR	5.0+5.0 MHz	24.07	28.27
D	NR	5.0+5.0 MHz	23.75	27.95
Total			26.92	31.12
C	NR	30.0+30.0 MHz	23.85	28.05
D	NR	30.0+30.0 MHz	23.31	27.51
Total			26.60	30.80
C	LTE + NR	5.0+5.0 MHz	23.59	27.79
D	LTE + NR	5.0+5.0 MHz	23.29	27.49
Total			26.45	30.65
C	LTE + NR (NC)	5.0+5.0 MHz	23.18	27.38
D	LTE + NR (NC)	5.0+5.0 MHz	22.87	27.07
Total			26.04	30.24



Maximum Output Power 23.00 dBm / Port

Antenna	NR / LTE Modulation	NR / LTE Carrier Bandwidth	Peak to Average Ratio (PAR) / Output Power	
			Channel Position T	
			Average Power	
			dBm	EIRP (dBm)
C	LTE	5.0+5.0 MHz	23.87	28.07
D	LTE	5.0+5.0 MHz	23.58	27.78
Total			26.74	30.94
C	LTE	20.0+20.0 MHz	23.37	27.57
D	LTE	20.0+20.0 MHz	23.06	27.26
Total			26.23	30.43
C	NR	5.0+5.0 MHz	24.29	28.49
D	NR	5.0+5.0 MHz	23.96	28.16
Total			27.14	31.34
C	NR	30.0+30.0 MHz	23.81	28.01
D	NR	30.0+30.0 MHz	23.34	27.54
Total			26.59	30.79
C	LTE + NR	5.0+5.0 MHz	23.78	27.98
D	LTE + NR	5.0+5.0 MHz	23.48	27.68
Total			26.64	30.84
C	LTE + NR (NC)	5.0+5.0 MHz	23.18	27.38
D	LTE + NR (NC)	5.0+5.0 MHz	22.87	27.07
Total			26.04	30.24

Remarks

1. Two carrier transmitter performance is presented for both contiguous and non-contiguous (NC) configurations.
2. The plot results represent typical radio performance across all channels.
3. The highest power transmitter configuration is presented.
4. Plot data performance for all transmitter ports and channels are on file and available on request.



Antenna C - Modulation LTE: QPSK - NR / LTE Carrier Bandwidth 5.0+5.0 MHz - Channel Position B



Antenna C - Modulation LTE: QPSK - NR / LTE Carrier Bandwidth 20.0+20.0 MHz - Channel Position B

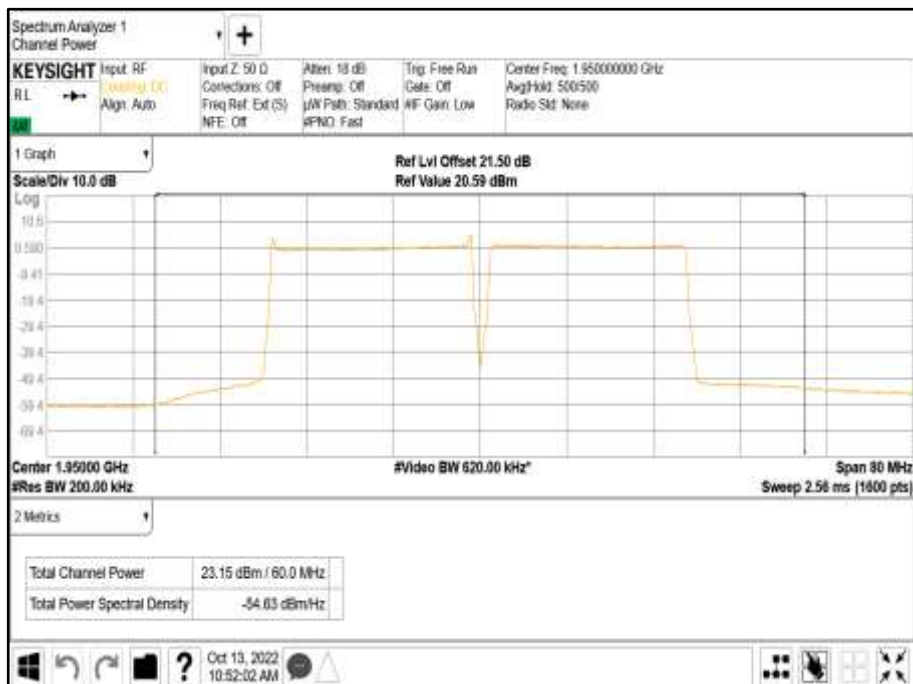



Antenna C - Modulation NR: QPSK - NR / LTE Carrier Bandwidth 5.0+5.0 MHz - Channel Position B



Antenna C - Modulation NR: QPSK - NR / LTE Carrier Bandwidth 30.0+30.0 MHz - Channel Position B





Antenna C - Modulation LTE+NR: QPSK - NR / LTE Carrier Bandwidth 5.0+5.0 MHz - Channel Position B



Antenna C - Modulation LTE+NR (NC): QPSK - NR / LTE Carrier Bandwidth 5.0+5.0 MHz - Channel Position B

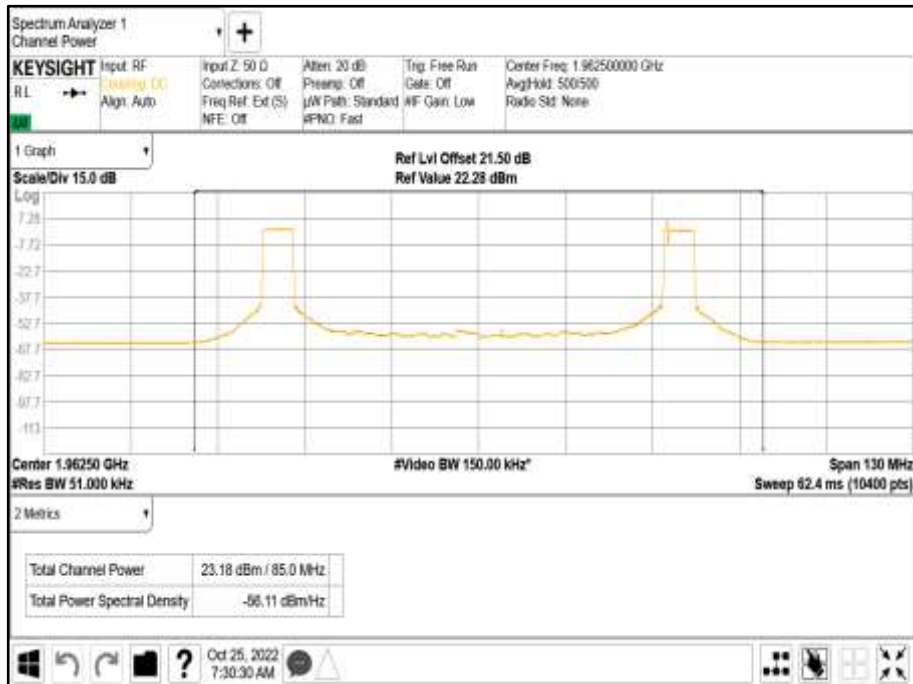



Configuration C

Maximum Output Power 23.00 dBm / Port

Antenna	NR / LTE Modulation	NR / LTE Carrier Bandwidth	Peak to Average Ratio (PAR) / Output Power	
			Channel Position B	
			Average Power	
			dBm	EIRP (dBm)
C	LTE	5.0+5.0+5.0+5.0+5.0+5.0 MHz	23.13	27.33
D	LTE	5.0+5.0+5.0+5.0+5.0+5.0 MHz	22.85	27.05
Total			26.00	30.20
C	LTE	10.0+10.0+10.0+10.0+10.0+10.0 MHz	23.33	27.53
D	LTE	10.0+10.0+10.0+10.0+10.0+10.0 MHz	22.82	27.02
Total			26.09	30.29
C	NR	5.0+5.0+5.0+5.0+5.0+5.0 MHz	23.57	27.77
D	NR	5.0+5.0+5.0+5.0+5.0+5.0 MHz	23.25	27.45
Total			26.42	30.62
C	NR	10.0+10.0+10.0+10.0+10.0+10.0 MHz	23.82	28.02
D	NR	10.0+10.0+10.0+10.0+10.0+10.0 MHz	23.47	27.67
Total			26.66	30.86
C	LTE + NR	5.0+5.0+5.0+5.0+5.0+5.0 MHz	23.12	27.32
D	LTE + NR	5.0+5.0+5.0+5.0+5.0+5.0 MHz	22.80	27.00
Total			25.97	30.17
C	LTE + NR (NC)	5.0+5.0+5.0+5.0+5.0+5.0 MHz	23.24	27.44
D	LTE + NR (NC)	5.0+5.0+5.0+5.0+5.0+5.0 MHz	22.92	27.12
Total			26.09	30.29

Maximum Output Power 23.00 dBm / Port

Antenna	NR / LTE Modulation	NR / LTE Carrier Bandwidth	Peak to Average Ratio (PAR) / Output Power	
			Channel Position M	
			Average Power	
			dBm	EIRP (dBm)
C	LTE	5.0+5.0+5.0+5.0+5.0+5.0 MHz	23.17	27.37
D	LTE	5.0+5.0+5.0+5.0+5.0+5.0 MHz	22.82	27.02
Total			26.01	30.21
C	LTE	10.0+10.0+10.0+10.0+10.0+10.0 MHz	23.35	27.55
D	LTE	10.0+10.0+10.0+10.0+10.0+10.0 MHz	23.09	27.29
Total			26.23	30.43
C	NR	5.0+5.0+5.0+5.0+5.0+5.0 MHz	23.60	27.80
D	NR	5.0+5.0+5.0+5.0+5.0+5.0 MHz	23.25	27.45
Total			26.44	30.64
C	NR	10.0+10.0+10.0+10.0+10.0+10.0 MHz	23.83	28.03
D	NR	10.0+10.0+10.0+10.0+10.0+10.0 MHz	23.33	27.53
Total			26.60	30.80
C	LTE + NR	5.0+5.0+5.0+5.0+5.0+5.0 MHz	23.21	27.41
D	LTE + NR	5.0+5.0+5.0+5.0+5.0+5.0 MHz	22.82	27.02
Total			26.03	30.23
C	LTE + NR (NC)	5.0+5.0+5.0+5.0+5.0+5.0 MHz	23.24	27.44
D	LTE + NR (NC)	5.0+5.0+5.0+5.0+5.0+5.0 MHz	22.92	27.12
Total			26.09	30.29



Maximum Output Power 23.00 dBm / Port

Antenna	NR / LTE Modulation	NR / LTE Carrier Bandwidth	Peak to Average Ratio (PAR) / Output Power	
			Channel Position T	
			Average Power	
			dBm	EIRP (dBm)
C	LTE	5.0+5.0+5.0+5.0+5.0+5.0 MHz	23.76	27.96
D	LTE	5.0+5.0+5.0+5.0+5.0+5.0 MHz	22.90	27.10
Total			26.36	30.56
C	LTE	10.0+10.0+10.0+10.0+10.0+10.0 MHz	23.19	27.39
D	LTE	10.0+10.0+10.0+10.0+10.0+10.0 MHz	22.88	27.08
Total			26.05	30.25
C	NR	5.0+5.0+5.0+5.0+5.0+5.0 MHz	23.66	27.86
D	NR	5.0+5.0+5.0+5.0+5.0+5.0 MHz	23.37	27.57
Total			26.53	30.73
C	NR	10.0+10.0+10.0+10.0+10.0+10.0 MHz	23.63	27.83
D	NR	10.0+10.0+10.0+10.0+10.0+10.0 MHz	23.52	27.72
Total			26.59	30.79
C	LTE + NR	5.0+5.0+5.0+5.0+5.0+5.0 MHz	23.18	27.38
D	LTE + NR	5.0+5.0+5.0+5.0+5.0+5.0 MHz	22.88	27.08
Total			26.04	30.24
C	LTE + NR (NC)	5.0+5.0+5.0+5.0+5.0+5.0 MHz	23.24	27.44
D	LTE + NR (NC)	5.0+5.0+5.0+5.0+5.0+5.0 MHz	22.92	27.12
Total			26.09	30.29

Remarks

1. Six carrier transmitter performance is presented.
2. The plot results represent typical radio performance across all channels.
3. The highest power transmitter configuration is presented for compliance.
4. Plot data performance for all transmitter ports and channels are on file and available on request.



Antenna C - Modulation LTE: QPSK - Carrier Bandwidth 5.0+5.0+5.0+5.0+5.0+5.0 MHz - Channel Position B

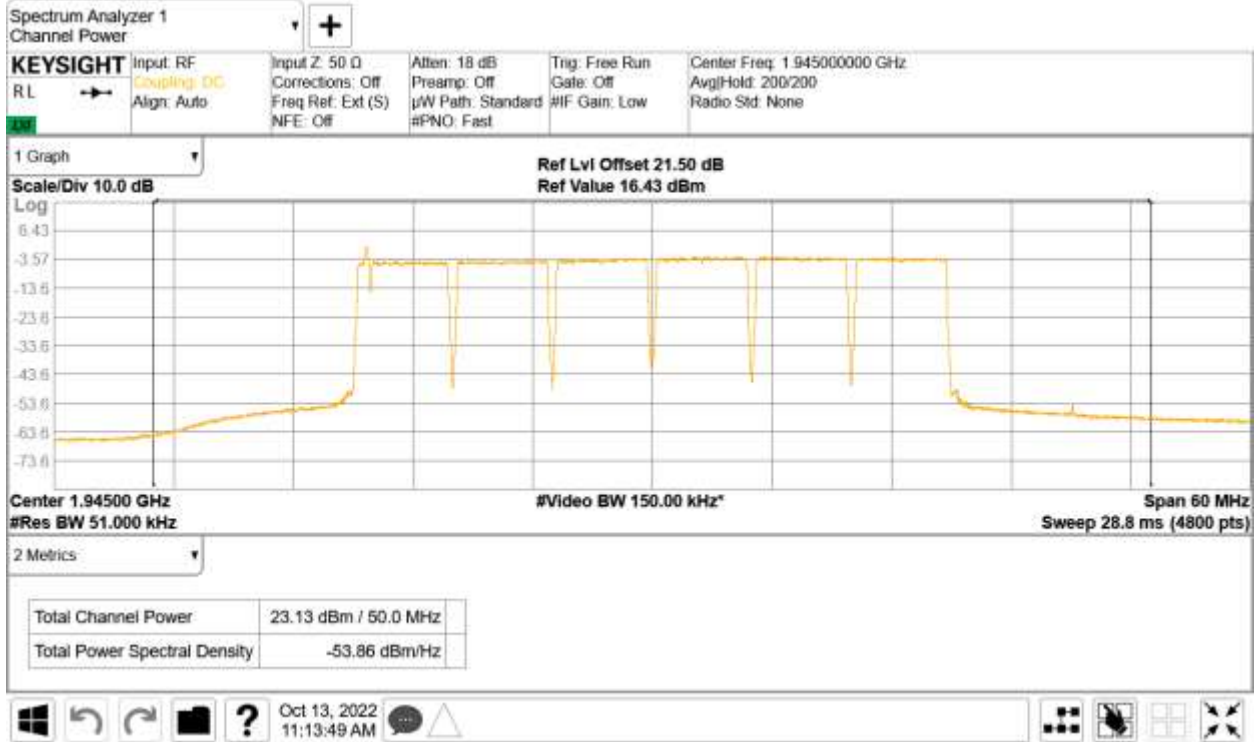

Antenna C - Modulation LTE: QPSK - Carrier Bandwidth 10.0+10.0+10.0+10.0+10.0+10.0 MHz - Channel Position B

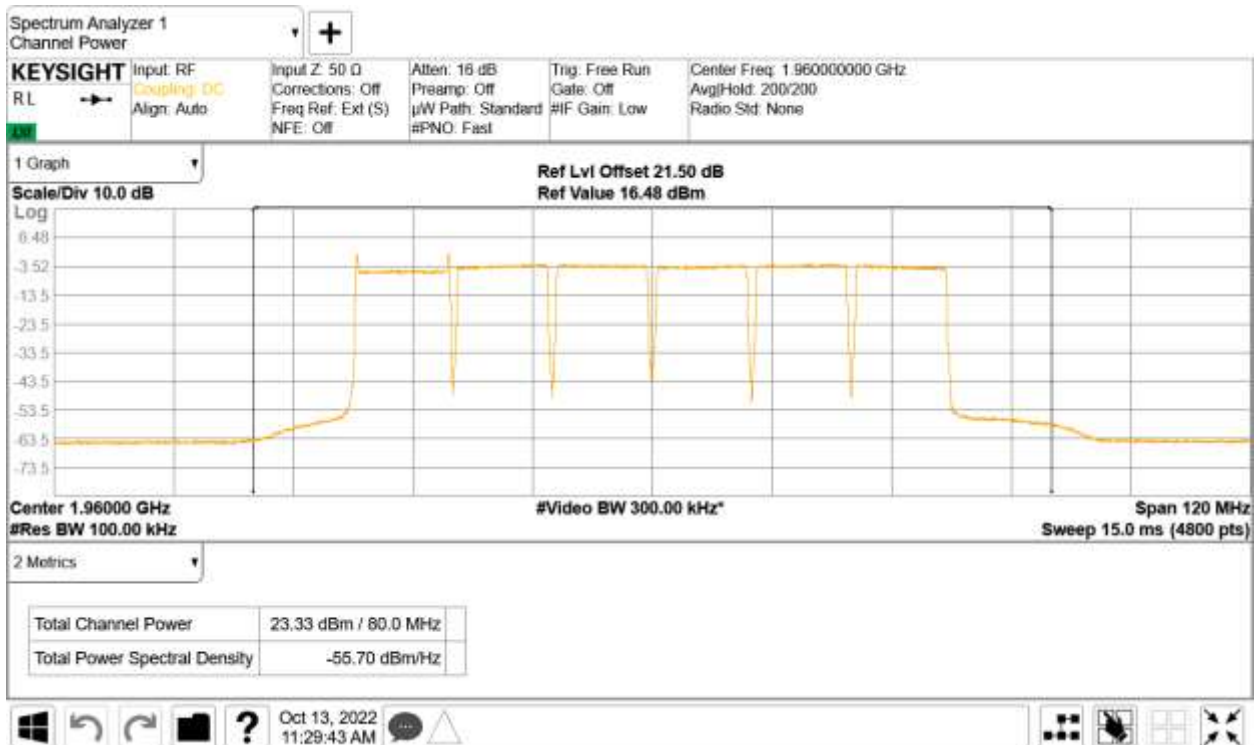



Antenna C - Modulation NR: QPSK - Carrier Bandwidth 5.0+5.0+5.0+5.0+5.0 MHz - Channel Position B

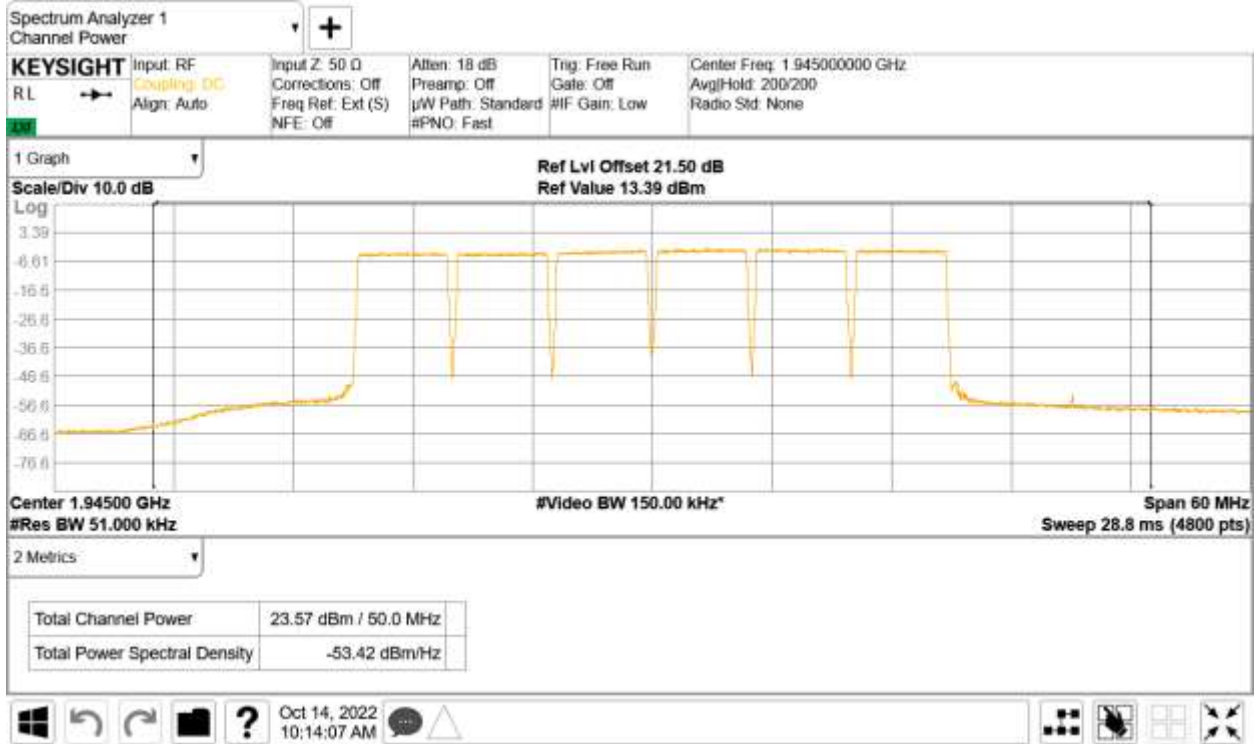

Antenna C - Modulation NR: QPSK - Carrier Bandwidth 10.0+10.0+10.0+10.0+10.0+10.0 MHz - Channel Position B

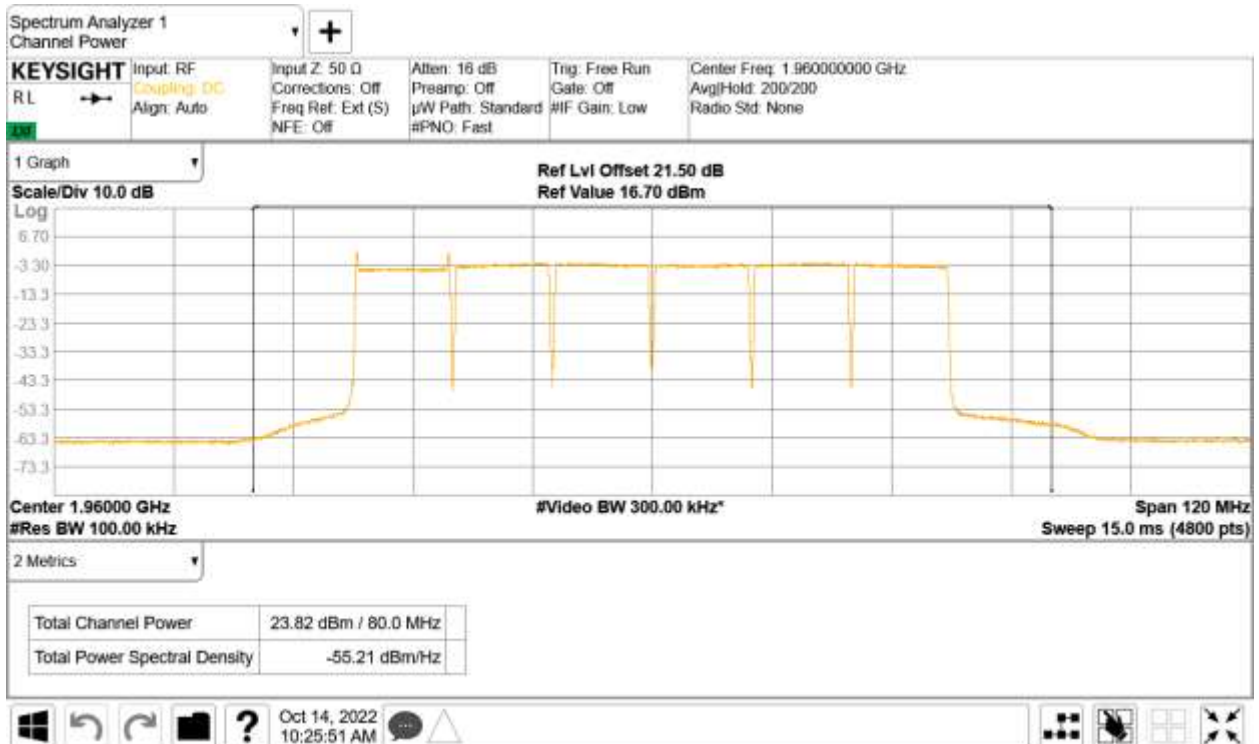



Antenna C - Modulation LTE + NR: QPSK - Carrier Bandwidth 5.0+5.0+5.0+5.0+5.0 MHz - Channel Position B



Antenna C - Modulation LTE + NR (NC): QPSK - Carrier Bandwidth 5.0+5.0+5.0+5.0+5.0MHz - Channel Position B

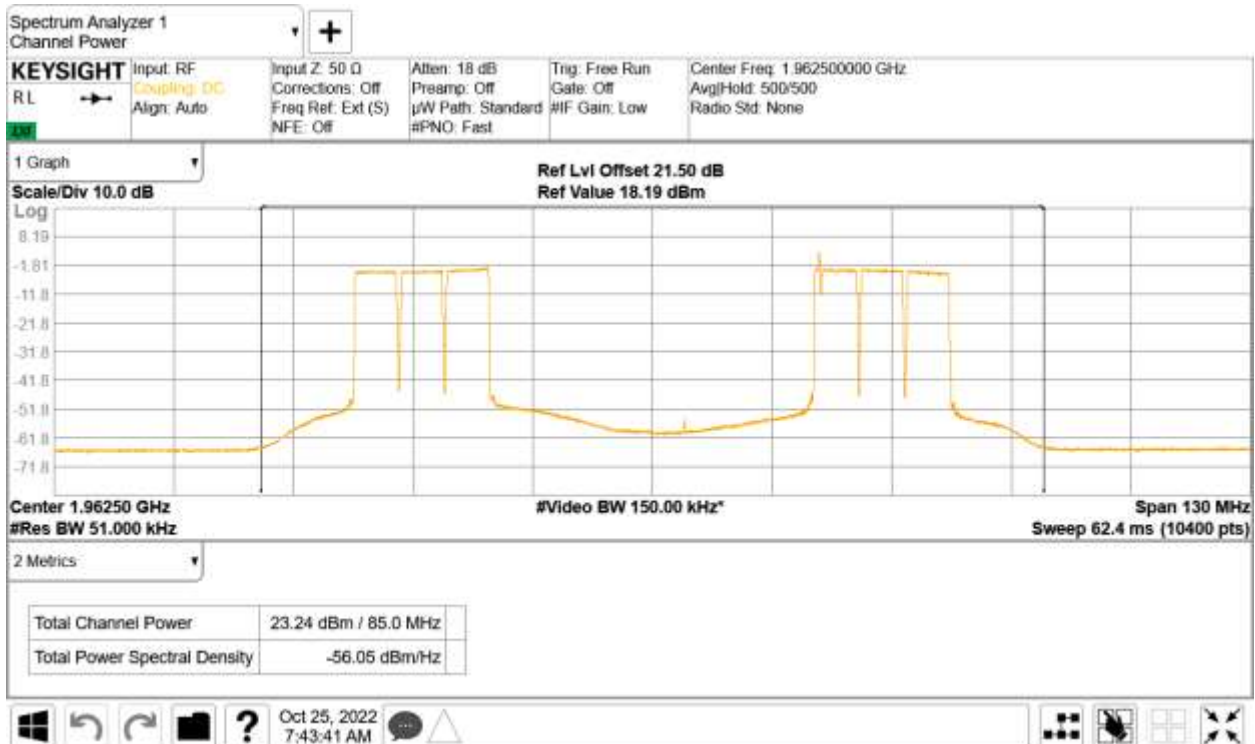



2.2 OCCUPIED BANDWIDTH

2.2.1 Specification Reference

FCC CFR 47 Part 24, Clause 24.238 (b)
FCC CFR 47 Part 2, Clause 2.1049

2.2.2 Date of Test and Modification State

07-October-2022 - Modification State 0

2.2.3 Test Equipment Used

The major items of test equipment used for the above tests are identified in Section 3.1.

2.2.4 Environmental Conditions

Ambient Temperature 32.0°C
Relative Humidity 22.1%

2.2.5 Test Method

All measurements were made in accordance with FCC KDB 971168 D01, Clause 4.2 and 4.3. The Spectrum Analyser RBW was configured to be at least 1% of the channel bandwidth of the carrier to be measured.

Occupied bandwidth – power bandwidth (99 %) measurement procedure
Subclause 5.4.4 of ANSI C63.26-2015 is applicable (wherein the recommendation is to use the 99 % power bandwidth function of a spectrum analyser).

2.2.6 Test Results

Configuration A

Maximum Output Power 23.00 dBm / Port

Antenna	NR / LTE Modulation	NR / LTE Carrier Bandwidth	Result (MHz)
			Channel Bandwidth
			99% Occupied Bandwidth
D	LTE: QPSK	LTE: 5.0 MHz	4.478
C	LTE: QPSK	LTE: 10.0 MHz	9.406
C	LTE: QPSK	LTE: 15.0 MHz	14.048
C	LTE: QPSK	LTE: 20.0 MHz	18.492
C	NR: QPSK	NR: 5.0 MHz	4.484
C	NR: QPSK	NR: 10.0 MHz	9.441
C	NR: QPSK	NR: 15.0 MHz	14.384
C	NR: QPSK	NR: 20.0 MHz	19.185
C	NR: QPSK	NR: 25.0 MHz	23.725
C	NR: QPSK	NR: 30.0 MHz	28.513
C	NR: QPSK	NR: 40.0 MHz	38.559

Remarks

Representative occupied bandwidth performance results presented. Plot data performance for all transmitter ports and channel positions are on file and available on request.



Antenna D - Modulation LTE: QPSK - NR / LTE Carrier Bandwidth LTE: 5.0 MHz - Channel Position B

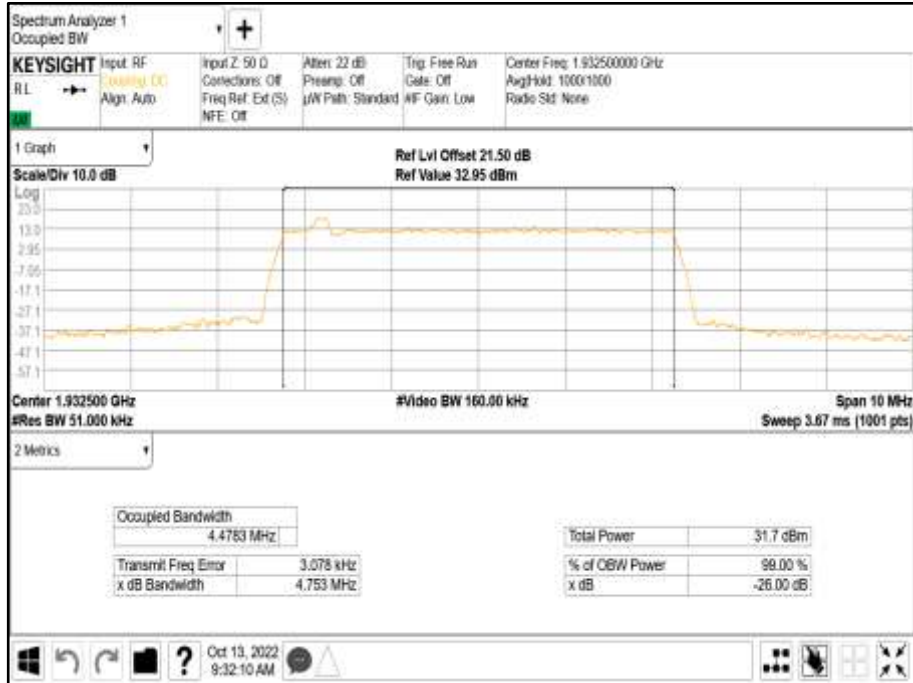

Antenna C - Modulation LTE: QPSK - NR / LTE Carrier Bandwidth LTE: 10.0 MHz - Channel Position B

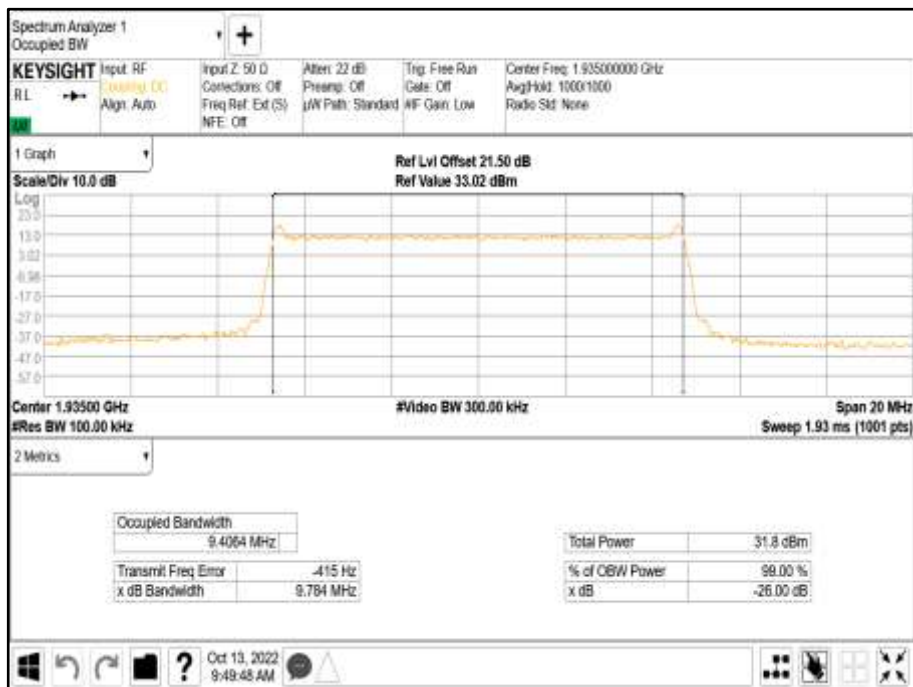



Antenna C - Modulation LTE: QPSK - NR / LTE Carrier Bandwidth LTE: 15.0 MHz - Channel Position B

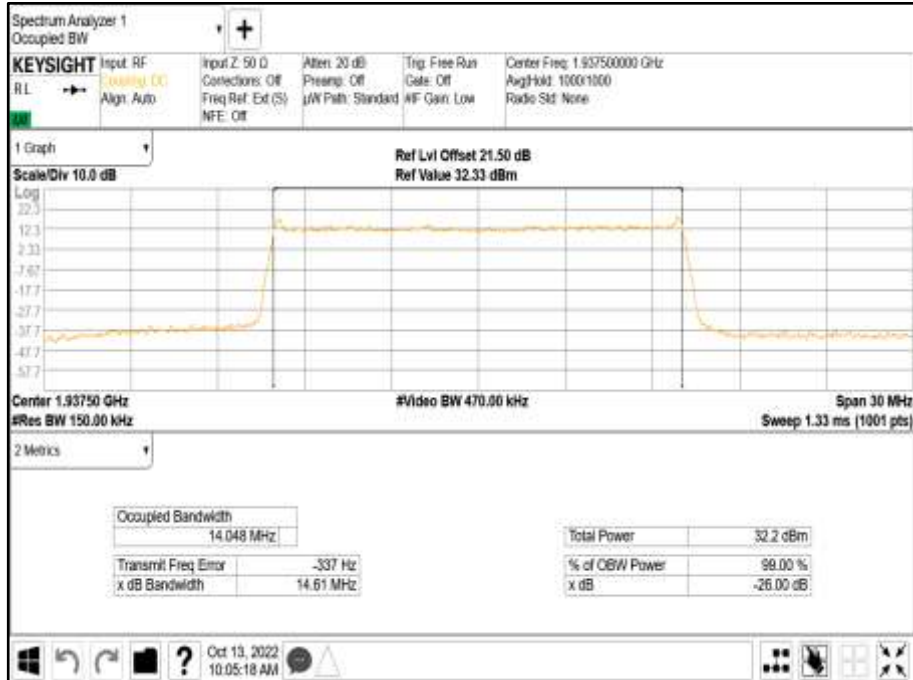

Antenna C - Modulation LTE: QPSK - NR / LTE Carrier Bandwidth LTE: 20.0 MHz - Channel Position B

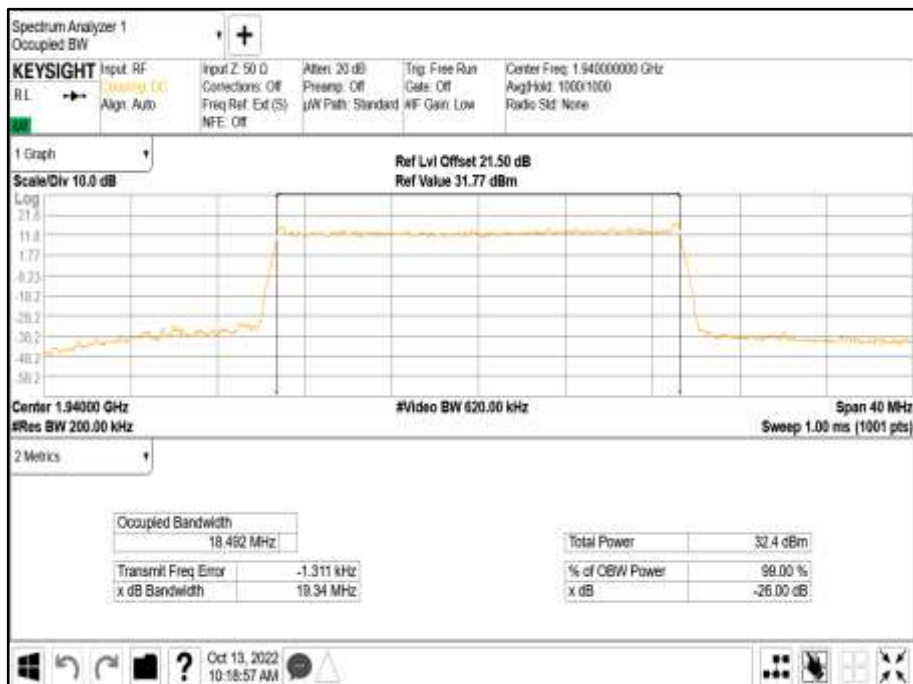



Antenna C - Modulation NR: QPSK - NR / LTE Carrier Bandwidth NR: 5.0 MHz - Channel Position B

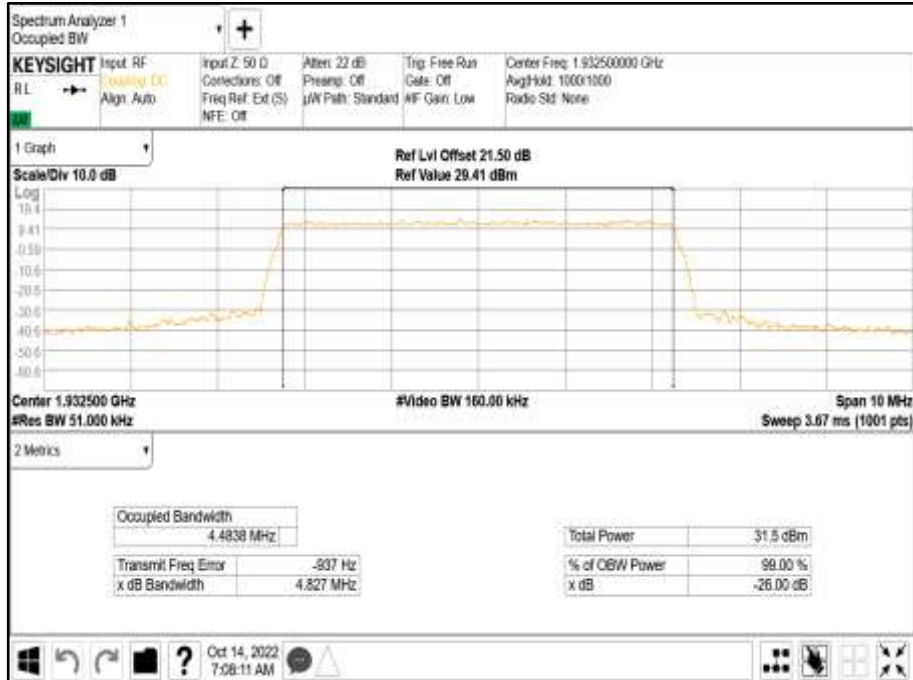

Antenna C - Modulation NR: QPSK - NR / LTE Carrier Bandwidth NR: 10.0 MHz - Channel Position B

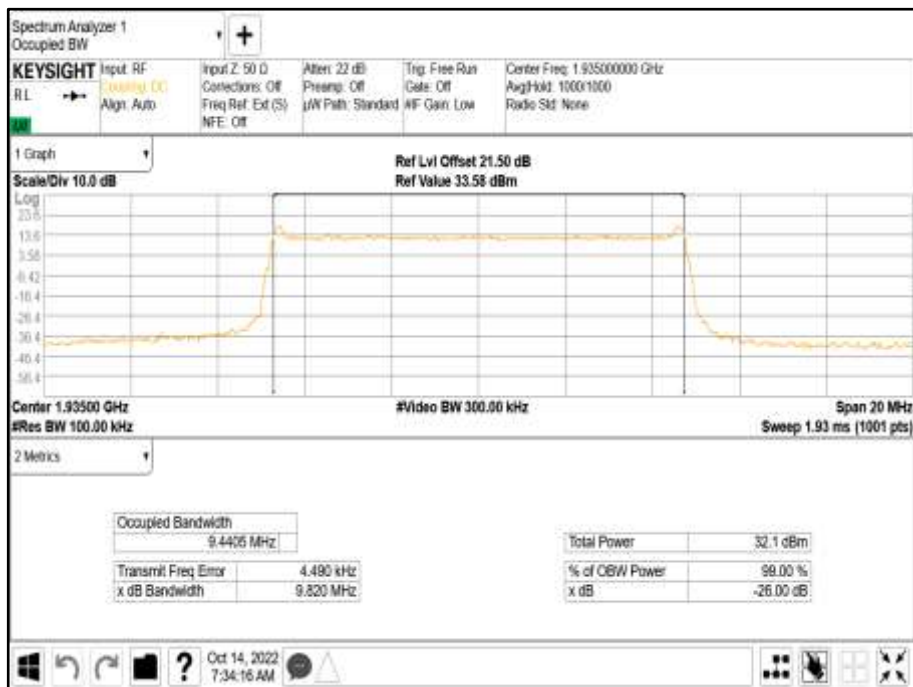



Antenna C - Modulation NR: QPSK - NR / LTE Carrier Bandwidth NR: 15.0 MHz - Channel Position B

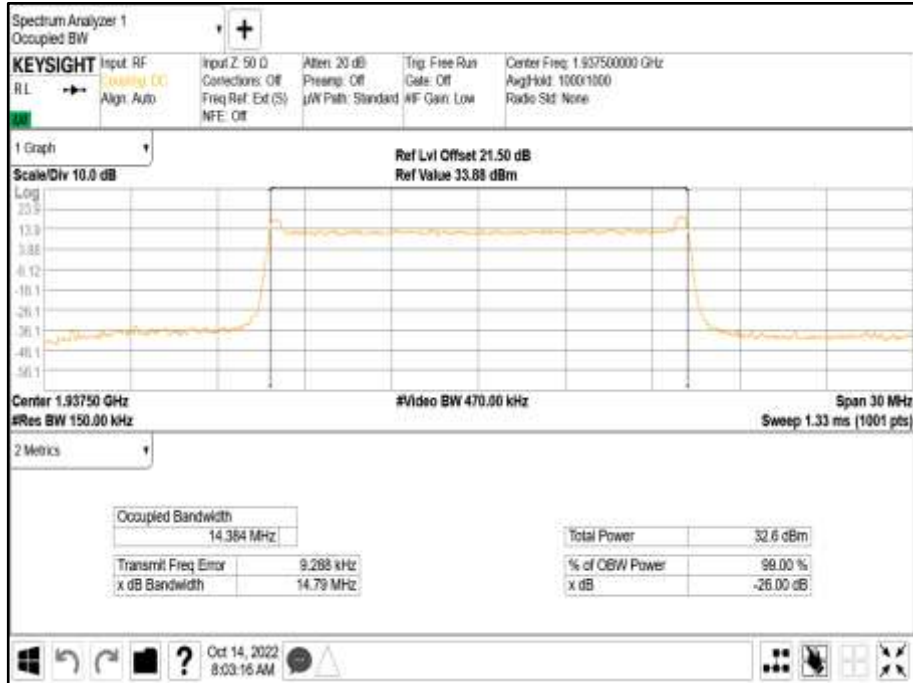

Antenna C - Modulation NR: QPSK - NR / LTE Carrier Bandwidth NR: 20.0 MHz - Channel Position B

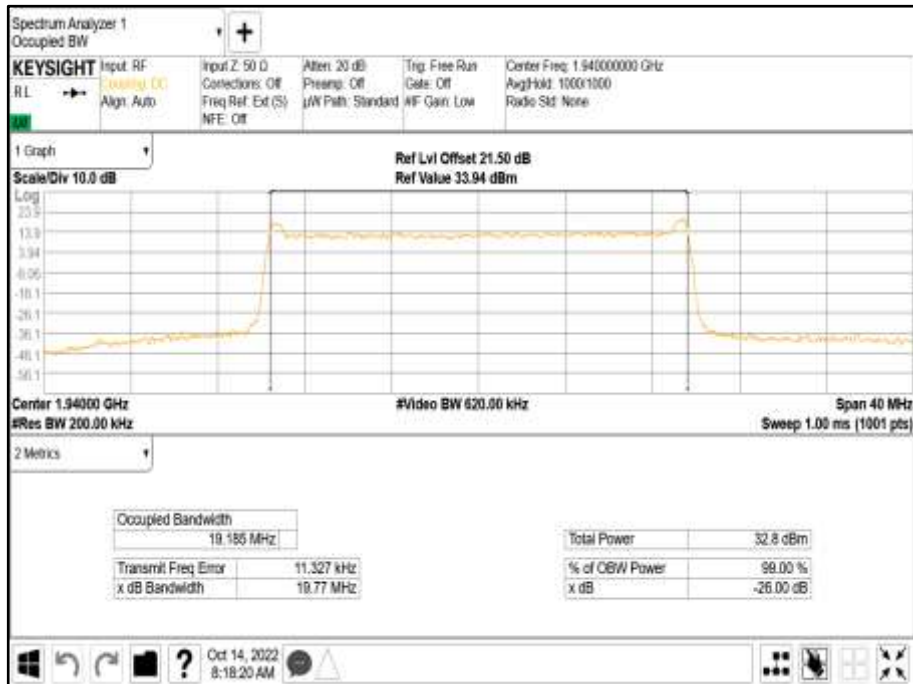



Antenna C - Modulation NR: QPSK - NR / LTE Carrier Bandwidth NR: 25.0 MHz - Channel Position B

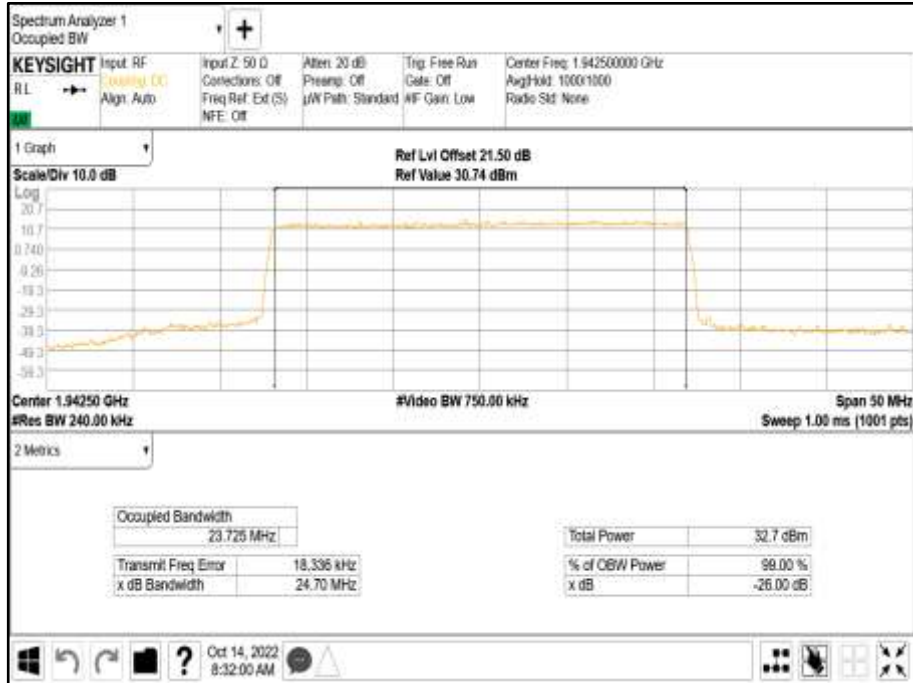

Antenna C - Modulation NR: QPSK - NR / LTE Carrier Bandwidth NR: 30.0 MHz - Channel Position B

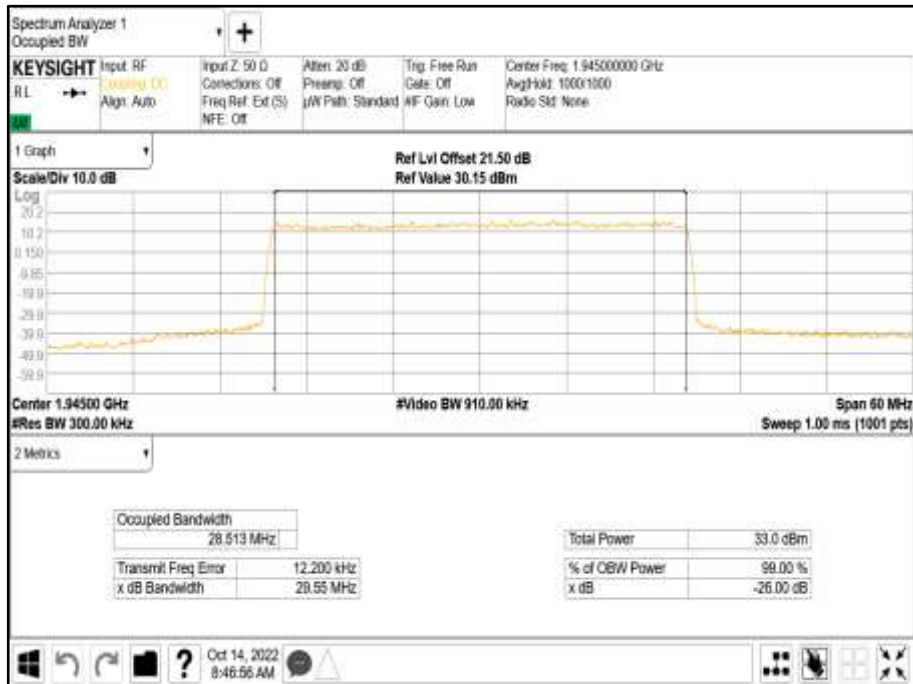



Antenna C - Modulation NR: QPSK - NR / LTE Carrier Bandwidth NR: 40.0 MHz - Channel Position B

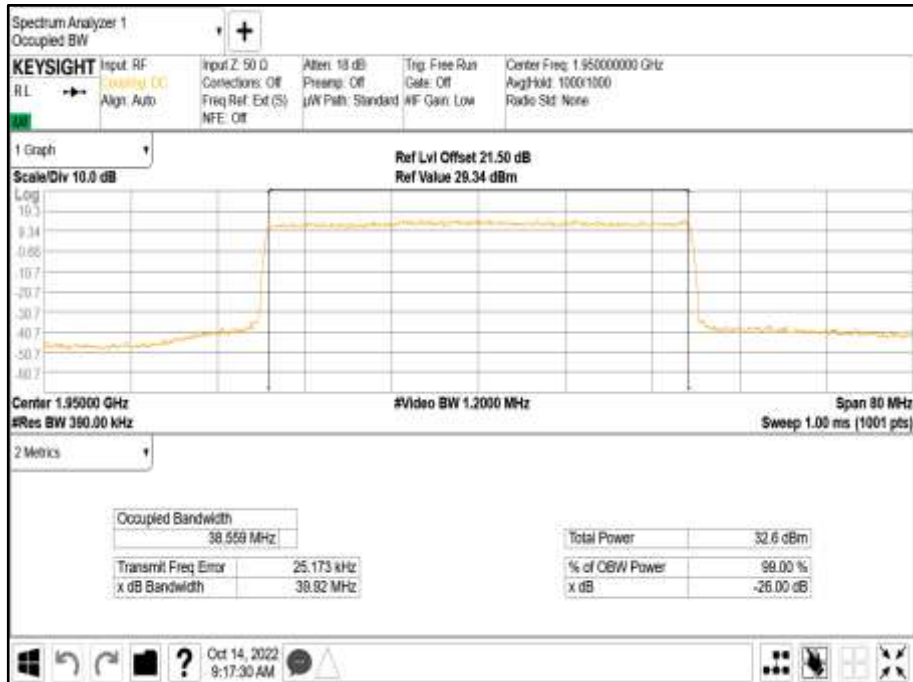



2.3 BAND EDGE

2.3.1 Specification Reference

FCC CFR 47 Part 24, Clause 24.238 (b)
FCC CFR 47 Part 2, Clause 2.1051

2.3.2 Date of Test and Modification State

07, 12 and 13-October-2022 - Modification State 0

2.3.3 Test Equipment Used

The major items of test equipment used for the above tests are identified in Section 3.1.

2.3.4 Environmental Conditions

Ambient Temperature 32.0°C
Relative Humidity 22.1 - 23.0%

2.3.5 Test Method

All measurements were made in accordance with FCC KDB 971168 D01, Clause 6.0.

Band Edge measurements were used an Integration Bandwidth of at least 1% of the measured 26dB Bandwidth.

Each antenna port has been declared as being equivalent, therefore measurements were made on one antenna port only. To account for this, the limit was tightened by $10 * \text{Log}(N)$, where N is equal to the number of MIMO antenna ports.

For dual port, the limit was calculated as being $-13 \text{ dBm} - 10 * \text{Log}(2) = -16 \text{ dBm}$.

2.3.6 Test Results

Configuration A

Maximum Output Power 23.00 dBm / Port

Antenna	Modulation	Carrier Bandwidth	Band Edge (MHz)	
			Channel Position B	Channel Position T
A	LTE: QPSK	LTE: 5.0 MHz	1,932.5	1,992.5
A	LTE: QPSK	LTE: 10.0 MHz	1,935.0	1,990.0
A	LTE: QPSK	LTE: 15.0 MHz	1,937.5	1,987.5
A	LTE: QPSK	LTE: 20.0 MHz	1,940.0	1,985.0
A	NR: QPSK	NR: 5.0 MHz	1,932.5	1,992.5
A	NR: QPSK	NR: 10.0 MHz	1,935.0	1,990.0
A	NR: QPSK	NR: 15.0 MHz	1,937.5	1,987.5
A	NR: QPSK	NR: 20.0 MHz	1,940.0	1,985.0
A	NR: QPSK	NR: 25.0 MHz	1,942.5	1,982.5
A	NR: QPSK	NR: 30.0 MHz	1,945.0	1,980.0
A	NR: QPSK	NR: 40.0 MHz	1,950.0	1,975.0



Remarks

1. Bandedge data was captured from the transmit port with maximum measured power.
2. Worst case bandedge data presented.



Antenna C - Modulation LTE: QPSK - NR / LTE Carrier Bandwidth LTE: 5.0 MHz - Channel Position B



Antenna C - Modulation LTE: QPSK - NR / LTE Carrier Bandwidth LTE: 5.0 MHz - Channel Position T





Antenna C - Modulation LTE: QPSK - NR / LTE Carrier Bandwidth LTE: 10.0 MHz - Channel Position B



Antenna C - Modulation LTE: QPSK - NR / LTE Carrier Bandwidth LTE: 10.0 MHz - Channel Position T





Antenna C - Modulation LTE: QPSK - NR / LTE Carrier Bandwidth LTE: 15.0 MHz - Channel Position B



Antenna C - Modulation LTE: QPSK - NR / LTE Carrier Bandwidth LTE: 15.0 MHz - Channel Position T





Antenna C - Modulation LTE: QPSK - NR / LTE Carrier Bandwidth LTE: 20.0 MHz - Channel Position B

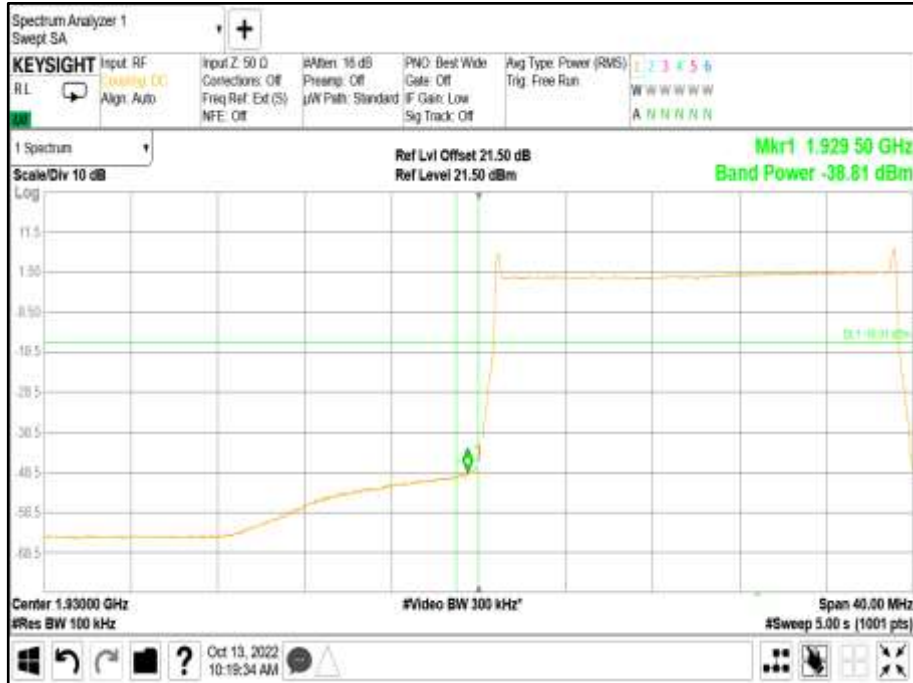

Antenna C - Modulation LTE: QPSK - NR / LTE Carrier Bandwidth LTE: 20.0 MHz - Channel Position T





Antenna C - Modulation NR: QPSK - NR / LTE Carrier Bandwidth NR: 5.0 MHz - Channel Position B



Antenna C - Modulation NR: QPSK - NR / LTE Carrier Bandwidth NR: 5.0 MHz - Channel Position T





Antenna C - Modulation NR: QPSK - NR / LTE Carrier Bandwidth NR: 10.0 MHz - Channel Position B



Antenna C - Modulation NR: QPSK - NR / LTE Carrier Bandwidth NR: 10.0 MHz - Channel Position T





Antenna C - Modulation NR: QPSK - NR / LTE Carrier Bandwidth NR: 15.0 MHz - Channel Position B



Antenna C - Modulation NR: QPSK - NR / LTE Carrier Bandwidth NR: 15.0 MHz - Channel Position T





Antenna C - Modulation NR: QPSK - NR / LTE Carrier Bandwidth NR: 20.0 MHz - Channel Position B



Antenna C - Modulation NR: QPSK - NR / LTE Carrier Bandwidth NR: 20.0 MHz - Channel Position T





Antenna C - Modulation NR: QPSK - NR / LTE Carrier Bandwidth NR: 25.0 MHz - Channel Position B



Antenna C - Modulation NR: QPSK - NR / LTE Carrier Bandwidth NR: 25.0 MHz - Channel Position T





Antenna C - Modulation NR: QPSK - NR / LTE Carrier Bandwidth NR: 30.0 MHz - Channel Position B



Antenna C - Modulation NR: QPSK - NR / LTE Carrier Bandwidth NR: 30.0 MHz - Channel Position T





Antenna C - Modulation NR: QPSK - NR / LTE Carrier Bandwidth NR: 40.0 MHz - Channel Position B

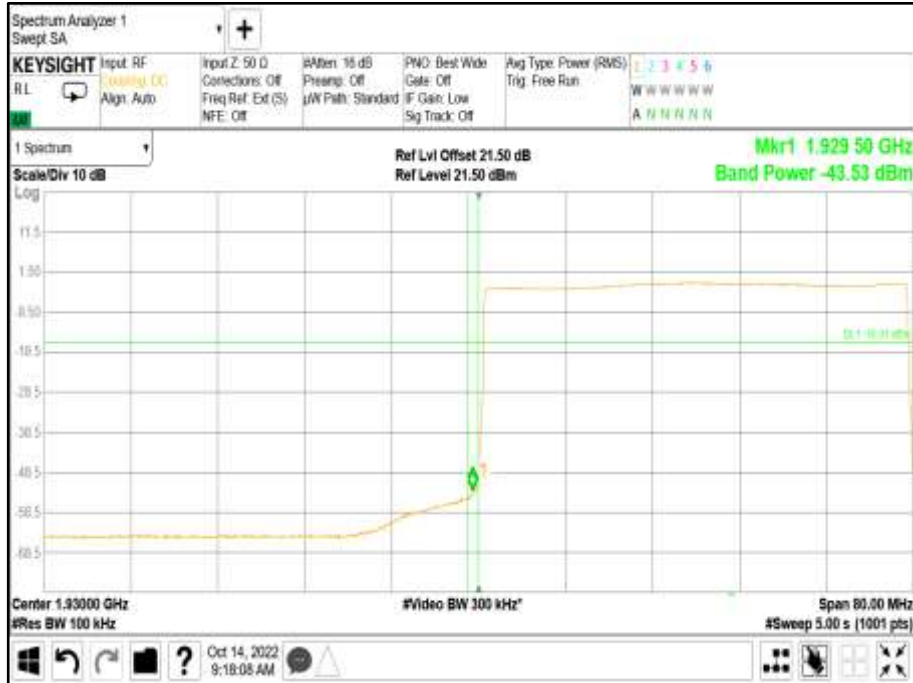

Antenna C - Modulation NR: QPSK - NR / LTE Carrier Bandwidth NR: 40.0 MHz - Channel Position T





Configuration B

Maximum Output Power 23.00 dBm / Port

Antenna	NR / LTE Modulation	NR / LTE Carrier Bandwidth	Band Edge (MHz)	
			Channel Position B	Channel Position T
C	LTE: QPSK	5.0+5.0 MHz	1932.5+1937.5	1987.5+1992.5
C	LTE: QPSK	20.0+20.0 MHz	1940 +1960	1985 + 1965
C	NR: QPSK	5.0+5.0 MHz	1932.5+1937.5	1987.5+1992.5
C	NR: QPSK	30.0+30.0 MHz	1945 + 1975	1950 + 1980
C	LTE + NR QPSK	5.0+5.0 MHz	1932.5+1937.5	1987.5+1992.5
C	LTE + NR (NC) QPSK	5.0+5.0 MHz	1932.5+1992.5	1932.5+1992.5

Remarks

Two carrier transmitter performance is presented. The plot results represent typical radio performance. Plot data performance for all transmitter ports and channels are on file and available on request.



Antenna C - Modulation LTE: QPSK - NR / LTE Carrier Bandwidth 5.0+5.0 MHz - Channel Position B



Antenna C - Modulation LTE: QPSK - NR / LTE Carrier Bandwidth 5.0+5.0 MHz - Channel Position T





Antenna C - Modulation LTE: QPSK - NR / LTE Carrier Bandwidth 20.0+20.0 MHz - Channel Position B



Antenna C - Modulation LTE: QPSK - NR / LTE Carrier Bandwidth 20.0+20.0 MHz - Channel Position T





Antenna C - Modulation NR: QPSK - NR / LTE Carrier Bandwidth 5.0+5.0 MHz - Channel Position B



Antenna C - Modulation NR: QPSK - NR / LTE Carrier Bandwidth 5.0+5.0 MHz - Channel Position T





Antenna C - Modulation NR: QPSK - NR / LTE Carrier Bandwidth 30.0+30.0 MHz - Channel Position B



Antenna C - Modulation NR: QPSK - NR / LTE Carrier Bandwidth 30.0+30.0 MHz - Channel Position T





Antenna C - Modulation LTE + NR QPSK - NR / LTE Carrier Bandwidth 5.0+5.0 MHz - Channel Position B



Antenna C - Modulation LTE + NR QPSK - NR / LTE Carrier Bandwidth 5.0+5.0 MHz - Channel Position T





Antenna C - Modulation LTE + NR (NC) QPSK - NR / LTE Carrier Bandwidth 5.0+5.0 MHz - Channel Position B

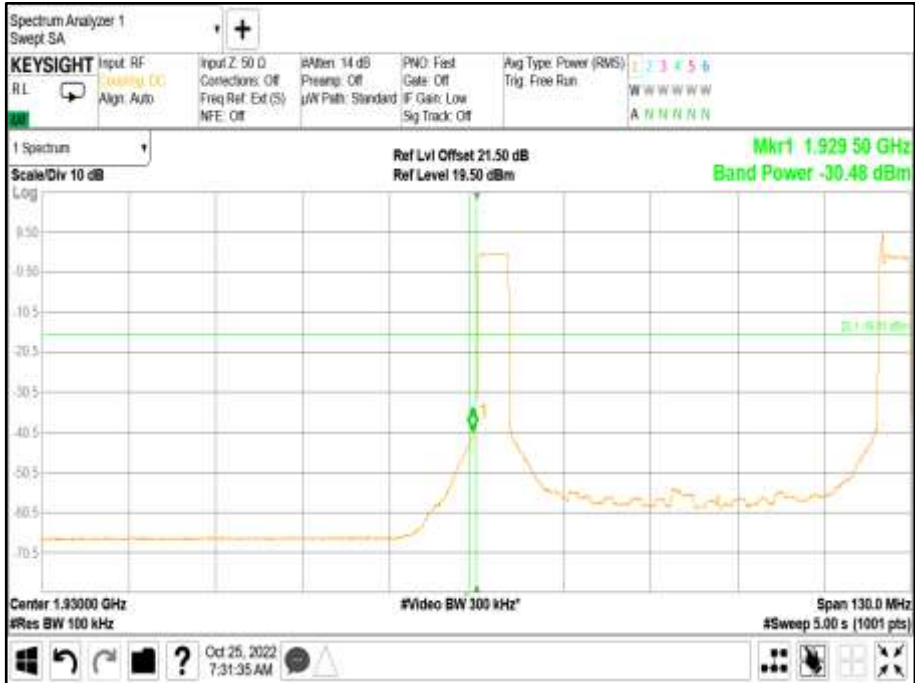

Antenna C - Modulation LTE + NR (NC) QPSK - NR / LTE Carrier Bandwidth 5.0+5.0 MHz - Channel Position T

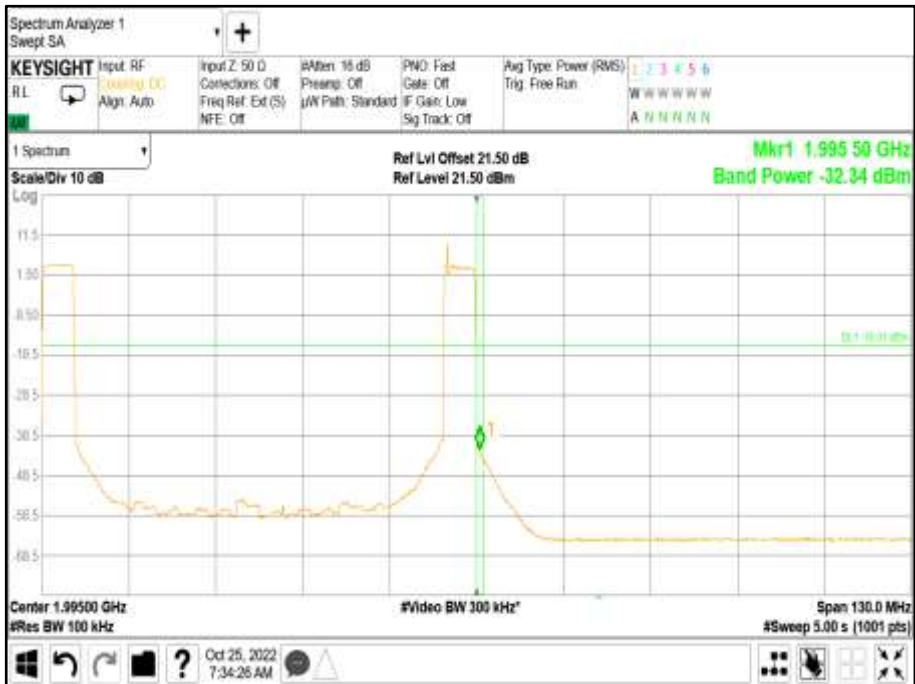



Configuration C

Maximum Output Power 23.00 dBm

Antenna	NR / LTE Modulation	NR / LTE Carrier Bandwidth	Band Edge (MHz)	
			Channel Position B	Channel Position T
C	LTE: QPSK	5.0+5.0+5.0+5.0+5.0+5.0 MHz	1932.5+1937.5+1942.5+1947.5+1952.5+1957.5	1967.5+1972.5+1977.5+1982.5+1987.5+1992.5
C	LTE: QPSK	10.0+10.0+10.0+10.0+10.0+10.0 MHz	1935.0+1945.0+1955.0+1965.0+1975.0+1985.0	1940.0+1950.0+1960.0+1970.0+1980.0+1990.0
C	NR: QPSK	5.0+5.0+5.0+5.0+5.0+5.0 MHz	1932.5+1937.5+1942.5+1947.5+1952.5+1957.5	1967.5+1972.5+1977.5+1982.5+1987.5+1992.5
C	NR: QPSK	10.0+10.0+10.0+10.0+10.0+10.0 MHz	1935.0+1945.0+1955.0+1965.0+1975.0+1985.0	1940.0+1950.0+1960.0+1970.0+1980.0+1990.0
C	LTE + NR QPSK	5.0+5.0+5.0+5.0+5.0+5.0 MHz	1932.5+1937.5+1942.5+1947.5+1952.5+1957.5	1967.5+1972.5+1977.5+1982.5+1987.5+1992.5
C	LTE + NR (NC) QPSK	5.0+5.0+5.0+5.0+5.0+5.0 MHz	1932.5+1937.5+1942.5+1982.5+1987.5+1992.5	1932.5+1937.5+1942.5+1982.5+1987.5+1992.5

Remarks

Six carrier transmitter performance is presented. The plot results represent typical radio performance. Plot data performance for all transmitter ports and channels are on file and available on request.



Antenna C - Modulation LTE: QPSK - NR / LTE Carrier Bandwidth 5.0+5.0+5.0+5.0+5.0+5.0 MHz - Channel Position B



Antenna C - Modulation LTE: QPSK - NR / LTE Carrier Bandwidth 5.0+5.0+5.0+5.0+5.0+5.0 MHz - Channel Position T





Antenna C - Modulation LTE: QPSK - NR / LTE Carrier Bandwidth
10.0+10.0+10.0+10.0+10.0+10.0 MHz - Channel Position B



Antenna C - Modulation LTE: QPSK - NR / LTE Carrier Bandwidth
10.0+10.0+10.0+10.0+10.0+10.0 MHz - Channel Position T





Antenna C - Modulation NR: QPSK - NR / LTE Carrier Bandwidth 5.0+5.0+5.0+5.0+5.0+5.0 MHz - Channel Position B



Antenna C - Modulation NR: QPSK - NR / LTE Carrier Bandwidth 5.0+5.0+5.0+5.0+5.0+5.0 MHz - Channel Position T





Antenna C - Modulation NR: QPSK - NR / LTE Carrier Bandwidth
10.0+10.0+10.0+10.0+10.0+10.0 MHz - Channel Position B



Antenna C - Modulation NR: QPSK - NR / LTE Carrier Bandwidth
10.0+10.0+10.0+10.0+10.0+10.0 MHz - Channel Position T





Antenna C - Modulation LTE + NR QPSK - NR / LTE Carrier Bandwidth
5.0+5.0+5.0+5.0+5.0 MHz - Channel Position B



Antenna C - Modulation LTE + NR QPSK - NR / LTE Carrier Bandwidth
5.0+5.0+5.0+5.0+5.0 MHz - Channel Position T





Antenna C - Modulation LTE + NR (NC) QPSK - NR / LTE Carrier Bandwidth
5.0+5.0+5.0+5.0+5.0 MHz - Channel Position B



Antenna C - Modulation LTE + NR (NC) QPSK - NR / LTE Carrier Bandwidth
5.0+5.0+5.0+5.0+5.0 MHz - Channel Position T

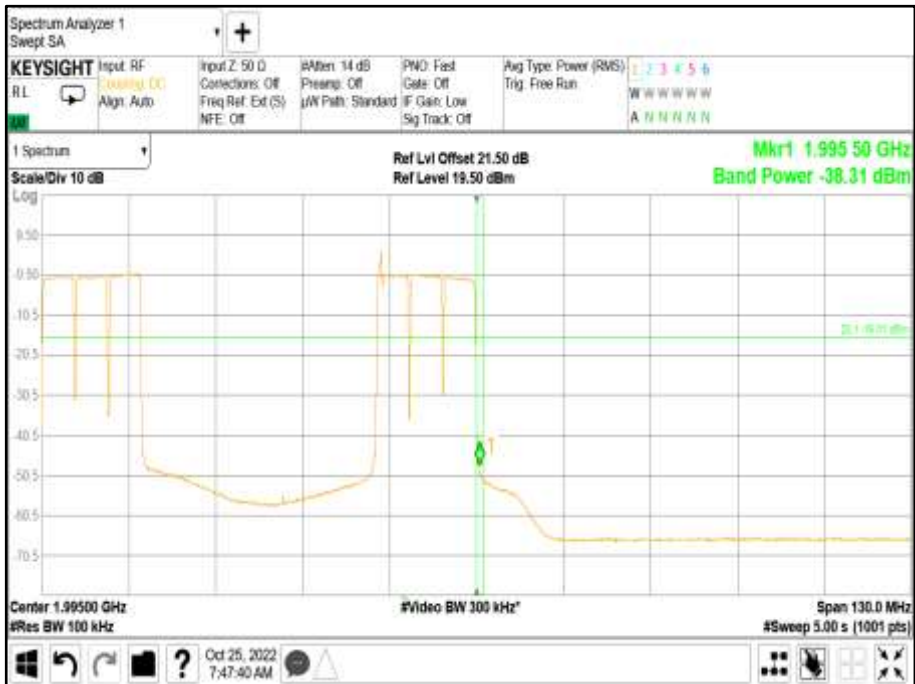

Limit	-16 dBm
-------	---------



2.4 TRANSMITTER SPURIOUS EMISSIONS

2.4.1 Specification Reference

FCC CFR 47 Part 24, Clause 24.238 (a)
FCC CFR 47 Part 2, Clause 2.1051

2.4.2 Date of Test and Modification State

07, 12 and 13-October-2022 - Modification State 0

2.4.3 Test Equipment Used

The major items of test equipment used for the above tests are identified in Section 3.1.

2.4.4 Environmental Conditions

Ambient Temperature	32.0°C
Relative Humidity	22.1 - 23.0%

2.4.5 Test Method

All measurements were made in accordance with FCC KDB 971168 D01, Clause 6.1.

Each antenna port has been declared as being equivalent, therefore measurements were made on one antenna port only. To account for this, the limit was tightened by $10 * \text{Log}(N)$, where N is equal to the number of MIMO antenna ports.

For dual port, the limit was calculated as being $-13 \text{ dBm} - 10 * \text{Log}(2) = -16 \text{ dBm}$.

2.4.6 Test Results

Configuration A

Maximum Output Power 23.00 dBm / Port

Remarks

1. Transceiver spurious emissions have been searched for all channel bandwidths and antenna ports.
2. Representative worst-case spurious emissions performance has been presented for all modulations.
3. Plot data performance for all transmitter ports, channel bandwidths, and channel positions are on file and available on request.



Antenna C - Modulation LTE: QPSK - NR / LTE / WCDMA Carrier Bandwidth 5.0 MHz - Channel Position B - Band 1 Range 0.009 to 4000 MHz

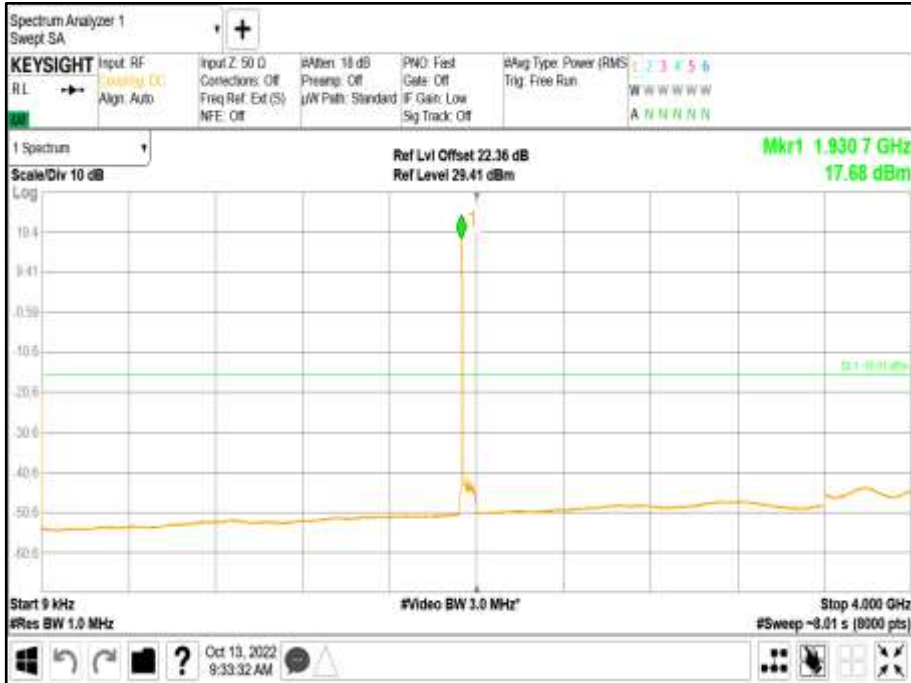

Antenna C - Modulation LTE: QPSK - NR / LTE / WCDMA Carrier Bandwidth 5.0 MHz - Channel Position B - Band 2 - Range 4000 to 12000 MHz

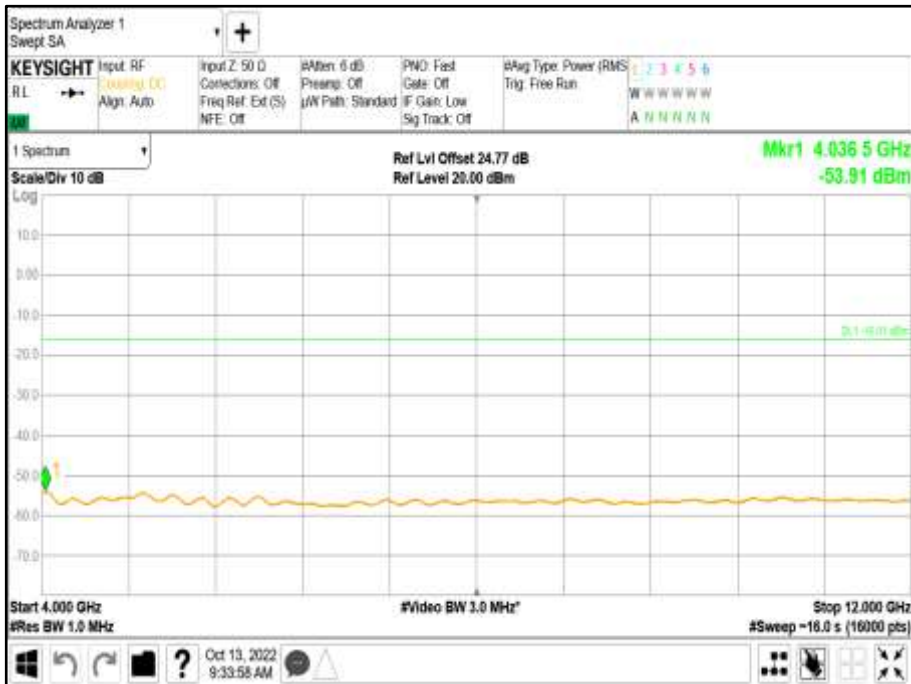



Antenna C - Modulation LTE: QPSK - NR / LTE / WCDMA Carrier Bandwidth 5.0 MHz - Channel Position B - Band 3 - Range 12000 to 20000 MHz



Antenna C - Modulation NR: QPSK - NR / LTE / WCDMA Carrier Bandwidth 5.0 MHz - Channel Position B - Band 1 - Range 0.009 to 4000 MHz





Antenna C - Modulation NR: QPSK - NR / LTE / WCDMA Carrier Bandwidth 5.0 MHz - Channel Position B - Band 2 - Range 4000 to 12000 MHz

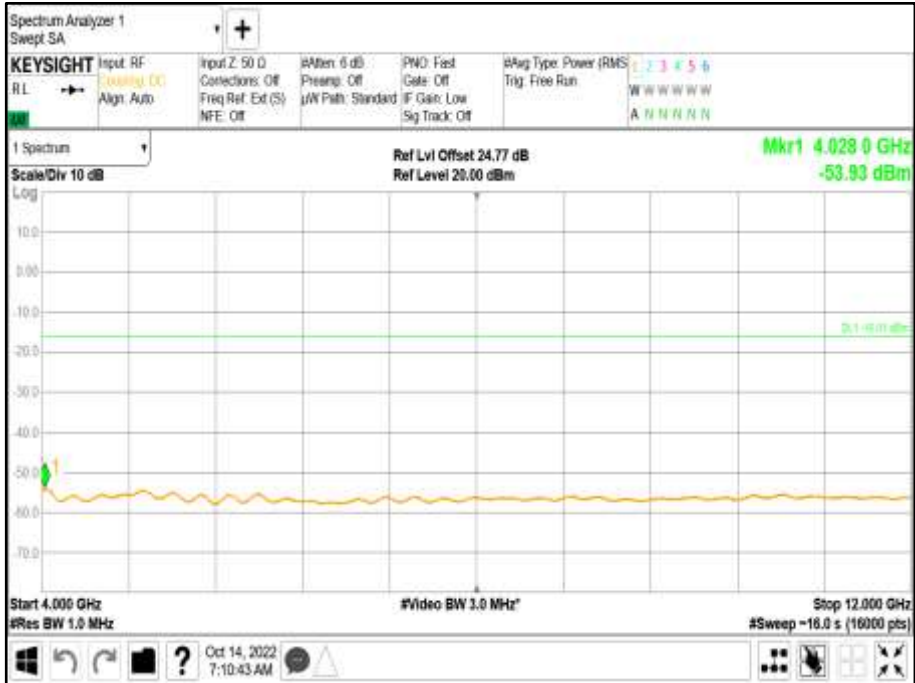

Antenna C - Modulation NR: QPSK - NR / LTE / WCDMA Carrier Bandwidth 5.0 MHz - Channel Position B - Band 3 - Range 12000 to 20000 MHz





Configuration B

Maximum Output Power 23.00 dBm / Port

Remarks

1. Spurious emissions have been searched for all channel bandwidths and antenna ports.
2. Representative spurious emissions performance has been presented for all modulations.
3. Plot data performance for all transmitter ports, channel bandwidths, and channel positions are on file and available on request.

Antenna C - Modulation LTE: QPSK - NR / LTE Carrier Bandwidth 5.0 MHz - Channel Position B - Band 1 - Range 0.009 to 4000 MHz





Antenna C - Modulation LTE: QPSK - NR / LTE Carrier Bandwidth 5.0 MHz - Channel Position B - Band 2 - Range 4000 to 12000 MHz

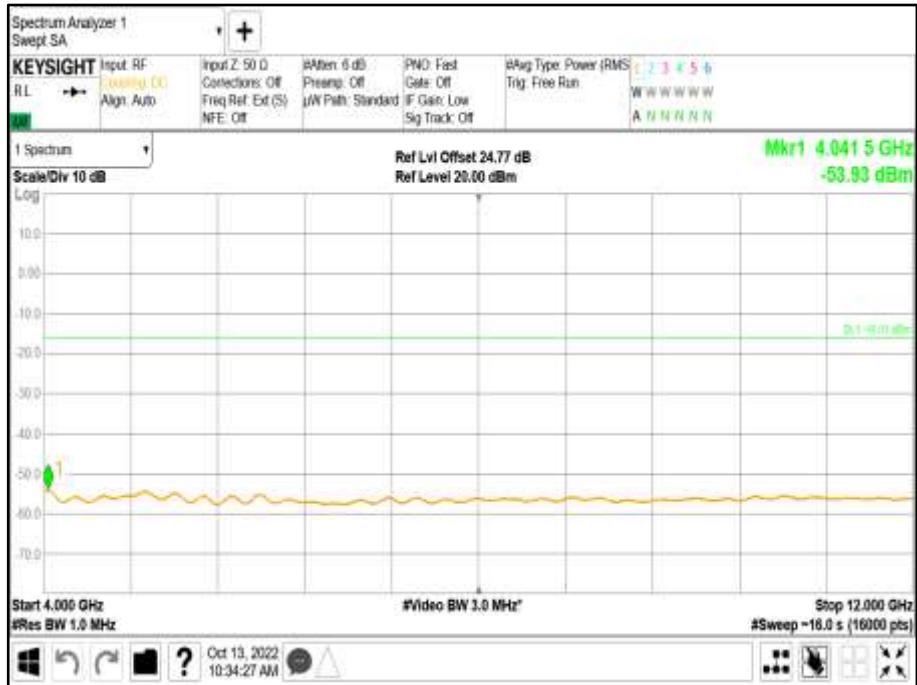

Antenna C - Modulation LTE: QPSK - NR / LTE Carrier Bandwidth 5.0 MHz - Channel Position B - Band 3 - Range 12000 to 20000 MHz





Antenna C - Modulation NR: QPSK - NR / LTE Carrier Bandwidth 5.0 MHz - Channel Position B - Band 1 - Range 0.009 to 4000 MHz



Antenna C - Modulation NR: QPSK - NR / LTE Carrier Bandwidth 5.0 MHz - Channel Position B - Band 2 - Range 4000 to 12000 MHz

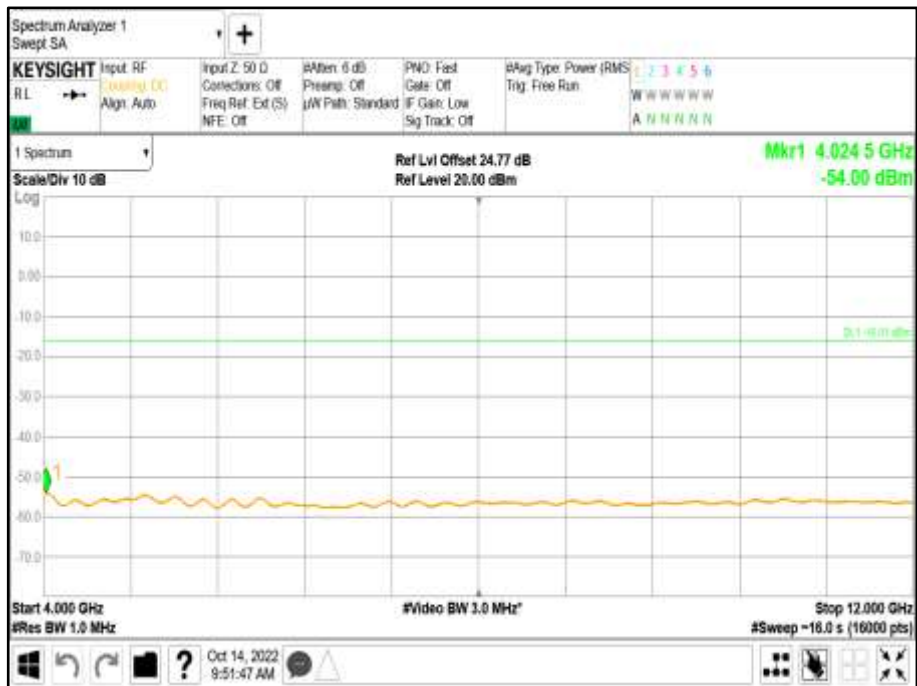



Antenna C - Modulation NR: QPSK - NR / LTE Carrier Bandwidth 5.0 MHz - Channel Position B
- Band 3 - Range 12000 to 20000 MHz





Antenna C - Modulation LTE+NR (NC): QPSK - NR / LTE Carrier Bandwidth 5.0 MHz - Channel Position B - Band 1- Range 0.009 to 4000 MHz



Antenna C - Modulation LTE+NR (NC): QPSK - NR / LTE Carrier Bandwidth 5.0 MHz - Channel Position B - Band 2 - Range 4000 to 12000 MHz

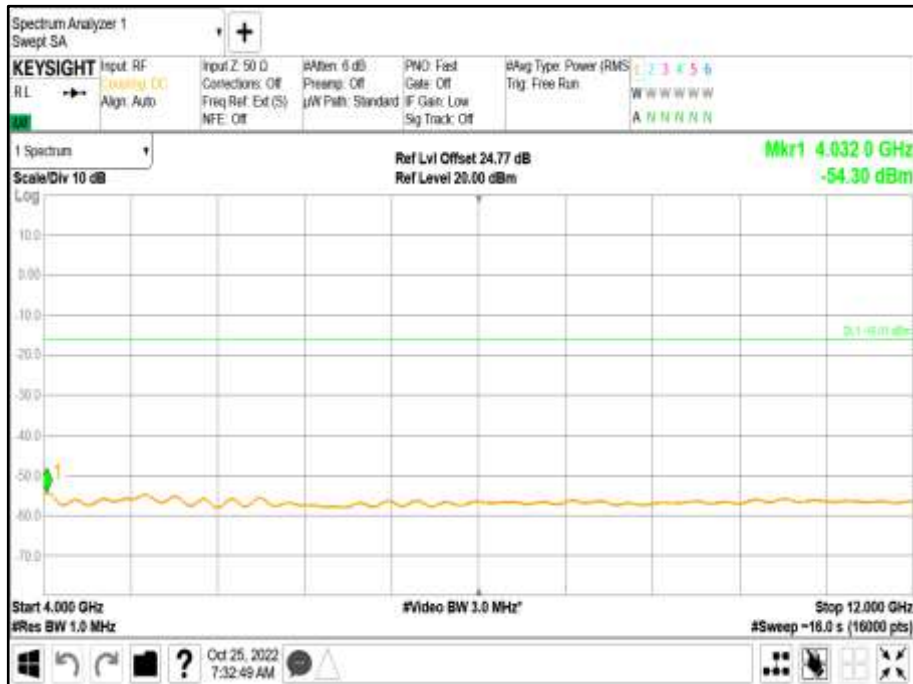



Antenna C - Modulation LTE+NR (NC): QPSK - NR / LTE Carrier Bandwidth 5.0 MHz - Channel Position B - Band 3 - Range 12000 to 20000 MHz



Configuration C

Maximum Output Power 23.00 dBm / Port

Remarks

1. Spurious emissions have been searched for all channel bandwidths and antenna ports.
2. Representative spurious emissions performance has been presented for all modulations.
3. Plot data performance for all transmitter ports, channel bandwidths, and channel positions are on file and available on request.



Antenna C - Modulation LTE: QPSK - NR / LTE Carrier Bandwidth 5.0+5.0+5.0+5.0+5.0+5.0 MHz - Channel Position B - Band 1 - Range 0.009 to 4000 MHz

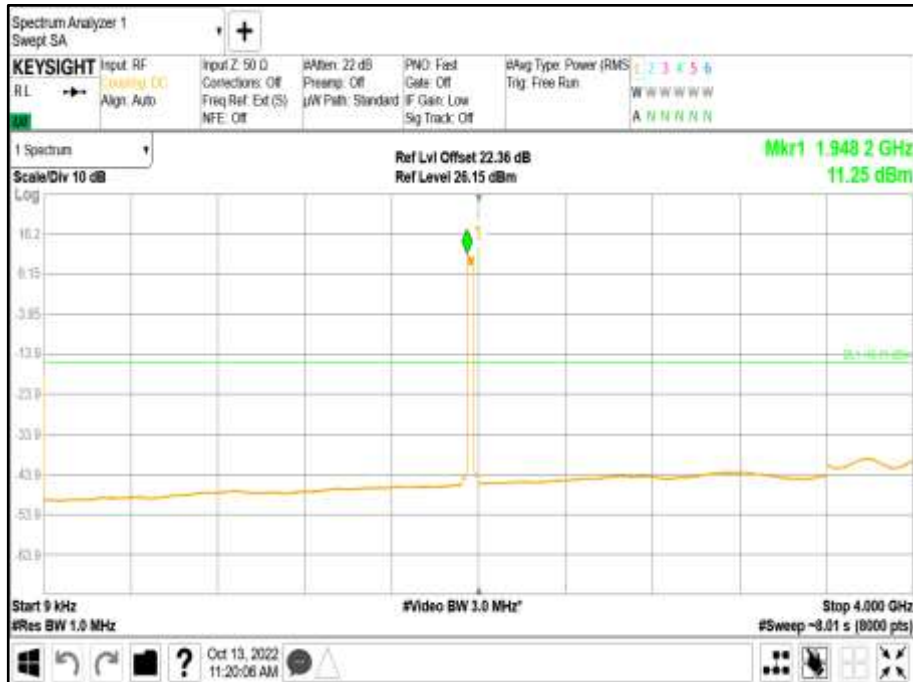

Antenna C - Modulation LTE: QPSK - NR / LTE Carrier Bandwidth 5.0+5.0+5.0+5.0+5.0+5.0 MHz - Channel Position B - Band 2 - Range 4000 to 12000 MHz

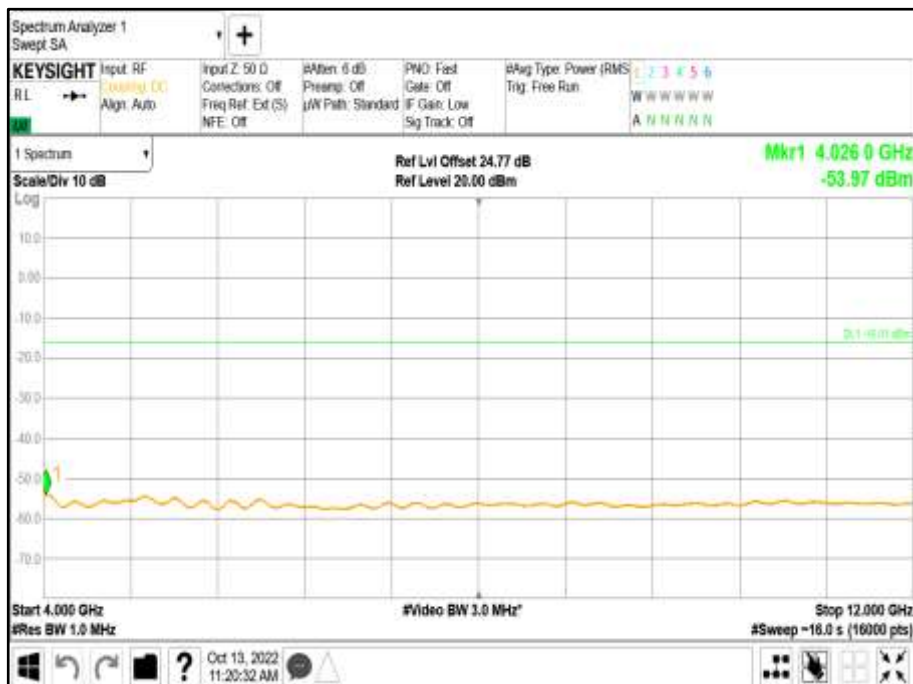



Antenna C - Modulation LTE: QPSK - NR / LTE Carrier Bandwidth 5.0+5.0+5.0+5.0+5.0+5.0 MHz - Channel Position B - Band 3 - Range 12000 to 20000 MHz



Antenna C - Modulation NR: QPSK - NR / LTE Carrier Bandwidth 5.0+5.0+5.0+5.0+5.0+5.0 MHz - Channel Position B - Band 1 - Range 0.009 to 4000 MHz





Antenna C - Modulation NR: QPSK - NR / LTE Carrier Bandwidth 5.0+5.0+5.0+5.0+5.0+5.0 MHz - Channel Position B - Band 2 - Range 4000 to 12000 MHz

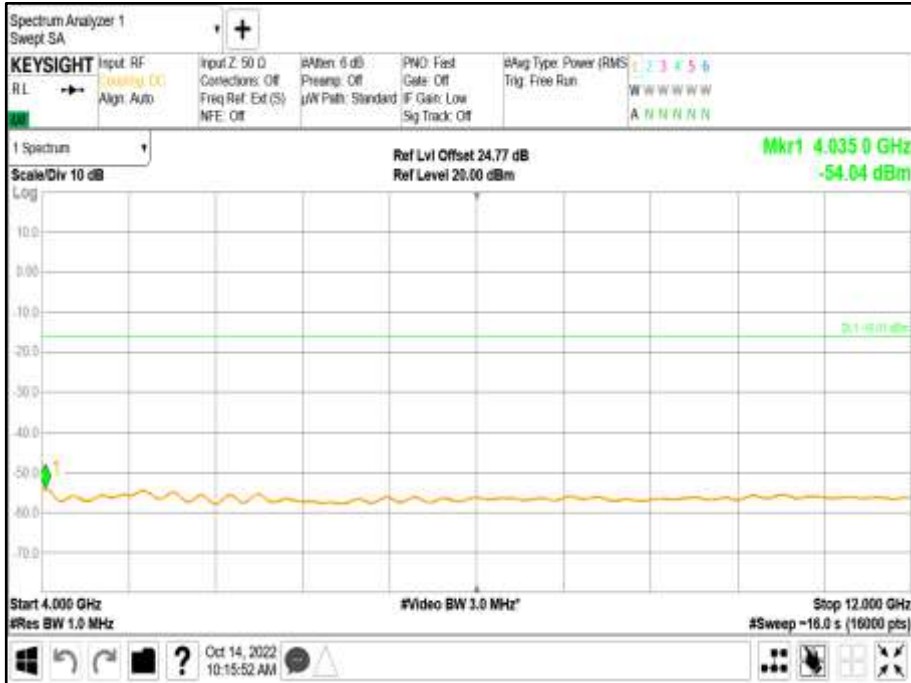

Antenna C - Modulation NR: QPSK - NR / LTE Carrier Bandwidth 5.0+5.0+5.0+5.0+5.0+5.0 MHz - Channel Position B - Band 3 - Range 12000 to 20000 MHz





Antenna C - Modulation LTE+NR (NC): QPSK - NR / LTE Carrier Bandwidth
5.0+5.0+5.0+5.0+5.0+5.0 MHz - Channel Position B - Band 1 - Range 0.009 to 4000 MHz



Antenna C - Modulation LTE+NR (NC): QPSK - NR / LTE Carrier Bandwidth
5.0+5.0+5.0+5.0+5.0+5.0 MHz - Channel Position B - Band 2 - Range 4000 to 12000 MHz

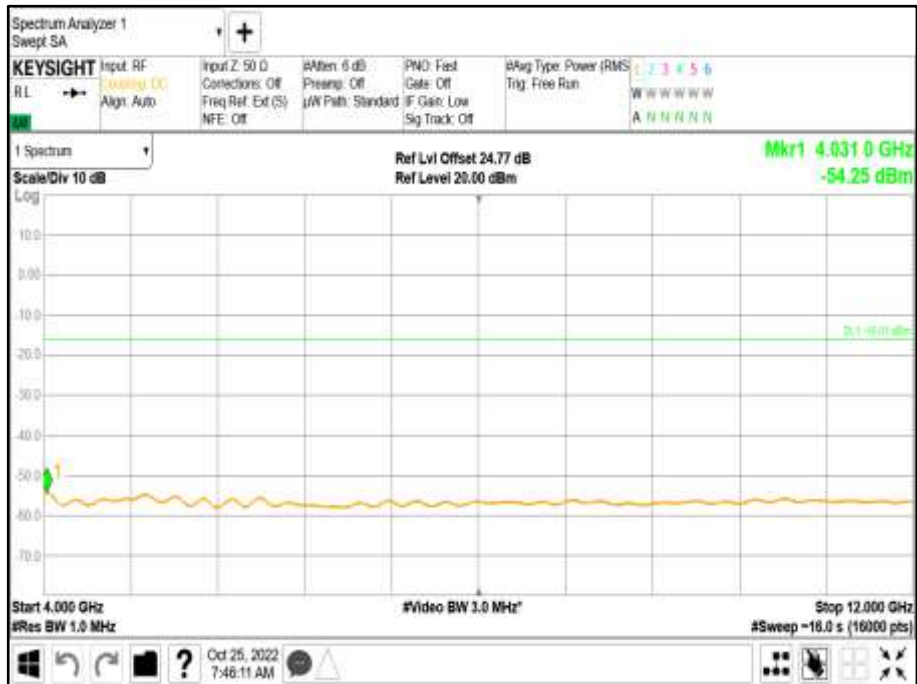



Antenna C - Modulation LTE+NR (NC): QPSK - NR / LTE Carrier Bandwidth
5.0+5.0+5.0+5.0+5.0+5.0 MHz - Channel Position B - Band 3 - Range 12000 to 20000 MHz



Limit	-16 dBm
-------	---------



2.5 FREQUENCY STABILITY

2.5.1 Specification Reference

FCC CFR 47 Part 2, Clause 2.1051

2.5.2 Date of Test and Modification State

6-October-2022 - Modification State 0

2.5.3 Test Equipment Used

The major items of test equipment used for the above tests are identified in Section 3.1.

2.5.4 Environmental Conditions

Ambient Temperature 24.6°C
Relative Humidity 30.8%

2.5.5 Test Method

All measurements were made in accordance with FCC KDB 971168 D01, Clause 9 and ANSI C63.26 Clause 5.6

2.5.6 Test Results

Configuration A

Temperature	Voltage	Frequency Error (Hz)
		Channel Position M (1 962 500 000 Hz)
-30°C	-48.0 V DC	Turns OFF
-20°C	-48.0 V DC	Turns OFF
-10°C	-48.0 V DC	1.5717
0°C	-48.0 V DC	-2.0136
+10°C	-48.0 V DC	1.2222
+20°C	-40.5 V DC	-1.3544
+20°C	-48.0 V DC	1.8616
+20°C	-57.5 V DC	-1.7002
+30°C	-48.0 V DC	2.2516
+40°C	-48.0 V DC	2.1063
+50°C	-48.0 V DC	-1.6846

Remarks

Worst Case deviation at 2.2516 Hz = 0.001147 ppm



SECTION 3

TEST EQUIPMENT USED



3.1 TEST EQUIPMENT USED

List of absolute measuring and other principal items of test equipment.

Instrument	Manufacturer	Type No.	TE No.	Calibration Period (months)	Calibration Due
Spectrum Analyzer	Keysight	PXA N9030B	MY57144347	12	25/03/2023
Thermometer / Refrigeration	VWR	89094-746	210697579	24	13/08/2023
PSU	Xantrex	XKW60-50	E00109862	-	O/P Mon
Attenuator (20dB)	Mini-Circuits	BW-K10-2W44+	-	-	O/P Mon
Switching Control Unit	HP	11713A	3748A060876	-	O/P Mon
Climate Chamber	Burnsco	RTC-37P-3-3	-07-07	-	O/P Mon

O/P Mon – Output Monitored with Calibrated Equipment



3.2 MEASUREMENT UNCERTAINTY

For a 95% confidence level, the measurement uncertainties for defined systems are:-

Test Discipline	Frequency / Parameter	MU	
Conducted Maximum Peak Output Power	30 MHz to 20 GHz Amplitude	± 0.7 dB	
Conducted Emissions	30 MHz to 20 GHz Amplitude	± 2.1 dB	
Frequency Stability	30 MHz to 2 GHz	± 5.0 Hz	
Occupied Bandwidth	Up to 20 MHz Bandwidth	5 MHz Bandwidth	± 11547 Hz
		10 MHz Bandwidth	± 23094 Hz
		15 MHz Bandwidth	± 34641 Hz
		20 MHz Bandwidth	± 46188 Hz
Band Edge	30 MHz to 20 GHz Amplitude	±0.8 dB	
Radiated Spurious Emissions	30 MHz to 1 GHz	± 5.2 dB	
	1 GHz to 40GHz	± 6.3 dB	

Measurement Uncertainty Decision Rule

Determination of conformity with the specification limits is based on the results of the compliance measurement and does not take into account measurement instrumentation uncertainty as defined in ANSI C63.26:2015 Clause 1.3.

Risk: The uncertainty of measurement about the measured result is negligible with regard to the final pass/fail decision. The measurement result can be directly compared with the test limit to determine conformance with the requirement (compare IEC Guide 115). The level of risk to falsely accept and falsely reject items is further described in ILAC-G8



SECTION 4

ACCREDITATION, DISCLAIMERS AND COPYRIGHT



4.1 ACCREDITATION, DISCLAIMERS AND COPYRIGHT



This report relates only to the actual item/items tested.

Our A2LA Accreditation does not cover opinions and interpretations and any expressed are outside the scope of our A2LA Accreditation.

© 2022 TÜV SÜD
TÜV SÜD
TUV SUD Canada, 1280 Teron Rd., Kanata On.

ANNEX A

MODULE LIST

Configuration A/B/C			
Product	Product No	R-State	Serial No
DOT 4465 B77DB25B66 (EUT)	KRY 901 523/2	R1A modified as R1B	TD3W340089
CT11	LPC 102 494/1	R2A	T01G495060
IRU 1648	KRC 161 842/1	R1D	TD3F105259
IRU 1649	KRC 161 842/2	R1E	TD3F109016
Software Version:	CXP 203 0045/26	Revision:	R14BX12