



Radiated Emissions Test Report
for
DOT 44Kr B48 (KRY 901 516/3) and DOT 41Kr B48 (KRY 901 516/4)
(Contiguous & non- Contiguous modes)

Tested to: FCC Part 15 Subpart B (Class B)
FCC Part 96 (Section – 96.41 e) 2))

FCC ID: TA8AKRY901516-4

Test Result summary

FCC/ ICES Section	Description	Specification/Method	Pass or Fail	Results in section
15.109 / 6.2	Radiated Emissions (RE)	FCC Part 15 / ANSI C63.4	Pass	3.2
15.107 / 6.1	Conducted Emissions (CE) for AC Power	FCC Part 15 / ANSI C63.4	NA	NA
96.41 e) 2)	Additional protection levels (RE)	FCC Part 96 / ANSI C63.26	Pass	3.2

Document number: 7169010768-TR-EMC-06-01-F15

Release date: 24 June 2022

Prepared for: Ericsson Canada



About this document

This document is written and distributed by TÜV SÜD Canada Inc. Whenever TÜV SÜD is mentioned in this document it shall be taken as referring to TÜV SÜD Canada Inc.

This test report does not imply product endorsement by any government, accreditation agency, or TÜV SÜD Canada Inc. Opinions or interpretations expressed in this report, if any, are outside the scope of the accreditations of TÜV SÜD Canada Inc. Any opinions expressed do not necessarily reflect the opinions of TÜV SÜD Canada Inc, unless otherwise stated.

Throughout this document:

- text in **blue** font is a clickable link
- text in *italics* is provided as-is from the customer

The release control record, document approvals, and laboratory Accreditations are as follows.

Release control record

This document is based on document template KG000347-TR-EMC-08-03.

Issue	Reason for change	Date released
02	initial release	14 April 2022
05	Re issue with FCC ID (For Dot 41Kr (KRY 901 516/4)	24 June 2022

Approvals

Function	Name	Job title	Signature
Technical Reviewer	Scott Drysdale	Canada Wireless Manager	
Author	Kasi Sivaratnam	EMC Test Engineer	

Accreditations

The test facilities of TÜV SÜD Canada Inc are accredited by the American Association for Laboratory Accreditation (A2LA) to ISO/IEC 17025:2017 in accordance with the scope of accreditation outlined at the website portal.a2la.org/scopepdf/2955-19.pdf.

 A2LA Cert. No. 2955.19	DISCLAIMER AND COPYRIGHT <p>This non-binding report has been prepared by TÜV SÜD Canada with all reasonable skill and care. The document is confidential to the potential Client and TÜV SÜD Canada. No part of this document may be reproduced without the prior written approval of TÜV SÜD Canada.</p> <p>© TÜV SÜD.</p>
	ACCREDITATION <p>Our A2LA Accreditation does not cover opinions and interpretations and any expressed are outside the scope of our A2LA Accreditation.</p>

The Canadian lab registration number associated with the TÜV SÜD test facilities is 24015.

Test lab information

Lab name	TÜV SÜD Canada Inc
Company name	TÜV SÜD Canada Inc
Mailing or shipping address	1280 Teron Road, Ottawa, Ontario, K2K 2C1, Canada
Primary technical contact	Scott Drysdale
Title	Canada Wireless Manager
Phone	613-218-1841

Customer information

Company name	Ericsson Canada
Mailing address	349 Terry Fox Drive, Ottawa, On, K2K 2V6, Canada
Primary contact	Denis Lalonde
Title	Team Leader RA Verification
Phone	613-790-2901
E-mail	Denis.lalonde@ericsson.com



Table of contents

About this document	2
1. Executive summary	8
1.1 Compliance summary	9
2. Details of the equipment under test	10
2.1 Assessed hardware	10
2.2 Product overview	10
2.3 Product port definition and EUT cable information	13
2.4 Configurations of the EUT.....	14
2.4.1 Configuration 1: Dot 41Kr B48 with IRU 1648 (contiguous mode).....	14
2.4.1.1 Radiated Emissions Single RAT/Single Carrier Configurations (LTE) – Cfg 1.....	15
2.4.1.2 Radiated Emissions Single RAT / Single Carrier Configurations (NR) – Cfg 1	16
2.4.1.3 Radiated Emissions Single RAT / Multi Carriers Configurations (LTE) – Cfg 1	17
2.4.1.4 Radiated Emissions Multi RAT/Multi Carrier Configuration (LTE+NR) – Cfg 1	18
2.4.2 Configuration 2: Dot 41Kr B48 with IRU 1649 (non-contiguous mode).....	19
2.4.2.1 Radiated Emissions Single RAT/Single Carrier Configuration (LTE) – Cfg 2	19
2.4.2.2 Radiated Emissions Single RAT/ Multi Carrier Configuration (LTE) – Cfg 2.....	20
2.4.2.3 Radiated Emissions Multi RAT/Multi Carrier Configuration (LTE + NR) – Cfg 2 ...	21
2.5 Modifications of the EUT during testing	21
2.6 Inventory of the EUT and support equipments.....	21
3. Detailed test results of Emissions	23
3.1 Measurement instrumentation.....	23
3.2 Radiated Emissions, E-field.....	24
3.2.1 Test specification and limits	24
3.2.2 Test procedure.....	24
3.2.3 Calculation of the compliance margin	26
3.2.4 Measurement uncertainties	26
3.2.5 Test results of RE – Single RAT / Carrier (LTE – Mid channel) – Cfg 1	27
3.2.6 Test results of RE – Single RAT / Carrier (LTE – Bot channel) – Cfg 1	32
3.2.7 Test results of RE – Single RAT / Carrier (LTE – Top channel) - Cfg 1	35
3.2.8 Test results of RE – Single RAT / Carrier (NR – Middle channel) – Cfg 1	38
3.2.9 Test results of RE – Single RAT / Multi Carrier (LTE – Mid channel) – Cfg 1	41
3.2.10 Test results of RE – (Multi RAT / Multi Carrier – Mid channel) – Cfg 1	44
3.2.11 Test results of RE – Single RAT / Carrier (LTE – Mid channel) – Cfg 2	47
3.2.12 Test results of RE – Single RAT / Multi Carrier (LTE) – Cfg 2	52
3.2.13 Test results of RE – (Multi RAT / Multi Carrier) – Cfg 2.....	55
3.2.14 Radiated Emissions test setup picture.....	58
3.2.15 Test equipment.....	59
3.2.16 Test conclusion	59



4. References 60
 4.1 Appendix A: Abbreviations 61

List of figures

Figure 1: The EUT with four Internal RF ports, Dot 44Kr B48 10
 Figure 2: The EUT with four external RF ports, Dot 41Kr B48..... 11
 Figure 3: Test configuration 1 for Emission tests (contiguous mode)..... 14
 Figure 4: Carrier detail – Single RAT /Single carrier (LTE)..... 15
 Figure 5: Tested carrier detail, Single RAT /Single carrier (LTE) – SC 1 15
 Figure 6: Carrier detail – Single RAT / Single carrier (NR)..... 16
 Figure 7: Carrier detail – Single RAT / Multi carrier (LTE) 17
 Figure 8: Carrier detail – MultiCarrier / Multi RAT Configuration 18
 Figure 9: Test configuration 2 for Emission tests (non-contiguous mode) 19
 Figure 10: Carrier detail – Single RAT/Single carrier Configuration 19
 Figure 11: Carrier detail – Single RAT / Multi carrier (LTE) 20
 Figure 12: Carrier detail – MultiCarrier / Multi RAT Configuration 21
 Figure 13: Setup of Radiated Emissions..... 25
 Figure 14: Plot of RE at 3 m – 30 to1000 MHz (SC, LTE – Mid channel) – Cfg 1 28
 Figure 15: Plot of RE at 3m from 1 to 10 GHz (SC, LTE – Mid channel) – Cfg 1..... 29
 Figure 16: Plot of RE at 3m from 10 to 18 GHz (SC, LTE – Mid channel) – Cfg 1..... 30
 Figure 17: Plot of RE at 1m from 18 to 26.5 GHz (SC, LTE – Mid channel) – Cfg 1..... 31
 Figure 18: Plot of RE at 1m from 26.5 to 40 GHz (SC, LTE – Mid channel) – Cfg 1..... 31
 Figure 19: Plot of RE at 3m from 1 to 10 GHz (SC, LTE – Bot channel) – Cfg 1..... 33
 Figure 20: Plot of RE at 3m from 10 to 18 GHz (SC, LTE – Bot channel) – Cfg 1..... 34
 Figure 21: Plot of RE at 3m from 1 to 10 GHz (SC, LTE – Top channel) – Cfg 1 36
 Figure 22: Plot of RE at 3m from 10 to 18 GHz (SC, LTE – Top channel) – Cfg 1 37
 Figure 23: Plot of RE at 3m from 1 to 10 GHz (SC, NR – Middle channel) – Cfg 1..... 39
 Figure 24: Plot of RE at 3m from 10 to 18 GHz (SC, NR – Middle channel) – Cfg 1..... 40
 Figure 25: Plot of RE at 3m from 1 to 10 GHz (MC, LTE – Mid channel) - Cfg 1 42
 Figure 26: Plot of RE at 3m from 10 to 18 GHz (MC, LTE – Mid channel) – Cfg 1 43
 Figure 27: Plot of RE at 3 m from 30 to 1000 MHz (MR (LTE + NR) – Mid channel) – Cfg 1 44
 Figure 28: Plot of RE at 3m from 1 to 10 GHz (MR (LTE + NR) – Mid channel) – Cfg 1 45
 Figure 29: Plot of RE at 3m from 10 to 18 GHz (MR (LTE + NR) – Mid channel) – Cfg 1 46
 Figure 30: Plot of RE at 3 m – 30 to1000 MHz (SC, LTE – Mid channel) – Cfg 2..... 48
 Figure 31: Plot of RE at 3m from 1 to 10 GHz (SC, LTE – Mid channel) – Cfg 2..... 49
 Figure 32: Plot of RE at 3m from 10 to 18 GHz (SC, LTE – Mid channel) – Cfg 2..... 50
 Figure 33: Plot of RE at 1m from 18 to 26.5 GHz (SC, LTE – Mid channel) – Cfg 2..... 51



Figure 34: Plot of RE at 1m from 26.5 to 40 GHz (SC, LTE – Mid channel) – Cfg 2..... 51
 Figure 35: Plot of RE at 3m from 1 to 10 GHz (MC, LTE) – Cfg 2 53
 Figure 36: Plot of RE at 3m from 10 to 18 GHz (MC, LTE) – Cfg 2 54
 Figure 37: Plot of RE at 3 m from 30 to 1000 MHz (MR (LTE + NR)) – Cfg 2 55
 Figure 38: Plot of RE at 3m from 1 to 10 GHz (MR (LTE + NR)) – Cfg 2 56
 Figure 39: Plot of RE at 3m from 10 to 18 GHz (MR (LTE + NR)) – Cfg 2..... 57
 Figure 40: Setup for RE tests 58

List of tables

Table 1: Summary of test results for the USA; FCC Part 15 subpart B 9
 Table 2: Summary of test results for the USA; FCC Part 96.41 e) 2) 9
 Table 3: Assessed hardware..... 10
 Table 4: DOT 41Kr B48 Product info 12
 Table 5: System port definition Dot 41Kr B48..... 13
 Table 6: Inventory of the EUT – Configuration 1 22
 Table 7: Inventory of the EUT – Configuration 2 22
 Table 8: RE test requirements..... 24
 Table 9: RE limits at 10 m for Class B of FCC 24
 Table 10: Emission limits for FCC Part 96 e) 2) 24
 Table 11: RE test results from 30 to 1000 MHz for FCC Part 15 (SC, LTE – Mid channel) – Cfg 1 28
 Table 12: RE test results from 30 to 1000 MHz for FCC Part 96 (SC, LTE – Mid channel) – Cfg 1 28
 Table 13: RE test results from 1 to 10 GHz for FCC Part 15 (SC, LTE – Mid channel) – Cfg 1 29
 Table 14: RE test results from 1 to 10 GHz for FCC Part 96 (SC, LTE – Mid channel) – Cfg 1 29
 Table 15: RE test results from 10 to 18 GHz for FCC Part 15 (SC, LTE – Mid channel) – Cfg 1 30
 Table 16: RE test results from 10 to 18 GHz for FCC Part 96 (SC, LTE – Mid channel) – Cfg 1 30
 Table 17: RE test results from 1 to 10 GHz for FCC Part 15 (SC, LTE – Bot channel) – Cfg 1 33
 Table 18: RE test results from 1 to 10 GHz for FCC Part 96 (SC, LTE – Bot channel) – Cfg 1 33
 Table 19: RE test results from 10 to 18 GHz for FCC Part 15 (SC, LTE – Bot channel) – Cfg 1 34
 Table 20: RE test results from 10 to 18 GHz FCC Part 96 (SC, LTE – Bot channel) – Cfg 1..... 34
 Table 21: RE test results from 1 to 10 GHz for FCC Part 15 (SC, LTE – Top channel) – Cfg 1 36
 Table 22: RE test results from 1 to 10 GHz for FCC Part 96 (SC, LTE – Top channel) – Cfg 1 36
 Table 23: RE test results from 10 to 18 GHz for FCC Part 15 (SC, LTE – Top channel) – Cfg 1 37
 Table 24: RE test results from 10 to 18 GHz for FCC Part 96 (SC, LTE – Top channel) – Cfg 1 37
 Table 25: RE test results from 1 to 10 GHz for FCC Part 15 (SC, NR – Middle channel) – Cfg 1 39
 Table 26: RE test results from 1 to 10 GHz for FCC Part 96 (SC, NR – Middle channel) – Cfg 1 39
 Table 27: RE test results from 10 to 18 GHz for FCC Part 15 (SC, NR – Middle channel) – Cfg 1 40
 Table 28: RE test results from 10 to 18 GHz FCC Part 96 (SC, NR – Middle channel) – Cfg 1..... 40



Table 29: RE test results from 1 to 10 GHz for FCC Part 15 (MC, LTE – Mid channel) – Cfg 1.....	42
Table 30: RE test results from 1 to 10 GHz for FCC Part 96 (MC, LTE – Mid channel) - Cfg 1	42
Table 31: RE test results from 10 to 18 GHz for FCC Part 15 (MC, LTE – Mid channel) – Cfg 1.....	43
Table 32: RE test results from 10 to 18 GHz FCC Part 96 (MC, LTE – Mid channel) – Cfg 1	43
Table 33: RE test results from 1 to 10 GHz for FCC Part 15 (MR (LTE + NR) – Mid channel) – Cfg 1	45
Table 34: RE test results from 1 to 10 GHz for FCC Part 96 (MR (LTE + NR) – Mid channel) – Cfg 1	45
Table 35: RE test results from 10 to 18 GHz for FCC Part 15 (MR (LTE + NR) – Mid ch) - Cfg 1.....	46
Table 36: RE test results from 10 to 18 GHz Part 96 (MR (LTE + NR) – Mid channel) – Cfg 1.....	46
Table 37: RE test results from 30 to 1000 MHz for FCC Part 15 (SC, LTE – Mid channel) – Cfg 2	48
Table 38: RE test results from 30 to 1000 MHz for FCC Part 96 (SC, LTE – Mid channel) – Cfg 2	48
Table 39: RE test results from 1 to 10 GHz for FCC Part 15 (SC, LTE – Mid channel) – Cfg 2	49
Table 40: RE test results from 1 to 10 GHz for FCC Part 96 (SC, LTE – Mid channel) – Cfg 2	49
Table 41: RE test results from 10 to 18 GHz for FCC Part 15 (SC, LTE – Mid channel) – Cfg 2	50
Table 42: RE test results from 10 to 18 GHz for FCC Part 96 (SC, LTE – Mid channel) – Cfg 2	50
Table 43: RE test results from 1 to 10 GHz for FCC Part 15 (MC, LTE) – Cfg 2.....	53
Table 44: RE test results from 1 to 10 GHz for FCC Part 96 (MC, LTE) – Cfg 2.....	53
Table 45: RE test results from 10 to 18 GHz for FCC Part 15 (MC, LTE) – Cfg 2.....	54
Table 46: RE test results from 10 to 18 GHz FCC Part 96 (MC, LTE) – Cfg 2.....	54
Table 47: RE test results from 1 to 10 GHz for FCC Part 15 (MR (LTE + NR)) – Cfg 2	56
Table 48: RE test results from 1 to 10 GHz for FCC Part 96 (MR (LTE + NR)) – Cfg 2	56
Table 49: RE test results from 10 to 18 GHz for FCC Part 15 (MR (LTE + NR)) – Cfg 2	57
Table 50: RE test results from 10 to 18 GHz FCC Part 96 (MR (LTE + NR)) – Cfg 2	57
Table 51: Test equipment used for RE	59

1. Executive summary

This document reports the Electromagnetic Compatibility (EMC) testing performed on the product called DOT 44Kr B48 (KRY 901 516/3) and DOT 41Kr B48 (KRY 901 516/4) for Ericsson Canada per project number 7169010768. The objective of the test activities is to evaluate compliance of the product to following EMC regulatory standards.

The DOT 44Kr B48 (KRY 901 516/3) and DOT 41Kr B48 (KRY 901 516/4) is verified to comply with the Class B Emissions requirements of these standards:

- FCC Part 15 Subpart B [5] (Class B)
- FCC Part 96 [7] (Additional protection levels, Section - 96.41e) 2)

Information about the test result summary and, the equipment under test (EUT) is in the sections:

- [Compliance summary](#)
- [Details of the equipment under test](#)
- [Detailed test results of Emissions](#)



1.1 Compliance summary

The test results in this report apply only to the tested components that are identified in the section [Assessed hardware](#).

The following table summarizes the EMC test results for the test cases performed on the DOT 44Kr B48 (KRY 901 516/3) and DOT 41Kr B48 (KRY 901 516/4)

Table 1: Summary of test results for the USA; FCC Part 15 subpart B

FCC Section	Description	Specification/Method	Pass or Fail	Results in section
15.109	Radiated Emissions (RE)	FCC Part 15/ANSI C63.4	Pass	3.2
15.107	Conducted Emissions (CE) for AC Power	FCC Part 15/ANSI C63.4	NA	NA
Table Notes				
1. Not Applicable; EUT operates from POE (56 VDC).				

Table 2: Summary of test results for the USA; FCC Part 96.41 e) 2)

FCC Section	Description	Specification/Method	Pass or Fail	Results in section
96.41 e) 2)	Additional protection levels - CBSD	FCC Part 96/ ANSI C63.26	Pass	3.2

2. Details of the equipment under test

This section describes the equipment under test (EUT).

2.1 Assessed hardware

The following table indicates the hardware components that were assessed during this test program.

Table 3: Assessed hardware

Hardware component ¹	Part number
DOT 44Kr B48, Dedicated Networks unit with internal antennas	KRY 901 516/3
DOT 41Kr B48, Dedicated Networks unit with external RF ports	KRY 901 516/4
Table Notes	
1. The 2 units above use the same pcb and hardware. The only difference between the units is the presence of the internal/external antennas. There fore all EMC tests were done only on the external port variant.	

2.2 Product overview

The product trade name is DOT 44Kr B48 (KRY 901 516/3) and DOT 41Kr B48 (KRY 901 516/4). DOT 44Kr B48 (KRY 901 516/3) and DOT 41Kr B48 (KRY 901 516/4) are indoor wireless telecommunication products; transmit and receive the cellular signals for 5G wireless systems. And operates from POE (56 VDC).

Figure 1: The EUT with four Internal RF ports, Dot 44Kr B48

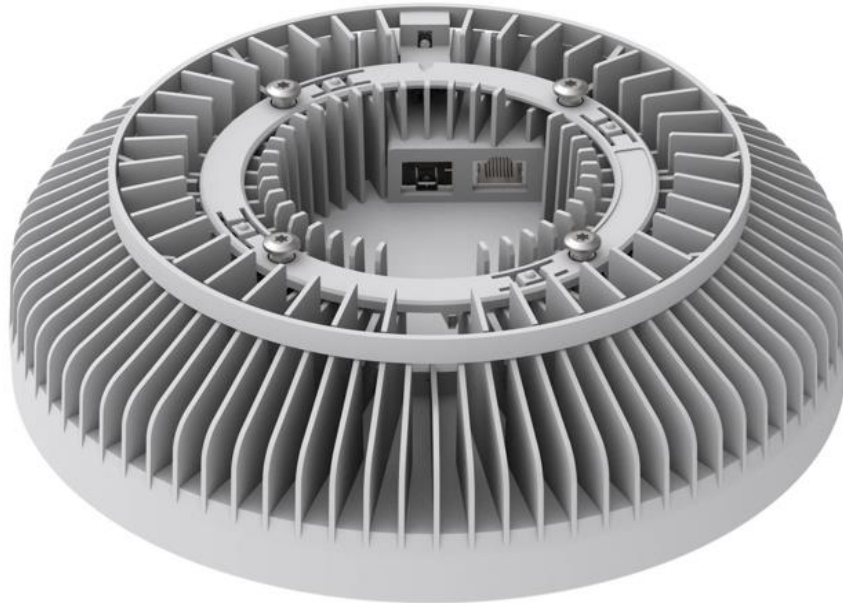
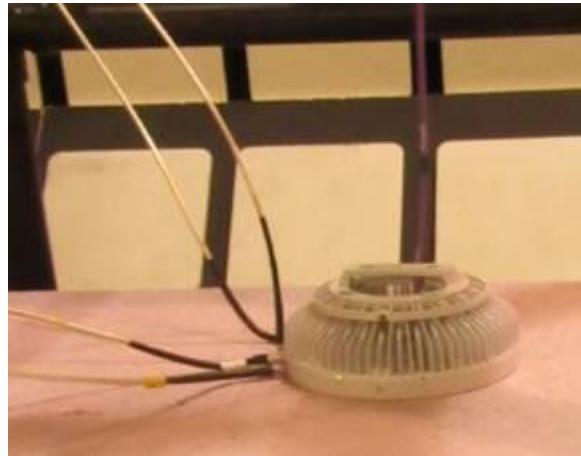

Figure 2: The EUT with four external RF ports, Dot 41Kr B48



The 2 units above use the same pcb and hardware. The only difference between the units is the presence of the internal/external antennas. There fore all EMC tests were done only on the external port variant; configurations of the DOT 41Kr B48 (KRY 901 516/4) that was tested is shown in the section [Configurations of the EUT](#). The EUT was tested in a tabletop setting.



Table 4: DOT 41Kr B48 Product info

Product data	DOT 41Kr B48
Product	Single-band Dot, 4T4R
P/N	KRY 901 516/4
HW Rev	R1A
Nominal Voltage	56Vdc (CAT6A POE or Hybrid cable)
Operating Temperature	+5°C to +40°C
Bands	B48
Antennas	4T4R B48
Output Power per band	400mW (26dBm) (B48, TDD) / branch
Maximum IBW	B48: 200MHz
Contig. / Non-contig	Contig. & Non-Contig
Single RAT (SRO) support	B48: NR-TDD, LTE-TDD
Mixed RAT (MRO) support	B48: NR-TDD + LTE-TDD
Channel Bandwidth B48	NR: 20, 30, 40, 50, 60, 70, 80, 90, 100MHz
	LTE: 5, 10, 15, 20MHz
Nominal O/P per TDD Antenna Port	Single Carrier: 1 x ~250mW (26dBm)
	Multi-Carrier: 2 x 200mW (23dBm)
	Multi-Carrier: 3 x 133.3mW (21.49dBm)
	Multi-Carrier: 4 x 100mW (20dBm)
	Multi-Carrier: 5 x 80mW (19dBm)
	Multi-Carrier: 6 x 66.7mW (18.23dBm)
Max carriers / Branch	B48: Max 12 carriers
CPRI line rate	10.1 Gbps
Compatible IRU	IRU 1648/1649 & 8848
Modulation:	NR: QPSK, 16QAM, 64QAM, 256 QAM
dRDI Interface:	Digital, dRDI compression rev = ATC
SFP Interface:	Optical SFP+, 10.1 Gbps
Mounting	ceiling or wall



2.3 Product port definition and EUT cable information

Table 5 identifies all the cables and ports on the EUT. The Environment of the cables is indoor.

Table 5: System port definition Dot 41Kr B48

Port Name	Port Description	Port Type	Interface Detail	Plug-Cable Type
RJ45	Digital RDI / DC Power Input	Telecom / DC Power	ethernet	RJ-45, CAT6A
SFP+	Digital RDI, Optical SFP+	Optical SFP	optical fiber, LC	SFP+, RDH 102 65/2,
3A, 3B, 4A, 4B	RF to antenna B48	Antenna	RF	SMA, Coax >3m

2.4 Configurations of the EUT

Two configurations were used for radiated Emissions test. All EUT configurations & RE test range were defined by customer.

- Configuration 1: Dot 41Kr B48 with IRU 1648 (contiguous mode)
- Configuration 2: Dot 41Kr B48 with IRU 1649 (non-contiguous mode)

2.4.1 Configuration 1: Dot 41Kr B48 with IRU 1648 (contiguous mode)

Figure 3 shows the configuration 1 of the EUT for Radiated Emissions test.

Figure 3: Test configuration 1 for Emission tests (contiguous mode)

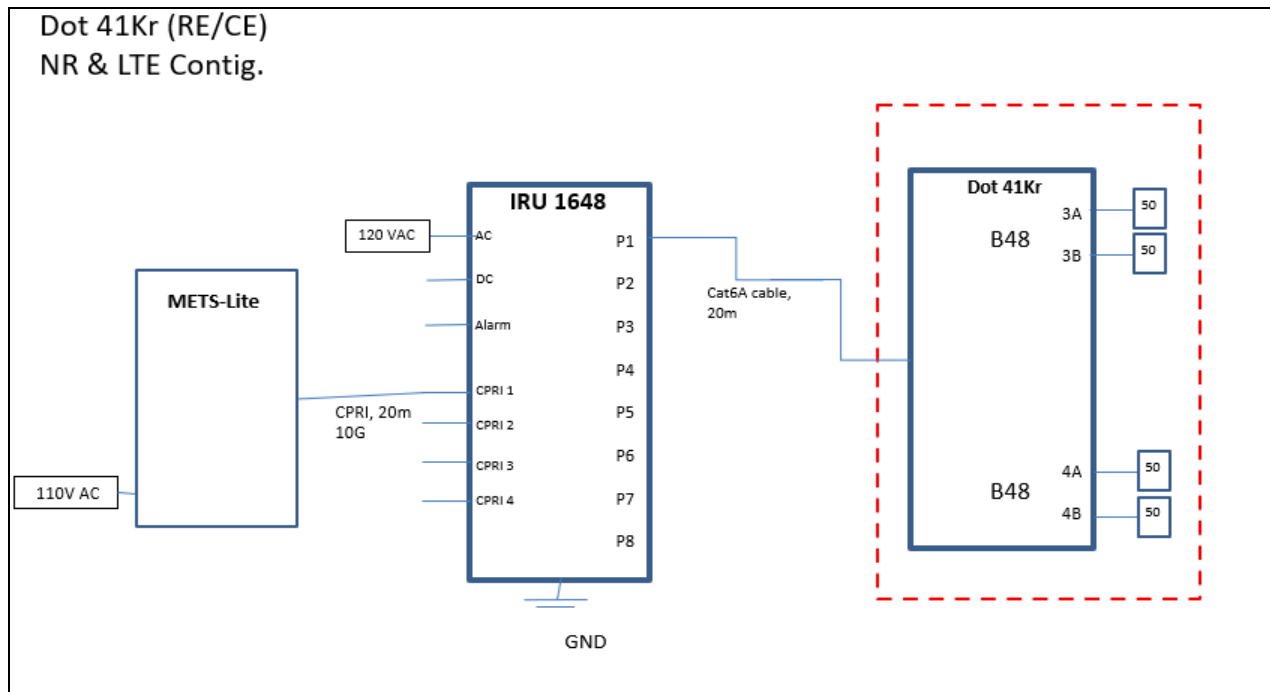

Following RAT/carrier configurations were tested during this Radiated Emissions evaluations for configuration 1.

- Radiated Emissions Single RAT/Single Carrier Configurations (LTE)
- Radiated Emissions Single RAT / Single Carrier Configurations (NR)
- Radiated Emissions Single RAT / Multi Carriers Configurations (LTE)
- Radiated Emissions Multi RAT/Multi Carrier Configuration (LTE+NR)

2.4.1.1 Radiated Emissions Single RAT/Single Carrier Configurations (LTE) – Cfg 1

Figure 4: Carrier detail – Single RAT /Single carrier (LTE)

Single RAT/Single Carrier - LTE setups for Emissions	
B48 PORT 3A,3B,4A,4B	
BS type 1-C, CS16 (NR) TC21	
SR LTE Config SC 1 Carrier setups for Emissions	
Carrier	Middle channel
1	B48: LTE, 5MHz, 3625MHz
SR LTE Config SC 2 Carrier setups for Emissions	
Carrier	Middle channel
1	B48: LTE, 10MHz, 3625MHz
SR LTE Config SC 3 Carrier setups for Emissions	
Carrier	Middle channel
1	B48: LTE, 15MHz, 3625MHz
SR LTE Config SC 4 Carrier setups for Emissions	
Carrier	Middle channel
1	B48: LTE, 20MHz, 3625MHz

Radiated Emissions measurements were compared between above 4 LTE carrier setups. **SC1** was found to have higher emissions than **SC2**, **SC3** and **SC4**. Single RAT/Single carrier LTE in this report are therefore measured using **SC1** Middle, Bottom, Top channel carrier setup. Tested carrier/frequency detail in Figure 5: Tested carrier detail, Single RAT /Single carrier (LTE) – SC 1.

Figure 5: Tested carrier detail, Single RAT /Single carrier (LTE) – SC 1

Single RAT/Single Carrier - LTE setups for Emissions	
B41K PORT 3A,3B,4A,4B	
BS type 1-C, CS16 (NR, LTE) TC21	
SR LTE Config SC 1 Carrier setups for Emissions	
Carrier	Bottom channel
1	B48: LTE, 5MHz, 3552.5MHz
Carrier	Middle channel
1	B48: LTE, 5MHz, 3625MHz
Carrier	Top channel
1	B48: LTE, 5MHz, 3697.5MHz

2.4.1.2 Radiated Emissions Single RAT / Single Carrier Configurations (NR) – Cfg 1

Figure 6: Carrier detail – Single RAT / Single carrier (NR)

Single RAT/Single Carrier - NR setups for Emissions	
B48 PORT 3A,3B,4A,4B	
BS type 1-C, CS16 (NR) TC21	
SR NR Config SC 1 Carrier setups for Emissions	
Carrier	Middle channel
1	B48: NR, 20MHz, 3625MHz
SR NR Config SC 2 Carrier setups for Emissions	
Carrier	Middle channel
1	B48: NR, 30MHz, 3625MHz
SR NR Config SC 3 Carrier setups for Emissions	
Carrier	Middle channel
1	B48: NR, 40MHz, 3625MHz
SR NR Config SC 4 Carrier setups for Emissions	
Carrier	Middle channel
1	B48: NR, 50MHz, 3625MHz
SR NR Config SC 5 Carrier setups for Emissions	
Carrier	Middle channel
1	B48: NR, 60MHz, 3625MHz
SR NR Config SC 6 Carrier setups for Emissions	
Carrier	Middle channel
1	B48: NR, 70MHz, 3625MHz
SR NR Config SC 7 Carrier setups for Emissions	
Carrier	Middle channel
1	B48: NR, 80MHz, 3625MHz
SR NR Config SC 8 Carrier setups for Emissions	
Carrier	Middle channel
1	B48: NR, 90MHz, 3625MHz
SR NR Config SC 9 Carrier setups for Emissions	
Carrier	Middle channel
1	B48: NR, 100MHz, 3625MHz

Note: Radiated Emissions measurements were compared between above 9 NR carrier setups. **SC1** was found to have higher emissions than **SC2, SC3, SC4, SC5, SC6, SC7, SC8** and **SC9**. All plots with single NR carrier in this report are therefore measured using **SC1** Middle channel NR carrier setup.

2.4.1.3 Radiated Emissions Single RAT / Multi Carriers Configurations (LTE) – Cfg 1

Figure 7: Carrier detail – Single RAT / Multi carrier (LTE)

Single RAT / Multi Carrier - LTE setups for Emissions	
B48 PORT 3A,3B,4A,4B	
BS type 1-C, CS16 (NR) TC21	
SR LTE Config MC1 Carrier setups for Emissions	
Carrier:	Middle channel
1	B48: LTE, 5MHz, 3622.5MHz
2	B48: LTE, 5MHz, 3627.5MHz
SR LTE Config MC2 Carrier setups for Emissions	
Carrier:	Middle channel
1	B48: LTE, 5MHz, 3597.5MHz
2	B48: LTE, 5MHz, 3602.5MHz
3	B48: LTE, 5MHz, 3607.5MHz
4	B48: LTE, 5MHz, 3612.5MHz
5	B48: LTE, 5MHz, 3617.5MHz
6	B48: LTE, 5MHz, 3622.5MHz
7	B48: LTE, 5MHz, 3627.5MHz
8	B48: LTE, 5MHz, 3632.5MHz
9	B48: LTE, 5MHz, 3637.5MHz
10	B48: LTE, 5MHz, 3642.5MHz
11	B48: LTE, 5MHz, 3647.5MHz
12	B48: LTE, 5MHz, 3652.5MHz

Note: Radiated Emissions measurements were compared between **MC1**, and **MC2**. **MC1** was found to have higher emissions. All plots with Single RAT/Multi carrier in this report are therefore measured using **MC1** middle LTE carrier setups.



2.4.1.4 Radiated Emissions Multi RAT/Multi Carrier Configuration (LTE+NR) – Cfg 1

Figure 8: Carrier detail – MultiCarrier / Multi RAT Configuration

Single RAT / Multi Carrier - LTE + NR setups for Emissions	
B48 PORT 3A,3B,4A,4B	
BS type 1-C, CS16 (NR) TC21	
MR Config MR1 Carrier setups for Emissions	
Carrier:	Middle channel
1	B48: NR, 20MHz, 3615MHz
2	B48: LTE, 5MHz, 3627.5MHz
MR Config MR2 Carrier setups for Emissions	
Carrier:	Middle channel
1	B48: NR, 20MHz, 3560MHz
2	B48: NR, 20MHz, 3580MHz
3	B48: NR, 20MHz, 3600MHz
4	B48: NR, 20MHz, 3620MHz
5	B48: NR, 20MHz, 3640MHz
6	B48: NR, 20MHz, 3660MHz
7	B48: LTE, 5MHz, 3672.5MHz
8	B48: LTE, 5MHz, 3677.5MHz
9	B48: LTE, 5MHz, 3682.5MHz
10	B48: LTE, 5MHz, 3687.5MHz
11	B48: LTE, 5MHz, 3692.5MHz
12	B48: LTE, 5MHz, 3697.5MHz

Note: Radiated Emissions measurements were compared between **MR1**, and **MR2**. **MR1** was found to have higher emissions than **MR2**. All plots with Multi RAT/Multi carrier in this report are therefore measured using **MR1** Middle channel carrier configuration.

2.4.2 Configuration 2: Dot 41Kr B48 with IRU 1649 (non-contiguous mode)

Figure 9 shows the configuration 2 of the EUT for Radiated Emissions test.

Figure 9: Test configuration 2 for Emission tests (non-contiguous mode)

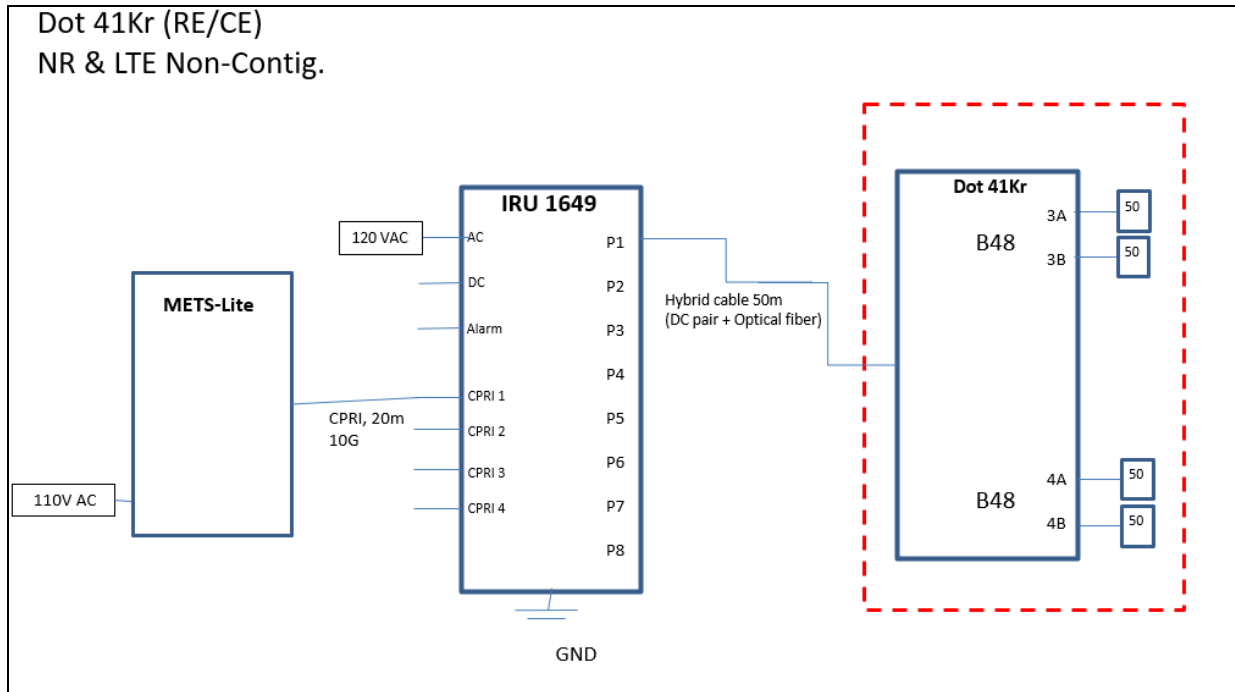

Following RAT/carrier configurations were tested during this Radiated Emissions evaluations for configuration 2.

2.4.2.1 Radiated Emissions Single RAT/Single Carrier Configuration (LTE) – Cfg 2

Figure 10: Carrier detail – Single RAT/Single carrier Configuration

Single RAT / Single Carrier - LTE setups for Emissions	
B48 PORT 3A,3B,4A,4B	
BS type 1-C, CS16 (NR) TC21	
SR Config SC1 Carrier setups for Emissions	
Carrier:	Middle channel
1	B48: LTE, 5MHz, 3625MHz

2.4.2.2 Radiated Emissions Single RAT/ Multi Carrier Configuration (LTE) – Cfg 2

Figure 11: Carrier detail – Single RAT / Multi carrier (LTE)

Single RAT / Multi Carrier - LTE setups for Emissions	
B48 PORT 3A,3B,4A,4B	
BS type 1-C, CS16 (NR) TC21	
SR LTE Config MC1 Carrier setups for Emissions	
Carrier:	1xBottom & 1xTop
1	B48: LTE, 5MHz, 3552.5MHz
2	B48: LTE, 5MHz, 3697.5MHz
SR LTE Config MC2 Carrier setups for Emissions	
Carrier:	6 x Bottom & 6 x Top
1	B48: LTE, 5MHz, 3552.5MHz
2	B48: LTE, 5MHz, 3557.5MHz
3	B48: LTE, 5MHz, 3562.5MHz
4	B48: LTE, 5MHz, 3567.5MHz
5	B48: LTE, 5MHz, 3572.5MHz
6	B48: LTE, 5MHz, 3577.5MHz
7	B48: LTE, 5MHz, 3672.5MHz
8	B48: LTE, 5MHz, 3677.5MHz
9	B48: LTE, 5MHz, 3682.5MHz
10	B48: LTE, 5MHz, 3687.5MHz
11	B48: LTE, 5MHz, 3692.5MHz
12	B48: LTE, 5MHz, 3697.5MHz

Note: Radiated Emissions measurements were compared between **MC1**, and **MC2**. **MC1** was found to have higher emissions. All plots with Single RAT/Multi carrier in this report are therefore measured using **MC1** LTE carrier setups as per table above.

2.4.2.3 Radiated Emissions Multi RAT/Multi Carrier Configuration (LTE + NR) – Cfg 2

Figure 12: Carrier detail – MultiCarrier / Multi RAT Configuration

Single RAT / Multi Carrier - LTE + NR setups for Emissions	
B48 PORT 3A,3B,4A,4B	
BS type 1-C, CS16 (NR) TC21	
MR Config MR1 Carrier setups for Emissions	
Carrier:	NR 1xBottom & LTE 1xTop
1	B48: NR, 20MHz, 3560MHz
2	B48: LTE, 5MHz, 3697.5MHz
MR Config MR2 Carrier setups for Emissions	
Carrier:	NR 5xBottom & LTE 7xTop
1	B48: NR, 20MHz, 3560MHz
2	B48: NR, 20MHz, 3580MHz
3	B48: NR, 20MHz, 3600MHz
4	B48: NR, 20MHz, 3620MHz
5	B48: NR, 20MHz, 3640MHz
6	B48: LTE, 5MHz, 3667.5MHz
7	B48: LTE, 5MHz, 3672.5MHz
8	B48: LTE, 5MHz, 3677.5MHz
9	B48: LTE, 5MHz, 3682.5MHz
10	B48: LTE, 5MHz, 3687.5MHz
11	B48: LTE, 5MHz, 3692.5MHz
12	B48: LTE, 5MHz, 3697.5MHz

Note: Radiated Emissions measurements were compared between **MR1**, and **MR2**. **MR1** was found to have higher emissions than **MR2**. All plots with Multi RAT/Multi carrier in this report are therefore measured using **MR1** carrier configuration setups as per table above.

2.5 Modifications of the EUT during testing

The EUT was not modified prior to or during testing.

2.6 Inventory of the EUT and support equipments

The following table identifies the inventory of the EUT.



Table 6: Inventory of the EUT – Configuration 1

Equipment Role	Product Name	Product Number	Product Release	Product Serial#
EUT	DOT 41Kr B48	KRY 901 516/4	R1A	TD3W213281
SUPPORT	IRU 1648	KRC 161 842/1	R1D	TD3F105254
Cable	IRU CPRI, Fiber, LC, SM, 20m	na	na	na
Cable	dRDI cable, 100m	Schnieder, F/FTP	na	na
Cable	RF, SMA, 2m, qty=4	na	na	na
TEST SET	METS-Lite (RUX + CT-11)	LPC 102 494/1	R2A	TO1G499655
S/W:				
IRU load: CXP2030045/26-R12A108				
RUX rev: R9F				
RUX testDef: _RRUS_DOT_Ph4_B48_V22_R9L				

Table 7: Inventory of the EUT – Configuration 2

Equipment Role	Product Name	Product Number	Product Release	Product Serial#
EUT	DOT 41Kr B48	KRY 901 516/4	R1A	TD3W213281
SUPPORT	IRU 1649	KRC 161 842/2	R1B	TD3F064558
Cable	IRU CPRI, Fiber, LC, SM, 20m	na	na	na
Cable	IRU to Dot Power, 56VDC, 2-wire, 50m	na	na	na
Cable	IRU to Dot, dRDI-optical, Fiber, LC, SM, 50m	na	na	na
Cable	RF, SMA, 2m, qty=4	na	na	na
S/W:				
IRU load: CXP2030045/26-R12A108				
RUX rev: R9F				
RUX testDef: _RRUS_DOT_Ph4_B48_V22_R9L				

3. Detailed test results of Emissions

Emissions from systems manifest themselves in two forms: conducted emissions on cables and radiated emissions from the entire system (i.e. electronic modules, hardware, and cables). Regulatory standards restrict these different forms of emissions generated by the system.

The temperature and humidity in the test facilities are controlled. The temperature is maintained between 20 °C and 25 °C, with a relative humidity between 30 % and 60 %. Levels are recorded and any exceptions are included in the detailed test results sections of this report.

3.1 Measurement instrumentation

The measurement instrumentation conforms to the relevant standards in this report: ANSI C63.2, CISPR 16, CISPR 22, and CISPR 32. Calibration of the measurement instrumentation is maintained in accordance with the supplier's recommendations, or as necessary to ensure its accuracy.

3.2 Radiated Emissions, E-field

This test verifies that the EUT does not produce excess amounts of E-field Radiated Emissions (RE) that could interfere with licensed radiators.

3.2.1 Test specification and limits

The testing requirements are as follows.

Table 8: RE test requirements

Requirement	Method	Country of application
FCC Part 15, Subpart B	ANSI C63.4	USA
FCC Part 96	FCC Part 96/ ANSI C63.26	USA

The limits of the RE tests are as follows.

Table 9: RE limits at 10 m for Class B of FCC

Frequency range (MHz)	FCC Part 15 (dB μ V/m)	Detector
30 to 88	29.5	Quasi-Peak
88 to 216	33.0	Quasi-Peak
216 to 960	35.5	Quasi-Peak
960 to 1000	43.5	Quasi-Peak
1000 to 40000	43.5	Average

Table 10: Emission limits for FCC Part 96 e) 2)

Frequency range (MHz)	FCC Part 96 EIRP Limit Section 96.41 e) 2) (dBm)	Calculated EIRP Limit in dB μ V/m
Below 3540 MHz or above 3710 MHz	-25	70.23
Below 3530 MHz or above 3720 MHz	-40	55.23

3.2.2 Test procedure

Verifications of the test equipment and AFC were performed before the installation of the EUT in accordance with the quality assurance procedures documented in the EMC test procedures document. The test was performed according to the relevant procedures listed in [Table 8](#).

- The EUT was placed on the turntable inside the AFC (configured for normal operation). The system and its cables were separated from the ground plane by an insulating support 10 mm in height.
- For tests between 30 MHz and 1 GHz the receive antenna (BiLog®) was placed 3 m away from the EUT. An initial scan was performed to find emissions/frequencies requiring detailed measurement.

The pre-scan was performed by rotating the system 360 degrees while recording all emissions (frequency and amplitude). This procedure was repeated for antenna heights of 1 to 4 m, as well as both polarizations of the receiving antenna.

- For tests above 1 GHz the receive antenna (horn) was placed 3 m away from the EUT. Absorbing cones were placed on the floor between the antenna and the EUT. An initial scan was performed to find emissions/frequencies requiring detailed measurement. The pre-scan was performed by rotating the system 360 degrees while recording all emissions (frequency and amplitude). This procedure was repeated for antenna heights of 1 to 4 m, as well as both polarizations of the receiving antenna.
- For tests between 18 and 40 GHz the receive horn antenna was placed at a 1 m distance from the EUT with the absorbing cones placed on the floor. An initial scan was performed to find emissions/frequencies requiring detail measurement. The pre-scan was performed on all sides of the EUT, using both polarizations of the receive antenna to find any system emissions.
- For all above frequency ranges, the pre-scan peak data was compared to the limits. Peaks with less than 6 dB of margin were maximized using the proper detector: the EUT was rotated in azimuth over 360 degrees to identify the direction of maximum emission, antenna height was then varied from 1 to 4 m to obtain maximum emission level.

Figure 13: Setup of Radiated Emissions

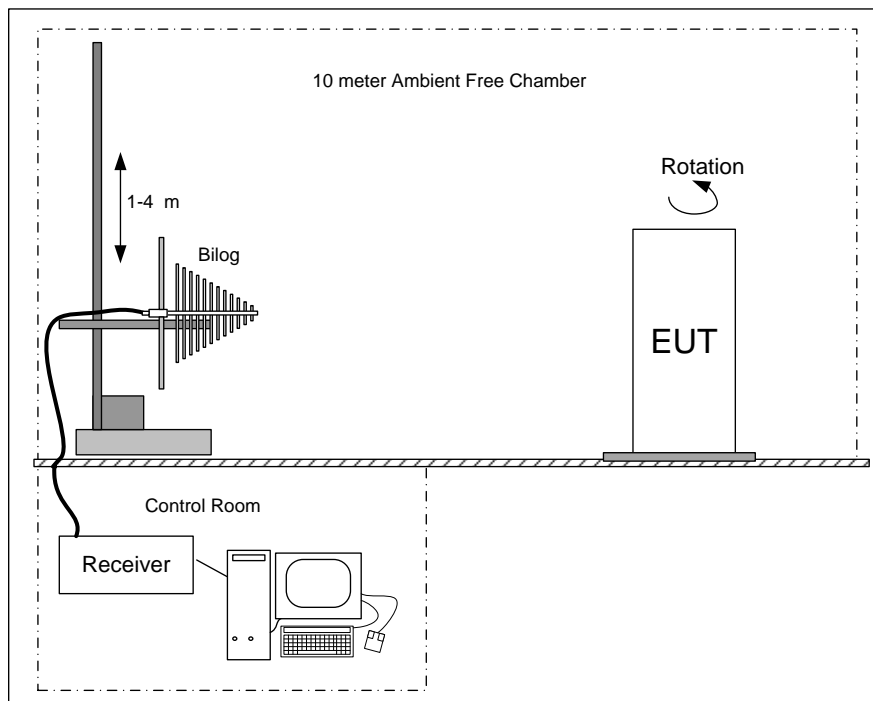

3.2.3 Calculation of the compliance margin

The following example shows the way in which the compliance margin is calculated in the “RE Test Results” tables.

The rows in these tables are defined as follows.

Meter Reading (dB μ V) = Voltage measured using the spectrum analyzer with the proper detector

Correction (dB) = Cumulative gain or loss of pre-amplifier and cables used in the measurement path (dB) + Antenna Factor (dB)

Level (dB μ V/m) = Corrected value or field strength, that is, the parameter of interest that is compared to the limit

Margin (dB) = Level with respect to the appropriate limit (a negative Margin indicates that the Level is below the limit and that the measurement is a Pass)

The values in the Level row are calculated as follows: Level = Meter Reading + Correction (dB)

The values in the Margin row are calculated as follows: Margin = Level – Limit

3.2.4 Measurement uncertainties

The expanded measurement instrumentation uncertainty with a 95 % level of confidence, calculated according to the method described in CISPR 16 is:

- ± 3.8 dB between 30 MHz and 1 GHz
- ± 4.7 dB between 1 GHz and 10 GHz
- ± 4.8 dB between 10 GHz and 18 GHz
- ± 4.6 dB between 18 GHz and 26.5 GHz
- ± 4.8 dB between 26.5 GHz and 40 GHz



3.2.5 Test results of RE – Single RAT / Carrier (LTE – Mid channel) – Cfg 1

Test location: 10-meter Ambient Free Chamber (AFC)

Date tested: 15 - 17 February 2022

Tested by: Tom Ott

Test configurations are listed as SC LTE in 2.4.1.1 as identified in the section [Configurations of the EUT](#). For the following test results that have supporting data tables, negative margin values indicate a pass.

Red trace – Vertical antenna polarity, **Blue trace** – Horizontal antenna polarity

Figure 14: Plot of RE at 3 m – 30 to 1000 MHz (SC, LTE – Mid channel) – Cfg 1

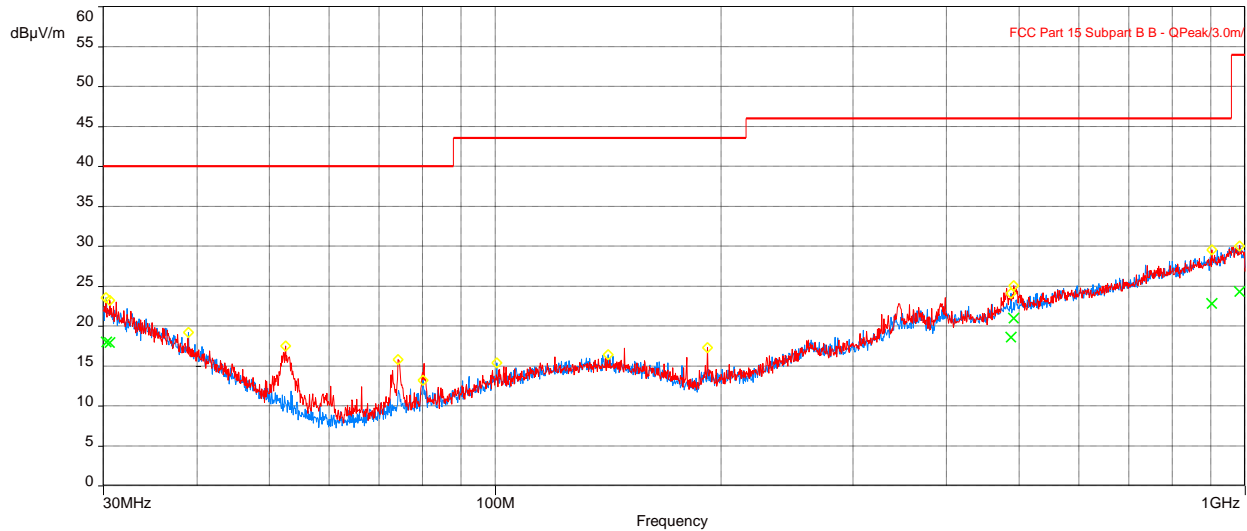

Table 11: RE test results from 30 to 1000 MHz for FCC Part 15 (SC, LTE – Mid channel) – Cfg 1

Frequency (MHz)	Level (dBµV)	Limit Quasi-peak (dBµV)	Margin to FCC part 15 Class B (dB)	Height (m)	Azimuth (deg)	Polarization	Correction (dB)
30.59910864	17.93	40.00	-22.07	3.83	319.25	Vertical	-3.12
491.4013174	20.94	46.02	-25.08	1.14	189.75	Vertical	-2.63
903.4701379	22.77	46.02	-23.25	2.92	125.00	Vertical	4.37
30.28591059	17.95	40.00	-22.05	1.00	261.75	Horizontal	-2.97

Table 12: RE test results from 30 to 1000 MHz for FCC Part 96 (SC, LTE – Mid channel) – Cfg 1

Frequency (MHz)	Level (dBµV)	Limit EIRP (dBµV)	Margin to EIRP Limit (dB)	Height (m)	Azimuth (deg)	Polarization	Correction (dB)
30.59910864	17.93	55.23	-37.3	3.83	319.25	Vertical	-3.12
491.4013174	20.94	55.23	-34.29	1.14	189.75	Vertical	-2.63
903.4701379	22.77	55.23	-32.46	2.92	125.00	Vertical	4.37
30.28591059	17.95	55.23	-37.28	1.00	261.75	Horizontal	-2.97

Note: In the table/Plot above, no emissions exceed the Part 96 radiated spurious emissions limit when converted to dBuV/m. For final spurious emissions measurements to FCC Part 96, see antenna port conducted emissions in applicable test report.

Figure 15: Plot of RE at 3m from 1 to 10 GHz (SC, LTE – Mid channel) – Cfg 1

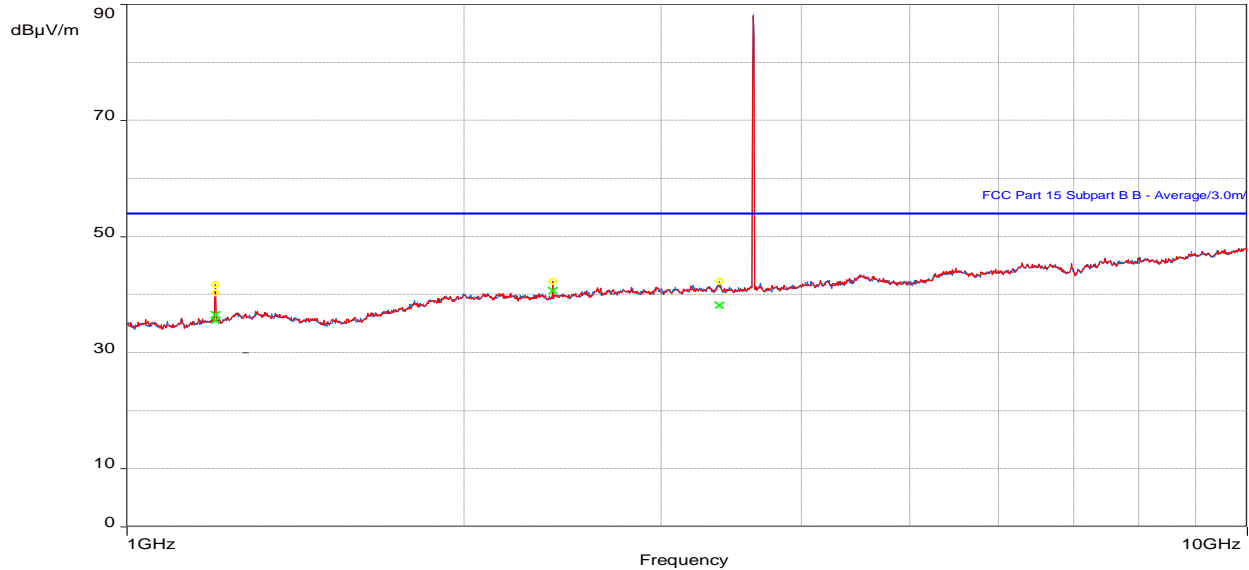

Note: Peak above the limit is leakage of the EUT’s fundamentals from the 50-ohm terminations.

Table 13: RE test results from 1 to 10 GHz for FCC Part 15 (SC, LTE – Mid channel) – Cfg 1

Frequency (MHz)	Level Average (dBµV)	Limit Average (dBµV)	Margin to FCC part 15 Class B (dB)	Height (m)	Azimuth (degrees)	Polarization	Correction (dB)
1199.811218	36.54	53.96	-17.42	2.56	343.00	Vertical	2.24
2399.985897	40.68	53.96	-13.28	2.21	218.50	Vertical	7.71
1199.811218	35.54	53.96	-18.42	3.00	206.25	Horizontal	2.24
3380.586538	38.14	53.96	-15.82	3.24	141.50	Horizontal	9.39

Table 14: RE test results from 1 to 10 GHz for FCC Part 96 (SC, LTE – Mid channel) – Cfg 1

Frequency (MHz)	Level (dBµV)	Limit EIRP (dBµV)	Margin to EIRP Limit (dB)	Height (m)	Azimuth (deg)	Polarization	Correction (dB)
1199.81218	36.54	55.23	-18.69	2.56	343.00	Vertical	2.24
2399.985897	40.68	55.23	-14.55	2.21	218.50	Vertical	7.71
1199.811218	35.54	55.23	-19.69	3.00	206.25	Horizontal	2.24
3380.586538	38.14	55.23	-17.09	3.24	141.50	Horizontal	9.39

Note: In the table/Plot above, no emissions exceed the Part 96 radiated spurious emissions limit when converted to dBuV/m. For final spurious emissions measurements to FCC Part 96, see antenna port conducted emissions in applicable test report.

Figure 16: Plot of RE at 3m from 10 to 18 GHz (SC, LTE – Mid channel) – Cfg 1

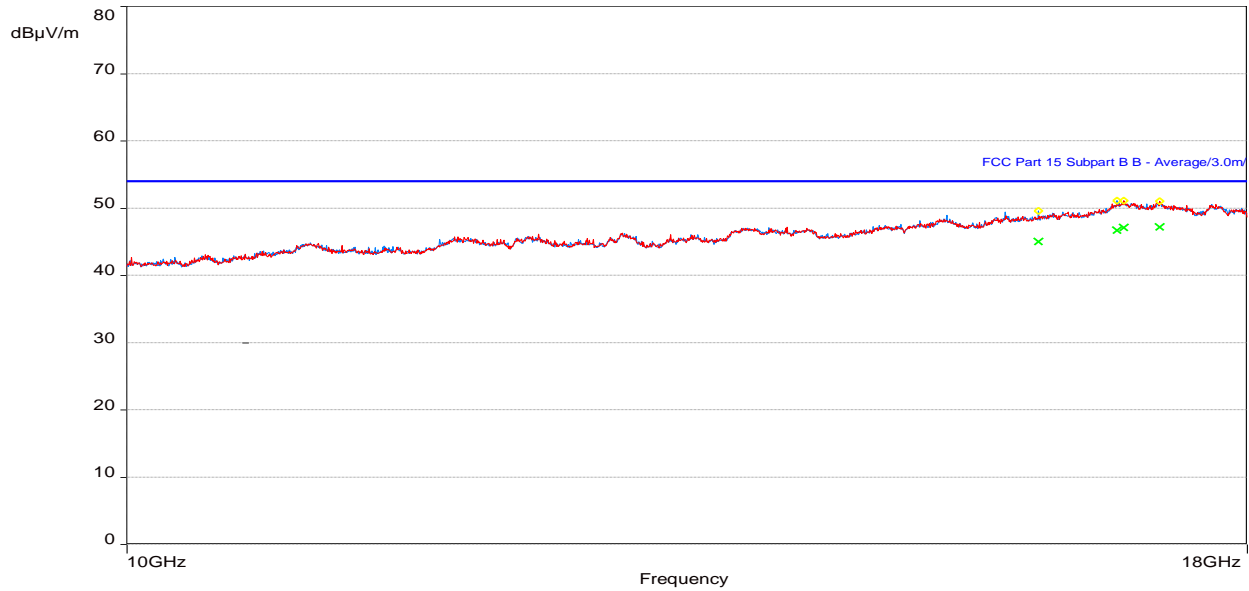

Table 15: RE test results from 10 to 18 GHz for FCC Part 15 (SC, LTE – Mid channel) – Cfg 1

Frequency (MHz)	Level Average (dBµV)	Limit Average (dBµV)	Margin to FCC part 15 Class B (dB)	Height (m)	Azimuth (degrees)	Polarization	Correction (dB)
16872.65096	47.06	53.96	-6.90	2.76	75.50	Vertical	17.21
17196.28783	47.19	53.96	-6.77	2.97	263.75	Vertical	17.48
16131.99937	44.98	53.96	-8.98	1.52	38.50	Horizontal	14.98
16810.4779	46.65	53.96	-7.31	2.21	89.25	Horizontal	17.00

Table 16: RE test results from 10 to 18 GHz for FCC Part 96 (SC, LTE – Mid channel) – Cfg 1

Frequency (MHz)	Level (dBµV)	Limit EIRP (dBµV)	Margin to EIRP Limit (dB)	Height (m)	Azimuth (deg)	Polarization	Correction (dB)
16872.65096	47.06	55.23	-8.17	2.76	75.50	Vertical	17.21
17196.28783	47.19	55.23	-8.04	2.97	263.75	Vertical	17.48
16131.99937	44.98	55.23	-10.25	1.52	38.50	Horizontal	14.98
16810.4779	46.65	55.23	-8.58	2.21	89.25	Horizontal	17.00

Note: In the table/Plot above, no emissions exceed the Part 96 radiated spurious emissions limit when converted to dBuV/m. For final spurious emissions measurements to FCC Part 96, see antenna port conducted emissions in applicable test report.

Figure 17: Plot of RE at 1m from 18 to 26.5 GHz (SC, LTE – Mid channel) – Cfg 1

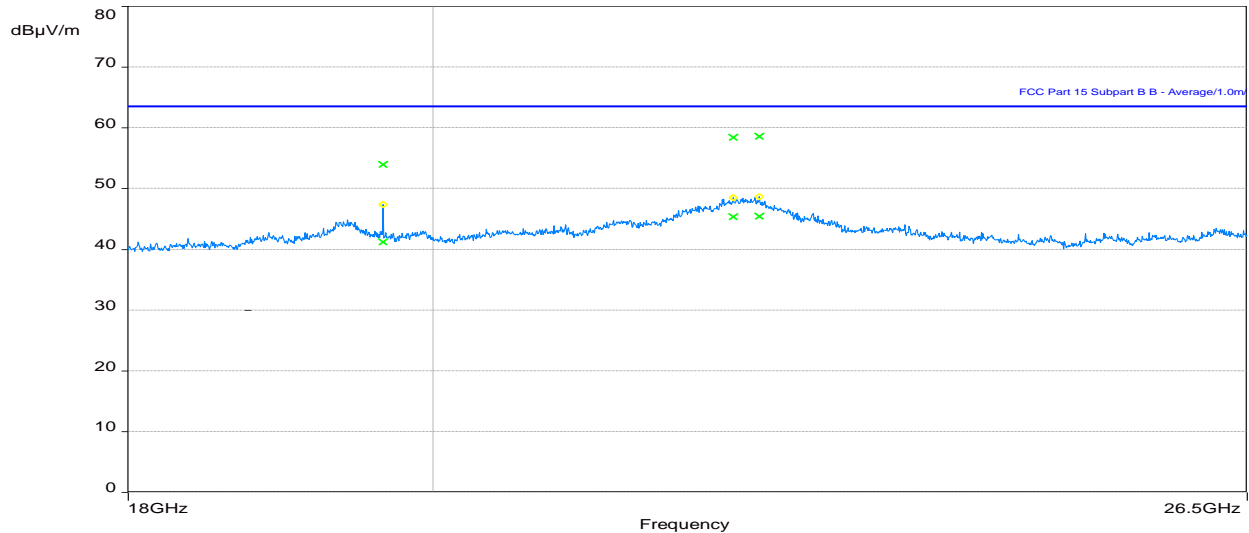

Note 1: In the plot above No Emissions exceeds the FCC Part 15 limit.

Note 2: In the plot above, no emissions exceed the Part 96 radiated spurious emissions limit when converted to dBuV/m. For final spurious emissions measurements to FCC Part 96, see antenna port conducted emissions in applicable test report.

Figure 18: Plot of RE at 1m from 26.5 to 40 GHz (SC, LTE – Mid channel) – Cfg 1

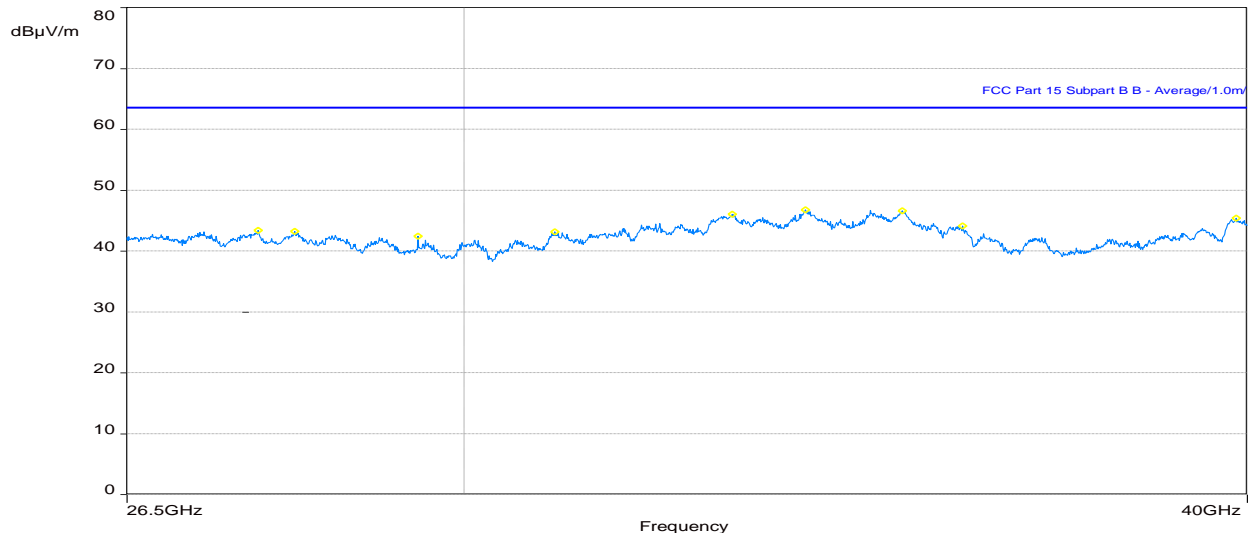

Note 1: In the plot above No Emissions exceeds the FCC Part 15 limit.

Note 2: In the plot above, no emissions exceed the Part 96 radiated spurious emissions limit when converted to dBuV/m. For final spurious emissions measurements to FCC Part 96, see antenna port conducted emissions in applicable test report.



3.2.6 Test results of RE – Single RAT / Carrier (LTE – Bot channel) – Cfg 1

Test location: 10-meter Ambient Free Chamber (AFC)

Date tested: 15 - 17 February 2022

Tested by: Tom Ott

Test configurations are listed as SC LTE in [2.4.1.1](#) as identified in the section [Configurations of the EUT](#). For the following test results that have supporting data tables, negative margin values indicate a pass.

Red trace – Vertical antenna polarity, **Blue trace** – Horizontal antenna polarity

Figure 19: Plot of RE at 3m from 1 to 10 GHz (SC, LTE – Bot channel) – Cfg 1

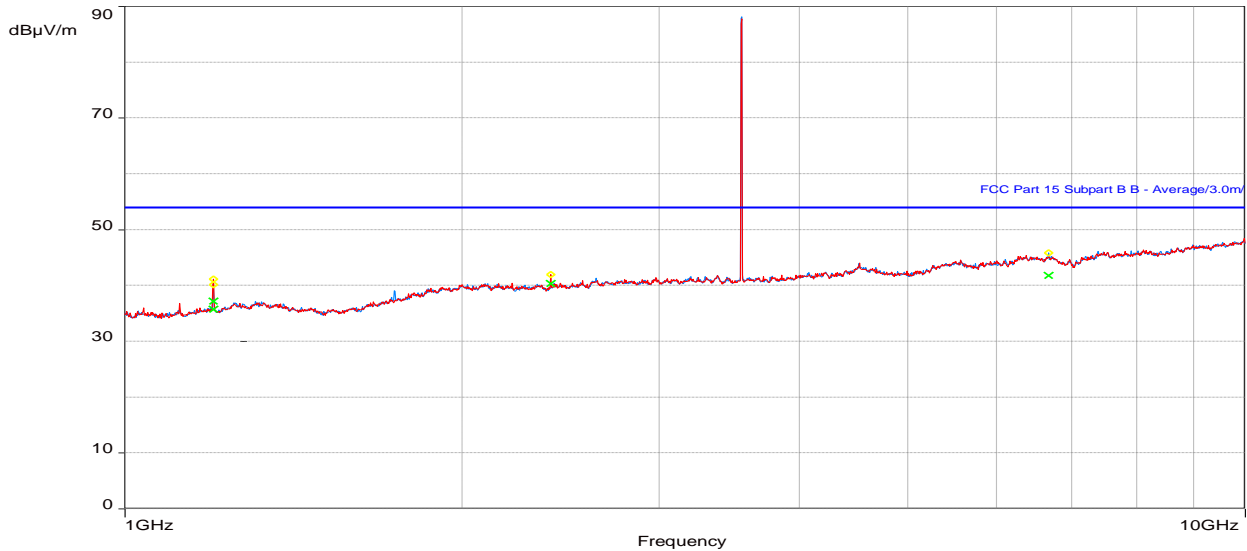

Note: Peak above the limit is leakage of the EUT’s fundamentals from the 50-ohm terminations.

Table 17: RE test results from 1 to 10 GHz for FCC Part 15 (SC, LTE – Bot channel) – Cfg 1

Frequency (MHz)	Level Average (dBµV)	Limit Average (dBµV)	Margin to FCC part 15 Class B (dB)	Height (m)	Azimuth (degrees)	Polarization	Correction (dB)
1199.897756	37.19	53.96	-16.77	2.56	184.50	Vertical	2.24
2399.985897	40.35	53.96	-13.61	2.14	218.50	Vertical	7.71
1199.851282	35.71	53.96	-18.25	3.00	206.25	Horizontal	2.24
6680.8625	41.74	53.96	-12.22	3.69	360.00	Horizontal	13.31

Table 18: RE test results from 1 to 10 GHz for FCC Part 96 (SC, LTE – Bot channel) – Cfg 1

Frequency (MHz)	Level (dBµV)	Limit EIRP (dBµV)	Margin to EIRP Limit (dB)	Height (m)	Azimuth (deg)	Polarization	Correction (dB)
1199.897756	37.19	55.23	-18.04	2.56	184.50	Vertical	2.24
2399.985897	40.35	55.23	-14.88	2.14	218.50	Vertical	7.71
1199.851282	35.71	55.23	-19.52	3.00	206.25	Horizontal	2.24
6680.8625	41.74	55.23	-13.49	3.69	360.00	Horizontal	13.31

Note: In the table/Plot above, no emissions exceed the Part 96 radiated spurious emissions limit when converted to dBuV/m, except for the fundamental. For final spurious emissions measurements to FCC Part 96, see antenna port conducted emissions in applicable test report.



Figure 20: Plot of RE at 3m from 10 to 18 GHz (SC, LTE – Bot channel) – Cfg 1

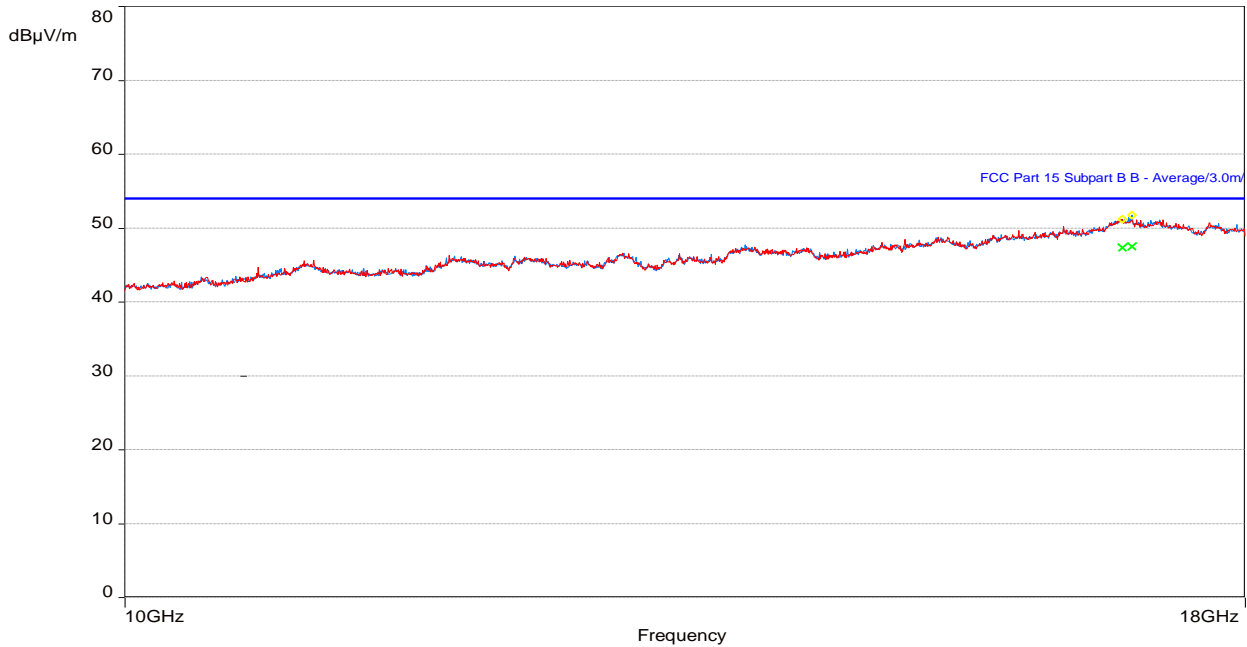

Table 19: RE test results from 10 to 18 GHz for FCC Part 15 (SC, LTE – Bot channel) – Cfg 1

Frequency (MHz)	Level Average (dBµV)	Limit Average (dBµV)	Margin to FCC part 15 Class B (dB)	Height (m)	Azimuth (degrees)	Polarization	Correction (dB)
16878.63878	47.29	53.96	-6.67	1.39	327.75	Vertical	17.22
16965.67372	47.51	53.96	-6.45	3.73	74.50	Horizontal	17.38

Table 20: RE test results from 10 to 18 GHz FCC Part 96 (SC, LTE – Bot channel) – Cfg 1

Frequency (MHz)	Level (dBµV)	Limit EIRP (dBµV)	Margin to EIRP Limit (dB)	Height (m)	Azimuth (deg)	Polarization	Correction (dB)
16878.63878	47.29	55.23	-7.94	1.39	327.75	Vertical	17.22
16965.67372	47.51	55.23	-7.72	3.73	74.50	Horizontal	17.38

Note: In the table/Plot above, no emissions exceeded the Part 96 radiated spurious emissions limit when converted to dBuV/m. For final spurious emissions measurements to FCC Part 96, see antenna port conducted emissions in applicable test report.



3.2.7 Test results of RE – Single RAT / Carrier (LTE – Top channel) - Cfg 1

Test location: 10-meter Ambient Free Chamber (AFC)

Date tested: 15 - 17 February 2022

Tested by: Tom Ott

Test configurations are listed as SC LTE in 2.4.1.1 as identified in the section [Configurations of the EUT](#). For the following test results that have supporting data tables, negative margin values indicate a pass.

Red trace – Vertical antenna polarity, **Blue trace** – Horizontal antenna polarity

Figure 21: Plot of RE at 3m from 1 to 10 GHz (SC, LTE – Top channel) – Cfg 1

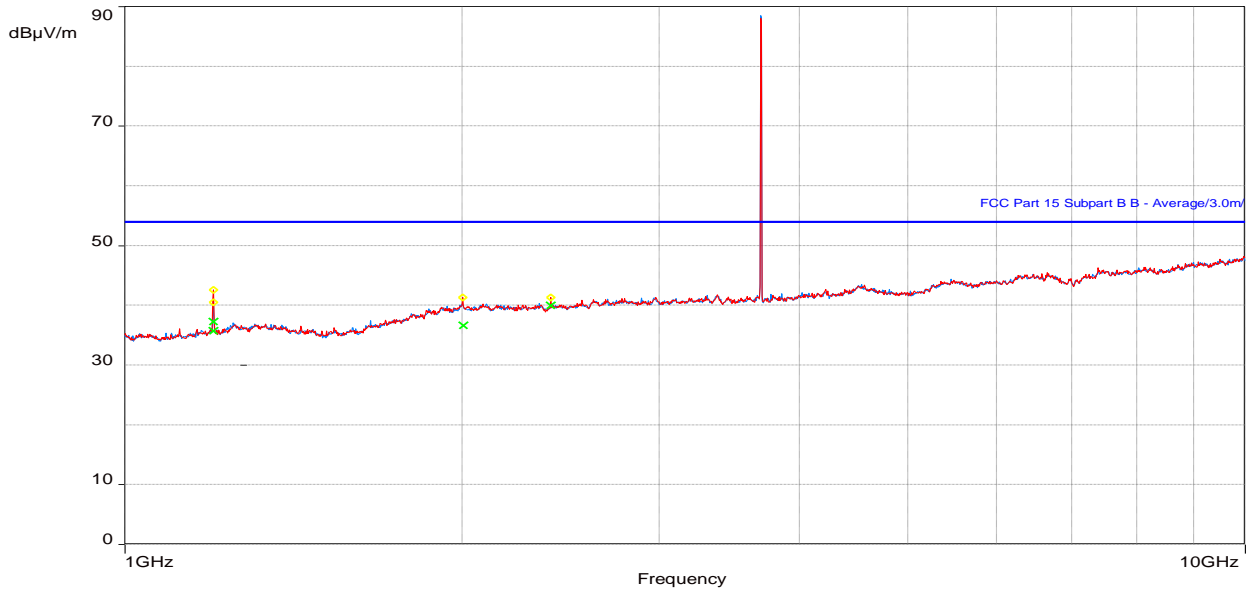

Table 21: RE test results from 1 to 10 GHz for FCC Part 15 (SC, LTE – Top channel) – Cfg 1

Frequency (MHz)	Level Average (dBµV)	Limit Average (dBµV)	Margin to FCC part 15 Class B (dB)	Height (m)	Azimuth (degrees)	Polarization	Correction (dB)
1199.719872	37.26	53.96	-16.70	2.56	88.75	Vertical	2.24
2004.603526	36.63	53.96	-17.33	3.89	314.25	Vertical	7.73
2399.985897	39.98	53.96	-13.98	3.40	192.00	Vertical	7.71
1200.094872	35.71	53.96	-18.25	2.86	177.50	Horizontal	2.25

Table 22: RE test results from 1 to 10 GHz for FCC Part 96 (SC, LTE – Top channel) – Cfg 1

Frequency (MHz)	Level (dBµV)	Limit EIRP (dBµV)	Margin to EIRP Limit (dB)	Height (m)	Azimuth (deg)	Polarization	Correction (dB)
1199.719872	37.26	55.23	-17.97	2.56	88.75	Vertical	2.24
2004.603526	36.63	55.23	-18.6	3.89	314.25	Vertical	7.73
2399.985897	39.98	55.23	-15.25	3.40	192.00	Vertical	7.71
1200.094872	35.71	55.23	-19.52	2.86	177.50	Horizontal	2.25

Note: In the table/Plot above, no emissions exceed the Part 96 radiated spurious emissions limit when converted to dBuV/m, except for the fundamental. For final spurious emissions measurements to FCC Part 96, see antenna port conducted emissions in applicable test report.

Figure 22: Plot of RE at 3m from 10 to 18 GHz (SC, LTE – Top channel) – Cfg 1

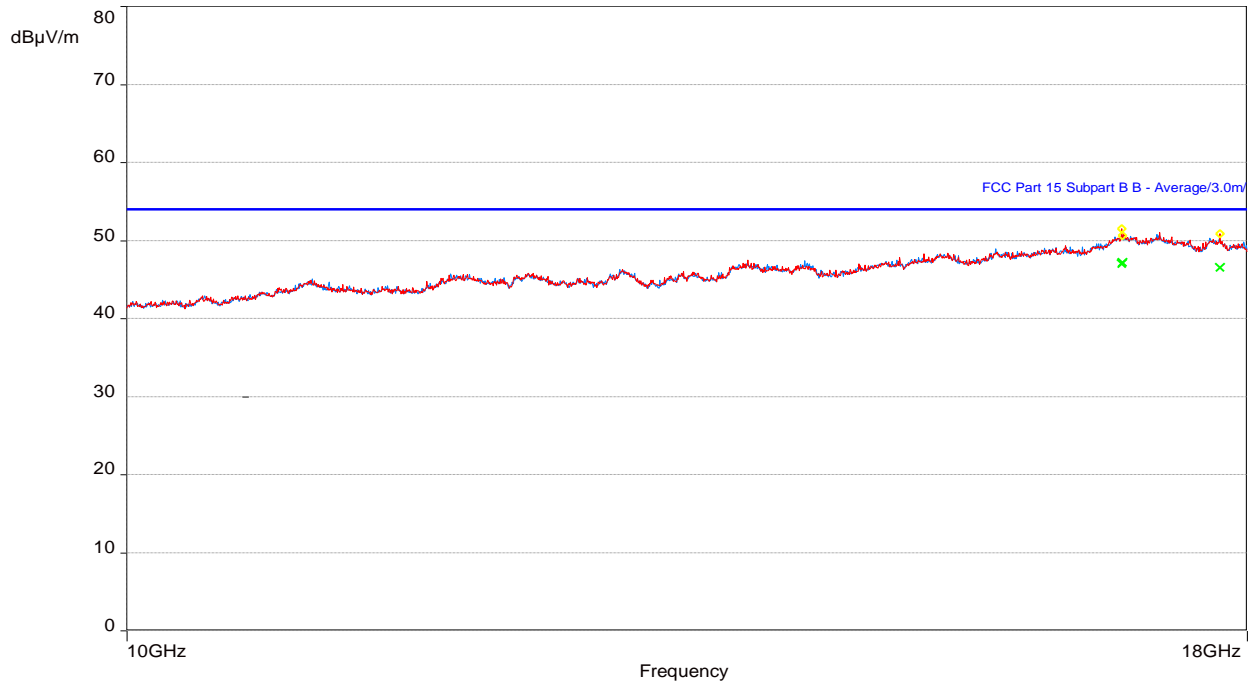

Table 23: RE test results from 10 to 18 GHz for FCC Part 15 (SC, LTE – Top channel) – Cfg 1

Frequency (MHz)	Level Average (dBµV)	Limit Average (dBµV)	Margin to FCC part 15 Class B (dB)	Height (m)	Azimuth (degrees)	Polarization	Correction (dB)
16855.39872	46.96	53.96	-7.00	2.97	278.50	Vertical	17.15
17747.90865	46.52	53.96	-7.44	3.38	38.50	Vertical	17.01
16860.67082	47.13	53.96	-6.83	1.04	350.50	Horizontal	17.17

Table 24: RE test results from 10 to 18 GHz for FCC Part 96 (SC, LTE – Top channel) – Cfg 1

Frequency (MHz)	Level (dBµV)	Limit EIRP (dBµV)	Margin to EIRP Limit (dB)	Height (m)	Azimuth (deg)	Polarization	Correction (dB)
16855.39872	46.96	55.23	-8.27	2.97	278.50	Vertical	17.15
17747.90865	46.52	55.23	-8.71	3.38	38.50	Vertical	17.01
16860.67082	47.13	55.23	-8.10	1.04	350.50	Horizontal	17.17

Note: In the table/Plot above, no emissions exceeded the Part 96 radiated spurious emissions limit when converted to dBuV/m. For final spurious emissions measurements to FCC Part 96, see antenna port conducted emissions in applicable test report.



3.2.8 Test results of RE – Single RAT / Carrier (NR – Middle channel) – Cfg 1

Test location: 10-meter Ambient Free Chamber (AFC)

Date tested: 15 - 17 February 2022

Tested by: Tom Ott

Test configurations are listed as SC NR in 2.4.1.2 as identified in the section [Configurations of the EUT](#). For the following test results that have supporting data tables, negative margin values indicate a pass.

Red trace – Vertical antenna polarity, **Blue trace** – Horizontal antenna polarity

Figure 23: Plot of RE at 3m from 1 to 10 GHz (SC, NR – Middle channel) – Cfg 1

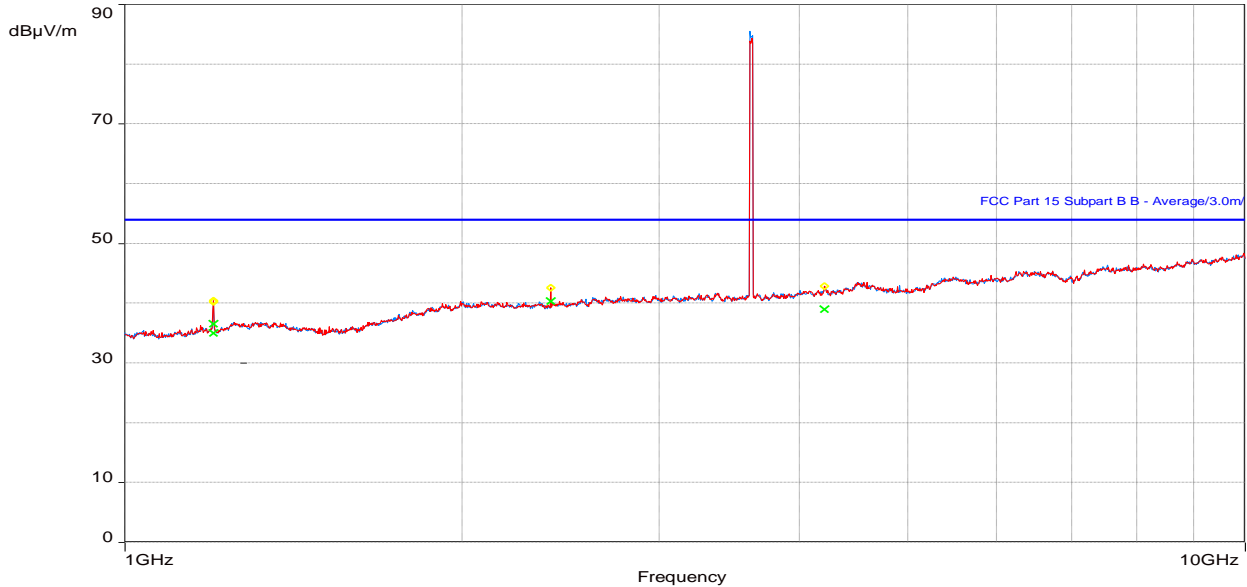

Note: Peak above the limit is leakage of the EUT’s fundamentals from the 50-ohm terminations.

Table 25: RE test results from 1 to 10 GHz for FCC Part 15 (SC, NR – Middle channel) – Cfg 1

Frequency (MHz)	Level Average (dBµV)	Limit Average (dBµV)	Margin to FCC part 15 Class B (dB)	Height (m)	Azimuth (degrees)	Polarization	Correction (dB)
1199.862821	36.50	53.96	-17.46	2.56	140.50	Vertical	2.24
2399.982692	40.33	53.96	-13.63	1.66	218.25	Vertical	7.71
4212.520513	38.96	53.96	-15.00	2.21	333.50	Vertical	10.49
1200.094872	35.02	53.96	-18.94	3.00	205.25	Horizontal	2.25

Table 26: RE test results from 1 to 10 GHz for FCC Part 96 (SC, NR – Middle channel) – Cfg 1

Frequency (MHz)	Level (dBµV)	Limit EIRP (dBµV)	Margin to EIRP Limit (dB)	Height (m)	Azimuth (deg)	Polarization	Correction (dB)
1199.862821	36.50	55.23	-18.73	2.56	140.50	Vertical	2.24
2399.982692	40.33	55.23	-14.90	1.66	218.25	Vertical	7.71
4212.520513	38.96	55.23	-16.27	2.21	333.50	Vertical	10.49
1200.094872	35.02	55.23	-20.21	3.00	205.25	Horizontal	2.25

Note: In the table/Plot above, no emissions exceed the Part 96 radiated spurious emissions limit when converted to dBuV/m, except for the fundamental. For final spurious emissions measurements to FCC Part 96, see antenna port conducted emissions in applicable test report.

Figure 24: Plot of RE at 3m from 10 to 18 GHz (SC, NR – Middle channel) – Cfg 1

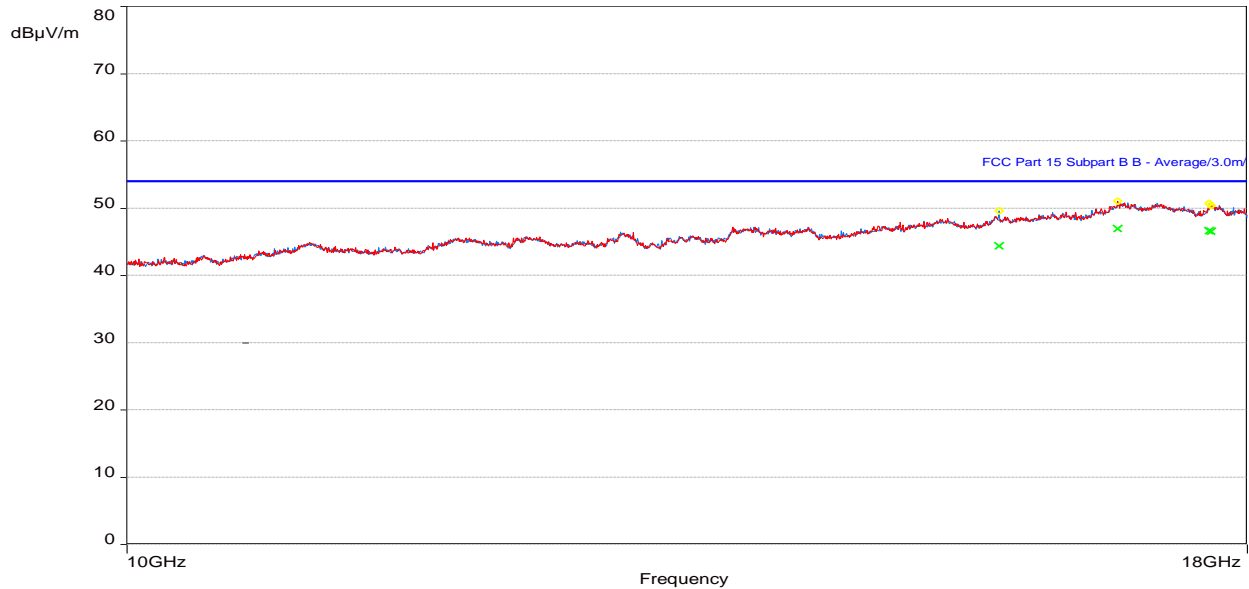

Table 27: RE test results from 10 to 18 GHz for FCC Part 15 (SC, NR – Middle channel) – Cfg 1

Frequency (MHz)	Level Average (dBµV)	Limit Average (dBµV)	Margin to FCC part 15 Class B (dB)	Height (m)	Azimuth (degrees)	Polarization	Correction (dB)
16820.96827	46.89	53.96	-7.07	2.76	271.00	Vertical	17.04
17666.49873	46.53	53.96	-7.43	3.72	312.25	Vertical	16.99
15803.92371	44.31	53.96	-9.65	2.86	304.75	Horizontal	14.80
17646.94905	46.58	53.96	-7.38	1.04	119.75	Horizontal	17.01

Table 28: RE test results from 10 to 18 GHz FCC Part 96 (SC, NR – Middle channel) – Cfg 1

Frequency (MHz)	Level (dBµV)	Limit EIRP (dBµV)	Margin to EIRP Limit (dB)	Height (m)	Azimuth (deg)	Polarization	Correction (dB)
16820.96827	46.89	55.23	-8.34	2.76	271.00	Vertical	17.04
17666.49873	46.53	55.23	-8.70	3.72	312.25	Vertical	16.99
15803.92371	44.31	55.23	-10.92	2.86	304.75	Horizontal	14.80
17646.94905	46.58	55.23	-8.65	1.04	119.75	Horizontal	17.01

Note: In the table/Plot above, no emissions exceed the Part 96 radiated spurious emissions limit when converted to dBuV/m. For final spurious emissions measurements to FCC Part 96, see antenna port conducted emissions in applicable test report.



3.2.9 Test results of RE – Single RAT / Multi Carrier (LTE – Mid channel) – Cfg 1

Test location: 10-meter Ambient Free Chamber (AFC)

Date tested: 15 - 17 February 2022

Tested by: Tom Ott

Test configurations are listed as MC LTE in [2.4.1.3](#) as identified in the section [Configurations of the EUT](#). For the following test results that have supporting data tables, negative margin values indicate a pass.

Red trace – Vertical antenna polarity, **Blue trace** – Horizontal antenna polarity

Figure 25: Plot of RE at 3m from 1 to 10 GHz (MC, LTE – Mid channel) - Cfg 1

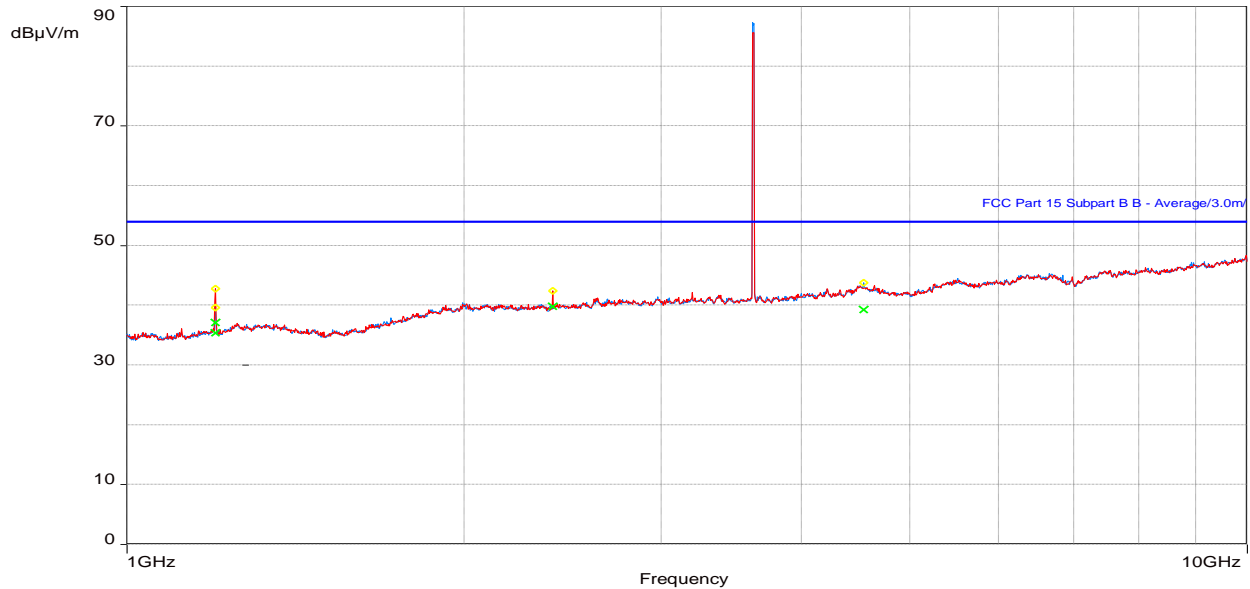

Note: Peak above the limit is leakage of the EUT’s fundamentals from the 50-ohm terminations.

Table 29: RE test results from 1 to 10 GHz for FCC Part 15 (MC, LTE – Mid channel) – Cfg 1

Frequency (MHz)	Level Average (dBµV)	Limit Average (dBµV)	Margin to FCC part 15 Class B (dB)	Height (m)	Azimuth (degrees)	Polarization	Correction (dB)
1199.755128	37.06	53.96	-16.90	2.56	242.50	Vertical	2.24
2399.984295	39.81	53.96	-14.15	4.00	161.75	Vertical	7.71
1199.916987	35.36	53.96	-18.60	3.00	206.25	Horizontal	2.24
4548.353526	39.26	53.96	-14.70	1.73	125.75	Horizontal	10.76

Table 30: RE test results from 1 to 10 GHz for FCC Part 96 (MC, LTE – Mid channel) - Cfg 1

Frequency (MHz)	Level (dBµV)	Limit EIRP (dBµV)	Margin to EIRP Limit (dB)	Height (m)	Azimuth (deg)	Polarization	Correction (dB)
1199.755128	37.06	55.23	-18.17	2.56	242.50	Vertical	2.24
2399.984295	39.81	55.23	-15.42	4.00	161.75	Vertical	7.71
1199.916987	35.36	55.23	-19.87	3.00	206.25	Horizontal	2.24
4548.353526	39.26	55.23	-15.97	1.73	125.75	Horizontal	10.76

Note: In the table/Plot above, no emissions exceed the Part 96 radiated spurious emissions limit when converted to dBuV/m, except for the fundamental. For final spurious emissions measurements to FCC Part 96, see antenna port conducted emissions in applicable test report.

Figure 26: Plot of RE at 3m from 10 to 18 GHz (MC, LTE – Mid channel) – Cfg 1

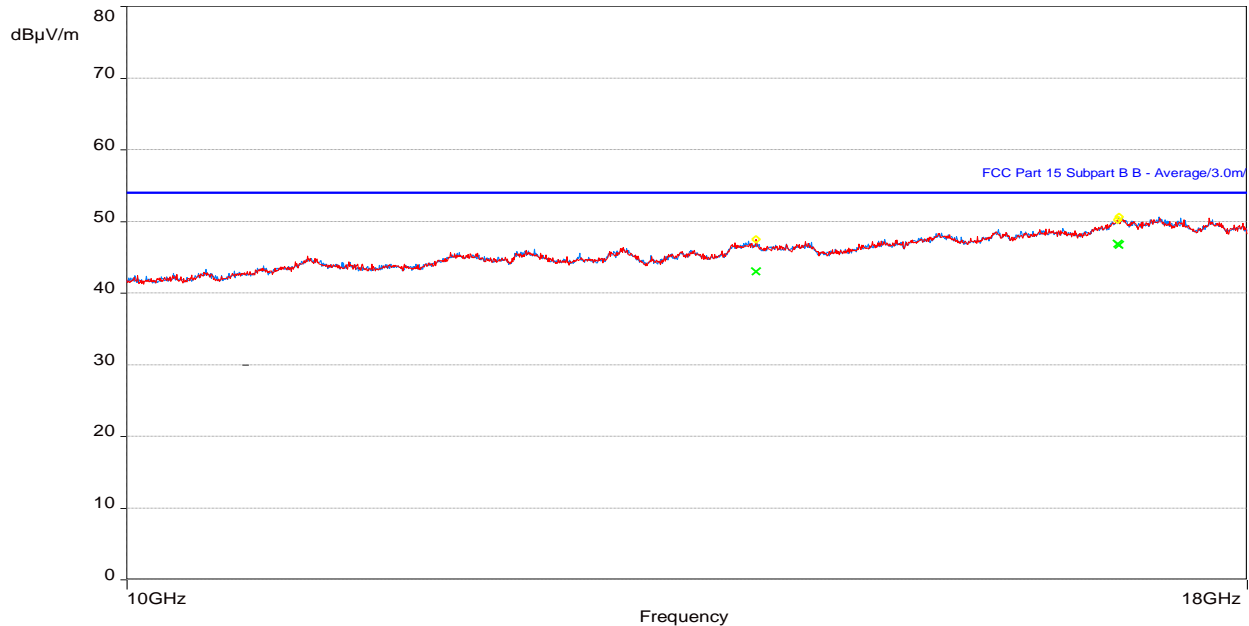

Table 31: RE test results from 10 to 18 GHz for FCC Part 15 (MC, LTE – Mid channel) – Cfg 1

Frequency (MHz)	Level Average (dBµV)	Limit Average (dBµV)	Margin to FCC part 15 Class B (dB)	Height (m)	Azimuth (degrees)	Polarization	Correction (dB)
13910.21153	42.97	53.96	-10.99	1.87	300.00	Vertical	15.06
16820.22531	46.84	53.96	-7.12	4.00	72.75	Vertical	17.04
16832.49133	46.70	53.96	-7.26	3.82	74.50	Horizontal	17.08

Table 32: RE test results from 10 to 18 GHz FCC Part 96 (MC, LTE – Mid channel) – Cfg 1

Frequency (MHz)	Level (dBµV)	Limit EIRP (dBµV)	Margin to EIRP Limit (dB)	Height (m)	Azimuth (deg)	Polarization	Correction (dB)
13910.21153	42.97	55.23	-12.26	1.87	300.00	Vertical	15.06
16820.22531	46.84	55.23	-8.39	4.00	72.75	Vertical	17.04
16832.49133	46.70	55.23	-8.53	3.82	74.50	Horizontal	17.08

Note: In the table/Plot above, no emissions exceed the Part 96 radiated spurious emissions limit when converted to dBuV/m. For final spurious emissions measurements to FCC Part 96, see antenna port conducted emissions in applicable test report.

3.2.10 Test results of RE – (Multi RAT / Multi Carrier – Mid channel) – Cfg 1

Test location: 10-meter Ambient Free Chamber (AFC)

Date tested: 15 - 17 February 2022

Tested by: Tom Ott

Test configurations are listed as MR (LTE + NR) in 2.4.1.4 as identified in the section [Configurations of the EUT](#). For the following test results that have supporting data tables, negative margin values indicate a pass.

Red trace – Vertical antenna polarity, **Blue trace** – Horizontal antenna polarity

Figure 27: Plot of RE at 3 m from 30 to 1000 MHz (MR (LTE + NR) – Mid channel) – Cfg 1

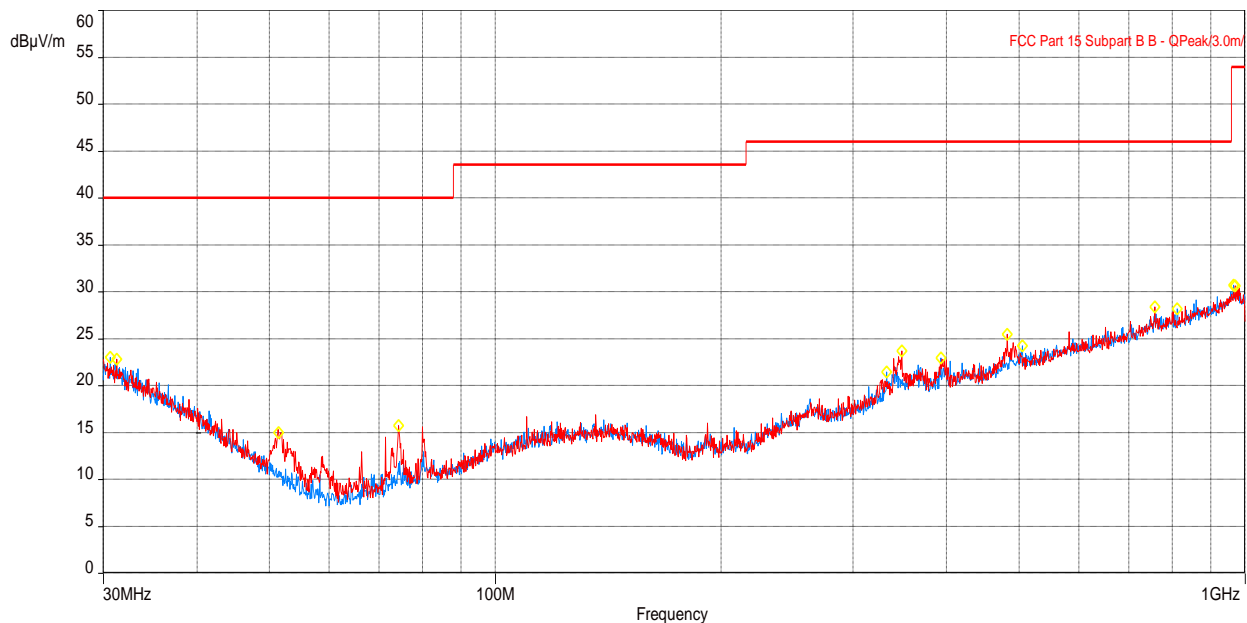

Note 1: In the plot above No Emissions exceeds the FCC Part 15 class B limit.

Note 2: In the plot above, no emissions exceed the Part 96 radiated spurious emissions limit when converted to dBuV/m. For final spurious emissions measurements to FCC Part 96, see antenna port conducted emissions in applicable test report.

Figure 28: Plot of RE at 3m from 1 to 10 GHz (MR (LTE + NR) – Mid channel) – Cfg 1

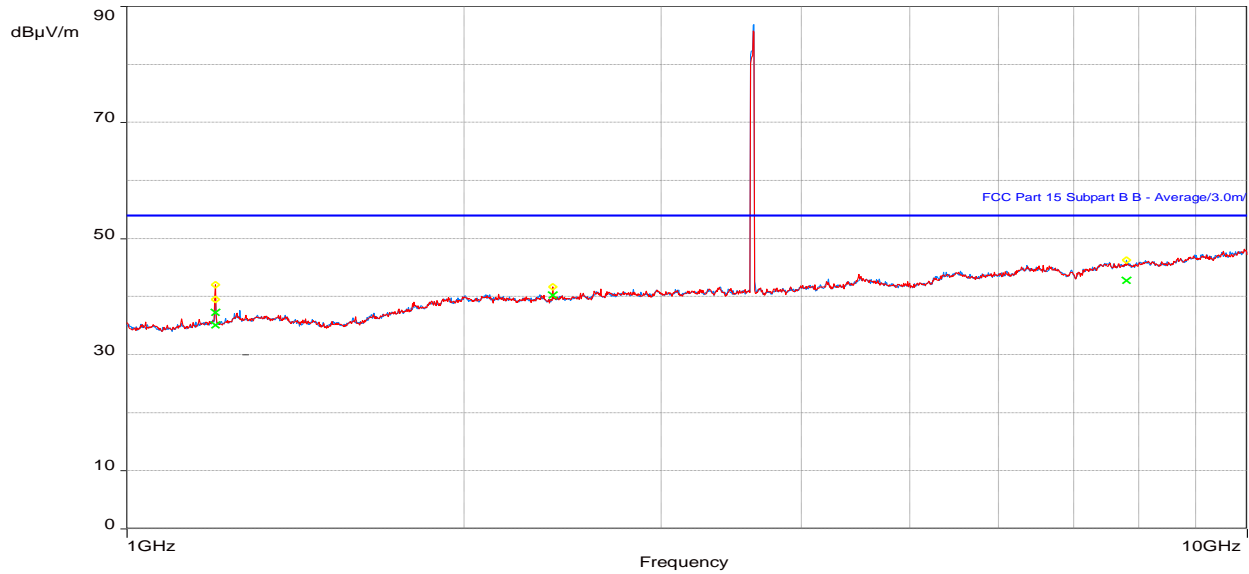

Note: Peak above the limit is leakage of the EUT's fundamentals from the 50-ohm terminations.

Table 33: RE test results from 1 to 10 GHz for FCC Part 15 (MR (LTE + NR) – Mid channel) – Cfg 1

Frequency (MHz)	Level Average (dBµV)	Limit Average (dBµV)	Margin to FCC part 15 Class B (dB)	Height (m)	Azimuth (degrees)	Polarization	Correction (dB)
1199.80	37.19	53.96	-16.77	2.56	242.50	Vertical	2.24
2399.983013	40.20	53.96	-13.76	3.33	191.50	Vertical	7.71
1199.864103	35.05	53.96	-18.91	2.97	256.75	Horizontal	2.24
7802.898077	42.70	53.96	-11.26	1.76	17.00	Horizontal	14.08

Table 34: RE test results from 1 to 10 GHz for FCC Part 96 (MR (LTE + NR) – Mid channel) – Cfg 1

Frequency (MHz)	Level (dBµV)	Limit EIRP (dBµV)	Margin to EIRP Limit (dB)	Height (m)	Azimuth (deg)	Polarization	Correction (dB)
1199.80	37.19	55.23	-18.04	2.56	242.50	Vertical	2.24
2399.983013	40.20	55.23	-15.03	3.33	191.50	Vertical	7.71
1199.864103	35.05	55.23	-20.18	2.97	256.75	Horizontal	2.24
7802.898077	42.70	55.23	-18.04	1.76	17.00	Horizontal	14.08

Note: In the table/Plot above, no emissions exceed the Part 96 radiated spurious emissions limit when converted to dBuV/m, except for the fundamental. For final spurious emissions measurements to FCC Part 96, see antenna port conducted emissions in applicable test report.

Figure 29: Plot of RE at 3m from 10 to 18 GHz (MR (LTE + NR) – Mid channel) – Cfg 1

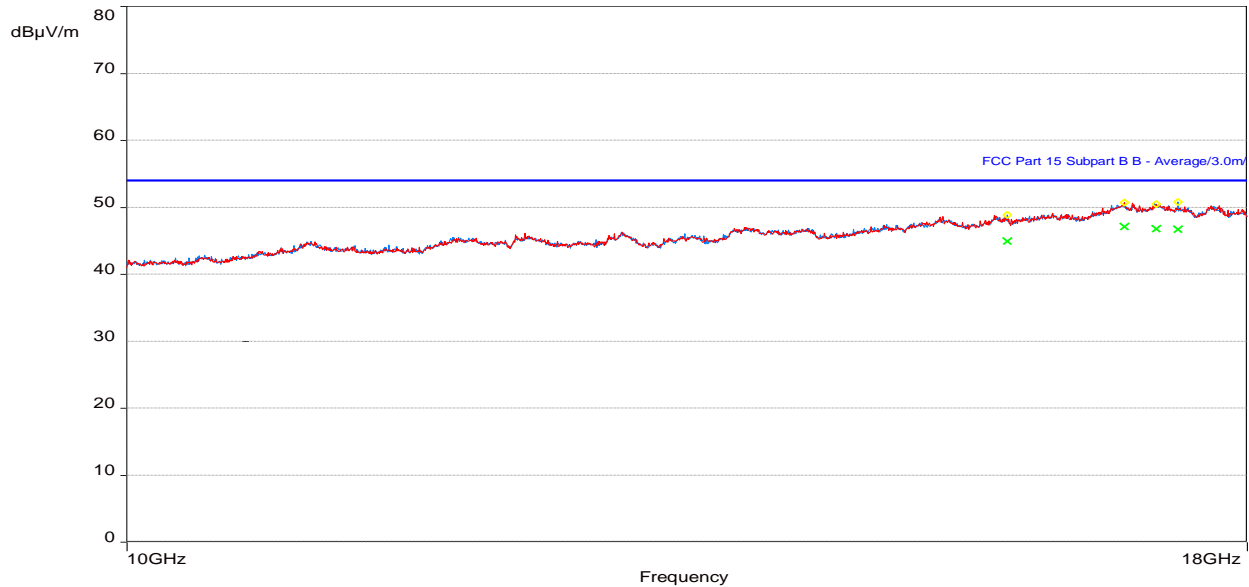

Table 35: RE test results from 10 to 18 GHz for FCC Part 15 (MR (LTE + NR) – Mid ch) - Cfg 1

Frequency (MHz)	Level Average (dBµV)	Limit Average (dBµV)	Margin to FCC part 15 Class B (dB)	Height (m)	Azimuth (degrees)	Polarization	Correction (dB)
16876.89553	47.05	53.96	-6.91	2.90	74.25	Vertical	17.22
17161.91187	46.72	53.96	-7.24	2.97	218.25	Vertical	17.51
15873.17277	44.91	53.96	-9.05	3.79	132.00	Horizontal	14.91
17357.91185	46.70	53.96	-7.26	2.62	98.50	Horizontal	17.52

Table 36: RE test results from 10 to 18 GHz Part 96 (MR (LTE + NR) – Mid channel) – Cfg 1

Frequency (MHz)	Level (dBµV)	Limit EIRP (dBµV)	Margin to EIRP Limit (dB)	Height (m)	Azimuth (deg)	Polarization	Correction (dB)
16876.89553	47.05	55.23	-8.18	2.90	74.25	Vertical	17.22
17161.91187	46.72	55.23	-8.51	2.97	218.25	Vertical	17.51
15873.17277	44.91	55.23	-10.32	3.79	132.00	Horizontal	14.91
17357.91185	46.70	55.23	-8.53	2.62	98.50	Horizontal	17.52

Note: In the table/Plot above, no emissions exceed the Part 96 radiated spurious emissions limit when converted to dBuV/m. For final spurious emissions measurements to FCC Part 96, see antenna port conducted emissions in applicable test report.



3.2.11 Test results of RE – Single RAT / Carrier (LTE – Mid channel) – Cfg 2

Test location: 10-meter Ambient Free Chamber (AFC)

Date tested: 15 - 17 February 2022

Tested by: Tom Ott

Test configurations are listed as SC LTE in [2.4.2.1](#) as identified in the section [Configurations of the EUT](#). For the following test results that have supporting data tables, negative margin values indicate a pass.

Red trace – Vertical antenna polarity, **Blue trace** – Horizontal antenna polarity

Figure 30: Plot of RE at 3 m – 30 to 1000 MHz (SC, LTE – Mid channel) – Cfg 2

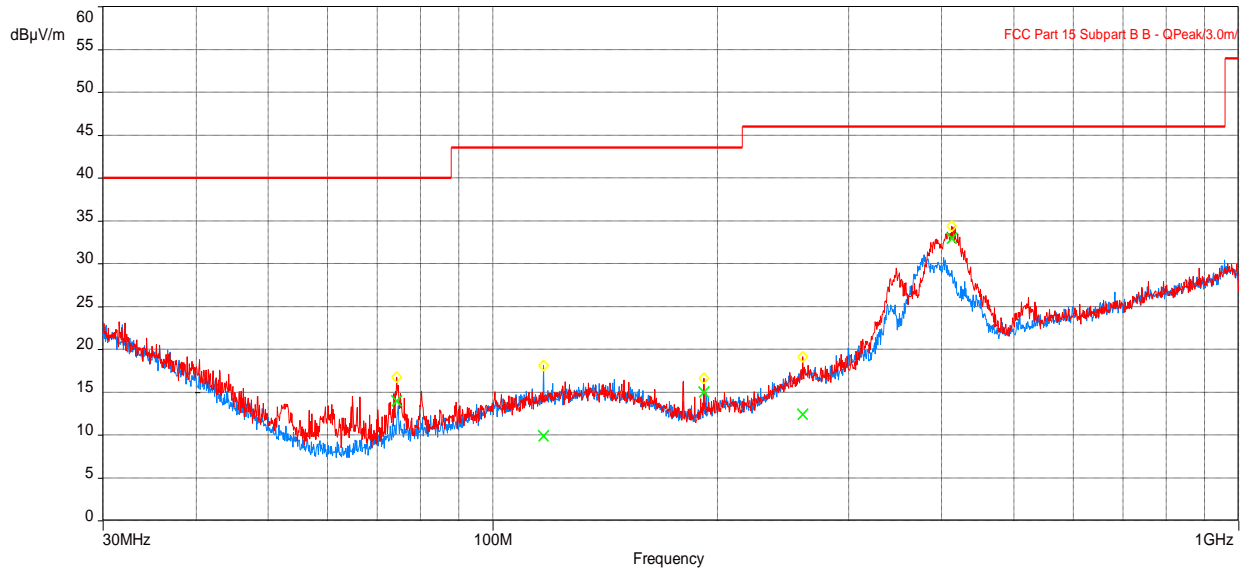

Table 37: RE test results from 30 to 1000 MHz for FCC Part 15 (SC, LTE – Mid channel) – Cfg 2

Frequency (MHz)	Level (dBµV)	Limit Quasi-peak (dBµV)	Margin to FCC part 15 Class B (dB)	Height (m)	Azimuth (deg)	Polarization	Correction (dB)
74.32086572	13.92	40.00	-26.08	1.20	290.50	Vertical	-15.13
191.9944454	14.98	43.52	-28.54	3.94	177.50	Vertical	-11.56
412.8910095	32.93	46.02	-13.09	1.50	55.25	Vertical	-3.78
117.0376441	9.89	43.52	-33.63	1.00	26.25	Horizontal	-10.14

Table 38: RE test results from 30 to 1000 MHz for FCC Part 96 (SC, LTE – Mid channel) – Cfg 2

Frequency (MHz)	Level (dBµV)	Limit EIRP (dBµV)	Margin to EIRP Limit (dB)	Height (m)	Azimuth (deg)	Polarization	Correction (dB)
74.32086572	13.92	55.23	-41.31	1.20	290.50	Vertical	-15.13
191.9944454	14.98	55.23	-40.25	3.94	177.50	Vertical	-11.56
412.8910095	32.93	55.23	-22.30	1.50	55.25	Vertical	-3.78
117.0376441	9.89	55.23	-45.34	1.00	26.25	Horizontal	-10.14

Note: In the table/Plot above, no emissions exceed the Part 96 radiated spurious emissions limit when converted to dBuV/m. For final spurious emissions measurements to FCC Part 96, see antenna port conducted emissions in applicable test report.

Figure 31: Plot of RE at 3m from 1 to 10 GHz (SC, LTE – Mid channel) – Cfg 2

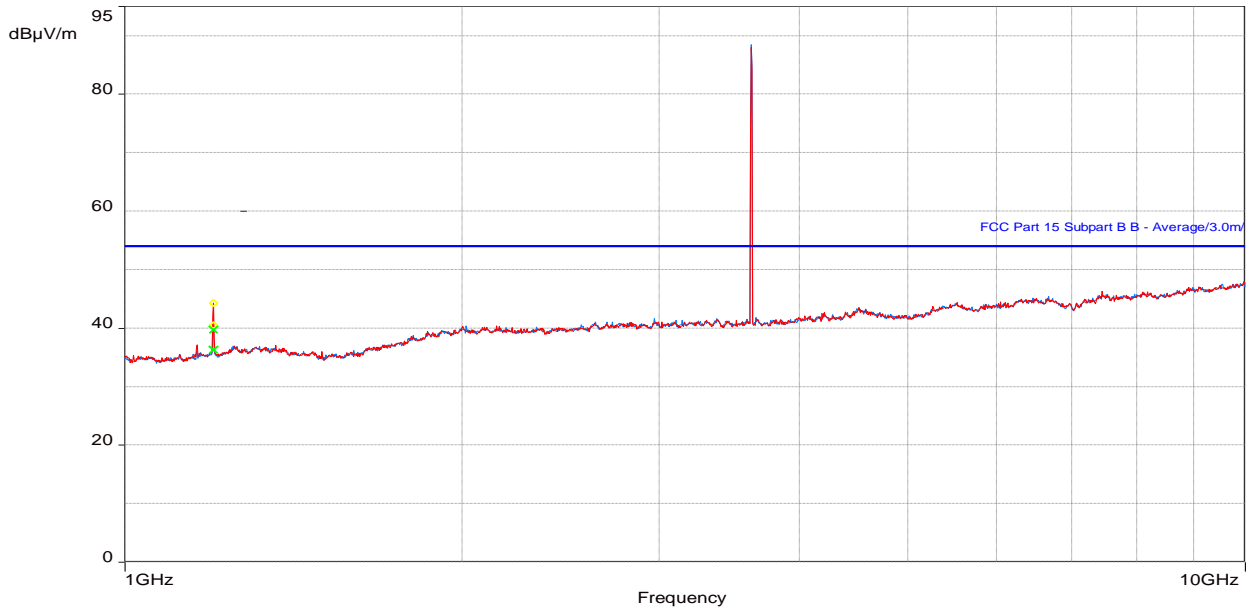

Note: Peak above the limit is leakage of the EUT’s fundamentals from the 50-ohm terminations.

Table 39: RE test results from 1 to 10 GHz for FCC Part 15 (SC, LTE – Mid channel) – Cfg 2

Frequency (MHz)	Level Average (dBµV)	Limit Average (dBµV)	Margin to FCC part 15 Class B (dB)	Height (m)	Azimuth (degrees)	Polarization	Correction (dB)
1199.860897	39.67	53.96	-14.29	2.56	256.75	Vertical	2.24
1199.832051	36.23	53.96	-17.73	3.75	197.75	Horizontal	2.24

Table 40: RE test results from 1 to 10 GHz for FCC Part 96 (SC, LTE – Mid channel) – Cfg 2

Frequency (MHz)	Level (dBµV)	Limit EIRP (dBµV)	Margin to EIRP Limit (dB)	Height (m)	Azimuth (deg)	Polarization	Correction (dB)
1199.860897	39.67	55.23	-15.56	2.56	256.75	Vertical	2.24
1199.832051	36.23	55.23	-19.00	3.75	197.75	Horizontal	2.24

Note: In the table/Plot above, no emissions exceed the Part 96 radiated spurious emissions limit when converted to dBuV/m. For final spurious emissions measurements to FCC Part 96, see antenna port conducted emissions in applicable test report.

Figure 32: Plot of RE at 3m from 10 to 18 GHz (SC, LTE – Mid channel) – Cfg 2

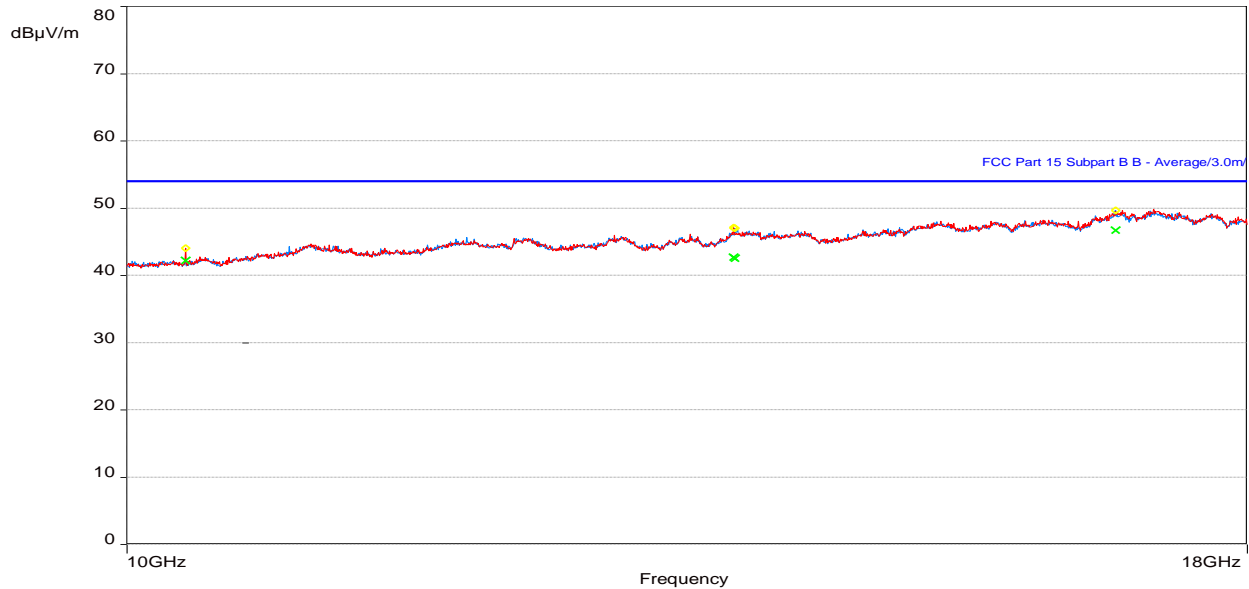

Table 41: RE test results from 10 to 18 GHz for FCC Part 15 (SC, LTE – Mid channel) – Cfg 2

Frequency (MHz)	Level Average (dBµV)	Limit Average (dBµV)	Margin to FCC part 15 Class B (dB)	Height (m)	Azimuth (degrees)	Polarization	Correction (dB)
10312.43367	42.16	53.96	-11.80	3.59	141.75	Vertical	9.94
13751.47662	42.66	53.96	-11.30	1.28	120.00	Vertical	14.91
13758.27758	42.49	53.96	-11.47	2.21	211.25	Horizontal	14.90
16798.79841	46.69	53.96	-7.27	2.42	139.25	Horizontal	16.96

Table 42: RE test results from 10 to 18 GHz for FCC Part 96 (SC, LTE – Mid channel) – Cfg 2

Frequency (MHz)	Level (dBµV)	Limit EIRP (dBµV)	Margin to EIRP Limit (dB)	Height (m)	Azimuth (deg)	Polarization	Correction (dB)
10312.43367	42.16	55.23	-13.07	3.59	141.75	Vertical	9.94
13751.47662	42.66	55.23	-12.57	1.28	120.00	Vertical	14.91
13758.27758	42.49	55.23	-12.74	2.21	211.25	Horizontal	14.90
16798.79841	46.69	55.23	-8.54	2.42	139.25	Horizontal	16.96

Note: In the table/Plot above, no emissions exceed the Part 96 radiated spurious emissions limit when converted to dBuV/m. For final spurious emissions measurements to FCC Part 96, see antenna port conducted emissions in applicable test report.

Figure 33: Plot of RE at 1m from 18 to 26.5 GHz (SC, LTE – Mid channel) – Cfg 2

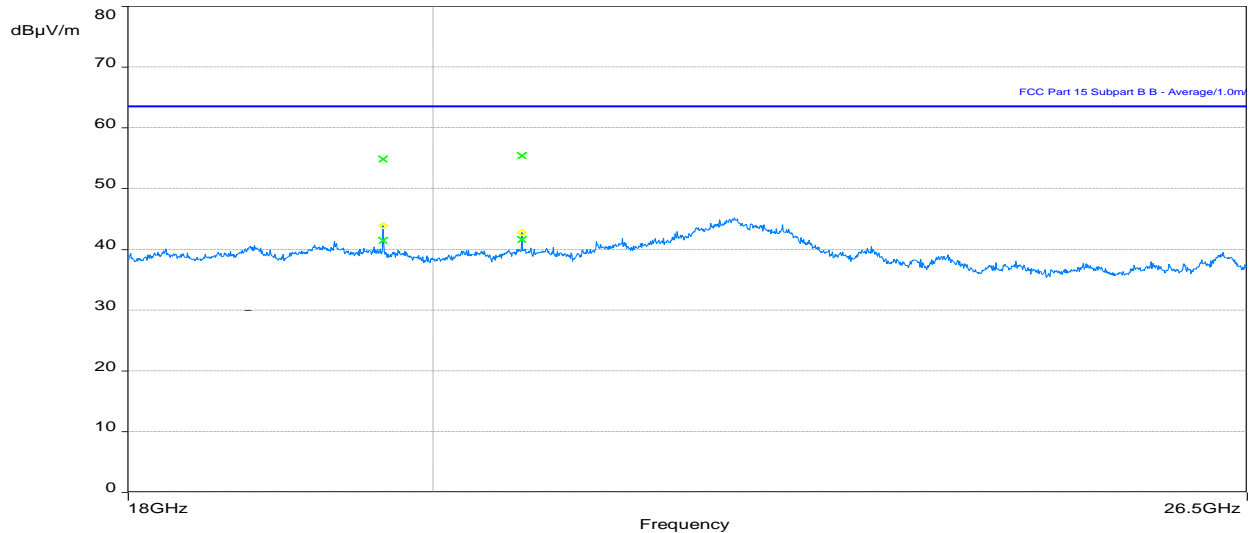

Note 1: In the plot above No Emissions exceeds the FCC Part 15 class B limit.

Note 2: In the plot above, no emissions exceed the Part 96 radiated spurious emissions limit when converted to dBuV/m. For final spurious emissions measurements to FCC Part 96, see antenna port conducted emissions in applicable test report.

Figure 34: Plot of RE at 1m from 26.5 to 40 GHz (SC, LTE – Mid channel) – Cfg 2

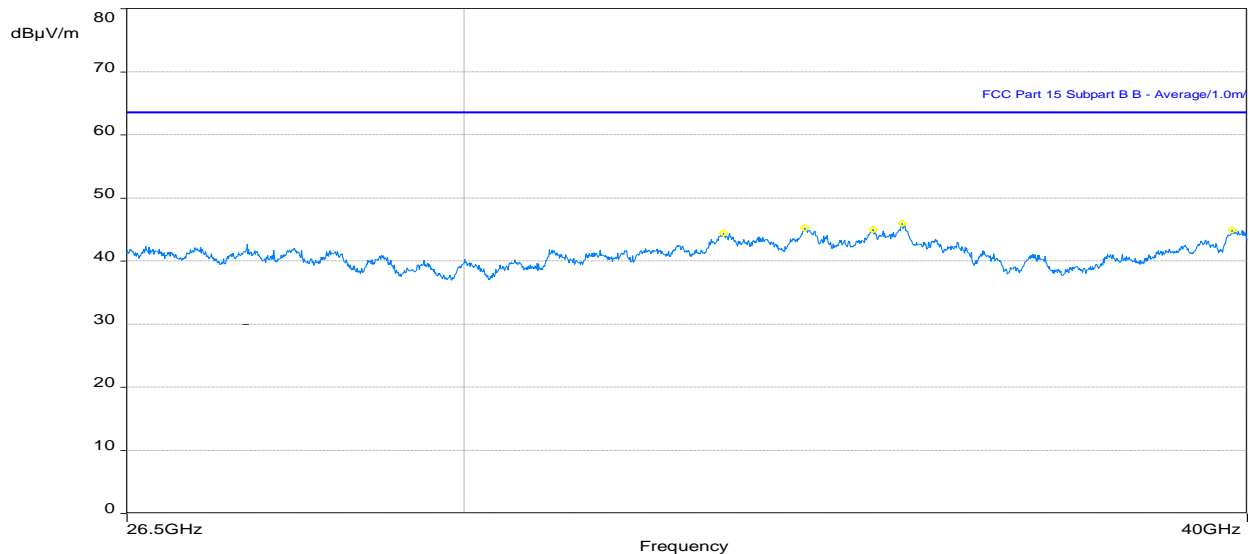

Note 1: In the plot above No Emissions exceeds the FCC Part 15 class B limit.

Note 2: In the plot above, no emissions exceed the Part 96 radiated spurious emissions limit when converted to dBuV/m. For final spurious emissions measurements to FCC Part 96, see antenna port conducted emissions in applicable test report.



3.2.12 Test results of RE – Single RAT / Multi Carrier (LTE) – Cfg 2

Test location: 10-meter Ambient Free Chamber (AFC)

Date tested: 15 - 17 February 2022

Tested by: Tom Ott

Test configurations are listed as MC LTE in [2.4.2.2](#) as identified in the section [Configurations of the EUT](#). For the following test results that have supporting data tables, negative margin values indicate a pass.

Red trace – Vertical antenna polarity, **Blue trace** – Horizontal antenna polarity

Figure 35: Plot of RE at 3m from 1 to 10 GHz (MC, LTE) – Cfg 2

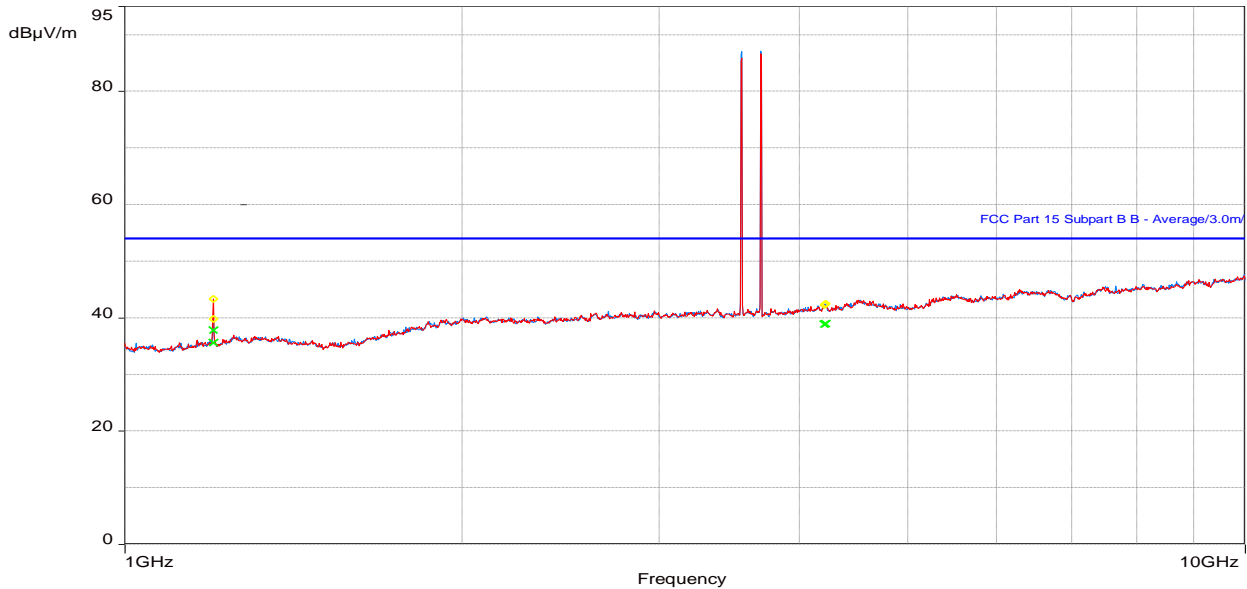

Note: Peaks above the limit are leakage of the EUT's fundamentals from the 50-ohm terminations.

Table 43: RE test results from 1 to 10 GHz for FCC Part 15 (MC, LTE) – Cfg 2

Frequency (MHz)	Level Average (dBµV)	Limit Average (dBµV)	Margin to FCC part 15 Class B (dB)	Height (m)	Azimuth (degrees)	Polarization	Correction (dB)
1199.979487	37.78	53.96	-16.18	2.56	333.75	Vertical	2.24
4212.449679	38.79	53.96	-15.17	3.66	211.50	Vertical	10.49
1199.753526	35.54	53.96	-18.42	3.00	199.25	Horizontal	2.24
4221.923077	38.96	53.96	-15.00	3.24	45.75	Horizontal	10.45

Table 44: RE test results from 1 to 10 GHz for FCC Part 96 (MC, LTE) – Cfg 2

Frequency (MHz)	Level (dBµV)	Limit EIRP (dBµV)	Margin to EIRP Limit (dB)	Height (m)	Azimuth (deg)	Polarization	Correction (dB)
1199.979487	37.78	55.23	-17.45	2.56	333.75	Vertical	2.24
4212.449679	38.79	55.23	-16.44	3.66	211.50	Vertical	10.49
1199.753526	35.54	55.23	-19.69	3.00	199.25	Horizontal	2.24
4221.923077	38.96	55.23	-16.27	3.24	45.75	Horizontal	10.45

Note: In the table/Plot above, no emissions exceed the Part 96 radiated spurious emissions limit when converted to dBuV/m, except for the fundamental. For final spurious emissions measurements to FCC Part 96, see antenna port conducted emissions in applicable test report.

Figure 36: Plot of RE at 3m from 10 to 18 GHz (MC, LTE) – Cfg 2

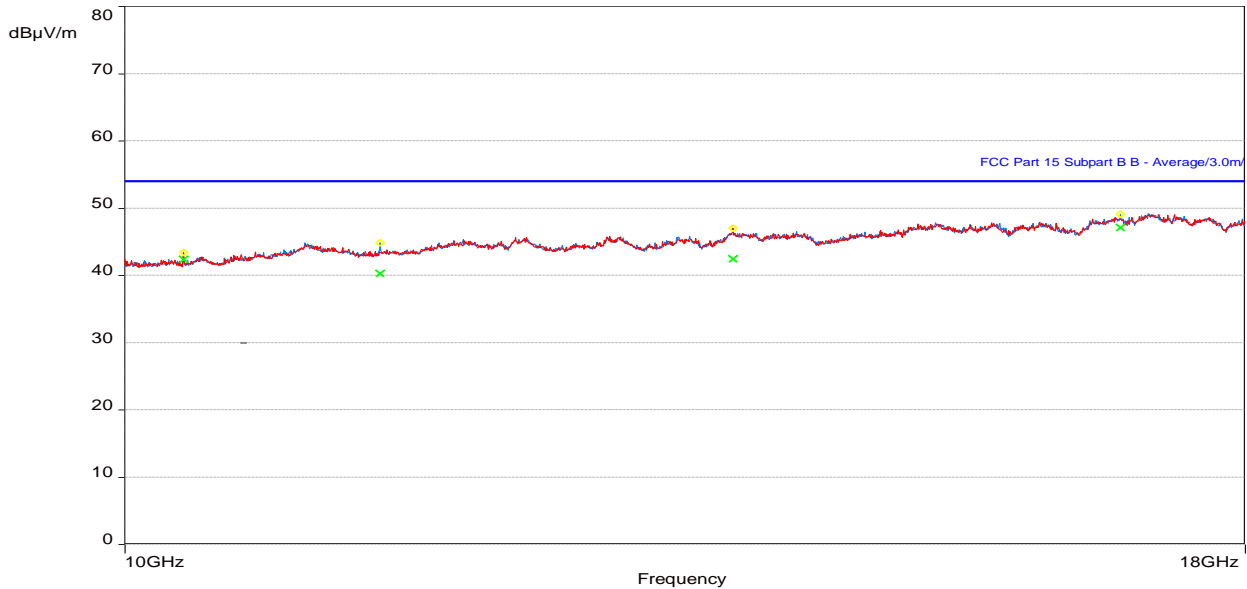

Table 45: RE test results from 10 to 18 GHz for FCC Part 15 (MC, LTE) – Cfg 2

Frequency (MHz)	Level Average (dBµV)	Limit Average (dBµV)	Margin to FCC part 15 Class B (dB)	Height (m)	Azimuth (degrees)	Polarization	Correction (dB)
10312.43046	42.34	53.96	-11.62	3.62	141.50	Vertical	9.94
13757.62404	42.45	53.96	-11.51	1.82	177.50	Vertical	14.90
16859.87179	47.04	53.96	-6.92	3.82	0.00	Horizontal	17.17

Table 46: RE test results from 10 to 18 GHz FCC Part 96 (MC, LTE) – Cfg 2

Frequency (MHz)	Level (dBµV)	Limit EIRP (dBµV)	Margin to EIRP Limit (dB)	Height (m)	Azimuth (deg)	Polarization	Correction (dB)
10312.43046	42.34	55.23	-12.89	3.62	141.50	Vertical	9.94
13757.62404	42.45	55.23	-12.78	1.82	177.50	Vertical	14.90
16859.87179	47.04	55.23	-8.19	3.82	0.00	Horizontal	17.17

Note: In the table/Plot above, no emissions exceed the Part 96 radiated spurious emissions limit when converted to dBµV/m. For final spurious emissions measurements to FCC Part 96, see antenna port conducted emissions in applicable test report.

3.2.13 Test results of RE – (Multi RAT / Multi Carrier) – Cfg 2

Test location: 10-meter Ambient Free Chamber (AFC)

Date tested: 15 - 17 February 2022

Tested by: Tom Ott

Test configurations are listed as MR (LTE + NR) in 2.4.2.3 as identified in the section [Configurations of the EUT](#). For the following test results that have supporting data tables, negative margin values indicate a pass.

Red trace – Vertical antenna polarity, Blue trace – Horizontal antenna polarity

Figure 37: Plot of RE at 3 m from 30 to 1000 MHz (MR (LTE + NR)) – Cfg 2

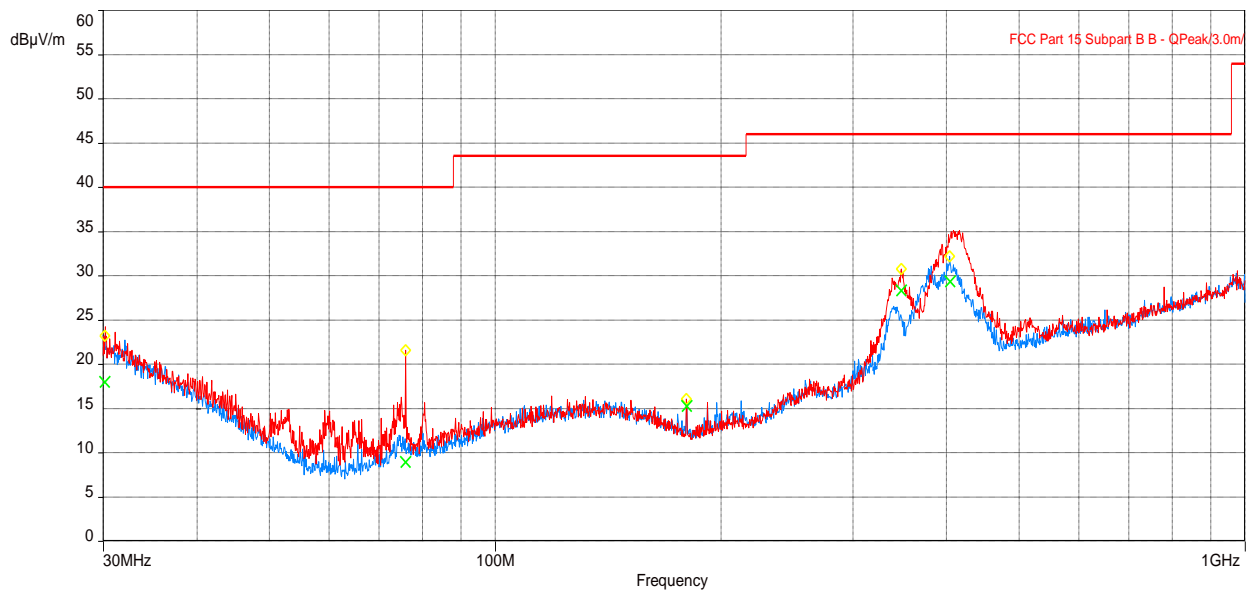

Note 1: In the plot above No Emissions exceeds the FCC Part 15 class B limit.

Note 2: In the plot above, no emissions exceed the Part 96 radiated spurious emissions limit when converted to dBuV/m. For final spurious emissions measurements to FCC Part 96, see antenna port conducted emissions in applicable test report.

Figure 38: Plot of RE at 3m from 1 to 10 GHz (MR (LTE + NR)) – Cfg 2

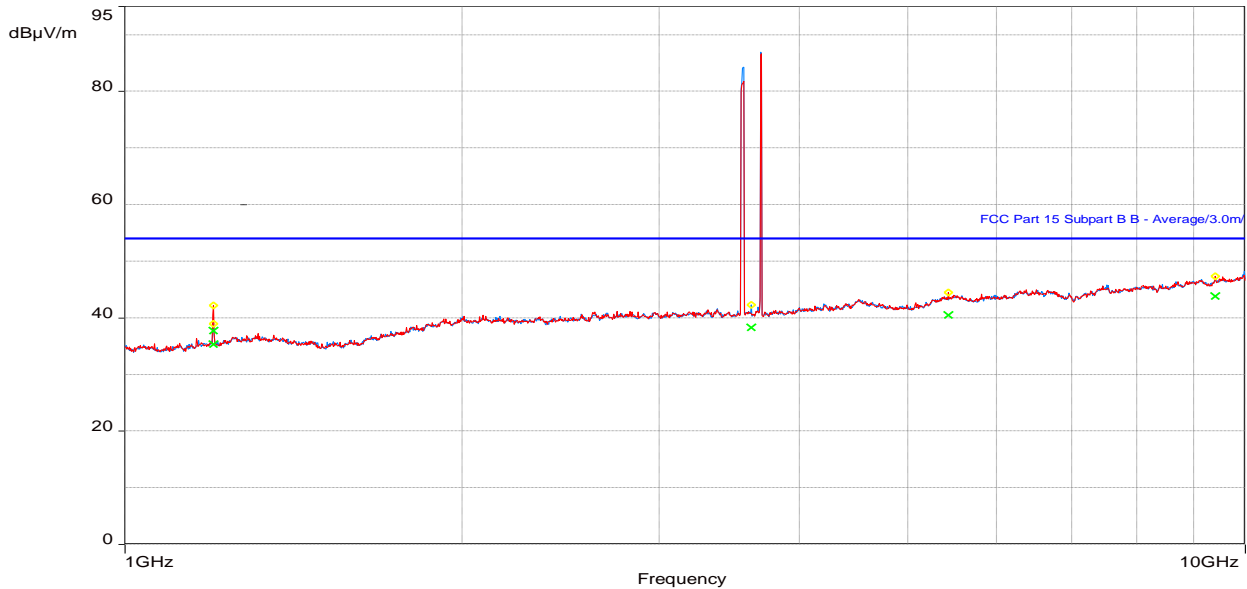

Note: Peaks above the limit are leakage of the EUT’s fundamentals from the 50-ohm terminations.

Table 47: RE test results from 1 to 10 GHz for FCC Part 15 (MR (LTE + NR)) – Cfg 2

Frequency (MHz)	Level Average (dBµV)	Limit Average (dBµV)	Margin to FCC part 15 Class B (dB)	Height (m)	Azimuth (degrees)	Polarization	Correction (dB)
1199.896154	37.70	53.96	-16.26	2.56	127.25	Vertical	2.24
5437.092949	40.47	53.96	-13.49	2.21	292.50	Vertical	12.25
9401.788782	43.79	53.96	-10.17	1.46	278.25	Vertical	15.32
1199.769231	35.33	53.96	-18.63	3.00	204.00	Horizontal	2.24

Table 48: RE test results from 1 to 10 GHz for FCC Part 96 (MR (LTE + NR)) – Cfg 2

Frequency (MHz)	Level (dBµV)	Limit EIRP (dBµV)	Margin to EIRP Limit (dB)	Height (m)	Azimuth (deg)	Polarization	Correction (dB)
1199.896154	37.70	55.23	-17.53	2.56	127.25	Vertical	2.24
5437.092949	40.47	55.23	-14.76	2.21	292.50	Vertical	12.25
9401.788782	43.79	55.23	-11.44	1.46	278.25	Vertical	15.32
1199.769231	35.33	55.23	-19.9	3.00	204.00	Horizontal	2.24

Note: In the table/Plot above, no emissions exceed the Part 96 radiated spurious emissions limit when converted to dBuV/m, except for the fundamental. For final spurious emissions measurements to FCC Part 96, see antenna port conducted emissions in applicable test report.

Figure 39: Plot of RE at 3m from 10 to 18 GHz (MR (LTE + NR)) – Cfg 2

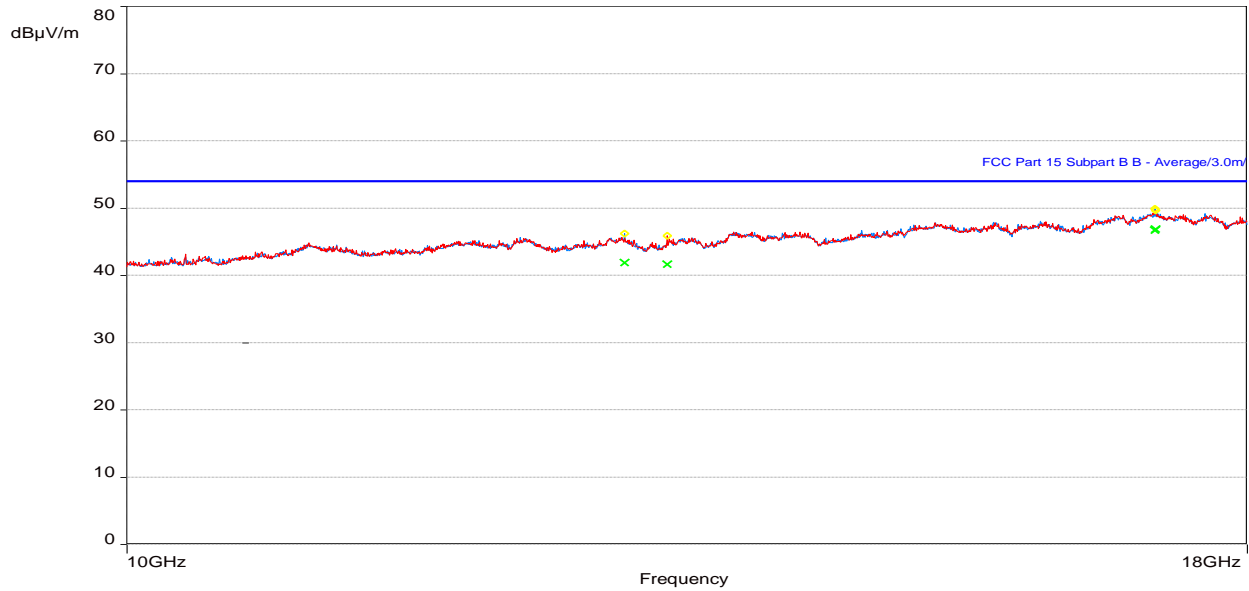

Table 49: RE test results from 10 to 18 GHz for FCC Part 15 (MR (LTE + NR)) – Cfg 2

Frequency (MHz)	Level Average (dBµV)	Limit Average (dBµV)	Margin to FCC part 15 Class B (dB)	Height (m)	Azimuth (degrees)	Polarization	Correction (dB)
13277.72918	41.61	53.96	-12.35	2.08	297.25	Vertical	14.51
17157.93428	46.83	53.96	-7.13	3.31	45.75	Vertical	17.51
12983.47662	41.89	53.96	-12.07	1.46	254.50	Horizontal	13.94
17150.04486	46.71	53.96	-7.25	3.14	170.25	Horizontal	17.51

Table 50: RE test results from 10 to 18 GHz FCC Part 96 (MR (LTE + NR)) – Cfg 2

Frequency (MHz)	Level (dBµV)	Limit EIRP (dBµV)	Margin to EIRP Limit (dB)	Height (m)	Azimuth (deg)	Polarization	Correction (dB)
13277.72918	41.61	55.23	-13.62	2.08	297.25	Vertical	14.51
17157.93428	46.83	55.23	-8.40	3.31	45.75	Vertical	17.51
12983.47662	41.89	55.23	-13.34	1.46	254.50	Horizontal	13.94
17150.04486	46.71	55.23	-8.52	3.14	170.25	Horizontal	17.51

Note: In the table/Plot above, no emissions exceed the Part 96 radiated spurious emissions limit when converted to dBuV/m. For final spurious emissions measurements to FCC Part 96, see antenna port conducted emissions in applicable test report.

3.2.14 Radiated Emissions test setup picture

Figure 40: Setup for RE tests

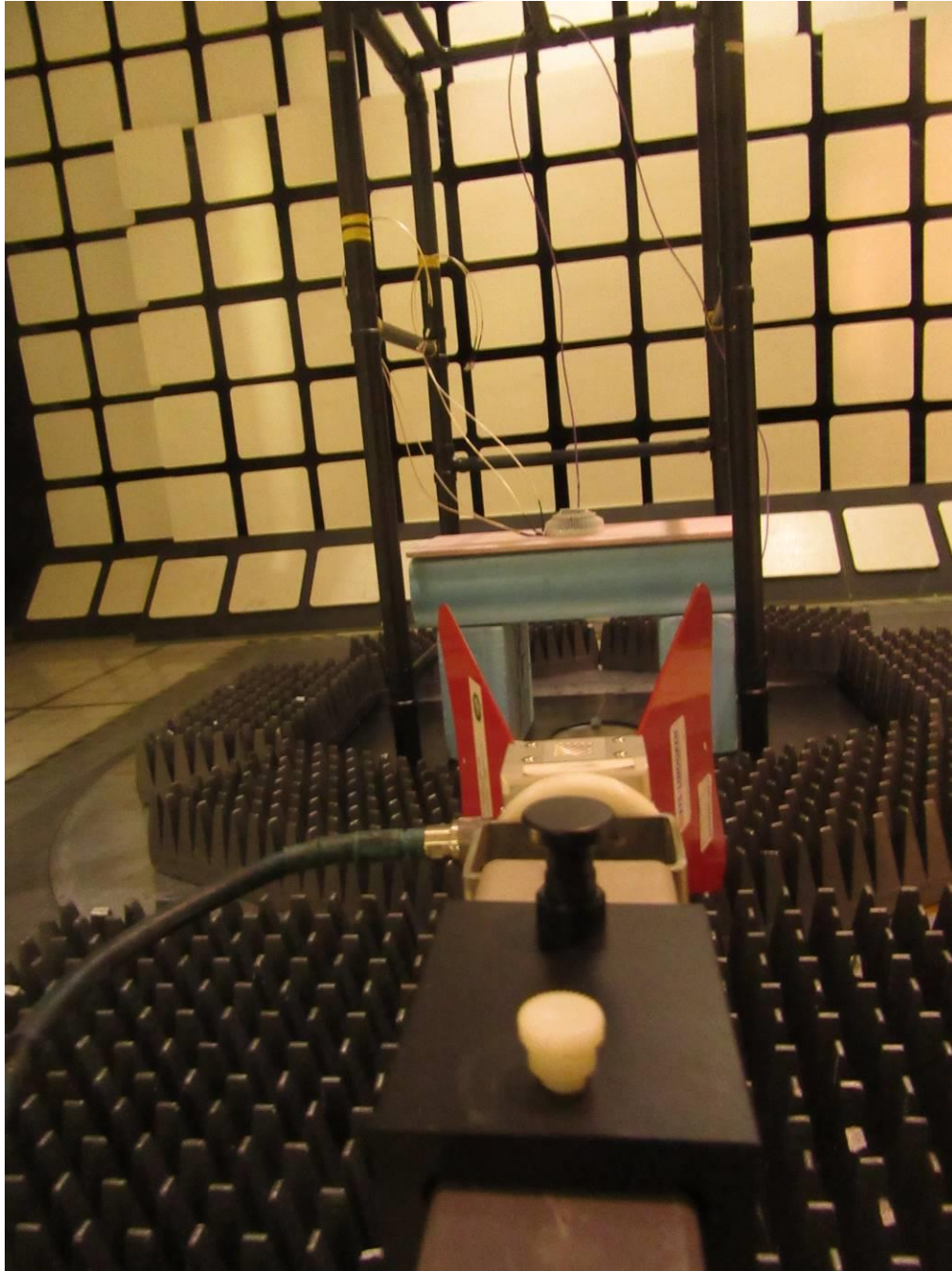



3.2.15 Test equipment

The equipment used for E-field RE testing was as follows.

Table 51: Test equipment used for RE

Description	Make	Model number	Asset ID	Calibr. date	Calibr. due
EMC Automation Software	Nexio V3.18	BAT-EMC	F0163649	Not required	Not required
Bilog Antenna	TESEQ	CBL 6111D	SSG013965	2021-05-04	2022-05-04
Horn Antenna 3MCH 00003	ETS	3117	LAVE04211	2021-03-30	2022-03-30
Ant 3MCH 00004	ETS	3116	LAVE04210	2021-11-05	2023-11-05
EMI Receiver	Rohde & Schwarz	ESU26	SSG013729	2021-03-31	2022-03-31
Spectrum analyzer	Rohde & Schwarz	ESU-40	LAVE04092	2020-07-17	2022-07-17
Coaxial Cable	Huber & Suhner	106A	SSG012455	2021-01-05	2022-04-05
Coaxial Cable	Huber & Suhner	106A	SSG012711	2021-01-05	2022-04-05
Coaxial Cable	Huber & Suhner	104PEA	SSG012041	2021-01-05	2022-04-05
Coaxial Cable	Huber & Suhner	ST18/Nm/Nm/36	SSG012785	2021-01-06	2022-04-06
Coaxial Cable	Micro-Coax	UFA 210B-1-1500-504504	SSG012376	2021-01-06	2022-04-06
Coaxial Cable	Huber & Suhner	101 PEA, Sucoflex	SSG012290	2020-11-04	2022-11-04
Pre-Amplifier	BNR	LNA	SSG012594	2021-04-12	2022-04-12
Pre-amp 18-40G	microComp Nordie	MCN-40-18004000-3.3-10P	SSG014000	2021-11-04	2023-11-04
Power Supply	Hewlett Packard	6216A	SSG013063	not required	not required

3.2.16 Test conclusion

The DOT 44Kr B48 (KRY 901 516/3) and DOT 41Kr B48 (KRY 901 516/4) have passed the E-field Radiated Emission (RE) tests with respect to the Class B limits of FCC Part 15 Subpart B and FCC Part 96 section 96.41 e) 2).

4. References

The documents, regulations, and standards that are referenced throughout this test report are listed alphabetically as follows.

1. ANSI C63.2-2009, American National Standards Institute for Electromagnetic Noise and Field Strength Instrumentation, 10 Hz to 40 GHz – Specifications.
2. ANSI C63.4-2014, American National Standards Institute for Methods of Measurement of Radio-Noise Emission from Low-Voltage Electrical and Electronic Equipment in the Range of 9 kHz to 40 GHz.
3. CISPR 16 Publications (all parts and sections), Specification for Radio Disturbance and Immunity Measuring Apparatus and Methods - Part 1: Radio Disturbance and Immunity Measuring Apparatus.
4. CISPR 22 (2008, +IS 1, + IS 2, + IS 3: 2012), Information technology equipment - Radio disturbance characteristics - Limits and methods of measurement.
5. FCC Rules for Radio Frequency Devices, Title 47 of the Code of Federal Regulations, Part 2, U.S. Federal Communications Commission.
6. FCC Rules for Radio Frequency Devices, Title 47 of the Code of Federal Regulations, Part 15 Radio Frequency Devices, U.S. Federal Communications Commission.
7. FCC Rules for Radio Frequency Devices, Title 47 of the Code of Federal Regulations, Part 96 Citizens Broadband Radio Service, U.S. Federal Communications Commission.

4.1 Appendix A: Abbreviations

The abbreviations of terms used in this document are as follows.

Term	Definition
A	6 dB Coaxial Attenuator (Conducted Immunity)
AAN	Asymmetric Artificial Network (ISN)
AE	Auxiliary equipment
AFC	Ambient Free Chamber
AM	Amplitude modulation
ANSI	American National Standards Institute
AVG	Average detector
BiLog	Biconical Log-Periodic Hybrid antenna (a registered trademark of Schaffner-Chase EMC Limited, 1993)
CC	RF Current Clamp
CCC	Capacitive Coupling Clamp
CDN	Coupling-decoupling Network
CE	Conducted Emissions
CI	Conducted Immunity
CISPR	Comité International Spécial Perturbation Radioélectrique (International Special Committee on Radio Interference)
CP	RF Current Probe
CSA	Canadian Standards Association
DI	Direct Injection
DN/P	Decoupling / Protection Network
EFT	Electrical Fast Transient
EFT/B	Electrical Fast Transient / Burst Generator
EMC	Electromagnetic Compatibility
EMI	Electromagnetic Interference
ESD	Electrostatic Discharge
ETSI	European Telecommunications Standards Institute
EUT	equipment under test
GND	Ground
HCP	Horizontal Coupling Plane
HME	Harmonics Measurement Equipment
HV	High Voltage
HVP	High Voltage Probe



Term	Definition
h/w	hardware
IC	Industry Canada
ICES	Canadian Specification: ICES-003, Issue 3, "Spectrum Management: Interference-causing equipment standard (Digital Apparatus)
IEC	International Electro Technical Association
ISN	Impedance Stabilization Network
LISN	Line Impedance Stabilization Network
ms	millisecond, unless otherwise specified
NA, na	not applicable
PA	Broadband Power Amplifier
PK	Peak Detector
PS	Power Supply
QP	Quasi-peak Detector
QPA	Quasi-peak Adapter (for the Spectrum Analyzer)
R	100-ohm Injection Resistor (Conducted Immunity)
RBW	Resolution Bandwidth
RE	Radiated Emissions
RF	Radio-Frequency
RI	Radiated Immunity
RMS	Root-mean-square
s/w	software
SA	Spectrum Analyzer, the CISPR 16, ANSI C63.2 Compliant EMI meter
SG	RF Signal Generator
SGen	Surge Generator
STP	Shielded Twisted Pair
T	50-ohm Coaxial Termination (Conducted Emissions / Immunity)
TL	Transient Limiter
UFA	Uniform field Area
VBW	Video Bandwidth
VCP	Vertical Coupling Plane
VDI	Voltage Dips and Short Interruptions
VFF	Voltage Fluctuations and Flicker



TÜV SÜD Canada Inc

Radiated Emissions Test Report

End of Document