



**Radiated Emissions Test Report  
for  
DOT 4459 B77D (KRY 901 515/1) and DOT 4469 B77D (KRY 901 515/2)**

**Tested to: FCC Part 15 Subpart B  
FCC Part 27 (Section - 27.53(l)(1))**

**Test Result summary**

<b>FCC/ ICES Section</b>	<b>Description</b>	<b>Specification/Method</b>	<b>Pass or Fail</b>	<b>Results in section</b>
15.109 / 6.2	Radiated Emissions (RE)	FCC Part 15 / ANSI C63.4	Pass	3.2
15.107 / 6.1	Conducted Emissions (CE) for AC Power	FCC Part 15 / ANSI C63.4	NA	NA
27.53(l)(1)	Transmitter Spurious Emissions (RE)	FCC Part 27 / ANSI C63.26	Pass	3.2

**Document number: 7169010505-TR-EMC-01-01-F15**

**Release date: 7 February 2022**

**Prepared for: Ericsson Canada**



## About this document

This document is written and distributed by TÜV SÜD Canada Inc. Whenever TÜV SÜD is mentioned in this document it shall be taken as referring to TÜV SÜD Canada Inc.

This test report does not imply product endorsement by any government, accreditation agency, or TÜV SÜD Canada Inc. Opinions or interpretations expressed in this report, if any, are outside the scope of the accreditations of TÜV SÜD Canada Inc. Any opinions expressed do not necessarily reflect the opinions of TÜV SÜD Canada Inc, unless otherwise stated.

Throughout this document:

- text in **blue** font is a clickable link
- text in *italics* is provided as-is from the customer

The release control record, document approvals, and laboratory Accreditations are as follows.

### Release control record

This document is based on document template KG000347-TR-EMC-08-03.

Issue	Reason for change	Date released
01	initial release	7 February 2022

### Approvals

Function	Name	Job title	Signature
Technical Reviewer	Scott Drysdale	Canada Wireless Manager	
Author	Kasi Sivaratnam	EMC Test Engineer	

## Accreditations

The test facilities of TÜV SÜD Canada Inc are accredited by the American Association for Laboratory Accreditation (A2LA) to ISO/IEC 17025:2017 in accordance with the scope of accreditation outlined at the website portal.a2la.org/scopepdf/2955-19.pdf.

 A2LA Cert. No. 2955.19	<b>DISCLAIMER AND COPYRIGHT</b> <p>This non-binding report has been prepared by TÜV SÜD Canada with all reasonable skill and care. The document is confidential to the potential Client and TÜV SÜD Canada. No part of this document may be reproduced without the prior written approval of TÜV SÜD Canada.</p> <p>© TÜV SÜD.</p>
	<b>ACCREDITATION</b> <p>Our A2LA Accreditation does not cover opinions and interpretations and any expressed are outside the scope of our A2LA Accreditation.</p>

The Canadian lab registration number associated with the TÜV SÜD test facilities is 24015.

## Test lab information

Lab name	TÜV SÜD Canada Inc
Company name	TÜV SÜD Canada Inc
Mailing or shipping address	1280 Teron Road, Ottawa, Ontario, K2K 2C1, Canada
Primary technical contact	Scott Drysdale
Title	Canada Wireless Manager
Phone	613-218-1841

## Customer information

Company name	Ericsson Canada
Mailing address	349 Terry Fox Drive, Ottawa, On, K2K 2V6, Canada
Primary contact	Denis Lalonde
Title	Team Leader RA Verification
Phone	613-790-2901
E-mail	<a href="mailto:Denis.lalonde@ericsson.com">Denis.lalonde@ericsson.com</a>



## Table of contents

<b>About this document</b> .....	<b>2</b>
<b>1. Executive summary</b> .....	<b>8</b>
1.1 Compliance summary .....	9
<b>2. Details of the equipment under test</b> .....	<b>10</b>
2.1 Assessed hardware .....	10
2.2 Product overview .....	10
2.3 Product port definition and EUT cable information .....	12
2.4 Configurations of the EUT.....	13
2.4.1.1 Radiated Emissions Single RAT/Single Carrier Configurations – Config 1.....	15
2.4.1.2 Radiated Emissions Single RAT / Multi Carriers Configurations – Config 1 .....	16
2.4.1.3 RE tests Single RAT / Single Carrier Config (Non-contiguous mode) – Config 2.....	17
2.4.1.4 RE tests Single RAT / Multi Carriers Configs (Non-contiguous mode) – Config 2...	17
2.5 Modifications of the EUT during testing.....	18
2.6 Inventory of the EUT and support equipments.....	18
<b>3. Detailed test results of Emissions</b> .....	<b>20</b>
3.1 Measurement instrumentation.....	20
3.2 Radiated Emissions, E-field.....	21
3.2.1 Test specification and limits .....	21
3.2.2 Test procedure.....	21
3.2.3 Calculation of the compliance margin .....	23
3.2.4 Measurement uncertainties .....	23
3.2.5 Test results of RE – Single RAT/ Carrier (SC Config 1 – Bot channel) .....	24
3.2.6 Test results of RE – Single RAT/Single Carrier (SC Config 1 – Mid channel) .....	29
3.2.7 Test results of RE – Single RAT/Single Carrier (SC Config 1 – Top channel) .....	35
3.2.8 Test results of RE – Single RAT / Multi Carrier (MC Config 1 – Mid channel) .....	40
3.2.9 Test results of RE – Single RAT/Single Carrier (SC Config 2 – Mid channel) .....	45
3.2.10 Test results of RE – Single RAT/Multi Carrier (MC Config 2 – Mid channel) .....	51
3.2.11 Radiated Emissions test setup pictures .....	57
3.2.12 Test equipment.....	61
3.2.13 Test conclusion .....	62
<b>4. References</b> .....	<b>63</b>
4.1 Appendix A: Abbreviations .....	64

## List of figures

Figure 1: The EUT with four Internal RF ports, Dot 4459 B77D .....	10
Figure 2: The EUT with four external RF ports, Dot 4469 B77D.....	11
Figure 3: Test configuration for Emission tests (Config 1) .....	13



---

Figure 4: Test configuration for Emission tests (Non-contiguous mode) - Config 2 .....	14
Figure 5: Carrier detail – Single RAT /Single carrier .....	15
Figure 6: Tested carrier detail, Single RAT /Single carrier – SC .....	15
Figure 7: Carrier detail – Single RAT / Multi carrier .....	16
Figure 8: Carrier detail – Single RAT /Single carrier (Non-contiguous mode) .....	17
Figure 9: Carrier detail – Single RAT / Multi carrier (Non-contiguous mode).....	17
Figure 10: Setup of Radiated Emissions.....	22
Figure 11: Plot of RE at 3 m – 30 to1000 MHz (SC Config 1 – Bot channel).....	25
Figure 12: Plot of RE at 3m from 1 to 4 GHz (SC Config 1 – Bot channel).....	26
Figure 13: Plot of RE at 3m from 4 to 10 GHz (SC Config 1 – Bot channel).....	27
Figure 14: Plot of RE at 3m from 10 to 18 GHz (SC Config 1 – Bot channel).....	28
Figure 15: Plot of RE at 3 m – 30 to1000 MHz (SC Config 1 – Mid channel).....	30
Figure 16: Plot of RE at 3m from 1 to 4 GHz (SC Config 1 – Mid channel).....	31
Figure 17: Plot of RE at 3m from 4 to 10 GHz (SC Config 1 – Mid channel).....	32
Figure 18: Plot of RE at 3m from 10 to 18 GHz (SC Config 1 – Mid channel).....	33
Figure 19: Plot of RE at 1m from 18 to 26.5 GHz (SC Config 1 – Mid channel).....	34
Figure 20: Plot of RE at 1m from 26.5 to 40 GHz (SC Config 1 – Mid channel).....	34
Figure 21: Plot of RE at 3 m – 30 to1000 MHz (SC Config 1 – Top channel) .....	36
Figure 22: Plot of RE at 3m from 1 to 4 GHz (SC Config 1 – Top channel) .....	37
Figure 23: Plot of RE at 3m from 4 to 10 GHz (SC Config 1 – Top channel).....	38
Figure 24: Plot of RE at 3m from 10 to 18 GHz (SC Config 1 – Top channel).....	39
Figure 25: Plot of RE at 3 m – 30 to1000 MHz (MC Config 1 – Mid channel).....	41
Figure 26: Plot of RE at 3m from 1 to 4 GHz (MC Config 1 – Mid channel).....	42
Figure 27: Plot of RE at 3m from 4 to 10 GHz (MC Config 1 – Mid channel).....	43
Figure 28: Plot of RE at 3m from 10 to 18 GHz (MC Config 1 – Mid channel).....	44
Figure 29: Plot of RE at 3 m – 30 to1000 MHz (SC Config 2 – Mid channel).....	46
Figure 30: Plot of RE at 3m from 1 to 4 GHz (SC Config 2 – Mid channel).....	47
Figure 31: Plot of RE at 3m from 4 to 10 GHz (SC Config 2 – Mid channel).....	48
Figure 32: Plot of RE at 3m from 10 to 18 GHz (SC Config 2 – Mid channel).....	49
Figure 33: Plot of RE at 1m from 18 to 26.5 GHz (SC Config 2 – Mid channel).....	50
Figure 34: Plot of RE at 1m from 26.5 to 40 GHz (SC Config 2 – Mid channel).....	50
Figure 35: Plot of RE at 3 m – 30 to1000 MHz (MC Config 2 – Mid channel).....	52
Figure 36: Plot of RE at 3m from 1 to 4 GHz (MC Config 2 – Mid channel).....	53
Figure 37: Plot of RE at 3m from 4 to 10 GHz (MC Config 2 – Mid channel).....	54
Figure 38: Plot of RE at 3m from 10 to 18 GHz (MC Config 2 – Mid channel).....	55
Figure 39: Plot of RE at 1m from 18 to 26.5 GHz (MC Config 2 – Mid channel).....	56
Figure 40: Plot of RE at 1m from 26.5 to 40 GHz (MC Config 2 – Mid channel).....	56

---



---

Figure 41: Setup for RE tests at 30 MHz to 1 GHz (Configuration 1) .....	57
Figure 42: Setup for RE tests for above 1 GHz (Configuration 1) .....	58
Figure 43: Setup for RE tests at 30 MHz to 1 GHz (Configuration 2) .....	59
Figure 44: Setup for RE tests for above 1 GHz (Configuration 2) .....	60

## List of tables

Table 1: Summary of test results for the USA; FCC Part 15 subpart B .....	9
Table 2: Summary of test results for the USA; FCC Part 27 subpart C .....	9
Table 3: Assessed hardware .....	10
Table 4: EUT info .....	12
Table 5: System port definition Dot 4469 B77D .....	12
Table 6: Inventory of the EUT – Configuration 1 .....	18
Table 7: Inventory of the EUT (Non-contiguous mode) - Configuration 2 .....	19
Table 8: RE test requirements .....	21
Table 9: RE limits at 10 m for Class B of FCC .....	21
Table 10: Emission limits for FCC Part 27 .....	21
Table 11: RE test results from 30 to 1000 MHz for FCC Part 15 (SC Config 1 – Bot channel) .....	25
Table 12: RE test results from 30 to 1000 MHz for FCC Part 27 (SC Config 1 – Bot channel) .....	25
Table 13: RE test results from 1 to 4 GHz for FCC Part 15 (SC Config 1 – Bot channel) .....	26
Table 14: RE test results from 1 to 4 GHz for FCC Part 27 (SC Config 1 – Bot channel) .....	26
Table 15: RE test results from 4 to 10 GHz for FCC Part 15 (SC Config 1 – Bot channel) .....	27
Table 16: RE test results from 4 to 10 GHz for FCC Part 27 (SC Config 1 – Bot channel) .....	27
Table 17: RE test results from 10 to 18 GHz for FCC Part 15 (SC Config 1 – Bot channel) .....	28
Table 18: RE test results from 10 to 18 GHz (SC Config 1 – Bot channel) .....	28
Table 19: RE test results from 30 to 1000 MHz for FCC Part 15 (SC Config 1 – Mid channel) .....	30
Table 20: RE test results from 30 to 1000 MHz for FCC Part 27 (SC Config 1 – Mid channel) .....	30
Table 21: RE test results from 1 to 4 GHz for FCC Part 15 (SC Config 1 – Mid channel) .....	31
Table 22: RE test results from 1 to 4 GHz for FCC Part 27 (SC Config 1 – Mid channel) .....	31
Table 23: RE test results from 4 to 10 GHz for FCC Part 15 (SC Config 1 – Mid channel) .....	32
Table 24: RE test results from 4 to 10 GHz for FCC Part 27 (SC Config 1 – Mid channel) .....	32
Table 25: RE test results from 10 to 18 GHz for FCC Part 15 (SC Config 1 – Mid channel) .....	33
Table 26: RE test results from 10 to 18 GHz (SC Config 1 – Mid channel) .....	33
Table 27: RE test results from 30 to 1000 MHz for FCC Part 15 (SC Config 1 – Top channel) .....	36
Table 28: RE test results from 30 to 1000 MHz for FCC Part 27 (SC Config 1 – Top channel) .....	36
Table 29: RE test results from 1 to 4 GHz for FCC Part 15 (SC Config 1 – Top channel) .....	37
Table 30: RE test results from 1 to 4 GHz for FCC Part 27 (SC Config 1 – Top channel) .....	37
Table 31: RE test results from 4 to 10 GHz for FCC Part 15 (SC Config 1 – Top channel) .....	38



---

Table 32: RE test results from 4 to 10 GHz for FCC Part 27 (SC Config 1 – Top channel).....	38
Table 33: RE test results from 10 to 18 GHz for FCC Part 15 (SC Config 1 – Top channel).....	39
Table 34: RE test results from 10 to 18 GHz (SC Config 1 – Top channel) .....	39
Table 35: RE test results from 30 to 1000 MHz for FCC Part 15 (MC Config 1 – Mid channel) .....	41
Table 36: RE test results from 30 to 1000 MHz for FCC Part 27 (MC Config 1 – Mid channel) .....	41
Table 37: RE test results from 1 to 4 GHz for FCC Part 15 (MC Config 1 – Mid channel) .....	42
Table 38: RE test results from 1 to 4 GHz for FCC Part 27 (MC Config 1 – Mid channel) .....	42
Table 39: RE test results from 4 to 10 GHz for FCC Part 15 (MC Config 1 – Mid channel) .....	43
Table 40: RE test results from 4 to 10 GHz for FCC Part 27 (MC Config 1 – Mid channel) .....	43
Table 41: RE test results from 10 to 18 GHz for FCC Part 15 (MC Config 1 – Mid channel) .....	44
Table 42: RE test results from 10 to 18 GHz (MC Config 1 – Mid channel).....	44
Table 43: RE test results from 30 to 1000 MHz for FCC Part 15 (SC Config 2 – Mid channel).....	46
Table 44: RE test results from 30 to 1000 MHz for FCC Part 27 (SC Config 2 – Mid channel).....	46
Table 45: RE test results from 1 to 4 GHz for FCC Part 15 (SC Config 2 – Mid channel) .....	47
Table 46: RE test results from 1 to 4 GHz for FCC Part 27 (SC Config 2 – Mid channel) .....	47
Table 47: RE test results from 4 to 10 GHz for FCC Part 15 (SC Config 2 – Mid channel) .....	48
Table 48: RE test results from 4 to 10 GHz for FCC Part 27 (SC Config 2 – Mid channel) .....	48
Table 49: RE test results from 10 to 18 GHz for FCC Part 15 (SC Config 2 – Mid channel) .....	49
Table 50: RE test results from 10 to 18 GHz (SC Config 2 – Mid channel) .....	49
Table 51: RE test results from 30 to 1000 MHz for FCC Part 15 (MC Config 2 – Mid channel) .....	52
Table 52: RE test results from 30 to 1000 MHz for FCC Part 27 (MC Config 2 – Mid channel) .....	52
Table 53: RE test results from 1 to 4 GHz for FCC Part 15 (MC Config 2 – Mid channel) .....	53
Table 54: RE test results from 1 to 4 GHz for FCC Part 27 (MC Config 2 – Mid channel) .....	53
Table 55: RE test results from 4 to 10 GHz for FCC Part 15 (MC Config 2 – Mid channel) .....	54
Table 56: RE test results from 4 to 10 GHz for FCC Part 27 (MC Config 2 – Mid channel) .....	54
Table 57: RE test results from 10 to 18 GHz for FCC Part 15 (MC Config 2 – Mid channel) .....	55
Table 58: RE test results from 10 to 18 GHz (MC Config 2 – Mid channel).....	55
Table 59: Test equipment used for RE (Configuration 1) .....	61
Table 60: Test equipment used for RE (Configuration 2) .....	62

---

# 1. Executive summary

This document reports the Electromagnetic Compatibility (EMC) testing performed on the product called DOT 4459 B77D (KRY 901 515/1) and DOT 4469 B77D (KRY 901 515/2) for Ericsson Canada per project number 7169010505 and 7169010855. The objective of the test activities is to evaluate compliance of the product to following EMC regulatory standards.

The DOT 4459 B77D (KRY 901 515/1) and DOT 4469 B77D (KRY 901 515/2) is verified to comply Emissions requirements of these standards:

- FCC Part 15 Subpart B [5] (**Class B**)
- FCC Part 27 [7] (Base Stations, Section - 27.53(l)(1))

Information about the test result summary and, the equipment under test (EUT) is in the sections:

- [Compliance summary](#)
- [Details of the equipment under test](#)
- [Detailed test results of Emissions](#)





## 1.1 Compliance summary

The test results in this report apply only to the tested components that are identified in the section [Assessed hardware](#).

The following table summarizes the EMC test results for the test cases performed on the DOT 4459 B77D (KRY 901 515/1) and DOT 4469 B77D (KRY 901 515/2)

**Table 1: Summary of test results for the USA; FCC Part 15 subpart B**

FCC Section	Description	Specification/Method	Pass or Fail	Results in section
15.109	Radiated Emissions (RE)	FCC Part 15/ANSI C63.4	Pass	3.2
15.107	Conducted Emissions (CE) for AC Power	FCC Part 15/ANSI C63.4	NA	NA
<b>Table Notes</b>				
1. Not Applicable; EUT operates from POE (56 VDC).				

**Table 2: Summary of test results for the USA; FCC Part 27 subpart C**

FCC Section	Description	Specification/Method	Pass or Fail	Results in section
27.53(l)(1)	Transmitter Spurious Emissions (RE) – Base Stations	FCC Part 27/ ANSI C63.26	Pass	3.2

## 2. Details of the equipment under test

This section describes the equipment under test (EUT).

### 2.1 Assessed hardware

The following table indicates the hardware components that were assessed during this test program.

**Table 3: Assessed hardware**

Hardware component <sup>1</sup>	Part number
DOT 4459 B77D, with internal Antenna port	KRY 901 515/1
DOT 4469 B77D, with External Antenna port	KRY 901 515/2
<b>Table Notes</b>	
1. The 2 units above use the same pcb and hardware. The only difference between the units is the presence of the internal/external antennas. There fore all EMC tests were done only on the external port variant.	

### 2.2 Product overview

The product trade name is DOT 4459 B77D (KRY 901 515/1) and DOT 4469 B77D (KRY 901 515/2). DOT 4459 B77D (KRY 901 515/1) and DOT 4469 B77D (KRY 901 515/2) are indoor wireless telecommunication products; transmit and receive the cellular signals for 5G wireless systems. And operates from POE (56 VDC).

**Figure 1: The EUT with four Internal RF ports, Dot 4459 B77D**

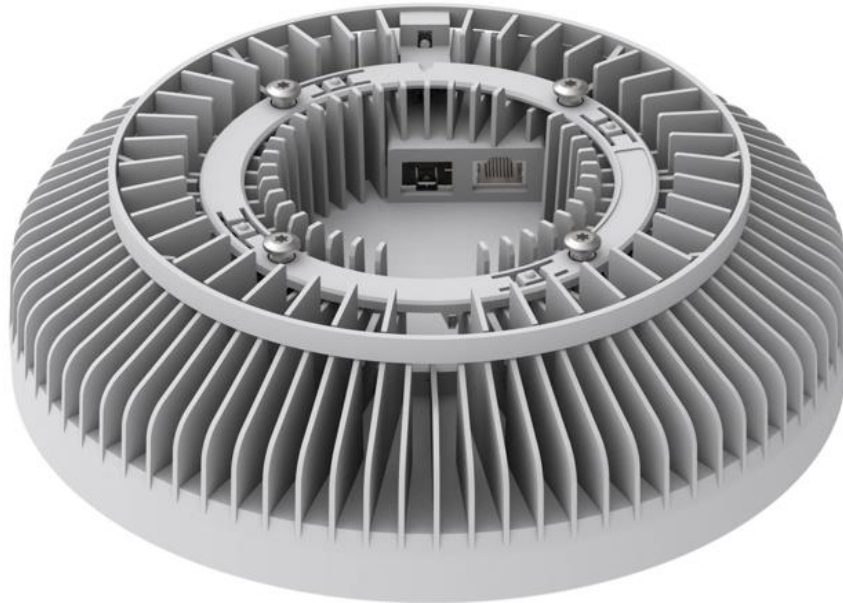

**Figure 2: The EUT with four external RF ports, Dot 4469 B77D**



The 2 units above use the same pcb and hardware. The only difference between the units is the presence of the internal/external antennas. There fore all EMC tests were done only on the external port variant; configurations of the DOT 4469 B77D (KRY 901 515/2) that was tested is shown in the section [Configurations of the EUT](#). The EUT was tested in a tabletop setting.

**Table 4: EUT info**

<b>Product data</b>	DOT 4469 B77D
<b>Product</b>	Single-band Dot, 4T4R
<b>P/N:</b>	KRY 901 515/2
<b>HW Rev</b>	R1B
<b>Nominal Voltage:</b>	56Vdc (CAT6A POE or Hybrid cable)
<b>Operating Temperature:</b>	+5°C to +40°C
<b>Bands</b>	B77D
<b>Antennas</b>	4T4R B77D
<b>Output Power per band</b>	400mW (26dBm) (B77D, TDD) / branch
<b>Maximum IBW</b>	B77D: 200MHz
<b>Contig. / Non-contig</b>	Contiguous and non-contiguous operation is supported
<b>Single RAT (SRO) support</b>	B77D: NR-TDD
<b>Mixed RAT (MRO) support</b>	B77D: none
<b>Channel Bandwidth B77D:</b>	NR: 20, 40, 60, 80, 100MHz
<b>Nominal O/P per TDD Antenna Port</b>	Single Carrier: 1 x 400mW (26dBm)
	Multi-Carrier: 2 x 200mW (23dBm)
	Multi-Carrier: 3 x 133.3mW (21.49dBm)
	Multi-Carrier: 4 x 100mW (20dBm)
	Multi-Carrier: 5 x 80mW (19dBm)
	Multi-Carrier: 6 x 66.7mW (18.23dBm)
<b>Max number carriers per Port</b>	B77D: Max 6 NR carriers
<b>CPRI line rate</b>	10.1 Gbps
<b>Compatible IRU</b>	IRU 1648/1649 & 8848
<b>Modulation:</b>	NR: QPSK, 16QAM, 64QAM, 256 QAM
<b>dRDI Interface:</b>	Digital, dRDI
<b>SFP Interface:</b>	Optical SFP+, 10.1 Gbps
<b>Mounting</b>	ceiling or wall

## 2.3 Product port definition and EUT cable information

Table 5 identifies all the cables and ports on the EUT. The Environment of the cables is indoor.

**Table 5: System port definition Dot 4469 B77D**

Port Name	Port Description	Port Type	Interface Detail	Plug-Cable Type
RJ45	Digital RDI / DC Power Input	Telecom / DC Power	ethernet	RJ-45, CAT6A
SFP+	Digital RDI, Optical SFP+	Optical SFP	optical fiber, LC	SFP+, RDH 102 65/2,
3A, 3B, 4A, 4B	RF to antenna B77D	Antenna	RF	SMA, Coax >3m

## 2.4 Configurations of the EUT

Two EUT configurations were evaluated for radiated Emissions test. All EUT configurations were defined by customer.

- Configuration 1 – EUT in regular operating mode
- Configuration 2 – EUT in Non-contiguous mode

Figure 3 and Figure 4 show the configurations of the EUT for Radiated Emissions test.

**Figure 3: Test configuration for Emission tests (Config 1)**

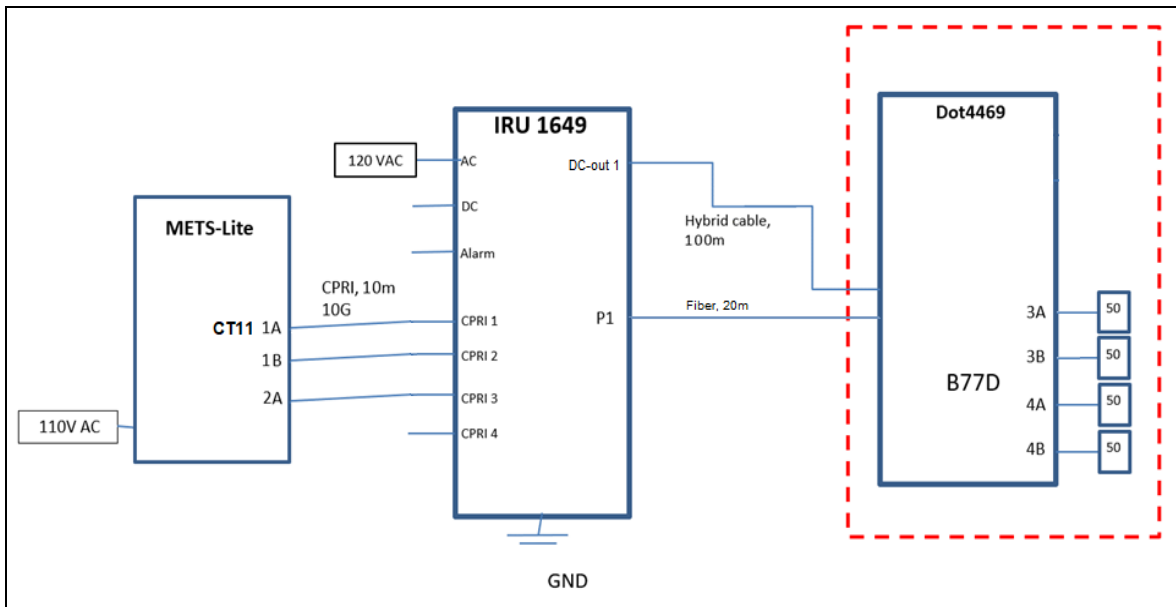

**Figure 4: Test configuration for Emission tests (Non-contiguous mode) - Config 2**

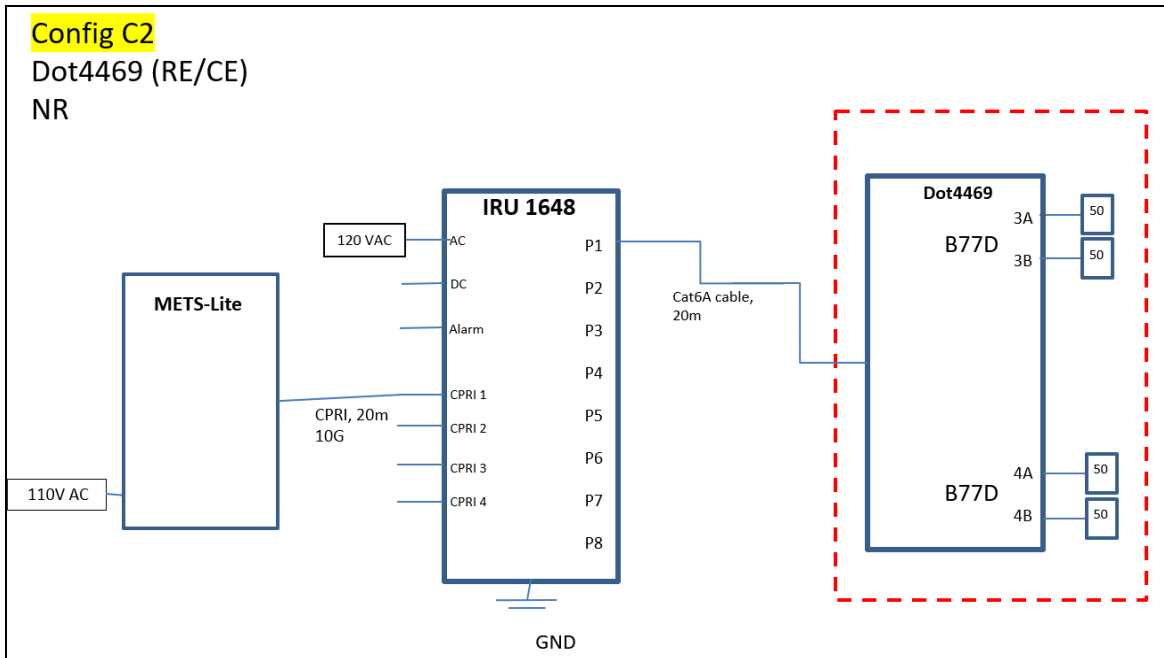

Following RAT/carrier configurations were tested during this Radiated Emissions evaluations.

- Radiated Emissions Single RAT/Single Carrier Configurations – Config 1
- Radiated Emissions Single RAT / Multi Carriers Configurations – Config 1
- RE tests Single RAT / Single Carrier Config (Non-contiguous mode) – Config 2
- RE tests Single RAT / Multi Carriers Configs (Non-contiguous mode) – Config 2

### 2.4.1.1 Radiated Emissions Single RAT/Single Carrier Configurations – Config 1

**Figure 5: Carrier detail – Single RAT /Single carrier**

Single RAT/Single Carrier - NR setups for Emissions	
B77D PORT 3A,3B, 4A,4B	
BS type 1-C, CS16 (NR) TC21	
SR NR Config <b>SC 1</b> Carrier setups for Emissions	
Carrier	Middle channel
1	NR, 20MHz, 3840MHz
SR NR Config <b>SC 2</b> Carrier setups for Emissions	
Carrier	Middle channel
1	NR, 40MHz, 3840MHz
SR NR Config <b>SC 3</b> Carrier setups for Emissions	
Carrier	Middle channel
1	NR, 60MHz, 3840MHz
SR NR Config <b>SC 4</b> Carrier setups for Emissions	
Carrier	Middle channel
1	NR, 80MHz, 3840MHz
SR NR Config <b>SC 5</b> Carrier setups for Emissions	
Carrier	Middle channel
1	NR, 100MHz, 3840MHz

Radiated Emissions measurements were compared between above 5 NR carrier setups. **SC1** was found to have higher emissions than **SC2, SC3, SC4** and **SC5**. Single RAT/Single carrier NR in this report are therefore measured using **SC1** Bottom, Middle and Top channel carrier setup. Tested carrier/frequency detail in [Figure 6: Tested carrier detail, Single RAT /Single carrier – SC](#) .

**Figure 6: Tested carrier detail, Single RAT /Single carrier – SC**

SR NR Config SC 1 Carrier setups for Emissions	
B77D PORT 3A,3B, 4A,4B	
Carrier	Bottom channel
1	NR, 20MHz, 3710MHz
Carrier	Middle channel
1	NR, 20MHz, 3840MHz
Carrier	Top channel
1	NR, 20MHz, 3970MHz

### 2.4.1.2 Radiated Emissions Single RAT / Multi Carriers Configurations – Config 1

**Figure 7: Carrier detail – Single RAT / Multi carrier**

Single RAT/ Multi Carriers - NR setups for Emissions	
B77D PORT 3A,3B, 4A,4B	
BS type 1-C, CS16 (NR) TC21	
SR NR Config <b>MC 1</b> Carrier setups for Emissions	
Carrier	Middle channel
1	NR, 20MHz, 3830MHz
2	NR, 20MHz, 3850MHz
SR NR Config <b>MC 2</b> Carrier setups for Emissions	
Carrier	Middle channel
1	NR, 20MHz, 3820MHz
2	NR, 20MHz, 3840MHz
3	NR, 20MHz, 3860MHz
SR NR Config <b>MC 3</b> Carrier setups for Emissions	
Carrier	Middle channel
1	NR, 20MHz, 3790MHz
2	NR, 20MHz, 3810MHz
3	NR, 20MHz, 3830MHz
4	NR, 20MHz, 3850MHz
5	NR, 20MHz, 3870MHz
6	NR, 20MHz, 3890MHz

**Note:** Radiated Emissions measurements were compared between **MC1**, **MC2** and **MC3**. **MC1** was found to have higher emissions. All plots with Single RAT/Multi carrier in this report are therefore measured using **MC1** middle carrier setups.



### 2.4.1.3 RE tests Single RAT / Single Carrier Config (Non-contiguous mode) – Config 2

Tested carrier/frequency detail in [Figure 8: Carrier detail – Single RAT /Single carrier \(Non-contiguous mode\)](#)

**Figure 8: Carrier detail – Single RAT /Single carrier (Non-contiguous mode)**

Single RAT/Single Carrier - Non-contiguous mode for RE	
B77D PORT 3A,3B, 4A,4B	
BS type 1-C, CS16 (NR) TC21	
SR NR Config <b>SC 6</b> Carrier setups for Emissions	
Carrier	Middle channel
1	NR, 20MHz, 3840MHz

### 2.4.1.4 RE tests Single RAT / Multi Carriers Configs (Non-contiguous mode) – Config 2

**Figure 9: Carrier detail – Single RAT / Multi carrier (Non-contiguous mode)**

Single RAT/ Multi Carriers - NR setups for Emissions	
B77D PORT 3A,3B, 4A,4B	
BS type 1-C, CS16 (NR) TC21	
SR NR Config <b>MC 4</b> Carrier setups for Emissions	
Carrier	Middle channel
1	B77D: NR, 20MHz, 3750MHz (M) NC
2	B77D: NR, 20MHz, 3930MHz (M) NC
SR NR Config <b>MC 5</b> Carrier setups for Emissions	
Carrier	Middle channel
1	B77D: NR, 20MHz, 3750MHz (M) NC
2	B77D: NR, 20MHz, 3770MHz (M) NC
3	B77D: NR, 20MHz, 3930MHz (M) NC
SR NR Config <b>MC 6</b> Carrier setups for Emissions	
Carrier	Middle channel
1	B77D: NR, 20MHz, 3750MHz (M)
2	B77D: NR, 20MHz, 3770MHz (M)
3	B77D: NR, 20MHz, 3790MHz (M)
4	B77D: NR, 20MHz, 3890MHz (M)
5	B77D: NR, 20MHz, 3910MHz (M)
6	B77D: NR, 20MHz, 3930MHz (M)

**Note:** Radiated Emissions measurements were compared between **MC4**, **MC5** and **MC6**. **MC4** was found to have higher emissions. All plots with Single RAT/Multi carrier in this report are therefore measured using **MC4** middle carrier setup. See [Figure 9: Carrier detail – Single RAT / Multi carrier \(Non-contiguous mode\)](#) for tested carrier detail.



## 2.5 Modifications of the EUT during testing

The EUT was not modified prior to or during testing.

## 2.6 Inventory of the EUT and support equipments

The following table identifies the inventory of the EUT.

**Table 6: Inventory of the EUT – Configuration 1**

Equipment Role	Product Name	Product Number	Release	Product Serial#
EUT	DOT 4469 B77D	KRY 901 515/2	R1B	TD3W187185
SUPPORT	IRU 1649	KRC 161 842/2	R1E	TD3F109016
Cable	IRU CPRI, Fiber, LC, SM, 10m		na	na
Cable	RDI Optical, Fiber, LC, SM, 20m	RPM 253 1610/20M	R2C	na
Cable	DOT DC power input, Hybrid cable assembly, 100m	42020600153	R1A	na
Cable	RF, SMA, 2m, qty=4	RMTL18-NFSMC-2M	na	na
TEST SET	METS-Lite (RUX + CT-11) #1			
<b>S/W:</b>				
IRU load:	iru3atc_app-CXP2030045_26-R11AK58			
RUX rev:	R9F			
RUX testDef:	_RRUS_V4p9_MR9954_dualXenon_B77D_Performance			



**Table 7: Inventory of the EUT (Non-contiguous mode) - Configuration 2**

Equipment Role	Product Name	Product Number	Product Release	Product Serial#
EUT	DOT 4469 B77D	KRY 901 515/2	R1B	TD3W187208
SUPPORT	IRU 1648	KRC 161 842/1	R1D	TD3F105254
Cable	IRU CPRI, Fiber, LC, SM, 20m x 3	2835084-1	na	na
Cable	dRDI cable:	Schnieder, F/FTP	na	na
Cable	RF, SMA, 2m, qty=4	RMTL18-NFSMRA-2M	na	na
TEST SET	METS-Lite (RUX + CT-11)	LPC 102 494/1	R2A	TO1G499655
<b>SW:</b>				
IRU load:	iru3atc_app-CXP2030045_26-R11CK57.xlf			
RUX rev:	R9F			
RUX testDef:	_RRUS_V4p9_MR9954_dualXenon_B77D_Performance			



---

## 3. Detailed test results of Emissions

Emissions from systems manifest themselves in two forms: conducted emissions on cables and radiated emissions from the entire system (i.e. electronic modules, hardware, and cables). Regulatory standards restrict these different forms of emissions generated by the system.

The temperature and humidity in the test facilities are controlled. The temperature is maintained between 20 °C and 25 °C, with a relative humidity between 30 % and 60 %. Levels are recorded and any exceptions are included in the detailed test results sections of this report.

### 3.1 Measurement instrumentation

The measurement instrumentation conforms to the relevant standards in this report: ANSI C63.2, CISPR 16, CISPR 22, and CISPR 32. Calibration of the measurement instrumentation is maintained in accordance with the supplier's recommendations, or as necessary to ensure its accuracy.

## 3.2 Radiated Emissions, E-field

This test verifies that the EUT does not produce excess amounts of E-field Radiated Emissions (RE) that could interfere with licensed radiators.

### 3.2.1 Test specification and limits

The testing requirements are as follows.

**Table 8: RE test requirements**

Requirement	Method	Country of application
FCC Part 15, Subpart B	ANSI C63.4	USA
FCC Part 27	FCC Part 27/ ANSI C63.26	USA

The limits of the RE tests are as follows.

**Table 9: RE limits at 10 m for Class B of FCC**

Frequency range (MHz)	FCC Part 15 (dB $\mu$ V/m)	Detector
30 to 88	29.5	Quasi-Peak
88 to 216	33.0	Quasi-Peak
216 to 960	35.5	Quasi-Peak
960 to 1000	43.5	Quasi-Peak
1000 to 40000	43.5	Average

**Table 10: Emission limits for FCC Part 27**

Frequency range (MHz)	FCC Part 27 EIRP Limit (dBm)	Calculated EIRP Limit in dB $\mu$ V/m
30 - 40000	-13	82.2

### 3.2.2 Test procedure

Verifications of the test equipment and AFC were performed before the installation of the EUT in accordance with the quality assurance procedures documented in the EMC test procedures document. The test was performed according to the relevant procedures listed in [Table 8](#).

- The EUT was placed on the turntable inside the AFC (configured for normal operation). The system and its cables were separated from the ground plane by an insulating support 10 mm in height.
- For tests between 30 MHz and 1 GHz the receive antenna (BiLog®) was placed 3 m away from the EUT. An initial scan was performed to find emissions/frequencies requiring detailed measurement. The pre-scan was performed by rotating the system 360 degrees while recording all emissions

(frequency and amplitude). This procedure was repeated for antenna heights of 1 to 4 m, as well as both polarizations of the receiving antenna.

- For tests above 1 GHz the receive antenna (horn) was placed 3 m away from the EUT. Absorbing cones were placed on the floor between the antenna and the EUT. An initial scan was performed to find emissions/frequencies requiring detailed measurement. The pre-scan was performed by rotating the system 360 degrees while recording all emissions (frequency and amplitude). This procedure was repeated for antenna heights of 1 to 4 m, as well as both polarizations of the receiving antenna.
- For tests between 18 and 40 GHz the receive horn antenna was placed at a 1 m distance from the EUT with the absorbing cones placed on the floor. An initial scan was performed to find emissions/frequencies requiring detail measurement. The pre-scan was performed on all sides of the EUT, using both polarizations of the receive antenna to find any system emissions.
- For all above frequency ranges, the pre-scan peak data was compared to the limits. Peaks with less than 6 dB of margin were maximized using the proper detector: the EUT was rotated in azimuth over 360 degrees to identify the direction of maximum emission, antenna height was then varied from 1 to 4 m to obtain maximum emission level.

**Figure 10: Setup of Radiated Emissions**

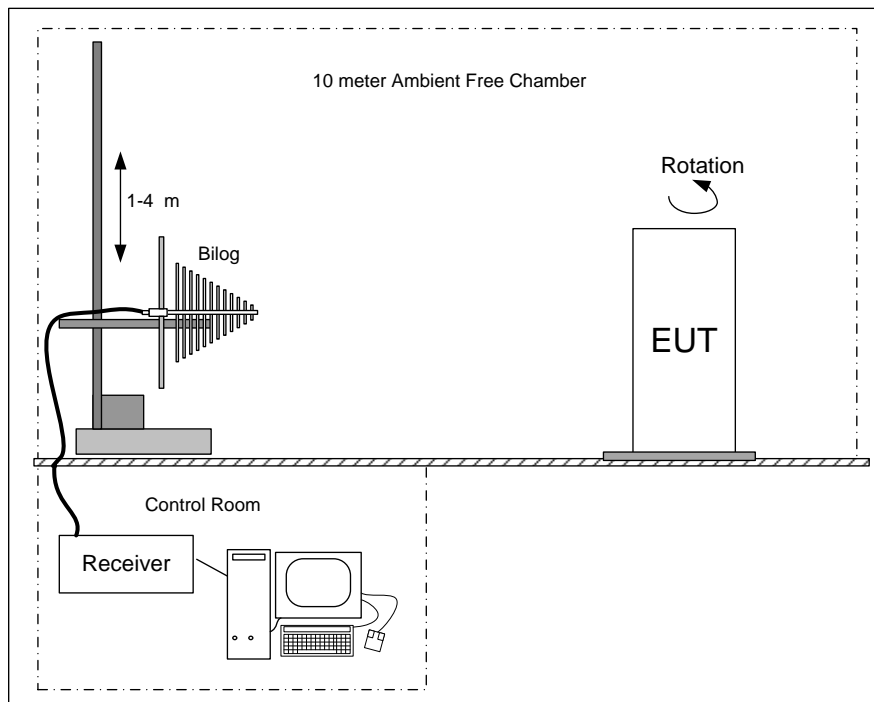

### 3.2.3 Calculation of the compliance margin

The following example shows the way in which the compliance margin is calculated in the “RE Test Results” tables.

The rows in these tables are defined as follows.

Meter Reading (dB $\mu$ V) = Voltage measured using the spectrum analyzer with the proper detector

Correction (dB) = Cumulative gain or loss of pre-amplifier and cables used in the measurement path (dB) + Antenna Factor (dB)

Level (dB $\mu$ V/m) = Corrected value or field strength, that is, the parameter of interest that is compared to the limit

Margin (dB) = Level with respect to the appropriate limit (a negative Margin indicates that the Level is below the limit and that the measurement is a Pass)

The values in the Level row are calculated as follows:      Level = Meter Reading + Correction (dB)

The values in the Margin row are calculated as follows:      Margin = Level – Limit

### 3.2.4 Measurement uncertainties

The expanded measurement instrumentation uncertainty with a 95 % level of confidence, calculated according to the method described in CISPR 16 is:

- $\pm 3.8$  dB between 30 MHz and 1 GHz
- $\pm 4.7$  dB between 1 GHz and 10 GHz
- $\pm 4.8$  dB between 10 GHz and 18 GHz
- $\pm 4.6$  dB between 18 GHz and 26.5 GHz
- $\pm 4.8$  dB between 26.5 GHz and 40 GHz



---

### 3.2.5 Test results of RE – Single RAT/ Carrier (SC Config 1 – Bot channel)

Test location: 10-meter Ambient Free Chamber (AFC)

Date tested: 15 - 17 November, 2021

Tested by: Steve Mcfarlane & Krupal Patel

Test configurations are listed as SC Configuration 1 in Section 2.4.1.1 as identified in the section [Configurations of the EUT](#). For the following test results that have supporting data tables, negative margin values indicate a pass.

**Red trace** – Vertical antenna polarity, **Blue trace** – Horizontal antenna polarity



**Figure 11: Plot of RE at 3 m – 30 to 1000 MHz (SC Config 1 – Bot channel)**

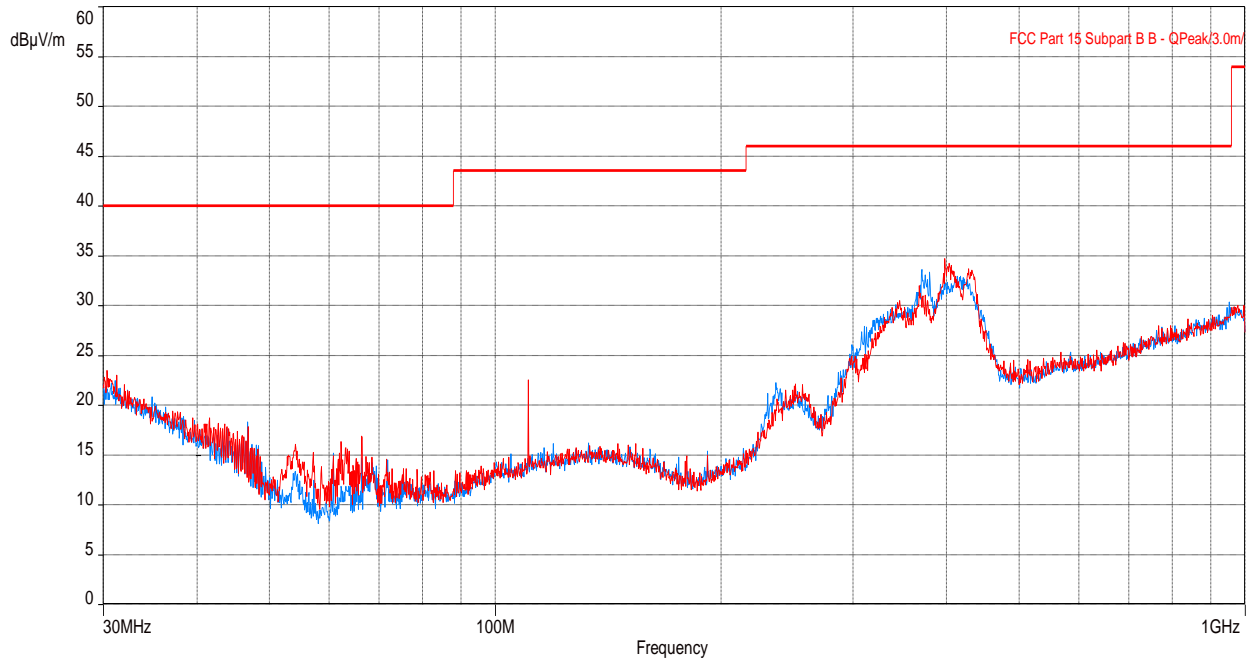

**Table 11: RE test results from 30 to 1000 MHz for FCC Part 15 (SC Config 1 – Bot channel)**

Frequency (MHz)	Level (dBµV)	Limit Quasi-peak (dBµV)	Margin to FCC part 15 Class B (dB)	Height (m)	Azimuth (deg)	Polarization	Correction (dB)
370.8624872	29.54	46.02	-16.48	3.07	54.50	Horizontal	-4.78
398.1572341	32.27	46.02	-13.75	1.14	90.50	Vertical	-4.25

**Table 12: RE test results from 30 to 1000 MHz for FCC Part 27 (SC Config 1 – Bot channel)**

Frequency (MHz)	Level (dBµV)	Limit EIRP (dBµV)	Margin to EIRP Limit (dB)	Height (m)	Azimuth (deg)	Polarization	Correction (dB)
370.8624872	29.54	82.2	-52.66	3.07	54.50	Horizontal	-4.78
398.1572341	32.27	82.2	-49.93	1.14	90.50	Vertical	-4.25

**Note:** In the table/Plot above, no emissions exceed the Part 27 radiated spurious emissions limit when converted to dBuV/m. For final spurious emissions measurements to FCC Part 27, see antenna port conducted emissions in applicable test report.

**Figure 12: Plot of RE at 3m from 1 to 4 GHz (SC Config 1 – Bot channel)**

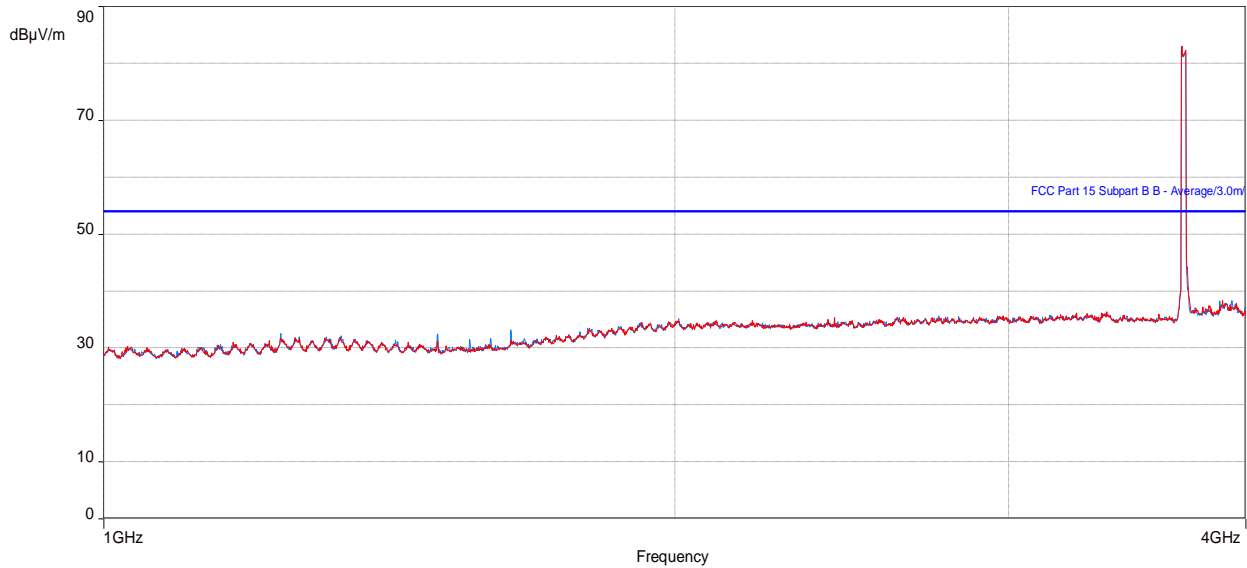

**Note:** Peak above the limit is leakage of the EUT’s fundamentals from the 50-ohm terminations.

**Table 13: RE test results from 1 to 4 GHz for FCC Part 15 (SC Config 1 – Bot channel)**

Frequency (MHz)	Level Average (dBµV)	Limit Average (dBµV)	Margin to FCC part 15 Class B (dB)	Height (m)	Azimuth (degrees)	Polarization	Correction (dB)
3372.103846	32.31	53.96	-21.65	3.03	105.50	Horizontal	3.39
3890.330128	32.98	53.96	-20.98	1.43	120.00	Vertical	4.00
3933.919872	32.74	53.96	-21.22	1.11	40.75	Horizontal	4.10

**Table 14: RE test results from 1 to 4 GHz for FCC Part 27 (SC Config 1 – Bot channel)**

Frequency (MHz)	Level (dBµV)	Limit EIRP (dBµV)	Margin to EIRP Limit (dB)	Height (m)	Azimuth (deg)	Polarization	Correction (dB)
3372.103846	32.31	82.2	-49.89	3.03	105.50	Horizontal	3.39
3890.330128	32.98	82.2	-49.22	1.43	120.00	Vertical	4.00
3933.919872	32.74	82.2	-49.46	1.11	40.75	Horizontal	4.10

**Note:** In the table/Plot above, no emissions exceed the Part 27 radiated spurious emissions limit when converted to dBuV/m. For final spurious emissions measurements to FCC Part 27, see antenna port conducted emissions in applicable test report.

**Figure 13: Plot of RE at 3m from 4 to 10 GHz (SC Config 1 – Bot channel)**

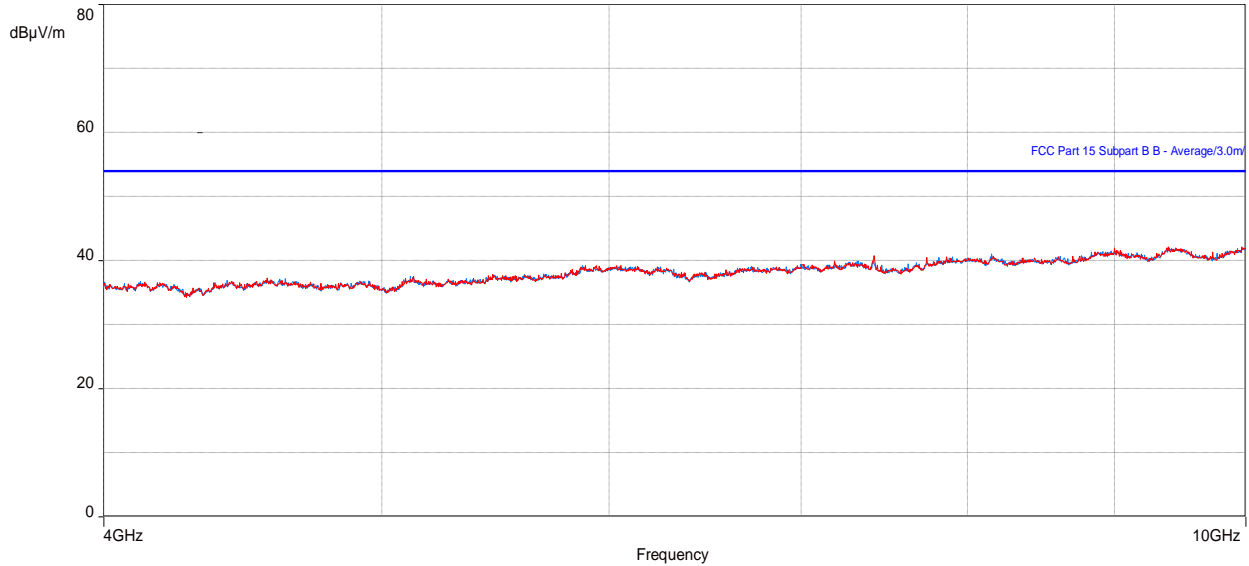

**Table 15: RE test results from 4 to 10 GHz for FCC Part 15 (SC Config 1 – Bot channel)**

Frequency (MHz)	Level Average (dBµV)	Limit Average (dBµV)	Margin to FCC part 15 Class B (dB)	Height (m)	Azimuth (degrees)	Polarization	Correction (dB)
5878.987179	35.65	53.96	-18.31	3.90	98.50	Vertical	6.83

**Table 16: RE test results from 4 to 10 GHz for FCC Part 27 (SC Config 1 – Bot channel)**

Frequency (MHz)	Level (dBµV)	Limit EIRP (dBµV)	Margin to EIRP Limit (dB)	Height (m)	Azimuth (deg)	Polarization	Correction (dB)
5878.987179	35.65	82.2	-46.55	3.90	98.50	Vertical	6.83

**Note:** In the table/Plot above, no emissions exceed the Part 27 radiated spurious emissions limit when converted to dBuV/m. For final spurious emissions measurements to FCC Part 27, see antenna port conducted emissions in applicable test report.

**Figure 14: Plot of RE at 3m from 10 to 18 GHz (SC Config 1 – Bot channel)**

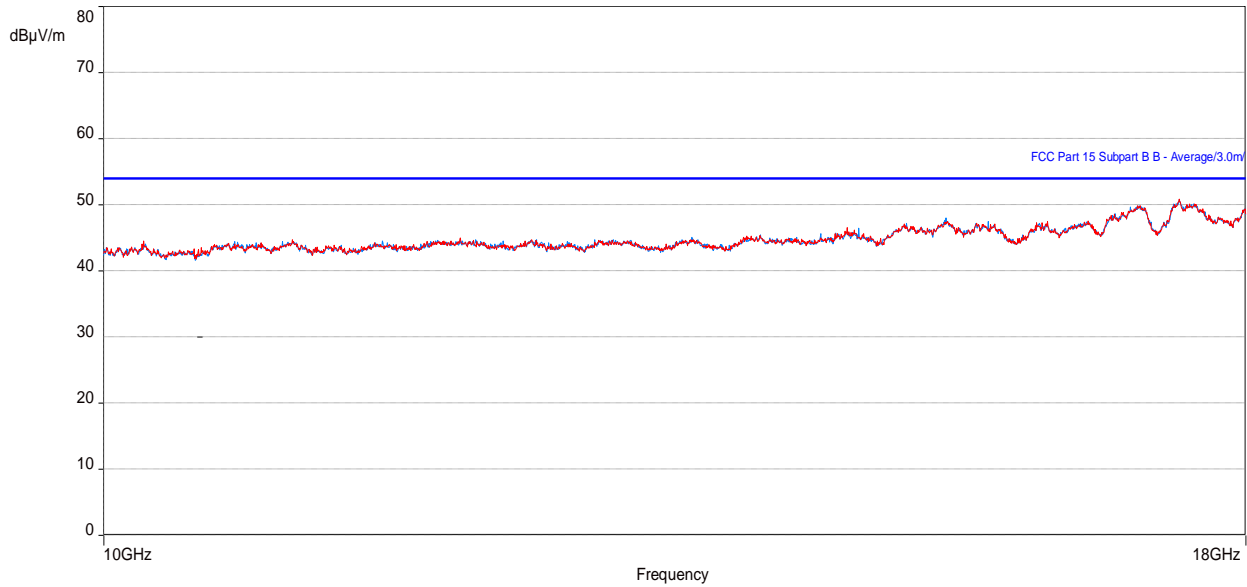

**Table 17: RE test results from 10 to 18 GHz for FCC Part 15 (SC Config 1 – Bot channel)**

Frequency (MHz)	Level Average (dBµV)	Limit Average (dBµV)	Margin to FCC part 15 Class B (dB)	Height (m)	Azimuth (degrees)	Polarization	Correction (dB)
17042.58527	46.78	53.96	-7.18	3.77	307.00	Horizontal	20.98
17049.31377	46.59	53.96	-7.37	3.17	270.75	Vertical	20.86
17393.50705	47.09	53.96	-6.87	4.00	0.25	Horizontal	21.54
17394.78559	47.28	53.96	-6.68	3.32	299.75	Vertical	21.60

**Table 18: RE test results from 10 to 18 GHz (SC Config 1 – Bot channel)**

Frequency (MHz)	Level (dBµV)	Limit EIRP (dBµV)	Margin to EIRP Limit (dB)	Height (m)	Azimuth (deg)	Polarization	Correction (dB)
17042.58527	46.78	82.2	-35.42	3.77	307.00	Horizontal	20.98
17049.31377	46.59	82.2	-35.61	3.17	270.75	Vertical	20.86
17393.50705	47.09	82.2	-35.11	4.00	0.25	Horizontal	21.54
17394.78559	47.28	82.2	-34.92	3.32	299.75	Vertical	21.60

**Note:** In the table/Plot above, no emissions exceed the Part 27 radiated spurious emissions limit when converted to dBuV/m. For final spurious emissions measurements to FCC Part 27, see antenna port conducted emissions in applicable test report.



---

### 3.2.6 Test results of RE – Single RAT/Single Carrier (SC Config 1 – Mid channel)

Test location: 10-meter Ambient Free Chamber (AFC)

Date tested: 15 - 17 November, 2021

Tested by: Steve Mcfarlane & Krupal Patel

Test configurations are listed as SC Configuration 1 in Section 2.4.1.1 as identified in the section [Configurations of the EUT](#). For the following test results that have supporting data tables, negative margin values indicate a pass.

**Red trace** – Vertical antenna polarity, **Blue trace** – Horizontal antenna polarity

**Figure 15: Plot of RE at 3 m – 30 to 1000 MHz (SC Config 1 – Mid channel)**

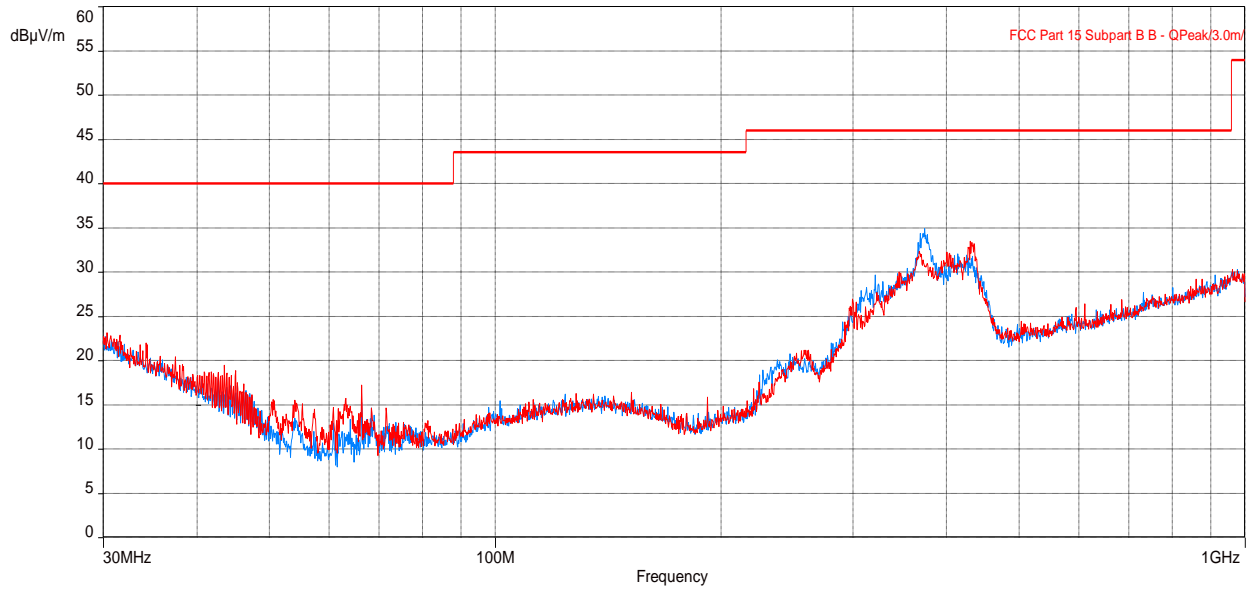

**Table 19: RE test results from 30 to 1000 MHz for FCC Part 15 (SC Config 1 – Mid channel)**

Frequency (MHz)	Level (dBµV)	Limit Quasi-peak (dBµV)	Margin to FCC part 15 Class B (dB)	Height (m)	Azimuth (deg)	Polarization	Correction (dB)
374.1609679	32.83	46.02	-13.19	3.07	55.00	Horizontal	-4.79
430.00192	30.98	46.02	-15.04	1.05	268.75	Vertical	-3.59

**Table 20: RE test results from 30 to 1000 MHz for FCC Part 27 (SC Config 1 – Mid channel)**

Frequency (MHz)	Level (dBµV)	Limit EIRP (dBµV)	Margin to EIRP Limit (dB)	Height (m)	Azimuth (deg)	Polarization	Correction (dB)
374.1609679	32.83	82.2	-49.37	3.07	55.00	Horizontal	-4.79
430.00192	30.98	82.2	-51.22	1.05	268.75	Vertical	-3.59

**Note:** In the table/Plot above, no emissions exceed the Part 27 radiated spurious emissions limit when converted to dBuV/m. For final spurious emissions measurements to FCC Part 27, see antenna port conducted emissions in applicable test report.

**Figure 16: Plot of RE at 3m from 1 to 4 GHz (SC Config 1 – Mid channel)**

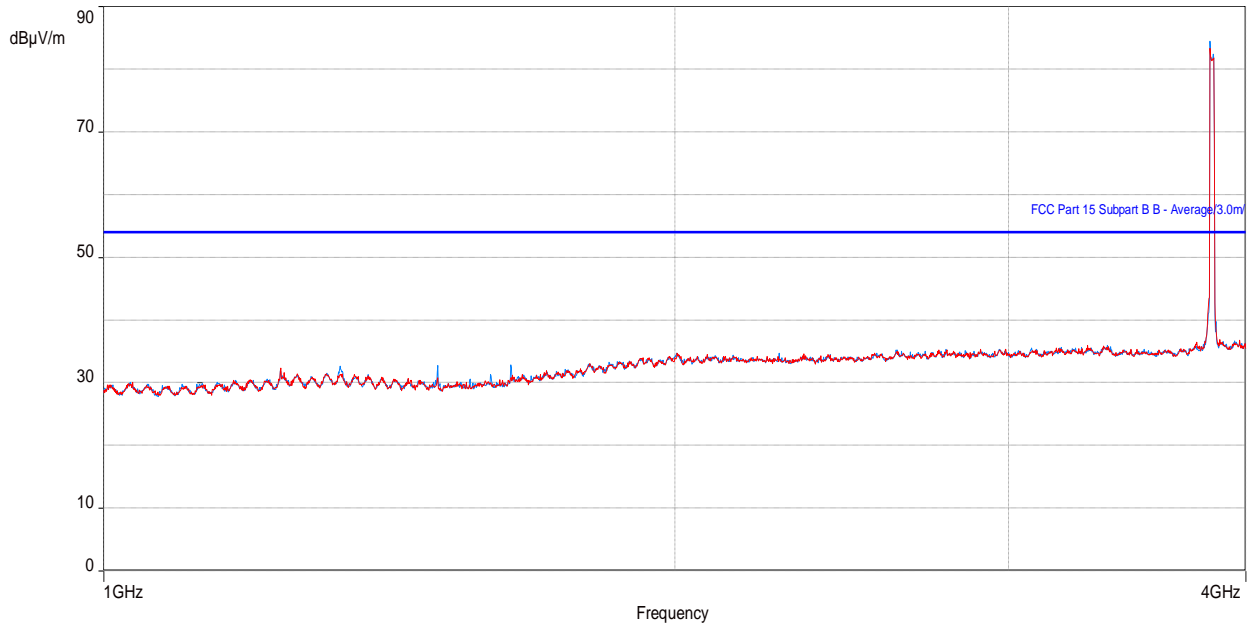

**Note:** Peak above the limit is leakage of the EUT’s fundamentals from the 50-ohm terminations.

**Table 21: RE test results from 1 to 4 GHz for FCC Part 15 (SC Config 1 – Mid channel)**

Frequency (MHz)	Level Average (dBµV)	Limit Average (dBµV)	Margin to FCC part 15 Class B (dB)	Height (m)	Azimuth (degrees)	Polarization	Correction (dB)
3365.209615	32.19	53.96	-21.77	4.00	19.00	Vertical	3.40

**Table 22: RE test results from 1 to 4 GHz for FCC Part 27 (SC Config 1 – Mid channel)**

Frequency (MHz)	Level (dBµV)	Limit EIRP (dBµV)	Margin to EIRP Limit (dB)	Height (m)	Azimuth (deg)	Polarization	Correction (dB)
3365.209615	32.19	82.2	-50.01	4.00	19.00	Vertical	3.40

**Note:** In the table/Plot above, no emissions exceed the Part 27 radiated spurious emissions limit when converted to dBuV/m, except for the fundamental. For final spurious emissions measurements to FCC Part 27, see antenna port conducted emissions in applicable test report.

**Figure 17: Plot of RE at 3m from 4 to 10 GHz (SC Config 1 – Mid channel)**

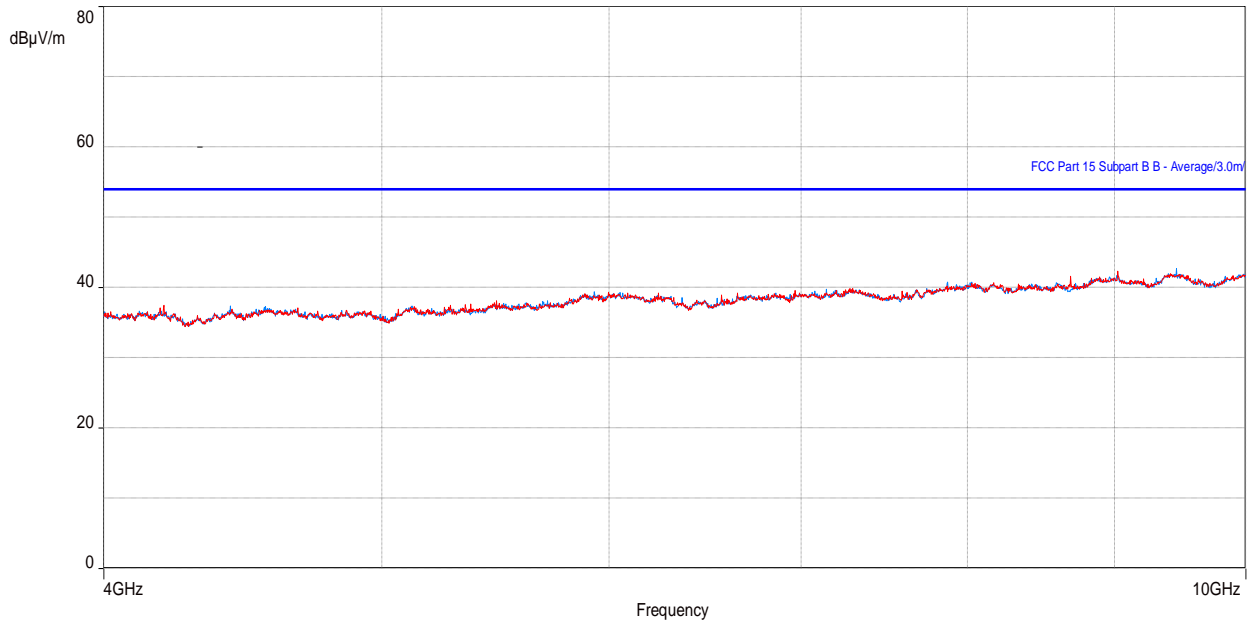

**Table 23: RE test results from 4 to 10 GHz for FCC Part 15 (SC Config 1 – Mid channel)**

Frequency (MHz)	Level Average (dBµV)	Limit Average (dBµV)	Margin to FCC part 15 Class B (dB)	Height (m)	Azimuth (degrees)	Polarization	Correction (dB)
4434.649359	33.22	53.96	-20.74	3.68	312.00	Vertical	4.43

**Table 24: RE test results from 4 to 10 GHz for FCC Part 27 (SC Config 1 – Mid channel)**

Frequency (MHz)	Level (dBµV)	Limit EIRP (dBµV)	Margin to EIRP Limit (dB)	Height (m)	Azimuth (deg)	Polarization	Correction (dB)
4434.649359	33.22	82.2	-48.98	3.68	312.00	Vertical	4.43

**Note:** In the table/Plot above, no emissions exceed the Part 27 radiated spurious emissions limit when converted to dBuV/m, except for the fundamental. For final spurious emissions measurements to FCC Part 27, see antenna port conducted emissions in applicable test report.





**Figure 18: Plot of RE at 3m from 10 to 18 GHz (SC Config 1 – Mid channel)**

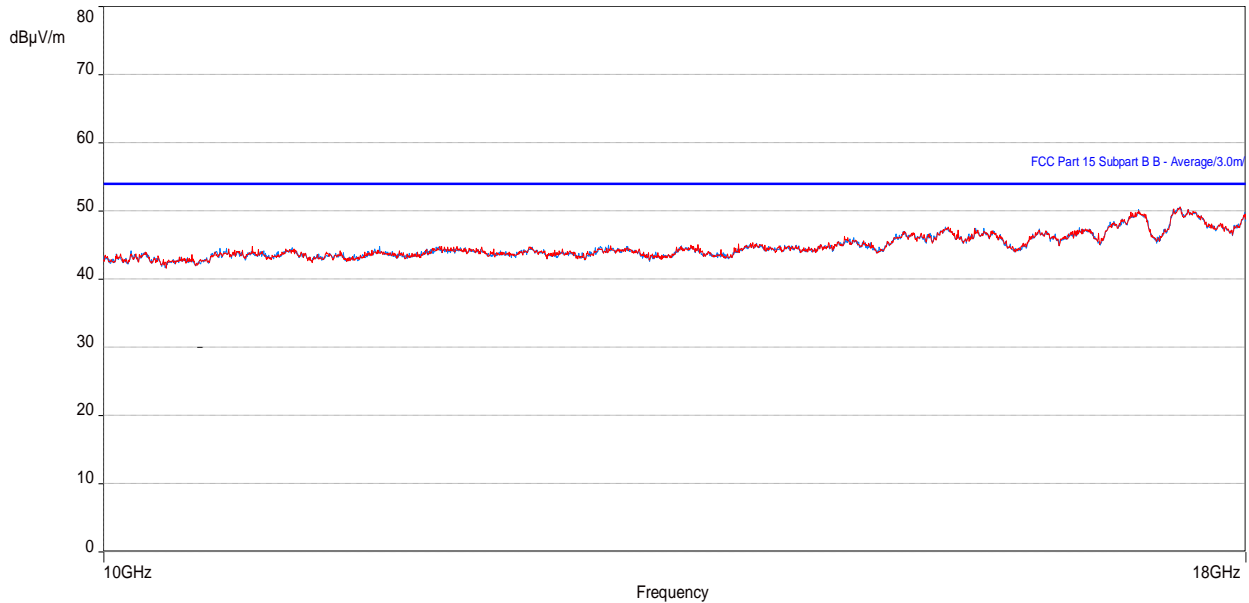

**Table 25: RE test results from 10 to 18 GHz for FCC Part 15 (SC Config 1 – Mid channel)**

Frequency (MHz)	Level Average (dBµV)	Limit Average (dBµV)	Margin to FCC part 15 Class B (dB)	Height (m)	Azimuth (degrees)	Polarization	Correction (dB)
17037.07018	46.81	53.96	-7.15	3.74	24.25	Vertical	21.07
17400.97726	47.14	53.96	-6.82	3.27	256.75	Horizontal	21.83
17404.67179	47.23	53.96	-6.73	3.79	16.75	Vertical	21.88

**Table 26: RE test results from 10 to 18 GHz (SC Config 1 – Mid channel)**

Frequency (MHz)	Level (dBµV)	Limit EIRP (dBµV)	Margin to EIRP Limit (dB)	Height (m)	Azimuth (deg)	Polarization	Correction (dB)
17037.07018	46.81	82.2	-35.06	3.74	24.25	Vertical	21.07
17400.97726	47.14	82.2	-34.97	3.27	256.75	Horizontal	21.83
17404.67179	47.23	82.2	-35.06	3.79	16.75	Vertical	21.88

**Note:** In the table/Plot above, no emissions exceeded the Part 27 radiated spurious emissions limit when converted to dBuV/m. For final spurious emissions measurements to FCC Part 27, see antenna port conducted emissions in applicable test report.

**Figure 19: Plot of RE at 1m from 18 to 26.5 GHz (SC Config 1 – Mid channel)**

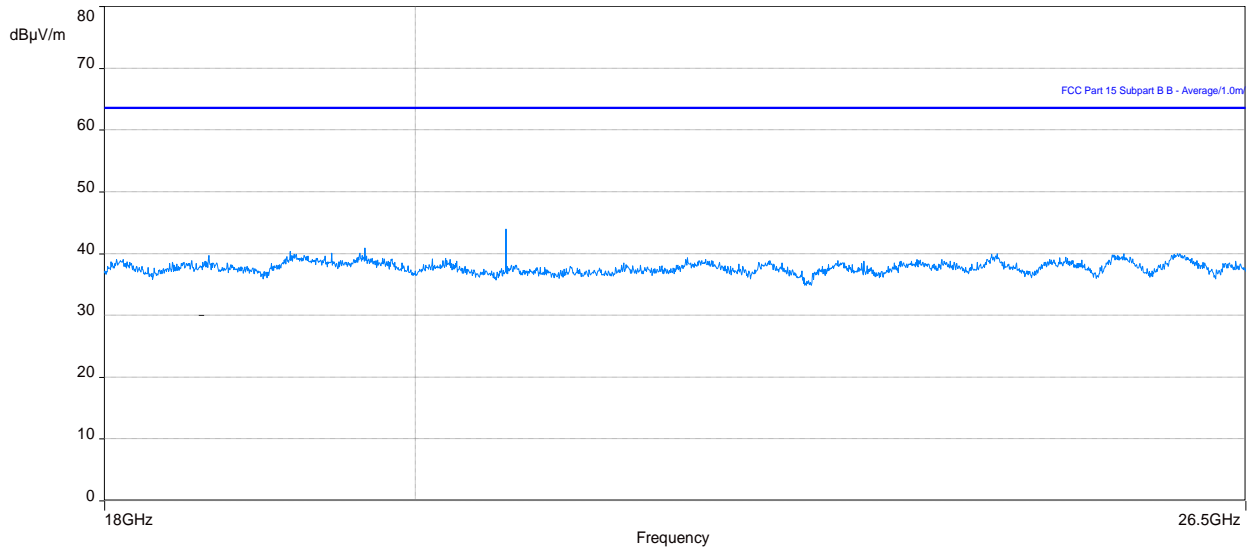

**Note 1:** In the plot above No Emissions exceeds the FCC Part 15 limit.

**Note 2:** In the plot above, no emissions exceed the Part 27 radiated spurious emissions limit when converted to dBuV/m. For final spurious emissions measurements to FCC Part 27, see antenna port conducted emissions in applicable test report.

**Figure 20: Plot of RE at 1m from 26.5 to 40 GHz (SC Config 1 – Mid channel)**

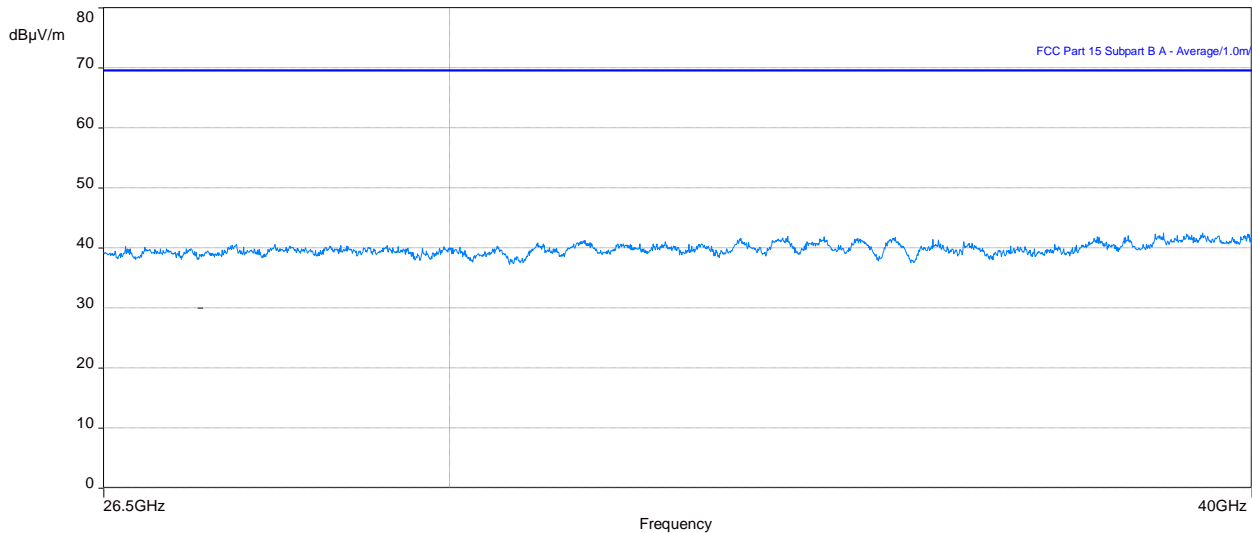

**Note 1:** In the plot above No Emissions exceeds the FCC Part 15 limit.

**Note 2:** In the plot above, no emissions exceed the Part 27 radiated spurious emissions limit when converted to dBuV/m. For final spurious emissions measurements to FCC Part 27, see antenna port conducted emissions in applicable test report.



---

### 3.2.7 Test results of RE – Single RAT/Single Carrier (SC Config 1 – Top channel)

Test location: 10-meter Ambient Free Chamber (AFC)

Date tested: 15 - 17 November, 2021

Tested by: Steve Mcfarlane & Krupal Patel

Test configurations are listed as SC Configuration 1 in Section 2.4.1.1 as identified in the section [Configurations of the EUT](#). For the following test results that have supporting data tables, negative margin values indicate a pass.

**Red trace** – Vertical antenna polarity, **Blue trace** – Horizontal antenna polarity

**Figure 21: Plot of RE at 3 m – 30 to 1000 MHz (SC Config 1 – Top channel)**

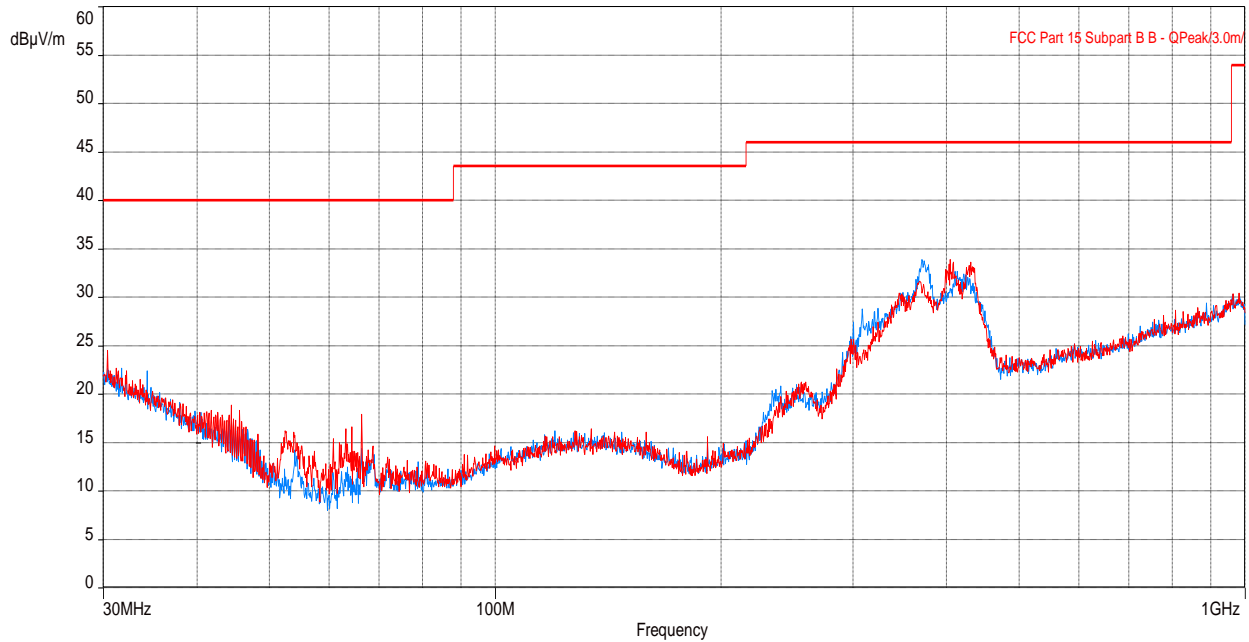

**Table 27: RE test results from 30 to 1000 MHz for FCC Part 15 (SC Config 1 – Top channel)**

Frequency (MHz)	Level (dBµV)	Limit Quasi-peak (dBµV)	Margin to FCC part 15 Class B (dB)	Height (m)	Azimuth (deg)	Polarization	Correction (dB)
370.6280159	32.21	46.02	-13.81	2.98	54.50	Horizontal	-4.78
404.3145064	31.34	46.02	-14.68	1.07	97.25	Vertical	-4.13

**Table 28: RE test results from 30 to 1000 MHz for FCC Part 27 (SC Config 1 – Top channel)**

Frequency (MHz)	Level (dBµV)	Limit EIRP (dBµV)	Margin to EIRP Limit (dB)	Height (m)	Azimuth (deg)	Polarization	Correction (dB)
370.6280159	32.21	82.2	-49.99	2.98	54.50	Horizontal	-4.78
404.3145064	31.34	82.2	-50.86	1.07	97.25	Vertical	-4.13

**Note:** In the table/Plot above, no emissions exceed the Part 27 radiated spurious emissions limit when converted to dBuV/m. For final spurious emissions measurements to FCC Part 27, see antenna port conducted emissions in applicable test report.

**Figure 22: Plot of RE at 3m from 1 to 4 GHz (SC Config 1 – Top channel)**

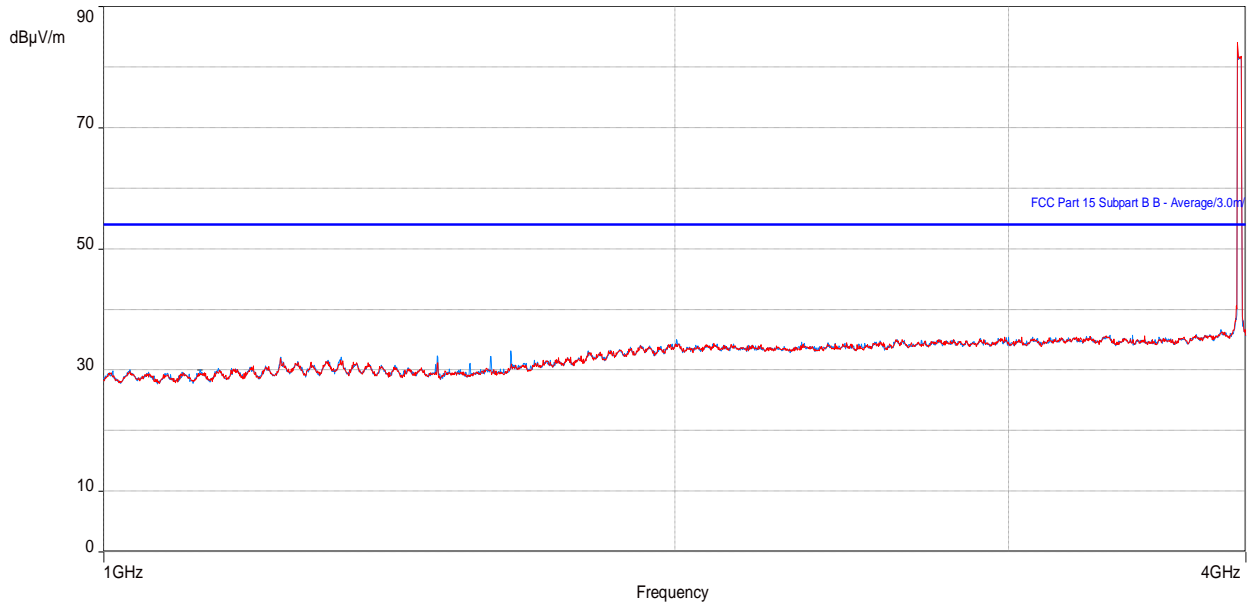

**Table 29: RE test results from 1 to 4 GHz for FCC Part 15 (SC Config 1 – Top channel)**

Frequency (MHz)	Level Average (dBµV)	Limit Average (dBµV)	Margin to FCC part 15 Class B (dB)	Height (m)	Azimuth (degrees)	Polarization	Correction (dB)
3378.13109	32.11	53.96	-21.85	3.68	163.00	Vertical	3.39
3393.844231	31.84	53.96	-22.12	2.58	98.25	Horizontal	3.39
3881.710897	33.15	53.96	-20.81	1.67	105.50	Horizontal	3.99
3884.449038	33.17	53.96	-20.79	2.03	77.50	Vertical	3.99

**Table 30: RE test results from 1 to 4 GHz for FCC Part 27 (SC Config 1 – Top channel)**

Frequency (MHz)	Level (dBµV)	Limit EIRP (dBµV)	Margin to EIRP Limit (dB)	Height (m)	Azimuth (deg)	Polarization	Correction (dB)
3378.13109	32.11	82.2	-50.09	3.68	163.00	Vertical	3.39
3393.844231	31.84	82.2	-50.36	2.58	98.25	Horizontal	3.39
3881.710897	33.15	82.2	-49.05	1.67	105.50	Horizontal	3.99
3884.449038	33.17	82.2	-49.03	2.03	77.50	Vertical	3.99

**Note:** In the table/Plot above, no emissions exceed the Part 27 radiated spurious emissions limit when converted to dBuV/m, except for the fundamental. For final spurious emissions measurements to FCC Part 27, see antenna port conducted emissions in applicable test report.

**Figure 23: Plot of RE at 3m from 4 to 10 GHz (SC Config 1 – Top channel)**

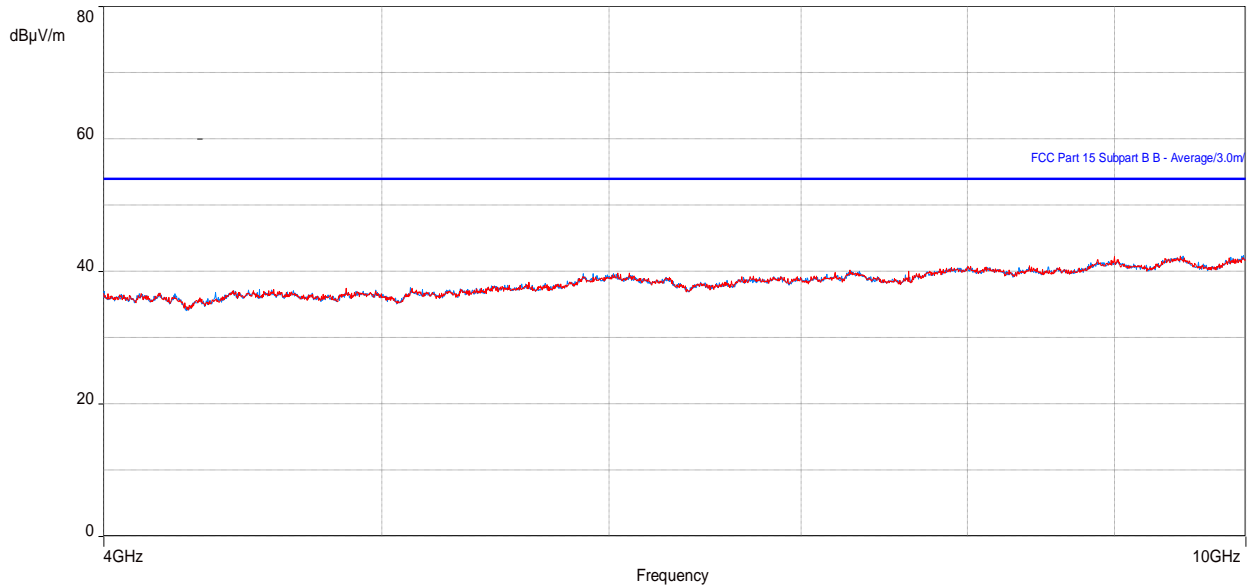

**Table 31: RE test results from 4 to 10 GHz for FCC Part 15 (SC Config 1 – Top channel)**

Frequency (MHz)	Level Average (dBµV)	Limit Average (dBµV)	Margin to FCC part 15 Class B (dB)	Height (m)	Azimuth (degrees)	Polarization	Correction (dB)
9001.375962	37.80	53.96	-16.16	2.99	168.50	Vertical	8.61
9025.088141	38.11	53.96	-15.85	3.27	185.00	Horizontal	8.61
9488.141987	38.24	53.96	-15.72	2.33	283.25	Vertical	9.55
9510.697756	38.30	53.96	-15.66	3.32	40.75	Horizontal	9.49

**Table 32: RE test results from 4 to 10 GHz for FCC Part 27 (SC Config 1 – Top channel)**

Frequency (MHz)	Level (dBµV)	Limit EIRP (dBµV)	Margin to EIRP Limit (dB)	Height (m)	Azimuth (deg)	Polarization	Correction (dB)
9001.375962	37.80	82.2	-44.4	2.99	168.50	Vertical	8.61
9025.088141	38.11	82.2	-44.09	3.27	185.00	Horizontal	8.61
9488.141987	38.24	82.2	-43.96	2.33	283.25	Vertical	9.55
9510.697756	38.30	82.2	-43.9	3.32	40.75	Horizontal	9.49

**Note:** In the table/Plot above, no emissions exceed the Part 27 radiated spurious emissions limit when converted to dBuV/m, except for the fundamental. For final spurious emissions measurements to FCC Part 27, see antenna port conducted emissions in applicable test report.

**Figure 24: Plot of RE at 3m from 10 to 18 GHz (SC Config 1 – Top channel)**

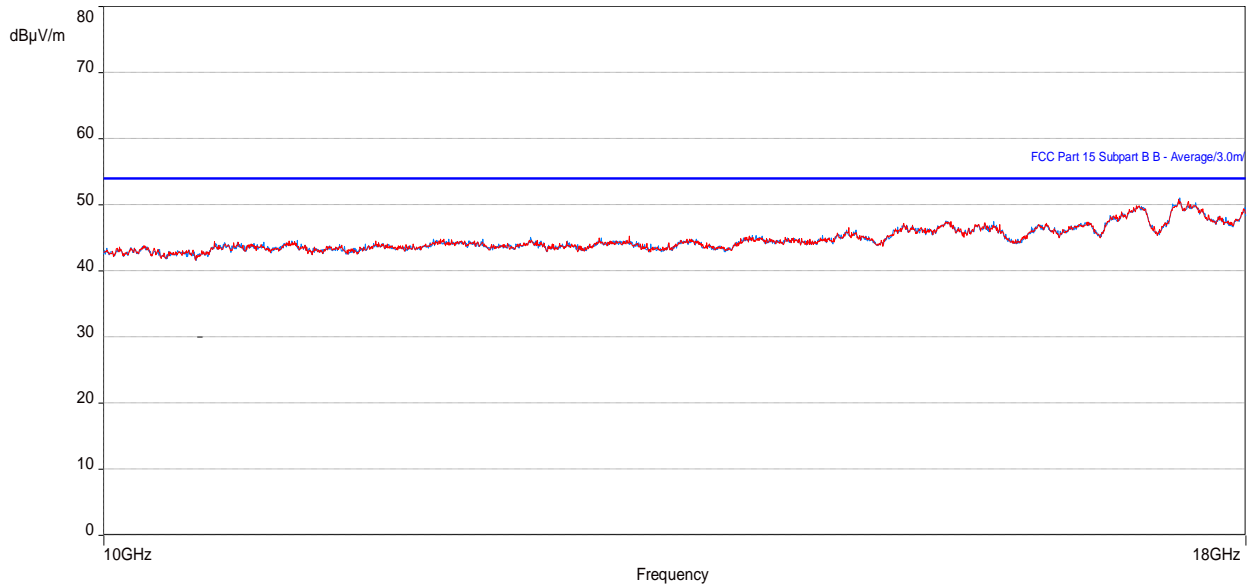

**Table 33: RE test results from 10 to 18 GHz for FCC Part 15 (SC Config 1 – Top channel)**

Frequency (MHz)	Level Average (dBµV)	Limit Average (dBµV)	Margin to FCC part 15 Class B (dB)	Height (m)	Azimuth (degrees)	Polarization	Correction (dB)
17389.75545	47.06	53.96	-6.90	3.52	0.25	Vertical	21.39
17398.31026	47.19	53.96	-6.77	4.00	2.50	Horizontal	21.75
17478.13077	46.69	53.96	-7.27	3.76	9.50	Vertical	22.85
17542.26604	46.76	53.96	-7.20	3.83	31.25	Horizontal	22.73

**Table 34: RE test results from 10 to 18 GHz (SC Config 1 – Top channel)**

Frequency (MHz)	Level (dBµV)	Limit EIRP (dBµV)	Margin to EIRP Limit (dB)	Height (m)	Azimuth (deg)	Polarization	Correction (dB)
17389.75545	47.06	82.2	-35.14	3.52	0.25	Vertical	21.39
17398.31026	47.19	82.2	-35.01	4.00	2.50	Horizontal	21.75
17478.13077	46.69	82.2	-35.51	3.76	9.50	Vertical	22.85
17542.26604	46.76	82.2	-35.44	3.83	31.25	Horizontal	22.73

**Note:** In the table/Plot above, no emissions exceed the Part 27 radiated spurious emissions limit when converted to dBuV/m. For final spurious emissions measurements to FCC Part 27, see antenna port conducted emissions in applicable test report.



---

### 3.2.8 Test results of RE – Single RAT / Multi Carrier (MC Config 1 – Mid channel)

Test location: 10-meter Ambient Free Chamber (AFC)

Date tested: 15 - 17 November, 2021

Tested by: Steve Mcfarlane & Krupal Patel

Test configurations are listed as MC Configuration 1 in Section 2.4.1.2 as identified in the section [Configurations of the EUT](#). For the following test results that have supporting data tables, negative margin values indicate a pass.

**Red trace** – Vertical antenna polarity, **Blue trace** – Horizontal antenna polarity



**Figure 25: Plot of RE at 3 m – 30 to 1000 MHz (MC Config 1 – Mid channel)**

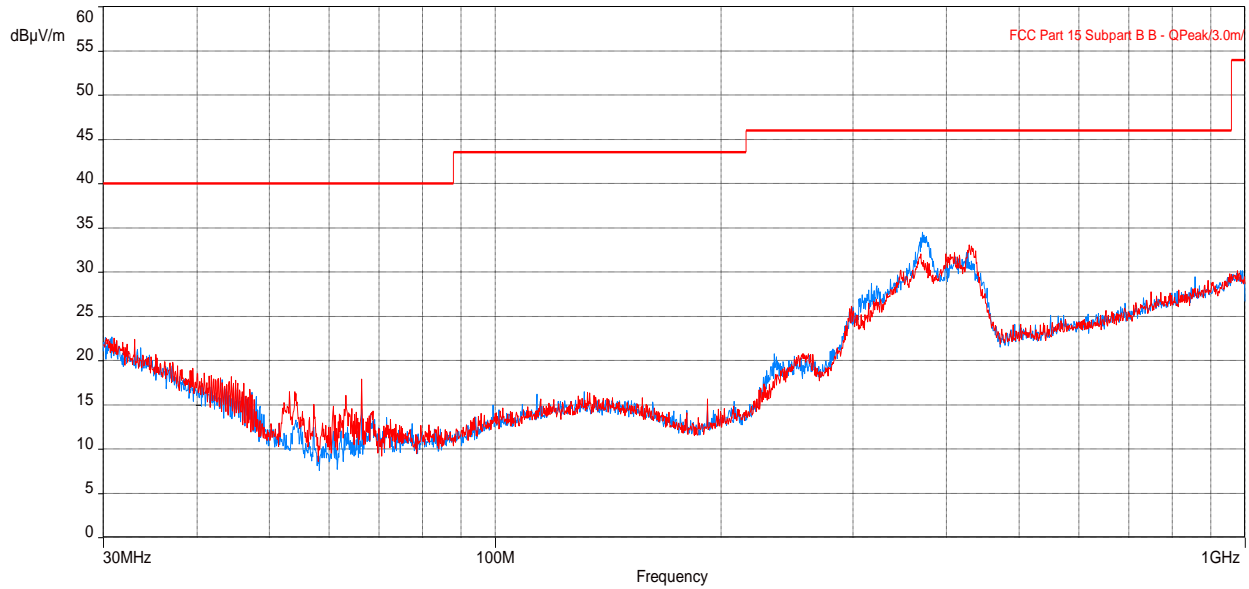

**Table 35: RE test results from 30 to 1000 MHz for FCC Part 15 (MC Config 1 – Mid channel)**

Frequency (MHz)	Level (dBµV)	Limit Quasi-peak (dBµV)	Margin to FCC part 15 Class B (dB)	Height (m)	Azimuth (deg)	Polarization	Correction (dB)
371.2780095	32.45	46.02	-13.57	3.07	48.00	Horizontal	-4.78
428.6290162	31.22	46.02	-14.80	1.04	255.50	Vertical	-3.49

**Table 36: RE test results from 30 to 1000 MHz for FCC Part 27 (MC Config 1 – Mid channel)**

Frequency (MHz)	Level (dBµV)	Limit EIRP (dBµV)	Margin to EIRP Limit (dB)	Height (m)	Azimuth (deg)	Polarization	Correction (dB)
371.2780095	32.45	82.2	-49.75	3.07	48.00	Horizontal	-4.78
428.6290162	31.22	82.2	-50.98	1.04	255.50	Vertical	-3.49

**Note:** In the table/Plot above, no emissions exceed the Part 27 radiated spurious emissions limit when converted to dBuV/m. For final spurious emissions measurements to FCC Part 27, see antenna port conducted emissions in applicable test report.

**Figure 26: Plot of RE at 3m from 1 to 4 GHz (MC Config 1 – Mid channel)**

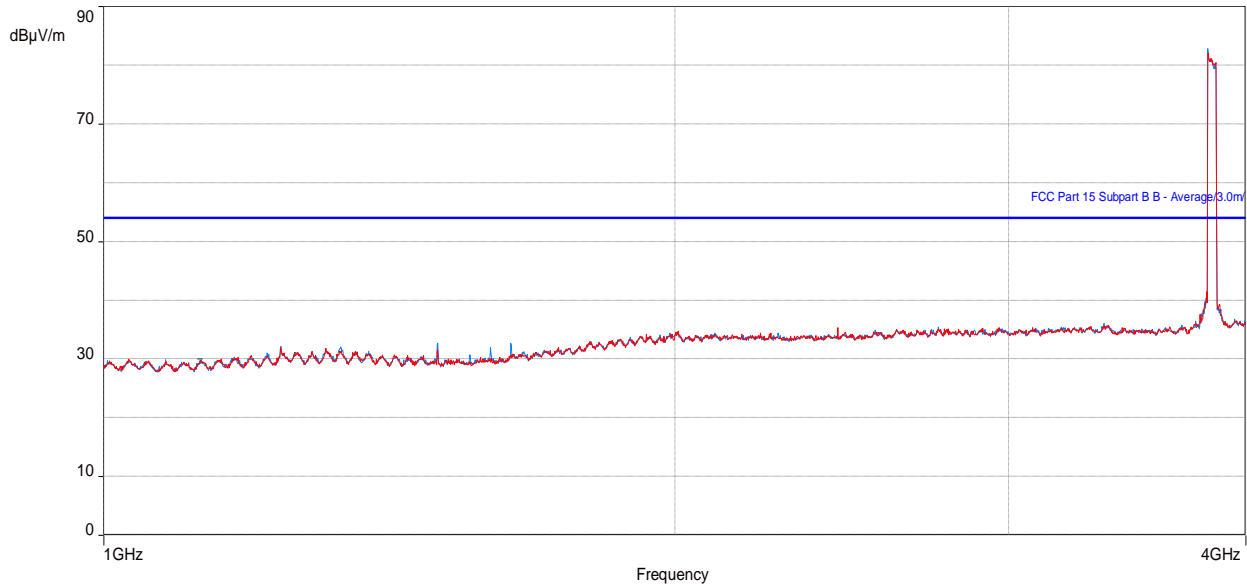

**Note:** Peak above the limit is leakage of the EUT’s fundamentals from the 50-ohm terminations.

**Table 37: RE test results from 1 to 4 GHz for FCC Part 15 (MC Config 1 – Mid channel)**

Frequency (MHz)	Level Average (dBµV)	Limit Average (dBµV)	Margin to FCC part 15 Class B (dB)	Height (m)	Azimuth (degrees)	Polarization	Correction (dB)
3386.478526	32.13	53.96	-21.83	1.00	283.25	Vertical	3.39
3956.300641	33.11	53.96	-20.85	3.42	26.50	Vertical	4.15
3368.917628	32.19	53.96	-21.77	3.37	2.25	Horizontal	3.40
3947.434295	33.37	53.96	-20.59	3.07	62.50	Horizontal	4.13

**Table 38: RE test results from 1 to 4 GHz for FCC Part 27 (MC Config 1 – Mid channel)**

Frequency (MHz)	Level (dBµV)	Limit EIRP (dBµV)	Margin to EIRP Limit (dB)	Height (m)	Azimuth (deg)	Polarization	Correction (dB)
3386.478526	32.13	82.2	-50.07	1.00	283.25	Vertical	3.39
3956.300641	33.11	82.2	-49.09	3.42	26.50	Vertical	4.15
3368.917628	32.19	82.2	-50.01	3.37	2.25	Horizontal	3.40
3947.434295	33.37	82.2	-48.83	3.07	62.50	Horizontal	4.13

**Note:** In the table/Plot above, no emissions exceed the Part 27 radiated spurious emissions limit when converted to dBuV/m, except for the fundamental. For final spurious emissions measurements to FCC Part 27, see antenna port conducted emissions in applicable test report.

**Figure 27: Plot of RE at 3m from 4 to 10 GHz (MC Config 1 – Mid channel)**

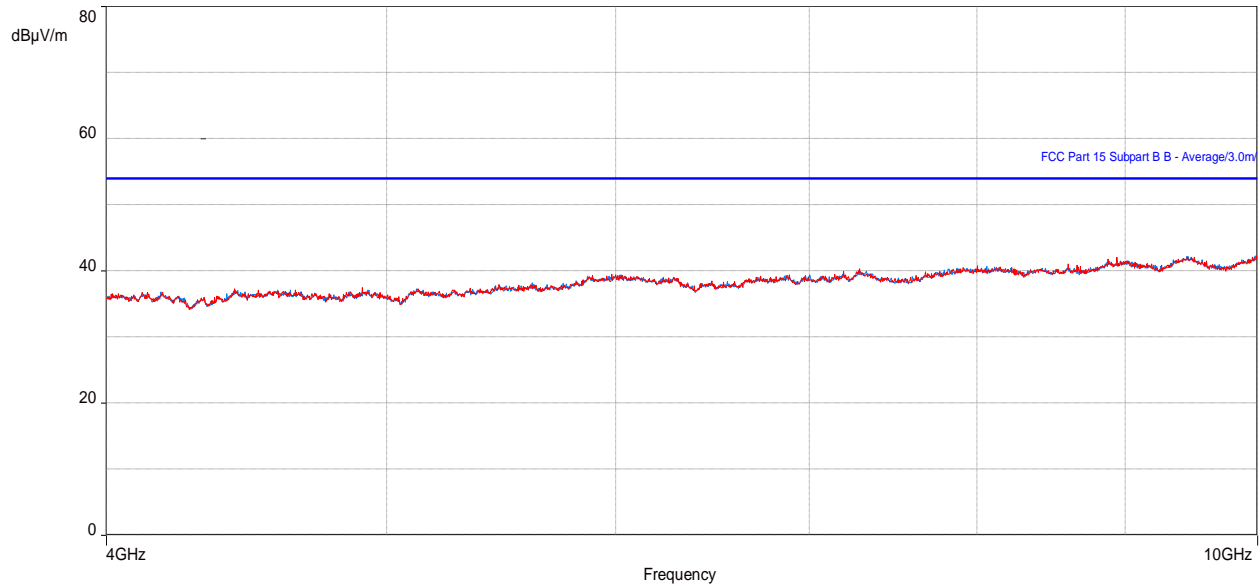

**Table 39: RE test results from 4 to 10 GHz for FCC Part 15 (MC Config 1 – Mid channel)**

Frequency (MHz)	Level Average (dBµV)	Limit Average (dBµV)	Margin to FCC part 15 Class B (dB)	Height (m)	Azimuth (degrees)	Polarization	Correction (dB)
8941.536538	37.56	53.96	-16.40	3.37	156.00	Vertical	8.67
9026.092949	37.91	53.96	-16.05	2.12	11.75	Horizontal	8.61
9460.529808	38.18	53.96	-15.78	3.46	220.75	Vertical	9.47
9465.712179	37.94	53.96	-16.02	1.17	0.00	Horizontal	9.49

**Table 40: RE test results from 4 to 10 GHz for FCC Part 27 (MC Config 1 – Mid channel)**

Frequency (MHz)	Level (dBµV)	Limit EIRP (dBµV)	Margin to EIRP Limit (dB)	Height (m)	Azimuth (deg)	Polarization	Correction (dB)
8941.536538	37.56	82.2	-44.64	3.37	156.00	Vertical	8.67
9026.092949	37.91	82.2	-44.29	2.12	11.75	Horizontal	8.61
9460.529808	38.18	82.2	-44.02	3.46	220.75	Vertical	9.47
9465.712179	37.94	82.2	-44.26	1.17	0.00	Horizontal	9.49

**Note:** In the table/Plot above, no emissions exceed the Part 27 radiated spurious emissions limit when converted to dBuV/m, except for the fundamental. For final spurious emissions measurements to FCC Part 27, see antenna port conducted emissions in applicable test report.

**Figure 28: Plot of RE at 3m from 10 to 18 GHz (MC Config 1 – Mid channel)**

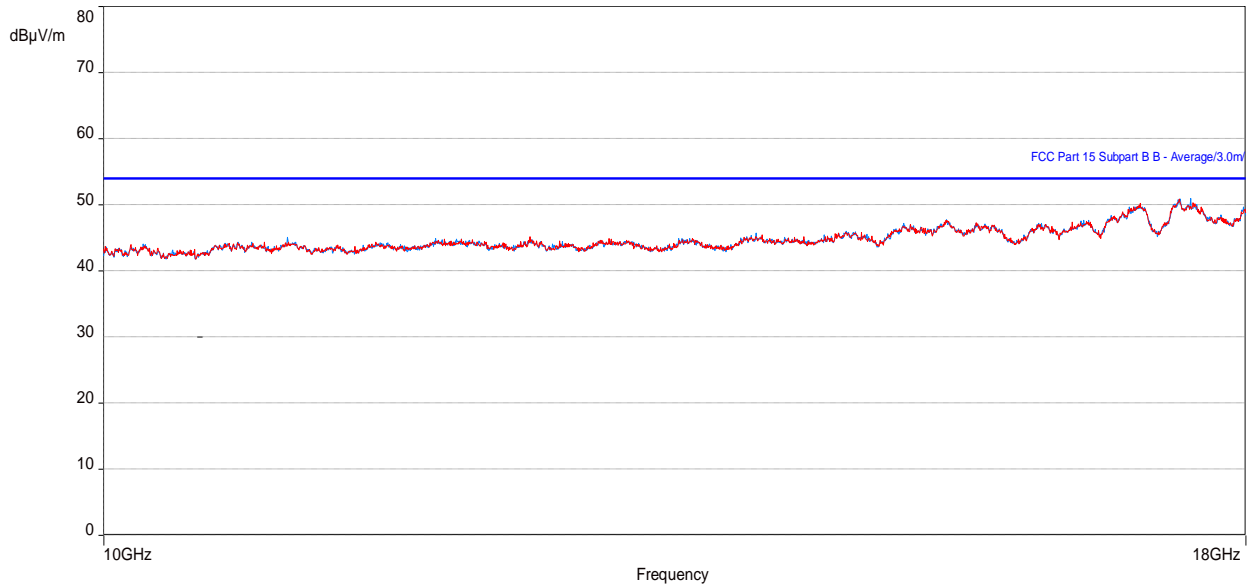

**Table 41: RE test results from 10 to 18 GHz for FCC Part 15 (MC Config 1 – Mid channel)**

Frequency (MHz)	Level Average (dBµV)	Limit Average (dBµV)	Margin to FCC part 15 Class B (dB)	Height (m)	Azimuth (degrees)	Polarization	Correction (dB)
17394.64777	47.11	53.96	-6.85	4.00	278.25	Vertical	21.59
17404.38236	47.05	53.96	-6.91	3.57	53.25	Horizontal	21.88
17499.59999	46.53	53.96	-7.43	4.00	95.75	Horizontal	23.16
17517.67051	46.56	53.96	-7.40	3.71	17.00	Vertical	22.98

**Table 42: RE test results from 10 to 18 GHz (MC Config 1 – Mid channel)**

Frequency (MHz)	Level (dBµV)	Limit EIRP (dBµV)	Margin to EIRP Limit (dB)	Height (m)	Azimuth (deg)	Polarization	Correction (dB)
17394.64777	47.11	82.2	-35.09	4.00	278.25	Vertical	21.59
17404.38236	47.05	82.2	-35.15	3.57	53.25	Horizontal	21.88
17499.59999	46.53	82.2	-35.67	4.00	95.75	Horizontal	23.16
17517.67051	46.56	82.2	-35.64	3.71	17.00	Vertical	22.98

**Note:** In the table/Plot above, no emissions exceed the Part 27 radiated spurious emissions limit when converted to dBuV/m. For final spurious emissions measurements to FCC Part 27, see antenna port conducted emissions in applicable test report.



---

### 3.2.9 Test results of RE – Single RAT/Single Carrier (SC Config 2 – Mid channel)

Test location: 10-meter Ambient Free Chamber (AFC)

Date tested: 28 - 31 January, 2022

Tested by: Kasi Sivaratnam

Test configurations are listed as SC Configuration 2 in Section 2.4.1.3 as identified in the section [Configurations of the EUT](#). For the following test results that have supporting data tables, negative margin values indicate a pass.

**Red trace** – Vertical antenna polarity, **Blue trace** – Horizontal antenna polarity

**Figure 29: Plot of RE at 3 m – 30 to 1000 MHz (SC Config 2 – Mid channel)**

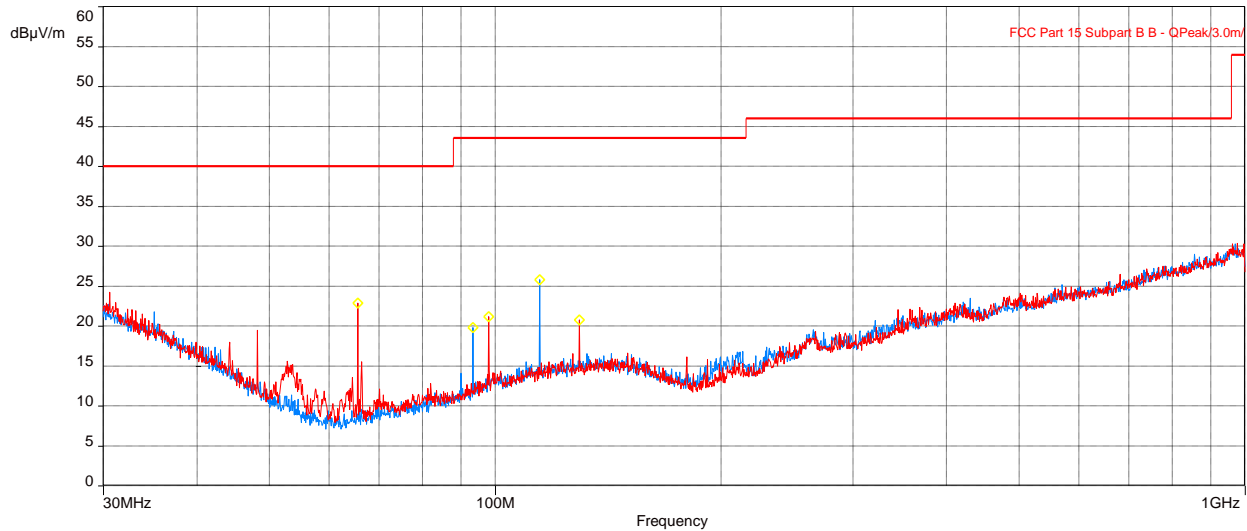

**Table 43: RE test results from 30 to 1000 MHz for FCC Part 15 (SC Config 2 – Mid channel)**

Frequency (MHz)	Level (dBµV)	Limit Quasi-peak (dBµV)	Margin to FCC part 15 Class B (dB)	Height (m)	Azimuth (deg)	Polarization	Correction (dB)
65.63133333	6.78	40.00	-33.22	1.14	3.50	Vertical	-16.43
98.11371154	8.63	43.52	-34.89	1.20	39.75	Vertical	-11.80
129.5007277	10.58	43.52	-32.94	4.00	291.50	Vertical	-9.61
114.6733077	10.73	43.52	-32.79	1.39	256.50	Horizontal	-10.29

**Table 44: RE test results from 30 to 1000 MHz for FCC Part 27 (SC Config 2 – Mid channel)**

Frequency (MHz)	Level (dBµV)	Limit EIRP (dBµV)	Margin to EIRP Limit (dB)	Height (m)	Azimuth (deg)	Polarization	Correction (dB)
65.63133333	6.78	82.2	-75.42	1.14	3.50	Vertical	-16.43
98.11371154	8.63	82.2	-73.57	1.20	39.75	Vertical	-11.80
129.5007277	10.58	82.2	-71.62	4.00	291.50	Vertical	-9.61
114.6733077	10.73	82.2	-71.47	1.39	256.50	Horizontal	-10.29

**Note:** In the table/Plot above, no emissions exceed the Part 27 radiated spurious emissions limit when converted to dBuV/m. For final spurious emissions measurements to FCC Part 27, see antenna port conducted emissions in applicable test report.

**Figure 30: Plot of RE at 3m from 1 to 4 GHz (SC Config 2 – Mid channel)**

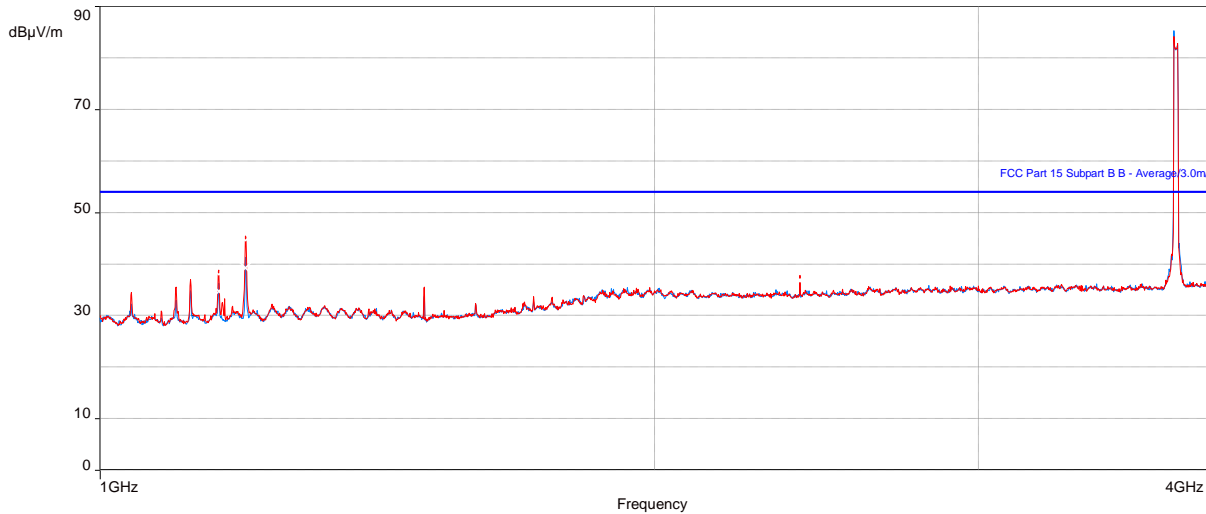

**Note:** Peak above the limit is leakage of the EUT’s fundamentals from the 50-ohm terminations.

**Table 45: RE test results from 1 to 4 GHz for FCC Part 15 (SC Config 2 – Mid channel)**

Frequency (MHz)	Level Average (dBµV)	Limit Average (dBµV)	Margin to FCC part 15 Class B (dB)	Height (m)	Azimuth (degrees)	Polarization	Correction (dB)
1159.957692	34.69	53.96	-19.27	2.49	82.50	Vertical	-4.01
1199.766346	39.19	53.96	-14.77	3.07	329.00	Vertical	-3.76
2399.985577	36.76	53.96	-17.20	1.87	268.75	Vertical	1.71

**Table 46: RE test results from 1 to 4 GHz for FCC Part 27 (SC Config 2 – Mid channel)**

Frequency (MHz)	Level (dBµV)	Limit EIRP (dBµV)	Margin to EIRP Limit (dB)	Height (m)	Azimuth (deg)	Polarization	Correction (dB)
1159.957692	34.69	82.2	-47.51	2.49	82.50	Vertical	-4.01
1199.766346	39.19	82.2	-43.01	3.07	329.00	Vertical	-3.76
2399.985577	36.76	82.2	-45.44	1.87	268.75	Vertical	1.71

**Note:** In the table/Plot above, no emissions exceed the Part 27 radiated spurious emissions limit when converted to dBuV/m, except for the fundamental. For final spurious emissions measurements to FCC Part 27, see antenna port conducted emissions in applicable test report.

**Figure 31: Plot of RE at 3m from 4 to 10 GHz (SC Config 2 – Mid channel)**

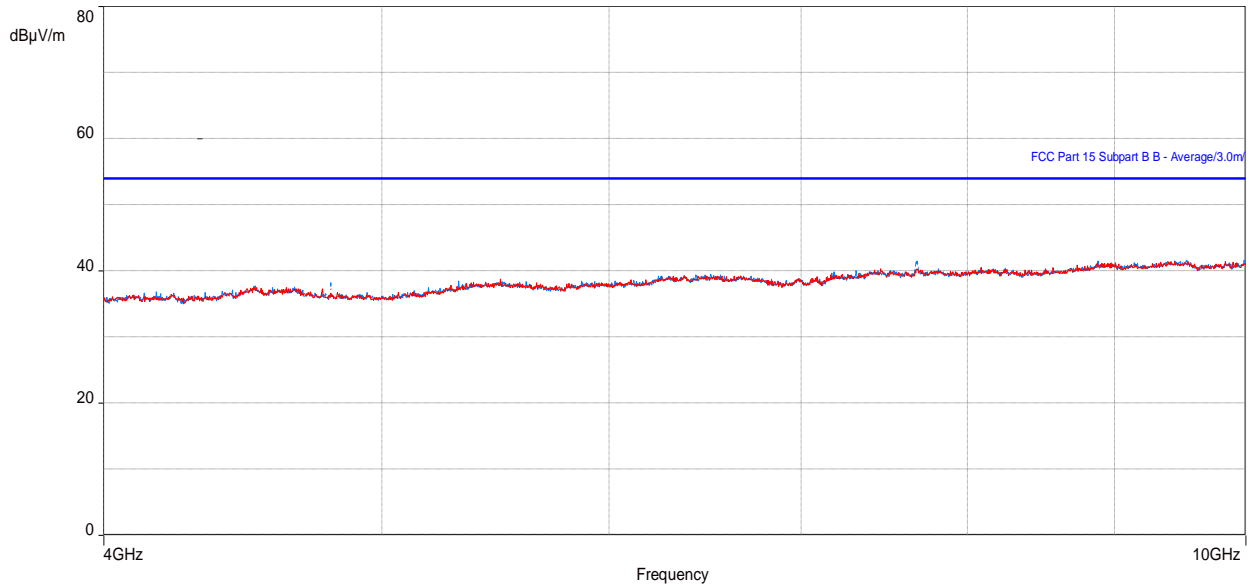

**Table 47: RE test results from 4 to 10 GHz for FCC Part 15 (SC Config 2 – Mid channel)**

Frequency (MHz)	Level Average (dBµV)	Limit Average (dBµV)	Margin to FCC part 15 Class B (dB)	Height (m)	Azimuth (degrees)	Polarization	Correction (dB)
4799.968269	36.93	53.96	-17.03	3.96	11.00	Horizontal	4.73
7675.395833	37.78	53.96	-16.18	1.00	25.25	Horizontal	8.12

**Table 48: RE test results from 4 to 10 GHz for FCC Part 27 (SC Config 2 – Mid channel)**

Frequency (MHz)	Level (dBµV)	Limit EIRP (dBµV)	Margin to EIRP Limit (dB)	Height (m)	Azimuth (deg)	Polarization	Correction (dB)
4799.968269	36.93	82.2	-45.27	3.96	11.00	Horizontal	4.73
7675.395833	37.78	82.2	-44.42	1.00	25.25	Horizontal	8.12

**Note:** In the table/Plot above, no emissions exceed the Part 27 radiated spurious emissions limit when converted to dBuV/m, except for the fundamental. For final spurious emissions measurements to FCC Part 27, see antenna port conducted emissions in applicable test report.



**Figure 32: Plot of RE at 3m from 10 to 18 GHz (SC Config 2 – Mid channel)**

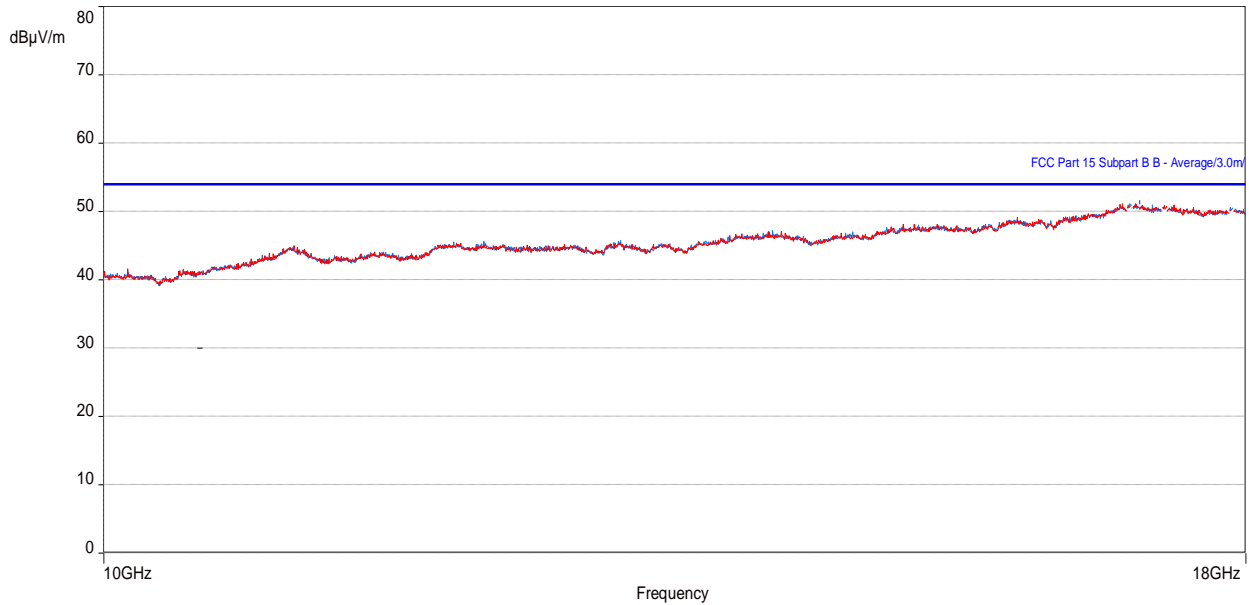

**Table 49: RE test results from 10 to 18 GHz for FCC Part 15 (SC Config 2 – Mid channel)**

Frequency (MHz)	Level Average (dBµV)	Limit Average (dBµV)	Margin to FCC part 15 Class B (dB)	Height (m)	Azimuth (degrees)	Polarization	Correction (dB)
16945.74423	46.17	53.96	-7.79	2.10	-2.00	Horizontal	17.35
17046.46668	46.53	53.96	-7.43	2.56	341.25	Horizontal	17.47
17262.96986	46.33	53.96	-7.63	3.38	278.75	Horizontal	17.45
17857.41473	46.13	53.96	-7.83	3.66	235.50	Horizontal	17.15

**Table 50: RE test results from 10 to 18 GHz (SC Config 2 – Mid channel)**

Frequency (MHz)	Level (dBµV)	Limit EIRP (dBµV)	Margin to EIRP Limit (dB)	Height (m)	Azimuth (deg)	Polarization	Correction (dB)
16945.74423	46.17	82.2	-36.03	3.74	24.25	Vertical	21.07
17046.46668	46.53	82.2	-35.67	3.27	256.75	Horizontal	21.83
17262.96986	46.33	82.2	-35.87	3.79	16.75	Vertical	21.88
17857.41473	46.13	82.2	-36.07	3.66	235.50	Horizontal	17.15

**Note:** In the table/Plot above, no emissions exceed the Part 27 radiated spurious emissions limit when converted to dBuV/m. For final spurious emissions measurements to FCC Part 27, see antenna port conducted emissions in applicable test report.

**Figure 33: Plot of RE at 1m from 18 to 26.5 GHz (SC Config 2 – Mid channel)**

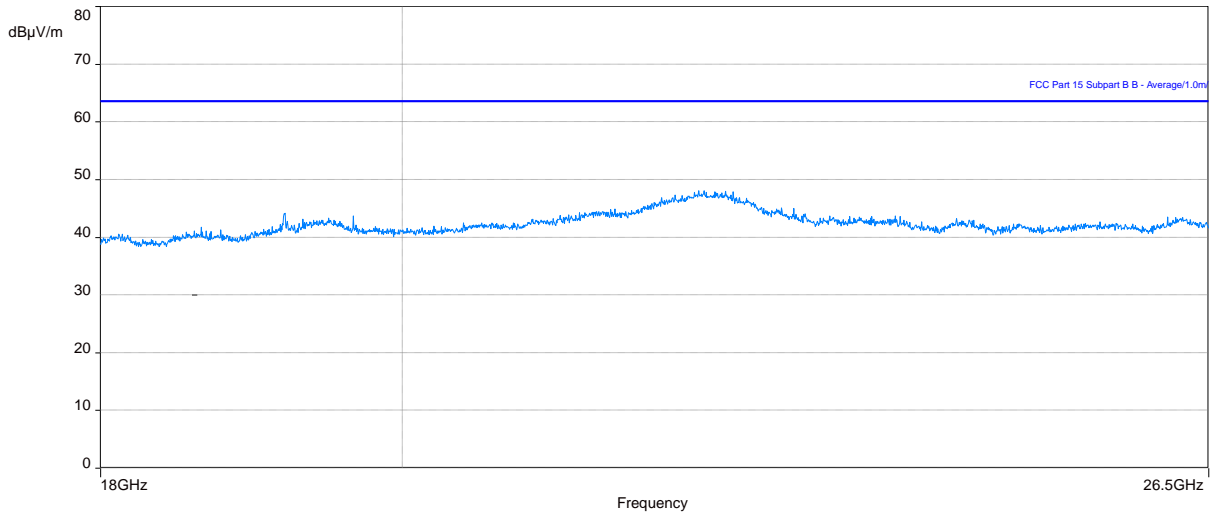

**Note 1:** In the plot above No Emissions exceeds the FCC Part 15 limit.

**Note 2:** In the plot above, no emissions exceed the Part 27 radiated spurious emissions limit when converted to dBuV/m. For final spurious emissions measurements to FCC Part 27, see antenna port conducted emissions in applicable test report.

**Figure 34: Plot of RE at 1m from 26.5 to 40 GHz (SC Config 2 – Mid channel)**

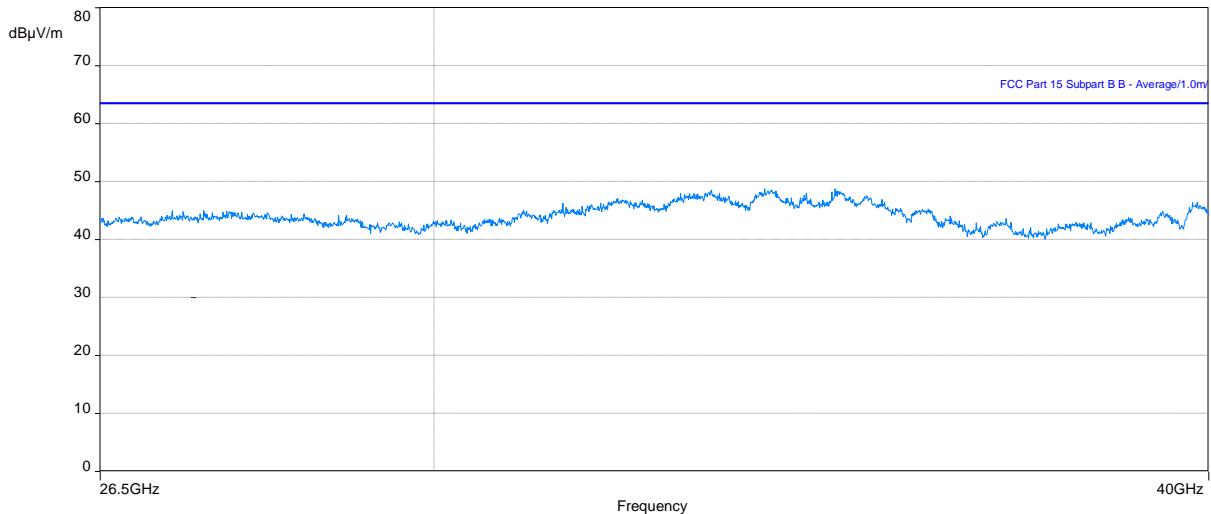

**Note 1:** In the plot above No Emissions exceeds the FCC Part 15 limit.

**Note 2:** In the plot above, no emissions exceed the Part 27 radiated spurious emissions limit when converted to dBuV/m. For final spurious emissions measurements to FCC Part 27, see antenna port conducted emissions in applicable test report.



---

### 3.2.10 Test results of RE – Single RAT/Multi Carrier (MC Config 2 – Mid channel)

Test location: 10-meter Ambient Free Chamber (AFC)

Date tested: 28 - 31 January, 2022

Tested by: Kasi Sivaratnam

Test configurations are listed as MC Configuration 2 in Section 2.4.1.4 as identified in the section [Configurations of the EUT](#). For the following test results that have supporting data tables, negative margin values indicate a pass.

**Red trace** – Vertical antenna polarity, **Blue trace** – Horizontal antenna polarity

**Figure 35: Plot of RE at 3 m – 30 to 1000 MHz (MC Config 2 – Mid channel)**

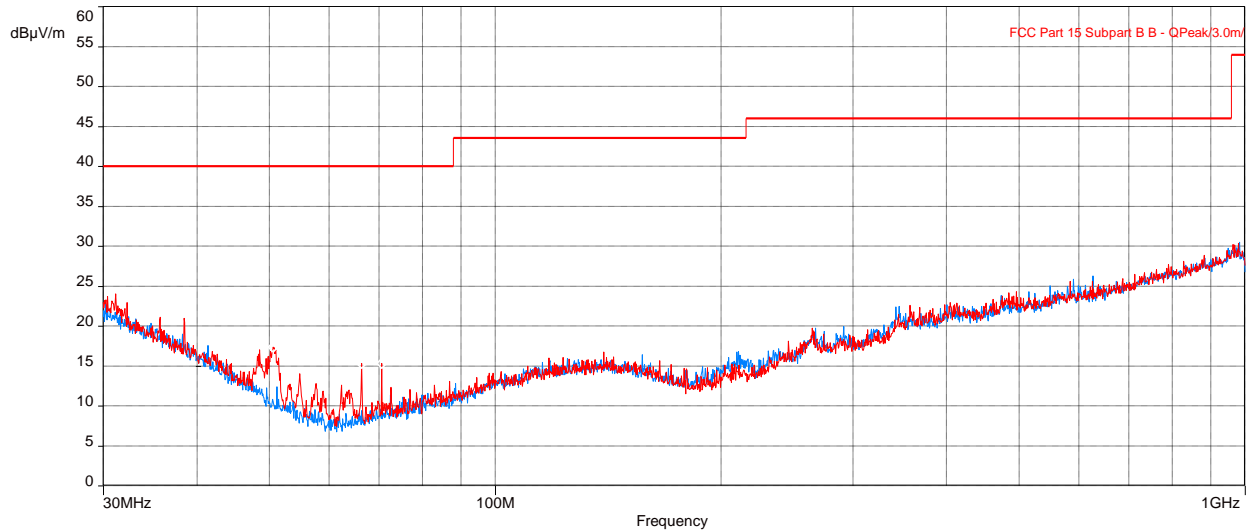

**Table 51: RE test results from 30 to 1000 MHz for FCC Part 15 (MC Config 2 – Mid channel)**

Frequency (MHz)	Level (dBµV)	Limit Quasi-peak (dBµV)	Margin to FCC part 15 Class B (dB)	Height (m)	Azimuth (deg)	Polarization	Correction (dB)
50.51163495	7.41	40.00	-32.59	1.65	0.25	Vertical	-14.04
66.35709008	15.32	40.00	-24.68	1.23	40.75	Vertical	-16.35
70.60457726	5.39	40.00	-34.61	1.60	156.00	Vertical	-15.71

**Table 52: RE test results from 30 to 1000 MHz for FCC Part 27 (MC Config 2 – Mid channel)**

Frequency (MHz)	Level (dBµV)	Limit EIRP (dBµV)	Margin to EIRP Limit (dB)	Height (m)	Azimuth (deg)	Polarization	Correction (dB)
50.51163495	7.41	82.2	-74.79	1.65	0.25	Vertical	-14.04
66.35709008	15.32	82.2	-66.88	1.23	40.75	Vertical	-16.35
70.60457726	5.39	82.2	-76.81	1.60	156.00	Vertical	-15.71

**Note:** In the table/Plot above, no emissions exceeded the Part 27 radiated spurious emissions limit when converted to dBuV/m. For final spurious emissions measurements to FCC Part 27, see antenna port conducted emissions in applicable test report.

**Figure 36: Plot of RE at 3m from 1 to 4 GHz (MC Config 2 – Mid channel)**

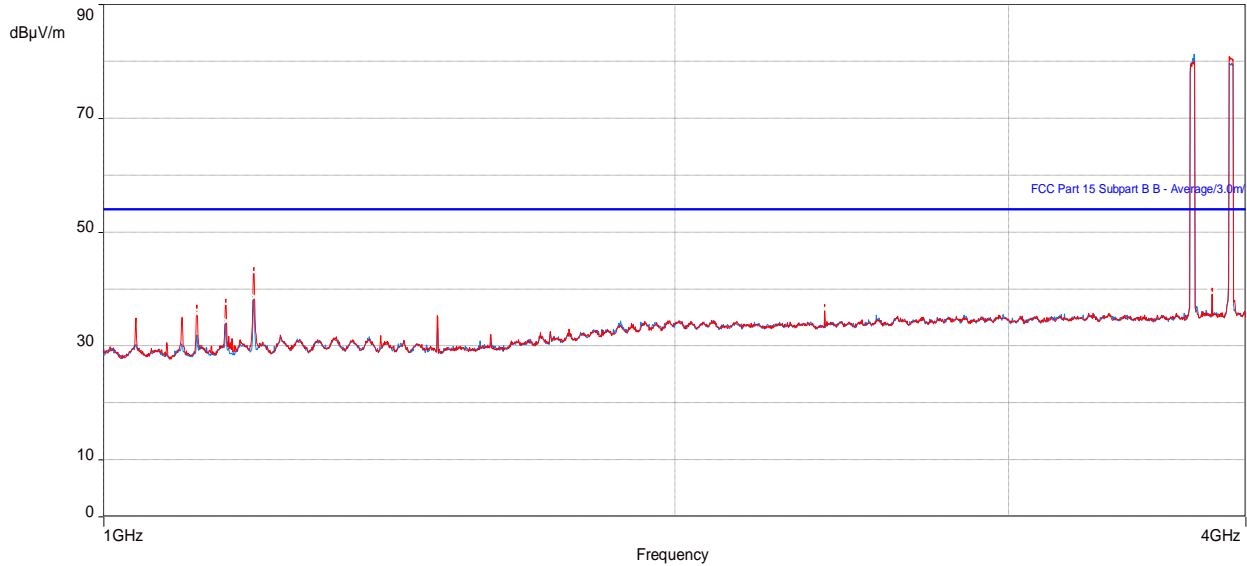

**Note:** Peak above the limit is leakage of the EUT’s fundamentals from the 50-ohm terminations.

**Table 53: RE test results from 1 to 4 GHz for FCC Part 15 (MC Config 2 – Mid channel)**

Frequency (MHz)	Level Average (dBµV)	Limit Average (dBµV)	Margin to FCC part 15 Class B (dB)	Height (m)	Azimuth (degrees)	Polarization	Correction (dB)
1119.921795	35.73	53.96	-18.23	1.00	349.00	Vertical	-4.54
1159.91859	34.42	53.96	-19.54	2.56	82.50	Vertical	-4.01
1199.994551	38.62	53.96	-15.34	3.07	327.50	Vertical	-3.76
2399.983013	36.50	53.96	-17.46	1.87	262.50	Vertical	1.71

**Table 54: RE test results from 1 to 4 GHz for FCC Part 27 (MC Config 2 – Mid channel)**

Frequency (MHz)	Level (dBµV)	Limit EIRP (dBµV)	Margin to EIRP Limit (dB)	Height (m)	Azimuth (deg)	Polarization	Correction (dB)
1119.921795	35.73	82.2	-46.47	1.00	349.00	Vertical	-4.54
1159.91859	34.42	82.2	-47.78	2.56	82.50	Vertical	-4.01
1199.994551	38.62	82.2	-43.58	3.07	327.50	Vertical	-3.76
2399.983013	36.50	82.2	-45.7	1.87	262.50	Vertical	1.71

**Note:** In the table/Plot above, no emissions exceed the Part 27 radiated spurious emissions limit when converted to dBuV/m, except for the fundamental. For final spurious emissions measurements to FCC Part 27, see antenna port conducted emissions in applicable test report.

**Figure 37: Plot of RE at 3m from 4 to 10 GHz (MC Config 2 – Mid channel)**

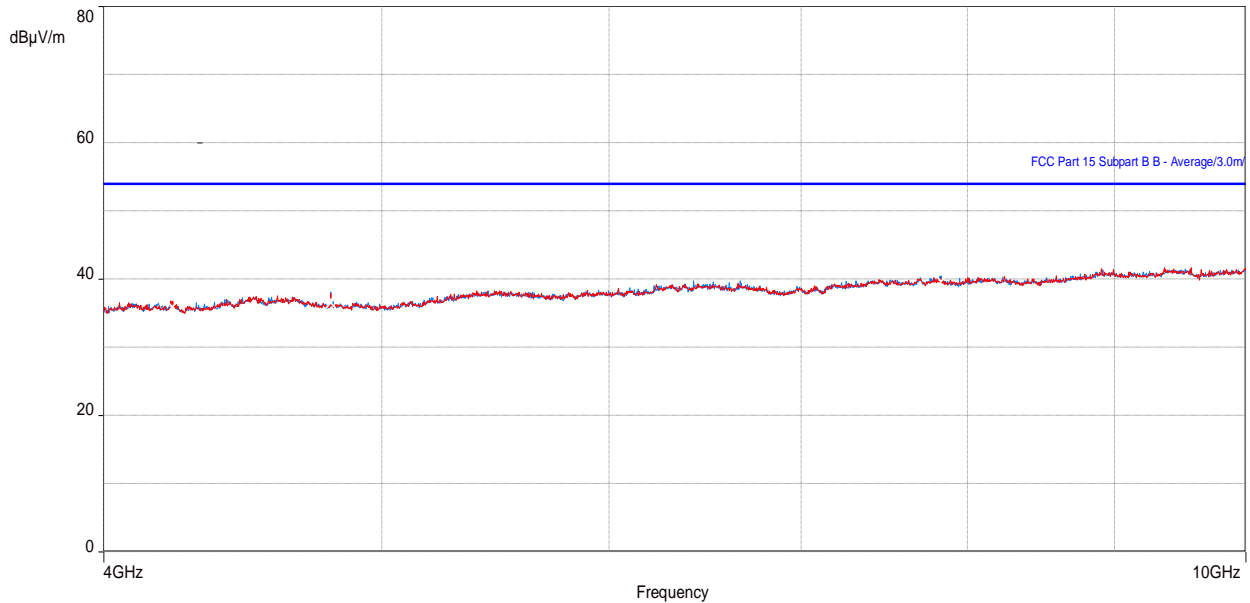

**Table 55: RE test results from 4 to 10 GHz for FCC Part 15 (MC Config 2 – Mid channel)**

Frequency (MHz)	Level Average (dBµV)	Limit Average (dBµV)	Margin to FCC part 15 Class B (dB)	Height (m)	Azimuth (degrees)	Polarization	Correction (dB)
4225.894551	33.14	53.96	-20.82	1.00	291.75	Horizontal	4.44
4799.967949	36.48	53.96	-17.48	3.62	11.00	Horizontal	4.73
7832.388782	36.18	53.96	-17.78	1.11	356.75	Horizontal	8.04

**Table 56: RE test results from 4 to 10 GHz for FCC Part 27 (MC Config 2 – Mid channel)**

Frequency (MHz)	Level (dBµV)	Limit EIRP (dBµV)	Margin to EIRP Limit (dB)	Height (m)	Azimuth (deg)	Polarization	Correction (dB)
4225.894551	33.14	82.2	-49.06	1.00	291.75	Horizontal	4.44
4799.967949	36.48	82.2	-45.72	3.62	11.00	Horizontal	4.73
7832.388782	36.18	82.2	-46.02	1.11	356.75	Horizontal	8.04

**Note:** In the table/Plot above, no emissions exceed the Part 27 radiated spurious emissions limit when converted to dBuV/m, except for the fundamental. For final spurious emissions measurements to FCC Part 27, see antenna port conducted emissions in applicable test report.

**Figure 38: Plot of RE at 3m from 10 to 18 GHz (MC Config 2 – Mid channel)**

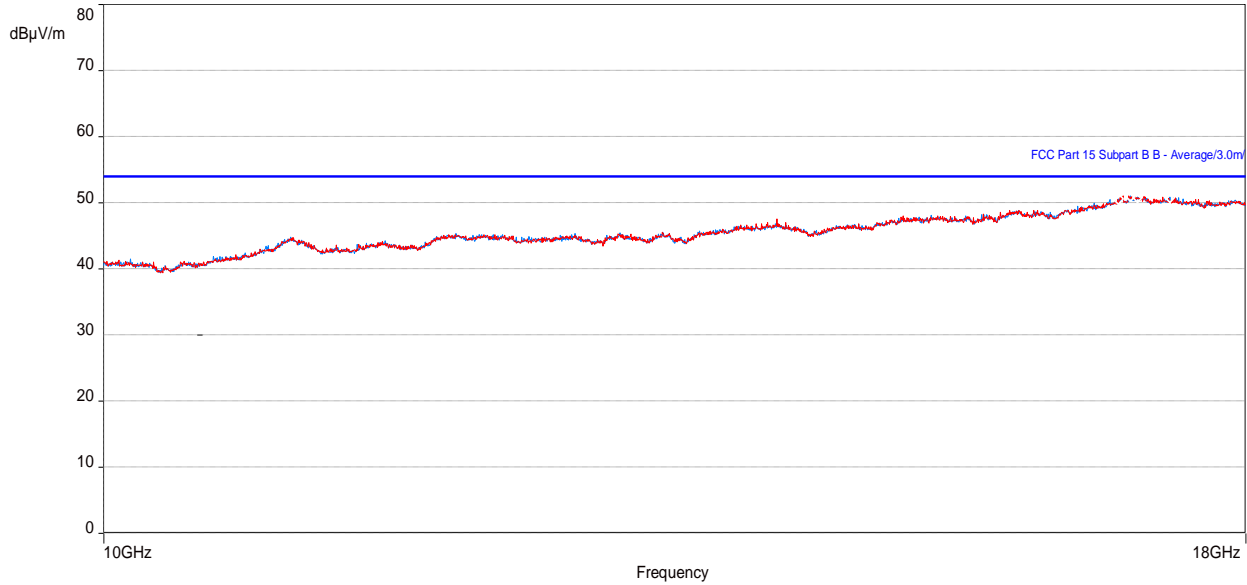

**Table 57: RE test results from 10 to 18 GHz for FCC Part 15 (MC Config 2 – Mid channel)**

Frequency (MHz)	Level Average (dBµV)	Limit Average (dBµV)	Margin to FCC part 15 Class B (dB)	Height (m)	Azimuth (degrees)	Polarization	Correction (dB)
16857.15354	46.55	53.96	-7.41	1.94	360.00	Horizontal	17.16
17027.53591	46.34	53.96	-7.62	3.48	300.25	Horizontal	17.45
17312.00321	46.38	53.96	-7.58	2.04	156.00	Horizontal	17.43

**Table 58: RE test results from 10 to 18 GHz (MC Config 2 – Mid channel)**

Frequency (MHz)	Level (dBµV)	Limit EIRP (dBµV)	Margin to EIRP Limit (dB)	Height (m)	Azimuth (deg)	Polarization	Correction (dB)
16857.15354	46.55	82.2	-35.65	1.94	360.00	Horizontal	17.16
17027.53591	46.34	82.2	-35.86	3.48	300.25	Horizontal	17.45
17312.00321	46.38	82.2	-35.82	2.04	156.00	Horizontal	17.43

**Note:** In the table/Plot above, no emissions exceed the Part 27 radiated spurious emissions limit when converted to dBuV/m. For final spurious emissions measurements to FCC Part 27, see antenna port conducted emissions in applicable test report.

**Figure 39: Plot of RE at 1m from 18 to 26.5 GHz (MC Config 2 – Mid channel)**

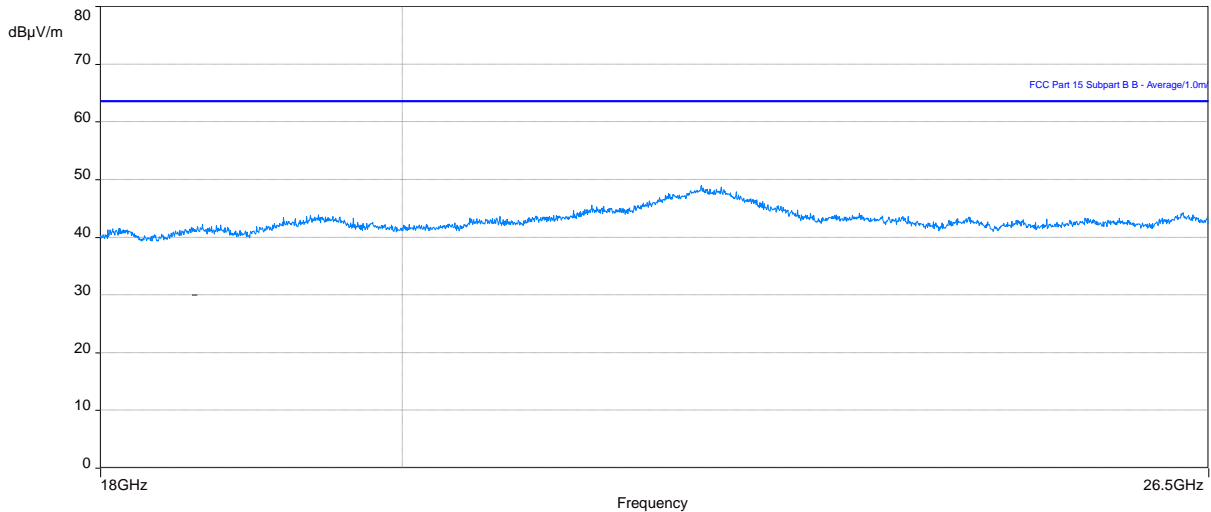

**Note 1:** In the plot above No Emissions exceeds the FCC Part 15 limit.

**Note 2:** In the plot above, no emissions exceed the Part 27 radiated spurious emissions limit when converted to dBuV/m. For final spurious emissions measurements to FCC Part 27, see antenna port conducted emissions in applicable test report.

**Figure 40: Plot of RE at 1m from 26.5 to 40 GHz (MC Config 2 – Mid channel)**

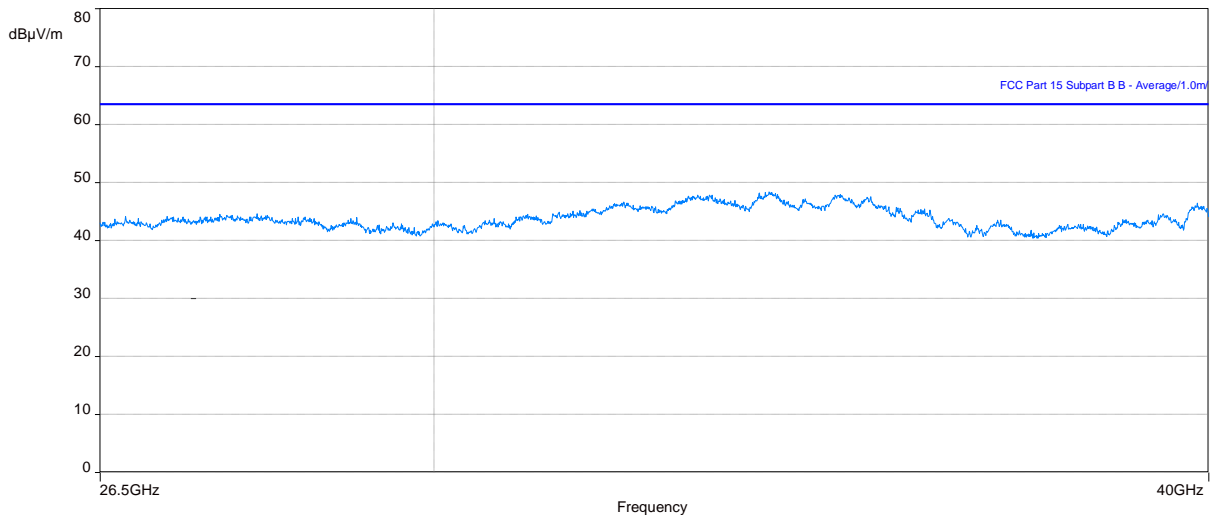

**Note 1:** In the plot above No Emissions exceeds the FCC Part 15 limit.

**Note 2:** In the plot above, no emissions exceed the Part 27 radiated spurious emissions limit when converted to dBuV/m. For final spurious emissions measurements to FCC Part 27, see antenna port conducted emissions in applicable test report.



### 3.2.11 Radiated Emissions test setup pictures

Figure 41: Setup for RE tests at 30 MHz to 1 GHz (Configuration 1)



**Figure 42: Setup for RE tests for above 1 GHz (Configuration 1)**

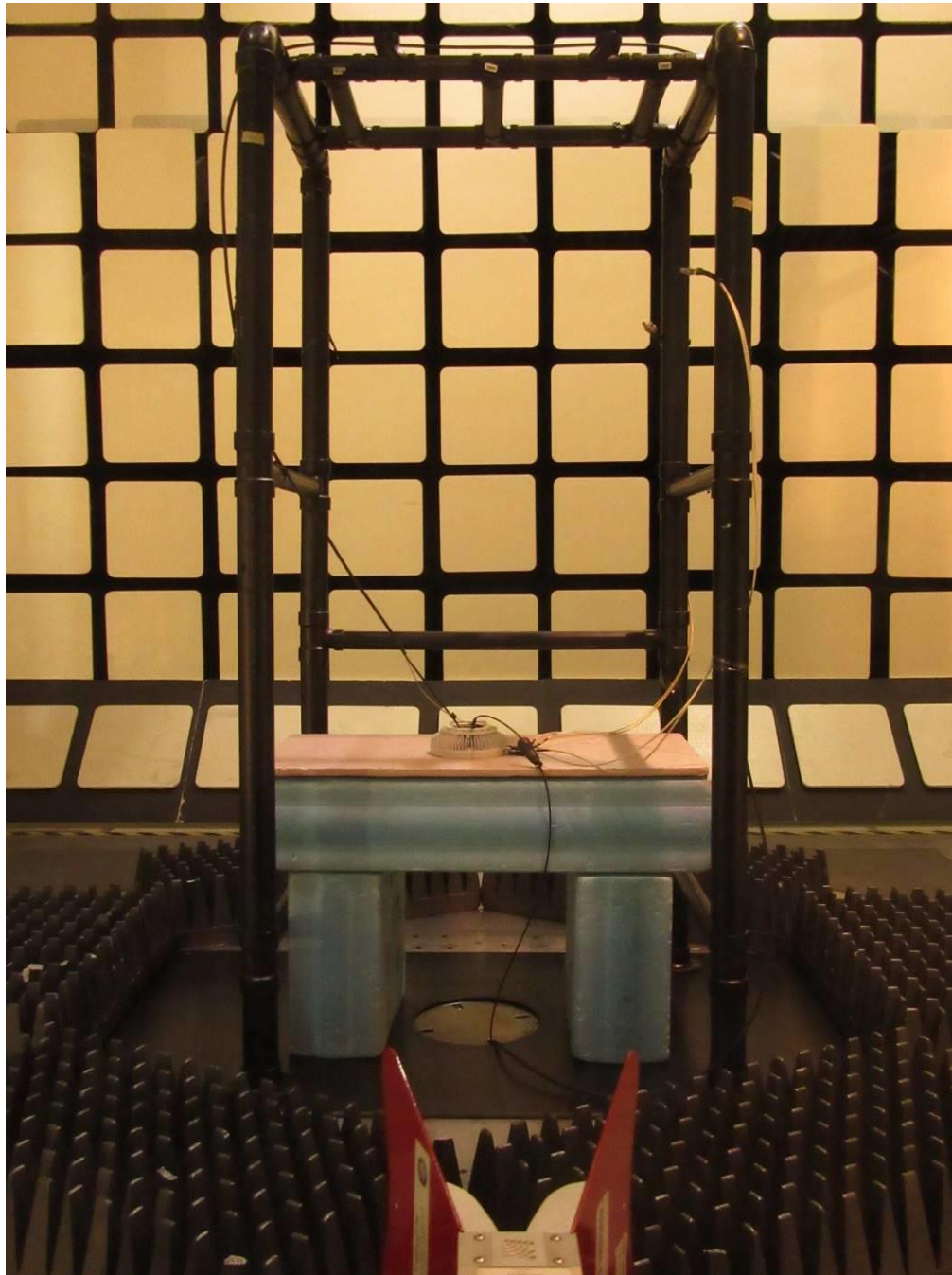

**Figure 43: Setup for RE tests at 30 MHz to 1 GHz (Configuration 2)**

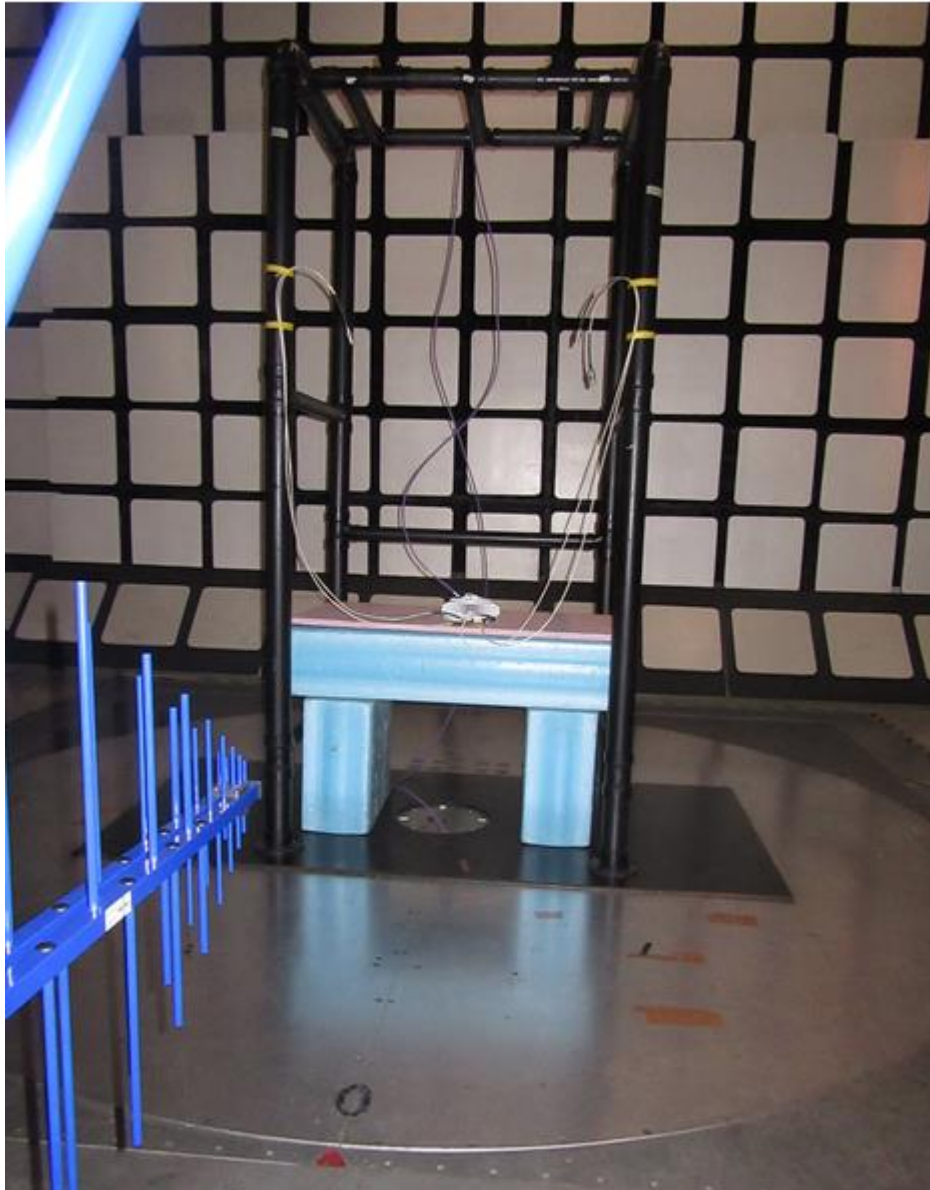

**Figure 44: Setup for RE tests for above 1 GHz (Configuration 2)**

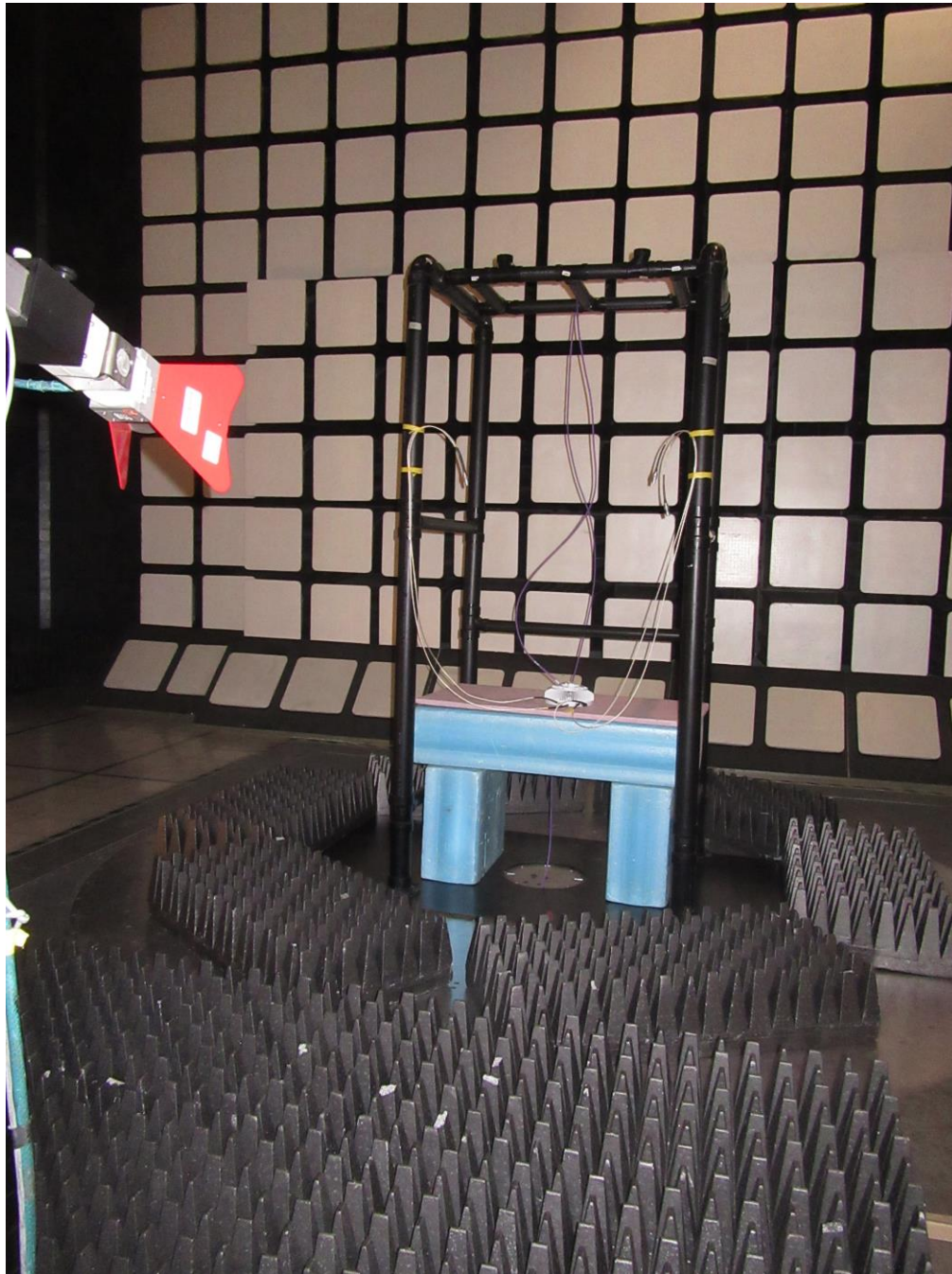



### 3.2.12 Test equipment

The equipment used for E-field RE testing was as follows.

**Table 59: Test equipment used for RE (Configuration 1)**

Description	Make	Model number	Asset ID	Calibr. date	Calibr. due
EMC Automation Software	Nexio V3.18	BAT-EMC	F0163649	Not required	Not required
Bilog Antenna	TESEQ	CBL 6111D	SSG013965	2021-05-04	2022-05-04
Horn Antenna 3MCH 00003	ETS	3117	LAVE04211	2021-03-30	2022-03-30
Horn Antenna (18 - 26.5 GHz)	Emco	3160-09	SSG012292	2019-08-26	2021-11-26
Horn Antenna (26.5 - 40 GHz)	Emco	3160-10	SSG012294	2019-08-26	2021-11-26
Spectrum analyzer	Rohde & Schwarz	ESU-40	LAVE04092	2020-07-17	2022-07-17
Coaxial Cable	Huber & Suhner	106A	SSG013841	2021-01-05	2022-01-05
Coaxial Cable	Huber & Suhner	106A	SSG012711	2021-01-05	2022-01-05
Coaxial Cable	Huber & Suhner	104PEA	SSG012041	2021-01-05	2022-01-05
Coaxial Cable	Huber & Suhner	ST18/Nm/Nm/36	SSG012785	2021-01-06	2022-01-06
Coaxial Cable	Micro-Coax	UFA 210B-1-1500-504504	SSG012376	2021-01-06	2022-01-06
Coaxial Cable	Huber & Suhner	101 PEA, Sucoflex	SSG012290	2020-11-04	2022-11-04
RF Amplifier	Hewlett Packard	8447D	SSG013045	2021-01-29	2022-01-29
Pre-Amplifier	BNR	LNA	SSG012594	2021-04-12	2022-04-12
Power Supply	Lambda	LPD-421A-FM	SSG013085	not required	not required
Attenuator	Narda	N/A	SSG013687	2021-01-06	2022-01-06



**Table 60: Test equipment used for RE (Configuration 2)**

Description	Make	Model number	Asset ID	Calibr. date	Calibr. due
EMC Automation Software	Nexio V3.18	BAT-EMC	F0163649	Not required	Not required
Bilog Antenna	TESEQ	CBL 6111D	SSG013965	2021-05-04	2022-05-04
Horn Antenna 3MCH 00003	ETS	3117	LAVE04211	2021-03-30	2022-03-30
Ant 3MCH 00004	ETS	3116	LAVE04210	2021-11-05	2023-11-05
EMI Receiver	Rohde & Schwarz	ESU26	SSG013729	2021-03-31	2022-03-31
Spectrum analyzer	Rohde & Schwarz	ESU-40	LAVE04092	2020-07-17	2022-07-17
Coaxial Cable	Huber & Suhner	106A	SSG012455	2021-01-05	2022-04-05
Coaxial Cable	Huber & Suhner	106A	SSG012711	2021-01-05	2022-04-05
Coaxial Cable	Huber & Suhner	104PEA	SSG012041	2021-01-05	2022-04-05
Coaxial Cable	Huber & Suhner	ST18/Nm/Nm/36	SSG012785	2021-01-06	2022-04-06
Coaxial Cable	Micro-Coax	UFA 210B-1-1500-504504	SSG012376	2021-01-06	2022-04-06
Coaxial Cable	Huber & Suhner	101 PEA, Sucoflex	SSG012290	2020-11-04	2022-11-04
RF Amplifier	Hewlett Packard	8447D	SSG013045	2021-01-29	2022-01-29
Pre-Amplifier	BNR	LNA	SSG012594	2021-04-12	2022-04-12
Pre-amp 18-40G	microComp Nordie	MCN-40-18004000-3.3-10P	SSG014000	2021-11-04	2023-11-04
Power Supply	Hewlett Packard	6216A	SSG013063	not required	not required

### 3.2.13 Test conclusion

The DOT 4459 B77D (KRY 901 515/1) and DOT 4469 B77D (KRY 901 515/2) have passed the E-field Radiated Emission (RE) tests with respect to the Class B limits of FCC Part 15 Subpart B and FCC Part 27 section 27.53(l)(1).

---

## 4. References

The documents, regulations, and standards that are referenced throughout this test report are listed alphabetically as follows.

1. ANSI C63.2-2009, American National Standards Institute for Electromagnetic Noise and Field Strength Instrumentation, 10 Hz to 40 GHz – Specifications.
2. ANSI C63.4-2014, American National Standards Institute for Methods of Measurement of Radio-Noise Emission from Low-Voltage Electrical and Electronic Equipment in the Range of 9 kHz to 40 GHz.
3. CISPR 16 Publications (all parts and sections), Specification for Radio Disturbance and Immunity Measuring Apparatus and Methods - Part 1: Radio Disturbance and Immunity Measuring Apparatus.
4. CISPR 22 (2008, +IS 1, + IS 2, + IS 3: 2012), Information technology equipment - Radio disturbance characteristics - Limits and methods of measurement.
5. FCC Rules for Radio Frequency Devices, Title 47 of the Code of Federal Regulations, Part 2, U.S. Federal Communications Commission.
6. FCC Rules for Radio Frequency Devices, Title 47 of the Code of Federal Regulations, Part 15 Radio Frequency Devices, U.S. Federal Communications Commission.
7. FCC Rules for Radio Frequency Devices, Title 47 of the Code of Federal Regulations, Part 27 Miscellaneous Wireless Communications Services, U.S. Federal Communications Commission.

## 4.1 Appendix A: Abbreviations

The abbreviations of terms used in this document are as follows.

Term	Definition
A	6 dB Coaxial Attenuator (Conducted Immunity)
AAN	Asymmetric Artificial Network (ISN)
AE	Auxiliary equipment
AFC	Ambient Free Chamber
AM	Amplitude modulation
ANSI	American National Standards Institute
AVG	Average detector
BiLog	Biconical Log-Periodic Hybrid antenna (a registered trademark of Schaffner-Chase EMC Limited, 1993)
CC	RF Current Clamp
CCC	Capacitive Coupling Clamp
CDN	Coupling-decoupling Network
CE	Conducted Emissions
CI	Conducted Immunity
CISPR	Comité International Spécial Perturbation Radioélectrique (International Special Committee on Radio Interference)
CP	RF Current Probe
CSA	Canadian Standards Association
DI	Direct Injection
DN/P	Decoupling / Protection Network
EFT	Electrical Fast Transient
EFT/B	Electrical Fast Transient / Burst Generator
EMC	Electromagnetic Compatibility
EMI	Electromagnetic Interference
ESD	Electrostatic Discharge
ETSI	European Telecommunications Standards Institute
EUT	equipment under test
GND	Ground
HCP	Horizontal Coupling Plane
HME	Harmonics Measurement Equipment
HV	High Voltage
HVP	High Voltage Probe



Term	Definition
h/w	hardware
IC	Industry Canada
ICES	Canadian Specification: ICES-003, Issue 3, "Spectrum Management: Interference-causing equipment standard (Digital Apparatus)
IEC	International Electro Technical Association
ISN	Impedance Stabilization Network
LISN	Line Impedance Stabilization Network
ms	millisecond, unless otherwise specified
NA, na	not applicable
PA	Broadband Power Amplifier
PK	Peak Detector
PS	Power Supply
QP	Quasi-peak Detector
QPA	Quasi-peak Adapter (for the Spectrum Analyzer)
R	100-ohm Injection Resistor (Conducted Immunity)
RBW	Resolution Bandwidth
RE	Radiated Emissions
RF	Radio-Frequency
RI	Radiated Immunity
RMS	Root-mean-square
s/w	software
SA	Spectrum Analyzer, the CISPR 16, ANSI C63.2 Compliant EMI meter
SG	RF Signal Generator
SGen	Surge Generator
STP	Shielded Twisted Pair
T	50-ohm Coaxial Termination (Conducted Emissions / Immunity)
TL	Transient Limiter
UFA	Uniform field Area
VBW	Video Bandwidth
VCP	Vertical Coupling Plane
VDI	Voltage Dips and Short Interruptions
VFF	Voltage Fluctuations and Flicker



**TÜV SÜD Canada Inc**

**Radiated Emissions Test Report**

**End of Document**