



**Radiated Emissions Test Report
for
DOT 4459 B41K (KRY 901 502/1) and DOT 4469 B41K (KRY 901 502/2)
(with NR and LTE)**

**Tested to: FCC Part 15 Subpart B
FCC Part 27 (Section - 27.53(m)(2))**

Test Result summary

FCC/ ICES Section	Description	Specification/Method	Pass or Fail	Results in section
15.109 / 6.2	Radiated Emissions (RE)	FCC Part 15 / ANSI C63.4	Pass	3.2
15.107 / 6.1	Conducted Emissions (CE) for AC Power	FCC Part 15 / ANSI C63.4	NA	NA
27.53(m)(2)	Transmitter Spurious Emissions (RE)	FCC Part 27 / ANSI C63.26	Pass	3.2

Document number: 7169010316-TR-EMC-01-01-F15

Release date: 22 October 2021

Prepared for: Ericsson Canada



About this document

This document is written and distributed by TÜV SÜD Canada Inc. Whenever TÜV SÜD is mentioned in this document it shall be taken as referring to TÜV SÜD Canada Inc.

This test report does not imply product endorsement by any government, accreditation agency, or TÜV SÜD Canada Inc. Opinions or interpretations expressed in this report, if any, are outside the scope of the accreditations of TÜV SÜD Canada Inc. Any opinions expressed do not necessarily reflect the opinions of TÜV SÜD Canada Inc, unless otherwise stated.

Throughout this document:

- text in **blue** font is a clickable link
- text in *italics* is provided as-is from the customer

The release control record, document approvals, and laboratory Accreditations are as follows.

Release control record

This document is based on document template KG000347-TR-EMC-08-03.

Issue	Reason for change	Date released
01	initial release	22 October 2021

Approvals

Function	Name	Job title	Signature
Technical Reviewer	Scott Drysdale	Canada Wireless Manager	
Author	Kasi Sivaratnam	EMC Test Engineer	

Accreditations

The test facilities of TÜV SÜD Canada Inc are accredited by the American Association for Laboratory Accreditation (A2LA) to ISO/IEC 17025:2017 in accordance with the scope of accreditation outlined at the website portal.a2la.org/scopepdf/2955-19.pdf.

 A2LA Cert. No. 2955.19	DISCLAIMER AND COPYRIGHT This non-binding report has been prepared by TÜV SÜD Canada with all reasonable skill and care. The document is confidential to the potential Client and TÜV SÜD Canada. No part of this document may be reproduced without the prior written approval of TÜV SÜD Canada. © TÜV SÜD.
	ACCREDITATION Our A2LA Accreditation does not cover opinions and interpretations and any expressed are outside the scope of our A2LA Accreditation.

The Canadian lab registration number associated with the TÜV SÜD test facilities is 24015.

Test lab information

Lab name	TÜV SÜD Canada Inc
Company name	TÜV SÜD Canada Inc
Mailing or shipping address	1280 Teron Road, Ottawa, Ontario, K2K 2C1, Canada
Primary technical contact	Stephen Tippet
Title	Lab Manager
Phone	613-668-5149

Customer information

Company name	Ericsson Canada
Mailing address	349 Terry Fox Drive, Ottawa, On, K2K 2V6, Canada
Primary contact	Denis Lalonde
Title	Team Leader RA Verification
Phone	613-790-2901
E-mail	Denis.lalonde@ericsson.com

Table of contents

About this document.....	2
1. Executive summary.....	9
1.1 Compliance summary	10
2. Details of the equipment under test.....	11
2.1 Assessed hardware	11
2.2 Product overview	11
2.3 Product port definition and EUT cable information	14
2.4 Configurations of the EUT.....	15
2.4.1 Configuration 1: Dot 4469 B41K with IRU 1648	15
2.4.1.1 Radiated Emissions Single RAT/Single Carrier Configurations (LTE).....	16
2.4.1.2 Radiated Emissions Single RAT / Single Carrier Configurations (NR)	17
2.4.1.3 Radiated Emissions Single RAT / Multi Carriers Configurations (LTE)	18
2.4.1.4 Radiated Emissions Multi RAT/Multi Carrier Configuration MR (LTE + NR).....	19
2.4.2 Configuration 2: Dot 4469 B41K with IRU 1649	20
2.4.2.1 Radiated Emissions Multi RAT/Multi Carrier Configuration MR (LTE + NR) – Cfg 2	20
2.5 Modifications of the EUT during testing	21
2.6 Inventory of the EUT and support equipments.....	21
3. Detailed test results of Emissions.....	22
3.1 Measurement instrumentation.....	22
3.2 Radiated Emissions, E-field.....	23
3.2.1 Test specification and limits	23
3.2.2 Test procedure.....	23
3.2.3 Calculation of the compliance margin	25
3.2.4 Measurement uncertainties	25
3.2.5 Test results of RE – (Single RAT/Single Carrier (LTE) – Bottom channel).....	26
3.2.6 Test results of RE – (Single RAT/Single Carrier (LTE) – Middle channel)	31
3.2.7 Test results of RE – (Single RAT/Single Carrier (LTE) – Top channel)	37
3.2.8 Test results of RE – (Single RAT/Single Carrier (NR) – Middle channel)	42
3.2.9 Test results of RE – (Single RAT / Multi Carrier (LTE) – Mid channel)	48
3.2.10 Test results of RE – (Multi RAT / Multi Carrier – Mid channel) – Cfg 1	53
3.2.11 Test results of RE – (Multi RAT / Multi Carrier – Mid channel) – Cfg 2.....	59
3.2.12 Radiated Emissions test setup pictures	65
3.2.13 Test equipment.....	69
3.2.14 Test conclusion	69
4. References	70
4.1 Appendix A: Abbreviations	71



List of figures

Figure 1: The EUT with four Internal RF ports, Dot 4459 B41K	11
Figure 2: The EUT with four external RF ports, Dot 4469 B41K.....	12
Figure 3: Test configuration 1 for Emission tests.....	15
Figure 4: Carrier detail – Single RAT /Single carrier (LTE).....	16
Figure 5: Tested carrier detail, Single RAT /Single carrier (LTE) – SC 1	16
Figure 6: Carrier detail – Single RAT / Single carrier (NR).....	17
Figure 7: Carrier detail – Single RAT / Multi carrier (LTE)	18
Figure 8: Carrier detail – MultiCarrier / Multi RAT Configuration	19
Figure 9: Test configuration 2 for Emission tests.....	20
Figure 10: Carrier detail – MultiCarrier / Multi RAT Configuration	20
Figure 11: Setup of Radiated Emissions.....	24
Figure 12: Plot of RE at 3 m – 30 to1000 MHz (LTE – Bottom channel)	27
Figure 13: Plot of RE at 3m from 1 to 3 GHz (LTE – Bottom channel)	28
Figure 14: Plot of RE at 3m from 3 to 10 GHz (LTE – Bottom channel)	29
Figure 15: Plot of RE at 3m from 10 to 18 GHz (LTE – Bottom channel)	30
Figure 16: Plot of RE at 3 m – 30 to1000 MHz (LTE – Middle channel).....	32
Figure 17: Plot of RE at 3m from 1 to 3 GHz (LTE – Middle channel).....	33
Figure 18: Plot of RE at 3m from 3 to 10 GHz (LTE – Middle channel).....	34
Figure 19: Plot of RE at 3m from 10 to 18 GHz (LTE – Middle channel).....	35
Figure 20: Plot of RE at 1m from 18 to 26.5 GHz (LTE – Middle channel).....	36
Figure 21: Plot of RE at 1m from 26.5 to 40 GHz (LTE – Middle channel).....	36
Figure 22: Plot of RE at 3 m – 30 to1000 MHz (LTE – Top channel).....	38
Figure 23: Plot of RE at 3m from 1 to 3 GHz (LTE – Top channel).....	39
Figure 24: Plot of RE at 3m from 3 to 10 GHz (LTE – Top channel).....	40
Figure 25: Plot of RE at 3m from 10 to 18 GHz (LTE – Top channel).....	41
Figure 26: Plot of RE at 3 m – 30 to1000 MHz (NR – Middle channel).....	43
Figure 27: Plot of RE at 3m from 1 to 3 GHz (NR – Middle channel)	44
Figure 28: Plot of RE at 3m from 3 to 10 GHz (NR – Middle channel)	45
Figure 29: Plot of RE at 3m from 10 to 18 GHz (NR – Middle channel)	46
Figure 30: Plot of RE at 1m from 18 to 26.5 GHz (NR – Middle channel)	47
Figure 31: Plot of RE at 1m from 26.5 to 40 GHz (NR – Middle channel)	47
Figure 32: Plot of RE at 3 m – 30 to1000 MHz (MC LTE – Mid channel)	49
Figure 33: Plot of RE at 3m from 1 to 3 GHz (MC LTE – Mid channel)	50
Figure 34: Plot of RE at 3m from 3 to 10 GHz (MC LTE – Mid channel)	51
Figure 35: Plot of RE at 3m from 10 to 18 GHz (MC LTE – Mid channel)	52
Figure 36: Plot of RE at 3 m from 30 to 1000 MHz (MR (LTE + NR) – Mid channel)	54



Figure 37: Plot of RE at 3m from 1 to 3 GHz (MR (LTE + NR) – Mid channel) 55
 Figure 38: Plot of RE at 3m from 3 to 10 GHz (MR (LTE + NR) – Mid channel) 56
 Figure 39: Plot of RE at 3m from 10 to 18 GHz (MR (LTE + NR) – Mid channel) 57
 Figure 40: Plot of RE at 1m from 18 to 26.5 GHz (MR (LTE + NR) – Mid channel) 58
 Figure 41: Plot of RE at 1m from 26.5 to 40 GHz (MR (LTE + NR) – Mid channel) 58
 Figure 42: Plot of RE at 3 m from 30 to 1000 MHz (MR (LTE + NR) – Mid ch) – Cfg 2 60
 Figure 43: Plot of RE at 3m from 1 to 3 GHz (MR (LTE + NR) – Mid ch) – Cfg 2 61
 Figure 44: Plot of RE at 3m from 3 to 10 GHz (MR (LTE + NR) – Mid ch) – Cfg 2 62
 Figure 45: Plot of RE at 3m from 10 to 18 GHz (MR (LTE + NR) – Mid ch) – Cfg 2 63
 Figure 46: Plot of RE at 1m from 18 to 26.5 GHz (MR (LTE + NR) – Mid ch) – Cfg 2 64
 Figure 47: Plot of RE at 1m from 26.5 to 40 GHz (MR (LTE + NR) – Mid ch) – Cfg 2 64
 Figure 48: Setup for RE tests - Close up (Configuration 1) 65
 Figure 49: Setup for RE tests - Close up (Configuration 2) 66
 Figure 50: Setup for RE tests at 30 MHz to 1 GHz – Configuration 1 67
 Figure 51: Setup for RE tests for above 1 GHz – Configuration 2 68

List of tables

Table 1: Summary of test results for the USA; FCC Part 15 subpart B 10
 Table 2: Summary of test results for the USA; FCC Part 27 subpart C 10
 Table 3: Assessed hardware 11
 Table 4: EUT info 13
 Table 5: System port definition Dot 4469 B41K 14
 Table 6: Inventory of the EUT – Configuration 1 21
 Table 7: Inventory of the EUT – Configuration 2 21
 Table 8: RE test requirements 23
 Table 9: RE limits at 10 m for Class B of FCC 23
 Table 10: Emission limits for FCC Part 27 23
 Table 11: RE test results from 30 to 1000 MHz for FCC Part 15 (LTE – Bottom channel) 27
 Table 12: RE test results from 30 to 1000 MHz for FCC Part 27 (LTE – Bottom channel) 27
 Table 13: RE test results from 1 to 3 GHz for FCC Part 15 (LTE – Bottom channel) 28
 Table 14: RE test results from 1 to 3 GHz for FCC Part 27 (LTE – Bottom channel) 28
 Table 15: RE test results from 3 to 10 GHz for FCC Part 15 (LTE – Bottom channel) 29
 Table 16: RE test results from 3 to 10 GHz for FCC Part 27 (LTE – Bottom channel) 29
 Table 17: RE test results from 10 to 18 GHz for FCC Part 15 (LTE – Bottom channel) 30
 Table 18: RE test results from 10 to 18 GHz (LTE – Bottom channel) 30
 Table 19: RE test results from 30 to 1000 MHz for FCC Part 15 (LTE – Middle channel) 32
 Table 20: RE test results from 30 to 1000 MHz for FCC Part 27 (LTE – Middle channel) 32



Table 21: RE test results from 1 to 3 GHz for FCC Part 15 (LTE – Middle channel)	33
Table 22: RE test results from 1 to 3 GHz for FCC Part 27 (LTE – Middle channel)	33
Table 23: RE test results from 3 to 10 GHz for FCC Part 15 (LTE – Middle channel)	34
Table 24: RE test results from 3 to 10 GHz for FCC Part 27 (LTE – Middle channel)	34
Table 25: RE test results from 10 to 18 GHz for FCC Part 15 (LTE – Middle channel)	35
Table 26: RE test results from 10 to 18 GHz (LTE – Middle channel).....	35
Table 27: RE test results from 30 to 1000 MHz for FCC Part 15 (LTE – Top channel).....	38
Table 28: RE test results from 30 to 1000 MHz for FCC Part 27 (LTE – Top channel).....	38
Table 29: RE test results from 1 to 3 GHz for FCC Part 15 (LTE – Top channel)	39
Table 30: RE test results from 1 to 3 GHz for FCC Part 27 (LTE – Top channel)	39
Table 31: RE test results from 3 to 10 GHz for FCC Part 15 (LTE – Top channel)	40
Table 32: RE test results from 3 to 10 GHz for FCC Part 27 (LTE – Top channel)	40
Table 33: RE test results from 10 to 18 GHz for FCC Part 15 (LTE – Top channel)	41
Table 34: RE test results from 10 to 18 GHz (LTE – Top channel).....	41
Table 35: RE test results from 30 to 1000 MHz for FCC Part 15 (NR – Middle channel)	43
Table 36: RE test results from 30 to 1000 MHz for FCC Part 27 (NR – Middle channel)	43
Table 37: RE test results from 1 to 3 GHz for FCC Part 15 (NR – Middle channel).....	44
Table 38: RE test results from 1 to 3 GHz for FCC Part 27 (NR – Middle channel).....	44
Table 39: RE test results from 3 to 10 GHz for FCC Part 15 (NR – Middle channel).....	45
Table 40: RE test results from 3 to 10 GHz for FCC Part 27 (NR – Middle channel).....	45
Table 41: RE test results from 10 to 18 GHz for FCC Part 15 (NR – Middle channel).....	46
Table 42: RE test results from 10 to 18 GHz (NR – Middle channel).....	46
Table 43: RE test results from 30 to 1000 MHz for FCC Part 15 (MC LTE – Mid channel)	49
Table 44: RE test results from 30 to 1000 MHz for FCC Part 27 (MC LTE – Mid channel)	49
Table 45: RE test results from 1 to 3 GHz for FCC Part 15 (MC LTE – Mid channel).....	50
Table 46: RE test results from 1 to 3 GHz for FCC Part 27 (MC LTE – Mid channel).....	50
Table 47: RE test results from 3 to 10 GHz for FCC Part 15 (MC LTE – Mid channel).....	51
Table 48: RE test results from 3 to 10 GHz for FCC Part 27 (MC LTE – Mid channel).....	51
Table 49: RE test results from 10 to 18 GHz for FCC Part 15 (MC LTE – Mid channel).....	52
Table 50: RE test results from 10 to 18 GHz (MC LTE – Mid channel)	52
Table 51: RE test results from 30 to 1000 MHz for FCC Part 15 (MR (LTE + NR) – Mid channel).....	54
Table 52: RE test results from 30 to 1000 MHz for FCC Part 27 (MR (LTE + NR) – Mid channel).....	54
Table 53: RE test results from 1 to 3 GHz for FCC Part 15 (MR (LTE + NR) – Mid channel)	55
Table 54: RE test results from 1 to 3 GHz for FCC Part 27 (MR (LTE + NR) – Mid channel)	55
Table 55: RE test results from 3 to 10 GHz for FCC Part 15 (MR (LTE + NR) – Mid channel)	56
Table 56: RE test results from 3 to 10 GHz for FCC Part 27 (MR (LTE + NR) – Mid channel)	56
Table 57: RE test results from 10 to 18 GHz for FCC Part 15 (MR (LTE + NR) – Mid channel)	57



Table 58: RE test results from 10 to 18 GHz (MR (LTE + NR) – Mid channel).....	57
Table 59: RE test results from 30 to 1000 MHz for FCC Part 15 (MR (LTE + NR) – Mid ch)- Cfg 2...	60
Table 60: RE test results from 30 to 1000 MHz for FCC Part 27 (MR (LTE + NR) – Mid ch) – Cfg 2 .	60
Table 61: RE test results from 1 to 3 GHz for FCC Part 15 (MR (LTE + NR) – Mid ch) – Cfg 2.....	61
Table 62: RE test results from 1 to 3 GHz for FCC Part 27 (MR (LTE + NR) – Mid ch) – Cfg 2.....	61
Table 63: RE test results from 3 to 10 GHz for FCC Part 15 (MR (LTE + NR) – Mid ch) – Cfg 2.....	62
Table 64: RE test results from 3 to 10 GHz for FCC Part 27 (MR (LTE + NR) – Mid ch) – Cfg 2.....	62
Table 65: RE test results from 10 to 18 GHz for FCC Part 15 (MR (LTE + NR) – Mid ch) – Cfg 2.....	63
Table 66: RE test results from 10 to 18 GHz (MR (LTE + NR) – Mid ch) – Cfg 2.....	63
Table 67: Test equipment used for RE	69

1. Executive summary

This document reports the Electromagnetic Compatibility (EMC) testing performed on the product called DOT 4459 B41K (KRY 901 502/1) and DOT 4469 B41K (KRY 901 502/2) for Ericsson Canada per project number 7169010316. The objective of the test activities is to evaluate compliance of the product to following EMC regulatory standards.

The DOT 4459 B41K (KRY 901 502/1) and DOT 4469 B41K (KRY 901 502/2) is verified to comply with the Class B Emissions requirements of these standards:

- FCC Part 15 Subpart B [5] (Class B)
- FCC Part 27 [7] (Digital Base Stations, Section - 27.53(m)(2))

Information about the test result summary and, the equipment under test (EUT) is in the sections:

- [Compliance summary](#)
- [Details of the equipment under test](#)
- [Detailed test results of Emissions](#)



1.1 Compliance summary

The test results in this report apply only to the tested components that are identified in the section [Assessed hardware](#).

The following table summarizes the EMC test results for the test cases performed on the DOT 4459 B41K (KRY 901 502/1) and DOT 4469 B41K (KRY 901 502/2)

Table 1: Summary of test results for the USA; FCC Part 15 subpart B

FCC Section	Description	Specification/Method	Pass or Fail	Results in section
15.109	Radiated Emissions (RE)	FCC Part 15/ANSI C63.4	Pass	3.2
15.107	Conducted Emissions (CE) for AC Power	FCC Part 15/ANSI C63.4	NA	NA
Table Notes				
1. Not Applicable; EUT operates from POE (56 VDC).				

Table 2: Summary of test results for the USA; FCC Part 27 subpart C

FCC Section	Description	Specification/Method	Pass or Fail	Results in section
27.53(m)(2)	Transmitter Spurious Emissions (RE) – Digital Base Stations	FCC Part 27/ ANSI C63.26	Pass	3.2

2. Details of the equipment under test

This section describes the equipment under test (EUT).

2.1 Assessed hardware

The following table indicates the hardware components that were assessed during this test program.

Table 3: Assessed hardware

Hardware component ¹	Part number
DOT 4459 B41K, with internal Antenna port	KRY 901 502/1
DOT 4469 B41K, with External Antenna port	KRY 901 502/2
Table Notes	
1. The 2 units above use the same pcb and hardware. The only difference between the units is the presence of the internal/external antennas. There fore all EMC tests were done only on the external port variant.	

2.2 Product overview

The product trade name is DOT 4459 B41K (KRY 901 502/1) and DOT 4469 B41K (KRY 901 502/2). DOT 4459 B41K (KRY 901 502/1) and DOT 4469 B41K (KRY 901 502/2) are indoor wireless telecommunication products; transmit and receive the cellular signals for 5G wireless systems. And operates from POE (56 VDC).

Figure 1: The EUT with four Internal RF ports, Dot 4459 B41K

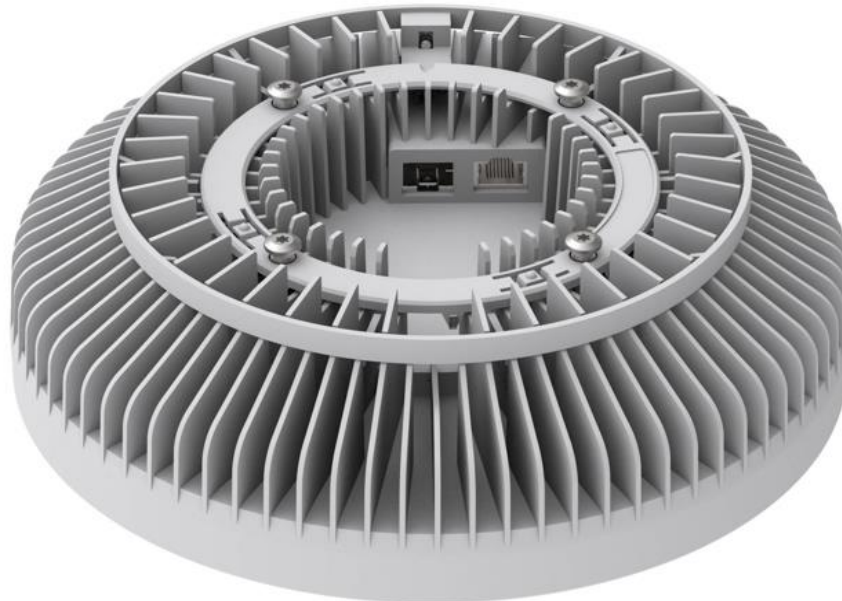
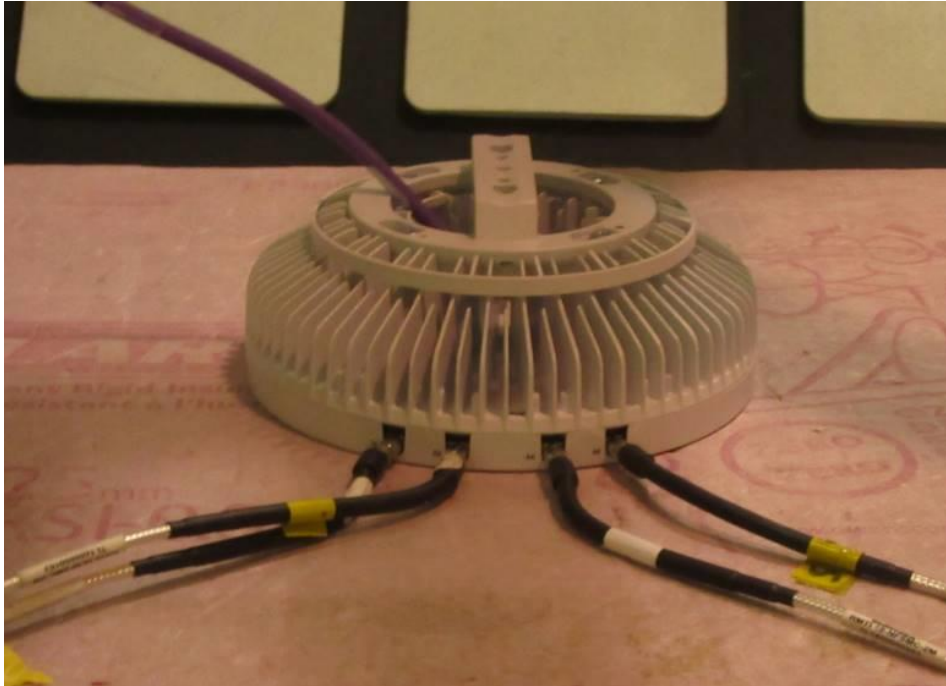

Figure 2: The EUT with four external RF ports, Dot 4469 B41K



The 2 units above use the same pcb and hardware. The only difference between the units is the presence of the internal/external antennas. There fore all EMC tests were done only on the external port variant; configurations of the DOT 4469 B41K (KRY 901 502/2) that was tested is shown in the section [Configurations of the EUT](#). The EUT was tested in a tabletop setting.



Table 4: EUT info

Product data	DOT 4469 B41K
Product	Single-band Dot, 4T4R
P/N	KRY 901 502/2
HW Rev	R1C
Nominal Voltage	56Vdc (CAT6A POE) / 54Vdc External AC/DC Converter
Operating Temperature	+5°C to +40°C
Bands	B41K
Antennas	4T4R B41K
Output Power per band	400mW (26dBm) (B41K, TDD) / branch
Maximum IBW	B41K: 160MHz
Single RAT (SRO) support	B41K: LTE-TDD, NR-TDD
Mixed RAT (MRO) support	B41K: LTE + NR
Channel Bandwidth B41K :	LTE-TDD: 5, 10, 15, 20MHz
	NR: 20, 40, 50, 60, 70, 80, 90, 100MHz
Nominal O/P per TDD Antenna Port:	Single Carrier: 1 x 400mW (26dBm)
	Multi-Carrier: 2 x 200mW (23dBm)
	Multi-Carrier: 3 x 133.3mW (21.49dBm)
	Multi-Carrier: 4 x 100mW (20dBm)
	Multi-Carrier: 5 x 80mW (19dBm)
	Multi-Carrier: 6 x 66.7mW (18.23dBm)
Max number carriers per Port	B41K: Max 6 Single RAT carriers (1648/9 IRU)
	B41K: Max 5 NR Mixed Mode carriers (1648/9 IRU)
CPRI line rate	10.1 Gbps
Compatible IRU	IRU 1648/1649
Modulation:	LTE: QPSK, 16QAM, 64QAM, 256 QAM
dRDI Interface:	Digital, dRDI compression rev = ATC
SFP Interface:	Optical SFP+, 10.1 Gbps
Mounting	ceiling or wall



2.3 Product port definition and EUT cable information

Table 5 identifies all the cables and ports on the EUT. The Environment of the cables is indoor.

Table 5: System port definition Dot 4469 B41K

Port Name	Port Description	Port Type	Interface Detail	Plug-Cable Type
RJ45	Digital RDI / DC Power Input	Telecom / DC Power	ethernet	RJ-45, CAT6A
SFP+	Digital RDI, Optical SFP+	Optical SFP	10/25 Gbs, optical fiber, LC	SFP+, RDH 102 65/2,
3A, 3B, 4A,4B	RF to antenna B41K	Antenna	RF	SMA, Coax >3m

2.4 Configurations of the EUT

Two configurations were used for radiated Emissions test. All EUT configurations were defined by customer.

- Configuration 1: Dot 4469 B41K with IRU 1648
- Configuration 2: Dot 4469 B41K with IRU 1649

2.4.1 Configuration 1: Dot 4469 B41K with IRU 1648

Figure 3 shows the configuration 1 of the EUT for Radiated Emissions test.

Figure 3: Test configuration 1 for Emission tests

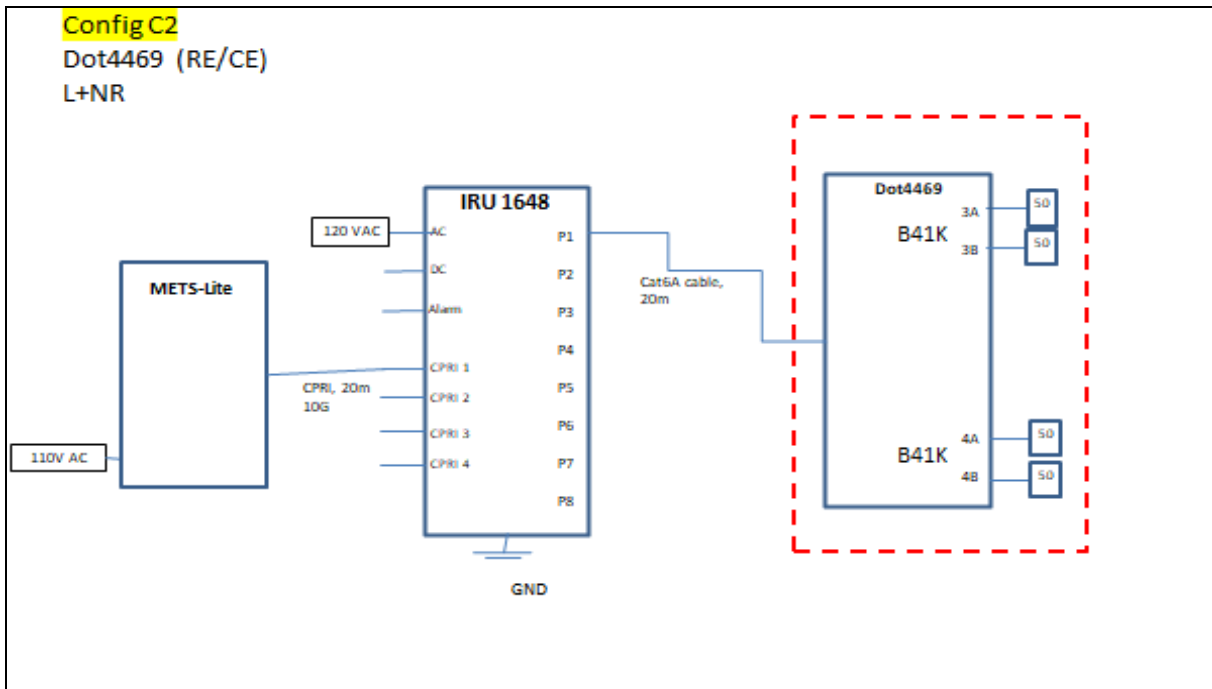

Following RAT/carrier configurations were tested during this Radiated Emissions evaluations for configuration 1.

- Radiated Emissions Single RAT/Single Carrier Configurations (LTE)
- Radiated Emissions Single RAT / Single Carrier Configurations (NR)
- Radiated Emissions Single RAT / Multi Carriers Configurations (LTE)
- Radiated Emissions Multi RAT/Multi Carrier Configuration MR (LTE + NR)

2.4.1.1 Radiated Emissions Single RAT/Single Carrier Configurations (LTE)

Figure 4: Carrier detail – Single RAT /Single carrier (LTE)

Single RAT/Single Carrier - LTE setups for Emissions	
B41K PORT 3A,3B,4A,4B	
BS type 1-C, CS16 (NR, LTE) TC21	
SR LTE Config SC 1 Carrier setups for Emissions	
Carrier	Middle channel
1	B41K: LTE, 5MHz, 2595MHz
SR LTE Config SC 2 Carrier setups for Emissions	
Carrier	Middle channel
1	B41K: LTE, 10MHz, 2595MHz
SR LTE Config SC 3 Carrier setups for Emissions	
Carrier	Middle channel
1	B41K: LTE, 15MHz, 2595MHz
SR LTE Config SC 4 Carrier setups for Emissions	
Carrier	Middle channel
1	B41K: LTE, 20MHz, 2595MHz

Radiated Emissions measurements were compared between above 4 LTE carrier setups. **SC1** was found to have higher emissions than **SC2**, **SC3** and **SC4**. Single RAT/Single carrier LTE in this report are therefore measured using **SC1** Bottom, Middle and Top channel carrier setup. Tested carrier/frequency detail in [Figure 5: Tested carrier detail, Single RAT /Single carrier \(LTE\) – SC 1](#).

Figure 5: Tested carrier detail, Single RAT /Single carrier (LTE) – SC 1

Single RAT/Single Carrier - LTE setups for Emissions	
B41K PORT 3A,3B,4A,4B	
BS type 1-C, CS16 (NR, LTE) TC21	
SR LTE Config SC 1 Carrier setups for Emissions	
Carrier	Bottom channel
1	B41K: LTE, 5MHz, 2517.5MHz
Carrier	Middle channel
1	B41K: LTE, 5MHz, 2595MHz
Carrier	Top channel
1	B41K: LTE, 5MHz, 2672.5MHz

2.4.1.2 Radiated Emissions Single RAT / Single Carrier Configurations (NR)

Figure 6: Carrier detail – Single RAT / Single carrier (NR)

Single RAT/Single Carrier - NR setups for Emissions	
B41K PORT 3A,3B,4A,4B	
BS type 1-C, CS16 (NR, LTE) TC21	
SR NR Config SC 5 Carrier setups for Emissions	
Carrier	Middle channel
1	B41K: NR, 20MHz, 2595MHz
SR NR Config SC 6 Carrier setups for Emissions	
Carrier	Middle channel
1	B41K: NR, 40MHz, 2595MHz
SR NR Config SC 7 Carrier setups for Emissions	
Carrier	Middle channel
1	B41K: NR, 50MHz, 2595MHz
SR NR Config SC 8 Carrier setups for Emissions	
Carrier	Middle channel
1	B41K: NR, 60MHz, 2595MHz
SR NR Config SC 9 Carrier setups for Emissions	
Carrier	Middle channel
1	B41K: NR, 70MHz, 2595MHz
SR NR Config SC 10 Carrier setups for Emissions	
Carrier	Middle channel
1	B41K: NR, 80MHz, 2595MHz
SR NR Config SC 11 Carrier setups for Emissions	
Carrier	Middle channel
1	B41K: NR, 90MHz, 2595MHz
SR NR Config SC 12 Carrier setups for Emissions	
Carrier	Middle channel
1	B41K: NR, 100MHz, 2595MHz

Note: Radiated Emissions measurements were compared between above 8 NR carrier setups. **SC5** was found to have higher emissions than **SC6, SC7, SC8, SC9, SC10, SC11, and SC12**. All plots with single NR carrier in this report are therefore measured using **SC5** Middle channel carrier setup.

2.4.1.3 Radiated Emissions Single RAT / Multi Carriers Configurations (LTE)

Figure 7: Carrier detail – Single RAT / Multi carrier (LTE)

Single RAT / Multi Carrier - LTE setups for Emissions	
B41K PORT 3A,3B,4A,4B	
BS type 1-C, CS16 (NR, LTE) TC21	
SR LTE Config MC1 Carrier setups for Emissions	
Carrier:	Middle channel
1	B41K: LTE, 5MHz, 2595MHz
2	B41K: LTE, 5MHz, 2590MHz
SR LTE Config MC2 Carrier setups for Emissions	
Carrier:	Middle channel
1	B41K: LTE, 5MHz, 2590MHz
2	B41K: LTE, 5MHz, 2595MHz
3	B41K: LTE, 5MHz, 2600MHz
SR LTE Config MC3 Carrier setups for Emissions	
Carrier:	Middle channel
1	B41K: LTE, 5MHz, 2580MHz
2	B41K: LTE, 5MHz, 2585MHz
3	B41K: LTE, 5MHz, 2590MHz
4	B41K: LTE, 5MHz, 2595MHz
5	B41K: LTE, 5MHz, 2600MHz
6	B41K: LTE, 5MHz, 2605MHz

Note: Radiated Emissions measurements were compared between **MC1**, **MC2** and **MC3**. **MC1** was found to have higher emissions. All plots with Single RAT/Multi carrier in this report are therefore measured using **MC1** middle carrier setups.



2.4.1.4 Radiated Emissions Multi RAT/Multi Carrier Configuration MR (LTE + NR)

Figure 8: Carrier detail – MultiCarrier / Multi RAT Configuration

Single RAT / Multi Carrier - LTE + NR setups for Emissions	
B41K PORT 3A,3B,4A,4B	
BS type 1-C, CS16 (NR, LTE) TC21	
MR Config MR1 Carrier setups for Emissions	
Carrier:	Middle channel
1	B41K: LTE, 5MHz, 2582.5MHZ
2	B41K: NR, 20MHz, 2595MHz
MR Config MR2 Carrier setups for Emissions	
Carrier:	Middle channel
1	B41K: LTE, 5MHz, 2572.5MHZ
2	B41K: LTE, 5MHz, 2577.5MHZ
3	B41K: LTE, 5MHz, 2582.5MHZ
4	B41K: NR, 20MHz, 2595MHz
5	B41K: NR, 20MHz, 2615MHz
6	B41K: NR, 20MHz, 2635MHz

Note: Radiated Emissions measurements were compared between **MR1**, and **MR2**. **MR1** was found to have higher emissions than **MR2**. All plots with Multi RAT/Multi carrier in this report are therefore measured using **MR1** Middle channel carrier configuration.

2.4.2 Configuration 2: Dot 4469 B41K with IRU 1649

Figure 9 shows the configuration 2 of the EUT for Radiated Emissions test.

Figure 9: Test configuration 2 for Emission tests

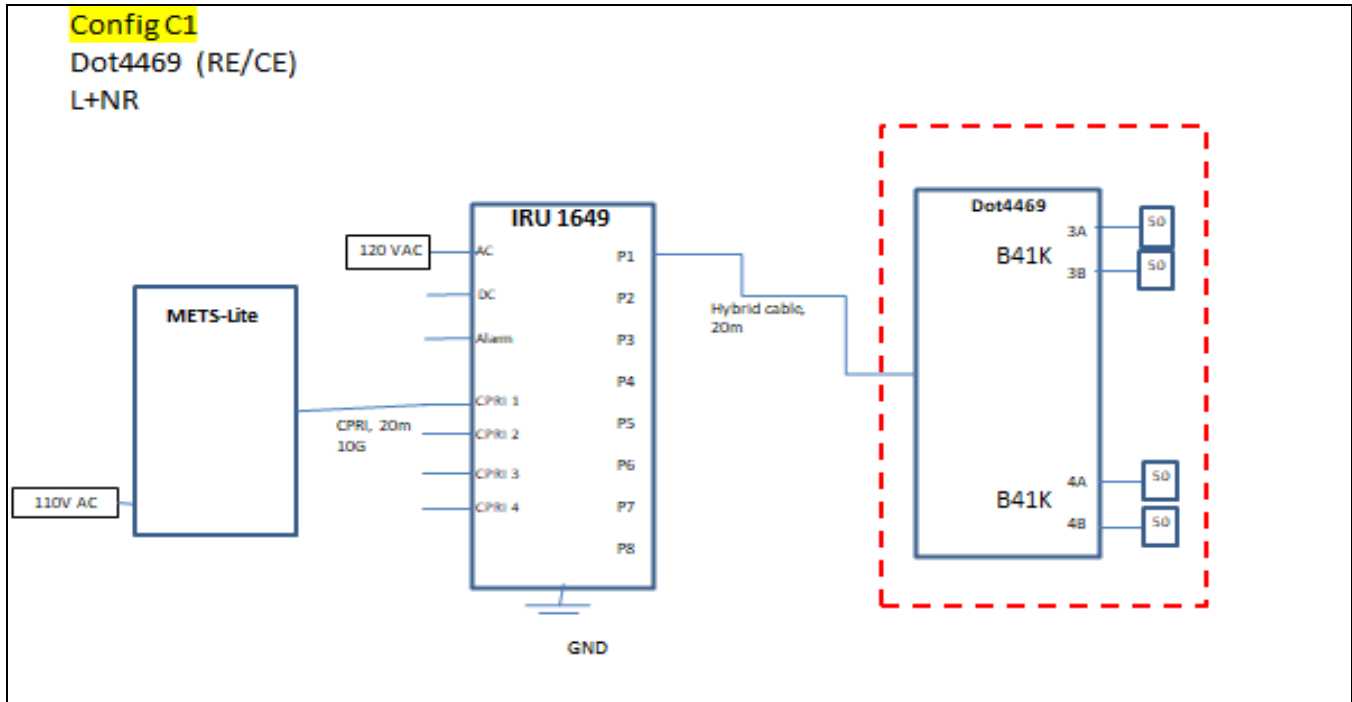

Following RAT/carrier configurations were tested during this Radiated Emissions evaluations for configuration 2.

2.4.2.1 Radiated Emissions Multi RAT/Multi Carrier Configuration MR (LTE + NR) – Cfg 2

Figure 10: Carrier detail – MultiCarrier / Multi RAT Configuration

Single RAT / Multi Carrier - LTE + NR setups for Emissions	
B41K PORT 3A,3B,4A,4B	
BS type 1-C, CS16 (NR, LTE) TC21	
MR Config MR1 Carrier setups for Emissions	
Carrier:	Middle channel
1	B41K: LTE, 5MHz, 2652.5MHZ
2	B41K: NR, 20MHz, 2665MHZ



2.5 Modifications of the EUT during testing

The EUT was not modified prior to or during testing.

2.6 Inventory of the EUT and support equipments

The following table identifies the inventory of the EUT.

Table 6: Inventory of the EUT – Configuration 1

Equipment Role	Product Name	Product Number	Product Release	Product Serial#
EUT	DOT 4469	KRY 901 502/2	R1C	TD3W150452
SUPPORT	IRU 1648	KRC 161 842/2	R1D	TD3F105263
Cable	IRU CPRI, Fiber, LC, SM, 20m		na	na
Cable	CAT6A dRDI cable, RJ45	Schnieder, F/FTP	na	na
Cable	RF, SMA, 2m, qty=8		na	na
TEST SET	METS-Lite (RUX + CT-11)	LPC 102 494/1	R2A	TO1G499655
S/W:				
IRU load:		CXP2030045_26-R10B285		
RUX rev:		R9F		
RUX testDef:		_RRUS_Triband_LTT_TX_v02 - 430		

Table 7: Inventory of the EUT – Configuration 2

Equipment Role	Product Name	Product Number	Product Release	Product Serial#
EUT	DOT 4469	KRY 901 502/2	R1C	TD3W150452
SUPPORT	IRU 1649	KRC 161 842/1	R1D	TD3F071564
Cable	IRU CPRI, Fiber, LC, SM, 20m		na	na
Cable	Hybrid cable: Optical + Power	Custom fiber + DC power	na	na
Cable	RF, SMA, 2m, qty=8		na	na
TEST SET	METS-Lite (RUX + CT-11)	LPC 102 494/1	R2A	TO1G499655
S/W:				
IRU load:		CXP2030045_26-R10B285		
RUX rev:		R9F		
RUX testDef:		_RRUS_Triband_LTT_TX_v02 - 430		



3. Detailed test results of Emissions

Emissions from systems manifest themselves in two forms: conducted emissions on cables and radiated emissions from the entire system (i.e. electronic modules, hardware, and cables). Regulatory standards restrict these different forms of emissions generated by the system.

The temperature and humidity in the test facilities are controlled. The temperature is maintained between 20 °C and 25 °C, with a relative humidity between 30 % and 60 %. Levels are recorded and any exceptions are included in the detailed test results sections of this report.

3.1 Measurement instrumentation

The measurement instrumentation conforms to the relevant standards in this report: ANSI C63.2, CISPR 16, CISPR 22, and CISPR 32. Calibration of the measurement instrumentation is maintained in accordance with the supplier's recommendations, or as necessary to ensure its accuracy.

3.2 Radiated Emissions, E-field

This test verifies that the EUT does not produce excess amounts of E-field Radiated Emissions (RE) that could interfere with licensed radiators.

3.2.1 Test specification and limits

The testing requirements are as follows.

Table 8: RE test requirements

Requirement	Method	Country of application
FCC Part 15, Subpart B	ANSI C63.4	USA
FCC Part 27	FCC Part 27/ ANSI C63.26	USA

The limits of the RE tests are as follows.

Table 9: RE limits at 10 m for Class B of FCC

Frequency range (MHz)	FCC Part 15 (dB μ V/m)	Detector
30 to 88	29.5	Quasi-Peak
88 to 216	33.0	Quasi-Peak
216 to 960	35.5	Quasi-Peak
960 to 1000	43.5	Quasi-Peak
1000 to 40000	43.5	Average

Table 10: Emission limits for FCC Part 27

Frequency range (MHz)	FCC Part 27 EIRP Limit (dBm)	Calculated EIRP Limit in dB μ V/m
30 - 40000	-13	82.2

3.2.2 Test procedure

Verifications of the test equipment and AFC were performed before the installation of the EUT in accordance with the quality assurance procedures documented in the EMC test procedures document. The test was performed according to the relevant procedures listed in [Table 8](#).

- The EUT was placed on the turntable inside the AFC (configured for normal operation). The system and its cables were separated from the ground plane by an insulating support 10 mm in height.
- For tests between 30 MHz and 1 GHz the receive antenna (BiLog®) was placed 3 m away from the EUT. An initial scan was performed to find emissions/frequencies requiring detailed measurement. The pre-scan was performed by rotating the system 360 degrees while recording all emissions

(frequency and amplitude). This procedure was repeated for antenna heights of 1 to 4 m, as well as both polarizations of the receiving antenna.

- For tests above 1 GHz the receive antenna (horn) was placed 3 m away from the EUT. Absorbing cones were placed on the floor between the antenna and the EUT. An initial scan was performed to find emissions/frequencies requiring detailed measurement. The pre-scan was performed by rotating the system 360 degrees while recording all emissions (frequency and amplitude). This procedure was repeated for antenna heights of 1 to 4 m, as well as both polarizations of the receiving antenna.
- For tests between 18 and 40 GHz the receive horn antenna was placed at a 1 m distance from the EUT with the absorbing cones placed on the floor. An initial scan was performed to find emissions/frequencies requiring detail measurement. The pre-scan was performed on all sides of the EUT, using both polarization of the receive antenna to find any system emissions.
- For all above frequency ranges, the pre-scan peak data was compared to the limits. Peaks with less than 6 dB of margin were maximized using the proper detector: the EUT was rotated in azimuth over 360 degrees to identify the direction of maximum emission, antenna height was then varied from 1 to 4 m to obtain maximum emission level.

Figure 11: Setup of Radiated Emissions

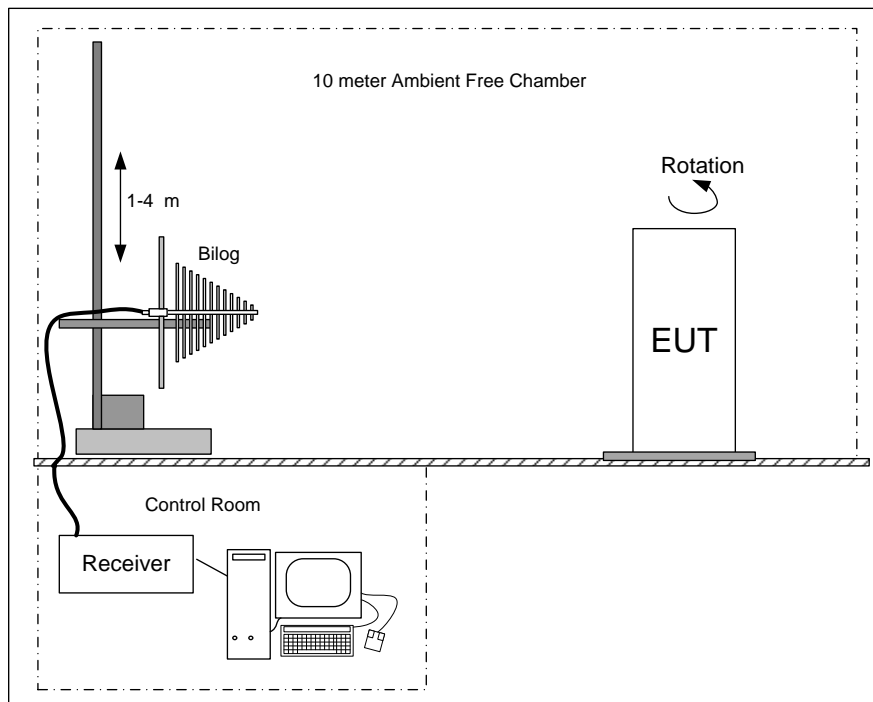

3.2.3 Calculation of the compliance margin

The following example shows the way in which the compliance margin is calculated in the “RE Test Results” tables.

The rows in these tables are defined as follows.

Meter Reading (dB μ V) = Voltage measured using the spectrum analyzer with the proper detector

Correction (dB) = Cumulative gain or loss of pre-amplifier and cables used in the measurement path (dB) + Antenna Factor (dB)

Level (dB μ V/m) = Corrected value or field strength, that is, the parameter of interest that is compared to the limit

Margin (dB) = Level with respect to the appropriate limit (a negative Margin indicates that the Level is below the limit and that the measurement is a Pass)

The values in the Level row are calculated as follows: Level = Meter Reading + Correction (dB)

The values in the Margin row are calculated as follows: Margin = Level – Limit

3.2.4 Measurement uncertainties

The expanded measurement instrumentation uncertainty with a 95 % level of confidence, calculated according to the method described in CISPR 16 is:

- ± 3.8 dB between 30 MHz and 1 GHz
- ± 4.7 dB between 1 GHz and 10 GHz
- ± 4.8 dB between 10 GHz and 18 GHz
- ± 4.6 dB between 18 GHz and 26.5 GHz
- ± 4.8 dB between 26.5 GHz and 40 GHz



3.2.5 Test results of RE – (Single RAT/Single Carrier (LTE) – Bottom channel)

Test location: 10-meter Ambient Free Chamber (AFC)

Date tested: 15 - 20 September 2021

Tested by: Steve Mcfarlane

Test configurations are listed as SC LTE in 2.4.1.1 as identified in the section [Configurations of the EUT](#). For the following test results that have supporting data tables, negative margin values indicate a pass.

Red trace – Vertical antenna polarity, **Blue trace** – Horizontal antenna polarity

Figure 12: Plot of RE at 3 m – 30 to 1000 MHz (LTE – Bottom channel)

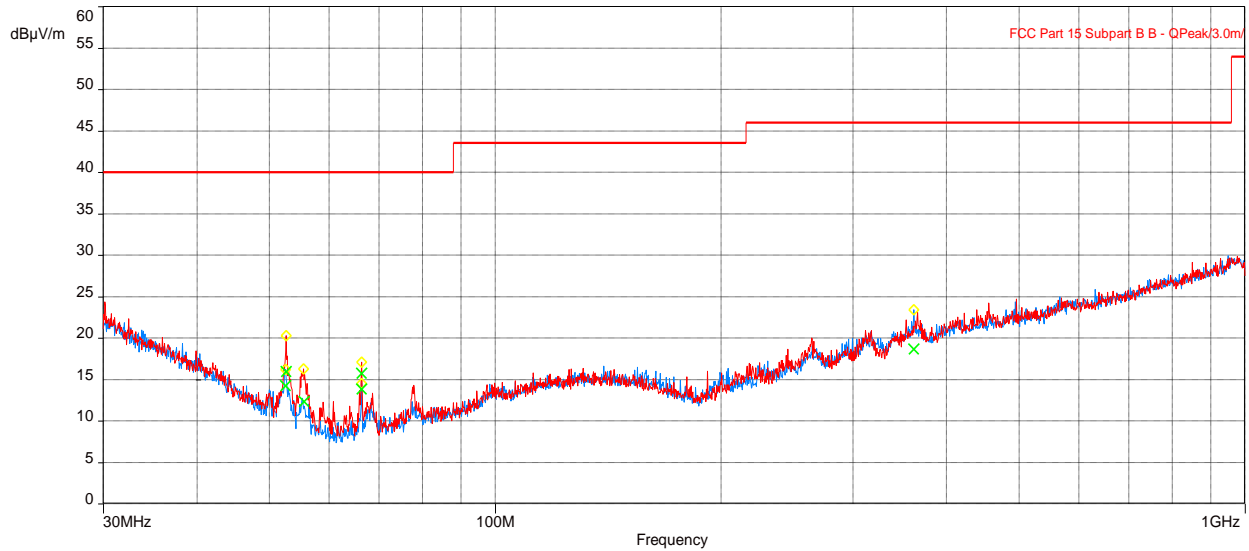

Table 11: RE test results from 30 to 1000 MHz for FCC Part 15 (LTE – Bottom channel)

Frequency (MHz)	Level (dBµV)	Limit Quasi-peak (dBµV)	Margin to FCC part 15 Class B (dB)	Height (m)	Azimuth (deg)	Polarization	Correction (dB)
52.59054454	15.91	40.00	-24.09	1.23	357.50	Vertical	-14.89
66.35709008	15.72	40.00	-24.28	3.89	333.75	Vertical	-16.35
66.35692982	13.84	40.00	-26.16	2.36	333.75	Horizontal	-16.35
361.4040097	18.64	46.02	-27.38	2.79	341.75	Horizontal	-4.85

Table 12: RE test results from 30 to 1000 MHz for FCC Part 27 (LTE – Bottom channel)

Frequency (MHz)	Level (dBµV)	Limit EIRP (dBµV)	Margin to EIRP Limit (dB)	Height (m)	Azimuth (deg)	Polarization	Correction (dB)
52.59054454	15.91	82.2	- 66.29	1.23	357.50	Vertical	-14.89
66.35709008	15.72	82.2	- 66.48	3.89	333.75	Vertical	-16.35
66.35692982	13.84	82.2	- 68.36	2.36	333.75	Horizontal	-16.35
361.4040097	18.64	82.2	- 63.56	2.79	341.75	Horizontal	-4.85

Note: In the table/Plot above, no emissions exceed the Part 27 radiated spurious emissions limit when converted to dBuV/m. For final spurious emissions measurements to FCC Part 27, see antenna port conducted emissions in applicable test report.

Figure 13: Plot of RE at 3m from 1 to 3 GHz (LTE – Bottom channel)

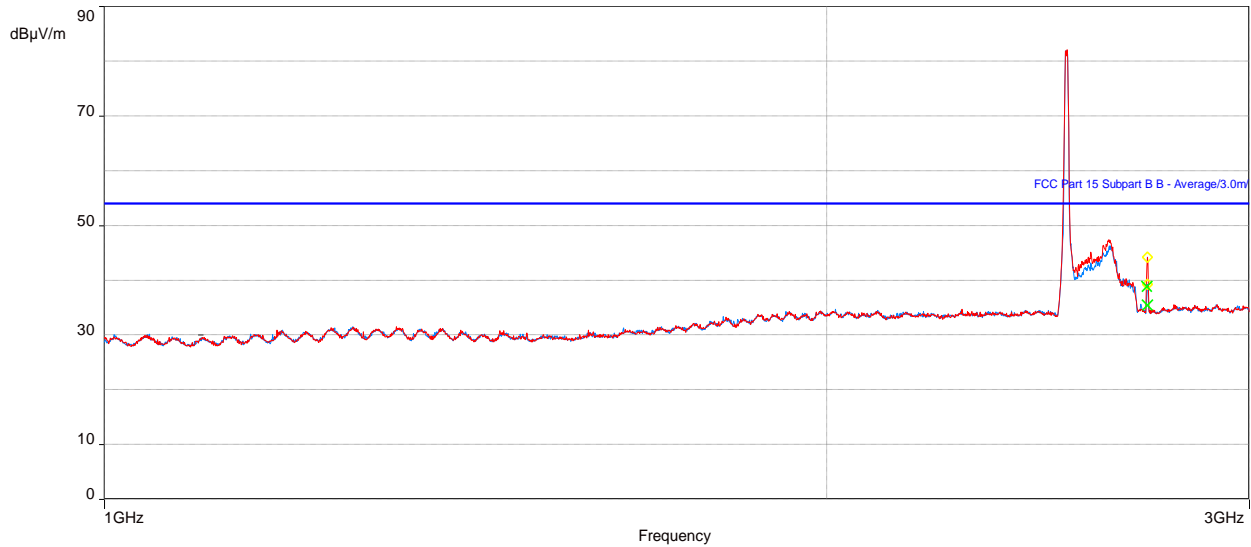

Note: Peak above the limit is leakage of the EUT’s fundamentals from the 50-ohm terminations.

Table 13: RE test results from 1 to 3 GHz for FCC Part 15 (LTE – Bottom channel)

Frequency (MHz)	Level Average (dBµV)	Limit Average (dBµV)	Margin to FCC part 15 Class B (dB)	Height (m)	Azimuth (degrees)	Polarization	Correction (dB)
2720.083013	38.81	53.96	-15.15	1.11	320.25	Vertical	2.42
2721.169872	35.36	53.96	-18.60	1.04	327.25	Horizontal	2.42

Table 14: RE test results from 1 to 3 GHz for FCC Part 27 (LTE – Bottom channel)

Frequency (MHz)	Level (dBµV)	Limit EIRP (dBµV)	Margin to EIRP Limit (dB)	Height (m)	Azimuth (deg)	Polarization	Correction (dB)
2720.083013	38.81	82.2	-43.39	1.11	320.25	Vertical	2.42
2721.169872	35.36	82.2	-46.84	1.04	327.25	Horizontal	2.42

Note: In the table/Plot above, no emissions exceeded the Part 27 radiated spurious emissions limit when converted to dBuV/m. For final spurious emissions measurements to FCC Part 27, see antenna port conducted emissions in applicable test report.

Figure 14: Plot of RE at 3m from 3 to 10 GHz (LTE – Bottom channel)

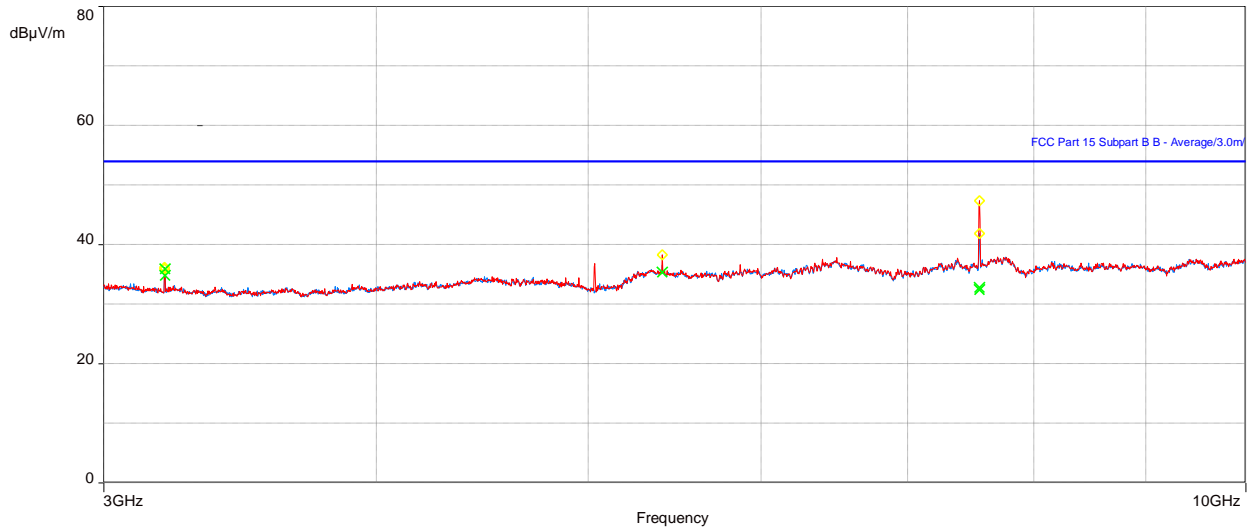

Table 15: RE test results from 3 to 10 GHz for FCC Part 15 (LTE – Bottom channel)

Frequency (MHz)	Level Average (dBµV)	Limit Average (dBµV)	Margin to FCC part 15 Class B (dB)	Height (m)	Azimuth (degrees)	Polarization	Correction (dB)
3199.980095	34.81	53.96	-19.15	1.25	90.25	Vertical	-3.73
5406.684936	35.33	53.96	-18.63	3.48	269.75	Vertical	-0.42
7552.666987	32.72	53.96	-21.24	2.72	356.25	Vertical	4.42
3199.980095	35.88	53.96	-18.08	2.42	162.25	Horizontal	-3.73

Table 16: RE test results from 3 to 10 GHz for FCC Part 27 (LTE – Bottom channel)

Frequency (MHz)	Level (dBµV)	Limit EIRP (dBµV)	Margin to EIRP Limit (dB)	Height (m)	Azimuth (deg)	Polarization	Correction (dB)
3199.980095	34.81	82.2	-47.39	1.25	90.25	Vertical	-3.73
5406.684936	35.33	82.2	-46.87	3.48	269.75	Vertical	-0.42
7552.666987	32.72	82.2	-49.48	2.72	356.25	Vertical	4.42
3199.980095	35.88	82.2	-46.32	2.42	162.25	Horizontal	-3.73

Note: In the table/Plot above, no emissions exceed the Part 27 radiated spurious emissions limit when converted to dBuV/m. For final spurious emissions measurements to FCC Part 27, see antenna port conducted emissions in applicable test report.

Figure 15: Plot of RE at 3m from 10 to 18 GHz (LTE – Bottom channel)

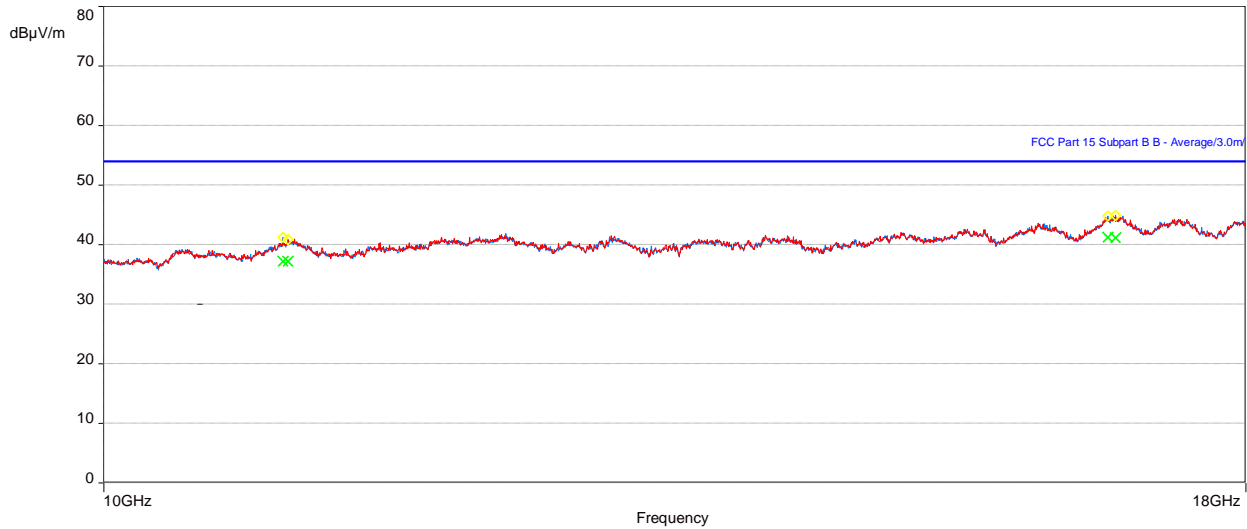

Table 17: RE test results from 10 to 18 GHz for FCC Part 15 (LTE – Bottom channel)

Frequency (MHz)	Level Average (dBµV)	Limit Average (dBµV)	Margin to FCC part 15 Class B (dB)	Height (m)	Azimuth (degrees)	Polarization	Correction (dB)
10994.8096	37.15	53.96	-16.81	1.00	336.00	Vertical	8.72
16834.12659	41.09	53.96	-12.87	3.14	349.50	Vertical	15.42
10969.07021	37.12	53.96	-16.84	4.00	343.25	Horizontal	8.70
16767.13492	41.24	53.96	-12.72	4.00	2.75	Horizontal	14.88

Table 18: RE test results from 10 to 18 GHz (LTE – Bottom channel)

Frequency (MHz)	Level (dBµV)	Limit EIRP (dBµV)	Margin to EIRP Limit (dB)	Height (m)	Azimuth (deg)	Polarization	Correction (dB)
10994.8096	37.15	82.2	-45.05	1.00	336.00	Vertical	8.72
16834.12659	41.09	82.2	-41.11	3.14	349.50	Vertical	15.42
10969.07021	37.12	82.2	-45.08	4.00	343.25	Horizontal	8.70
16767.13492	41.24	82.2	-40.96	4.00	2.75	Horizontal	14.88

Note: In the table/Plot above, no emissions exceed the Part 27 radiated spurious emissions limit when converted to dBuV/m. For final spurious emissions measurements to FCC Part 27, see antenna port conducted emissions in applicable test report.



3.2.6 Test results of RE – (Single RAT/Single Carrier (LTE) – Middle channel)

Test location: 10-meter Ambient Free Chamber (AFC)

Date tested: 15 - 20 September 2021

Tested by: Steve Mcfarlane

Test configurations are listed as SC LTE in [2.4.1.1](#) as identified in the section [Configurations of the EUT](#). For the following test results that have supporting data tables, negative margin values indicate a pass.

Red trace – Vertical antenna polarity, **Blue trace** – Horizontal antenna polarity

Figure 16: Plot of RE at 3 m – 30 to 1000 MHz (LTE – Middle channel)



Table 19: RE test results from 30 to 1000 MHz for FCC Part 15 (LTE – Middle channel)

Frequency (MHz)	Level (dBµV)	Limit Quasi-peak (dBµV)	Margin to FCC part 15 Class B (dB)	Height (m)	Azimuth (deg)	Polarization	Correction (dB)
52.50235864	16.48	40.00	-23.52	1.00	362.00	Vertical	-14.86
66.35676956	15.21	40.00	-24.79	4.00	333.50	Vertical	-16.35
52.50588428	13.83	40.00	-26.17	2.66	360.00	Horizontal	-14.86
66.357333	13.38	40.00	-26.62	2.39	333.75	Horizontal	-16.35

Table 20: RE test results from 30 to 1000 MHz for FCC Part 27 (LTE – Middle channel)

Frequency (MHz)	Level (dBµV)	Limit EIRP (dBµV)	Margin to EIRP Limit (dB)	Height (m)	Azimuth (deg)	Polarization	Correction (dB)
52.50235864	16.48	82.2	-65.72	1.00	362.00	Vertical	-14.86
66.35676956	15.21	82.2	-66.99	4.00	333.50	Vertical	-16.35
52.50588428	13.83	82.2	-68.37	2.66	360.00	Horizontal	-14.86
66.357333	13.38	82.2	-68.82	2.39	333.75	Horizontal	-16.35

Note: In the table/Plot above, no emissions exceed the Part 27 radiated spurious emissions limit when converted to dBuV/m. For final spurious emissions measurements to FCC Part 27, see antenna port conducted emissions in applicable test report.

Figure 17: Plot of RE at 3m from 1 to 3 GHz (LTE – Middle channel)

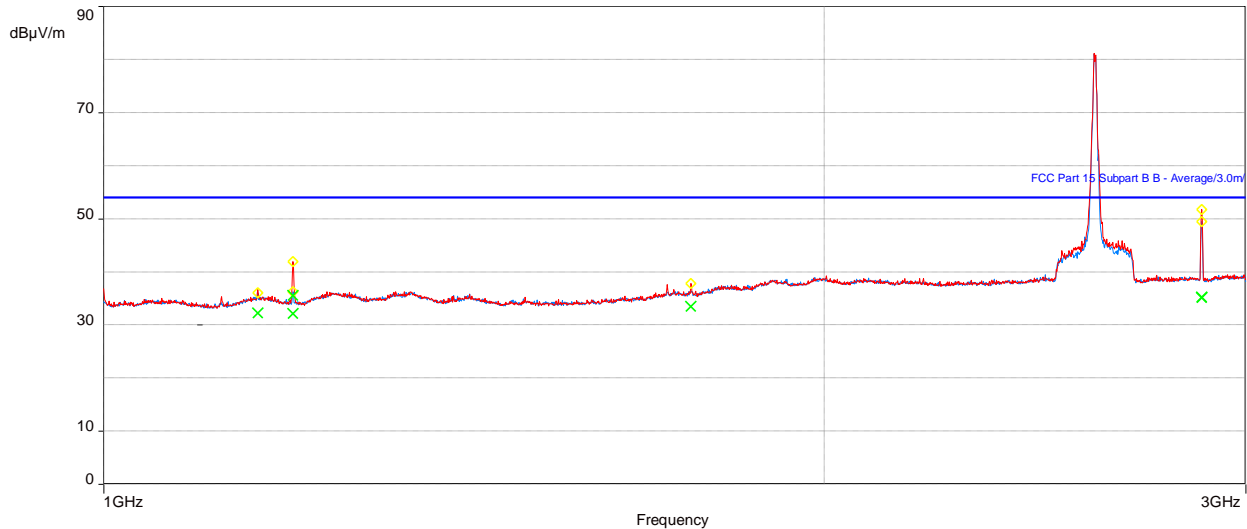

Note: Peak above the limit is leakage of the EUT’s fundamentals from the 50-ohm terminations.

Table 21: RE test results from 1 to 3 GHz for FCC Part 15 (LTE – Middle channel)

Frequency (MHz)	Level Average (dBµV)	Limit Average (dBµV)	Margin to FCC part 15 Class B (dB)	Height (m)	Azimuth (degrees)	Polarization	Correction (dB)
1200.078238	35.50	53.96	-18.46	2.49	341.75	Vertical	-4.72
1759.73141	33.47	53.96	-20.49	2.66	97.00	Vertical	-2.20
2875.776249	35.19	53.96	-18.77	3.38	219.50	Vertical	0.78
2875.592982	35.06	53.96	-18.90	3.55	269.75	Horizontal	0.78

Table 22: RE test results from 1 to 3 GHz for FCC Part 27 (LTE – Middle channel)

Frequency (MHz)	Level (dBµV)	Limit EIRP (dBµV)	Margin to EIRP Limit (dB)	Height (m)	Azimuth (deg)	Polarization	Correction (dB)
1200.078238	35.50	82.2	-46.7	2.49	341.75	Vertical	-4.72
1759.73141	33.47	82.2	-48.73	2.66	97.00	Vertical	-2.20
2875.776249	35.19	82.2	-47.01	3.38	219.50	Vertical	0.78
2875.592982	35.06	82.2	-47.14	3.55	269.75	Horizontal	0.78

Note: In the table/Plot above, no emissions exceed the Part 27 radiated spurious emissions limit when converted to dBuV/m, except for the fundamental. For final spurious emissions measurements to FCC Part 27, see antenna port conducted emissions in applicable test report.

Figure 18: Plot of RE at 3m from 3 to 10 GHz (LTE – Middle channel)

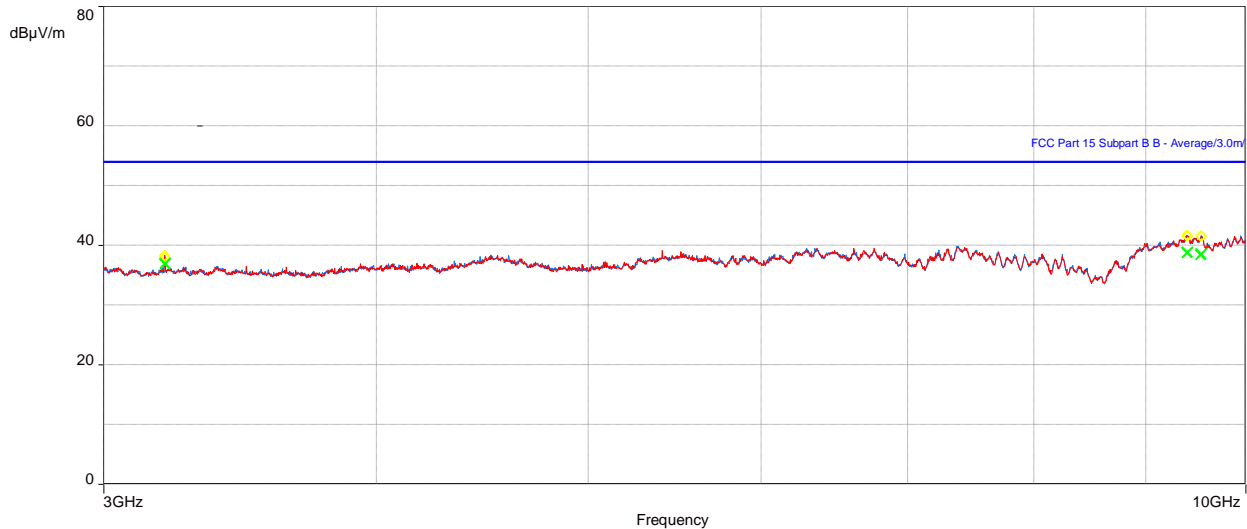

Table 23: RE test results from 3 to 10 GHz for FCC Part 15 (LTE – Middle channel)

Frequency (MHz)	Level Average (dBµV)	Limit Average (dBµV)	Margin to FCC part 15 Class B (dB)	Height (m)	Azimuth (degrees)	Polarization	Correction (dB)
9406.767341	38.84	53.96	-15.12	3.07	104.50	Vertical	9.95
9544.485897	38.53	53.96	-15.43	1.11	88.75	Vertical	9.87
3199.979521	36.77	53.96	-17.19	2.01	156.25	Horizontal	3.96
9539.332018	38.34	53.96	-15.62	4.00	97.50	Horizontal	9.94

Table 24: RE test results from 3 to 10 GHz for FCC Part 27 (LTE – Middle channel)

Frequency (MHz)	Level (dBµV)	Limit EIRP (dBµV)	Margin to EIRP Limit (dB)	Height (m)	Azimuth (deg)	Polarization	Correction (dB)
9406.767341	38.84	82.2	-43.36	3.07	104.50	Vertical	9.95
9544.485897	38.53	82.2	-43.67	1.11	88.75	Vertical	9.87
3199.979521	36.77	82.2	-45.43	2.01	156.25	Horizontal	3.96
9539.332018	38.34	82.2	-43.86	4.00	97.50	Horizontal	9.94

Note: In the table/Plot above, no emissions exceeded the Part 27 radiated spurious emissions limit when converted to dBuV/m, except for the fundamental. For final spurious emissions measurements to FCC Part 27, see antenna port conducted emissions in applicable test report.

Figure 19: Plot of RE at 3m from 10 to 18 GHz (LTE – Middle channel)

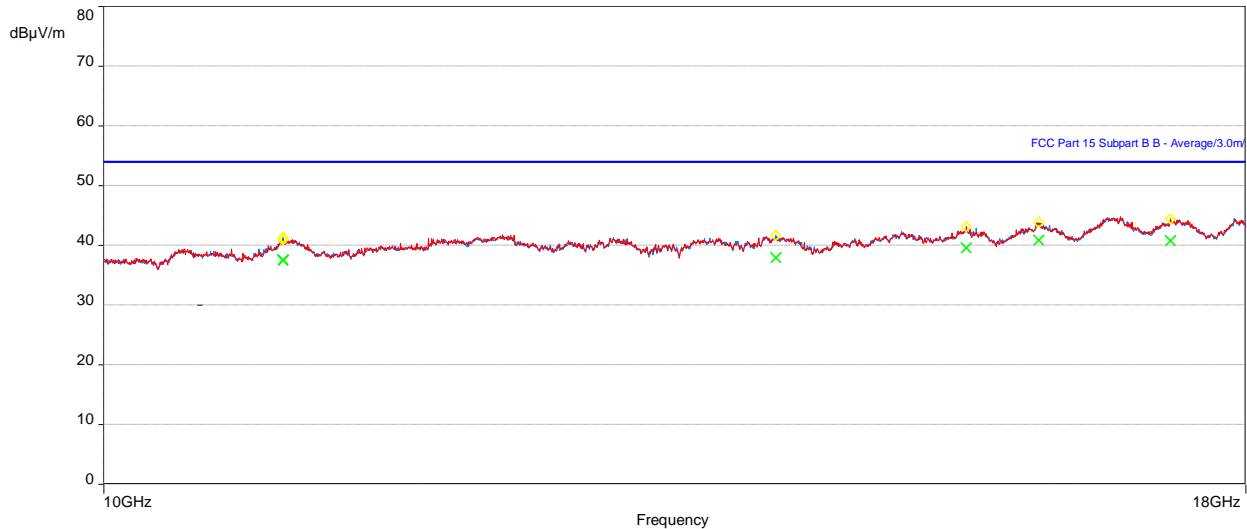

Table 25: RE test results from 10 to 18 GHz for FCC Part 15 (LTE – Middle channel)

Frequency (MHz)	Level Average (dBµV)	Limit Average (dBµV)	Margin to FCC part 15 Class B (dB)	Height (m)	Azimuth (degrees)	Polarization	Correction (dB)
10969.44518	37.51	53.96	-16.45	3.59	0.00	Vertical	8.70
15591.7971	39.53	53.96	-14.43	3.14	357.75	Vertical	14.90
17319.5311	40.70	53.96	-13.26	3.21	357.25	Vertical	14.35
16183.08685	40.81	53.96	-13.15	3.52	38.50	Horizontal	14.94

Table 26: RE test results from 10 to 18 GHz (LTE – Middle channel)

Frequency (MHz)	Level (dBµV)	Limit EIRP (dBµV)	Margin to EIRP Limit (dB)	Height (m)	Azimuth (deg)	Polarization	Correction (dB)
10969.44518	37.51	82.2	-44.69	3.59	0.00	Vertical	8.70
15591.7971	39.53	82.2	-42.67	3.14	357.75	Vertical	14.90
17319.5311	40.70	82.2	-41.5	3.21	357.25	Vertical	14.35
16183.08685	40.81	82.2	-41.39	3.52	38.50	Horizontal	14.94

Note: In the table/Plot above, no emissions exceed the Part 27 radiated spurious emissions limit when converted to dBuV/m. For final spurious emissions measurements to FCC Part 27, see antenna port conducted emissions in applicable test report.

Figure 20: Plot of RE at 1m from 18 to 26.5 GHz (LTE – Middle channel)

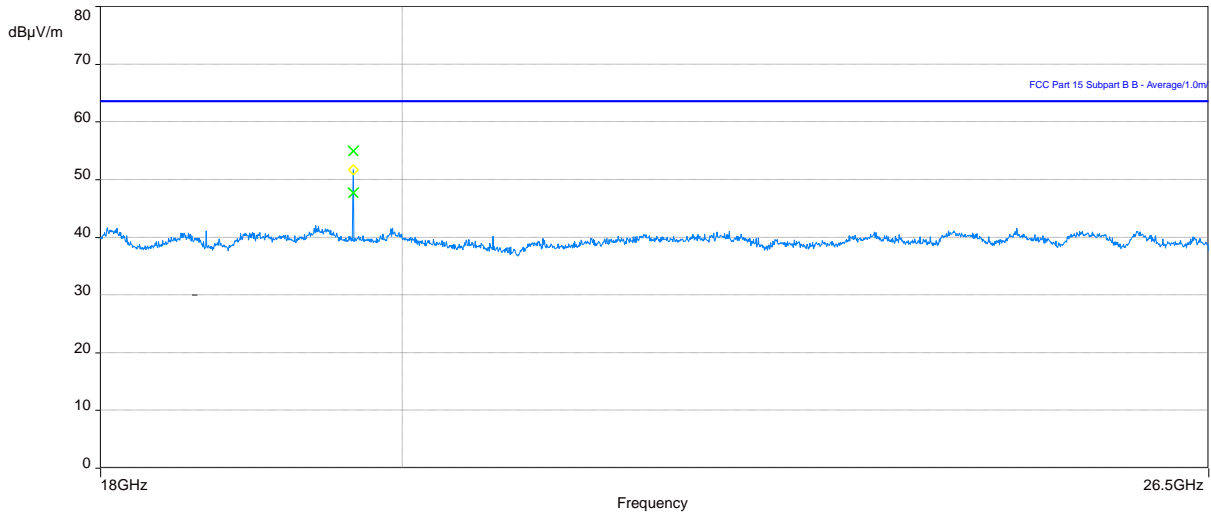

Note 1: In the plot above No Emissions exceeds the FCC Part 15 limit.

Note 2: In the plot above, no emissions exceed the Part 27 radiated spurious emissions limit when converted to dBuV/m. For final spurious emissions measurements to FCC Part 27, see antenna port conducted emissions in applicable test report.

Figure 21: Plot of RE at 1m from 26.5 to 40 GHz (LTE – Middle channel)

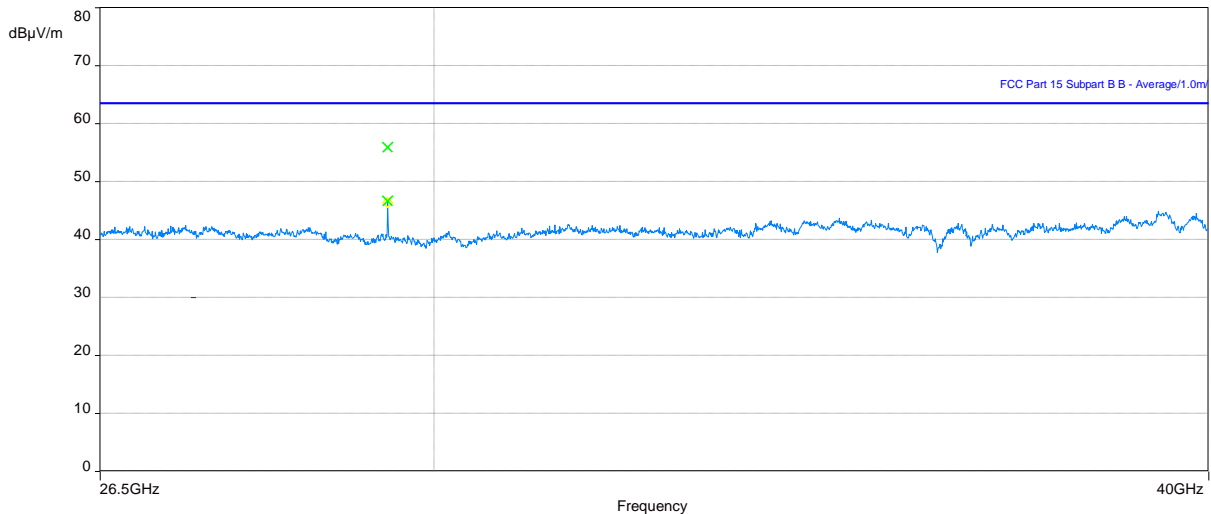

Note 1: In the plot above No Emissions exceeds the FCC Part 15 limit.

Note 2: In the plot above, no emissions exceed the Part 27 radiated spurious emissions limit when converted to dBuV/m. For final spurious emissions measurements to FCC Part 27, see antenna port conducted emissions in applicable test report.



3.2.7 Test results of RE – (Single RAT/Single Carrier (LTE) – Top channel)

Test location: 10-meter Ambient Free Chamber (AFC)

Date tested: 15 - 20 September 2021

Tested by: Steve Mcfarlane

Test configurations are listed as SC LTE in [2.4.1.1](#) as identified in the section [Configurations of the EUT](#). For the following test results that have supporting data tables, negative margin values indicate a pass.

Red trace – Vertical antenna polarity, **Blue trace** – Horizontal antenna polarity

Figure 22: Plot of RE at 3 m – 30 to1000 MHz (LTE – Top channel)

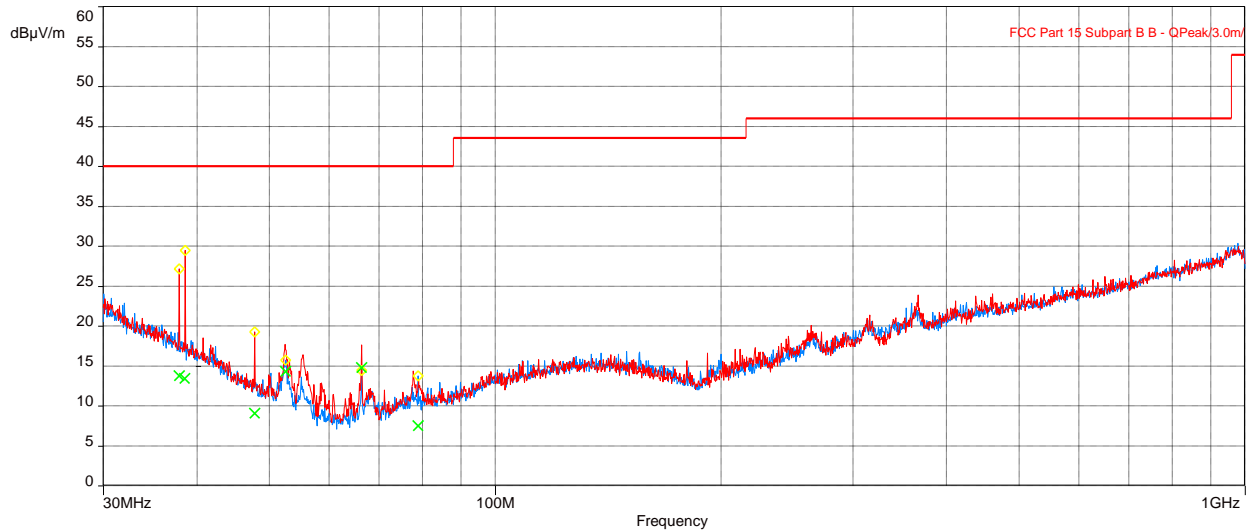

Table 27: RE test results from 30 to 1000 MHz for FCC Part 15 (LTE – Top channel)

Frequency (MHz)	Level (dBµV)	Limit Quasi-peak (dBµV)	Margin to FCC part 15 Class B (dB)	Height (m)	Azimuth (deg)	Polarization	Correction (dB)
37.87731377	13.74	40.00	-26.26	3.68	120.00	Vertical	-7.06
52.50315992	14.28	40.00	-25.72	2.44	355.00	Horizontal	-14.86
66.35696762	14.75	40.00	-25.25	2.25	334.00	Horizontal	-16.35

Table 28: RE test results from 30 to 1000 MHz for FCC Part 27 (LTE – Top channel)

Frequency (MHz)	Level (dBµV)	Limit EIRP (dBµV)	Margin to EIRP Limit (dB)	Height (m)	Azimuth (deg)	Polarization	Correction (dB)
37.87731377	13.74	82.2	-68.46	3.68	120.00	Vertical	-7.06
52.50315992	14.28	82.2	-67.92	2.44	355.00	Horizontal	-14.86
66.35696762	14.75	82.2	-67.45	2.25	334.00	Horizontal	-16.35

Note: In the table/Plot above, no emissions exceed the Part 27 radiated spurious emissions limit when converted to dBuV/m. For final spurious emissions measurements to FCC Part 27, see antenna port conducted emissions in applicable test report.

Figure 23: Plot of RE at 3m from 1 to 3 GHz (LTE – Top channel)

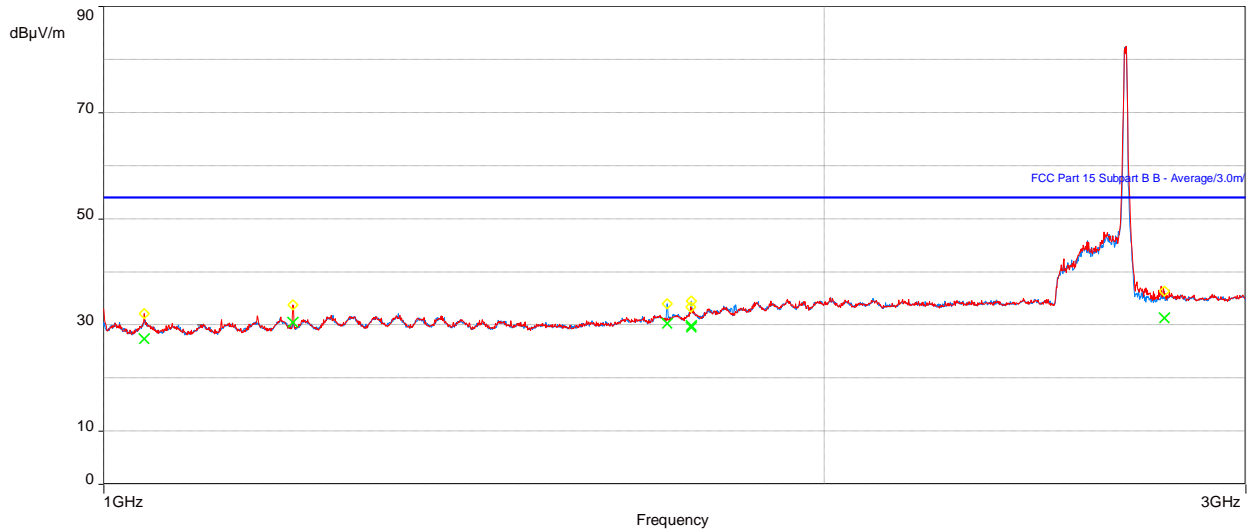

Table 29: RE test results from 1 to 3 GHz for FCC Part 15 (LTE – Top channel)

Frequency (MHz)	Level Average (dBµV)	Limit Average (dBµV)	Margin to FCC part 15 Class B (dB)	Height (m)	Azimuth (degrees)	Polarization	Correction (dB)
1199.921187	30.44	53.96	-23.52	2.93	199.25	Vertical	-3.76
1759.881444	29.48	53.96	-24.48	2.17	146.50	Vertical	-0.98
1719.736892	30.21	53.96	-23.75	2.07	276.00	Horizontal	-1.42
2774.375033	31.30	53.96	-22.66	1.00	327.25	Horizontal	2.50

Table 30: RE test results from 1 to 3 GHz for FCC Part 27 (LTE – Top channel)

Frequency (MHz)	Level (dBµV)	Limit EIRP (dBµV)	Margin to EIRP Limit (dB)	Height (m)	Azimuth (deg)	Polarization	Correction (dB)
1199.921187	30.44	82.2	-51.76	2.93	199.25	Vertical	-3.76
1759.881444	29.48	82.2	-52.72	2.17	146.50	Vertical	-0.98
1719.736892	30.21	82.2	-51.99	2.07	276.00	Horizontal	-1.42
2774.375033	31.30	82.2	-50.9	1.00	327.25	Horizontal	2.50

Note: In the table/Plot above, no emissions exceed the Part 27 radiated spurious emissions limit when converted to dBuV/m, except for the fundamental. For final spurious emissions measurements to FCC Part 27, see antenna port conducted emissions in applicable test report.

Figure 24: Plot of RE at 3m from 3 to 10 GHz (LTE – Top channel)

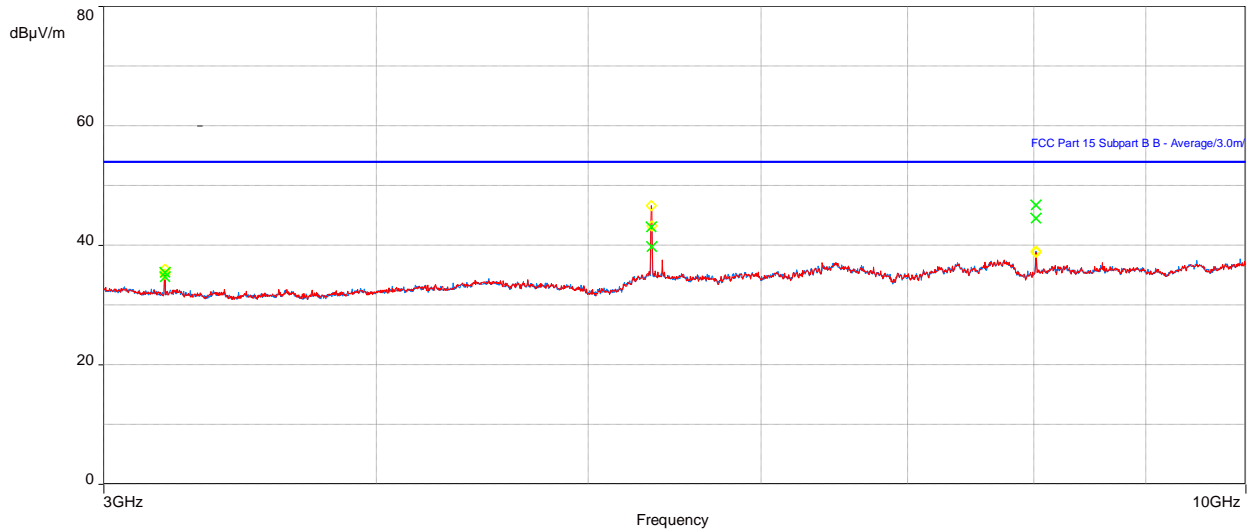

Table 31: RE test results from 3 to 10 GHz for FCC Part 15 (LTE – Top channel)

Frequency (MHz)	Level Average (dBµV)	Limit Average (dBµV)	Margin to FCC part 15 Class B (dB)	Height (m)	Azimuth (degrees)	Polarization	Correction (dB)
5344.65189	43.04	53.96	-10.92	1.04	320.25	Vertical	-0.23
8015.860931	44.53	53.96	-9.43	3.48	31.50	Vertical	4.36
5346.473718	39.70	53.96	-14.26	3.34	305.75	Horizontal	-0.23
8016.914423	46.66	53.96	-7.30	3.27	19.00	Horizontal	4.36

Table 32: RE test results from 3 to 10 GHz for FCC Part 27 (LTE – Top channel)

Frequency (MHz)	Level (dBµV)	Limit EIRP (dBµV)	Margin to EIRP Limit (dB)	Height (m)	Azimuth (deg)	Polarization	Correction (dB)
5344.65189	43.04	82.2	-39.16	1.04	320.25	Vertical	-0.23
8015.860931	44.53	82.2	-37.67	3.48	31.50	Vertical	4.36
5346.473718	39.70	82.2	-42.5	3.34	305.75	Horizontal	-0.23
8016.914423	46.66	82.2	-35.54	3.27	19.00	Horizontal	4.36

Note: In the table/Plot above, no emissions exceed the Part 27 radiated spurious emissions limit when converted to dBuV/m, except for the fundamental. For final spurious emissions measurements to FCC Part 27, see antenna port conducted emissions in applicable test report.

Figure 25: Plot of RE at 3m from 10 to 18 GHz (LTE – Top channel)

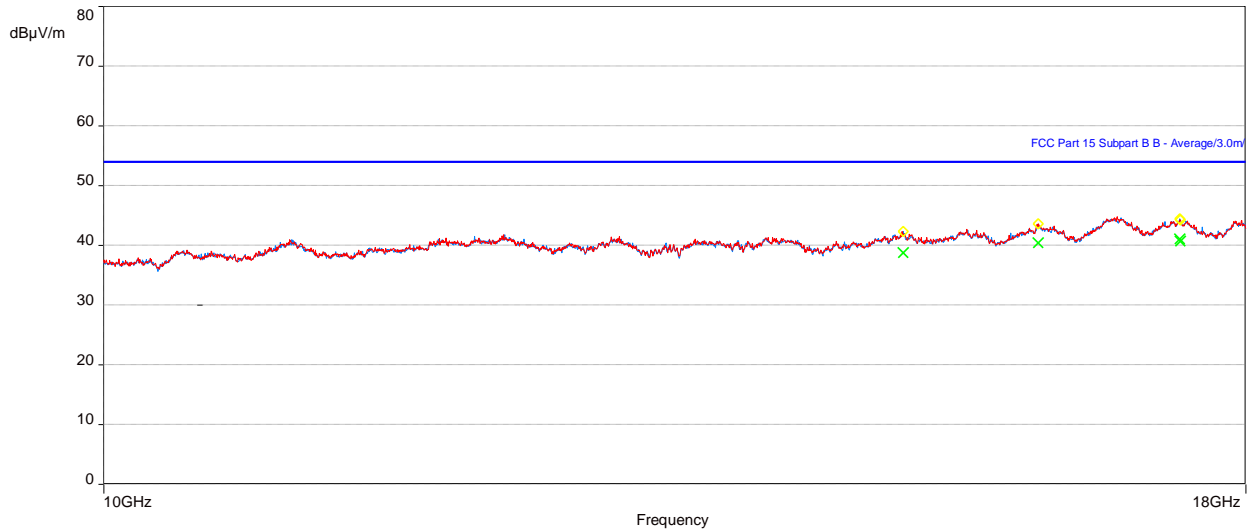

Table 33: RE test results from 10 to 18 GHz for FCC Part 15 (LTE – Top channel)

Frequency (MHz)	Level Average (dBµV)	Limit Average (dBµV)	Margin to FCC part 15 Class B (dB)	Height (m)	Azimuth (degrees)	Polarization	Correction (dB)
16179.28814	40.40	53.96	-13.56	1.00	0.00	Vertical	14.87
17403.81731	40.68	53.96	-13.28	1.00	3.50	Vertical	15.28
15090.11056	38.73	53.96	-15.23	4.00	39.25	Horizontal	14.33
17400.94521	41.01	53.96	-12.95	3.45	25.00	Horizontal	15.30

Table 34: RE test results from 10 to 18 GHz (LTE – Top channel)

Frequency (MHz)	Level (dBµV)	Limit EIRP (dBµV)	Margin to EIRP Limit (dB)	Height (m)	Azimuth (deg)	Polarization	Correction (dB)
16179.28814	40.40	82.2	-41.80	1.00	0.00	Vertical	14.87
17403.81731	40.68	82.2	-41.52	1.00	3.50	Vertical	15.28
15090.11056	38.73	82.2	-43.47	4.00	39.25	Horizontal	14.33
17400.94521	41.01	82.2	-41.19	3.45	25.00	Horizontal	15.30

Note: In the table/Plot above, no emissions exceeded the Part 27 radiated spurious emissions limit when converted to dBuV/m. For final spurious emissions measurements to FCC Part 27, see antenna port conducted emissions in applicable test report.



3.2.8 Test results of RE – (Single RAT/Single Carrier (NR) – Middle channel)

Test location: 10-meter Ambient Free Chamber (AFC)

Date tested: 15 - 20 September 2021

Tested by: Steve Mcfarlane

Test configurations are listed as SC NR in [2.4.1.2](#) as identified in the section [Configurations of the EUT](#). For the following test results that have supporting data tables, negative margin values indicate a pass.

Red trace – Vertical antenna polarity, **Blue trace** – Horizontal antenna polarity

Figure 26: Plot of RE at 3 m – 30 to 1000 MHz (NR – Middle channel)

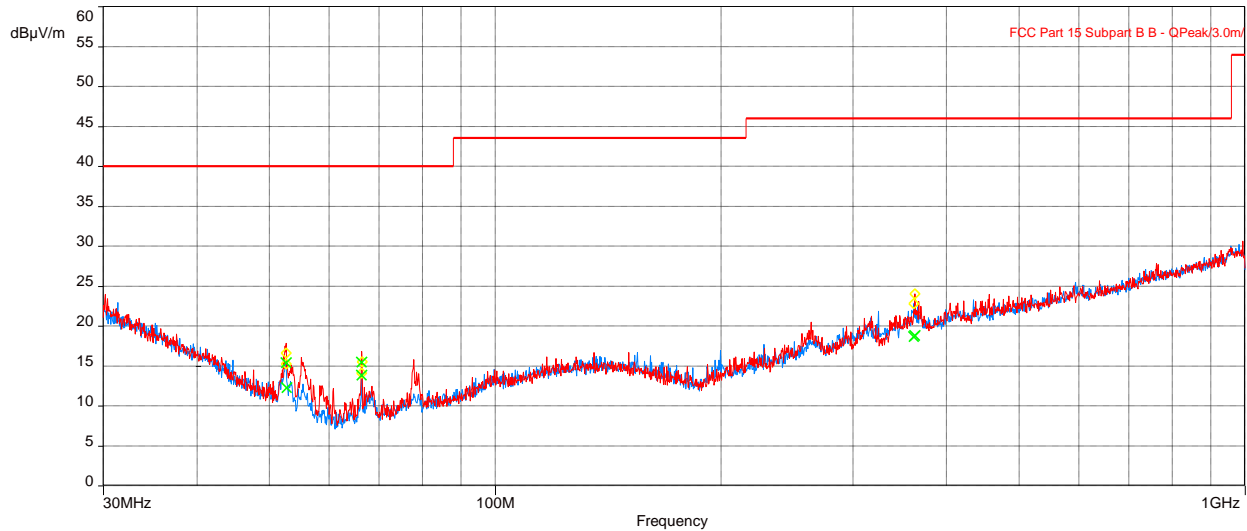

Table 35: RE test results from 30 to 1000 MHz for FCC Part 15 (NR – Middle channel)

Frequency (MHz)	Level (dBµV)	Limit Quasi-peak (dBµV)	Margin to FCC part 15 Class B (dB)	Height (m)	Azimuth (deg)	Polarization	Correction (dB)
52.5984359	15.36	40.00	-24.64	1.04	361.75	Vertical	-14.89
66.3573333	15.42	40.00	-24.58	3.98	333.75	Vertical	-16.35
362.5946123	18.79	46.02	-27.23	1.83	283.00	Vertical	-4.85
52.70156444	12.25	40.00	-27.75	2.55	356.50	Horizontal	-14.93

Table 36: RE test results from 30 to 1000 MHz for FCC Part 27 (NR – Middle channel)

Frequency (MHz)	Level (dBµV)	Limit EIRP (dBµV)	Margin to EIRP Limit (dB)	Height (m)	Azimuth (deg)	Polarization	Correction (dB)
52.5984359	15.36	82.2	-66.84	1.04	361.75	Vertical	-14.89
66.3573333	15.42	82.2	-66.78	3.98	333.75	Vertical	-16.35
362.5946123	18.79	82.2	-63.41	1.83	283.00	Vertical	-4.85
52.70156444	12.25	82.2	-69.95	2.55	356.50	Horizontal	-14.93

Note: In the table/Plot above, no emissions exceed the Part 27 radiated spurious emissions limit when converted to dBuV/m. For final spurious emissions measurements to FCC Part 27, see antenna port conducted emissions in applicable test report.

Figure 27: Plot of RE at 3m from 1 to 3 GHz (NR – Middle channel)

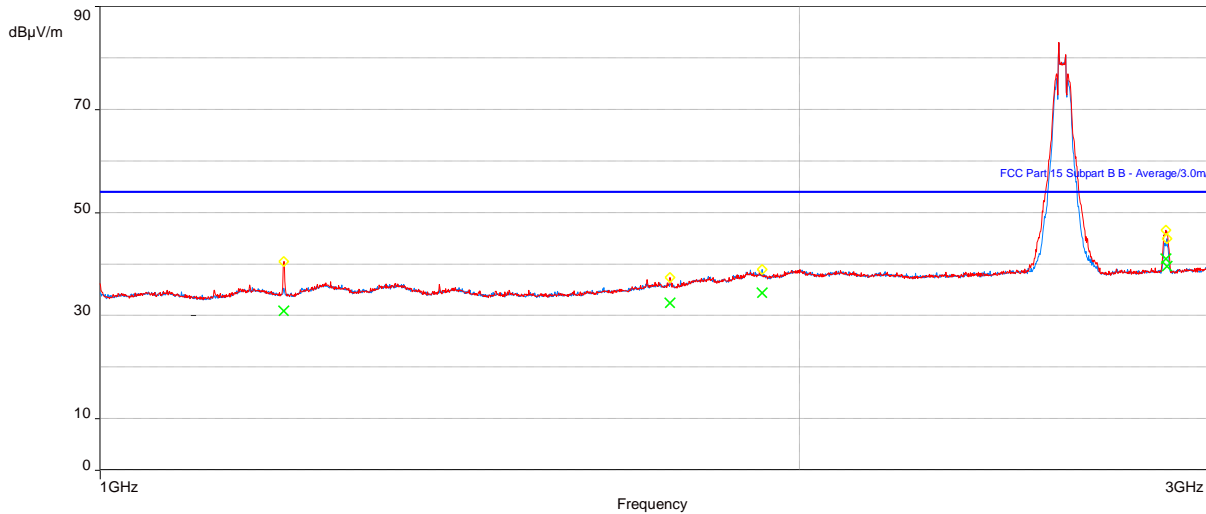

Note: Peak above the limit is leakage of the EUT’s fundamentals from the 50-ohm terminations.

Table 37: RE test results from 1 to 3 GHz for FCC Part 15 (NR – Middle channel)

Frequency (MHz)	Level Average (dBµV)	Limit Average (dBµV)	Margin to FCC part 15 Class B (dB)	Height (m)	Azimuth (degrees)	Polarization	Correction (dB)
1199.768556	30.86	53.96	-23.10	3.52	213.50	Vertical	-4.73
1759.6	32.37	53.96	-21.59	2.72	60.00	Vertical	-2.20
2876.508367	41.01	53.96	-12.95	1.46	320.25	Vertical	0.78
1927.888141	34.33	53.96	-19.63	1.00	360.00	Horizontal	-0.22

Table 38: RE test results from 1 to 3 GHz for FCC Part 27 (NR – Middle channel)

Frequency (MHz)	Level (dBµV)	Limit EIRP (dBµV)	Margin to EIRP Limit (dB)	Height (m)	Azimuth (deg)	Polarization	Correction (dB)
1199.768556	30.86	82.2	-51.34	3.52	213.50	Vertical	-4.73
1759.6	32.37	82.2	-49.83	2.72	60.00	Vertical	-2.20
2876.508367	41.01	82.2	-41.19	1.46	320.25	Vertical	0.78
1927.888141	34.33	82.2	-47.87	1.00	360.00	Horizontal	-0.22

Note: In the table/Plot above, no emissions exceeded the Part 27 radiated spurious emissions limit when converted to dBuV/m, except for the fundamental. For final spurious emissions measurements to FCC Part 27, see antenna port conducted emissions in applicable test report.

Figure 28: Plot of RE at 3m from 3 to 10 GHz (NR – Middle channel)

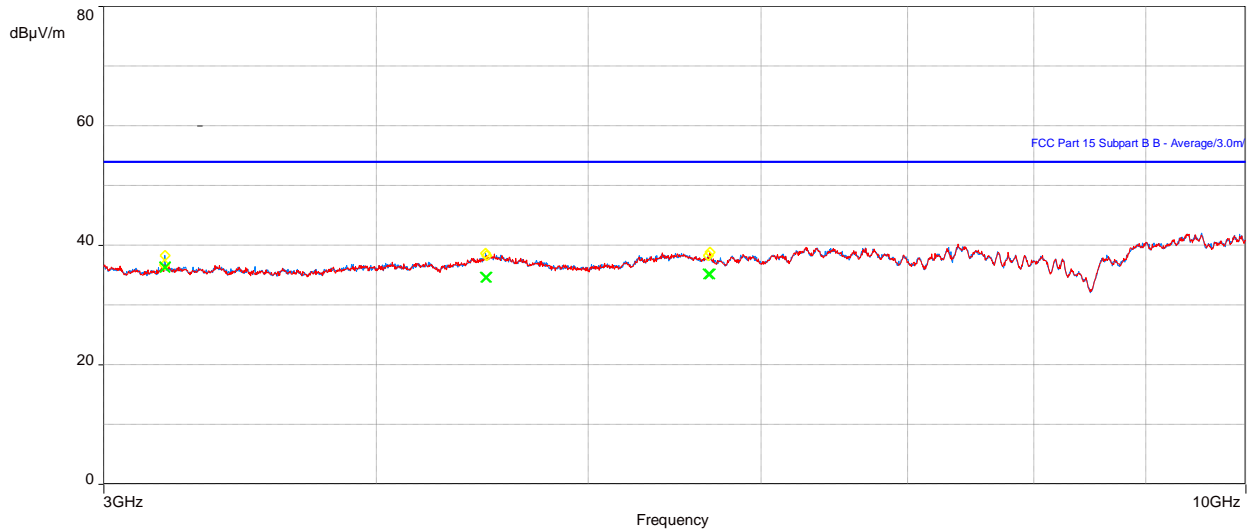

Table 39: RE test results from 3 to 10 GHz for FCC Part 15 (NR – Middle channel)

Frequency (MHz)	Level Average (dBµV)	Limit Average (dBµV)	Margin to FCC part 15 Class B (dB)	Height (m)	Azimuth (degrees)	Polarization	Correction (dB)
3199.980095	36.36	53.96	-17.60	1.04	84.25	Vertical	3.96
5686.519872	35.13	53.96	-18.83	3.17	140.75	Vertical	6.67
3199.977918	36.28	53.96	-17.68	2.01	156.00	Horizontal	3.96
5674.196441	35.15	53.96	-18.81	3.31	285.75	Horizontal	6.67

Table 40: RE test results from 3 to 10 GHz for FCC Part 27 (NR – Middle channel)

Frequency (MHz)	Level (dBµV)	Limit EIRP (dBµV)	Margin to EIRP Limit (dB)	Height (m)	Azimuth (deg)	Polarization	Correction (dB)
3199.980095	36.36	82.2	-45.84	1.04	84.25	Vertical	3.96
5686.519872	35.13	82.2	-47.07	3.17	140.75	Vertical	6.67
3199.977918	36.28	82.2	-45.92	2.01	156.00	Horizontal	3.96
5674.196441	35.15	82.2	-47.05	3.31	285.75	Horizontal	6.67

Note: In the table/Plot above, no emissions exceeded the Part 27 radiated spurious emissions limit when converted to dBuV/m, except for the fundamental. For final spurious emissions measurements to FCC Part 27, see antenna port conducted emissions in applicable test report.

Figure 29: Plot of RE at 3m from 10 to 18 GHz (NR – Middle channel)

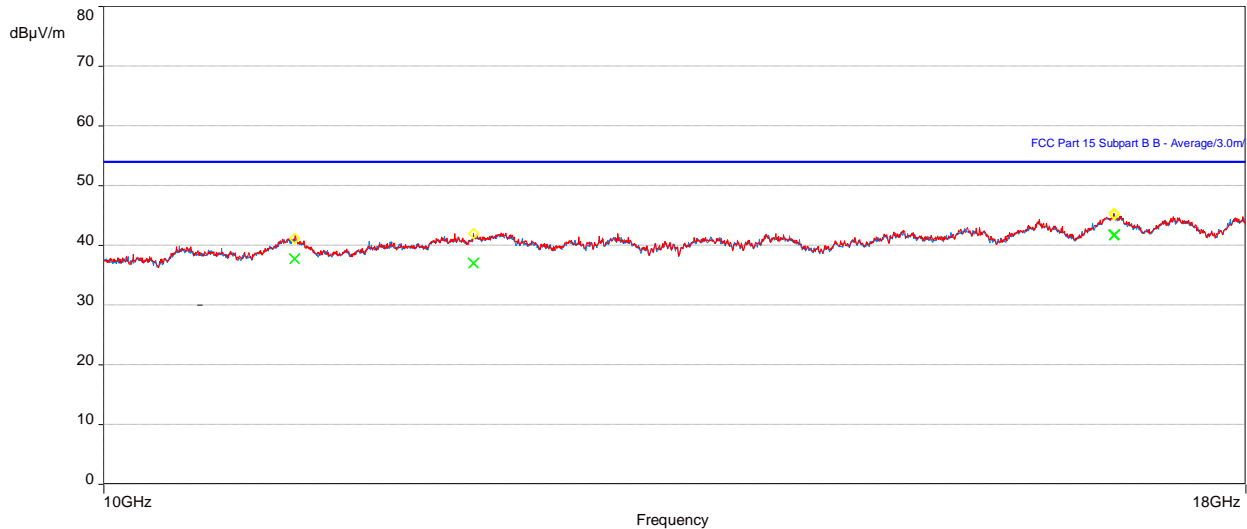

Table 41: RE test results from 10 to 18 GHz for FCC Part 15 (NR – Middle channel)

Frequency (MHz)	Level Average (dBµV)	Limit Average (dBµV)	Margin to FCC part 15 Class B (dB)	Height (m)	Azimuth (degrees)	Polarization	Correction (dB)
12098.00479	37.02	53.96	-16.94	1.00	2.25	Vertical	8.15
16818.70867	41.66	53.96	-12.30	1.00	362.00	Vertical	15.36
11032.25578	37.74	53.96	-16.22	3.93	360.25	Horizontal	8.52
16823.11827	41.77	53.96	-12.19	4.00	81.50	Horizontal	15.38

Table 42: RE test results from 10 to 18 GHz (NR – Middle channel)

Frequency (MHz)	Level (dBµV)	Limit EIRP (dBµV)	Margin to EIRP Limit (dB)	Height (m)	Azimuth (deg)	Polarization	Correction (dB)
12098.00479	37.02	82.2	-45.18	1.00	2.25	Vertical	8.15
16818.70867	41.66	82.2	-40.54	1.00	362.00	Vertical	15.36
11032.25578	37.74	82.2	-44.46	3.93	360.25	Horizontal	8.52
16823.11827	41.77	82.2	-40.43	4.00	81.50	Horizontal	15.38

Note: In the table/Plot above, no emissions exceeded the Part 27 radiated spurious emissions limit when converted to dBuV/m. For final spurious emissions measurements to FCC Part 27, see antenna port conducted emissions in applicable test report.

Figure 30: Plot of RE at 1m from 18 to 26.5 GHz (NR – Middle channel)

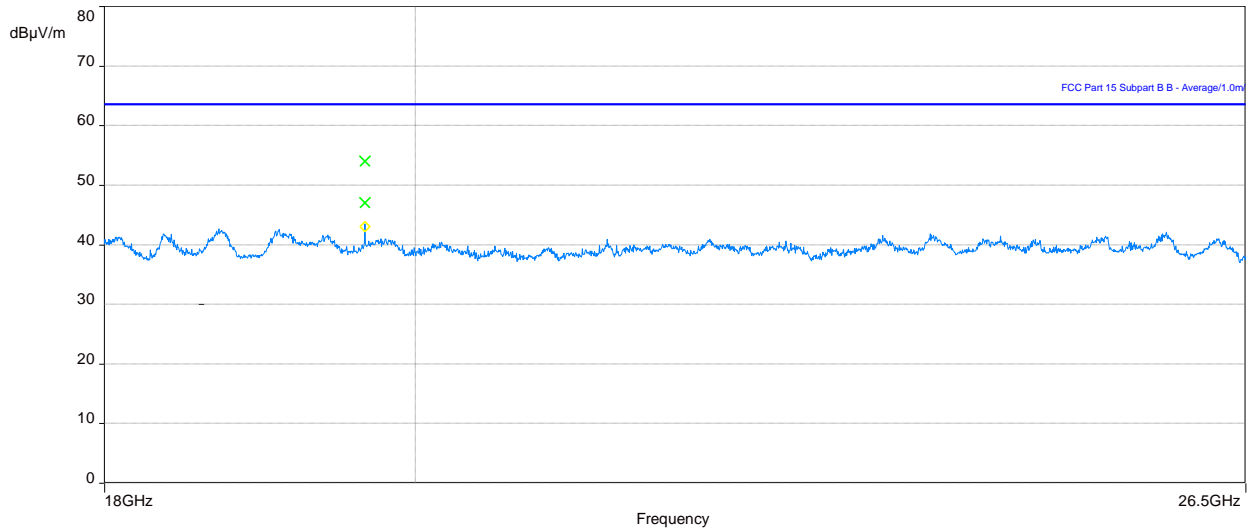

Note 1: In the plot above No Emissions exceeds the FCC Part 15 limit.

Note 2: In the plot above, no emissions exceed the Part 27 radiated spurious emissions limit when converted to dBuV/m. For final spurious emissions measurements to FCC Part 27, see antenna port conducted emissions in applicable test report.

Figure 31: Plot of RE at 1m from 26.5 to 40 GHz (NR – Middle channel)

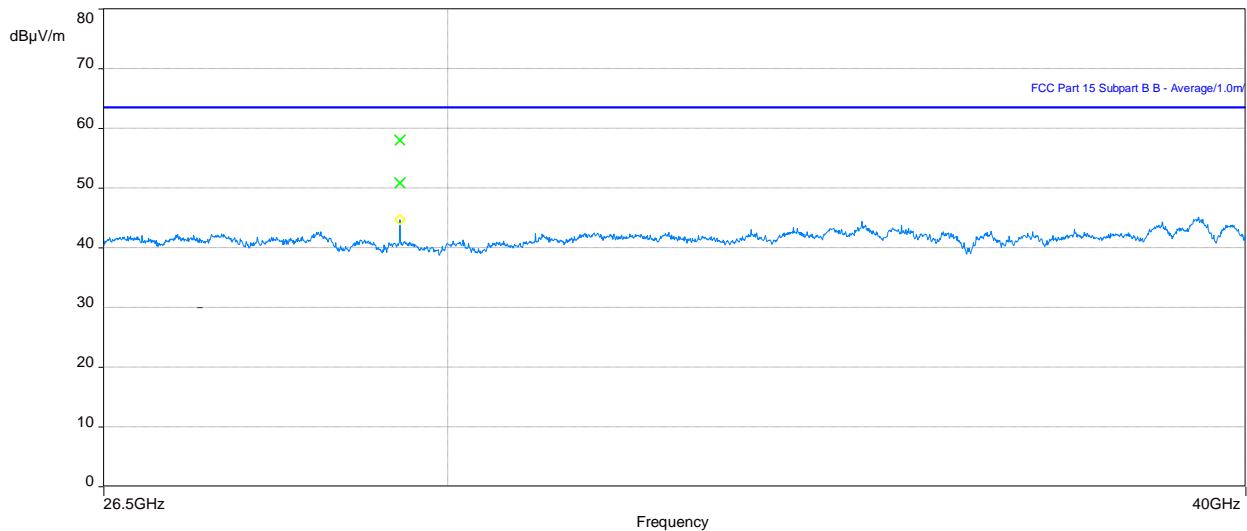

Note 1: In the plot above No Emissions exceeds the FCC Part 15 limit.

Note 2: In the plot above, no emissions exceed the Part 27 radiated spurious emissions limit when converted to dBuV/m. For final spurious emissions measurements to FCC Part 27, see antenna port conducted emissions in applicable test report.



3.2.9 Test results of RE – (Single RAT / Multi Carrier (LTE) – Mid channel)

Test location: 10-meter Ambient Free Chamber (AFC)

Date tested: 15 - 20 September 2021

Tested by: Steve Mcfarlane

Test configurations are listed as MC LTE in 2.4.1.3 as identified in the section [Configurations of the EUT](#). For the following test results that have supporting data tables, negative margin values indicate a pass.

Red trace – Vertical antenna polarity, **Blue trace** – Horizontal antenna polarity

Figure 32: Plot of RE at 3 m – 30 to 1000 MHz (MC LTE – Mid channel)

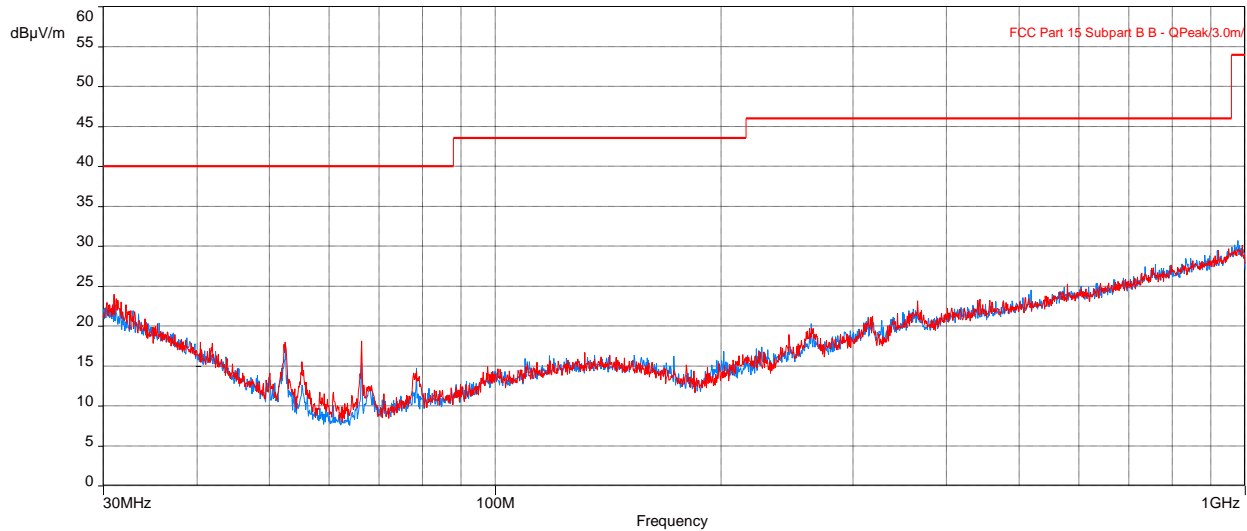

Table 43: RE test results from 30 to 1000 MHz for FCC Part 15 (MC LTE – Mid channel)

Frequency (MHz)	Level (dBµV)	Limit Quasi-peak (dBµV)	Margin to FCC part 15 Class B (dB)	Height (m)	Azimuth (deg)	Polarization	Correction (dB)
30.84739777	17.64	40.00	-22.36	3.54	105.75	Horizontal	-3.24
31.084667	18.88	40.00	-21.12	3.73	269.75	Vertical	-3.36
917.9455321	23.00	46.02	-23.02	1.90	177.75	Horizontal	4.56
921.3864838	22.83	46.02	-23.19	3.77	62.75	Vertical	4.62

Table 44: RE test results from 30 to 1000 MHz for FCC Part 27 (MC LTE – Mid channel)

Frequency (MHz)	Level (dBµV)	Limit EIRP (dBµV)	Margin to EIRP Limit (dB)	Height (m)	Azimuth (deg)	Polarization	Correction (dB)
30.84739777	17.64	82.2	-64.56	3.54	105.75	Horizontal	-3.24
31.084667	18.88	82.2	-63.32	3.73	269.75	Vertical	-3.36
917.9455321	23.00	82.2	-59.2	1.90	177.75	Horizontal	4.56
921.3864838	22.83	82.2	-59.37	3.77	62.75	Vertical	4.62

Note: In the table/Plot above, no emissions exceed the Part 27 radiated spurious emissions limit when converted to dBuV/m. For final spurious emissions measurements to FCC Part 27, see antenna port conducted emissions in applicable test report.

Figure 33: Plot of RE at 3m from 1 to 3 GHz (MC LTE – Mid channel)

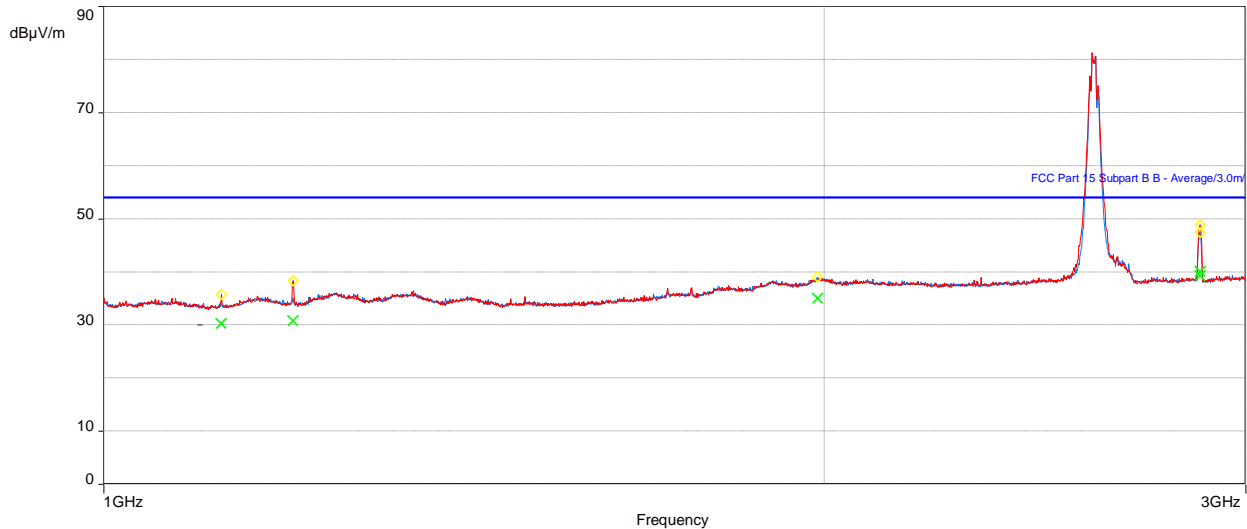

Note: Peak above the limit is leakage of the EUT’s fundamentals from the 50-ohm terminations.

Table 45: RE test results from 1 to 3 GHz for FCC Part 15 (MC LTE – Mid channel)

Frequency (MHz)	Level Average (dBµV)	Limit Average (dBµV)	Margin to FCC part 15 Class B (dB)	Height (m)	Azimuth (degrees)	Polarization	Correction (dB)
1199.917274	30.75	53.96	-23.21	3.45	120.00	Vertical	-4.73
2871.237787	40.03	53.96	-13.93	1.46	319.00	Vertical	0.78
1987.505162	34.99	53.96	-18.97	4.00	264.00	Horizontal	0.33
2871.240351	39.20	53.96	-14.76	1.00	326.25	Horizontal	0.78

Table 46: RE test results from 1 to 3 GHz for FCC Part 27 (MC LTE – Mid channel)

Frequency (MHz)	Level (dBµV)	Limit EIRP (dBµV)	Margin to EIRP Limit (dB)	Height (m)	Azimuth (deg)	Polarization	Correction (dB)
1199.917274	30.75	82.2	-51.45	3.45	120.00	Vertical	-4.73
2871.237787	40.03	82.2	-42.17	1.46	319.00	Vertical	0.78
1987.505162	34.99	82.2	-47.21	4.00	264.00	Horizontal	0.33
2871.240351	39.20	82.2	-43.0	1.00	326.25	Horizontal	0.78

Note: In the table/Plot above, no emissions exceed the Part 27 radiated spurious emissions limit when converted to dBuV/m, except for the fundamental. For final spurious emissions measurements to FCC Part 27, see antenna port conducted emissions in applicable test report.

Figure 34: Plot of RE at 3m from 3 to 10 GHz (MC LTE – Mid channel)

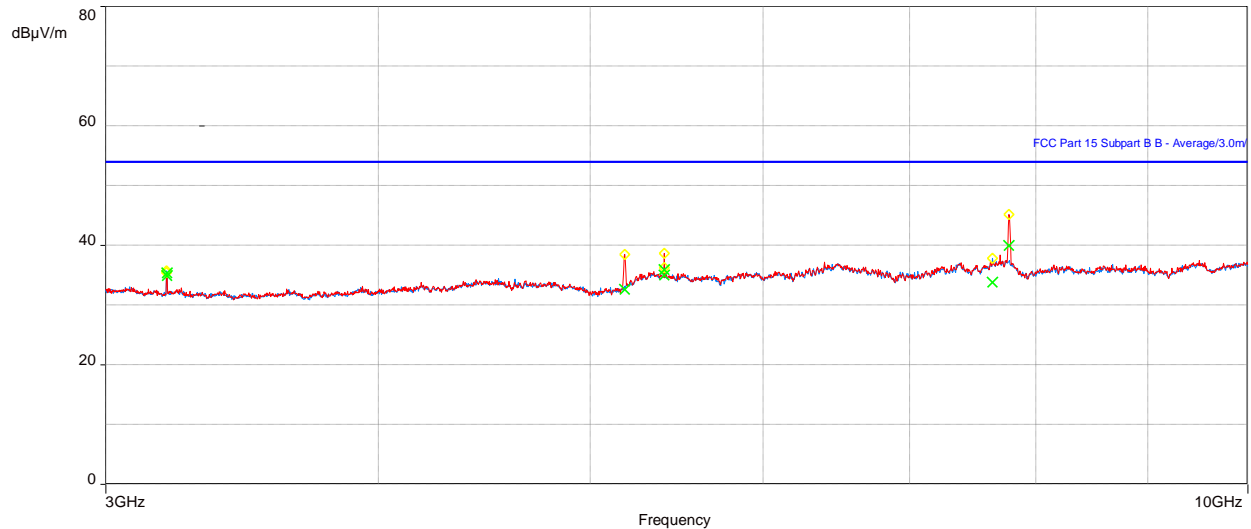

Table 47: RE test results from 3 to 10 GHz for FCC Part 15 (MC LTE – Mid channel)

Frequency (MHz)	Level Average (dBµV)	Limit Average (dBµV)	Margin to FCC part 15 Class B (dB)	Height (m)	Azimuth (degrees)	Polarization	Correction (dB)
5406.684936	35.90	53.96	-18.06	3.48	269.75	Vertical	-0.42
7777.066379	39.87	53.96	-14.09	3.27	10.50	Vertical	4.78
3199.980095	35.33	53.96	-18.63	2.42	163.25	Horizontal	-3.73
5406.684936	34.99	53.96	-18.97	2.08	183.25	Horizontal	-0.42

Table 48: RE test results from 3 to 10 GHz for FCC Part 27 (MC LTE – Mid channel)

Frequency (MHz)	Level (dBµV)	Limit EIRP (dBµV)	Margin to EIRP Limit (dB)	Height (m)	Azimuth (deg)	Polarization	Correction (dB)
5406.684936	35.90	82.2	-46.30	3.48	269.75	Vertical	-0.42
7777.066379	39.87	82.2	-42.33	3.27	10.50	Vertical	4.78
3199.980095	35.33	82.2	-46.87	2.42	163.25	Horizontal	-3.73
5406.684936	34.99	82.2	-47.21	2.08	183.25	Horizontal	-0.42

Note: In the table/Plot above, no emissions exceeded the Part 27 radiated spurious emissions limit when converted to dBuV/m, except for the fundamental. For final spurious emissions measurements to FCC Part 27, see antenna port conducted emissions in applicable test report.

Figure 35: Plot of RE at 3m from 10 to 18 GHz (MC LTE – Mid channel)

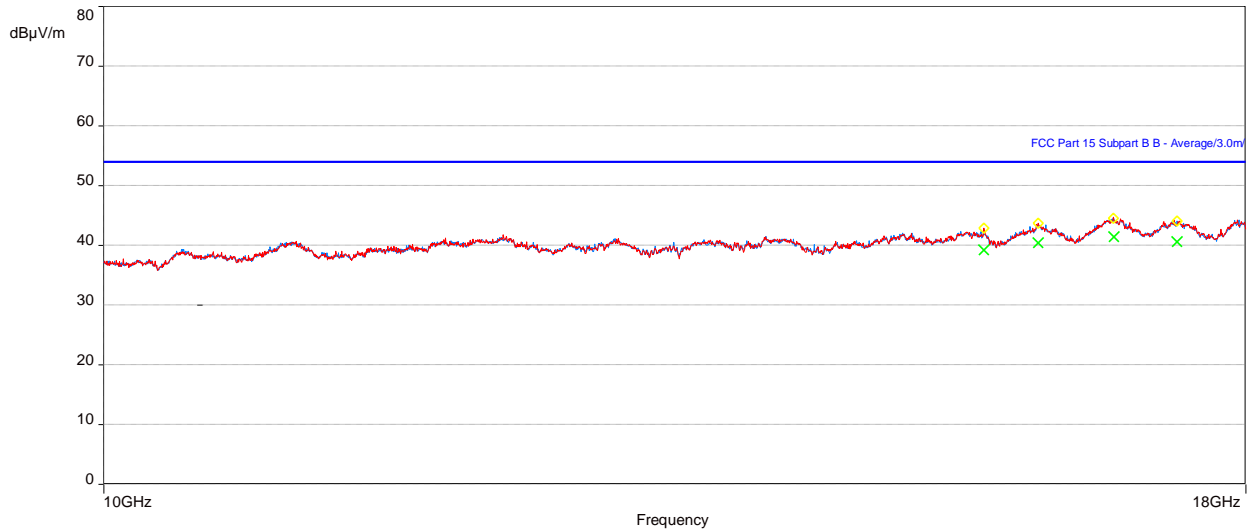

Table 49: RE test results from 10 to 18 GHz for FCC Part 15 (MC LTE – Mid channel)

Frequency (MHz)	Level Average (dBµV)	Limit Average (dBµV)	Margin to FCC part 15 Class B (dB)	Height (m)	Azimuth (degrees)	Polarization	Correction (dB)
15731.50706	39.19	53.96	-14.77	3.14	53.00	Vertical	14.87
16178.56283	40.36	53.96	-13.60	1.00	357.50	Vertical	14.85
16818.04168	41.40	53.96	-12.56	4.00	360.00	Horizontal	15.35
17375.74101	40.59	53.96	-13.37	4.00	0.25	Horizontal	15.19

Table 50: RE test results from 10 to 18 GHz (MC LTE – Mid channel)

Frequency (MHz)	Level (dBµV)	Limit EIRP (dBµV)	Margin to EIRP Limit (dB)	Height (m)	Azimuth (deg)	Polarization	Correction (dB)
15731.50706	39.19	82.2	-43.01	3.14	53.00	Vertical	14.87
16178.56283	40.36	82.2	-41.84	1.00	357.50	Vertical	14.85
16818.04168	41.40	82.2	-40.8	4.00	360.00	Horizontal	15.35
17375.74101	40.59	82.2	-41.61	4.00	0.25	Horizontal	15.19

Note: In the table/Plot above, no emissions exceeded the Part 27 radiated spurious emissions limit when converted to dBuV/m. For final spurious emissions measurements to FCC Part 27, see antenna port conducted emissions in applicable test report.



3.2.10 Test results of RE – (Multi RAT / Multi Carrier – Mid channel) – Cfg 1

Test location: 10-meter Ambient Free Chamber (AFC)

Date tested: 15 - 20 September 2021

Tested by: Steve Mcfarlane

Test configurations are listed as MR (LTE + NR) in 2.4.1.4 as identified in the section [Configurations of the EUT](#). For the following test results that have supporting data tables, negative margin values indicate a pass.

Red trace – Vertical antenna polarity, **Blue trace** – Horizontal antenna polarity

Figure 36: Plot of RE at 3 m from 30 to 1000 MHz (MR (LTE + NR) – Mid channel)

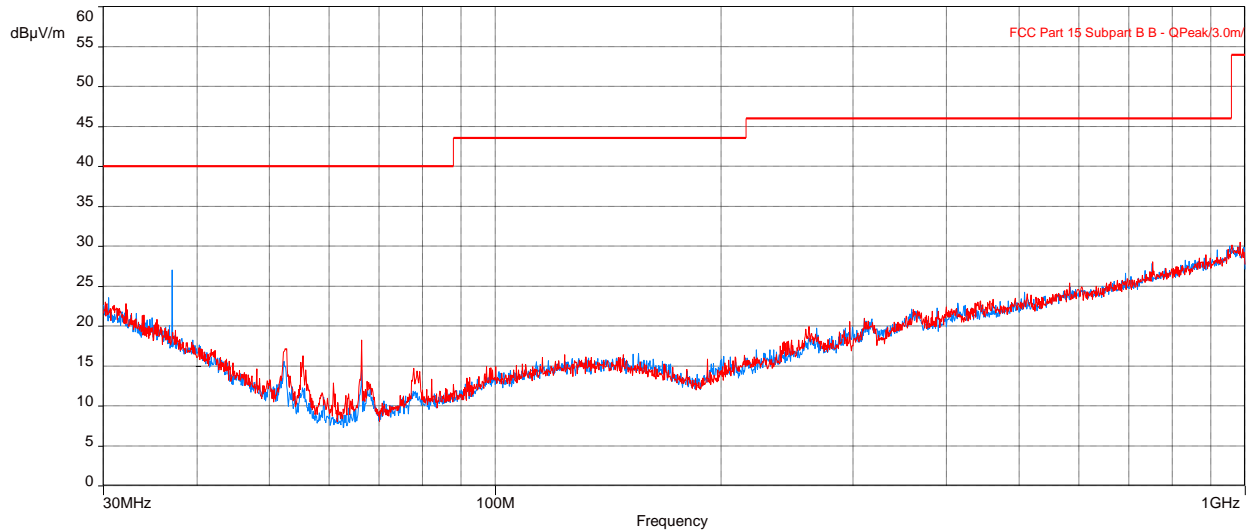

Table 51: RE test results from 30 to 1000 MHz for FCC Part 15 (MR (LTE + NR) – Mid channel)

Frequency (MHz)	Level (dBµV)	Limit Quasi-peak (dBµV)	Margin to FCC part 15 Class B (dB)	Height (m)	Azimuth (deg)	Polarization	Correction (dB)
32.18071828	17.25	40.00	-22.75	3.94	11.00	Vertical	-3.99
37.05808333	14.16	40.00	-25.84	3.58	196.75	Horizontal	-6.66
954.8964423	23.77	46.02	-22.25	1.21	348.25	Horizontal	5.69
961.2052885	24.15	53.98	-29.83	2.87	218.75	Vertical	6.03

Table 52: RE test results from 30 to 1000 MHz for FCC Part 27 (MR (LTE + NR) – Mid channel)

Frequency (MHz)	Level (dBµV)	Limit EIRP (dBµV)	Margin to EIRP Limit (dB)	Height (m)	Azimuth (deg)	Polarization	Correction (dB)
32.18071828	17.25	82.2	-64.95	3.94	11.00	Vertical	-3.99
37.05808333	14.16	82.2	-68.04	3.58	196.75	Horizontal	-6.66
954.8964423	23.77	82.2	-58.43	1.21	348.25	Horizontal	5.69
961.2052885	24.15	82.2	-58.05	2.87	218.75	Vertical	6.03

Note: In the table/Plot above, no emissions exceed the Part 27 radiated spurious emissions limit when converted to dBuV/m. For final spurious emissions measurements to FCC Part 27, see antenna port conducted emissions in applicable test report.

Figure 37: Plot of RE at 3m from 1 to 3 GHz (MR (LTE + NR) – Mid channel)

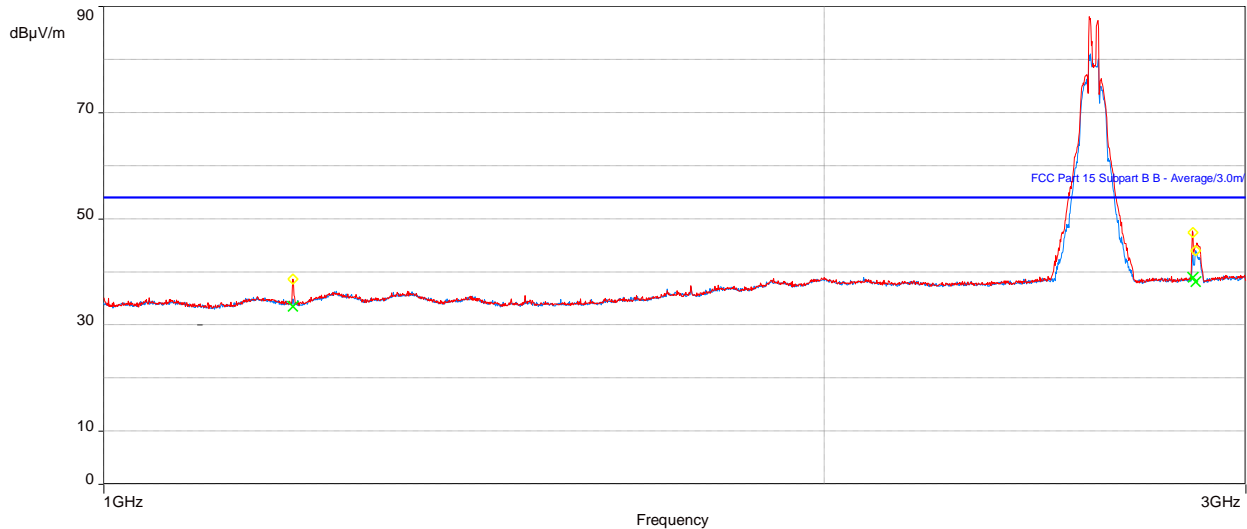

Note: Peak above the limit is leakage of the EUT’s fundamentals from the 50-ohm terminations.

Table 53: RE test results from 1 to 3 GHz for FCC Part 15 (MR (LTE + NR) – Mid channel)

Frequency (MHz)	Level Average (dBµV)	Limit Average (dBµV)	Margin to FCC part 15 Class B (dB)	Height (m)	Azimuth (degrees)	Polarization	Correction (dB)
1199.620226	33.45	53.96	-20.51	2.49	205.50	Vertical	-4.73
2852.549326	38.88	53.96	-15.08	1.46	319.25	Vertical	0.79
2859.375962	38.09	53.96	-15.87	1.00	326.75	Horizontal	0.79

Table 54: RE test results from 1 to 3 GHz for FCC Part 27 (MR (LTE + NR) – Mid channel)

Frequency (MHz)	Level (dBµV)	Limit EIRP (dBµV)	Margin to EIRP Limit (dB)	Height (m)	Azimuth (deg)	Polarization	Correction (dB)
1199.620226	33.45	82.2	-48.75	2.49	205.50	Vertical	-4.73
2852.549326	38.88	82.2	-43.32	1.46	319.25	Vertical	0.79
2859.375962	38.09	82.2	-44.11	1.00	326.75	Horizontal	0.79

Note: In the table/Plot above, no emissions exceed the Part 27 radiated spurious emissions limit when converted to dBuV/m, except for the fundamental. For final spurious emissions measurements to FCC Part 27, see antenna port conducted emissions in applicable test report.

Figure 38: Plot of RE at 3m from 3 to 10 GHz (MR (LTE + NR) – Mid channel)

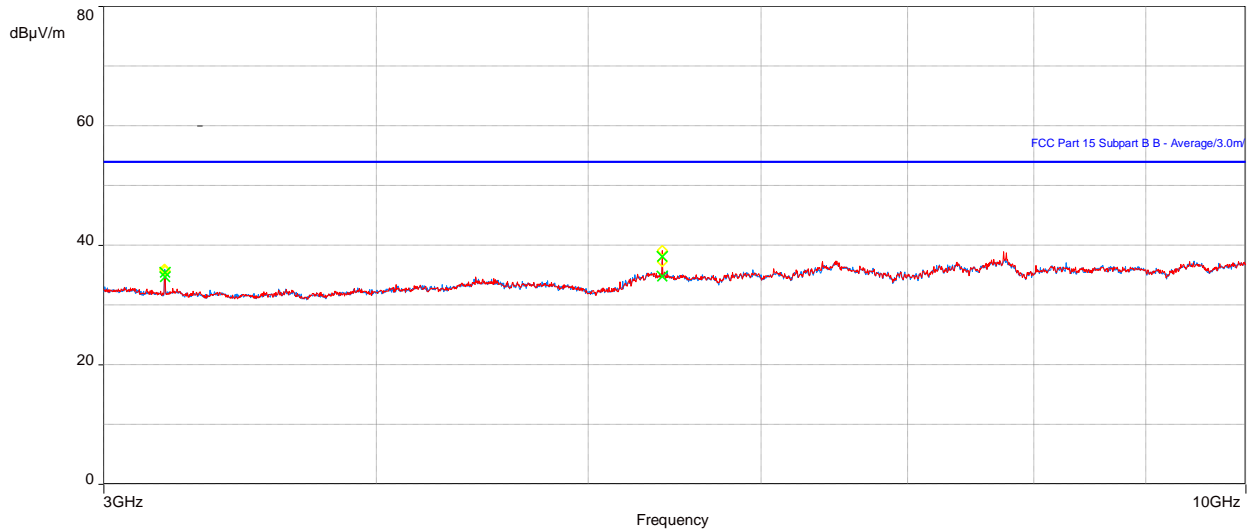

Table 55: RE test results from 3 to 10 GHz for FCC Part 15 (MR (LTE + NR) – Mid channel)

Frequency (MHz)	Level Average (dBµV)	Limit Average (dBµV)	Margin to FCC part 15 Class B (dB)	Height (m)	Azimuth (degrees)	Polarization	Correction (dB)
3199.979521	34.68	53.96	-19.28	1.25	91.50	Vertical	-3.73
5406.684936	38.07	53.96	-15.89	2.93	81.50	Vertical	-0.42
3199.980095	35.40	53.96	-18.56	2.42	163.50	Horizontal	-3.73
5406.684262	34.78	53.96	-19.18	3.27	357.50	Horizontal	-0.42

Table 56: RE test results from 3 to 10 GHz for FCC Part 27 (MR (LTE + NR) – Mid channel)

Frequency (MHz)	Level (dBµV)	Limit EIRP (dBµV)	Margin to EIRP Limit (dB)	Height (m)	Azimuth (deg)	Polarization	Correction (dB)
3199.979521	34.68	82.2	-47.52	1.25	91.50	Vertical	-3.73
5406.684936	38.07	82.2	-44.13	2.93	81.50	Vertical	-0.42
3199.980095	35.40	82.2	-46.8	2.42	163.50	Horizontal	-3.73
5406.684262	34.78	82.2	-47.42	3.27	357.50	Horizontal	-0.42

Note: In the table/Plot above, no emissions exceed the Part 27 radiated spurious emissions limit when converted to dBuV/m, except for the fundamental. For final spurious emissions measurements to FCC Part 27, see antenna port conducted emissions in applicable test report.

Figure 39: Plot of RE at 3m from 10 to 18 GHz (MR (LTE + NR) – Mid channel)

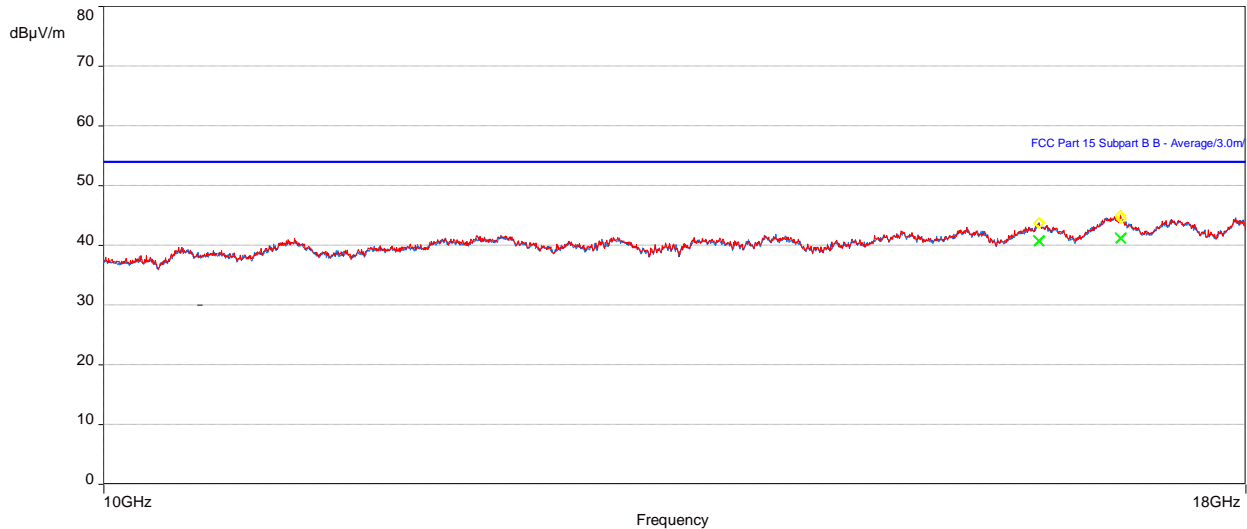

Table 57: RE test results from 10 to 18 GHz for FCC Part 15 (MR (LTE + NR) – Mid channel)

Frequency (MHz)	Level Average (dBµV)	Limit Average (dBµV)	Margin to FCC part 15 Class B (dB)	Height (m)	Azimuth (degrees)	Polarization	Correction (dB)
16182.72146	40.75	53.96	-13.21	3.52	285.50	Vertical	14.94
16879.60322	41.19	53.96	-12.77	3.14	-1.75	Vertical	15.56
16882.75354	41.08	53.96	-12.88	4.00	104.25	Horizontal	15.56

Table 58: RE test results from 10 to 18 GHz (MR (LTE + NR) – Mid channel)

Frequency (MHz)	Level (dBµV)	Limit EIRP (dBµV)	Margin to EIRP Limit (dB)	Height (m)	Azimuth (deg)	Polarization	Correction (dB)
16182.72146	40.75	82.2	-41.45	3.52	285.50	Vertical	14.94
16879.60322	41.19	82.2	-41.01	3.14	-1.75	Vertical	15.56
16882.75354	41.08	82.2	-41.12	4.00	104.25	Horizontal	15.56

Note: In the table/Plot above, no emissions exceed the Part 27 radiated spurious emissions limit when converted to dBuV/m. For final spurious emissions measurements to FCC Part 27, see antenna port conducted emissions in applicable test report.

Figure 40: Plot of RE at 1m from 18 to 26.5 GHz (MR (LTE + NR) – Mid channel)

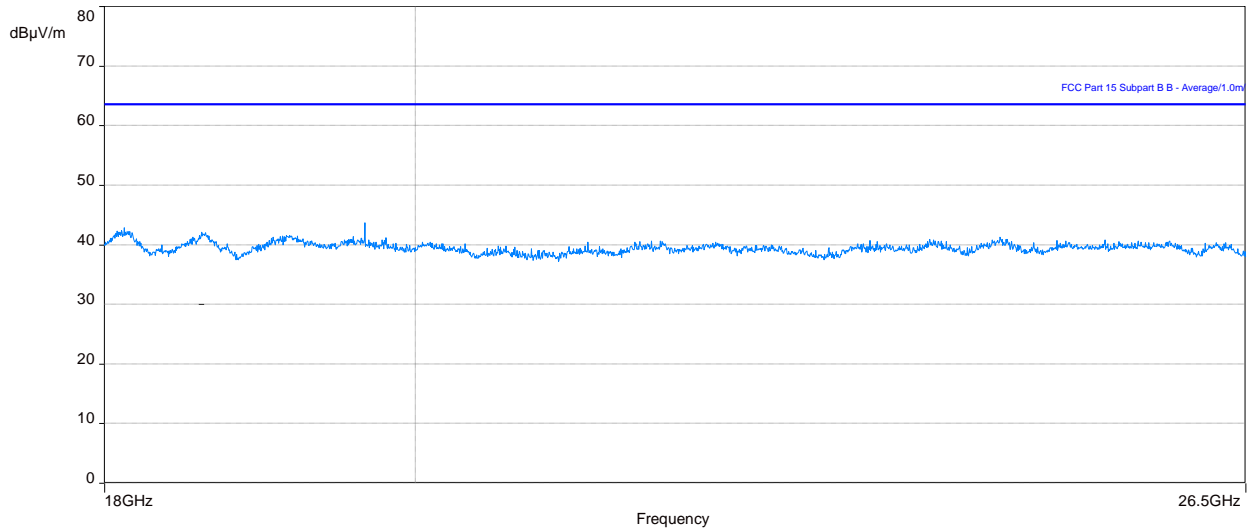

Note 1: In the plot above No Emissions exceeds the FCC Part 15 limit.

Note 2: In the plot above, no emissions exceed the Part 27 radiated spurious emissions limit when converted to dBuV/m. For final spurious emissions measurements to FCC Part 27, see antenna port conducted emissions in applicable test report.

Figure 41: Plot of RE at 1m from 26.5 to 40 GHz (MR (LTE + NR) – Mid channel)

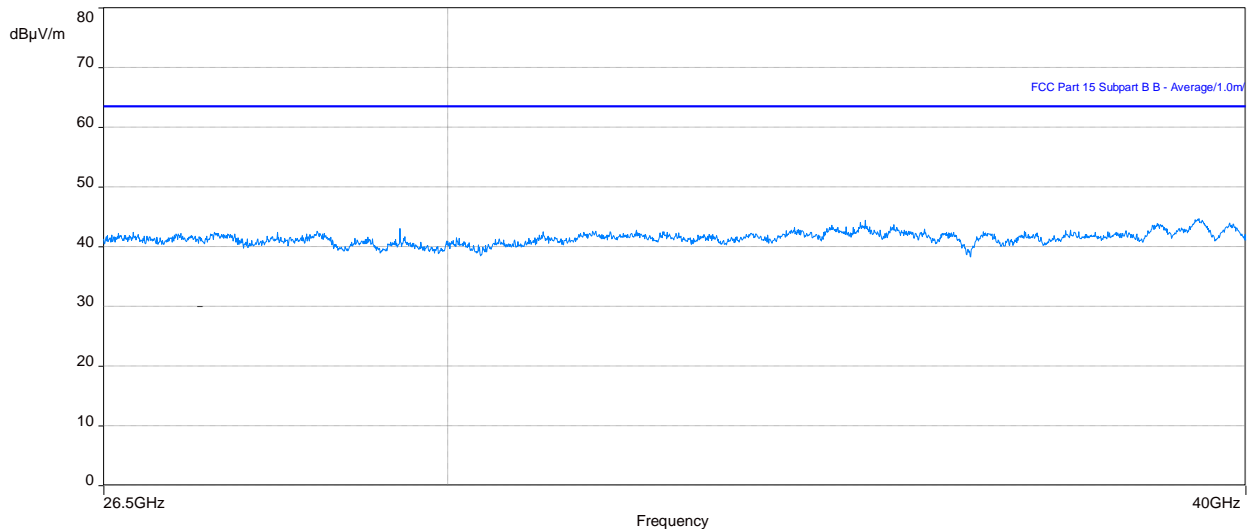

Note 1: In the plot above No Emissions exceeds the FCC Part 15 limit.

Note 2: In the plot above, no emissions exceed the Part 27 radiated spurious emissions limit when converted to dBuV/m. For final spurious emissions measurements to FCC Part 27, see antenna port conducted emissions in applicable test report.



3.2.11 Test results of RE – (Multi RAT / Multi Carrier – Mid channel) – Cfg 2

Test location: 10-meter Ambient Free Chamber (AFC)

Date tested: 15 - 20 September 2021

Tested by: Steve Mcfarlane

Test configurations are listed as MR (LTE + NR) in 2.4.2.1 as identified in the section [Configurations of the EUT](#). For the following test results that have supporting data tables, negative margin values indicate a pass.

Red trace – Vertical antenna polarity, **Blue trace** – Horizontal antenna polarity

Figure 42: Plot of RE at 3 m from 30 to 1000 MHz (MR (LTE + NR) – Mid ch) – Cfg 2

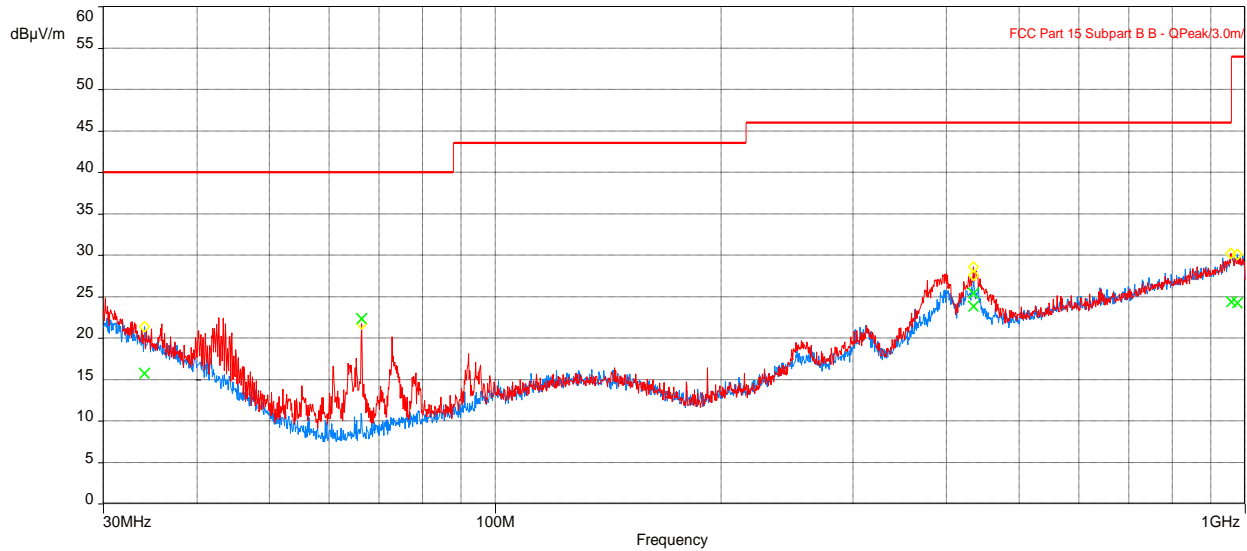

Table 59: RE test results from 30 to 1000 MHz for FCC Part 15 (MR (LTE + NR) – Mid ch)- Cfg 2

Frequency (MHz)	Level (dBµV)	Limit Quasi-peak (dBµV)	Margin to FCC part 15 Class B (dB)	Height (m)	Azimuth (deg)	Polarization	Correction (dB)
66.35676956	22.31	40.00	-17.69	1.56	240.00	Vertical	-16.35
434.8243877	25.41	46.02	-20.61	1.14	268.75	Vertical	-3.59
958.3718174	24.35	46.02	-21.67	1.65	327.75	Vertical	5.91
34.04935931	15.71	40.00	-24.29	3.27	74.50	Horizontal	-5.00

Table 60: RE test results from 30 to 1000 MHz for FCC Part 27 (MR (LTE + NR) – Mid ch) – Cfg 2

Frequency (MHz)	Level (dBµV)	Limit EIRP (dBµV)	Margin to EIRP Limit (dB)	Height (m)	Azimuth (deg)	Polarization	Correction (dB)
66.35676956	22.31	82.2	-59.89	1.56	240.00	Vertical	-16.35
434.8243877	25.41	82.2	-56.79	1.14	268.75	Vertical	-3.59
958.3718174	24.35	82.2	-57.85	1.65	327.75	Vertical	5.91
34.04935931	15.71	82.2	-66.49	3.27	74.50	Horizontal	-5.00

Note: In the table/Plot above, no emissions exceed the Part 27 radiated spurious emissions limit when converted to dBuV/m. For final spurious emissions measurements to FCC Part 27, see antenna port conducted emissions in applicable test report.

Figure 43: Plot of RE at 3m from 1 to 3 GHz (MR (LTE + NR) – Mid ch) – Cfg 2

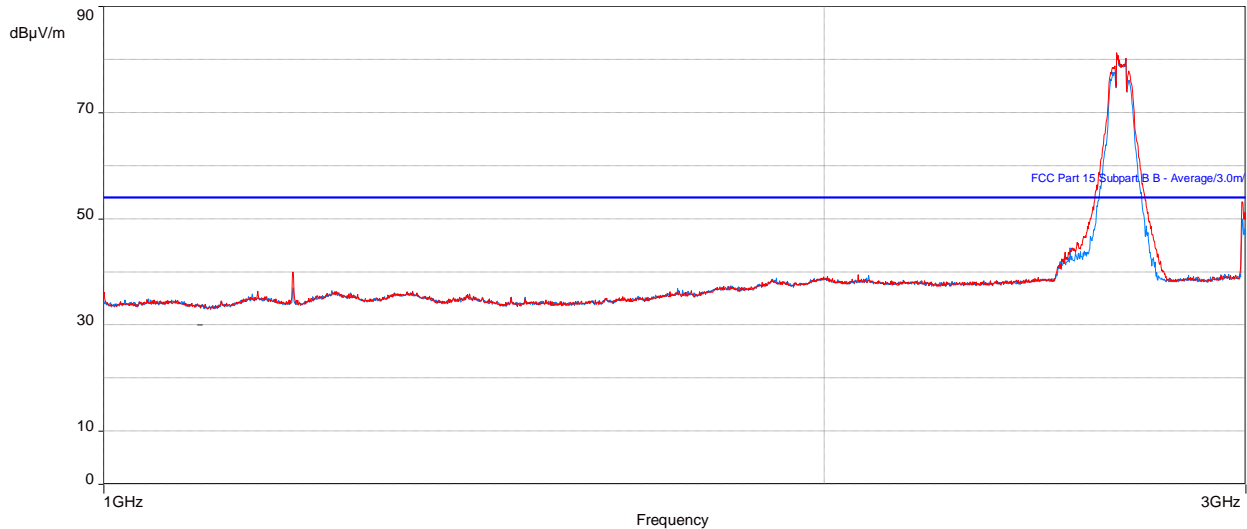

Note: Peak above the limit is leakage of the EUT’s fundamentals from the 50-ohm terminations.

Table 61: RE test results from 1 to 3 GHz for FCC Part 15 (MR (LTE + NR) – Mid ch) – Cfg 2

Frequency (MHz)	Level Average (dBµV)	Limit Average (dBµV)	Margin to FCC part 15 Class B (dB)	Height (m)	Azimuth (degrees)	Polarization	Correction (dB)
1199.928492	34.82	53.96	-19.14	2.55	335.75	Vertical	-4.73
2991.291346	46.44	53.96	-7.52	2.79	248.25	Vertical	1.14
2533.155736	37.91	53.96	-16.05	3.89	225.75	Horizontal	0.74
2990.346154	41.87	53.96	-12.09	1.39	232.75	Horizontal	1.14

Table 62: RE test results from 1 to 3 GHz for FCC Part 27 (MR (LTE + NR) – Mid ch) – Cfg 2

Frequency (MHz)	Level (dBµV)	Limit EIRP (dBµV)	Margin to EIRP Limit (dB)	Height (m)	Azimuth (deg)	Polarization	Correction (dB)
1199.928492	34.82	53.96	-19.14	2.55	335.75	Vertical	-4.73
2991.291346	46.44	53.96	-7.52	2.79	248.25	Vertical	1.14
2533.155736	37.91	53.96	-16.05	3.89	225.75	Horizontal	0.74
2990.346154	41.87	53.96	-12.09	1.39	232.75	Horizontal	1.14

Note: In the table/Plot above, no emissions exceed the Part 27 radiated spurious emissions limit when converted to dBuV/m, except for the fundamental. For final spurious emissions measurements to FCC Part 27, see antenna port conducted emissions in applicable test report.

Figure 44: Plot of RE at 3m from 3 to 10 GHz (MR (LTE + NR) – Mid ch) – Cfg 2

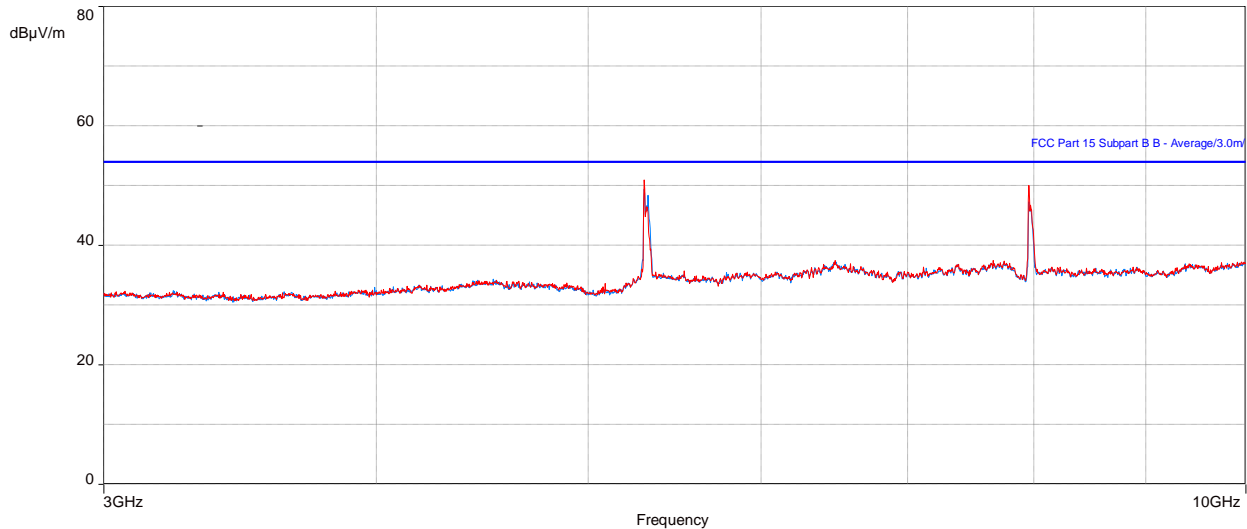

Table 63: RE test results from 3 to 10 GHz for FCC Part 15 (MR (LTE + NR) – Mid ch) – Cfg 2

Frequency (MHz)	Level Average (dBµV)	Limit Average (dBµV)	Margin to FCC part 15 Class B (dB)	Height (m)	Azimuth (degrees)	Polarization	Correction (dB)
5303.267628	31.83	53.96	-22.13	3.48	170.50	Horizontal	-0.90
5304.756697	35.94	53.96	-18.02	2.42	206.50	Vertical	-0.89
7958.181731	31.32	53.96	-22.64	3.75	69.75	Horizontal	3.15
7958.713462	37.27	53.96	-16.69	2.21	268.75	Vertical	3.15

Table 64: RE test results from 3 to 10 GHz for FCC Part 27 (MR (LTE + NR) – Mid ch) – Cfg 2

Frequency (MHz)	Level (dBµV)	Limit EIRP (dBµV)	Margin to EIRP Limit (dB)	Height (m)	Azimuth (deg)	Polarization	Correction (dB)
5303.267628	31.83	82.2	-50.37	3.48	170.50	Horizontal	-0.90
5304.756697	35.94	82.2	-46.26	2.42	206.50	Vertical	-0.89
7958.181731	31.32	82.2	-50.88	3.75	69.75	Horizontal	3.15
7958.713462	37.27	82.2	-44.93	2.21	268.75	Vertical	3.15

Note: In the table/Plot above, no emissions exceed the Part 27 radiated spurious emissions limit when converted to dBuV/m, except for the fundamental. For final spurious emissions measurements to FCC Part 27, see antenna port conducted emissions in applicable test report.

Figure 45: Plot of RE at 3m from 10 to 18 GHz (MR (LTE + NR) – Mid ch) – Cfg 2

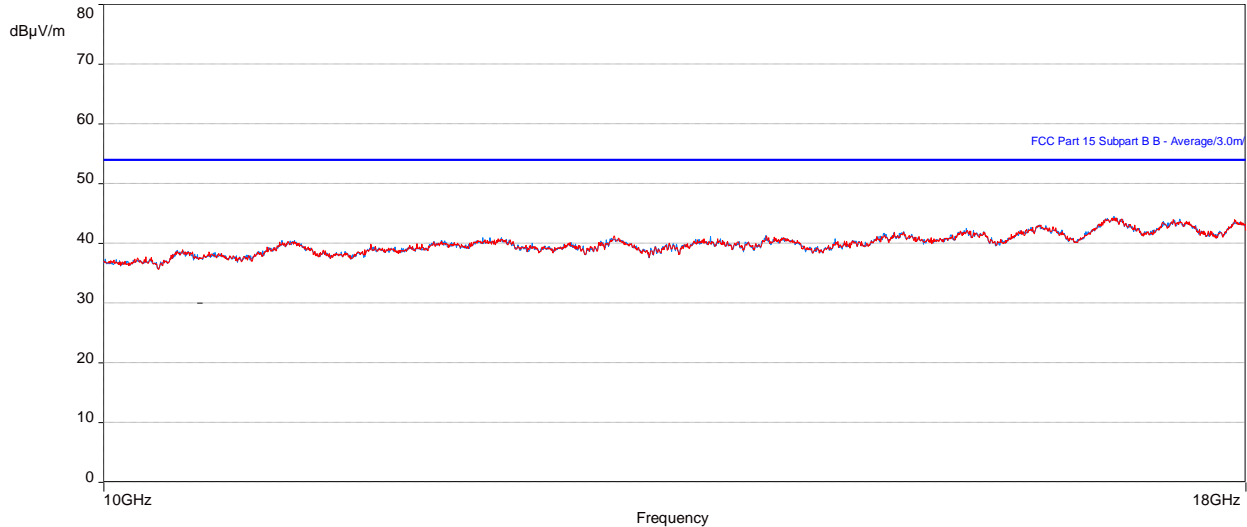

Table 65: RE test results from 10 to 18 GHz for FCC Part 15 (MR (LTE + NR) – Mid ch) – Cfg 2

Frequency (MHz)	Level Average (dBµV)	Limit Average (dBµV)	Margin to FCC part 15 Class B (dB)	Height (m)	Azimuth (degrees)	Polarization	Correction (dB)
16804.817	41.22	53.96	-12.74	1.94	75.75	Vertical	14.82
16821.36185	41.07	53.96	-12.89	1.94	357.25	Horizontal	14.87
17896.8	40.84	53.96	-13.12	1.00	343.00	Vertical	14.84
17896.98367	40.92	53.96	-13.04	1.87	31.25	Horizontal	14.84

Table 66: RE test results from 10 to 18 GHz (MR (LTE + NR) – Mid ch) – Cfg 2

Frequency (MHz)	Level (dBµV)	Limit EIRP (dBµV)	Margin to EIRP Limit (dB)	Height (m)	Azimuth (deg)	Polarization	Correction (dB)
16804.817	41.22	82.2	-40.98	1.94	75.75	Vertical	14.82
16821.36185	41.07	82.2	-41.13	1.94	357.25	Horizontal	14.87
17896.8	40.84	82.2	-41.36	1.00	343.00	Vertical	14.84
17896.98367	40.92	82.2	-41.28	1.87	31.25	Horizontal	14.84

Note: In the table/Plot above, no emissions exceeded the Part 27 radiated spurious emissions limit when converted to dBuV/m. For final spurious emissions measurements to FCC Part 27, see antenna port conducted emissions in applicable test report.

Figure 46: Plot of RE at 1m from 18 to 26.5 GHz (MR (LTE + NR) – Mid ch) – Cfg 2

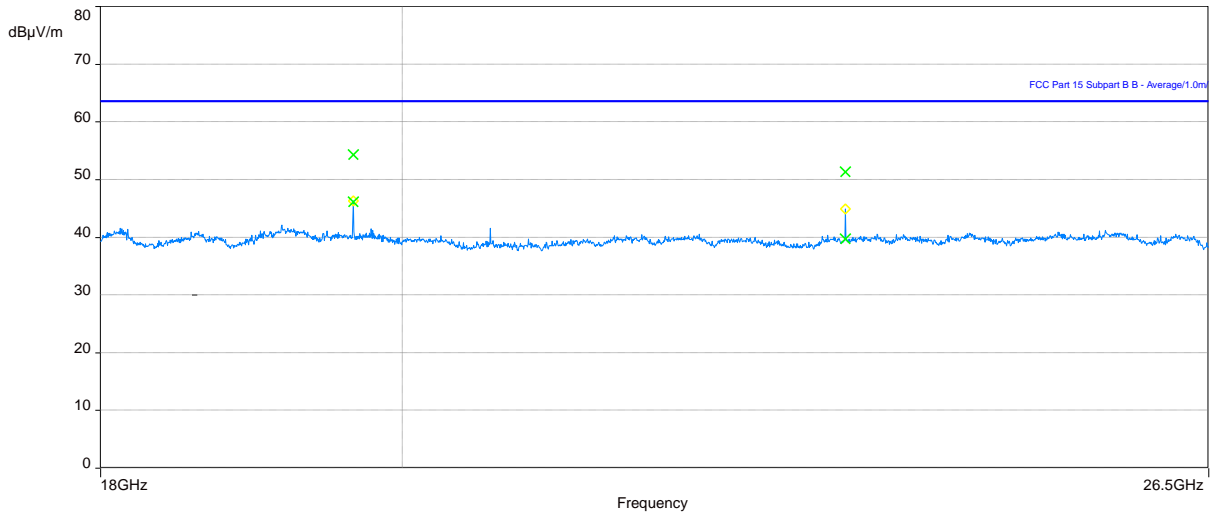

Note 1: In the plot above No Emissions exceeds the FCC Part 15 limit.

Note 2: In the plot above, no emissions exceed the Part 27 radiated spurious emissions limit when converted to dBuV/m. For final spurious emissions measurements to FCC Part 27, see antenna port conducted emissions in applicable test report.

Figure 47: Plot of RE at 1m from 26.5 to 40 GHz (MR (LTE + NR) – Mid ch) – Cfg 2

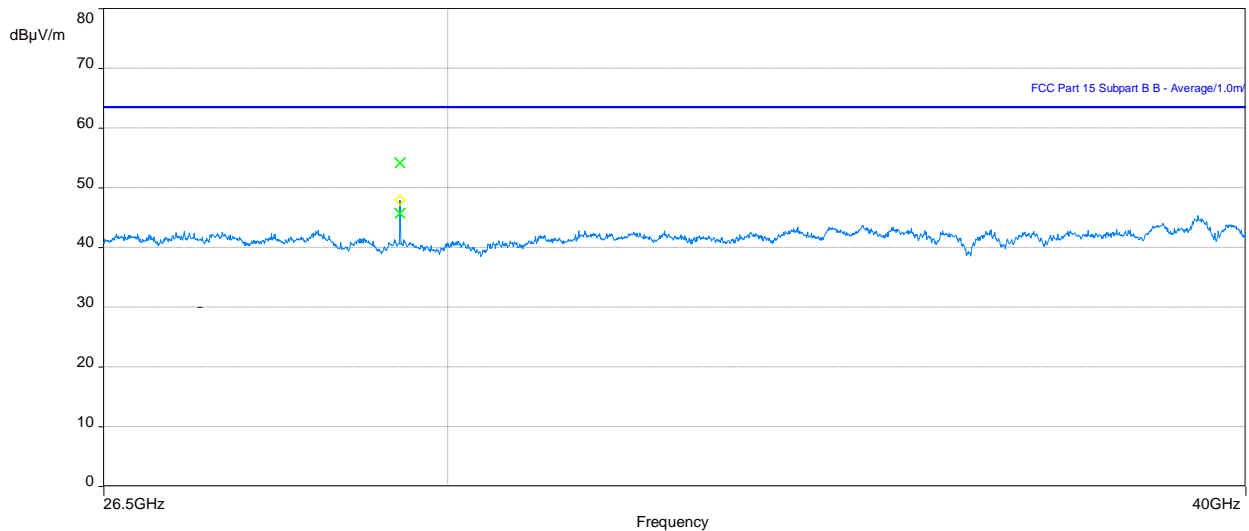

Note 1: In the plot above No Emissions exceeds the FCC Part 15 limit.

Note 2: In the plot above, no emissions exceed the Part 27 radiated spurious emissions limit when converted to dBuV/m. For final spurious emissions measurements to FCC Part 27, see antenna port conducted emissions in applicable test report.

3.2.12 Radiated Emissions test setup pictures

Figure 48: Setup for RE tests - Close up (Configuration 1)



Figure 49: Setup for RE tests - Close up (Configuration 2)



Figure 50: Setup for RE tests at 30 MHz to 1 GHz – Configuration 1

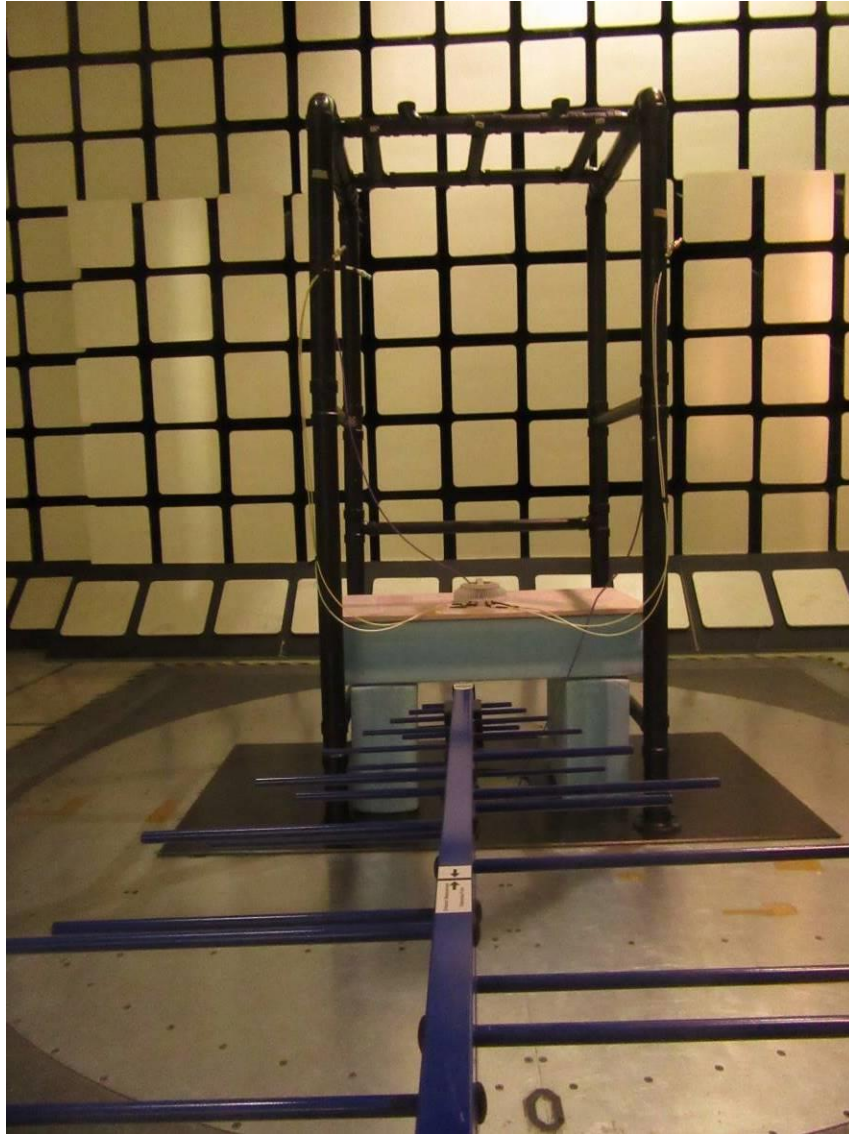
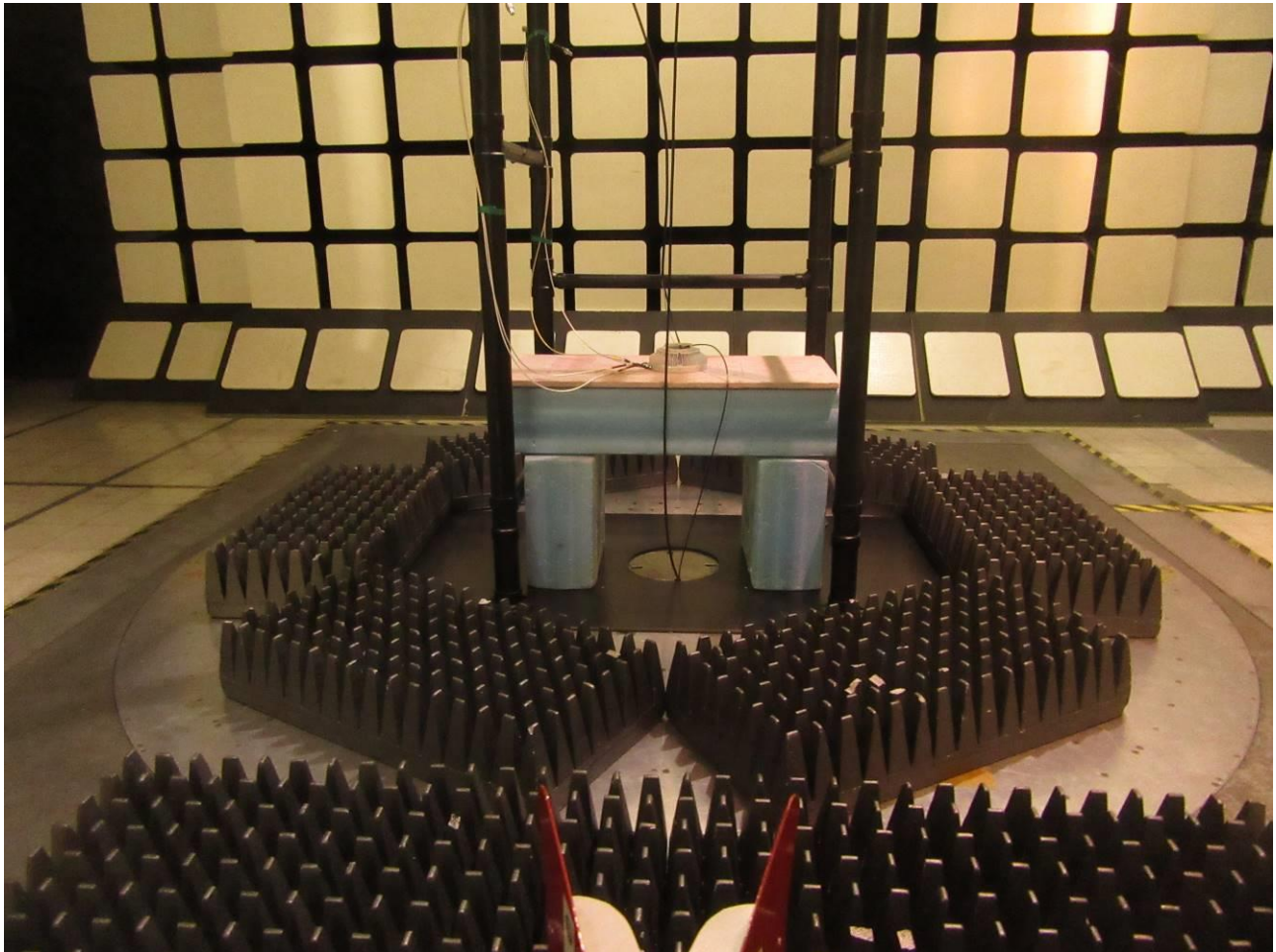

Figure 51: Setup for RE tests for above 1 GHz – Configuration 2





3.2.13 Test equipment

The equipment used for E-field RE testing was as follows.

Table 67: Test equipment used for RE

Description	Make	Model number	Asset ID	Calibr. date	Calibr. due
EMC Automation Software	Nexio V3.18	BAT-EMC	F0163649	Not required	Not required
EMI Receiver	Rohde & Schwarz	ESU26	SSG013729	2021-03-31	2022-03-31
RF Amplifier	Hewlett Packard	8447D	SSG013045	2021-01-29	2022-01-29
Coaxial Cable	Huber & Suhner	104PEA	SSG012041	2021-01-05	2022-01-05
Coaxial Cable	Huber & Suhner	106A	SSG012711	2021-01-05	2022-01-05
Coaxial Cable	Huber & Suhner	106A	SSG013841	2021-01-05	2022-01-05
Bilog Antenna	TESEQ	CBL 6111D	SSG013965	2021-05-04	2022-05-04
EMI Receiver	Rohde & Schwarz	ESU40	SSG013672	2020-10-29	2021-10-29
Horn Antenna 3MCH 00003	ETS	3117	LAVE04211	2021-03-30	2022-03-30
Pre-Amplifier	BNR	LNA	SSG012360	2020-11-16	2021-11-16
Coaxial Cable	Micro-Coax	UFA 210B-1-1500-504504	SSG012376	2021-01-06	2022-01-06
Coaxial Cable	Huber & Suhner	ST18/Nm/Nm/36	SSG012786	2021-01-05	2022-01-05
Coaxial Cable	Huber & Suhner	101 PEA, Sucoflex	SSG012290	2020-11-04	2022-11-04
Horn Antenna (18 - 26.5 GHz)	Emco	3160-09	SSG012292	2019-08-26	2021-11-26
Horn Antenna (26.5 - 40 GHz)	Emco	3160-10	SSG012294	2019-08-26	2021-11-26

3.2.14 Test conclusion

The DOT 4459 B41K (KRY 901 502/1) and DOT 4469 B41K (KRY 901 502/2) have passed the E-field Radiated Emission (RE) tests with respect to the Class B limits of FCC Part 15 Subpart B and FCC Part 27 section 27.53(m)(2).

4. References

The documents, regulations, and standards that are referenced throughout this test report are listed alphabetically as follows.

1. ANSI C63.2-2009, American National Standards Institute for Electromagnetic Noise and Field Strength Instrumentation, 10 Hz to 40 GHz – Specifications.
2. ANSI C63.4-2014, American National Standards Institute for Methods of Measurement of Radio-Noise Emission from Low-Voltage Electrical and Electronic Equipment in the Range of 9 kHz to 40 GHz.
3. CISPR 16 Publications (all parts and sections), Specification for Radio Disturbance and Immunity Measuring Apparatus and Methods - Part 1: Radio Disturbance and Immunity Measuring Apparatus.
4. CISPR 22 (2008, +IS 1, + IS 2, + IS 3: 2012), Information technology equipment - Radio disturbance characteristics - Limits and methods of measurement.
5. FCC Rules for Radio Frequency Devices, Title 47 of the Code of Federal Regulations, Part 2, U.S. Federal Communications Commission.
6. FCC Rules for Radio Frequency Devices, Title 47 of the Code of Federal Regulations, Part 15 Radio Frequency Devices, U.S. Federal Communications Commission.
7. FCC Rules for Radio Frequency Devices, Title 47 of the Code of Federal Regulations, Part 27 Miscellaneous Wireless Communications Services, U.S. Federal Communications Commission.

4.1 Appendix A: Abbreviations

The abbreviations of terms used in this document are as follows.

Term	Definition
A	6 dB Coaxial Attenuator (Conducted Immunity)
AAN	Asymmetric Artificial Network (ISN)
AE	Auxiliary equipment
AFC	Ambient Free Chamber
AM	Amplitude modulation
ANSI	American National Standards Institute
AVG	Average detector
BiLog	Biconical Log-Periodic Hybrid antenna (a registered trademark of Schaffner-Chase EMC Limited, 1993)
CC	RF Current Clamp
CCC	Capacitive Coupling Clamp
CDN	Coupling-decoupling Network
CE	Conducted Emissions
CI	Conducted Immunity
CISPR	Comité International Spécial Perturbation Radioélectrique (International Special Committee on Radio Interference)
CP	RF Current Probe
CSA	Canadian Standards Association
DI	Direct Injection
DN/P	Decoupling / Protection Network
EFT	Electrical Fast Transient
EFT/B	Electrical Fast Transient / Burst Generator
EMC	Electromagnetic Compatibility
EMI	Electromagnetic Interference
ESD	Electrostatic Discharge
ETSI	European Telecommunications Standards Institute
EUT	equipment under test
GND	Ground
HCP	Horizontal Coupling Plane
HME	Harmonics Measurement Equipment
HV	High Voltage
HVP	High Voltage Probe



Term	Definition
h/w	hardware
IC	Industry Canada
ICES	Canadian Specification: ICES-003, Issue 3, "Spectrum Management: Interference-causing equipment standard (Digital Apparatus)
IEC	International Electro Technical Association
ISN	Impedance Stabilization Network
LISN	Line Impedance Stabilization Network
ms	millisecond, unless otherwise specified
NA, na	not applicable
PA	Broadband Power Amplifier
PK	Peak Detector
PS	Power Supply
QP	Quasi-peak Detector
QPA	Quasi-peak Adapter (for the Spectrum Analyzer)
R	100-ohm Injection Resistor (Conducted Immunity)
RBW	Resolution Bandwidth
RE	Radiated Emissions
RF	Radio-Frequency
RI	Radiated Immunity
RMS	Root-mean-square
s/w	software
SA	Spectrum Analyzer, the CISPR 16, ANSI C63.2 Compliant EMI meter
SG	RF Signal Generator
SGen	Surge Generator
STP	Shielded Twisted Pair
T	50-ohm Coaxial Termination (Conducted Emissions / Immunity)
TL	Transient Limiter
UFA	Uniform field Area
VBW	Video Bandwidth
VCP	Vertical Coupling Plane
VDI	Voltage Dips and Short Interruptions
VFF	Voltage Fluctuations and Flicker



TÜV SÜD Canada Inc

Radiated Emissions Test Report

End of Document