



Add value.
Inspire trust.

Report On

FCC Testing of the Ericsson KRY 901 432/1 DOT 4479 B41K LTE, NR, LTE + NR (2515-2675 MHz) Base Station in accordance with FCC CFR 47 Part 2, FCC CFR 47 Part 27.

COMMERCIAL-IN-CONFIDENCE

FCC: TA8AKRY901432-1

PREPARED BY

Handwritten signature of Glen Westwell.

Glen Westwell
Senior Regulatory
Engineer

APPROVED BY

Handwritten signature of Scott Drysdale.

Scott Drysdale
Authorised Signatory

DATED

Aug 31st 2021

Document 7169010140.1 Report 01 Issue 1

August 2021



CONTENTS

Section	Page No
1	REPORT INFORMATION 2
1.1	Report Details 3
1.2	Brief Summary of Results 4
1.3	Test Rationale..... 5
1.4	Configuration Description 6
1.5	Declaration of Build Status 7
1.6	Product Information 9
1.7	Test Setup 10
1.8	Test Conditions..... 11
1.9	Deviation From The Standard 11
1.10	Modification Record 11
1.11	Additional Information 11
2	TEST DETAILS 12
1.12	Maximum Peak Output Power and Peak to Average Ratio - Conducted..... 13
1.13	Occupied Bandwidth..... 37
1.14	Band Edge 43
1.15	Transmitter Spurious Emissions..... 62
3	TEST EQUIPMENT USED 75
2.1	Test Equipment Used 76
2.1	Measurement Uncertainty 77
4	ACCREDITATION, DISCLAIMERS AND COPYRIGHT 78
3.1	Accreditation, Disclaimers and Copyright..... 79
ANNEX A	Module Lists.....A.2



SECTION 1

REPORT INFORMATION



1.1 REPORT DETAILS

Manufacturer	Ericsson
Address	Torshamnsgatan 23 Kista SE-16480 Stockholm Sweden
Product Name & Product Number	DOT 4479 B41K
Model Name	KRY 901 432/2
Serial Number(s)	TD3T789158
Software Version	CXP9013268/17
Hardware Version	R1B
Non-Tested Variant (See Section 1.11 Additional Information)	KRY 901 432/1
Test Specification/Issue/Date	FCC CFR 47 Part 2: 2020 FCC CFR 47 Part 27: 2020
Test Plan	B41K_RA_testplan (with new BW)
Start of Test	25 June 2021
Finish of Test	23 August 2021
Name of Engineer(s)	Glen Westwell
Related Document(s)	KDB 971168 D01 v02r02 KDB 662911 D01 v02r01 ANSI C63.26-2015

ENGINEERING STATEMENT

The measurements shown in this report were made in accordance with the procedures described on test pages. All reported testing was carried out on a sample equipment to demonstrate compliance with and FCC CFR 47 Part 2: 2020, FCC CFR 47 Part 27: 2020. The sample tested was found to comply with the requirements defined in the applied rules.

Test Engineer(s);

Glen Westwell



1.2 BRIEF SUMMARY OF RESULTS

The tests that have been selected are detailed in the customer Test Plan as defined in section 1.1 of this report. The Test Plan is based on the TÜV SÜD FCC Test Plan Rationale, available on request.

A brief summary of results for each configuration, in accordance with FCC CFR 47 Part 2, FCC CFR 47 Part 27, is shown below.

Section	Specification Clause		Test Description	Result
	FCC CFR 47 Part 2	FCC CFR 47 Part 27		
2.1	2.1046	27.50	Maximum Peak Output Power and Peak to Average Ratio - Conducted	Pass
2.2	2.1049	27.53	Occupied Bandwidth	Pass
2.3	2.1051	27.53	Band Edge	Pass
2.4	2.1051	27.53	Transmitter Spurious Emissions	Pass

The Dot 4479 B41K (KRY 901 432/1) and the Dot 4489 B41K (KRY 901 432/2) are Remote Radio Units forming part of the Ericsson Radio Base Station (RBS) equipment.

The 4479 and 4489 radios are identical except that Dot 4479 has internal antennas and Dot 4489 has external ports.

FCC C2PC Certification is only requested for Dot 4479.

The DOT 4489 – external antenna RF port variant was used to demonstrate compliance for this application using conducted measurements.



1.3 TEST RATIONALE

The tests that have been selected are detailed in the customer Test Plan as defined in section 1.1 of this report. The Test Plan is based on the TÜV SÜD FCC Test Plan Rationale, available on request.



1.4 CONFIGURATION DESCRIPTION

Configuration A					
RAT	No. of Carriers	Carrier Bandwidth	Carrier Frequency Configuration (MHz)		
			Bottom	Middle	Top
LTE	1	5 MHz	2,517.5	2,595.0	2,672.5
		10 MHz	2,520.0	2,595.0	2,670.0
		15 MHz	2,522.5	2,595.0	2,667.5
NR	1	40 MHz	2,535.0	2,595.0	2,655.0
		50 MHz	2,540.0	2,595.0	2,650.0
		60 MHz	2,545.0	2,595.0	2,645.0
		70 MHz	2,550.0	2,595.0	2,640.0
		80 MHz	2,555.0	2,595.0	2,635.0
		90 MHz	2,560.0	2,595.0	2,630.0

Configuration B					
RAT	No. of Carriers	Carrier Bandwidth	Carrier Frequency Configuration (MHz)		
			Bottom	Middle	Top
NR	2	40+40 MHz	2535.0+2575.0	2575.0+2615.0	2615.0+2655.0
		50+50 MHz	2540.0+2590.0	2570.0+2620.0	2600.0+2650.0
LTE+NR	2	L5+NR20 MHz	2517.5+2530.0	2582.5+2595.0	2652.5+2665.0

Configuration C					
RAT	No. of Carriers	Carrier Bandwidth	Carrier Frequency Configuration (MHz)		
			Bottom	Middle	Top
LTE	6	5 MHz	2517.5+2522.5+2527.5+	2582.5+2587.5+2592.5+	2647.5+2652.5+2657.5+
			2532.5+2537.5+2542.5 MHz	2597.5+2602.5+2607.5 MHz	2662.5+2667.5+2672.5 MHz
		10 MHz	2520.0+2530.0+2540.0+	2570.0+2580.0+2590.0+	2620.0+2630.0+2640.0+
			2550.0+2560.0+2570.0 MHz	2600.0+2610.0+2620.0 MHz	2650.0+2660.0+2670.0 MHz
		15 MHz	2522.5+2537.5+2552.2+	2550.0+2565.0+2580.0+	2592.5+2607.5+2622.5+
			2567.5+2582.5+2597.5 MHz	2595.0+2610.0+2625.0 MHz	2637.5+2652.5+2667.5 MHz
LTE (3) + NR (3)	L10 MHz + NR 20 MHz	2520.0+2530.0+2540.0+	2560.0+2570.0+2580.0	2590.0+2600.0+2610.0+	
		2555.0+2575.0+2595.0 MHz	2595.0+2615.0+2635.0 MHz	2625.0+2645.0+2665.0 MHz	



1.5 DECLARATION OF BUILD STATUS

MAIN EUT	
MANUFACTURING DESCRIPTION	Radio Dot
MANUFACTURER	Ericsson
TYPE	Remote Radio Base Station
PART NUMBER	KRY 901 432/1 and KRY 901 432/2
SERIAL NUMBER	TD3T789158
HARDWARE VERSION	R1B
SOFTWARE VERSION	CXP 901 3268/17 - R86BB920
TRANSMITTER OPERATING RANGE	2515 – 2675 MHz
RECEIVER OPERATING RANGE	2515 – 2675 MHz
COUNTRY OF ORIGIN	China
INTERMEDIATE FREQUENCIES	None
EMISSION DESIGNATOR(S): (i.e. G1D, GXW)	LTE: 5M00W7D, 10M0W7D, 15M0W7D, 20M0W7D NR: 20M0F9W, 40M0F9W, 50M0F9W, 60M0F9W, 70M0F9W, 80M0F9W, 90M0F9W, 100MF9W
MODULATION TYPES: (i.e. GMSK, QPSK)	LTE: QPSK, 16QAM, 64QAM, 256QAM NR: QPSK, 16QAM, 64QAM, 256QAM
HIGHEST INTERNALLY GENERATED FREQUENCY	2.7 GHz
Antenna Gain (dBi)	4.9 dBi
OUTPUT POWER (W or dBm)	4 x 0.25W (24dBm)
FCC ID	TA8AKRY901432-1
INDUSTRY CANADA ID	
TECHNICAL DESCRIPTION (a brief description of the intended use and operation)	The Dot 4479 B41K (KRY 901 432/1) and the Dot 4489 B41K (KRY 901 432/2) are Remote Radio Units forming part of the Ericsson Radio Base Station (RBS) equipment. The Dot provides radio access for mobile and fixed devices and is intended for the indoor environment. The radio operates over 4 Transmit ports in MRO (LTE and NR); Single, Multi-Carrier, and MIMO transmission with a maximum rated RF Output of 0.25W per port over an operational temperature of 5°C to +40°C. The unit is designed to be ceiling or wall mounted. The 4479 and 4489 radios are identical except that Dot 4479 has internal antennas and Dot 4489 has external ports. FCC Certification is only requested for Dot 4479.

Signature:

.....

Denis Lalonde

Date: 24 August 2021

Declaration of Build Status Serial Number: TD3T789158

No responsibility will be accepted by TÜV SÜD Limited as to the accuracy of the information declared in this document by the manufacturer.



1.6 PRODUCT INFORMATION

1.6.1 Technical Description

The Equipment Under Test (EUT) DOT 4479 B41K & KRY 901 432/1 is an Ericsson AB Radio Unit working in the public mobile service Band 41K band which provides communication connections to Band 41K network. The EUT operates from a -48V DC supply.

The Equipment Under Test (EUT) is shown in the photograph below. A full technical description can be found in the Manufacturer's documentation.

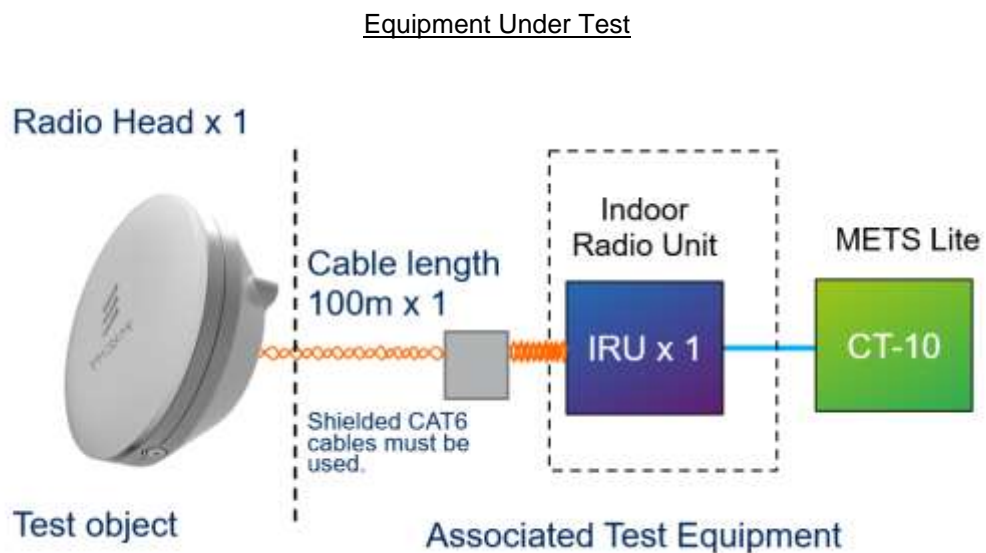



1.7 TEST SETUP

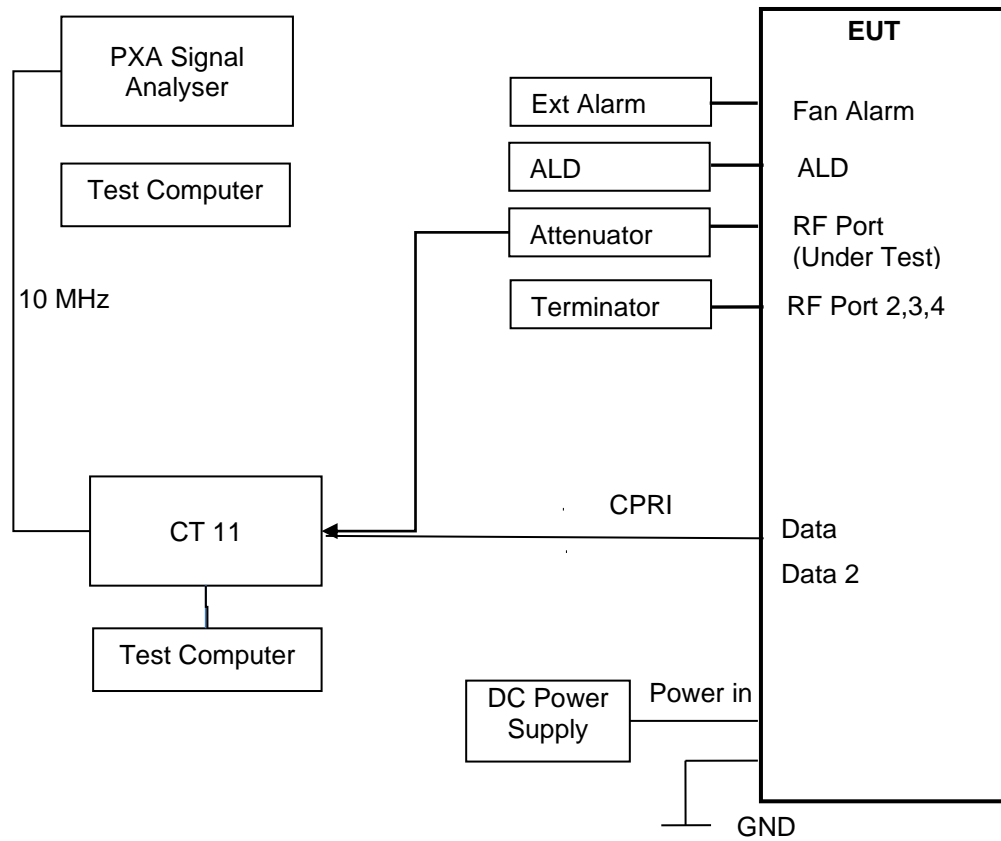



1.8 TEST CONDITIONS

For all tests the EUT was set up in accordance with the relevant test standard and to represent typical operating conditions. Tests were applied with the EUT situated as described in the Test Method for each Test.

The EUT was powered from a -48V DC supply.

ISED Accreditation
IC#24015 TUV SUD Ottawa, Canada.

Under our A2LA Accreditation, TÜV SÜD Canada conducted the following tests at Ericsson's, Ottawa Laboratory: 349 Terry Fox Dr, Kanata, ON.

Test Name	Name of Engineer(s)
Maximum Peak Output Power and Peak to Average Ratio - Conducted	Glen Westwell
Occupied Bandwidth	Glen Westwell
Band Edge	Glen Westwell
Transceiver Spurious Emissions	Glen Westwell

1.9 DEVIATION FROM THE STANDARD

No deviations from the applicable test standards or test plan were made during testing.

1.10 MODIFICATION RECORD

No modifications were made to the EUT during testing.

1.11 ADDITIONAL INFORMATION

Ericsson will limit this product through the software from operating across the whole of Band 41, it will be limited to Band 41K.

1. This filing is for a Class II Permissive Change Radio Certification for use in the USA under the following ID's:

FCC ID: TA8AKRY901432-1

2. Transmitter performance was measured for top, mid & bottom channels, where applicable, across all antenna ports as presented in the average power measurement tables. Typical performance is presented.



SECTION 2

TEST DETAILS



1.12 MAXIMUM PEAK OUTPUT POWER AND PEAK TO AVERAGE RATIO - CONDUCTED

1.12.1 Specification Reference

FCC CFR 47 Part 27, Clause 27.50
FCC CFR 47 Part 2, Clause 2.1046

1.12.2 Date of Test and Modification State

25, 26 June and 22 August 2021 - Modification State 0

1.12.3 Test Equipment Used

The major items of test equipment used for the above tests are identified in Section 3.1.

1.12.4 Environmental Conditions

Ambient Temperature	24.5 - 25.2°C
Relative Humidity	29.4 - 29.9%

1.12.5 Test Method

All measurements were made in accordance with FCC KDB 971168 D01, clause 5.2.1 and summed in accordance with FCC KDB 662911 D01.

1.12.6 Test Results

1.12.7 Configuration A

Maximum Output Power 24.00 dBm / Port

Remarks

1. Transmitter performance has been presented for top, mid, bottom channels across all antenna ports as represented in the following tables.
2. Typical performance and measurement plot data has been presented for reference.
3. All plot data is on file and available upon request.



Antenna Gain (dBi)	Modulation	Carrier Bandwidth	Peak to Average Ratio (PAR) / Output Power				
			PAR (dB)	Channel Position B			
				Average Power			
Antenna Port				dBm	EIRP (dBm)	dBm/MHz	EIRP dBm/MHz
4.90							
A	LTE: QPSK	5.0 MHz	10.19	23.79	28.69	17.96	22.86
B	LTE: QPSK	5.0 MHz	-	23.39	28.29	17.96	22.86
C	LTE: QPSK	5.0 MHz	-	23.68	28.58	17.96	22.86
D	LTE: QPSK	5.0 MHz	-	23.45	28.35	17.96	22.86
Total			-	29.60	34.50	23.98	28.88
A	LTE: QPSK	10.0 MHz	9.72	24.79	29.69	16.00	20.90
B	LTE: QPSK	10.0 MHz	-	24.50	29.40	16.00	20.90
C	LTE: QPSK	10.0 MHz	-	24.93	29.83	16.00	20.90
D	LTE: QPSK	10.0 MHz	-	24.66	29.56	16.00	20.90
Total			-	30.74	35.64	22.02	26.92
A	LTE: QPSK	15.0 MHz	10.14	24.62	29.52	14.11	19.01
B	LTE: QPSK	15.0 MHz	-	24.23	29.13	14.11	19.01
C	LTE: QPSK	15.0 MHz	-	24.75	29.65	14.11	19.01
D	LTE: QPSK	15.0 MHz	-	24.72	29.62	14.11	19.01
Total			-	30.61	35.51	20.13	25.03
A	NR: QPSK	40.0 MHz	9.50	24.25	29.15	9.49	14.39
B	NR: QPSK	40.0 MHz	-	23.80	28.70	9.49	14.39
C	NR: QPSK	40.0 MHz	-	23.99	28.89	9.49	14.39
D	NR: QPSK	40.0 MHz	-	24.14	29.04	9.49	14.39
Total			-	30.07	34.97	15.51	20.41
A	NR: QPSK	50.0 MHz	9.55	23.93	28.83	8.03	12.93
B	NR: QPSK	50.0 MHz	-	23.09	27.99	8.03	12.93
C	NR: QPSK	50.0 MHz	-	24.24	29.14	8.03	12.93
D	NR: QPSK	50.0 MHz	-	24.11	29.01	8.03	12.93
Total			-	29.89	34.79	14.05	18.95
A	NR: QPSK	60.0 MHz	9.27	24.02	28.92	7.82	12.72
B	NR: QPSK	60.0 MHz	-	23.37	28.27	7.82	12.72
C	NR: QPSK	60.0 MHz	-	23.73	28.63	7.82	12.72
D	NR: QPSK	60.0 MHz	-	24.51	29.41	7.82	12.72
Total			-	29.95	34.85	13.84	18.74
A	NR: QPSK	70.0 MHz	9.28	23.38	28.28	6.15	11.05
B	NR: QPSK	70.0 MHz	-	22.78	27.68	6.15	11.05
C	NR: QPSK	70.0 MHz	-	23.39	28.29	6.15	11.05
D	NR: QPSK	70.0 MHz	-	23.35	28.25	6.15	11.05
Total			-	29.25	34.15	12.17	17.07
A	NR: QPSK	80.0 MHz	9.38	23.40	28.30	5.16	10.06
B	NR: QPSK	80.0 MHz	-	22.92	27.82	5.16	10.06
C	NR: QPSK	80.0 MHz	-	22.77	27.67	5.16	10.06
D	NR: QPSK	80.0 MHz	-	23.18	28.08	5.16	10.06
Total			-	29.09	33.99	11.18	16.08
A	NR: QPSK	90.0 MHz	9.39	23.53	28.43	5.11	10.01
B	NR: QPSK	90.0 MHz	-	23.31	28.21	5.11	10.01
C	NR: QPSK	90.0 MHz	-	23.22	28.12	5.11	10.01
D	NR: QPSK	90.0 MHz	-	23.22	28.12	5.11	10.01
Total			-	29.34	34.24	11.13	16.03



Antenna Gain (dBi)	Modulation	Carrier Bandwidth	Peak to Average Ratio (PAR) / Output Power					
			Antenna Port	PAR (dB)	Channel Position M			
					Average Power			
4.90				dBm	EIRP (dBm)	dBm/MHz	EIRP dBm/MHz	
A	LTE: QPSK	5.0 MHz	9.91	25.20	30.10	18.32	23.22	
B	LTE: QPSK	5.0 MHz	-	25.01	29.91	18.32	23.22	
C	LTE: QPSK	5.0 MHz	-	24.19	29.09	18.32	23.22	
D	LTE: QPSK	5.0 MHz	-	24.08	28.98	18.32	23.22	
Total			-	30.67	35.57	24.34	29.24	
A	LTE: QPSK	10.0 MHz	9.39	24.96	29.86	15.75	20.65	
B	LTE: QPSK	10.0 MHz	-	24.75	29.65	15.75	20.65	
C	LTE: QPSK	10.0 MHz	-	24.63	29.53	15.75	20.65	
D	LTE: QPSK	10.0 MHz	-	24.53	29.43	15.75	20.65	
Total			-	30.74	35.64	21.77	26.67	
A	LTE: QPSK	15.0 MHz	9.64	24.80	29.70	13.91	18.81	
B	LTE: QPSK	15.0 MHz	-	24.18	29.08	13.91	18.81	
C	LTE: QPSK	15.0 MHz	-	24.57	29.47	13.91	18.81	
D	LTE: QPSK	15.0 MHz	-	24.49	29.39	13.91	18.81	
Total			-	30.54	35.44	19.93	24.83	
A	NR: QPSK	40.0 MHz	9.53	24.18	29.08	9.09	13.99	
B	NR: QPSK	40.0 MHz	-	23.82	28.72	9.09	13.99	
C	NR: QPSK	40.0 MHz	-	23.92	28.82	9.09	13.99	
D	NR: QPSK	40.0 MHz	-	23.39	28.29	9.09	13.99	
Total			-	29.86	34.76	15.11	20.01	
A	NR: QPSK	50.0 MHz	9.60	23.74	28.64	7.62	12.52	
B	NR: QPSK	50.0 MHz	-	23.70	28.60	7.62	12.52	
C	NR: QPSK	50.0 MHz	-	23.61	28.51	7.62	12.52	
D	NR: QPSK	50.0 MHz	-	23.65	28.55	7.62	12.52	
Total			-	29.70	34.60	13.64	18.54	
A	NR: QPSK	60.0 MHz	9.46	23.93	28.83	6.84	11.74	
B	NR: QPSK	60.0 MHz	-	23.48	28.38	6.84	11.74	
C	NR: QPSK	60.0 MHz	-	23.52	28.42	6.84	11.74	
D	NR: QPSK	60.0 MHz	-	23.47	28.37	6.84	11.74	
Total			-	29.62	34.52	12.86	17.76	
A	NR: QPSK	70.0 MHz	9.43	23.81	28.71	5.51	10.41	
B	NR: QPSK	70.0 MHz	-	23.00	27.90	5.51	10.41	
C	NR: QPSK	70.0 MHz	-	23.02	27.92	5.51	10.41	
D	NR: QPSK	70.0 MHz	-	23.04	27.94	5.51	10.41	
Total			-	29.25	34.15	11.53	16.43	
A	NR: QPSK	80.0 MHz	9.44	23.41	28.31	5.27	10.17	
B	NR: QPSK	80.0 MHz	-	22.59	27.49	5.27	10.17	
C	NR: QPSK	80.0 MHz	-	24.23	29.13	5.27	10.17	
D	NR: QPSK	80.0 MHz	-	24.04	28.94	5.27	10.17	
Total			-	29.63	34.53	11.29	16.19	
A	NR: QPSK	90.0 MHz	9.75	23.38	28.28	4.78	9.68	
B	NR: QPSK	90.0 MHz	-	23.11	28.01	4.78	9.68	
C	NR: QPSK	90.0 MHz	-	22.67	27.57	4.78	9.68	
D	NR: QPSK	90.0 MHz	-	23.32	28.22	4.78	9.68	
Total			-	29.15	34.05	10.80	15.70	



Antenna Gain (dBi)	Modulation	Carrier Bandwidth	Peak to Average Ratio (PAR) / Output Power				
			Channel Position T				
			PAR (dB)	Average Power			
dBm	EIRP (dBm)	dBm/MHz		EIRP dBm/MHz			
4.90							
Antenna Port							
A	LTE: QPSK	5.0 MHz	9.67	25.11	30.01	18.43	23.33
B	LTE: QPSK	5.0 MHz	-	24.96	29.86	18.43	23.33
C	LTE: QPSK	5.0 MHz	-	24.39	29.29	18.43	23.33
D	LTE: QPSK	5.0 MHz	-	23.65	28.55	18.43	23.33
Total			-	30.59	35.49	24.45	29.35
A	LTE: QPSK	10.0 MHz	9.81	25.00	29.90	16.27	21.17
B	LTE: QPSK	10.0 MHz	-	24.54	29.44	16.27	21.17
C	LTE: QPSK	10.0 MHz	-	24.65	29.55	16.27	21.17
D	LTE: QPSK	10.0 MHz	-	24.17	29.07	16.27	21.17
Total			-	30.62	35.52	22.29	27.19
A	LTE: QPSK	15.0 MHz	9.65	24.95	29.85	14.68	19.58
B	LTE: QPSK	15.0 MHz	-	24.57	29.47	14.68	19.58
C	LTE: QPSK	15.0 MHz	-	24.87	29.77	14.68	19.58
D	LTE: QPSK	15.0 MHz	-	24.44	29.34	14.68	19.58
Total			-	30.73	35.63	20.70	25.60
A	NR: QPSK	40.0 MHz	9.70	23.52	28.42	8.45	13.35
B	NR: QPSK	40.0 MHz	-	23.45	28.35	8.45	13.35
C	NR: QPSK	40.0 MHz	-	23.57	28.47	8.45	13.35
D	NR: QPSK	40.0 MHz	-	23.62	28.52	8.45	13.35
Total			-	29.56	34.46	14.47	19.37
A	NR: QPSK	50.0 MHz	9.39	23.94	28.84	7.88	12.78
B	NR: QPSK	50.0 MHz	-	23.60	28.50	7.88	12.78
C	NR: QPSK	50.0 MHz	-	24.00	28.90	7.88	12.78
D	NR: QPSK	50.0 MHz	-	24.00	28.90	7.88	12.78
Total			-	29.91	34.81	13.90	18.80
A	NR: QPSK	60.0 MHz	9.44	23.36	28.26	7.58	12.48
B	NR: QPSK	60.0 MHz	-	23.83	28.73	7.58	12.48
C	NR: QPSK	60.0 MHz	-	23.76	28.66	7.58	12.48
D	NR: QPSK	60.0 MHz	-	23.83	28.73	7.58	12.48
Total			-	29.72	34.62	13.60	18.50
A	NR: QPSK	70.0 MHz	7.78	23.96	28.86	5.52	10.42
B	NR: QPSK	70.0 MHz	-	23.23	28.13	5.52	10.42
C	NR: QPSK	70.0 MHz	-	22.72	27.62	5.52	10.42
D	NR: QPSK	70.0 MHz	-	22.97	27.87	5.52	10.42
Total			-	29.27	34.17	11.54	16.44
A	NR: QPSK	80.0 MHz	9.20	23.71	28.61	6.11	11.01
B	NR: QPSK	80.0 MHz	-	24.10	29.00	6.11	11.01
C	NR: QPSK	80.0 MHz	-	23.93	28.83	6.11	11.01
D	NR: QPSK	80.0 MHz	-	24.14	29.04	6.11	11.01
Total			-	29.99	34.89	12.13	17.03
A	NR: QPSK	90.0 MHz	9.58	23.40	28.30	4.81	9.71
B	NR: QPSK	90.0 MHz	-	22.80	27.70	4.81	9.71
C	NR: QPSK	90.0 MHz	-	22.71	27.61	4.81	9.71
D	NR: QPSK	90.0 MHz	-	22.67	27.57	4.81	9.71
Total			-	28.93	33.83	10.83	15.73



Antenna Port A Carrier Power - Modulation LTE: QPSK - Carrier Bandwidth 5.0 MHz - Channel Position B



Antenna Port A Pk-Av Ratio - Modulation LTE: QPSK - Carrier Bandwidth 5.0 MHz - Channel Position B

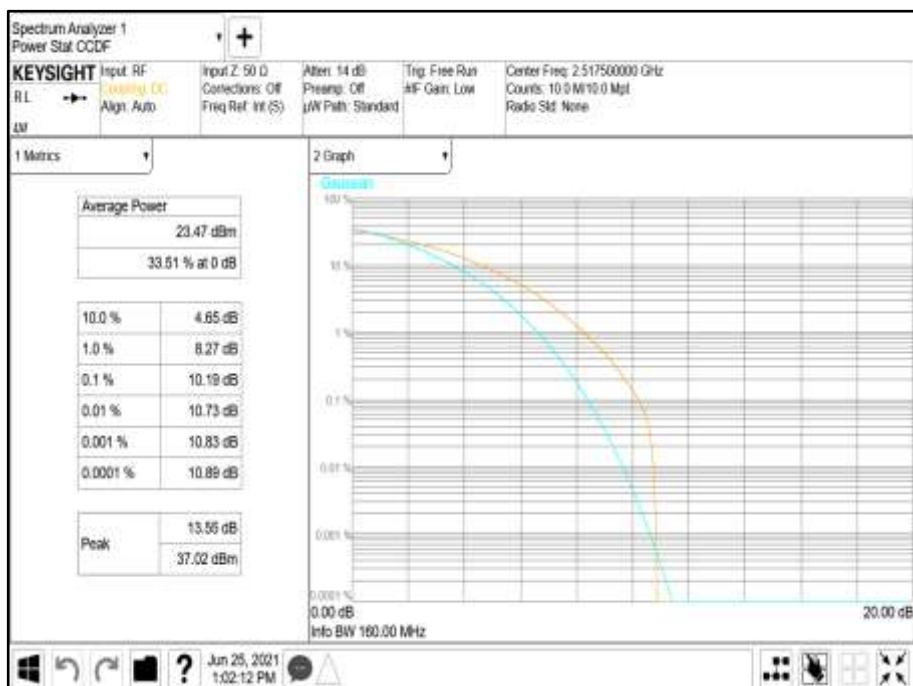



Antenna Port A PSD - Modulation LTE: QPSK - Carrier Bandwidth 5.0 MHz - Channel Position B



Antenna Port A Carrier Power - Modulation LTE: QPSK - Carrier Bandwidth 10.0 MHz - Channel Position B





Antenna Port A Pk-Av Ratio - Modulation LTE: QPSK - Carrier Bandwidth 10.0 MHz - Channel Position B

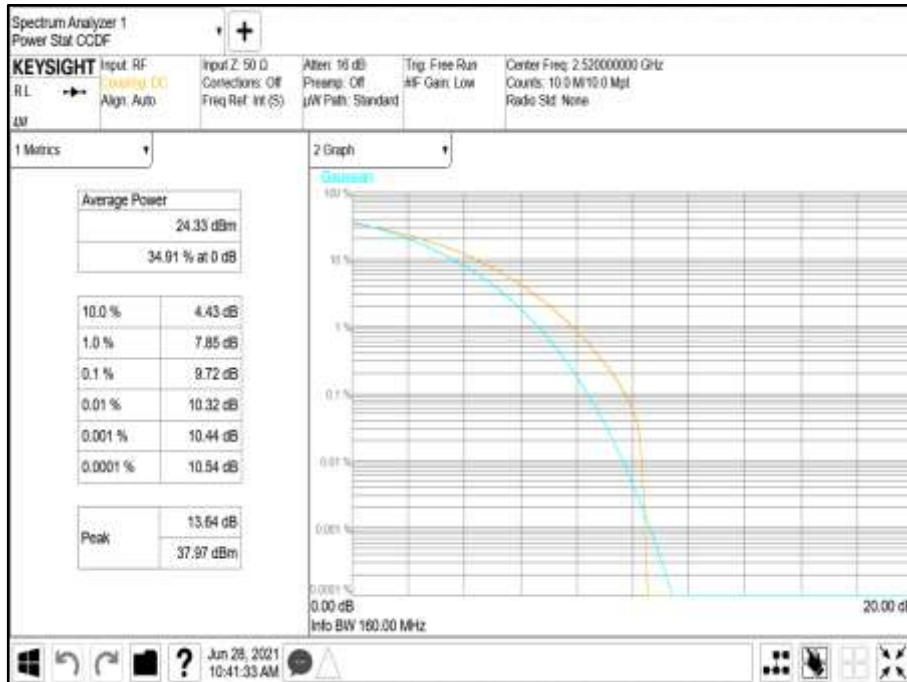

Antenna Port A PSD - Modulation LTE: QPSK - Carrier Bandwidth 10.0 MHz - Channel Position B





Antenna Port A Carrier Power - Modulation LTE: QPSK - Carrier Bandwidth 15.0 MHz - Channel Position B



Antenna Port A Pk-Av Ratio - Modulation LTE: QPSK - Carrier Bandwidth 15.0 MHz - Channel Position B

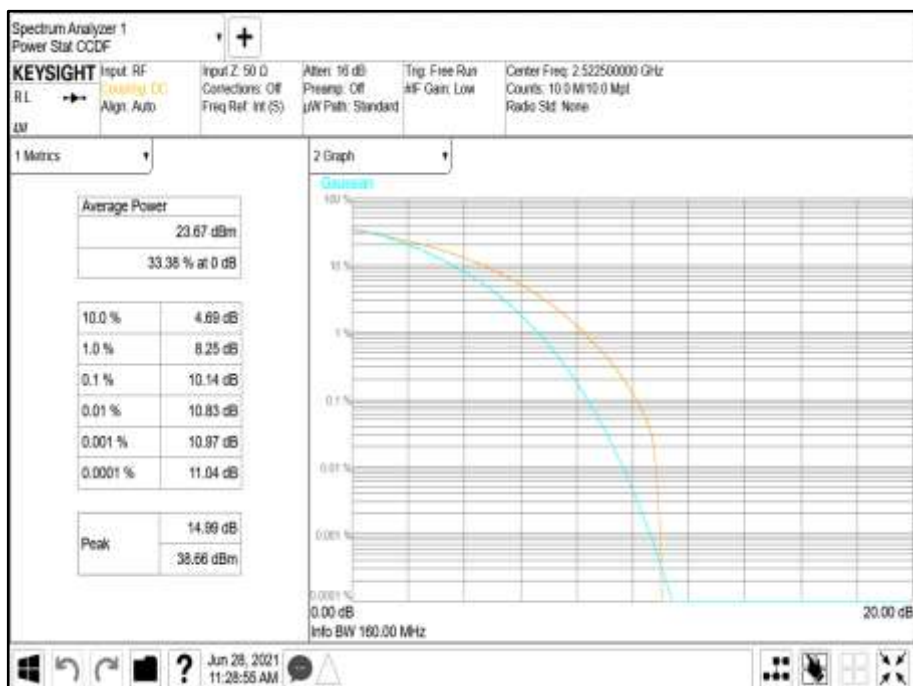



Antenna Port A PSD - Modulation LTE: QPSK - Carrier Bandwidth 15.0 MHz - Channel Position B



Antenna Port A Carrier Power - Modulation NR: QPSK - Carrier Bandwidth 40.0 MHz - Channel Position B





Antenna Port A Pk-Av Ratio - Modulation NR: QPSK - Carrier Bandwidth 40.0 MHz - Channel Position B

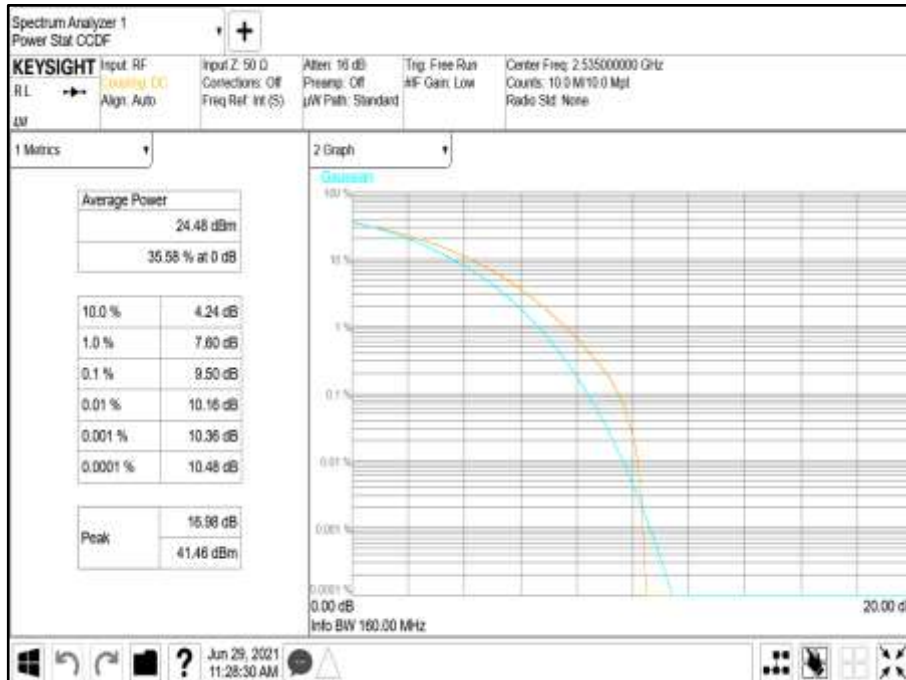

Antenna Port A PSD - Modulation NR: QPSK - Carrier Bandwidth 40.0 MHz - Channel Position B

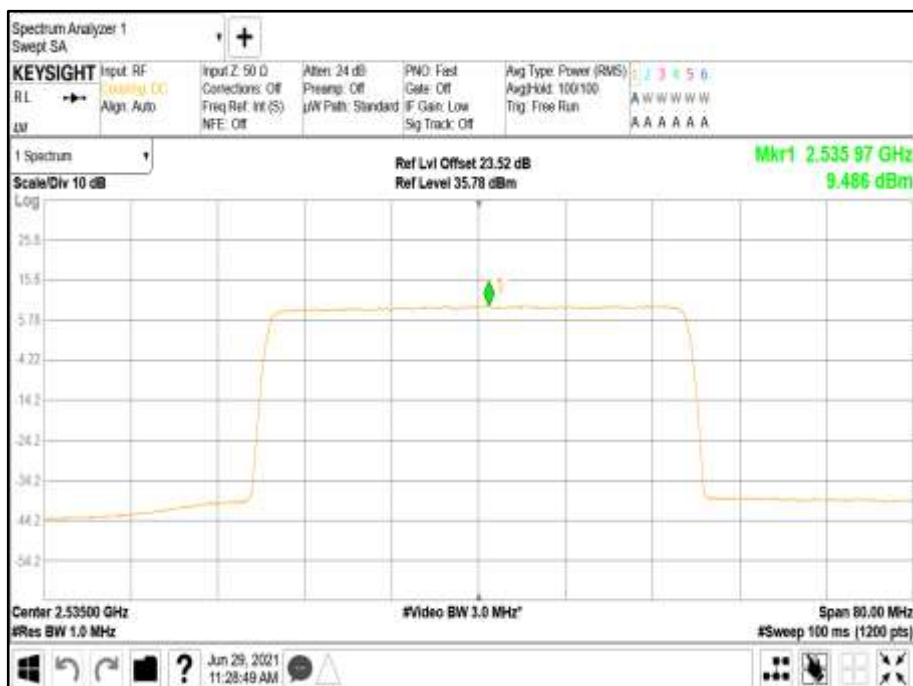



Antenna Port A Carrier Power - Modulation NR: QPSK - Carrier Bandwidth 50.0 MHz - Channel Position B



Antenna Port A Pk-Av Ratio - Modulation NR: QPSK - Carrier Bandwidth 50.0 MHz - Channel Position B

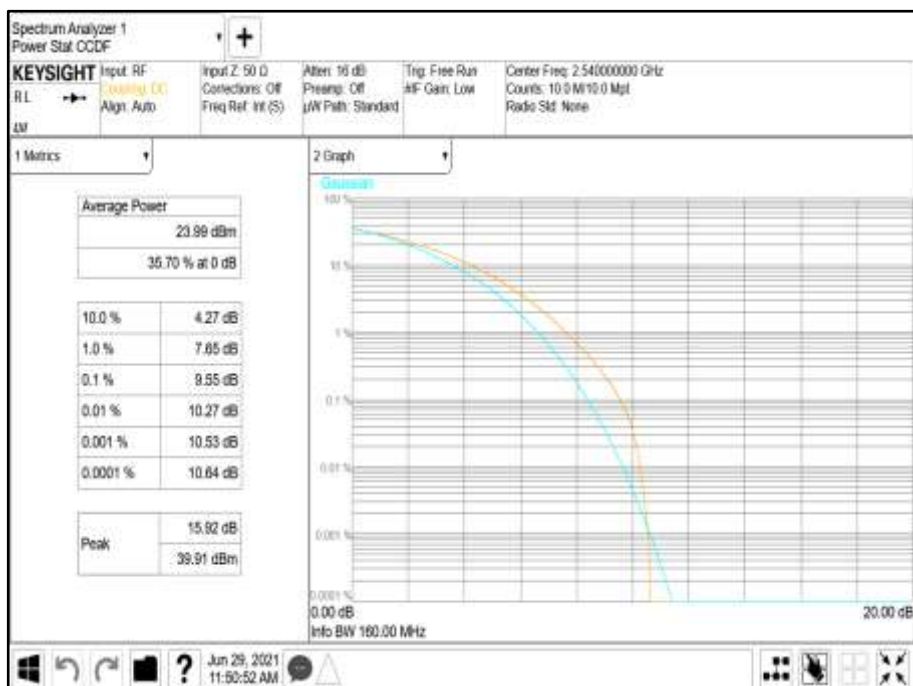



Antenna Port A PSD - Modulation NR: QPSK - Carrier Bandwidth 50.0 MHz - Channel Position B

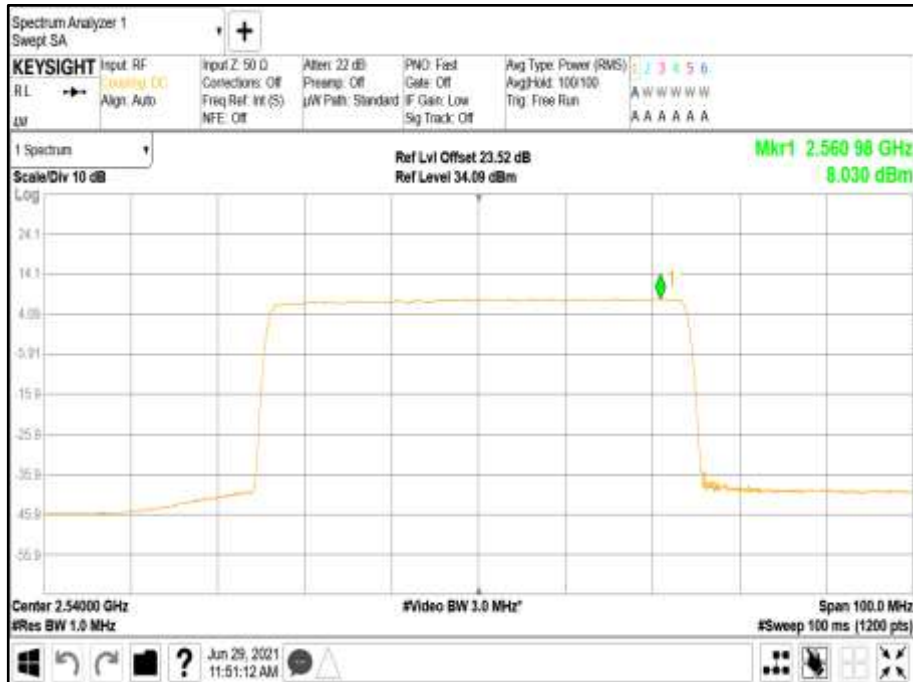

Antenna Port A Carrier Power - Modulation NR: QPSK - Carrier Bandwidth 60.0 MHz - Channel Position B





Antenna Port A Pk-Av Ratio - Modulation NR: QPSK - Carrier Bandwidth 60.0 MHz - Channel Position B

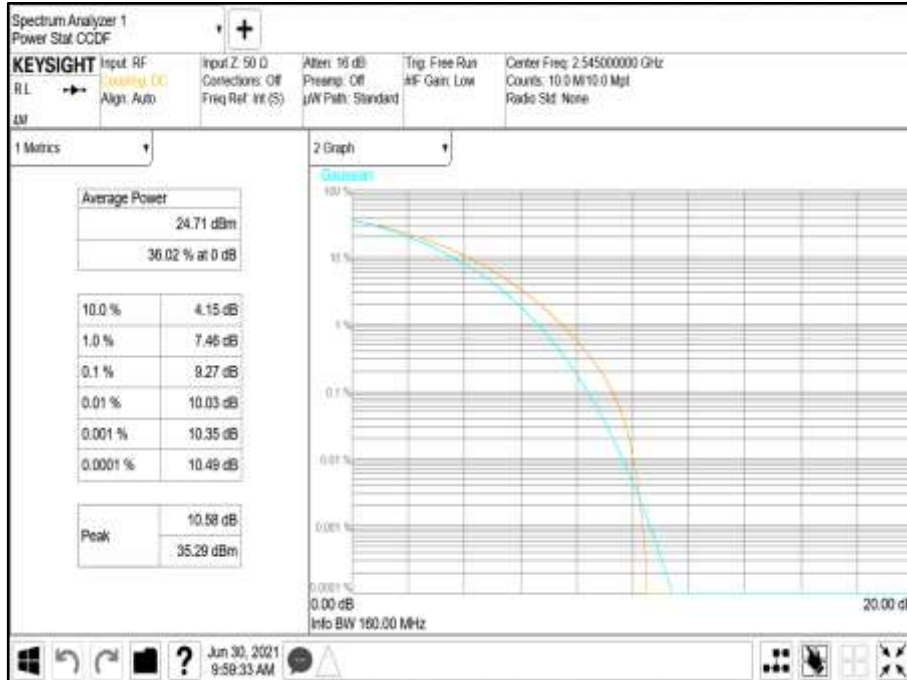

Antenna Port A PSD - Modulation NR: QPSK - Carrier Bandwidth 60.0 MHz - Channel Position B





Antenna Port A Carrier Power - Modulation NR: QPSK - Carrier Bandwidth 70.0 MHz - Channel Position B



Antenna Port A Pk-Av Ratio - Modulation NR: QPSK - Carrier Bandwidth 70.0 MHz - Channel Position B

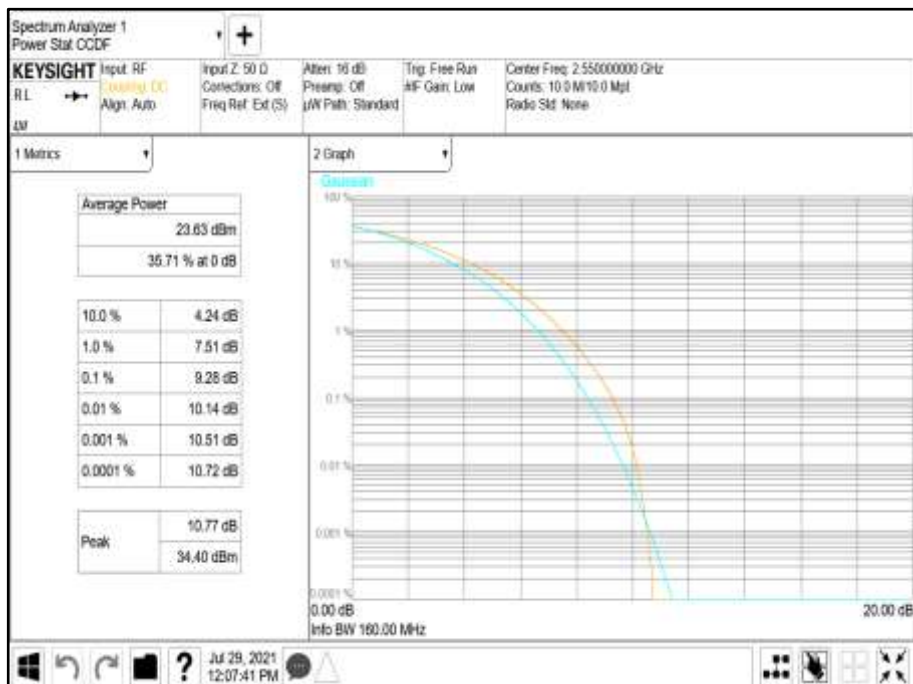



Antenna Port A PSD - Modulation NR: QPSK - Carrier Bandwidth 70.0 MHz - Channel Position B



Antenna Port A Carrier Power - Modulation NR: QPSK - Carrier Bandwidth 80.0 MHz - Channel Position B





Antenna Port A Pk-Av Ratio - Modulation NR: QPSK - Carrier Bandwidth 80.0 MHz - Channel Position B

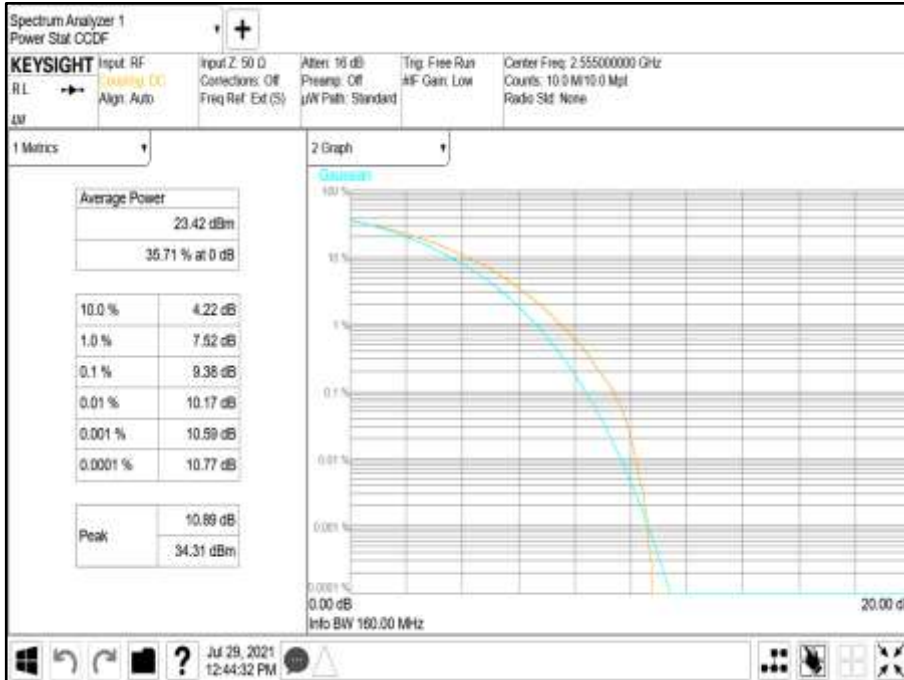

Antenna Port A PSD - Modulation NR: QPSK - Carrier Bandwidth 80.0 MHz - Channel Position B

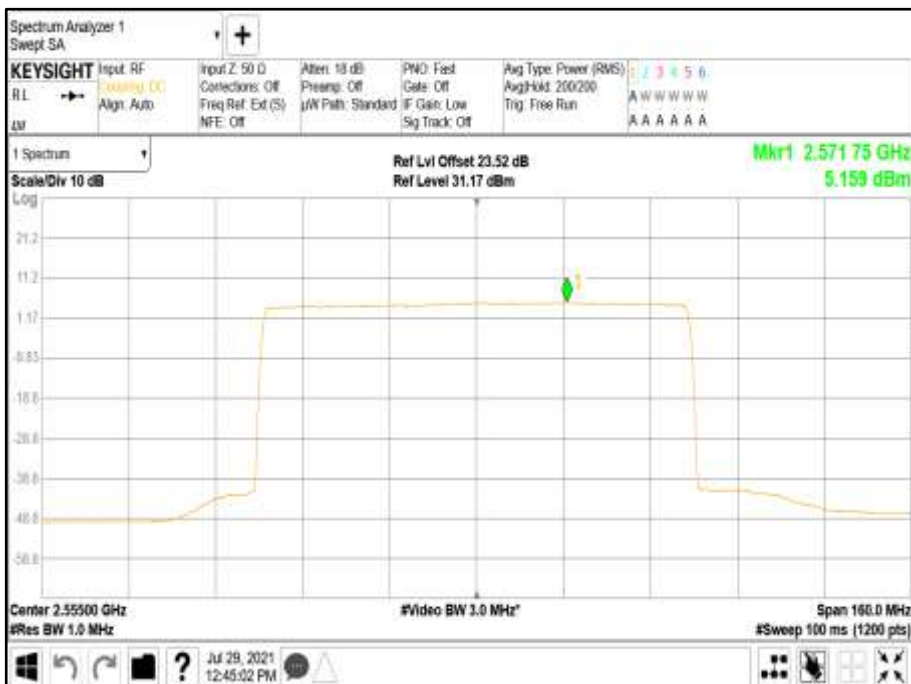



Antenna Port A Carrier Power - Modulation NR: QPSK - Carrier Bandwidth 90.0 MHz - Channel Position B



Antenna Port A Pk-Av Ratio - Modulation NR: QPSK - Carrier Bandwidth 90.0 MHz - Channel Position B

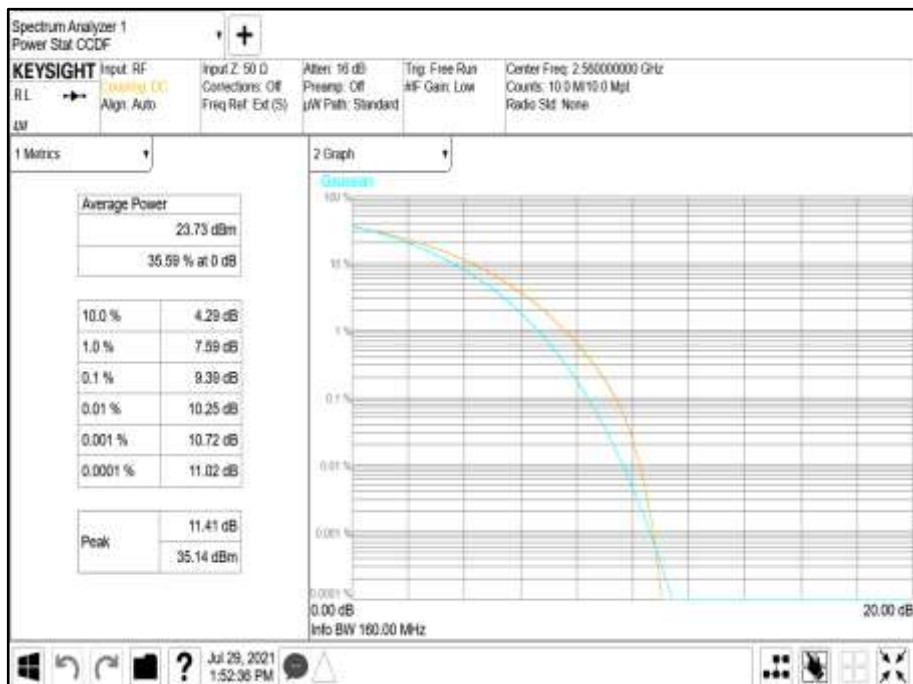



Antenna Port A PSD - Modulation NR: QPSK - Carrier Bandwidth 90.0 MHz - Channel Position B





Configuration B

Maximum Output Power 24.00 dBm / Port

Antenna Gain (dBi)	Modulation	Carrier Bandwidth	Output Power	
			Channel Position M	
Antenna Port			Average Power (dBm)	
			dBm	EIRP (dBm)
4.90				
A	NR: QPSK	40.0+40.0 MHz	23.42	28.32
B	NR: QPSK	40.0+40.0 MHz	23.06	27.96
C	NR: QPSK	40.0+40.0 MHz	24.25	29.15
D	NR: QPSK	40.0+40.0 MHz	24.39	29.29
Total			29.84	34.74
A	NR: QPSK	50.0+50.0 MHz	24.01	28.91
B	NR: QPSK	50.0+50.0 MHz	23.80	28.70
C	NR: QPSK	50.0+50.0 MHz	23.88	28.78
D	NR: QPSK	50.0+50.0 MHz	23.90	28.80
Total			29.92	34.82
A	LTE5+NR20: QPSK	L5.0+NR20.0 MHz	23.01	27.91
B	LTE5+NR20: QPSK	L5.0+NR20.0 MHz	22.59	27.49
C	LTE5+NR20: QPSK	L5.0+NR20.0 MHz	22.50	27.40
D	LTE5+NR20: QPSK	L5.0+NR20.0 MHz	22.43	27.33
Total			28.66	33.56

Remarks

1. The table results are measured at all antenna ports, worst-case performance presented.
2. The plot results represent typical radio performance across all channels.
3. Plot data performance for all transmitter ports and channels are available on request.



Antenna Port A Carrier Power - Modulation NR: QPSK - Carrier Bandwidth 40.0+40.0 MHz - Channel Position M



Antenna Port A Carrier Power - Modulation NR: QPSK - Carrier Bandwidth 50.0+50.0 MHz - Channel Position M





Antenna Port A Carrier Power - Modulation LTE5+NR20: QPSK - Carrier Bandwidth L5.0+NR20.0 MHz - Channel Position M





Configuration C

Maximum Output Power 24.00 dBm / Port

Antenna Gain (dBi)	Modulation	Carrier Bandwidth	Output Power	
			Channel Position M	
Antenna Port			Average Power (dBm)	
			dBm	EIRP (dBm)
4.90				
A	LTE: QPSK	5+5+5+5+5+5 MHz	24.44	29.34
B	LTE: QPSK	5+5+5+5+5+5 MHz	24.10	29.00
C	LTE: QPSK	5+5+5+5+5+5 MHz	24.47	29.37
D	LTE: QPSK	5+5+5+5+5+5 MHz	24.48	29.38
Total			30.40	35.30
A	LTE: QPSK	10+10+10+10+10+10 MHz	23.62	28.52
B	LTE: QPSK	10+10+10+10+10+10 MHz	23.06	27.96
C	LTE: QPSK	10+10+10+10+10+10 MHz	23.56	28.46
D	LTE: QPSK	10+10+10+10+10+10 MHz	23.72	28.62
Total			29.52	34.42
A	LTE: QPSK	15+15+15+15+15+15 MHz	23.51	28.41
B	LTE: QPSK	15+15+15+15+15+15 MHz	23.11	28.01
C	LTE: QPSK	15+15+15+15+15+15 MHz	23.67	28.57
D	LTE: QPSK	15+15+15+15+15+15 MHz	23.82	28.72
Total			29.56	34.46
A	LTE10+NR20: QPSK	10+10+10+20+20+20 MHz	22.25	27.15
B	LTE10+NR20: QPSK	10+10+10+20+20+20 MHz	21.89	26.79
C	LTE10+NR20: QPSK	10+10+10+20+20+20 MHz	22.06	26.96
D	LTE10+NR20: QPSK	10+10+10+20+20+20 MHz	22.37	27.27
Total			28.17	33.07

Remarks

1. The plot results represent typical radio performance across the transmit pass band.
2. The highest power transmitter configuration is presented for compliance.



Antenna Port A Carrier Power - Modulation LTE: QPSK - Carrier Bandwidth 5+5+5+5+5 MHz - Channel Position M

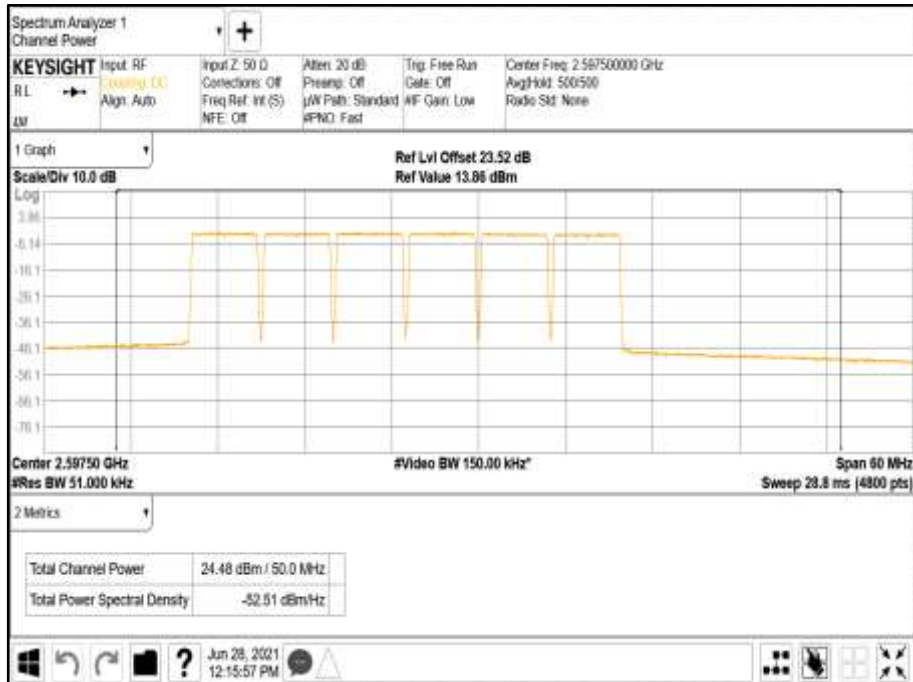

Antenna Port A Carrier Power - Modulation LTE: QPSK - Carrier Bandwidth 10+10+10+10+10+10 MHz - Channel Position M

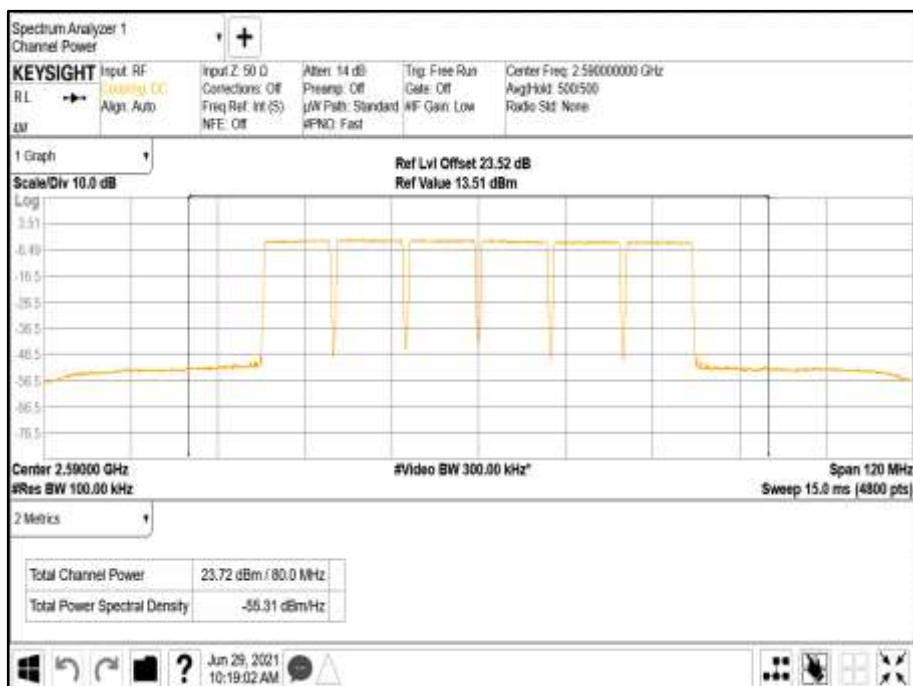



Antenna Port A Carrier Power - Modulation LTE: QPSK - Carrier Bandwidth 15+15+15+15+15+15 MHz - Channel Position M

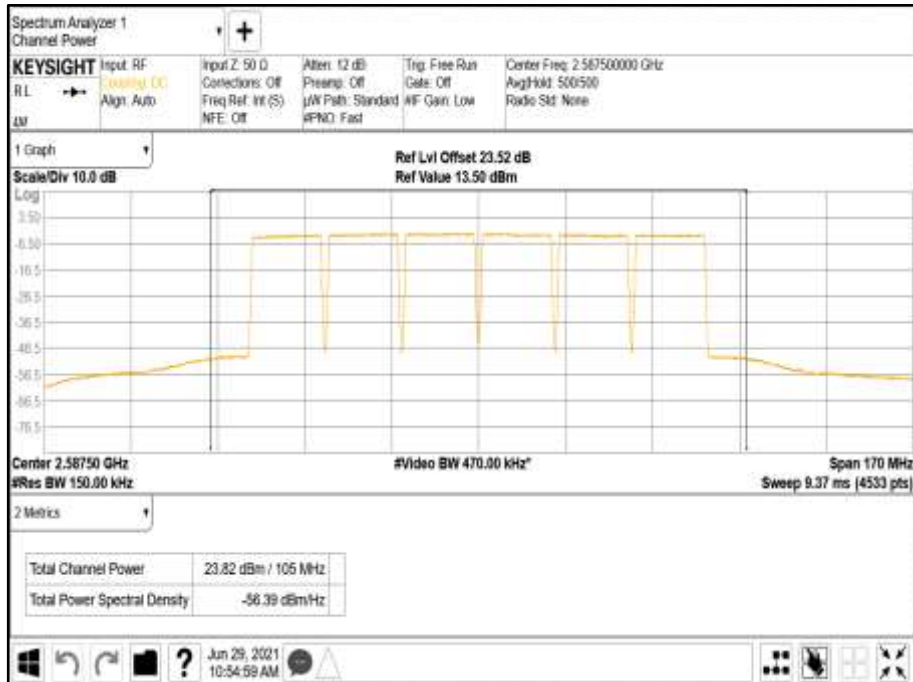

Antenna Port A Carrier Power - Modulation LTE10+NR20: QPSK - Carrier Bandwidth 10+10+10+20+20+20 MHz - Channel Position M

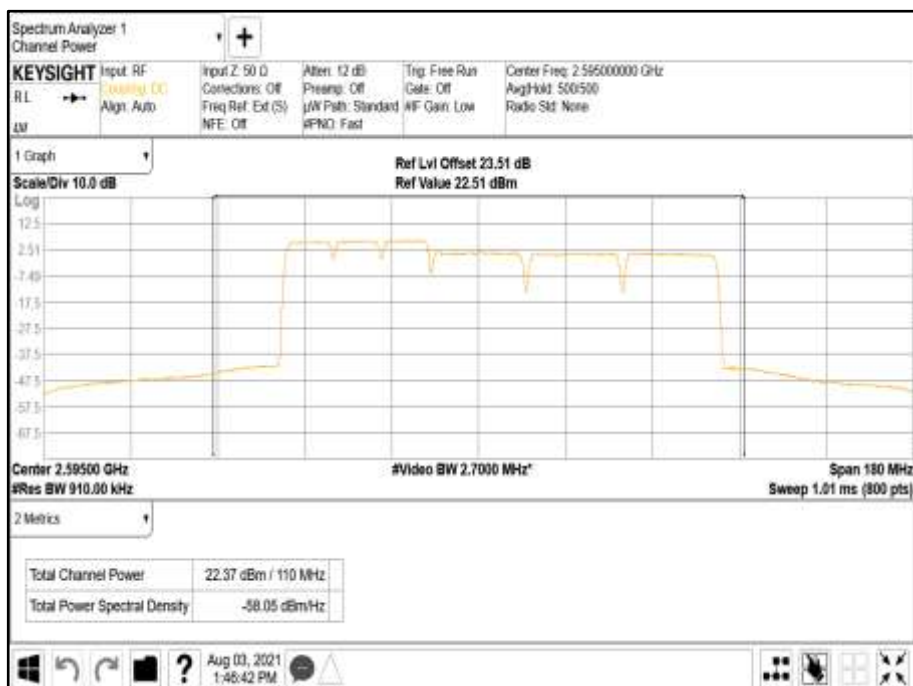

Limit	
Maximum rated output power (27.5(h))	≤ 33 dBW + 10log (X/Y) dBW



1.13 OCCUPIED BANDWIDTH

1.13.1 Specification Reference

FCC CFR 47 Part 27, Clause 27.53
 FCC CFR 47 Part 2, Clause 2.1049

1.13.2 Date of Test and Modification State

26 June 2021 - Modification State 0

1.13.3 Test Equipment Used

The major items of test equipment used for the above tests are identified in Section 3.1.

1.13.4 Environmental Conditions

Ambient Temperature 24.5°C
 Relative Humidity 29.9%

1.13.5 Test Method

All measurements were made in accordance with FCC KDB 971168 D01,

1.13.6 Test Results

Configuration A

Maximum Output Power 24.00 dBm /Port

Modulation	Carrier Bandwidth	Result (MHz)	
		Channel Bandwidth	
		Occupied Bandwidth	-26 dB Bandwidth
LTE: QPSK	LTE: 5.0 MHz	4.49	4.79
LTE: QPSK	LTE: 10.0 MHz	8.95	9.62
LTE: QPSK	LTE: 15.0 MHz	13.40	14.37
NR: QPSK	NR: 40.0 MHz	37.82	39.59
NR: QPSK	NR: 50.0 MHz	47.44	50.40
NR: QPSK	NR: 60.0 MHz	57.78	60.03
NR: QPSK	NR: 70.0 MHz	67.39	69.24
NR: QPSK	NR: 80.0 MHz	77.90	79.46
NR: QPSK	NR: 90.0 MHz	86.78	90.32

Remarks

Representative occupied bandwidth performance results presented. Plot data performance for all transmitter ports and channel positions are on file and available on request.

Modulation LTE: QPSK - LTE Carrier Bandwidth LTE: 5.0 MHz - Channel Position B

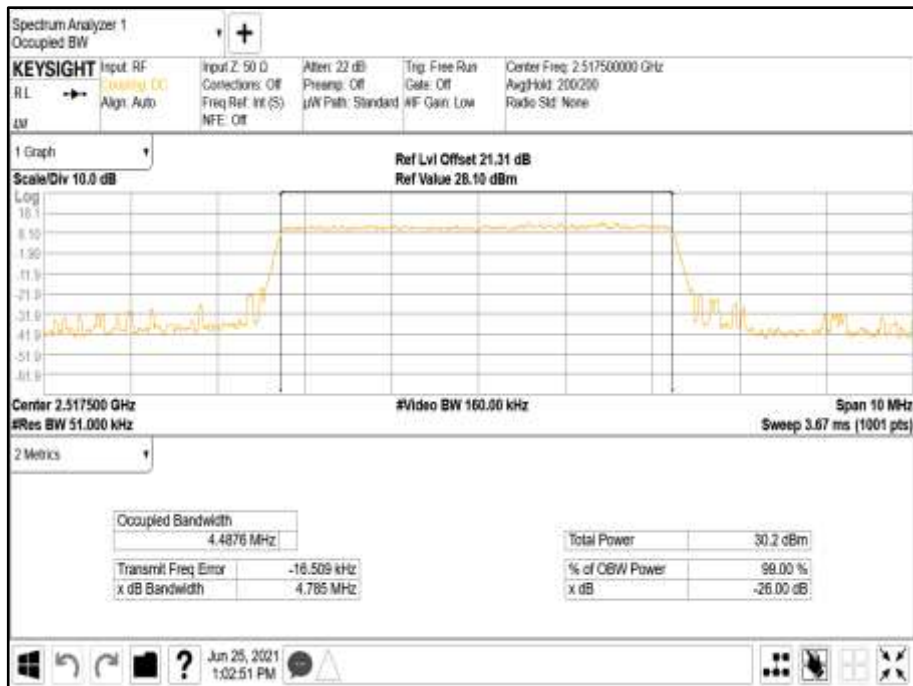

Modulation LTE: QPSK - LTE Carrier Bandwidth LTE: 10.0 MHz - Channel Position B

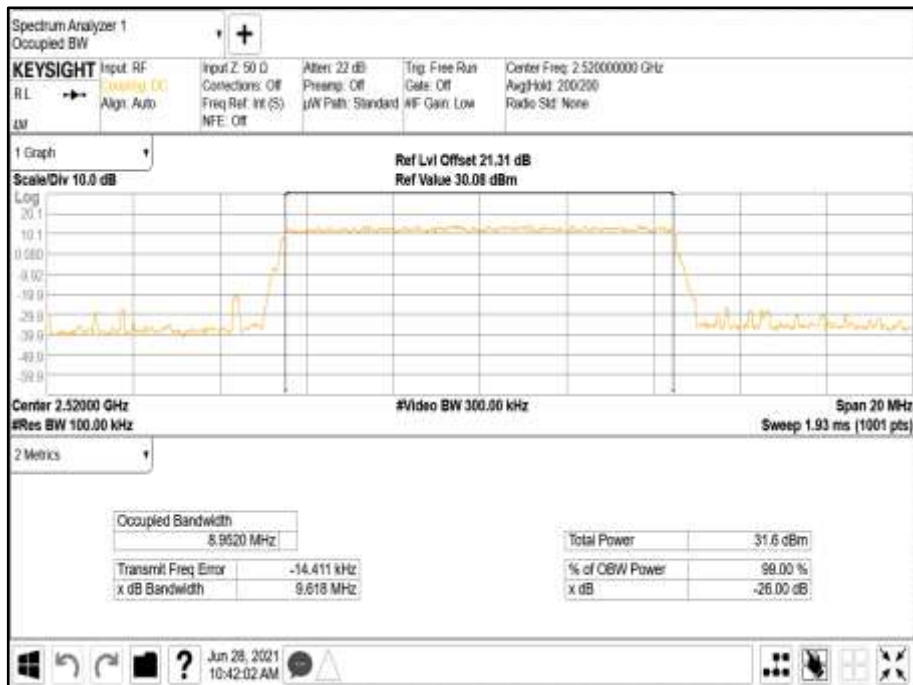



Modulation LTE: QPSK - LTE Carrier Bandwidth LTE: 15.0 MHz - Channel Position B

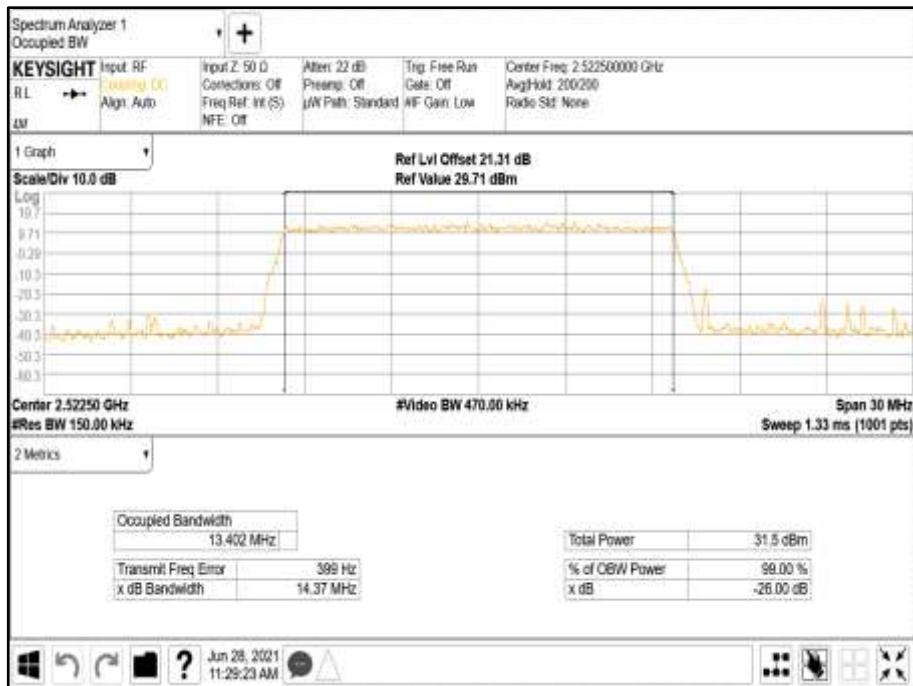

Modulation NR: QPSK - LTE Carrier Bandwidth NR: 40.0 MHz - Channel Position B

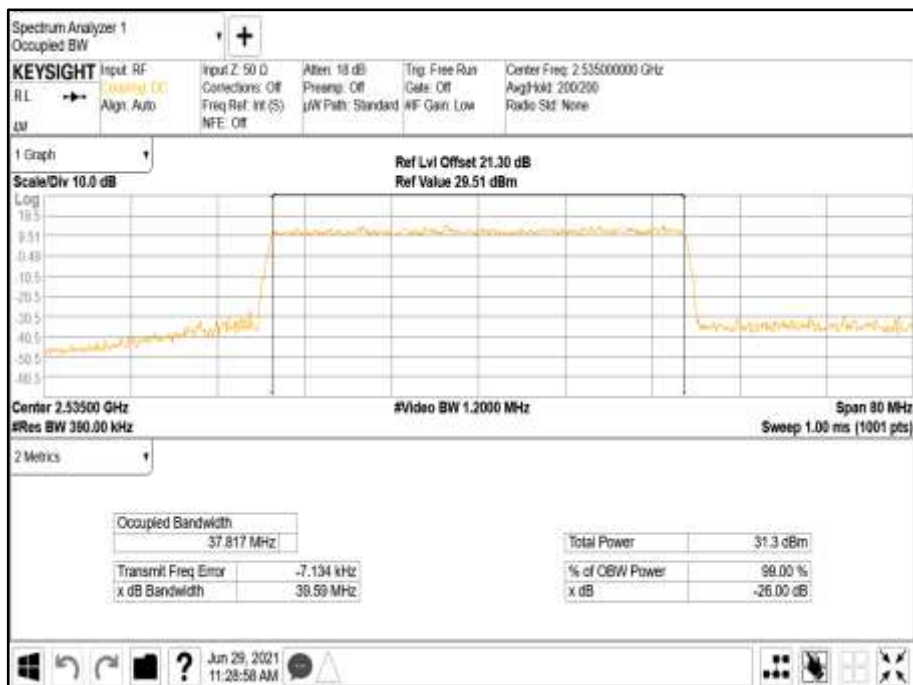



Modulation NR: QPSK - LTE Carrier Bandwidth NR: 50.0 MHz - Channel Position B

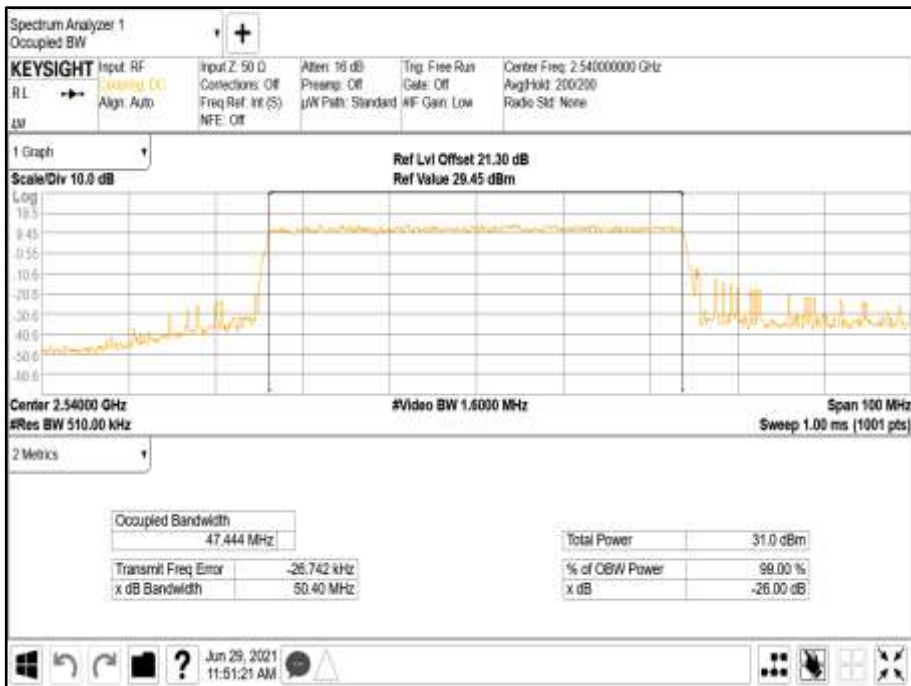

Modulation NR: QPSK - LTE Carrier Bandwidth NR: 60.0 MHz - Channel Position B

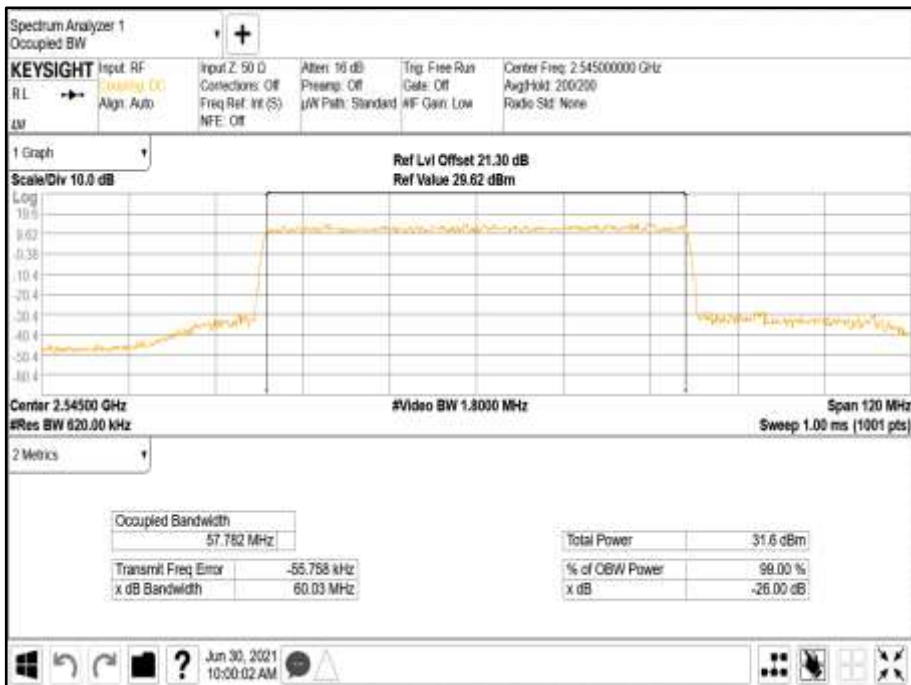



Modulation NR: QPSK - LTE Carrier Bandwidth NR: 70.0 MHz - Channel Position B

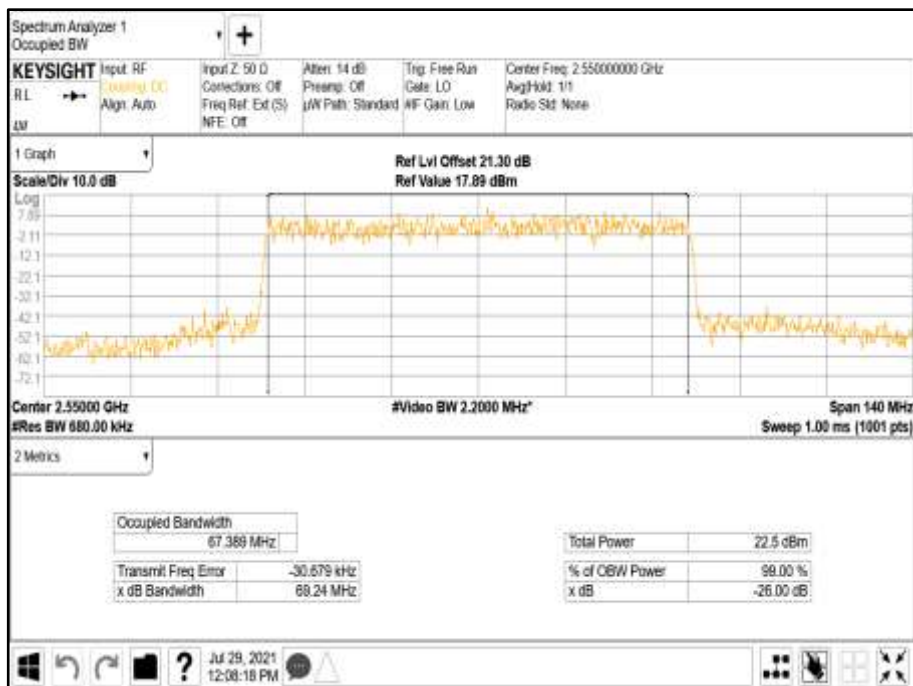

Modulation NR: QPSK - LTE Carrier Bandwidth NR: 80.0 MHz - Channel Position B

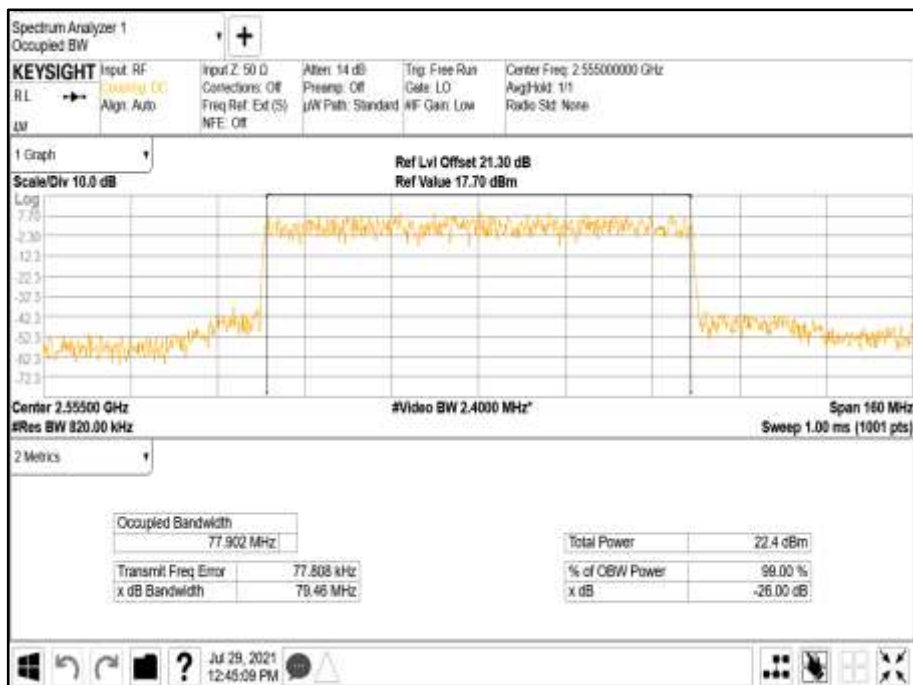



Modulation NR: QPSK - LTE Carrier Bandwidth NR: 90.0 MHz - Channel Position B

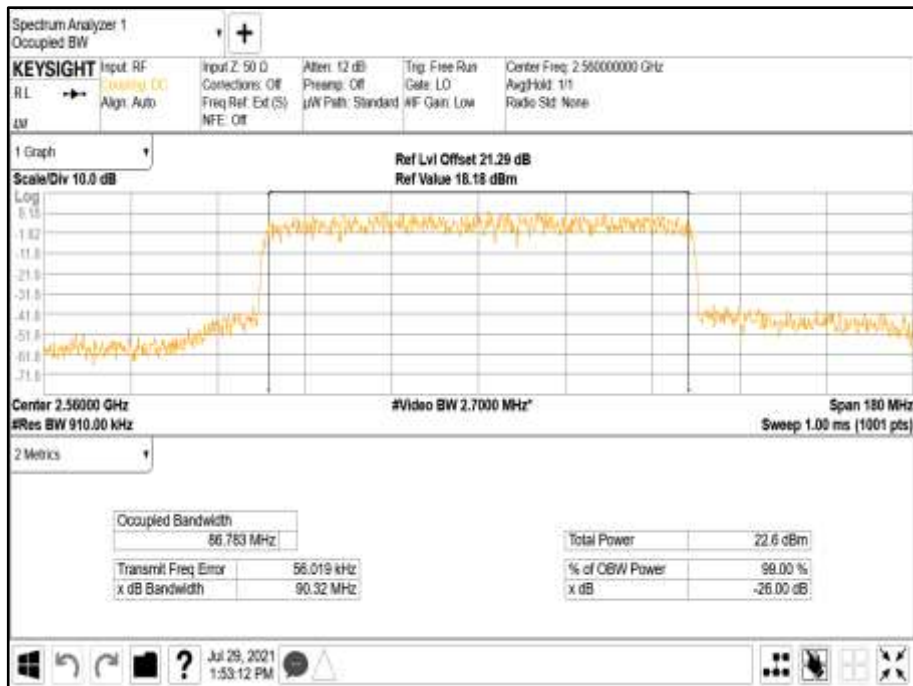



1.14 BAND EDGE

1.14.1 Specification Reference

FCC CFR 47 Part 27, Clause 27.53
 FCC CFR 47 Part 2, Clause 2.1051

1.14.2 Date of Test and Modification State

26 June and 22 August 2021 - Modification State 0

1.14.3 Test Equipment Used

The major items of test equipment used for the above tests are identified in Section 3.1.

1.14.4 Environmental Conditions

Ambient Temperature 24.5 - 25.2°C
 Relative Humidity 29.4 - 29.9%

1.14.5 Test Method

All measurements were made in accordance with FCC KDB 971168 D01, Clause 6.0.

Band Edge measurements were used an Integration Bandwidth of at least 1% of the measured 26dB Bandwidth.

Each antenna port has been declared as being equivalent, therefore measurements were made on one antenna port only. To account for this, the limit was tightened by $10 * \text{Log}(N)$, where N is equal to the number of MIMO antenna ports.

For 4 port, the limit was calculated as being $-13 \text{ dBm} - 10 * \text{Log}(4) = -19 \text{ dBm}$.

1.14.6 Test Results

Configuration A

Maximum Output Power 24.00 dBm / Port

Modulation	Carrier Bandwidth	Band Edge (MHz)	
		Channel Position B	Channel Position T
LTE: QPSK	LTE: 5.0 MHz	2,517.5	2,672.5
LTE: QPSK	LTE: 10.0 MHz	2,520.0	2,670.0
LTE: QPSK	LTE: 15.0 MHz	2,522.5	2,667.5
NR: QPSK	NR: 40.0 MHz	2,535.0	2,655.0
NR: QPSK	NR: 50.0 MHz	2,540.0	2,650.0
NR: QPSK	NR: 60.0 MHz	2,545.0	2,645.0
NR: QPSK	NR: 70.0 MHz	2,550.0	2,640.0
NR: QPSK	NR: 80.0 MHz	2,555.0	2,635.0
NR: QPSK	NR: 90.0 MHz	2,560.0	2,630.0

Remarks

1. Bandedge data was captured from the transmit port with maximum measured power.
2. Worst case bandedge data presented.



Antenna A - Modulation LTE: QPSK - Carrier Bandwidth LTE: 5.0 MHz - Channel Position B



Antenna A - Modulation LTE: QPSK - Carrier Bandwidth LTE: 5.0 MHz - Channel Position T

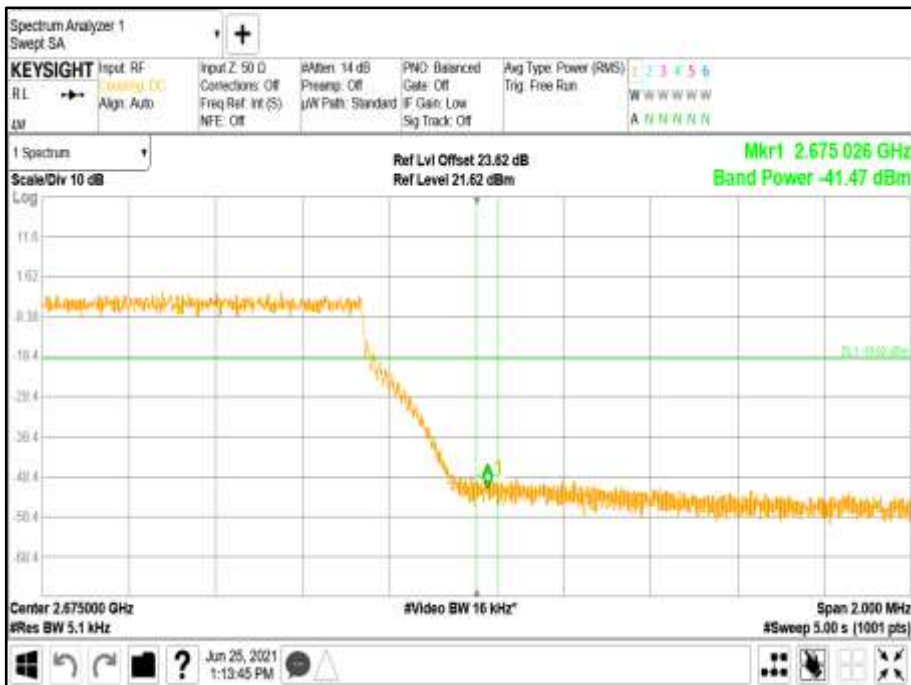



Antenna A - Modulation LTE: QPSK - Carrier Bandwidth LTE: 10.0 MHz - Channel Position B



Antenna A - Modulation LTE: QPSK - Carrier Bandwidth LTE: 10.0 MHz - Channel Position T

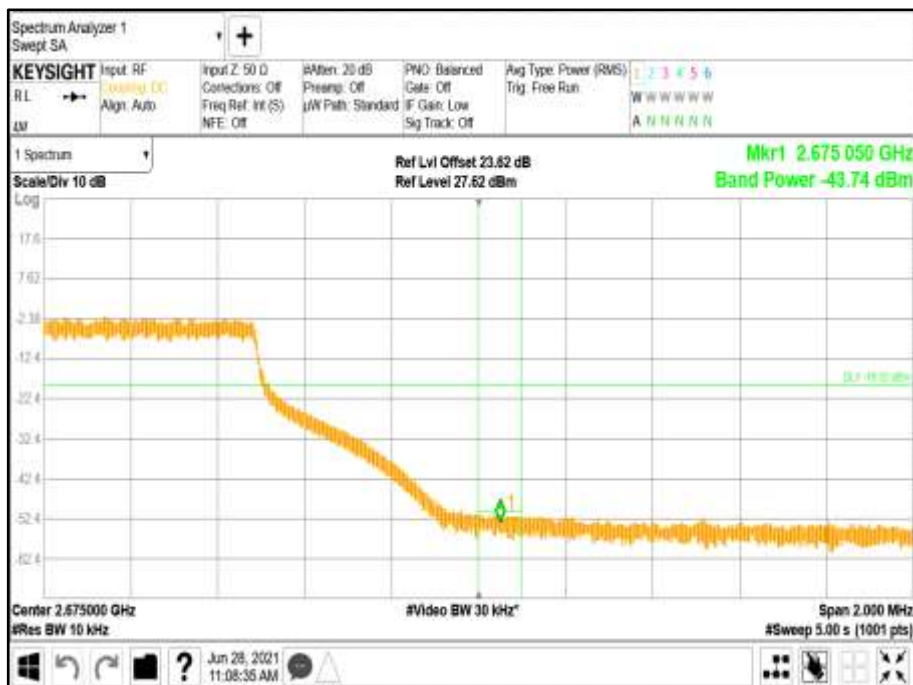



Antenna A - Modulation LTE: QPSK - Carrier Bandwidth LTE: 15.0 MHz - Channel Position B



Antenna A - Modulation LTE: QPSK - Carrier Bandwidth LTE: 15.0 MHz - Channel Position T





Antenna A - Modulation NR: QPSK - Carrier Bandwidth NR: 40.0 MHz - Channel Position B



Antenna A - Modulation NR: QPSK - Carrier Bandwidth NR: 40.0 MHz - Channel Position T





Antenna A - Modulation NR: QPSK - Carrier Bandwidth NR: 50.0 MHz - Channel Position B



Antenna A - Modulation NR: QPSK - Carrier Bandwidth NR: 50.0 MHz - Channel Position T





Antenna A - Modulation NR: QPSK - Carrier Bandwidth NR: 60.0 MHz - Channel Position B



Antenna A - Modulation NR: QPSK - Carrier Bandwidth NR: 60.0 MHz - Channel Position T



Antenna A - Modulation NR: QPSK - Carrier Bandwidth NR: 70.0 MHz - Channel Position B



Antenna A - Modulation NR: QPSK - Carrier Bandwidth NR: 70.0 MHz - Channel Position T





Antenna A - Modulation NR: QPSK - Carrier Bandwidth NR: 80.0 MHz - Channel Position B

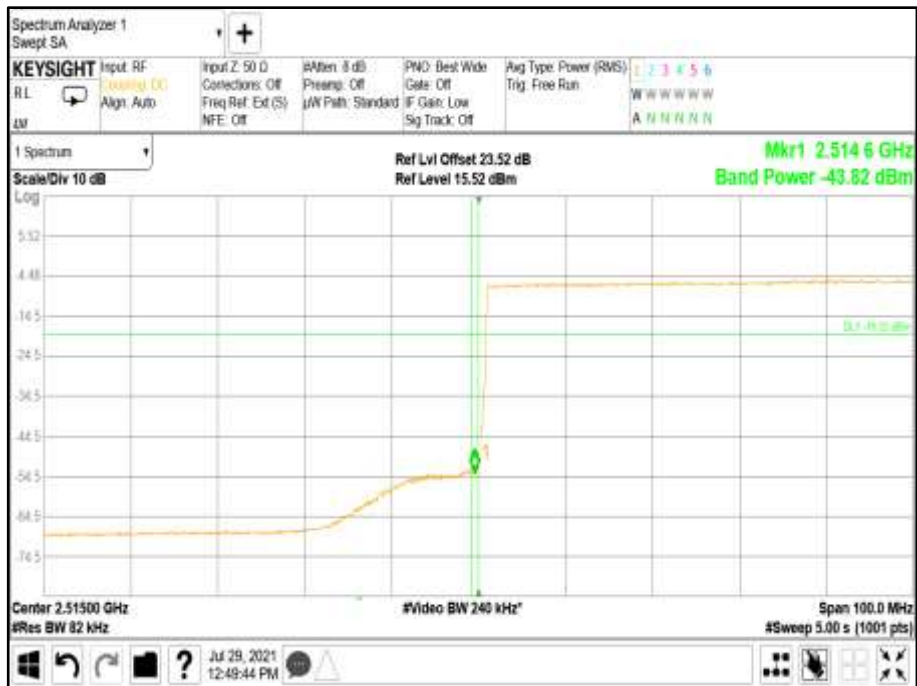

Antenna A - Modulation NR: QPSK - Carrier Bandwidth NR: 80.0 MHz - Channel Position T





Antenna A - Modulation NR: QPSK - Carrier Bandwidth NR: 90.0 MHz - Channel Position B



Antenna A - Modulation NR: QPSK - Carrier Bandwidth NR: 90.0 MHz - Channel Position T





Configuration B

Maximum Output Power 24.00 dBm / Port

Antenna	Modulation	Carrier Bandwidth	Band Edge (MHz)	
			Channel Position B	Channel Position T
A	NR: QPSK	40.0+40.0 MHz	2535.0+2575.0	2615.0+2655.0
A	NR: QPSK	50.0+50.0 MHz	2540.0+2590.0	2600.0+2650.0
A	LTE5+NR20: QPSK	L5.0+NR20.0 MHz	2517.5+2530.0	2652.5+2665.0

Remarks

The plot results represent typical radio performance.



Antenna A - Modulation NR: QPSK - Carrier Bandwidth 40.0+40.0 MHz - Channel Position B



Antenna A - Modulation NR: QPSK - Carrier Bandwidth 40.0+40.0 MHz - Channel Position T





Antenna A - Modulation NR: QPSK - Carrier Bandwidth 50.0+50.0 MHz - Channel Position B



Antenna A - Modulation NR: QPSK - Carrier Bandwidth 50.0+50.0 MHz - Channel Position T





Antenna A - Modulation LTE5+NR20: QPSK - Carrier Bandwidth L5.0+NR20.0 MHz - Channel Position B



Antenna A - Modulation LTE5+NR20: QPSK - Carrier Bandwidth L5.0+NR20.0 MHz - Channel Position T





Configuration C

Maximum Output Power 24.00 dBm / Port

Antenna A - Modulation LTE: QPSK - Carrier Bandwidth 5+5+5+5+5+5 MHz - Channel Position B

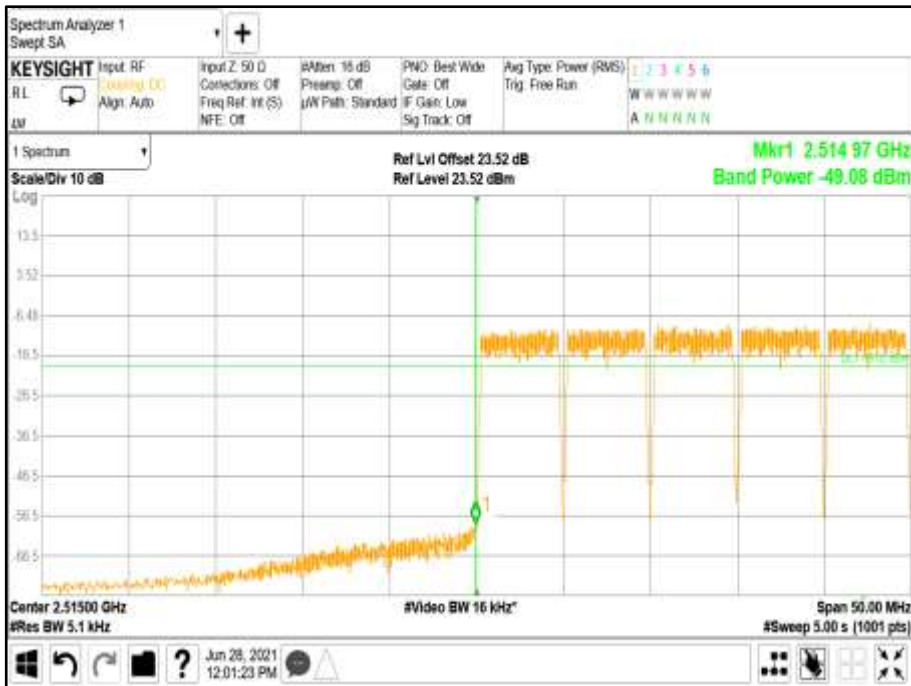

Antenna A - Modulation LTE: QPSK - Carrier Bandwidth 5+5+5+5+5+5 MHz - Channel Position I

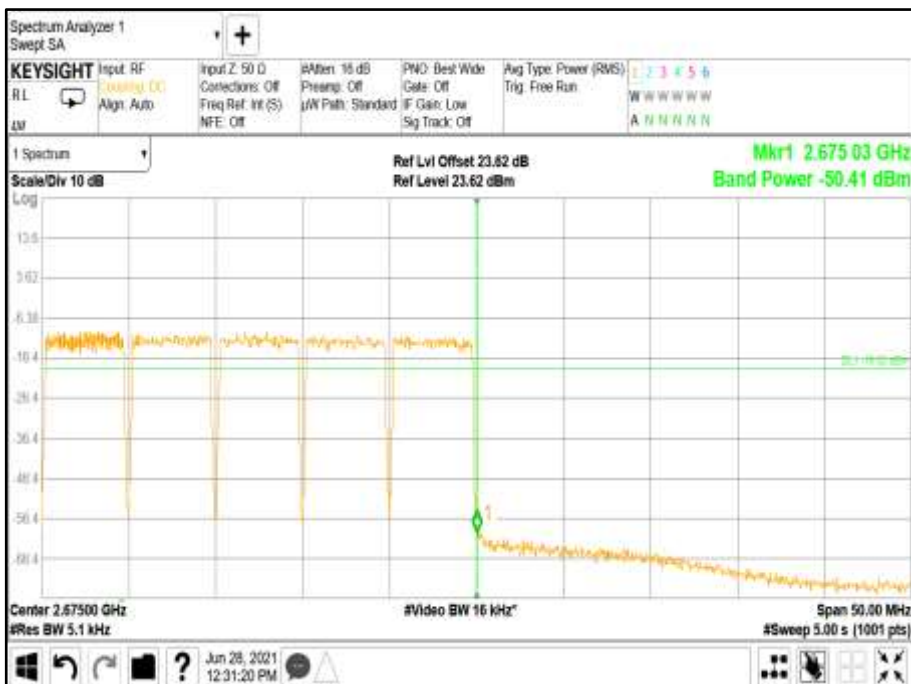



Antenna A - Modulation LTE: QPSK - Carrier Bandwidth 10+10+10+10+10+10 MHz - Channel Position B



Antenna A - Modulation LTE: QPSK - Carrier Bandwidth 10+10+10+10+10+10 MHz - Channel Position T





Antenna A - Modulation LTE: QPSK - Carrier Bandwidth 15+15+15+15+15 MHz - Channel Position B

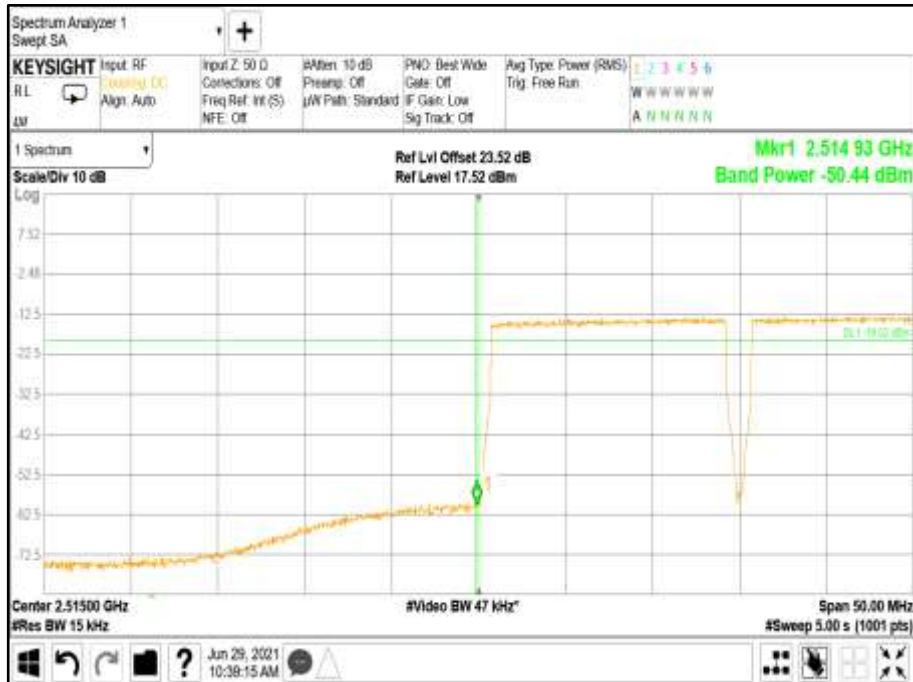

Antenna A - Modulation LTE: QPSK - Carrier Bandwidth 15+15+15+15+15 MHz - Channel Position T





Antenna A - Modulation LTE10+NR20: QPSK - Carrier Bandwidth 10+10+10+20+20+20 MHz - Channel Position B



Antenna A - Modulation LTE10+NR20: QPSK - Carrier Bandwidth 10+10+10+20+20+20 MHz - Channel Position T





FCC Part 27.50 Clauses (m)(2)(v)

Limit	
Emission Limits	≤ -19 dBm/MHz (4 TX ports)



1.15 TRANSMITTER SPURIOUS EMISSIONS

1.15.1 Specification Reference

FCC CFR 47 Part 27, Clause 27.53
FCC CFR 47 Part 2, Clause 2.1051

1.15.2 Date of Test and Modification State

26 June and 23 August 2021 - Modification State 0

1.15.3 Test Equipment Used

The major items of test equipment used for the above tests are identified in Section 3.1.

1.15.4 Environmental Conditions

Ambient Temperature	24.5 - 25.2°C
Relative Humidity	29.4 - 29.9%

1.15.5 Test Method

All measurements were made in accordance with FCC KDB 971168 D01, Clause 6.1.

Each antenna port has been declared as being equivalent, therefore measurements were made on one antenna port only. To account for this, the limit was tightened by $10 * \text{Log}(N)$, where N is equal to the number of MIMO antenna ports.

For 4 port, the limit was calculated as being $-13 \text{ dBm} - 10 * \text{Log}(4) = -19 \text{ dBm}$.

1.15.6 Test Results

Configuration A

Maximum Output Power 24.00 dBm / Port

Remarks

1. Transceiver spurious emissions have been searched for all channel bandwidths and antenna ports.
2. Representative spurious emissions performance using the most narrow channel bandwidth has been presented. The smallest Ch BW has been found to result in the worst case performance.
3. Plot data performance for all channel bandwidths, and channel positions are on file and available on request.



Modulation LTE: QPSK - Carrier Bandwidth 5.0 MHz - Channel Position B - Band 1.00 - Range 0.009 to 4000 MHz

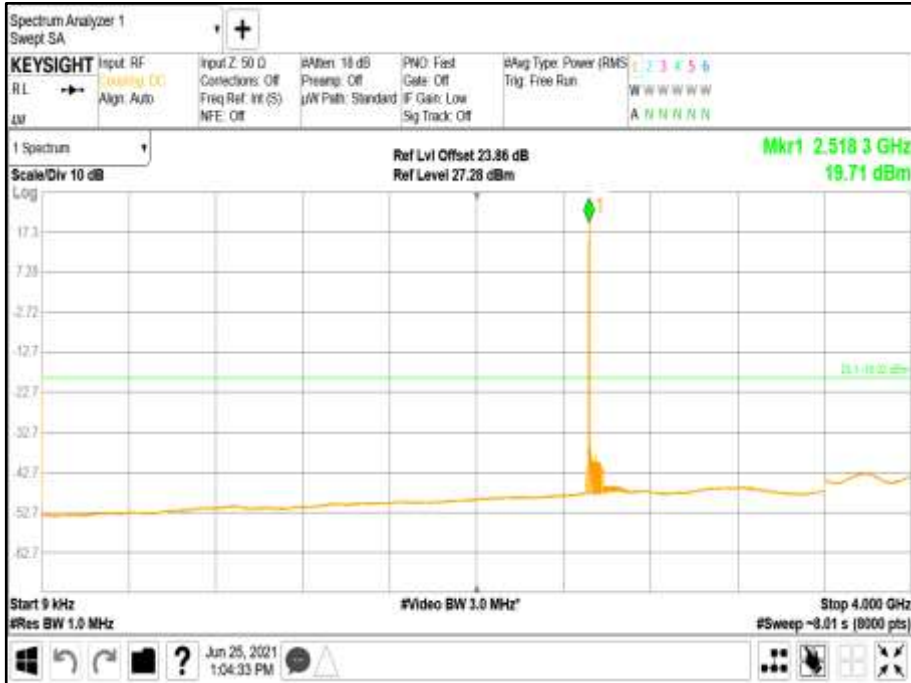

Modulation LTE: QPSK - Carrier Bandwidth 5.0 MHz - Channel Position B - Band 2 - Range 4000 to 12000 MHz

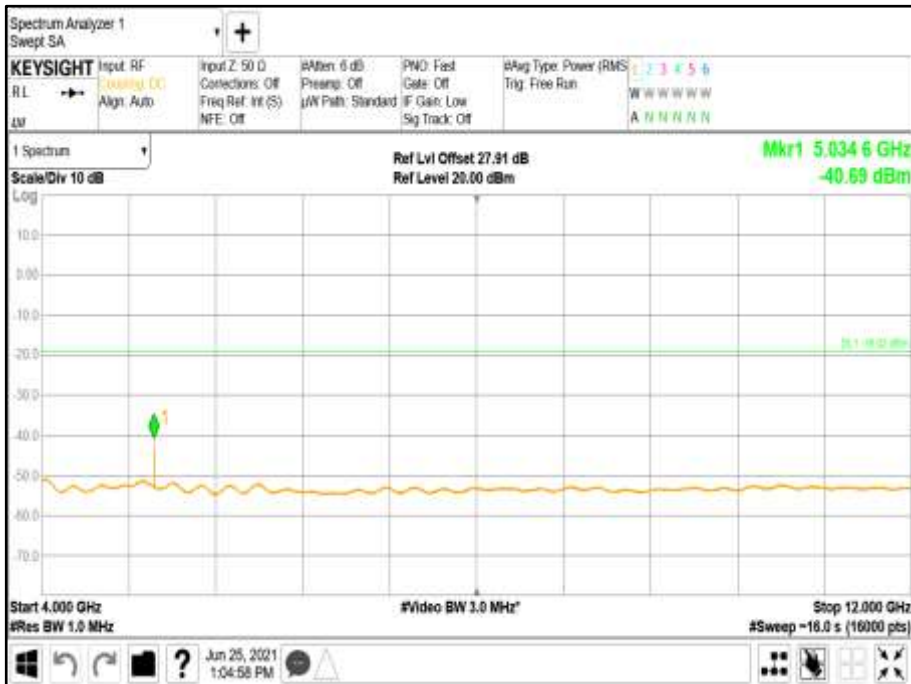



Modulation LTE: QPSK - Carrier Bandwidth 5.0 MHz - Channel Position B - Band 3 - Range 12000 to 18000 MHz



Modulation LTE: QPSK - Carrier Bandwidth 5.0 MHz - Channel Position B - Band 4 - Range 18000 to 27000 MHz





Modulation NR: QPSK - Carrier Bandwidth 40.0 MHz - Channel Position B - Band 1.00 - Range 0.009 to 4000 MHz

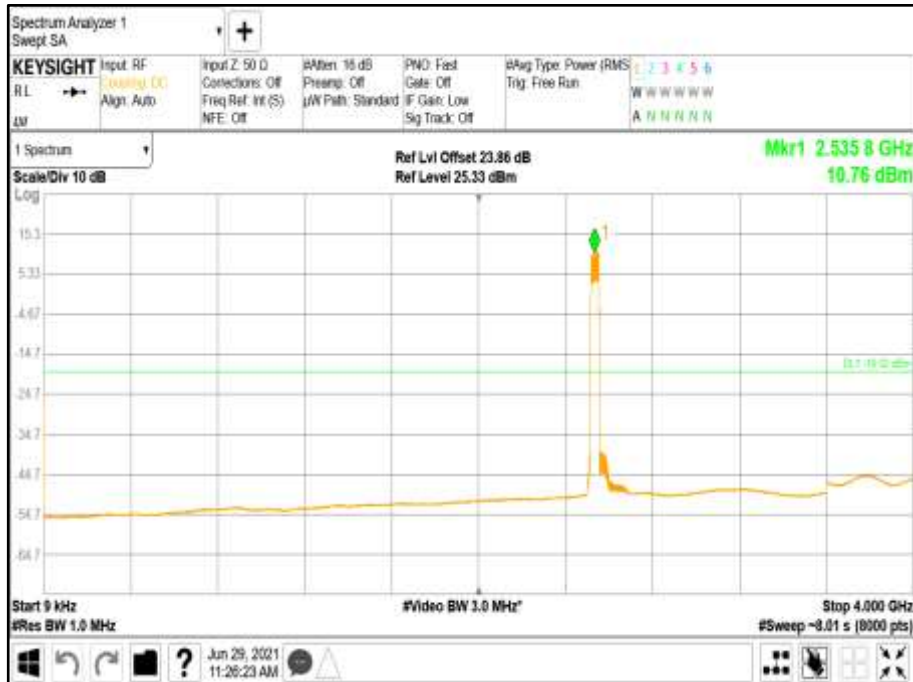

Modulation NR: QPSK - Carrier Bandwidth 40.0 MHz - Channel Position B - Band 2 - Range 4000 to 12000 MHz

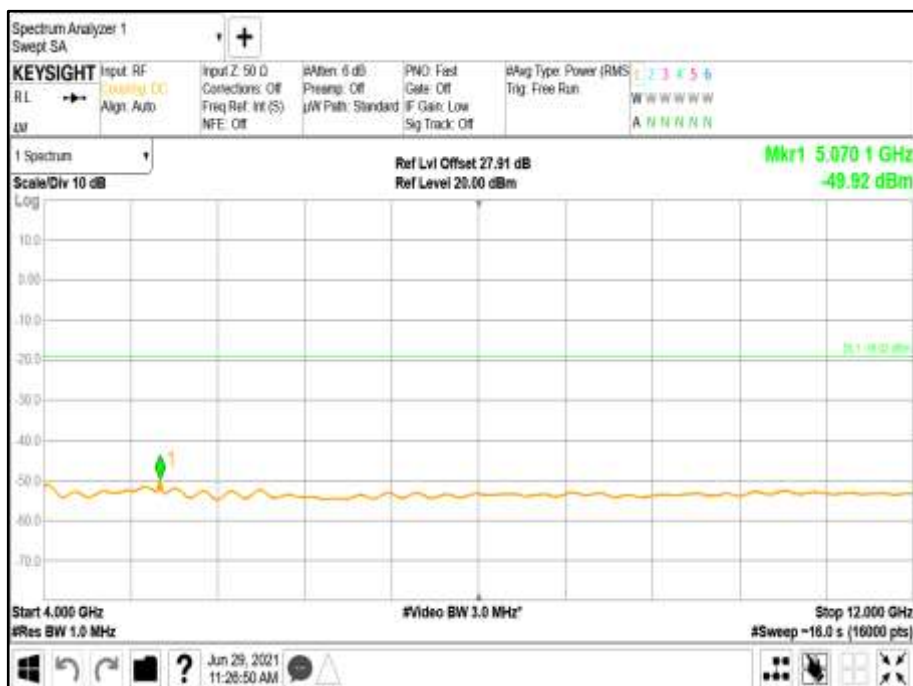



Modulation NR: QPSK - Carrier Bandwidth 40.0 MHz - Channel Position B - Band 3 - Range 12000 to 18000 MHz



Modulation NR: QPSK - Carrier Bandwidth 40.0 MHz - Channel Position B - Band 4 - Range 18000 to 27000 MHz

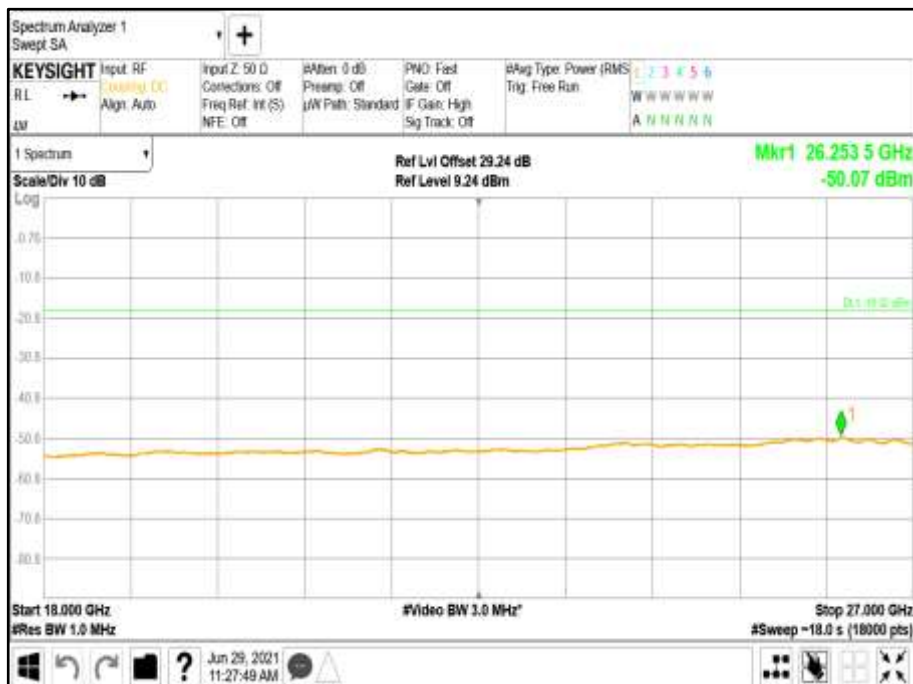



Configuration B

Maximum Output Power 24.00 dBm / Port

Modulation NR: QPSK - Carrier Bandwidth 40.0+40.0 MHz - Channel Position M - Band 1.00 - Range 0.009 to 4000 MHz

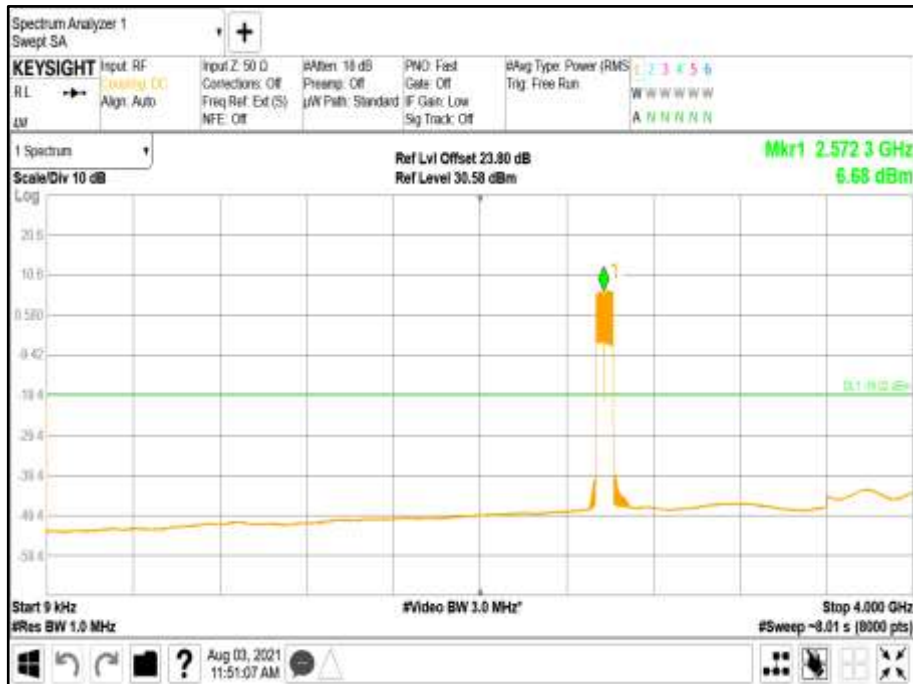

Modulation NR: QPSK - Carrier Bandwidth 40.0+40.0 MHz - Channel Position M - Band 2 - Range 4000 to 12000 MHz

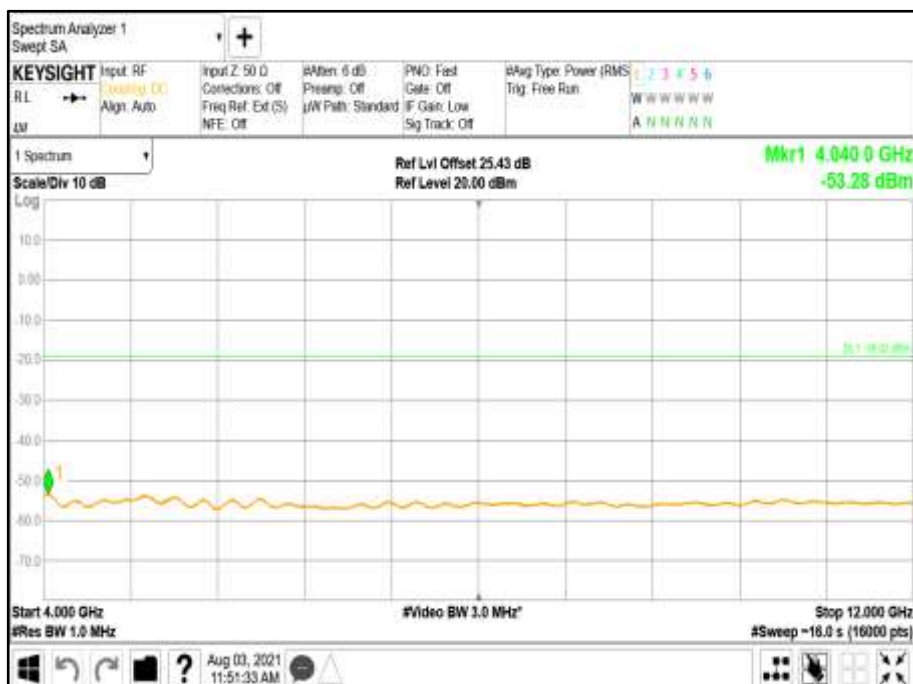



Modulation NR: QPSK - Carrier Bandwidth 40.0+40.0 MHz - Channel Position M - Band 3 - Range 12000 to 18000 MHz



Modulation NR: QPSK - Carrier Bandwidth 40.0+40.0 MHz - Channel Position M - Band 4 - Range 18000 to 27000 MHz

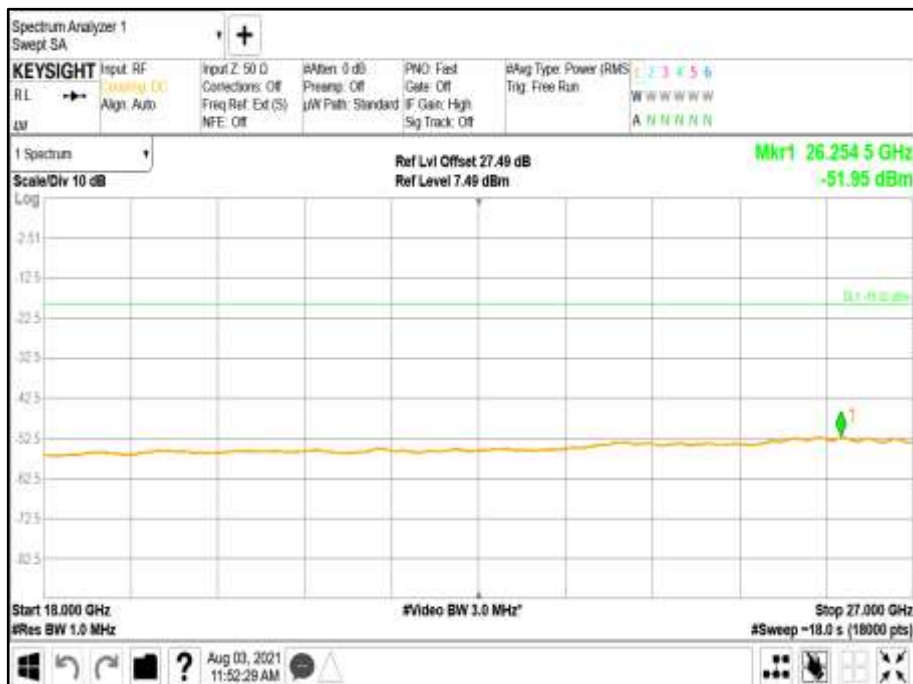



Modulation LTE5+NR20: QPSK - Carrier Bandwidth L5.0+NR20.0 MHz - Channel Position M - Band 1.00 - Range 0.009 to 4000 MHz

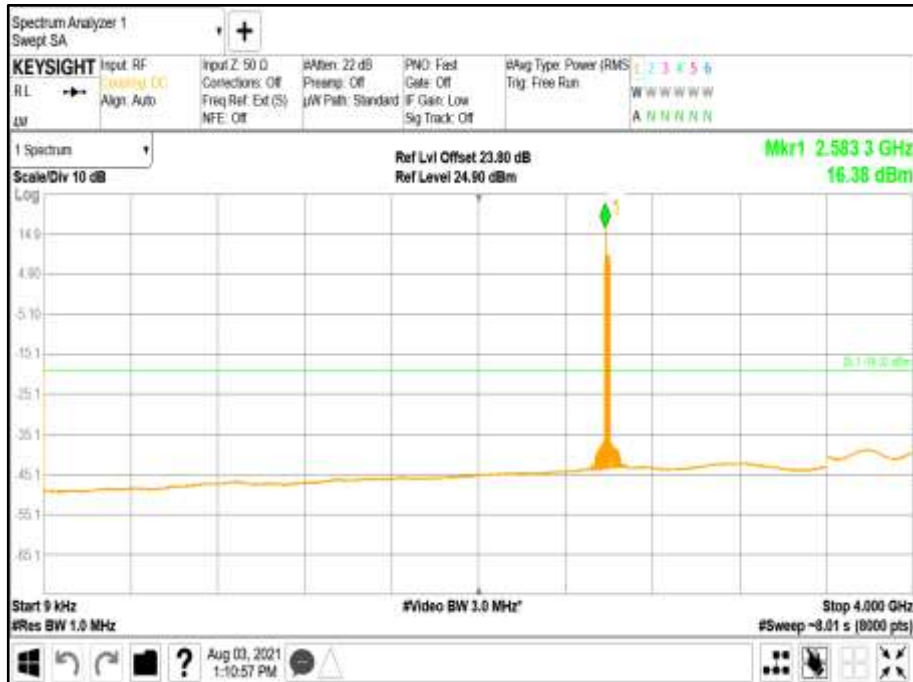

Modulation LTE5+NR20: QPSK - Carrier Bandwidth L5.0+NR20.0 MHz - Channel Position M - Band 2 - Range 4000 to 12000 MHz

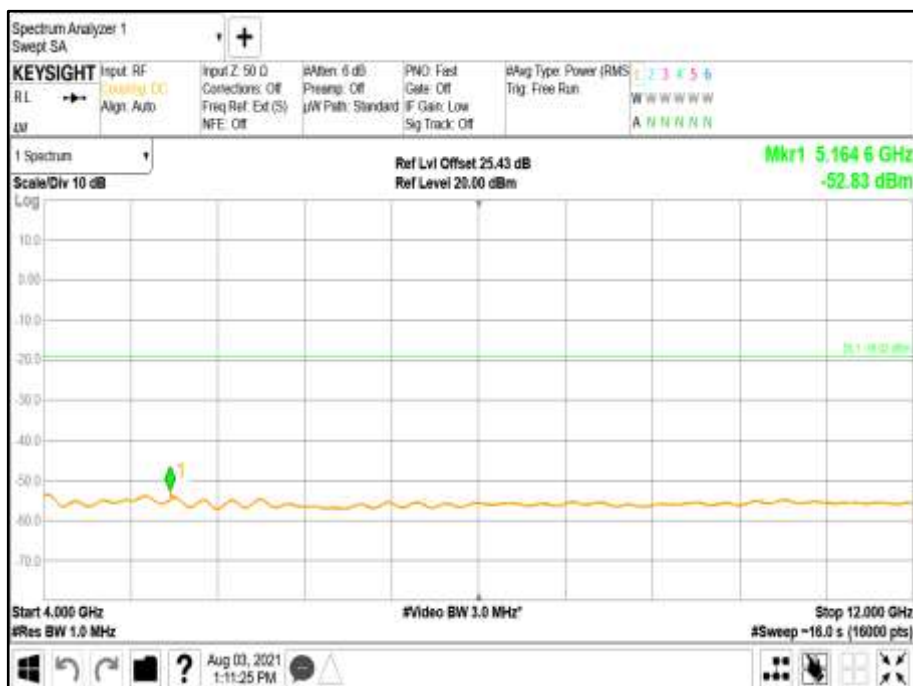



Modulation LTE5+NR20: QPSK - Carrier Bandwidth L5.0+NR20.0 MHz - Channel Position M - Band 3 - Range 12000 to 18000 MHz



Modulation LTE5+NR20: QPSK - Carrier Bandwidth L5.0+NR20.0 MHz - Channel Position M - Band 4 - Range 18000 to 27000 MHz

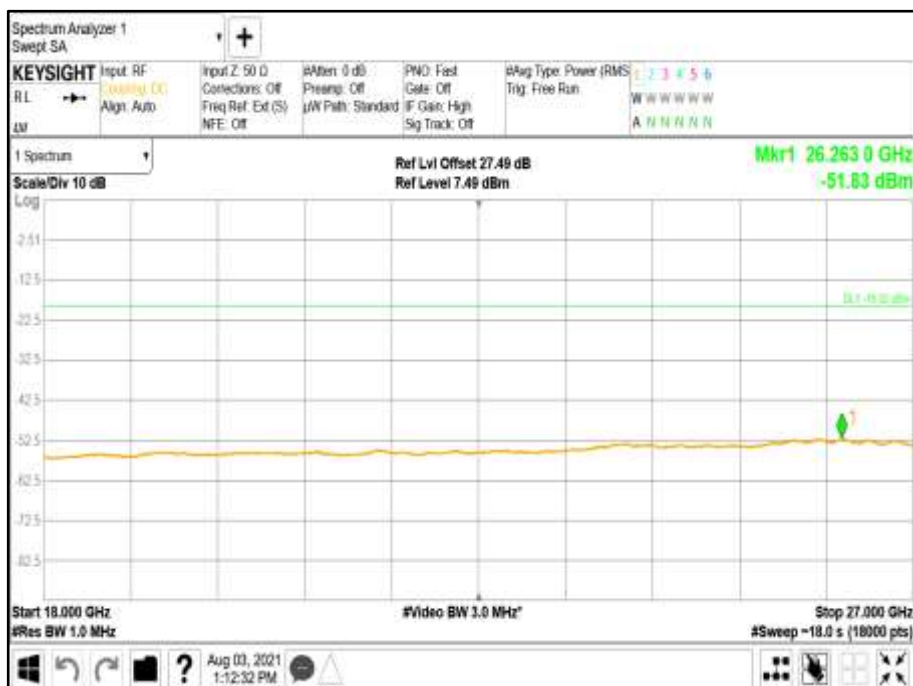



Configuration C

Maximum Output Power 24.00 dBm Port

Modulation LTE: QPSK - Carrier Bandwidth 5+5+5+5+5+5 MHz - Channel Position M - Band 1.00 - Range 0.009 to 4000 MHz

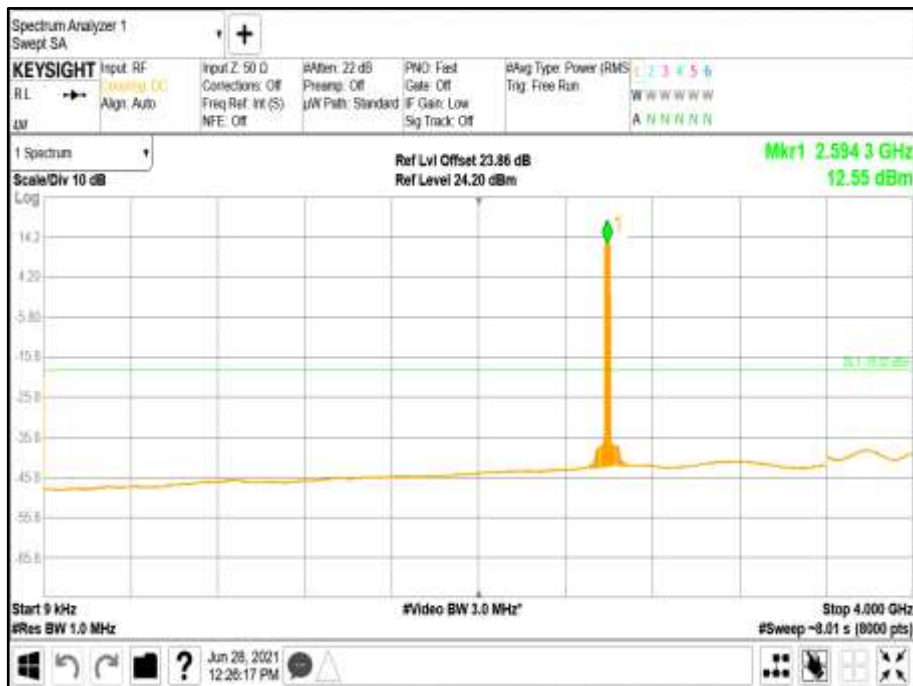

Modulation NR: QPSK - Carrier Bandwidth 5+5+5+5+5+5 MHz - Channel Position M - Band 2 - Range 4000 to 12000 MHz

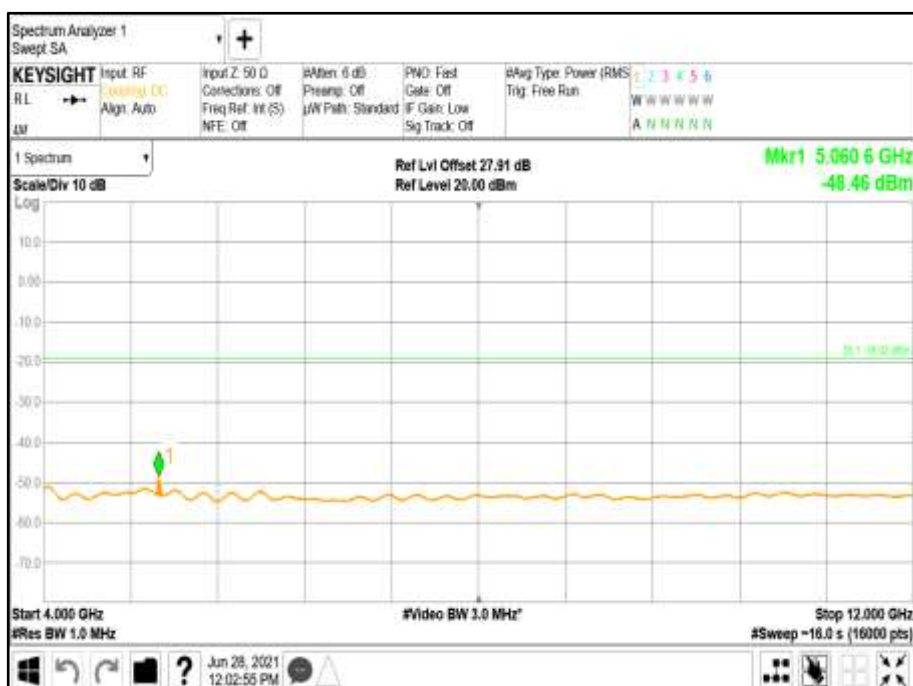



Modulation NR: QPSK - Carrier Bandwidth 5+5+5+5+5+5 MHz - Channel Position M - Band 3 - Range 12000 to 18000 MHz



Modulation NR: QPSK - Carrier Bandwidth 5+5+5+5+5+5 MHz - Channel Position M - Band 4 - Range 18000 to 27000 MHz

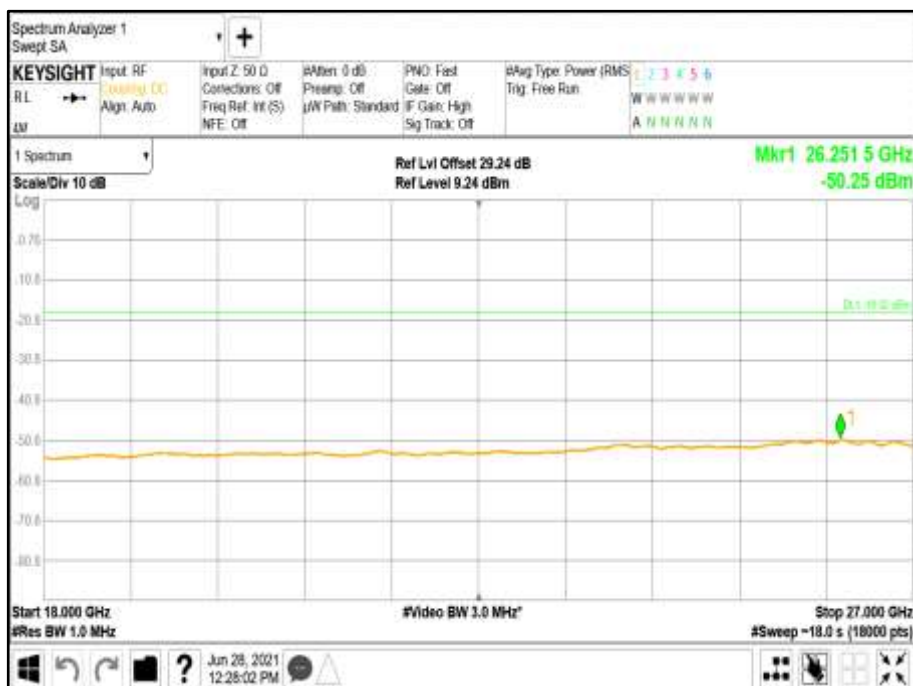



Modulation LTE10+NR20: QPSK - Carrier Bandwidth 10+10+10+20+20+20 MHz - Channel Position M - Band 1.00 - Range 0.009 to 4000 MHz

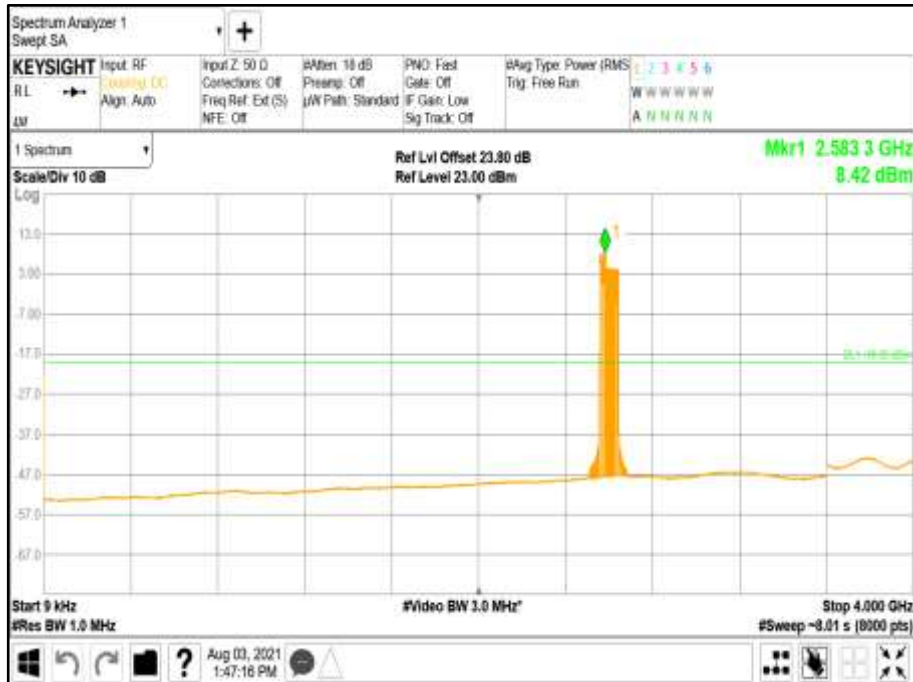

Modulation LTE10+NR20: QPSK - Carrier Bandwidth 10+10+10+20+20+20 MHz - Channel Position M - Band 2 - Range 4000 to 12000 MHz

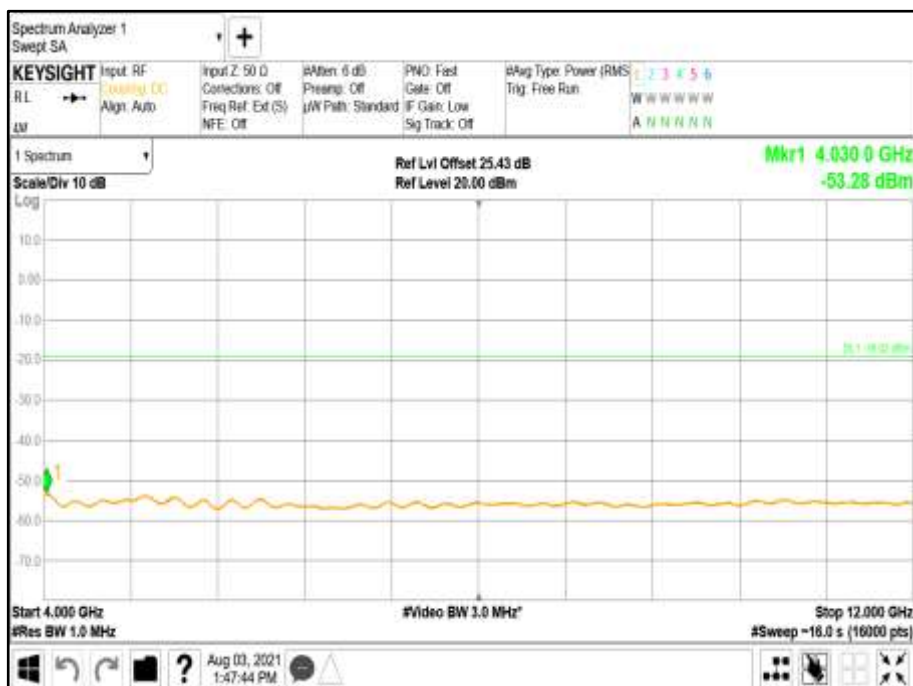



Modulation LTE10+NR20: QPSK - Carrier Bandwidth 10+10+10+20+20+20 MHz - Channel Position M - Band 3 - Range 12000 to 18000 MHz



Modulation LTE10+NR20: QPSK - Carrier Bandwidth 10+10+10+20+20+20 MHz - Channel Position M - Band 4 - Range 18000 to 27000 MHz



Limit	The power of any emission outside of the authorized operating frequency ranges must be attenuated below the transmitting power (P) by a factor of at least $43 + 10 \log(P)$ db / Port. < -19dBm / MHz
-------	-----------------------------------------------------------------------------------------------------------------------------------------------------------------------------------------------------------



SECTION 4

TEST EQUIPMENT USED



2.1 TEST EQUIPMENT USED

List of absolute measuring and other principal items of test equipment.

Instrument	Manufacturer	Type No.	TE No.	Calibration Period (months)	Calibration Due
Spectrum Analyzer	Keysight	PXA N9030B	MY57144347	24	24-Apr-2022
Thermometer	VWR	61161-364	192595396.00	24	25-Oct-2021
PSU	Xantrex	XKW60-50	E00109862	-	O/P Mon
Attenuator (20dB)	Mini-Circuits	BW-K10-2W44+	-	-	O/P Mon
Climate Chamber	Burnsco	RTC-37P-3-3	-07-07	-	O/P Mon

N/A – Not Applicable

O/P Mon – Output Monitored with Calibrated Equipment



2.1 MEASUREMENT UNCERTAINTY

For a 95% confidence level, the measurement uncertainties for defined systems are:-

Test Discipline	Frequency / Parameter	MU	
Conducted Maximum Peak Output Power	30 MHz to 20 GHz Amplitude	± 0.7 dB	
Conducted Emissions	30 MHz to 20 GHz Amplitude	± 2.1 dB	
Frequency Stability	30 MHz to 2 GHz	± 5.0 Hz	
Occupied Bandwidth	Up to 20 MHz Bandwidth	5 MHz Bandwidth	± 11547 Hz
		10 MHz Bandwidth	± 23094 Hz
		15 MHz Bandwidth	± 34641 Hz
		20 MHz Bandwidth	± 46188 Hz
Band Edge	30 MHz to 20 GHz Amplitude	±0.8 dB	
Radiated Spurious Emissions	30 MHz to 1 GHz	± 5.2 dB	
	1 GHz to 40GHz	± 6.3 dB	

Measurement Uncertainty Decision Rule

Determination of conformity with the specification limits is based on the decision rule according to IEC Guide 115: 2007, clause 4.4.3 and 4.5.1.



SECTION 4

ACCREDITATION, DISCLAIMERS AND COPYRIGHT



3.1 ACCREDITATION, DISCLAIMERS AND COPYRIGHT



This report relates only to the actual item/items tested.

This report does not imply product endorsement by any government, accreditation agency, or TÜV SÜD Canada Inc.

Opinions or interpretations expressed in this report, if any, are outside the scope of TÜV SÜD Canada Inc. accreditations. Any opinions expressed do not necessarily reflect the opinions of TÜV SÜD Canada Inc., unless otherwise stated.

This report relates only to the actual item/items tested

© 2021 TÜV SÜD



ANNEX A

MODULE LIST



Configuration A/B/C			
Product	Product No	R-State	Serial No
CT11	LPC 102 494/1	R2A	T01G495060
IRU 8846	KRC 161 754/2	R1A	D828508475
DOT 4489 B41K (EUT)	KRY 901 432/2	R1B	TD3T789158
Software Version:	CXP9013268/17	Revision:	R86BB920