



EMC Test Report

for

RD 4442 B25B66A, RD 2243 B25 and RD 2243 B66A (NR + LTE with NBloT GB signal)

Tested to: **FCC Part 15 Subpart B / ICES 003**
FCC Part 24 (Section 24.238(a))
FCC Part 27 (Section - 27.53(h))
RSS-Gen (Section 7.0)
RSS-133 (Section 6.5)
RSS-139 (Section 6.6)

Test Result summary

FCC/ ICES/ RSS Section	Description	Specification/Method	Pass or Fail	Results in section
15.109 / 6.2	Radiated Emissions (RE)	FCC Part 15 / ICES 003 / ANSI C63.4	Pass	3.2
7.0	Receiver Emissions Limits	RSS-Gen / ANSI C63.4	Pass	3.2
15.107 / 6.1	Conducted Emissions (CE) for AC Power	FCC Part 15 / ICES 003 / ANSI C63.4	Not Applicable	
27.53(h)	Transmitter Spurious Emissions (RE)	FCC Part 27 / ANSI C63.26	Pass	3.2
24.238(a)	Out of band Emissions (RE)	FCC Part 24 / ANSI C63.26	Pass	3.2
RSS-133 / 6.5	Transmitter unwanted Emissions	RSS-133 / ANSI C63.26	Pass	3.2
RSS-139 / 6.6	Transmitter unwanted Emissions	RSS-139 / ANSI C63.26	Pass	3.2

Document number: 7169009141-TR-EMC-01-01-F15

Release date: 8 March, 2021

Prepared for: Ericsson Canada



About this document

This document is written and distributed by TÜV SÜD Canada Inc. Whenever TÜV SÜD is mentioned in this document it shall be taken as referring to TÜV SÜD Canada Inc.

This test report does not imply product endorsement by any government, accreditation agency, or TÜV SÜD Canada Inc. Opinions or interpretations expressed in this report, if any, are outside the scope of the accreditations of TÜV SÜD Canada Inc. Any opinions expressed do not necessarily reflect the opinions of TÜV SÜD Canada Inc, unless otherwise stated.

Throughout this document:

- text in **blue** font is a clickable link
- text in *italics* is provided as-is from the customer

The release control record, document approvals, and laboratory Accreditations are as follows.

Release control record

This document is based on document template KG000347-TR-EMC-08-03.

Issue	Reason for change	Date released
01	initial release	8 March, 2021

Approvals

Function	Name	Job title	Signature
Technical Reviewer	Scott Drysdale	Canada Wireless Manager	
Author	Kasi Sivaratnam	EMC Test Engineer	

Accreditations

The test facilities of TÜV SÜD Canada Inc are accredited by the American Association for Laboratory Accreditation (A2LA) to ISO/IEC 17025:2017 in accordance with the scope of accreditation outlined at the website portal.a2la.org/scopepdf/2955-19.pdf.

 <p>A2LA Cert. No. 2955.19</p>	<p>DISCLAIMER AND COPYRIGHT</p> <p>This non-binding report has been prepared by TÜV SÜD Canada with all reasonable skill and care. The document is confidential to the potential Client and TÜV SÜD Canada. No part of this document may be reproduced without the prior written approval of TÜV SÜD Canada.</p> <p>© TÜV SÜD.</p>
	<p>ACCREDITATION</p> <p>Our A2LA Accreditation does not cover opinions and interpretations and any expressed are outside the scope of our A2LA Accreditation.</p>

The Canadian lab registration number associated with the TÜV SÜD test facilities is 24015.

Test lab information

Lab name	TÜV SÜD Canada Inc
Company name	TÜV SÜD Canada Inc
Mailing or shipping address	1280 Teron Road, Ottawa, Ontario, K2K 2C1, Canada
Primary technical contact	Stephen Tippet
Title	Lab Manager
Phone	613-668-5149

Customer information

Company name	Ericsson Canada
Mailing address	349 Terry Fox Drive, Ottawa, On, K2K 2V6, Canada
Primary contact	Denis Lalonde
Title	Team Leader RA Verification
Phone	613-790-2901
E-mail	Denis.lalonde@ericsson.com



Table of contents

About this document	2
1. Executive summary	9
1.1 Compliance summary	10
2. Details of the equipment under test	12
2.1 Assessed hardware	12
2.2 Product overview	12
2.3 Product port definition and EUT cable information	15
2.4 Configurations of the EUT.....	15
2.4.1 Radiated Emissions Single RAT / Single Carrier (LTE + NBloT GB)	16
2.4.2 Radiated Emissions Single RAT / Single Carrier (NR).....	17
2.4.3 Radiated Emissions Single RAT / Multi Carrier Configurations	18
2.4.4 Radiated Emissions Multi RAT/Multi Carrier Configuration	18
2.5 Modifications of the EUT during testing.....	19
2.6 Inventory of the EUT and support equipments.....	19
3. Detailed test results of Emissions	20
3.1 Measurement instrumentation.....	20
3.2 Radiated Emissions, E-field.....	21
3.2.1 Test specification and limits	21
3.2.2 Test procedure.....	22
3.2.3 Calculation of the compliance margin	23
3.2.4 Measurement uncertainties	24
3.2.5 Test results of RE (Single RAT/Carrier, SC2 - LTE + NBloT GB, Mid channel).....	24
3.2.6 Test results of RE (Single RAT/Carrier, SC2 - LTE + NBloT GB, Bot channel).....	30
3.2.7 Test results of RE (Single RAT/Carrier, SC2 - LTE + NBloT GB, Top channel)	36
3.2.8 Test results of RE (Single RAT/Carrier, SC1 - NR, Mid channel).....	42
3.2.9 Test results of RE (Single RAT/Multi carrier, 2 x LTE+NBloT GB, Mid channel)	48
3.2.10 Test results of RE (Multi RAT/Carrier, MR1- NBloT GB+WCDMA, Mid channel)	54
3.2.11 Test results of RE (Multi RAT/Carrier, MR 2- NBloT GB+NR, Mid channel).....	60
3.2.12 Radiated Emissions test setup pictures	66
3.2.13 Test equipment.....	69
3.2.14 Test conclusion	69
4. References	70
4.1 Appendix A: Abbreviations	71

List of figures

Figure 1: The EUT, RD 4442 B25B66A	13
Figure 2: The EUT, RD 4442 B25B66A (With Test fixture)	13



Figure 3: Test configuration for Emission tests.....	15
Figure 4: Tested carrier detail – LTE + NBloT Config (SC1) - Middle.....	16
Figure 5: Tested carrier detail – LTE + NBloT Config (SC2) - Middle.....	16
Figure 6: Tested carrier detail – LTE + NBloT Config (SC2) - Bottom	16
Figure 7: Tested carrier detail – LTE + NBloT Config (SC2) - Top.....	16
Figure 8: Tested carrier detail – LTE + NBloT Config (SC3) - Middle.....	17
Figure 9: Tested carrier detail – NR Config (SC1) – Middle	17
Figure 10: Tested carrier detail – NR Config (SC2) – Middle	17
Figure 11: Tested carrier detail – NR Config (SC3) – Middle	17
Figure 12: Tested carrier detail – NR Config (SC4) – Middle	17
Figure 13: Tested carrier detail – Single RAT/Multicarrier (2 x LTE+NBloT GB)	18
Figure 14: Tested carrier detail – Multi RAT/Carrier Config (MR1- NBloT GB+WCDMA).....	18
Figure 15: Tested carrier detail – Multi RAT/Carrier Config (MR2- NBloT GB+NR).....	18
Figure 16: Setup of Radiated Emissions.....	23
Figure 17: Plot of RE at 3 m – 30 to1000 MHz (LTE + NBloT GB, Mid channel).....	25
Figure 18: Plot of RE at 3m from 1 to 3 GHz (SC2 - LTE + NBloT GB, Mid channel)	26
Figure 19: Plot of RE at 3m from 3 to 10 GHz (SC2 - LTE + NBloT GB, Mid channel)	27
Figure 20: Plot of RE at 3m from 10 to 18 GHz (SC2 - LTE + NBloT GB, Mid channel)	28
Figure 21: Plot of RE at 1m from 18 to 26.5 GHz (SC2 - LTE + NBloT GB, Mid channel)	29
Figure 22: Plot of RE at 1m from 26.5 to 40 GHz (SC2 - LTE + NBloT GB, Mid channel)	29
Figure 23: Plot of RE at 3 m – 30 to1000 MHz (LTE + NBloT GB, Bot channel).....	31
Figure 24: Plot of RE at 3m from 1 to 3 GHz (SC2 - LTE + NBloT GB, Bot channel)	32
Figure 25: Plot of RE at 3m from 3 to 10 GHz (SC2 - LTE + NBloT GB, Bot channel)	33
Figure 26: Plot of RE at 3m from 10 to 18 GHz (SC2 - LTE + NBloT GB, Bot channel)	34
Figure 27: Plot of RE at 1m from 18 to 26.5 GHz (SC2 - LTE + NBloT GB, Bot channel)	35
Figure 28: Plot of RE at 3 m – 30 to1000 MHz (LTE + NBloT GB, Top channel).....	37
Figure 29: Plot of RE at 3m from 1 to 3 GHz (SC2 - LTE + NBloT GB, Top channel).....	38
Figure 30: Plot of RE at 3m from 3 to 10 GHz (SC2 - LTE + NBloT GB, Top channel).....	39
Figure 31: Plot of RE at 3m from 10 to 18 GHz (SC2 - LTE + NBloT GB, Top channel).....	40
Figure 32: Plot of RE at 1m from 18 to 26.5 GHz (SC2 - LTE + NBloT GB, Top channel).....	41
Figure 33: Plot of RE at 3 m – 30 to1000 MHz (SC1 - NR, Mid channel)	43
Figure 34: Plot of RE at 3m from 1 to 3 GHz (SC1 - NR, Mid channel)	44
Figure 35: Plot of RE at 3m from 3 to 10 GHz (SC1 - NR, Mid channel)	45
Figure 36: Plot of RE at 3m from 10 to 18 GHz (SC1 - NR, Mid channel)	46
Figure 37: Plot of RE at 1m from 18 to 26.5 GHz (SC1 - NR, Mid channel)	47
Figure 38: Plot of RE at 3 m – 30 to1000 MHz (2 x LTE+NBloT GB – Mid channel).....	49
Figure 39: Plot of RE at 3m from 1 to 3 GHz (2 x LTE+NBloT GB – Mid channel).....	50



Figure 40: Plot of RE at 3m from 3 to 10 GHz (2 x LTE+NBlot GB – Mid channel).....	51
Figure 41: Plot of RE at 3m from 10 to 18 GHz (2 x LTE+NBlot GB – Mid channel).....	52
Figure 42: Plot of RE at 1m from 18 to 26.5 GHz (2 x LTE+NBlot GB – Mid channel).....	53
Figure 43: Plot of RE at 3 m – 30 to1000 MHz (Config - MR1, Mid channel)	55
Figure 44: Plot of RE at 3m from 1 to 3 GHz (Config - MR1, Mid channel)	56
Figure 45: Plot of RE at 3m from 3 to 10 GHz (Config - MR1, Mid channel)	57
Figure 46: Plot of RE at 3m from 10 to 18 GHz (Config - MR1, Mid channel)	58
Figure 47: Plot of RE at 1m from 18 to 26.5 GHz (Config - MR1, Mid channel)	59
Figure 48: Plot of RE at 3 m – 30 to1000 MHz (Config – MR2, Mid channel).....	61
Figure 49: Plot of RE at 3m from 1 to 3 GHz (Config – MR2, Mid channel).....	62
Figure 50: Plot of RE at 3m from 3 to 10 GHz (Config – MR2, Mid channel).....	63
Figure 51: Plot of RE at 3m from 10 to 18 GHz (Config – MR2, Mid channel).....	64
Figure 52: Plot of RE at 1m from 18 to 26.5 GHz (Config – MR2, Mid channel).....	65
Figure 53: EUT Setup for RE tests (Closeup)	66
Figure 54: EUT Setup for RE tests at 30 MHz to 1 GHz	67
Figure 55: EUT Setup for RE tests for above 1 GHz	68

List of tables

Table 1: Summary of test results for the USA; FCC Part 15 subpart B	10
Table 2: Summary of test results for the USA; FCC Part 24, Section 24.238 (a)	10
Table 3: Summary of test results for the USA; FCC Part 27 subpart C	10
Table 4: Summary of test results for Canada; ICES-003.....	10
Table 5: Summary of test results for RSS-Gen, Section 7.0.....	11
Table 6: Summary of test results for Canada, RSS-133	11
Table 7: Summary of test results for Canada, RSS-139	11
Table 8: Assessed hardware.....	12
Table 9: Product Info – RD 4442 B25B66A	14
Table 10: System port definition.....	15
Table 11: Inventory of the EUT	19
Table 12: RE test requirements.....	21
Table 13: RE limits at 10 m for Class B of FCC Part 15, ICES 003 & RSS-Gen.....	21
Table 14: Emission limits for FCC Part 24, Part 27, RSS-133, RSS-139	21
Table 15: RE test results from 30 to 1000 MHz for FCC Part 15 (LTE + NBlot GB, Mid channel)	25
Table 16: RE test results from 30 to 1000 MHz for FCC Part 24/27 (LTE + NBlot GB, Mid channel)	25
Table 17: RE test results from 1 to 3 GHz for FCC Part 15 (SC2 - LTE + NBlot GB, Mid channel).....	26
Table 18: RE test results from 1 to 3 GHz for Part 24/27 (SC2 - LTE + NBlot GB, Mid channel)	26



Table 19: RE test results from 3 to 10 GHz for FCC Part 15 (SC2 - LTE + NBloT GB, Mid channel) ..	27
Table 20: RE test results from 3 to 10 GHz for Part 24/27 (SC2 - LTE + NBloT GB, Mid channel)	27
Table 21: RE test results from 10 to 18 GHz for FCC Part 15 (SC2 - LTE + NBloT GB, Mid channel)	28
Table 22: RE test results from 10 to 18 GHz for Part 24/27 (SC2 - LTE + NBloT GB, Mid channel) ...	28
Table 23: RE test results from 30 to 1000 MHz for FCC Part 15 (LTE + NBloT GB, Bot channel)	31
Table 24: RE test results from 30 to 1000 MHz for FCC Part 24/27 (LTE + NBloT GB, Bot channel) .	31
Table 25: RE test results from 1 to 3 GHz for FCC Part 15 (SC2 - LTE + NBloT GB, Bot channel).....	32
Table 26: RE test results from 1 to 3 GHz for Part 24/27 (SC2 - LTE + NBloT GB, Bot channel)	32
Table 27: RE test results from 3 to 10 GHz for FCC Part 15 (SC2 - LTE + NBloT GB, Bot channel)...	33
Table 28: RE test results from 3 to 10 GHz for Part 24/27 (SC2 - LTE + NBloT GB, Bot channel)	33
Table 29: RE test results from 10 to 18 GHz for FCC Part 15 (SC2 - LTE + NBloT GB, Bot channel).	34
Table 30: RE test results from 10 to 18 GHz for Part 24/27 (SC2 - LTE + NBloT GB, Bot channel)	34
Table 31: RE test results from 30 to 1000 MHz for FCC Part 15 (LTE + NBloT GB, Top channel).....	37
Table 32: RE test results from 30 to 1000 MHz for FCC Part 24/27 (LTE + NBloT GB, Top channel).	37
Table 33: RE test results from 1 to 3 GHz for FCC Part 15 (SC2 - LTE + NBloT GB, Top channel)	38
Table 34: RE test results from 1 to 3 GHz for Part 24/27 (SC2 - LTE + NBloT GB, Top channel).....	38
Table 35: RE test results from 3 to 10 GHz for FCC Part 15 (SC2 - LTE + NBloT GB, Top channel) ..	39
Table 36: RE test results from 3 to 10 GHz for Part 24/27 (SC2 - LTE + NBloT GB, Top channel).....	39
Table 37: RE test results from 10 to 18 GHz for FCC Part 15 (SC2 - LTE + NBloT GB, Top channel)	40
Table 38: RE test results from 10 to 18 GHz for Part 24/27 (SC2 - LTE + NBloT GB, Top channel)....	40
Table 39: RE test results from 30 to 1000 MHz for FCC Part 15 (SC1 - NR, Mid channel).....	43
Table 40: RE test results from 30 to 1000 MHz for FCC Part 24/27 (SC1 - NR, Mid channel).....	43
Table 41: RE test results from 1 to 3 GHz for FCC Part 15 (SC1 - NR, Mid channel).....	44
Table 42: RE test results from 1 to 3 GHz for Part 24/27 (SC1 - NR, Mid channel).....	44
Table 43: RE test results from 3 to 10 GHz for FCC Part 15 (SC1 - NR, Mid channel).....	45
Table 44: RE test results from 3 to 10 GHz for Part 24/27 (SC1 - NR, Mid channel).....	45
Table 45: RE test results from 10 to 18 GHz for FCC Part 15 (SC1 - NR, Mid channel).....	46
Table 46: RE test results from 10 to 18 GHz for Part 24/27 (SC1 - NR Mid channel)	46
Table 47: RE test results from 30 to 1000 MHz for FCC Part 15 (2 x LTE+NBloT GB – Mid channel)	49
Table 48: RE test results from 30 to 1000 MHz for FCC Part 24/27 (2 x LTE+NBloT GB – Mid channel).....	49
Table 49: RE test results from 1 to 3 GHz for FCC Part 15 (2 x LTE+NBloT GB – Mid channel)	50
Table 50: RE test results from 1 to 3 GHz for Part 24/27 (2 x LTE+NBloT GB – Mid channel)	50
Table 51: RE test results from 3 to 10 GHz for FCC Part 15 (2 x LTE+NBloT GB – Mid channel)	51
Table 52: RE test results from 3 to 10 GHz for Part 24/27 (2 x LTE+NBloT GB – Mid channel).....	51
Table 53: RE test results from 10 to 18 GHz for FCC Part 15 (2 x LTE+NBloT GB – Mid channel)	52
Table 54: RE test results from 10 to 18 GHz for Part 24/27 (2 x LTE+NBloT GB – Mid channel).....	52



Table 55: RE test results from 30 to 1000 MHz for FCC Part 15 (Config - MR1, Mid channel)	55
Table 56: RE test results from 30 to 1000 MHz for FCC Part 24/27 (Config - MR1, Mid channel)	55
Table 57: RE test results from 1 to 3 GHz for FCC Part 15 (Config - MR1, Mid channel).....	56
Table 58: RE test results from 1 to 3 GHz for Part 24/27 (Config - MR1, Mid channel)	56
Table 59: RE test results from 3 to 10 GHz for FCC Part 15 (Config - MR1, Mid channel).....	57
Table 60: RE test results from 3 to 10 GHz for Part 24/27 (Config - MR1, Mid channel)	57
Table 61: RE test results from 10 to 18 GHz for FCC Part 15 (Config - MR1, Mid channel).....	58
Table 62: RE test results from 10 to 18 GHz for Part 24/27 (Config - MR1, Mid channel)	58
Table 63: RE test results from 30 to 1000 MHz for FCC Part 15 (Config – MR2, Mid channel)	61
Table 64: RE test results from 30 to 1000 MHz for FCC Part 24/27 (Config – MR2, Mid channel)	61
Table 65: RE test results from 1 to 3 GHz for FCC Part 15 (Config – MR2, Mid channel)	62
Table 66: RE test results from 1 to 3 GHz for Part 24/27 (Config – MR2, Mid channel)	62
Table 67: RE test results from 3 to 10 GHz for FCC Part 15 (Config – MR2, Mid channel)	63
Table 68: RE test results from 3 to 10 GHz for Part 24/27 (Config – MR2, Mid channel)	63
Table 69: RE test results from 10 to 18 GHz for FCC Part 15 (Config – MR2, Mid channel)	64
Table 70: RE test results from 10 to 18 GHz for Part 24/27 (Config – MR2, Mid channel)	64
Table 71: Test equipment used for RE	69

1. Executive summary

This document reports the Electromagnetic Compatibility (EMC) testing performed on the product called RD 4442 B25B66A, RD 2243 B25, and RD 2243 B66A for Ericsson Canada per project number 7169009141. The objective of the test activities is to evaluate compliance of the product to following EMC regulatory standards.

The RD 4442 B25B66A is verified to comply with the Class B Emissions requirements of these standards:

- FCC Part 15 Subpart B [5] (Class B)
- FCC Part 24 [7] (Emissions Limitations for broadband PCS equipment, Section 24.238(a))
- FCC Part 27 [8] (Digital Base Stations, Section - 27.53(h))
- ICES 003 [9] (Class B)
- RSS-Gen [12] (Receiver emissions Limits, Section 7.0)
- RSS-133 [10] (Transmitter unwanted Emissions, Section 6.5)
- RSS-139 [11] (Transmitter unwanted Emissions, Section 6.6)

Information about the test result summary and, the equipment under test (EUT) is in the sections:

- [Compliance summary](#)
- [Details of the equipment under test](#)
- [Detailed test results of Emissions](#)

1.1 Compliance summary

The test results in this report apply only to the tested components that are identified in the section [Assessed hardware](#).

The following table summarizes the EMC test results for the test cases performed on the RD 4442 B25B66A

Table 1: Summary of test results for the USA; FCC Part 15 subpart B

FCC Section	Description	Specification/Method	Pass or Fail	Results in section
15.109	Radiated Emissions (RE)	FCC Part 15/ANSI C63.4	Pass	3.2
15.107	Conducted Emissions (CE) for AC Power	FCC Part 15/ANSI C63.4	Not applicable ¹	
Table Notes				
1. EUT is not AC powered.				

Table 2: Summary of test results for the USA; FCC Part 24, Section 24.238 (a)

FCC Section	Description	Specification/Method	Pass or Fail	Results in section
24.238 (a)	Emissions Limitations for Broadband PCS equipment – Out of band emissions	FCC Part 24/ ANSI C63.26	Pass	3.2

Table 3: Summary of test results for the USA; FCC Part 27 subpart C

FCC Section	Description	Specification/Method	Pass or Fail	Results in section
27.53(h)	AWS emission limits	FCC Part 27/ ANSI C63.26	Pass	3.2

Table 4: Summary of test results for Canada; ICES-003

ICES Section	Description	Specification/Method	Pass or Fail	Results in section
6.2	Radiated Emissions (RE)	ICES 003/ANSI C63.4	Pass	3.2
6.1	Conducted Emissions (CE) for AC Power	ICES 003/ANSI C63.4	Not applicable ¹	
Table Notes				
1. EUT is not AC powered.				



Table 5: Summary of test results for RSS-Gen, Section 7.0

RSS-Gen Section	Description	Specification/Method	Pass or Fail	Results in section
7.3	Receiver Radiated Emissions	RSS-Gen / ANSI C63.4	Pass	3.2
7.2	Conducted Emissions (CE) for AC Power	RSS-Gen / ANSI C63.4	Not applicable ¹	
7.4	Receiver Conducted Emissions	See antenna port conducted emissions in applicable test report		
Table Notes				
1. EUT is not AC powered.				

Table 6: Summary of test results for Canada, RSS-133

RSS-133 Section	Description	Specification/Method	Pass or Fail	Results in section
6.5	Transmitter unwanted Emissions	RSS-133 / ANSI C63.26	Pass	3.2

Table 7: Summary of test results for Canada, RSS-139

RSS-139 Section	Description	Specification/Method	Pass or Fail	Results in section
6.6	Transmitter unwanted Emissions	RSS-139 / ANSI C63.26	Pass	3.2

2. Details of the equipment under test

This section describes the equipment under test (EUT).

2.1 Assessed hardware

The following table indicates the hardware components that were assessed during this test program.

Table 8: Assessed hardware

Hardware component	Part number
RD 4442 B25B66A	KRY 901 386/1
RD 2243 B25 ¹	KRY 901 402/1
RD 2243 B66A ²	KRY 901 404/1
Table Notes	
<p>1. Not Tested, see Customer provided compliance by similarity rational below: <i>“The RD 2243 B25 is a depopulated variant of the RD 4442 B25B66A product where the B66A circuits have been removed”</i></p> <p>2. Not Tested, see Customer provided compliance by similarity rational below: <i>“The RD 2243 B66A is a depopulated variant of the RD 4442 B25B66A product where the B25 circuits have been removed”</i></p>	

2.2 Product overview

The product trade name is RD 4442 B25B66A. The RD 4442 B25B66A product is an indoor wireless telecommunication product. It is a radio unit that provides cellular service. It can operate from POE (-56 Vdc) power. The EUT was tested with test fixture which connect the internal antenna ports to external 50 Ohm terminations; as shown in [Figure 2](#).

Figure 1: The EUT, RD 4442 B25B66A



Figure 2: The EUT, RD 4442 B25B66A (With Test fixture)

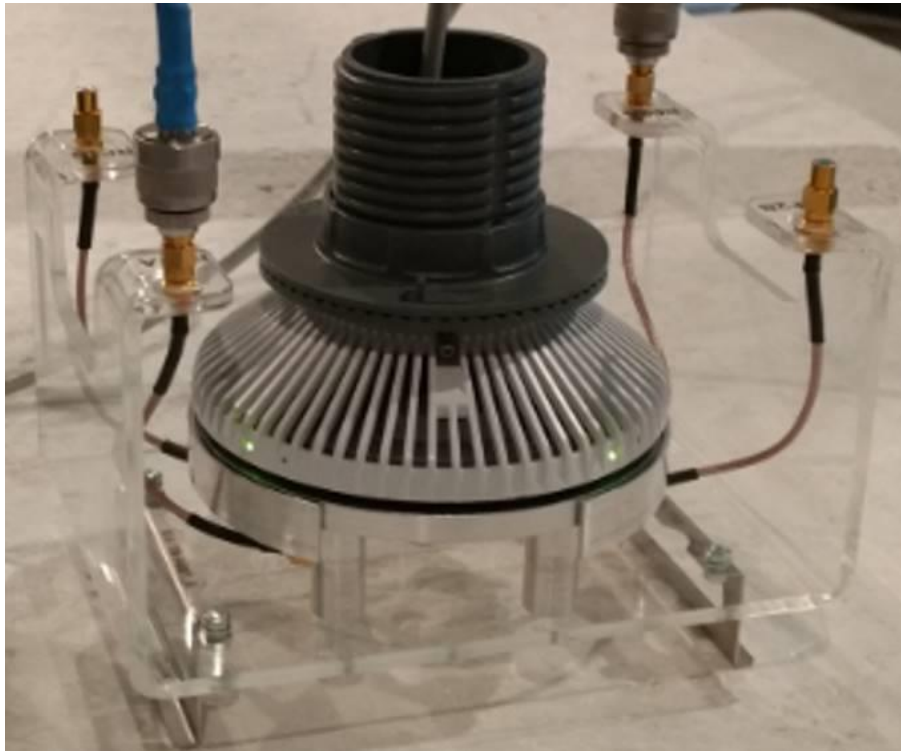



Table 9: Product Info – RD 4442 B25B66A

Product data	RD 4442 B25B66A
Product	Ph3 Dot, Dual band, 4T4R, Internal antenna
Revision	R1B
P/N:	KRY 901 386/1
Nominal Voltage:	56Vdc
Operating Temperature:	+5°C to +40°C
Bands	B25 + B66A
Antennas	4T4R
Output Power per band	2x50mW (FDD)
RAT support	B25: LTE-FDD, WCDMA, NBloT GB/IB, NR
	B66: LTE-FDD, WCDMA, NBloT GB/IB, NR
Mixed Mode supported	LTE+WCDMA (1 LTE carrier and 1 WCDMA carrier)
	LTE+NR (1 LTE carrier and 1 NR carrier)
IBW	40 MHz (Contiguous operation only)
Nominal O/P per FDD Antenna Port	Single Carrier: 1 x 50mW (17dBm)
	Multi-Carrier: 2 x 25mW (14dBm)
	Multi-Carrier: 3 x 16.7mW (12.2dBm)
	Multi-Carrier: 4 x 12.5mW (11dBm)
	Multi-Carrier: 5 x 10mW (10dBm)
Multi-Carrier: 6 x 8.3mW (9.2dBm)	
Max carriers per Port	6 (Contiguous operations only)
Total number of NR carriers	2
Total number of UTRA carriers	4
Total number of E-UTRA carriers	2
Modulation	LTE: QPSK, 16QAM, 64QAM, 256 QAM (DL only)
Channel Bandwidth:	LTE: 5, 10, 15, 20MHz
	WCDMA: 5MHz
	NBloT GB/IB: 10, 15, 20MHz (host LTE BW)
	NR: 5, 10, 15, 20MHz
RDI Interface:	Analog, DL: 110 – 150MHz, UL: 40 - 80MHz
Channel Raster:	LTE: 100kHz, WCDMA: 200kHz
Mounting	ceiling or wall
Dimensions: (H x W x D)	140 x 140 x 52mm
Weight;	0.439 kg

The Configurations of the RD 4442 B25B66A that were tested is shown in the section [Configurations of the EUT](#). The EUT was tested in a tabletop setting.

2.3 Product port definition and EUT cable information

[Table 10](#) identifies all the cables and ports on the EUT. The Environment of the cables is indoor.

Table 10: System port definition

DOT Port Name	DOT Port Description	Port Type	Interface Detail	Plug-Cable Type
RDI	Analog Radio DOT Interface	Signal	Analog RF	RJ-45, CAT6A shielded
RF1A, RF1B	RF, B25 TX/RX ports	Antenna	RF probe to Internal Antenna	connects to test fixture SMA ports
RF2A, RF2B	RF, B66A TX/RX ports	Antenna	RF probe to Internal Antenna	

2.4 Configurations of the EUT

[Figure 3](#) shows the configuration of the EUT for Emissions test.

Figure 3: Test configuration for Emission tests

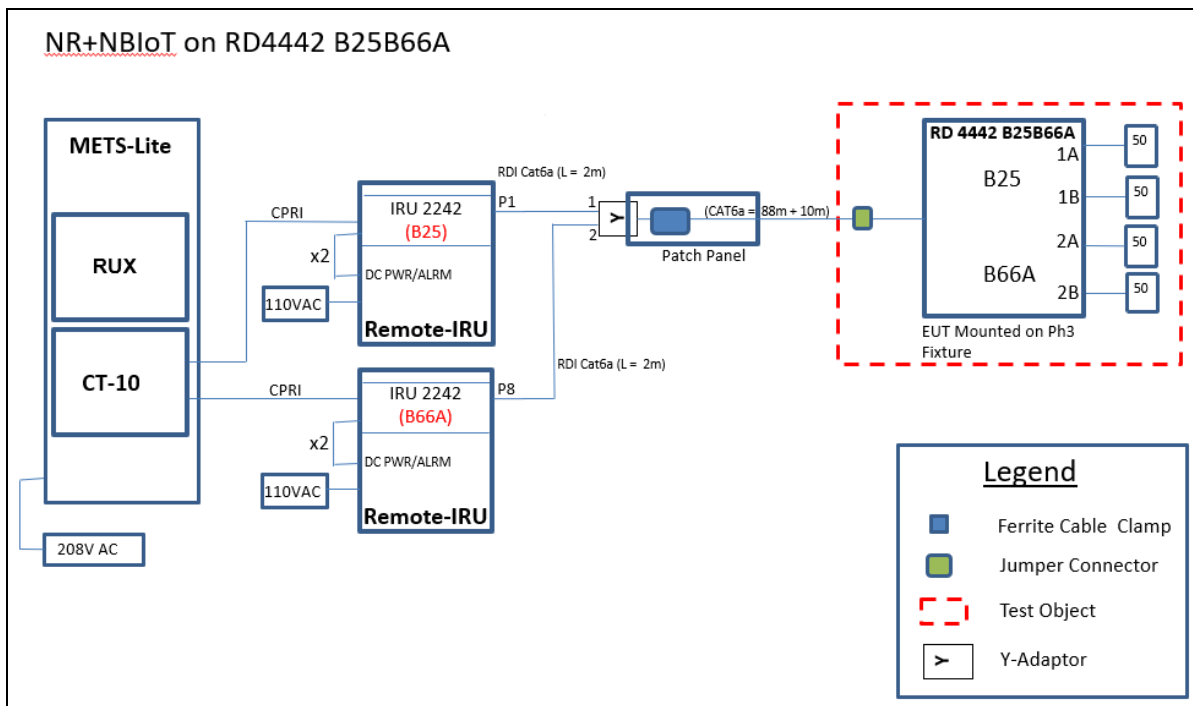

2.4.1 Radiated Emissions Single RAT / Single Carrier (LTE + NBLoT GB)

Figure 4: Tested carrier detail – LTE + NBLoT Config (SC1) - Middle

SR NBLoT Config SC1 Carrier setups for Emissions			
B25 PORT (1A,1B) - LTE + NBLoT GB		B66AA Port (2A, 2B) - LTE + NBLoT GB	
Carrier:	Middle	Carrier:	Middle
1	B25: L, 10MHz, 1962.5 MHz	1	B66A: L, 10MHz, 2145 MHz
2	B25: NBLoT GB, 200KHz, 1957.9 MHz	2	B66A: NBLoT GB, 200KHz, 2140.4 MHz
3	B25: NBLoT GB, 200KHz, 1967.1 MHz	3	B66A: NBLoT GB, 200KHz, 2149.6 MHz

Figure 5: Tested carrier detail – LTE + NBLoT Config (SC2) - Middle

SR NBLoT Config SC2 Carrier setups for Emissions			
B25 PORT (1A,1B) - LTE + NBLoT GB		B66AA Port (2A, 2B) - LTE + NBLoT GB	
Carrier:	Middle	Carrier:	Middle
1	B25: L, 15MHz, 1962.5 MHz	1	B66A: L, 15MHz, 2145 MHz
2	B25: NBLoT GB, 200KHz, 1955.6 MHz	2	B66A: NBLoT GB, 200KHz, 2138.1 MHz
3	B25: NBLoT GB, 200KHz, 1969.4 MHz	3	B66A: NBLoT GB, 200KHz, 2151.9 MHz

Figure 6: Tested carrier detail – LTE + NBLoT Config (SC2) - Bottom

SR NBLoT Config SC2 Carrier setups for Emissions			
B25 PORT (1A,1B) - LTE + NBLoT GB		B66AA Port (2A, 2B) - LTE + NBLoT GB	
Carrier:	Bottom	Carrier:	Bottom
1	B25: L, 15MHz, 1937.5 MHz	1	B66A: L, 15MHz, 2117.5 MHz
2	B25: NBLoT GB, 200KHz, 1930.6 MHz	2	B66A: NBLoT GB, 200KHz, 2110.6 MHz
3	B25: NBLoT GB, 200KHz, 1944.4 MHz	3	B66A: NBLoT GB, 200KHz, 2124.4 MHz

Figure 7: Tested carrier detail – LTE + NBLoT Config (SC2) - Top

SR NBLoT Config SC2 Carrier setups for Emissions			
B25 PORT (1A,1B) - LTE + NBLoT GB		B66AA Port (2A, 2B) - LTE + NBLoT GB	
Carrier:	Top	Carrier:	Top
1	B25: L, 15MHz, 1987.5 MHz	1	B66A: L, 15MHz, 2172.5 MHz
2	B25: NBLoT GB, 200KHz, 1980.6 MHz	2	B66A: NBLoT GB, 200KHz, 2165.6 MHz
3	B25: NBLoT GB, 200KHz, 1994.4 MHz	3	B66A: NBLoT GB, 200KHz, 2179.4 MHz

Figure 8: Tested carrier detail – LTE + NBLoT Config (SC3) - Middle

SR NBLoT Config SC3 Carrier setups for Emissions			
B25 PORT (1A,1B) - LTE + NBLoT GB		B66AA Port (2A, 2B) - LTE + NBLoT GB	
Carrier:	Middle	Carrier:	Middle
1	B25: L, 20MHz, 1962.5 MHz	1	B66A: L, 20MHz, 2145 MHz
2	B25: NBLoT GB, 200KHz, 1953.4 MHz	2	B66A: NBLoT GB, 200KHz, 2135.9 MHz
3	B25: NBLoT GB, 200KHz, 1971.6 MHz	3	B66A: NBLoT GB, 200KHz, 2154.1 MHz

Note: Radiated Emissions measurements were compared between SC1, SC2 and SC3 middle channel. SC2 was found to have higher emissions than SC1 and SC3; therefore EUT with SC2 carrier configuration was fully tested and reported.

2.4.2 Radiated Emissions Single RAT / Single Carrier (NR)

Figure 9: Tested carrier detail – NR Config (SC1) – Middle

SR NR Config SC1 Carrier setups for Emissions			
B25 PORT (1A,1B) - NR		B66AA Port (2A, 2B) - NR	
Carrier:	Middle	Carrier:	Middle
1	B25: NR, 5MHz, 1962.5 MHz	1	B66A: NR, 5MHz, 2145 MHz

Figure 10: Tested carrier detail – NR Config (SC2) – Middle

SR NR Config SC2 Carrier setups for Emissions			
B25 PORT (1A,1B) - NR		B66AA Port (2A, 2B) - NR	
Carrier:	Middle	Carrier:	Middle
1	B25: NR, 10MHz, 1962.5 MHz	1	B66A: NR, 10MHz, 2145 MHz

Figure 11: Tested carrier detail – NR Config (SC3) – Middle

SR NR Config SC3 Carrier setups for Emissions			
B25 PORT (1A,1B) - NR		B66AA Port (2A, 2B) - NR	
Carrier:	Middle	Carrier:	Middle
1	B25: NR, 15MHz, 1962.5 MHz	1	B66A: NR, 15MHz, 2145 MHz

Figure 12: Tested carrier detail – NR Config (SC4) – Middle

SR NR Config SC4 Carrier setups for Emissions			
B25 PORT (1A,1B) - NR		B66AA Port (2A, 2B) - NR	
Carrier:	Middle	Carrier:	Middle
1	B25: NR, 20MHz, 1962.5 MHz	1	B66A: NR, 20MHz, 2145 MHz

Note: Radiated Emissions measurements were compared between SC1, SC2, SC3 and SC4 middle channel. SC1 was found to have higher emissions than SC2, SC3 and SC4; therefore EUT with SC1 (middle) carrier configuration was tested and reported.

2.4.3 Radiated Emissions Single RAT / Multi Carrier Configurations

Figure 13: Tested carrier detail – Single RAT/Multicarrier (2 x LTE+NBlot GB)

SR NBlot Config MC-1 Carrier setups for Emissions			
B25 PORT (1A,1B) - 2 x LTE15 + NBlot GB		B66AA Port (2A, 2B) - 2 x LTE15 + NBlot GB	
Carrier	Middle	Carrier	Middle
1	B25: L, 15MHz, 1955 MHz	1	B66A: L, 15MHz, 2137.5 MHz
2	B25: L, 15MHz, 1970 MHz	2	B66A: L, 15MHz, 2152.5 MHz
3	B25: NBlot GB, 200KHz, 1948.1 MHz (Port A)	3	B66A: NBlot GB, 200KHz, 2130.6 MHz (Port A)
4	B25: NBlot GB, 200KHz, 1961.9 MHz (Port A)	4	B66A: NBlot GB, 200KHz, 2144.4 MHz (Port A)
5	B25: NBlot GB, 200KHz, 1963.1 MHz (Port B)	5	B66A: NBlot GB, 200KHz, 2145.6 MHz (Port B)
6	B25: NBlot GB, 200KHz, 1976.9 MHz (Port B)	6	B66A: NBlot GB, 200KHz, 2159.4 MHz (Port B)

2.4.4 Radiated Emissions Multi RAT/Multi Carrier Configuration

Figure 14: Tested carrier detail – Multi RAT/Carrier Config (MR1- NBlot GB+WCDMA)

MR Config MR-1 Carrier setups for Emissions			
B25 PORT (1A,1B) - NBlot+WCDMA		B66AA Port (2A, 2B) - NBlot+WCDMA	
Carrier	Middle	Carrier	Middle
1	B25: L, 15MHz, 1960 MHz	1	B66A: L, 15MHz, 2142.5 MHz
2	B25: NBlot GB, 200KHz, 1953.1 MHz	2	B66A: NBlot GB, 200KHz, 2135.6 MHz
3	B25: NBlot GB, 200KHz, 1966.9 MHz	3	B66A: NBlot GB, 200KHz, 2149.4 MHz
4	B25: WCDMA, 5MHz, 1970 MHz	4	B66: WCDMA, 5MHz, 2152.6 MHz

Figure 15: Tested carrier detail – Multi RAT/Carrier Config (MR2- NBlot GB+NR)

MR Config MR-2 Carrier setups for Emissions			
B25 PORT (1A,1B) - NBlot+NR		B66AA Port (2A, 2B) - NBlot+NR	
Carrier:	Middle	Carrier:	Middle
1	B25: L, 15MHz, 1960 MHz	1	B66A: L, 15MHz, 2142.5 MHz
2	B25: NBlot GB, 200KHz, 1953.1 MHz	2	B66A: NBlot GB, 200KHz, 2135.6 MHz
3	B25: NBlot GB, 200KHz, 1966.9 MHz	3	B66A: NBlot GB, 200KHz, 2149.4 MHz
4	B25: NR, 5MHz, 1970 MHz	4	B66A: NR, 5MHz, 2152.5 MHz

2.5 Modifications of the EUT during testing

The EUT was not modified prior to or during testing.

2.6 Inventory of the EUT and support equipments

The following tables identifies the inventory of the EUT.

Table 11: Inventory of the EUT

Equipment Role	Product Name	Product Number	Release	Product Serial#
EUT	RD 4442 B25B66A	KRY 901 386/1	R1B	TD3T308290
Support	Remote IRU Enclosure	1/BFL 901 141/1	R3A	BW90100004
Support	IRU 2242 (Band 66A)	KRC 161 444/3	R1B	D825149062
Support	Remote IRU Enclosure	1/BFL 901 141/1	R2A	BW95728240
Support	IRU 2242 (Band 25)	KRC 161 444/2	R1C	D825699225
SFP+	Optical SFP+, LC Dual, SM, 10G, 1.4km	RDH 102 65/2		
Cable	IRU CPRI, Fiber, LC, SM, 20m			na
Cable	RDI cable: 2m & 10m S/FTP patch cables + 80m F-F F/FTP blue cable #7			
Cable Adaptor	Y-Adaptor	RPV 899 155/1	R1A	na
TEST SET	METS, CT10	LPC 102 487/1		
Software info				
IRU load: iru_app-CXP9013268_14-R79JC.xlf				

3. Detailed test results of Emissions

Emissions from systems manifest themselves in two forms: conducted emissions on cables and radiated emissions from the entire system (i.e. electronic modules, hardware, and cables). Regulatory standards restrict these different forms of emissions generated by the system.

The temperature and humidity in the test facilities are controlled. The temperature is maintained between 20 °C and 25 °C, with a relative humidity between 30 % and 60 %. Levels are recorded and any exceptions are included in the detailed test results sections of this report.

3.1 Measurement instrumentation

The measurement instrumentation conforms to the relevant standards in this report: ANSI C63.2, CISPR 16, CISPR 22, and CISPR 32. Calibration of the measurement instrumentation is maintained in accordance with the supplier's recommendations, or as necessary to ensure its accuracy.

3.2 Radiated Emissions, E-field

This test verifies that the EUT does not produce excess amounts of E-field Radiated Emissions (RE) that could interfere with licensed radiators.

3.2.1 Test specification and limits

The testing requirements are as follows.

Table 12: RE test requirements

Requirement	Method	Country of application
FCC Part 15, Subpart B	FCC Part 15 / ANSI C63.4	USA
FCC Part 24 (Section 24.238(a))	ANSI C63.26	USA
FCC Part 27 (Section 27.53(h))	ANSI C63.26	USA
ICES 003	FCC Part 15 / ICES 003 / ANSI C63.4	Canada
RSS-Gen (Section 7.3)	FCC Part 15 / ICES 003 / ANSI C63.4	Canada
RSS-133 (Section 6.5)	ANSI C63.26	Canada
RSS- 139 (Section 6.6)	ANSI C63.26	Canada

The limits of the RE tests are as follows.

Table 13: RE limits at 10 m for Class B of FCC Part 15, ICES 003 & RSS-Gen

Frequency range (MHz)	FCC Part 15 & ICES 003 (dB μ V/m)	Detector
30 to 88	29.5	Quasi-Peak
88 to 216	33.0	Quasi-Peak
216 to 960	35.5	Quasi-Peak
960 to 1000	43.5	Quasi-Peak
1000 to 40000	43.5 ¹	Average

Table 14: Emission limits for FCC Part 24, Part 27, RSS-133, RSS-139

Frequency range (MHz)	EIRP Limit (dBm)	Calculated EIRP Limit in dB μ V/m
30 - 40000	-13	82.2

3.2.2 Test procedure

Verifications of the test equipment and AFC were performed before the installation of the EUT in accordance with the quality assurance procedures documented in the EMC test procedures document. The test was performed according to the relevant procedures listed in [Table 12](#).

- The EUT was placed on the turntable inside the AFC (configured for normal operation). The system and its cables were separated from the ground plane by an insulating support 10 mm in height.
- For tests between 30 MHz and 1 GHz the receive antenna (BiLog®) was placed 3 m away from the EUT. An initial scan was performed to find emissions/frequencies requiring detailed measurement. The pre-scan was performed by rotating the system 360 degrees while recording all emissions (frequency and amplitude). This procedure was repeated for antenna heights of 1 to 4 m, as well as both polarizations of the receiving antenna.
- For tests above 1 GHz the receive antenna (horn) was placed 3 m away from the EUT. Absorbing cones were placed on the floor between the antenna and the EUT. An initial scan was performed to find emissions/frequencies requiring detailed measurement. The pre-scan was performed by rotating the system 360 degrees while recording all emissions (frequency and amplitude). This procedure was repeated for antenna heights of 1 to 4 m, as well as both polarizations of the receiving antenna.
- For tests between 18 and 40 GHz the receive horn antenna was placed at a 1 m distance from the EUT with the absorbing cones placed on the floor. An initial scan was performed to find emissions/frequencies requiring detail measurement. The pre-scan was performed on all sides of the EUT, using both polarization of the receive antenna to find any system emissions.
- For all above frequency ranges, the pre-scan peak data was compared to the limits. Peaks with less than 6 dB of margin were maximized using the proper detector: the EUT was rotated in azimuth over 360 degrees to identify the direction of maximum emission, antenna height was then varied from 1 to 4 m to obtain maximum emission level.

Figure 16: Setup of Radiated Emissions

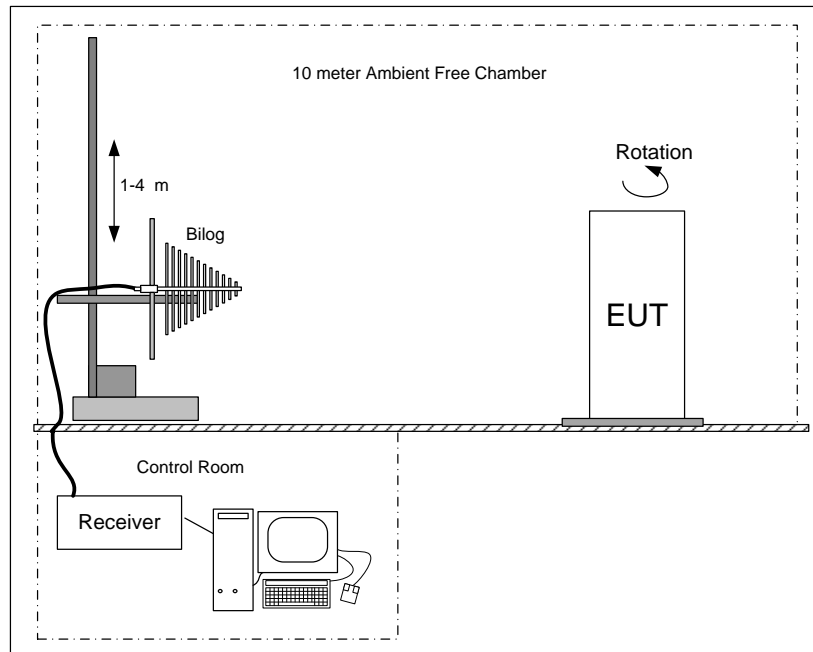

3.2.3 Calculation of the compliance margin

The following example shows the way in which the compliance margin is calculated in the “RE Test Results” tables.

The rows in these tables are defined as follows.

Meter Reading (dB μ V) = Voltage measured using the spectrum analyzer with the proper detector

Correction (dB) = Cumulative gain or loss of pre-amplifier and cables used in the measurement path (dB) + Antenna Factor (dB)

Level (dB μ V/m) = Corrected value or field strength, that is, the parameter of interest that is compared to the limit

Margin (dB) = Level with respect to the appropriate limit (a negative Margin indicates that the Level is below the limit and that the measurement is a Pass)

The values in the Level row are calculated as follows: Level = Meter Reading + Correction (dB)

The values in the Margin row are calculated as follows: Margin = Level - Limit

3.2.4 Measurement uncertainties

The expanded measurement instrumentation uncertainty with a 95 % level of confidence, calculated according to the method described in CISPR 16 is:

- ± 3.8 dB between 30 MHz and 1 GHz
- ± 4.7 dB between 1 GHz and 10 GHz
- ± 4.8 dB between 10 GHz and 18 GHz
- ± 4.6 dB between 18 GHz and 26.5 GHz
- ± 4.8 dB between 26.5 GHz and 40 GHz

3.2.5 Test results of RE (Single RAT/Carrier, **SC2** - LTE + NBloT GB, Mid channel)

Test location: 10-meter Ambient Free Chamber (AFC)

Date tested: 3-16, February 2021

Tested by: Krupal Patel & Tom Ott

Test configurations are identified in the section [Configurations of the EUT](#).

For the following test results that have supporting data tables, negative margin values indicate a pass.

Figure 17: Plot of RE at 3 m – 30 to 1000 MHz (LTE + NB IoT GB, Mid channel)

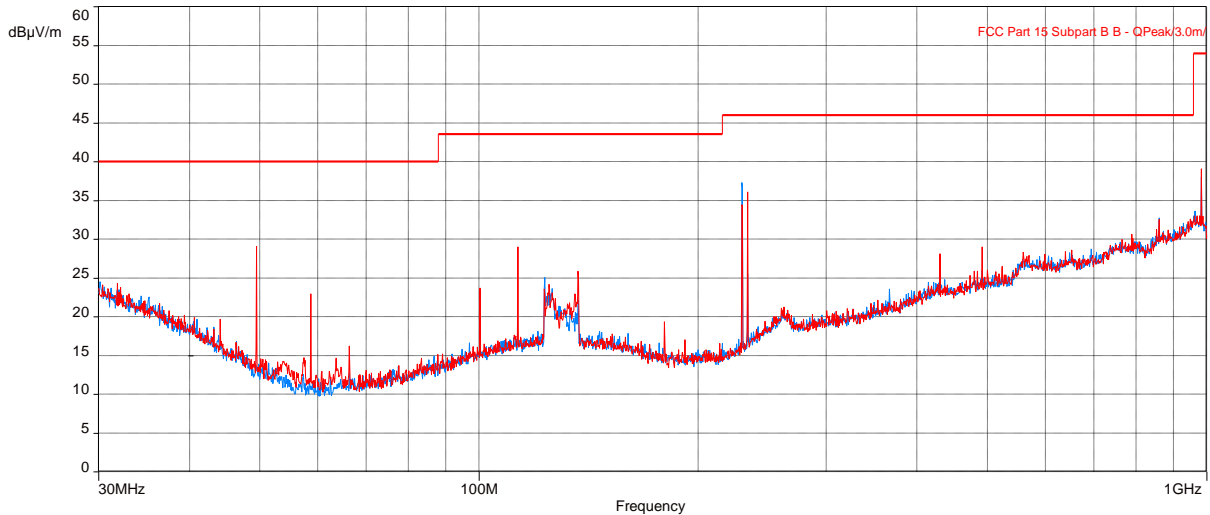

Table 15: RE test results from 30 to 1000 MHz for FCC Part 15 (LTE + NB IoT GB, Mid channel)

Frequency (MHz)	Level Quasi Peak (dBµV/m)	Limit Quasi-peak (dBµV/m)	Margin to FCC part 15 Class B (dB)	Height (m)	Azimuth (deg)	Polarization	Correction (dB)
49.48854521	9.23	40.00	-30.77	1.30	0.00	Vertical	-11.14
229.9491697	33.79	46.02	-12.23	1.81	4.75	Horizontal	-8.24
234.0494518	32.81	46.02	-13.21	2.24	348.25	Vertical	-7.81
983.0334518	38.82	53.98	-15.16	1.98	0.00	Vertical	8.78

Table 16: RE test results from 30 to 1000 MHz for FCC Part 24/27 (LTE + NB IoT GB, Mid channel)

Frequency (MHz)	Level (dBµV/m)	EIRP Limit (dBµV/m)	Margin to (dB)	Height (m)	Azimuth (deg)	Polarization	Correction (dB)
49.48854521	9.23	82.2	- 72.97	1.30	0.00	Vertical	-11.14
229.9491697	33.79	82.2	- 48.41	1.81	4.75	Horizontal	-8.24
234.0494518	32.81	82.2	- 49.39	2.24	348.25	Vertical	-7.81
983.0334518	38.82	82.2	- 43.38	1.98	0.00	Vertical	8.78

Note: In the table/Plot above, no emissions exceed the Part 24/Part 27 radiated spurious emissions limit when converted to dBµV/m. For final spurious emissions measurements to FCC Part 24/Part 27, see antenna port conducted emissions in applicable test report.

Figure 18: Plot of RE at 3m from 1 to 3 GHz (SC2 - LTE + NBloT GB, Mid channel)

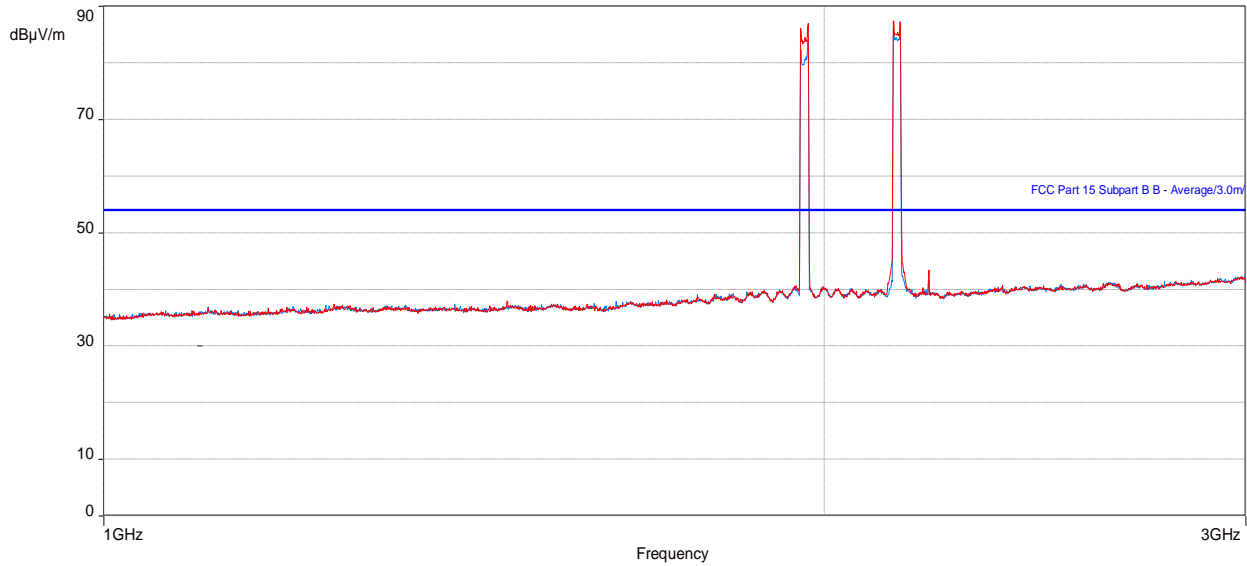

Note: Peaks above the limit are leakage of the EUT’s fundamentals from the 50-ohm terminations.

Table 17: RE test results from 1 to 3 GHz for FCC Part 15 (SC2 - LTE + NBloT GB, Mid channel)

Frequency (MHz)	Level Average (dBµV/m)	Limit Average (dBµV/m)	Margin to FCC part 15 Class B (dB)	Height (m)	Azimuth (degrees)	Polarization	Correction (dB)
1887.709649	36.37	53.96	-17.59	3.75	33.50	Vertical	6.53
2211.825033	41.16	53.96	-12.80	3.47	304.75	Vertical	6.85

Table 18: RE test results from 1 to 3 GHz for Part 24/27 (SC2 - LTE + NBloT GB, Mid channel)

Frequency (MHz)	Level (dBµV/m)	EIRP Limit (dBµV/m)	Margin to (dB)	Height (m)	Azimuth (degrees)	Polarization	Correction (dB)
1887.709649	36.37	82.2	- 45.83	3.75	33.50	Vertical	6.53
2211.825033	41.16	82.2	- 41.04	3.47	304.75	Vertical	6.85

Note: In the table/Plot above, no emissions exceed the Part 24/Part 27 radiated spurious emissions limit when converted to dBuV/m, except for the fundamentals. For final spurious emissions measurements to FCC Part 24/Part 27, see antenna port conducted emissions in applicable test report.

Figure 19: Plot of RE at 3m from 3 to 10 GHz (SC2 - LTE + NBloT GB, Mid channel)

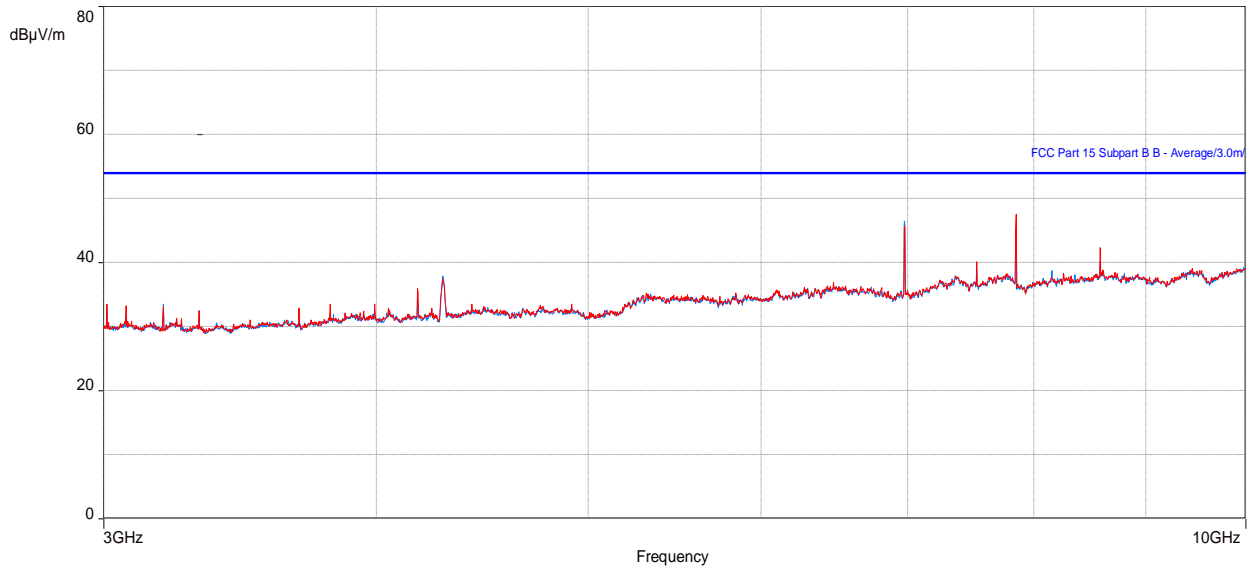

Table 19: RE test results from 3 to 10 GHz for FCC Part 15 (SC2 - LTE + NBloT GB, Mid channel)

Frequency (MHz)	Level Average (dBµV/m)	Limit Average (dBµV/m)	Margin to FCC part 15 Class B (dB)	Height (m)	Azimuth (degrees)	Polarization	Correction (dB)
7849.94811	46.60	53.96	-7.36	2.08	110.75	Vertical	4.49
6979.950674	46.15	53.96	-7.81	2.99	0.00	Horizontal	2.69
6979.952277	44.64	53.96	-9.32	1.00	31.75	Vertical	2.69
8579.943944	42.23	53.96	-11.73	3.88	276.00	Vertical	5.42

Table 20: RE test results from 3 to 10 GHz for Part 24/27 (SC2 - LTE + NBloT GB, Mid channel)

Frequency (MHz)	Level (dBµV/m)	EIRP Limit (dBµV/m)	Margin to (dB)	Height (m)	Azimuth (degrees)	Polarization	Correction (dB)
7849.94811	46.60	82.2	- 35.6	2.08	110.75	Vertical	4.49
6979.950674	46.15	82.2	- 36.05	2.99	0.00	Horizontal	2.69
6979.952277	44.64	82.2	- 37.56	1.00	31.75	Vertical	2.69
8579.943944	42.23	82.2	- 39.97	3.88	276.00	Vertical	5.42

Note: In the table/Plot above, no emissions exceed the Part 24/Part 27 radiated spurious emissions limit when converted to dBuV/m. For final spurious emissions measurements to FCC Part 24/Part 27, see antenna port conducted emissions in applicable test report.

Figure 20: Plot of RE at 3m from 10 to 18 GHz (SC2 - LTE + NBLoT GB, Mid channel)

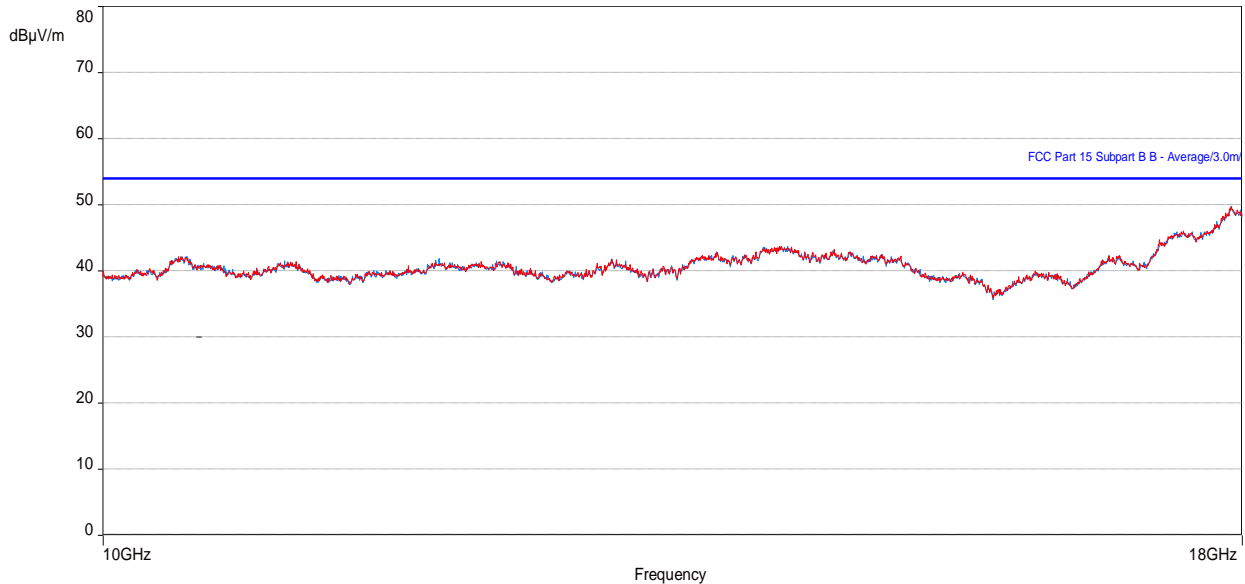

Table 21: RE test results from 10 to 18 GHz for FCC Part 15 (SC2 - LTE + NBLoT GB, Mid channel)

Frequency (MHz)	Level Average (dBµV/m)	Limit Average (dBµV/m)	Margin to FCC part 15 Class B (dB)	Height (m)	Azimuth (degrees)	Polarization	Correction (dB)
17904.48492	46.75	53.96	-7.21	1.00	10.00	Horizontal	20.42
17922.08973	46.34	53.96	-7.62	1.00	314.25	Vertical	20.29

Table 22: RE test results from 10 to 18 GHz for Part 24/27 (SC2 - LTE + NBLoT GB, Mid channel)

Frequency (MHz)	Level (dBµV/m)	EIRP Limit (dBµV/m)	Margin to (dB)	Height (m)	Azimuth (degrees)	Polarization	Correction (dB)
17904.48492	46.75	82.2	- 35.45	1.00	10.00	Horizontal	20.42
17922.08973	46.34	82.2	- 35.86	1.00	314.25	Vertical	20.29

Note: In the table/Plot above, no emissions exceed the Part 24/Part 27 radiated spurious emissions limit when converted to dBuV/m. For final spurious emissions measurements to FCC Part 24/Part 27, see antenna port conducted emissions in applicable test report.

Figure 21: Plot of RE at 1m from 18 to 26.5 GHz (SC2 - LTE + NBloT GB, Mid channel)

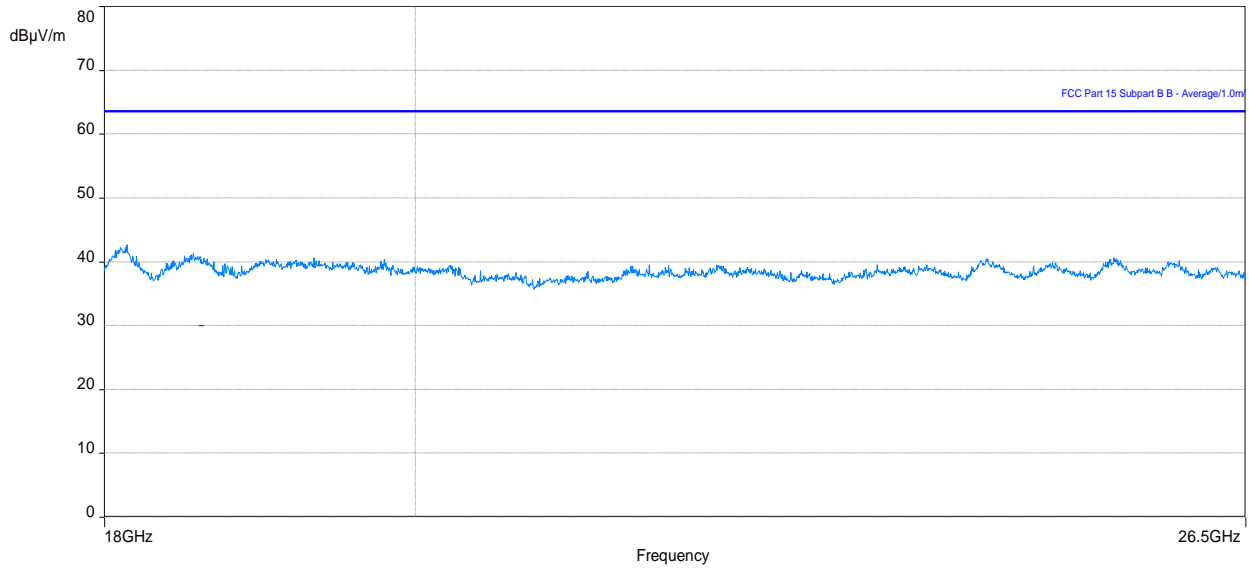
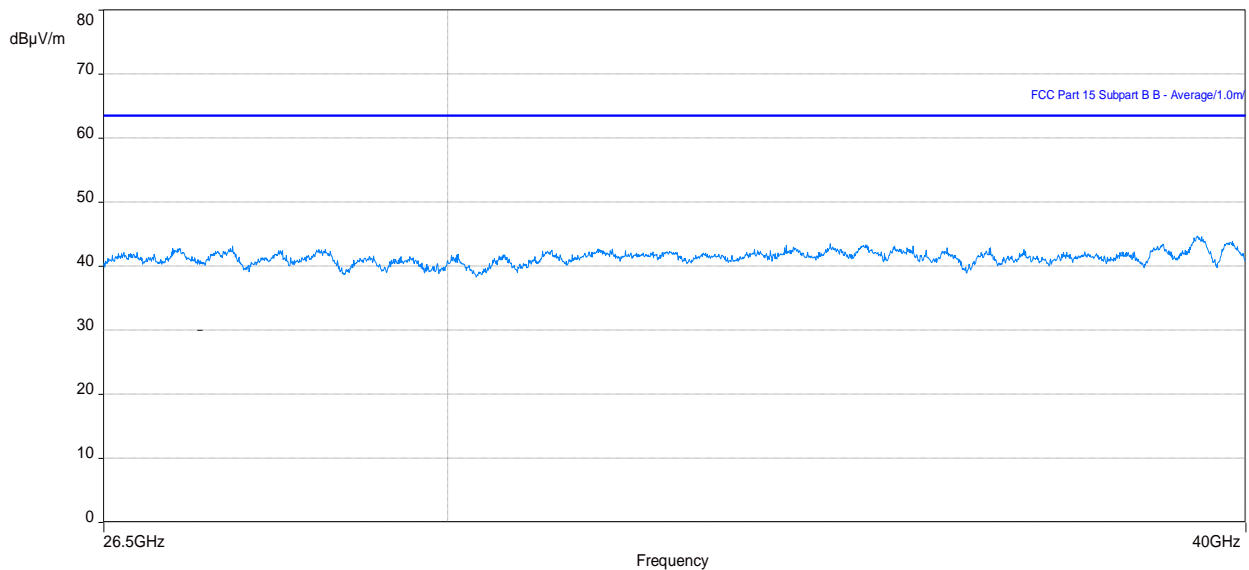

Figure 22: Plot of RE at 1m from 26.5 to 40 GHz (SC2 - LTE + NBloT GB, Mid channel)



Note 1: In the plots above No Emissions exceeds the FCC Part 15/ICES 003 limit.

Note 2: In the plots above, no emissions exceed the Part 24/27 radiated spurious emissions limit when converted to dBuV/m. For final spurious emissions measurements to FCC Part 24/27, see antenna port conducted emissions in applicable test report.



3.2.6 Test results of RE (Single RAT/Carrier, SC2 - LTE + NBloT GB, Bot channel)

Test location: 10-meter Ambient Free Chamber (AFC)

Date tested: 3-16, February 2021

Tested by: Krupal Patel & Tom Ott

Test configurations are identified in the section [Configurations of the EUT](#).

For the following test results that have supporting data tables, negative margin values indicate a pass.

Figure 23: Plot of RE at 3 m – 30 to 1000 MHz (LTE + NB IoT GB, Bot channel)

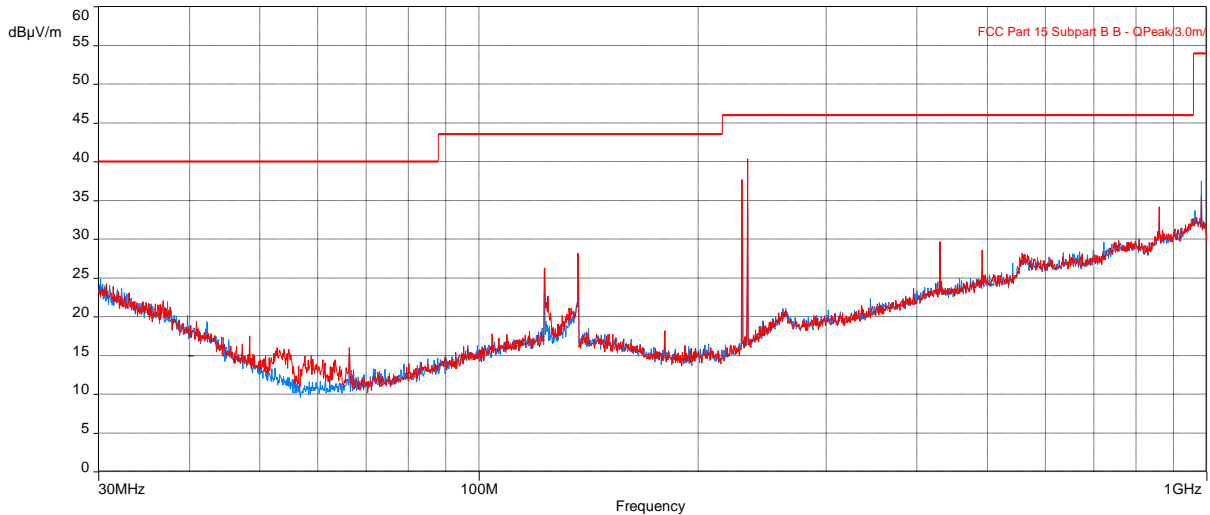

Table 23: RE test results from 30 to 1000 MHz for FCC Part 15 (LTE + NB IoT GB, Bot channel)

Frequency (MHz)	Level Quasi Peak (dBµV/m)	Limit Quasi-peak (dBµV/m)	Margin to FCC part 15 Class B (dB)	Height (m)	Azimuth (deg)	Polarization	Correction (dB)
229.9491697	37.94	46.02	-8.08	2.80	276.25	Vertical	-8.24
233.9493751	37.91	46.02	-8.11	3.88	103.50	Vertical	-7.82
983.0331313	37.69	53.98	-16.29	2.95	290.50	Horizontal	8.78
860.1541633	33.03	46.02	-12.99	2.95	340.75	Vertical	7.14

Table 24: RE test results from 30 to 1000 MHz for FCC Part 24/27 (LTE + NB IoT GB, Bot channel)

Frequency (MHz)	Level (dBµV/m)	EIRP Limit (dBµV/m)	Margin to (dB)	Height (m)	Azimuth (deg)	Polarization	Correction (dB)
229.9491697	37.94	82.2	-44.26	2.80	276.25	Vertical	-8.24
233.9493751	37.91	82.2	-44.29	3.88	103.50	Vertical	-7.82
983.0331313	37.69	82.2	-44.51	2.95	290.50	Horizontal	8.78
860.1541633	33.03	82.2	-49.17	2.95	340.75	Vertical	7.14

Note: In the table/Plot above, no emissions exceed the Part 24/Part 27 radiated spurious emissions limit when converted to dBuV/m. For final spurious emissions measurements to FCC Part 24/Part 27, see antenna port conducted emissions in applicable test report.

Figure 24: Plot of RE at 3m from 1 to 3 GHz (SC2 - LTE + NBloT GB, Bot channel)

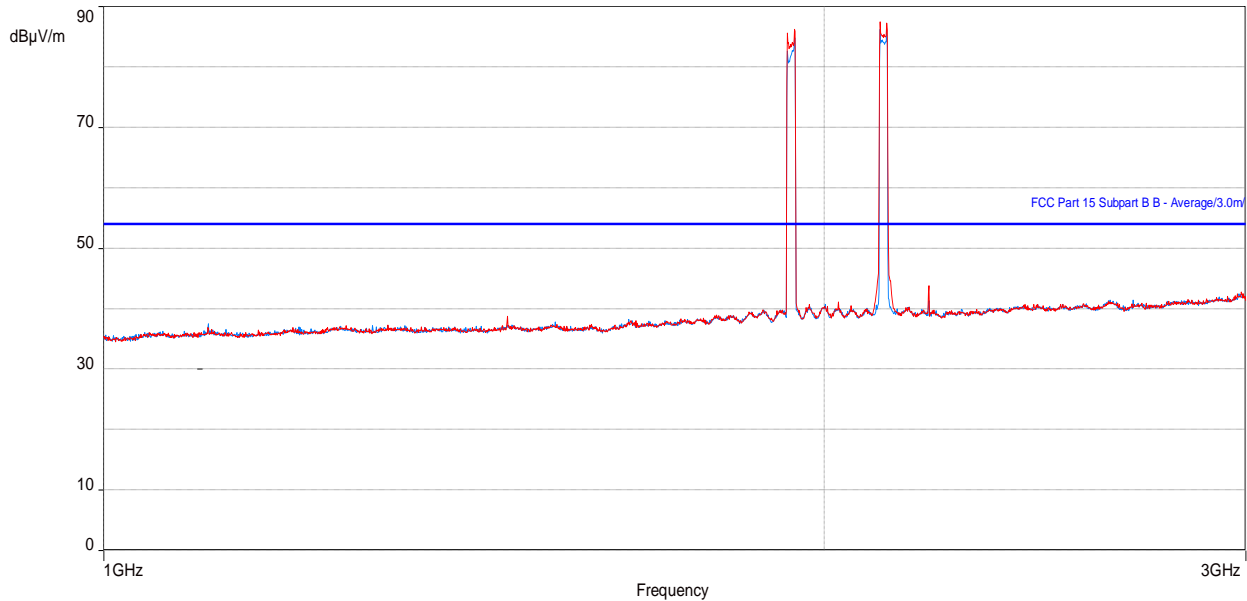

Note: Peaks above the limit are leakage of the EUT's fundamentals from the 50-ohm terminations.

Table 25: RE test results from 1 to 3 GHz for FCC Part 15 (SC2 - LTE + NBloT GB, Bot channel)

Frequency (MHz)	Level Average (dBµV/m)	Limit Average (dBµV/m)	Margin to FCC part 15 Class B (dB)	Height (m)	Azimuth (degrees)	Polarization	Correction (dB)
2211.824326	39.21	53.96	-14.75	3.48	0.00	Horizontal	6.85
2211.825641	41.24	53.96	-12.72	1.00	356.25	Vertical	6.85

Table 26: RE test results from 1 to 3 GHz for Part 24/27 (SC2 - LTE + NBloT GB, Bot channel)

Frequency (MHz)	Level (dBµV/m)	EIRP Limit (dBµV/m)	Margin to (dB)	Height (m)	Azimuth (degrees)	Polarization	Correction (dB)
2211.824326	39.21	82.2	- 42.99	3.48	0.00	Horizontal	6.85
2211.825641	41.24	82.2	- 40.96	1.00	356.25	Vertical	6.85

Note: In the table/Plot above, no emissions exceed the Part 24/Part 27 radiated spurious emissions limit when converted to dBuV/m, except for the fundamentals. For final spurious emissions measurements to FCC Part 24/Part 27, see antenna port conducted emissions in applicable test report.

Figure 25: Plot of RE at 3m from 3 to 10 GHz (SC2 - LTE + NBloT GB, Bot channel)

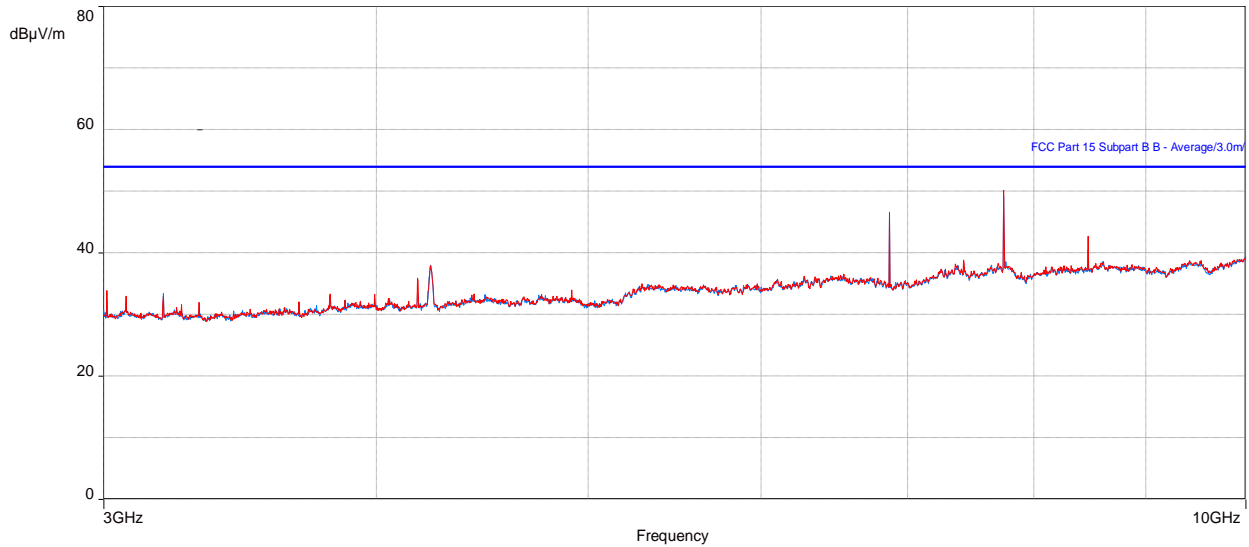

Table 27: RE test results from 3 to 10 GHz for FCC Part 15 (SC2 - LTE + NBloT GB, Bot channel)

Frequency (MHz)	Level Average (dBµV/m)	Limit Average (dBµV/m)	Margin to FCC part 15 Class B (dB)	Height (m)	Azimuth (degrees)	Polarization	Correction (dB)
7749.948044	49.08	53.96	-4.88	1.39	290.50	Vertical	5.40
7749.947469	48.32	53.96	-5.64	2.86	254.75	Horizontal	5.40
6869.952918	47.37	53.96	-6.59	2.86	360.00	Horizontal	1.96
6869.956123	47.02	53.96	-6.94	2.59	213.50	Vertical	1.96

Table 28: RE test results from 3 to 10 GHz for Part 24/27 (SC2 - LTE + NBloT GB, Bot channel)

Frequency (MHz)	Level (dBµV/m)	EIRP Limit (dBµV/m)	Margin to (dB)	Height (m)	Azimuth (degrees)	Polarization	Correction (dB)
7749.948044	49.08	82.2	- 33.12	1.39	290.50	Vertical	5.40
7749.947469	48.32	82.2	- 33.88	2.86	254.75	Horizontal	5.40
6869.952918	47.37	82.2	- 34.83	2.86	360.00	Horizontal	1.96
6869.956123	47.02	82.2	- 35.18	2.59	213.50	Vertical	1.96

Note: In the table/Plot above, no emissions exceed the Part 24/Part 27 radiated spurious emissions limit when converted to dBuV/m. For final spurious emissions measurements to FCC Part 24/Part 27, see antenna port conducted emissions in applicable test report.

Figure 26: Plot of RE at 3m from 10 to 18 GHz (SC2 - LTE + NBloT GB, Bot channel)

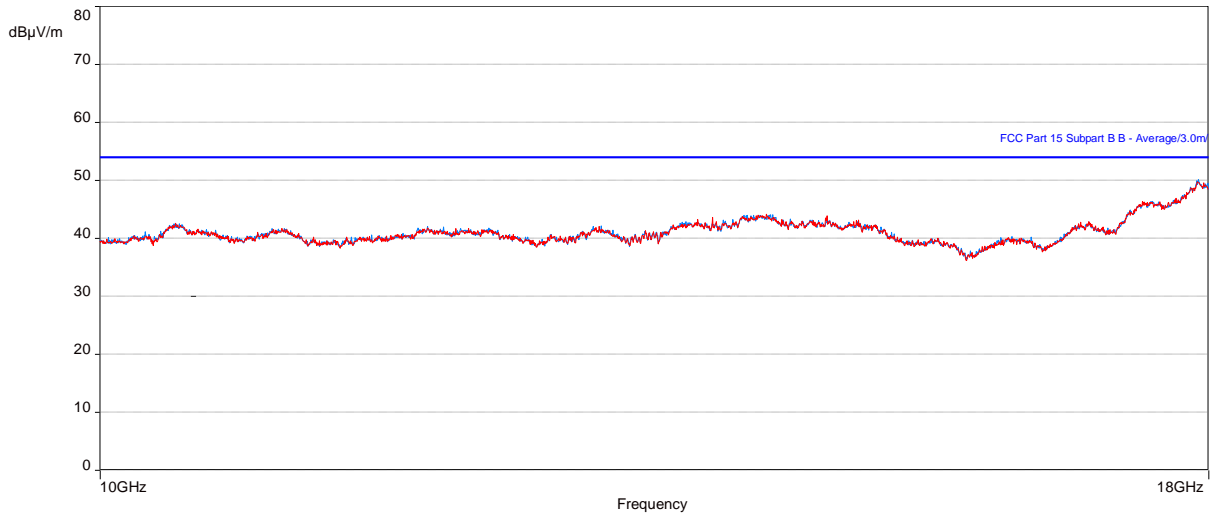

Table 29: RE test results from 10 to 18 GHz for FCC Part 15 (SC2 - LTE + NBloT GB, Bot channel)

Frequency (MHz)	Level Average (dBµV/m)	Limit Average (dBµV/m)	Margin to FCC part 15 Class B (dB)	Height (m)	Azimuth (degrees)	Polarization	Correction (dB)
17895.81731	46.79	53.96	-7.17	1.00	357.75	Vertical	20.36
17901.76346	46.88	53.96	-7.08	1.00	-0.25	Horizontal	20.44

Table 30: RE test results from 10 to 18 GHz for Part 24/27 (SC2 - LTE + NBloT GB, Bot channel)

Frequency (MHz)	Level (dBµV/m)	EIRP Limit (dBµV/m)	Margin to (dB)	Height (m)	Azimuth (degrees)	Polarization	Correction (dB)
17895.81731	46.79	82.2	- 35.41	1.00	357.75	Vertical	20.36
17901.76346	46.88	82.2	- 35.32	1.00	-0.25	Horizontal	20.44

Note: In the table/Plot above, no emissions exceed the Part 24/Part 27 radiated spurious emissions limit when converted to dBuV/m. For final spurious emissions measurements to FCC Part 24/Part 27, see antenna port conducted emissions in applicable test report.

Figure 27: Plot of RE at 1m from 18 to 26.5 GHz (SC2 - LTE + NBloT GB, Bot channel)

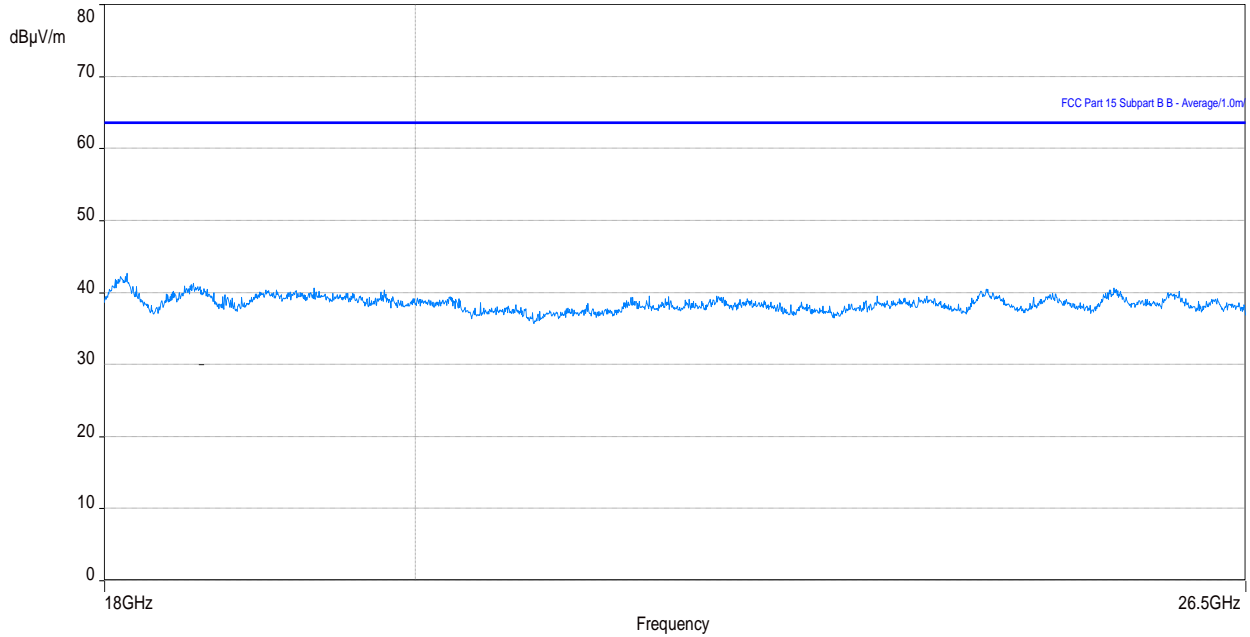

Note 1: In the plot above No Emissions exceeds the FCC Part 15/ICES 003 limit.

Note 2: In the plot above, no emissions exceed the Part 24/27 radiated spurious emissions limit when converted to dBuV/m. For final spurious emissions measurements to FCC Part 24/27, see antenna port conducted emissions in applicable test report.



3.2.7 Test results of RE (Single RAT/Carrier, **SC2** - LTE + NBloT GB, Top channel)

Test location: 10-meter Ambient Free Chamber (AFC)

Date tested: 3-16, February 2021

Tested by: Krupal Patel & Tom Ott

Test configurations are identified in the section [Configurations of the EUT](#).

For the following test results that have supporting data tables, negative margin values indicate a pass.

Figure 28: Plot of RE at 3 m – 30 to 1000 MHz (LTE + NB IoT GB, Top channel)

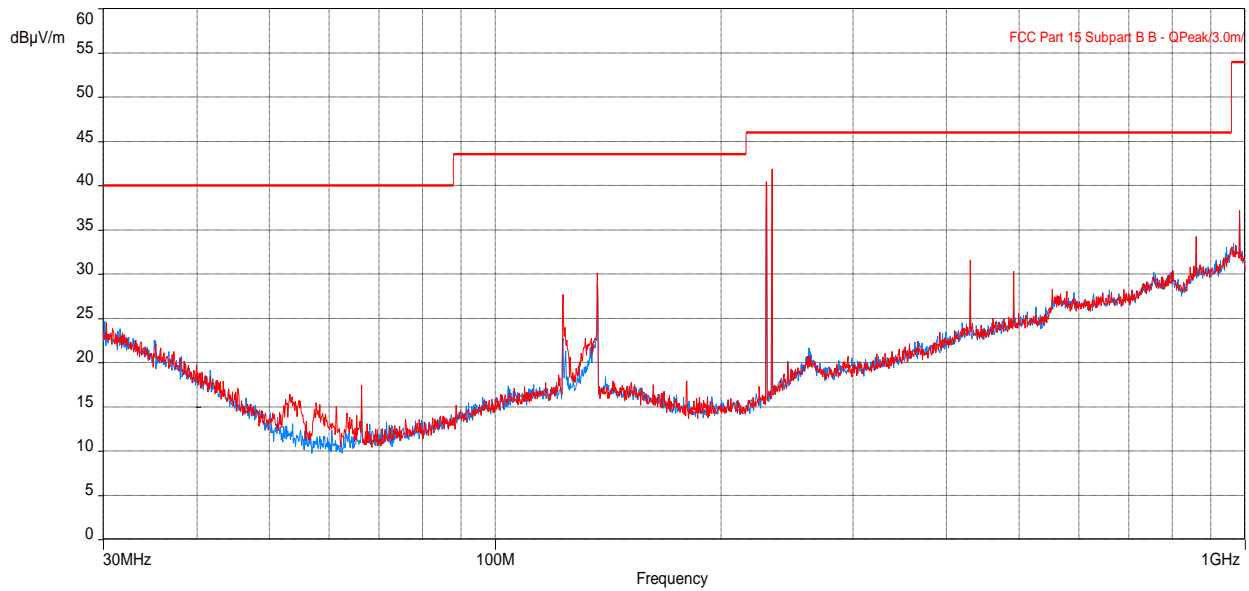

Table 31: RE test results from 30 to 1000 MHz for FCC Part 15 (LTE + NB IoT GB, Top channel)

Frequency (MHz)	Level Quasi Peak (dBµV/m)	Limit Quasi-peak (dBµV/m)	Margin to FCC part 15 Class B (dB)	Height (m)	Azimuth (deg)	Polarization	Correction (dB)
233.9495672	40.44	46.02	-5.58	3.28	134.25	Vertical	-7.82
983.0331313	37.65	53.98	-16.33	2.95	290.75	Horizontal	8.78
229.9994167	37.33	46.02	-8.69	1.16	26.00	Horizontal	-8.24

Table 32: RE test results from 30 to 1000 MHz for FCC Part 24/27 (LTE + NB IoT GB, Top channel)

Frequency (MHz)	Level (dBµV/m)	EIRP Limit (dBµV/m)	Margin to (dB)	Height (m)	Azimuth (deg)	Polarization	Correction (dB)
233.9495672	40.44	82.2	-41.76	3.28	134.25	Vertical	-7.82
983.0331313	37.65	82.2	-44.55	2.95	290.75	Horizontal	8.78
229.9994167	37.33	82.2	-44.87	1.16	26.00	Horizontal	-8.24

Note: In the table/Plot above, no emissions exceed the Part 24/Part 27 radiated spurious emissions limit when converted to dBuV/m. For final spurious emissions measurements to FCC Part 24/Part 27, see antenna port conducted emissions in applicable test report.

Figure 29: Plot of RE at 3m from 1 to 3 GHz (SC2 - LTE + NBloT GB, Top channel)

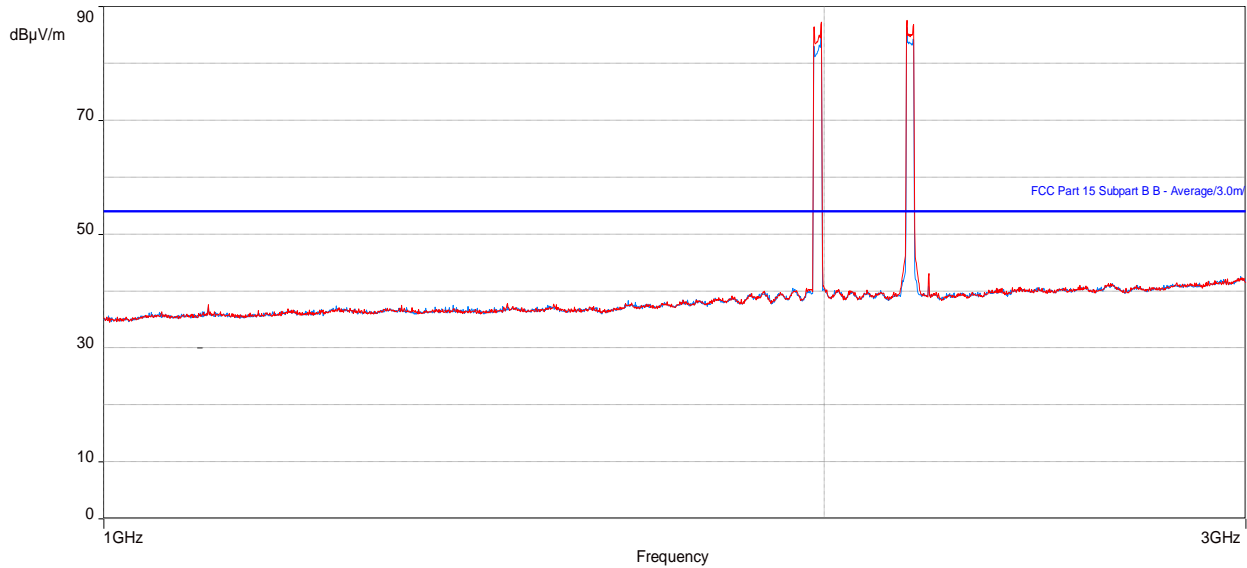

Note: Peaks above the limit are leakage of the EUT’s fundamentals from the 50-ohm terminations.

Table 33: RE test results from 1 to 3 GHz for FCC Part 15 (SC2 - LTE + NBloT GB, Top channel)

Frequency (MHz)	Level Average (dBµV/m)	Limit Average (dBµV/m)	Margin to FCC part 15 Class B (dB)	Height (m)	Azimuth (degrees)	Polarization	Correction (dB)
2050.311859	36.42	53.96	-17.54	1.32	342.00	Vertical	7.13
2211.825641	39.79	53.96	-14.17	1.73	360.00	Vertical	6.85

Table 34: RE test results from 1 to 3 GHz for Part 24/27 (SC2 - LTE + NBloT GB, Top channel)

Frequency (MHz)	Level (dBµV/m)	EIRP Limit (dBµV/m)	Margin to (dB)	Height (m)	Azimuth (degrees)	Polarization	Correction (dB)
2050.311859	36.42	82.2	-45.78	1.32	342.00	Vertical	7.13
2211.825641	39.79	82.2	-42.41	1.73	360.00	Vertical	6.85

Note: In the table/Plot above, no emissions exceed the Part 24/Part 27 radiated spurious emissions limit when converted to dBuV/m, except for the fundamentals. For final spurious emissions measurements to FCC Part 24/Part 27, see antenna port conducted emissions in applicable test report.

Figure 30: Plot of RE at 3m from 3 to 10 GHz (SC2 - LTE + NBloT GB, Top channel)

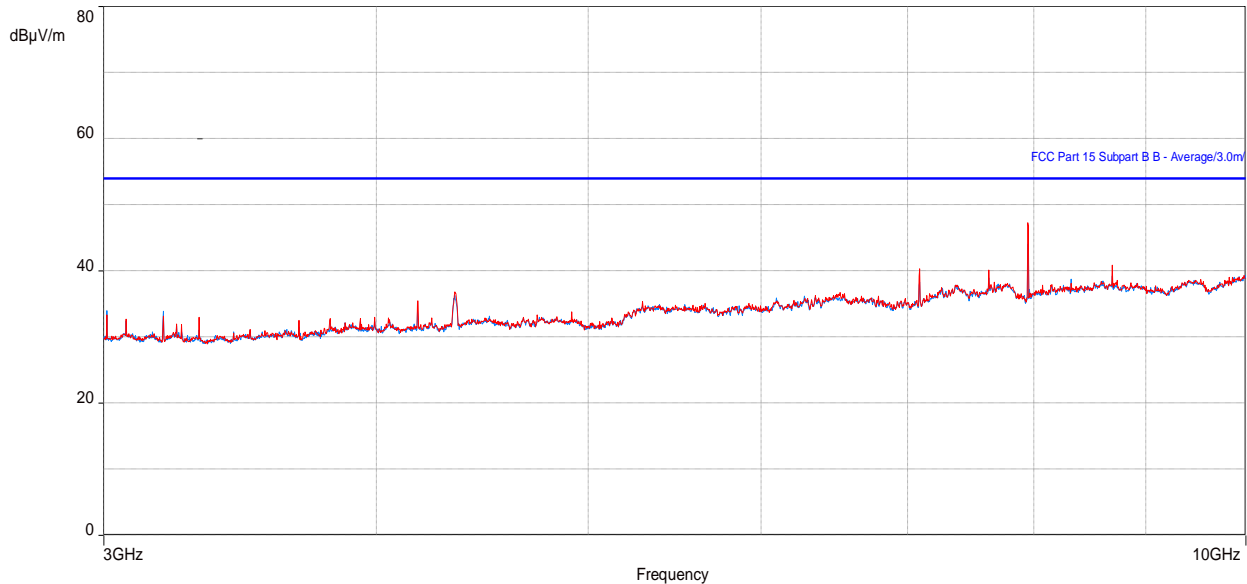

Table 35: RE test results from 3 to 10 GHz for FCC Part 15 (SC2 - LTE + NBloT GB, Top channel)

Frequency (MHz)	Level Average (dBµV/m)	Limit Average (dBµV/m)	Margin to FCC part 15 Class B (dB)	Height (m)	Azimuth (degrees)	Polarization	Correction (dB)
7949.947723	47.83	53.96	-6.13	1.39	40.75	Vertical	4.86
7089.952564	42.95	53.96	-11.01	2.08	198.75	Vertical	3.36
8689.940097	40.05	53.96	-13.91	4.00	269.00	Vertical	5.46
7629.949038	38.40	53.96	-15.56	3.31	299.75	Horizontal	5.32

Table 36: RE test results from 3 to 10 GHz for Part 24/27 (SC2 - LTE + NBloT GB, Top channel)

Frequency (MHz)	Level (dBµV/m)	EIRP Limit (dBµV/m)	Margin to (dB)	Height (m)	Azimuth (degrees)	Polarization	Correction (dB)
7949.947723	47.83	82.2	-34.37	1.39	40.75	Vertical	4.86
7089.952564	42.95	82.2	-39.25	2.08	198.75	Vertical	3.36
8689.940097	40.05	82.2	-42.15	4.00	269.00	Vertical	5.46
7629.949038	38.40	82.2	-43.80	3.31	299.75	Horizontal	5.32

Note: In the table/Plot above, no emissions exceed the Part 24/Part 27 radiated spurious emissions limit when converted to dBuV/m. For final spurious emissions measurements to FCC Part 24/Part 27, see antenna port conducted emissions in applicable test report.

Figure 31: Plot of RE at 3m from 10 to 18 GHz (SC2 - LTE + NBLoT GB, Top channel)

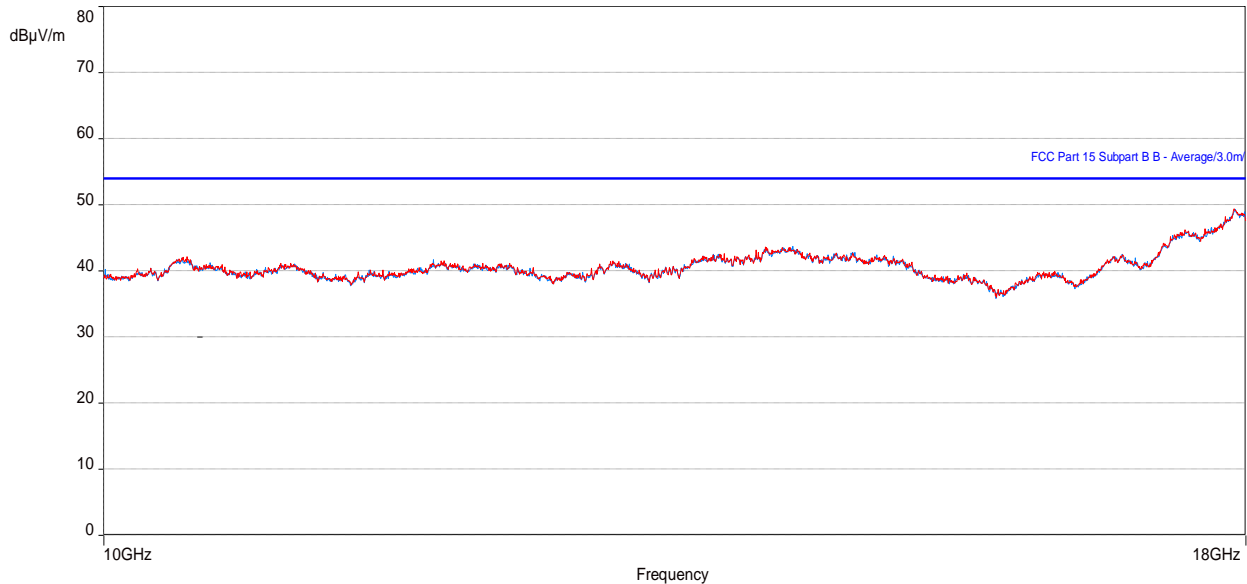

Table 37: RE test results from 10 to 18 GHz for FCC Part 15 (SC2 - LTE + NBLoT GB, Top channel)

Frequency (MHz)	Level Average (dBµV/m)	Limit Average (dBµV/m)	Margin to FCC part 15 Class B (dB)	Height (m)	Azimuth (degrees)	Polarization	Correction (dB)
17895.39328	46.71	53.96	-7.25	4.00	53.25	Vertical	20.35
17901.79488	46.69	53.96	-7.27	4.00	360.00	Horizontal	20.44

Table 38: RE test results from 10 to 18 GHz for Part 24/27 (SC2 - LTE + NBLoT GB, Top channel)

Frequency (MHz)	Level (dBµV/m)	EIRP Limit (dBµV/m)	Margin to (dB)	Height (m)	Azimuth (degrees)	Polarization	Correction (dB)
17895.39328	46.71	82.2	-35.49	4.00	53.25	Vertical	20.35
17901.79488	46.69	82.2	-35.51	4.00	360.00	Horizontal	20.44

Note: In the table/Plot above, no emissions exceed the Part 24/Part 27 radiated spurious emissions limit when converted to dBuV/m. For final spurious emissions measurements to FCC Part 24/Part 27, see antenna port conducted emissions in applicable test report.

Figure 32: Plot of RE at 1m from 18 to 26.5 GHz (SC2 - LTE + NBloT GB, Top channel)

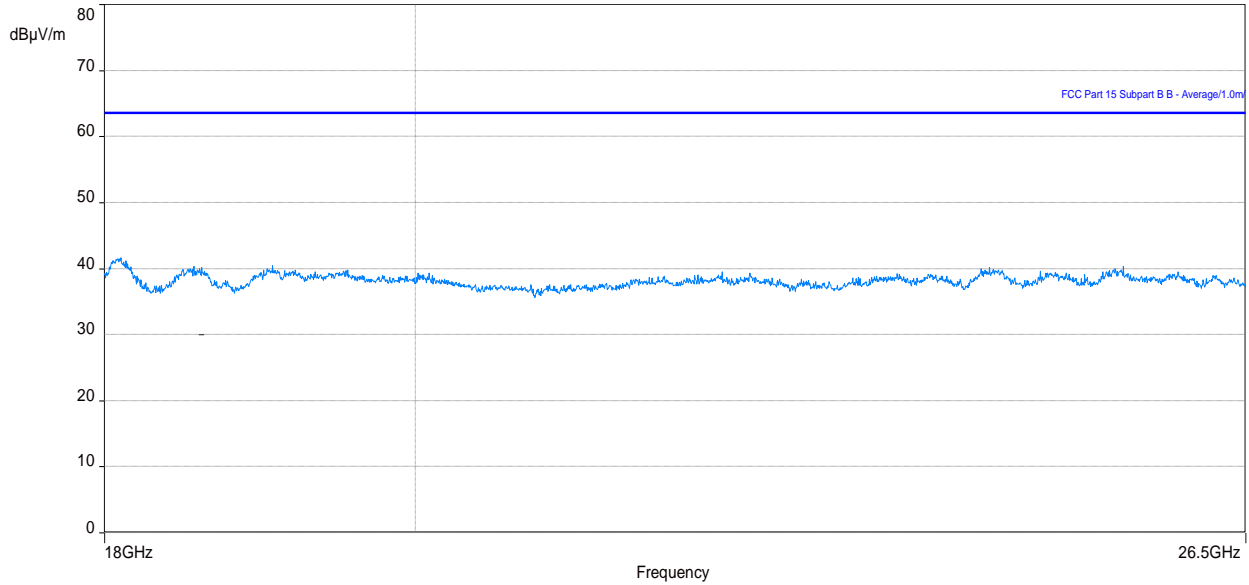

Note 1: In the plots above No Emissions exceeds the FCC Part 15/ICES 003 limit.

Note 2: In the plots above, no emissions exceed the Part 24/27 radiated spurious emissions limit when converted to dBuV/m. For final spurious emissions measurements to FCC Part 24/27, see antenna port conducted emissions in applicable test report.



3.2.8 Test results of RE (Single RAT/Carrier, SC1 - NR, Mid channel)

Test location: 10-meter Ambient Free Chamber (AFC)

Date tested: 3-16, February 2021

Tested by: Krupal Patel & Tom Ott

Test configurations are identified in the section [Configurations of the EUT](#).

For the following test results that have supporting data tables, negative margin values indicate a pass.

Figure 33: Plot of RE at 3 m – 30 to 1000 MHz (SC1 - NR, Mid channel)

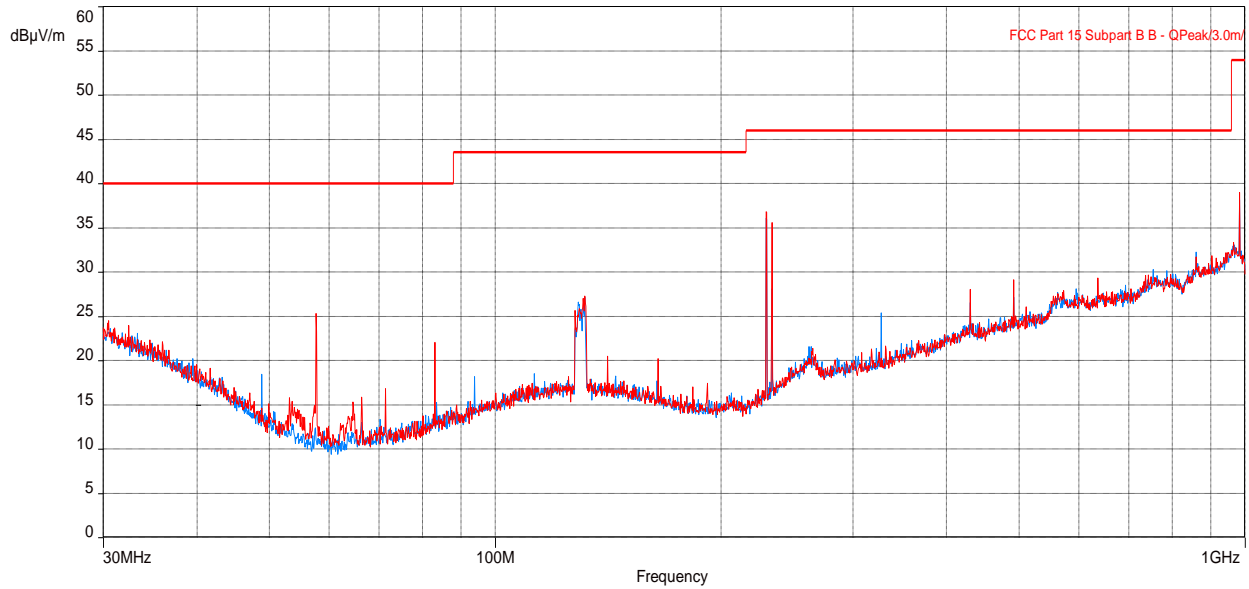

Table 39: RE test results from 30 to 1000 MHz for FCC Part 15 (SC1 - NR, Mid channel)

Frequency (MHz)	Level Quasi Peak (dBµV/m)	Limit Quasi-peak (dBµV/m)	Margin to FCC part 15 Class B (dB)	Height (m)	Azimuth (deg)	Polarization	Correction (dB)
131.6987149	23.45	43.52	-20.07	1.05	177.75	Horizontal	-7.45
229.9491697	38.15	46.02	-7.87	2.35	285.25	Vertical	-8.24
233.9431987	37.21	46.02	-8.81	2.31	342.75	Vertical	-7.82
983.0331313	38.76	53.98	-15.22	1.97	2.75	Vertical	8.78

Table 40: RE test results from 30 to 1000 MHz for FCC Part 24/27 (SC1 - NR, Mid channel)

Frequency (MHz)	Level (dBµV/m)	EIRP Limit (dBµV/m)	Margin to (dB)	Height (m)	Azimuth (deg)	Polarization	Correction (dB)
131.6987149	23.45	82.2	-58.75	1.05	177.75	Horizontal	-7.45
229.9491697	38.15	82.2	-44.05	2.35	285.25	Vertical	-8.24
233.9431987	37.21	82.2	-44.99	2.31	342.75	Vertical	-7.82
983.0331313	38.76	82.2	-43.44	1.97	2.75	Vertical	8.78

Note: In the table/Plot above, no emissions exceed the Part 24/Part 27 radiated spurious emissions limit when converted to dBuV/m. For final spurious emissions measurements to FCC Part 24/Part 27, see antenna port conducted emissions in applicable test report.

Figure 34: Plot of RE at 3m from 1 to 3 GHz (SC1 - NR, Mid channel)

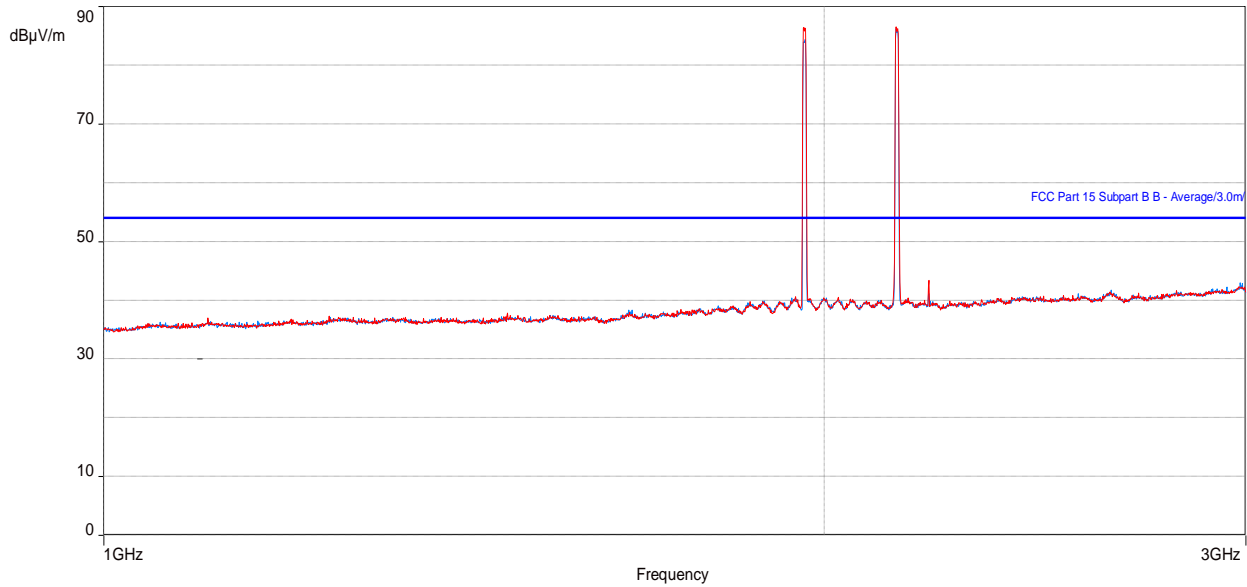

Note: Peaks above the limit are leakage of the EUT's fundamentals from the 50-ohm terminations.

Table 41: RE test results from 1 to 3 GHz for FCC Part 15 (SC1 - NR, Mid channel)

Frequency (MHz)	Level Average (dBµV/m)	Limit Average (dBµV/m)	Margin to FCC part 15 Class B (dB)	Height (m)	Azimuth (degrees)	Polarization	Correction (dB)
2211.825641	41.23	53.96	-12.73	4.00	304.75	Vertical	6.85
2984.594905	38.89	53.96	-15.07	3.34	297.75	Horizontal	9.68

Table 42: RE test results from 1 to 3 GHz for Part 24/27 (SC1 - NR, Mid channel)

Frequency (MHz)	Level (dBµV/m)	EIRP Limit (dBµV/m)	Margin to (dB)	Height (m)	Azimuth (degrees)	Polarization	Correction (dB)
2211.825641	41.23	82.2	-40.97	4.00	304.75	Vertical	6.85
2984.594905	38.89	82.2	-43.31	3.34	297.75	Horizontal	9.68

Note: In the table/Plot above, no emissions exceed the Part 24/Part 27 radiated spurious emissions limit when converted to dBuV/m, except for the fundamentals. For final spurious emissions measurements to FCC Part 24/Part 27, see antenna port conducted emissions in applicable test report.

Figure 35: Plot of RE at 3m from 3 to 10 GHz (SC1 - NR, Mid channel)

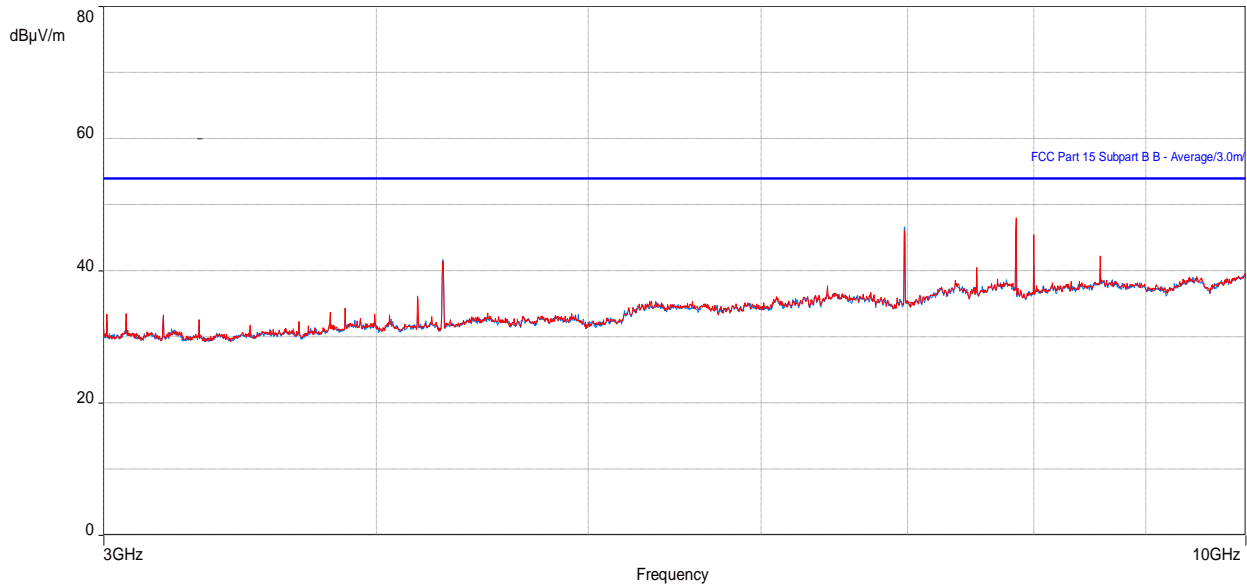

Table 43: RE test results from 3 to 10 GHz for FCC Part 15 (SC1 - NR, Mid channel)

Frequency (MHz)	Level Average (dBµV/m)	Limit Average (dBµV/m)	Margin to FCC part 15 Class B (dB)	Height (m)	Azimuth (degrees)	Polarization	Correction (dB)
7849.944905	46.95	53.96	-7.01	1.39	290.75	Vertical	4.49
7999.946154	45.89	53.96	-8.07	1.66	283.50	Vertical	5.16
6979.952277	45.75	53.96	-8.21	3.00	0.00	Horizontal	2.69

Table 44: RE test results from 3 to 10 GHz for Part 24/27 (SC1 - NR, Mid channel)

Frequency (MHz)	Level (dBµV/m)	EIRP Limit (dBµV/m)	Margin to (dB)	Height (m)	Azimuth (degrees)	Polarization	Correction (dB)
7849.944905	46.95	82.2	-35.25	1.39	290.75	Vertical	4.49
7999.946154	45.89	82.2	-36.31	1.66	283.50	Vertical	5.16
6979.952277	45.75	82.2	-36.45	3.00	0.00	Horizontal	2.69

Note: In the table/Plot above, no emissions exceed the Part 24/Part 27 radiated spurious emissions limit when converted to dBuV/m. For final spurious emissions measurements to FCC Part 24/Part 27, see antenna port conducted emissions in applicable test report.

Figure 36: Plot of RE at 3m from 10 to 18 GHz (SC1 - NR, Mid channel)

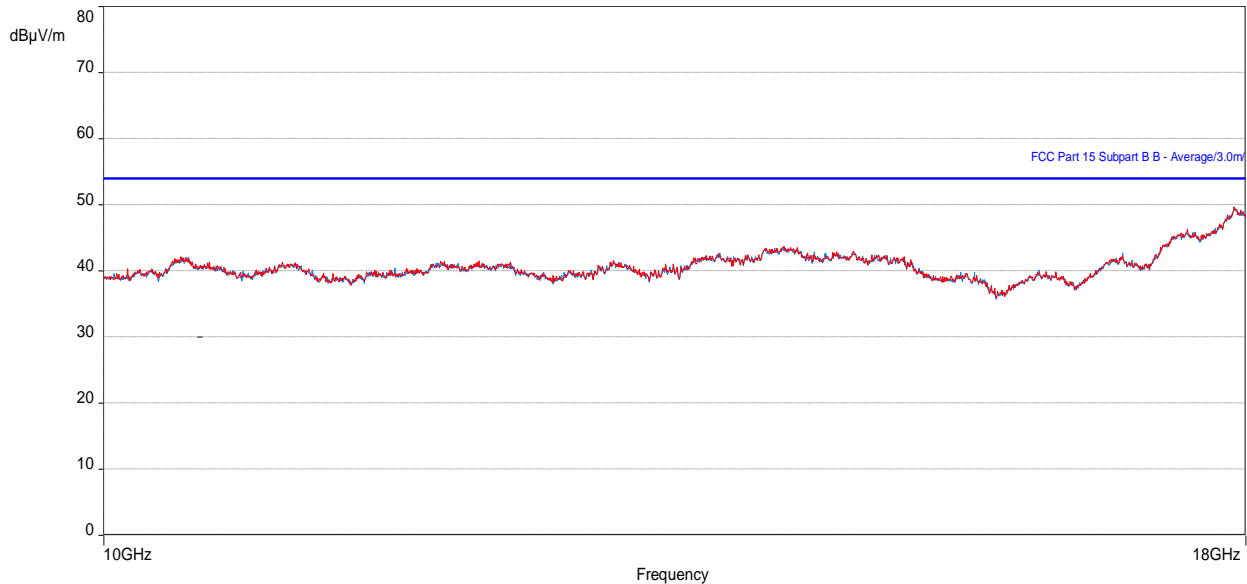

Table 45: RE test results from 10 to 18 GHz for FCC Part 15 (SC1 - NR, Mid channel)

Frequency (MHz)	Level Average (dBµV/m)	Limit Average (dBµV/m)	Margin to FCC part 15 Class B (dB)	Height (m)	Azimuth (degrees)	Polarization	Correction (dB)
17895.45899	46.66	53.96	-7.30	4.00	360.00	Horizontal	20.35
17895.58879	46.67	53.96	-7.29	1.00	9.50	Vertical	20.35

Table 46: RE test results from 10 to 18 GHz for Part 24/27 (SC1 - NR Mid channel)

Frequency (MHz)	Level (dBµV/m)	EIRP Limit (dBµV/m)	Margin to (dB)	Height (m)	Azimuth (degrees)	Polarization	Correction (dB)
17895.45899	46.66	82.2	-35.54	4.00	360.00	Horizontal	20.35
17895.58879	46.67	82.2	-35.53	1.00	9.50	Vertical	20.35

Note: In the table/Plot above, no emissions exceed the Part 24/Part 27 radiated spurious emissions limit when converted to dBuV/m. For final spurious emissions measurements to FCC Part 24/Part 27, see antenna port conducted emissions in applicable test report.

Figure 37: Plot of RE at 1m from 18 to 26.5 GHz (SC1 - NR, Mid channel)

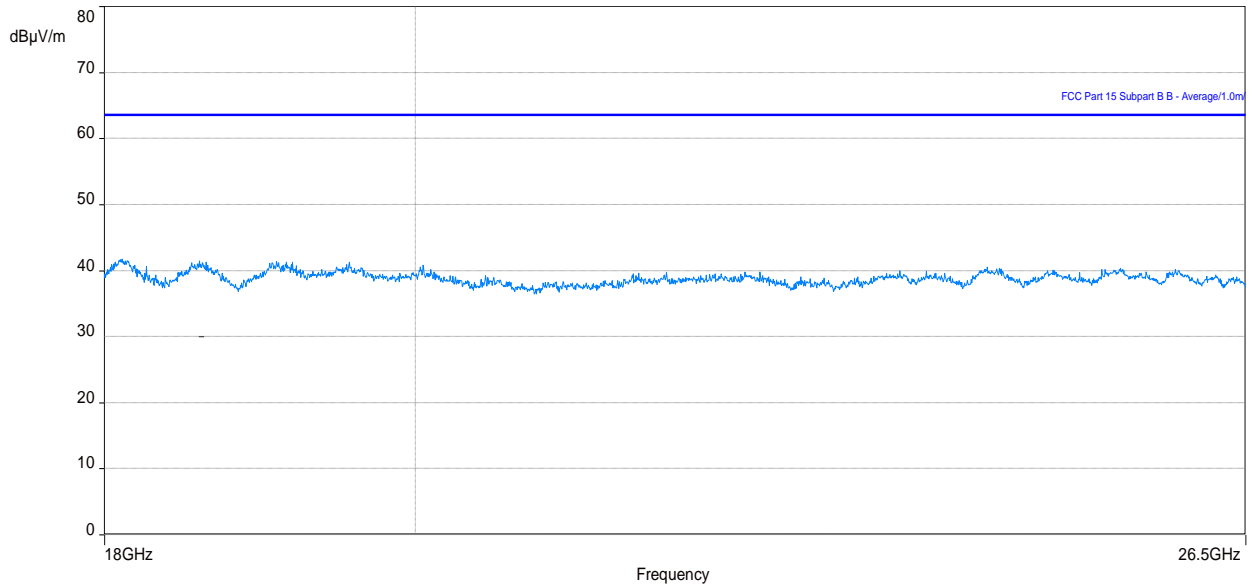

Note 1: In the plots above No Emissions exceeds the FCC Part 15/ICES 003 limit.

Note 2: In the plots above, no emissions exceed the Part 24/27 radiated spurious emissions limit when converted to dBuV/m. For final spurious emissions measurements to FCC Part 24/27, see antenna port conducted emissions in applicable test report.



3.2.9 Test results of RE (Single RAT/Multi carrier, 2 x LTE+NBlot GB, Mid channel)

Test location: 10-meter Ambient Free Chamber (AFC)

Date tested: 3-16, February 2021

Tested by: Krupal Patel & Tom Ott

Test configurations are identified in the section [Configurations of the EUT](#).

For the following test results that have supporting data tables, negative margin values indicate a pass.

Figure 38: Plot of RE at 3 m – 30 to 1000 MHz (2 x LTE+NBIoT GB – Mid channel)

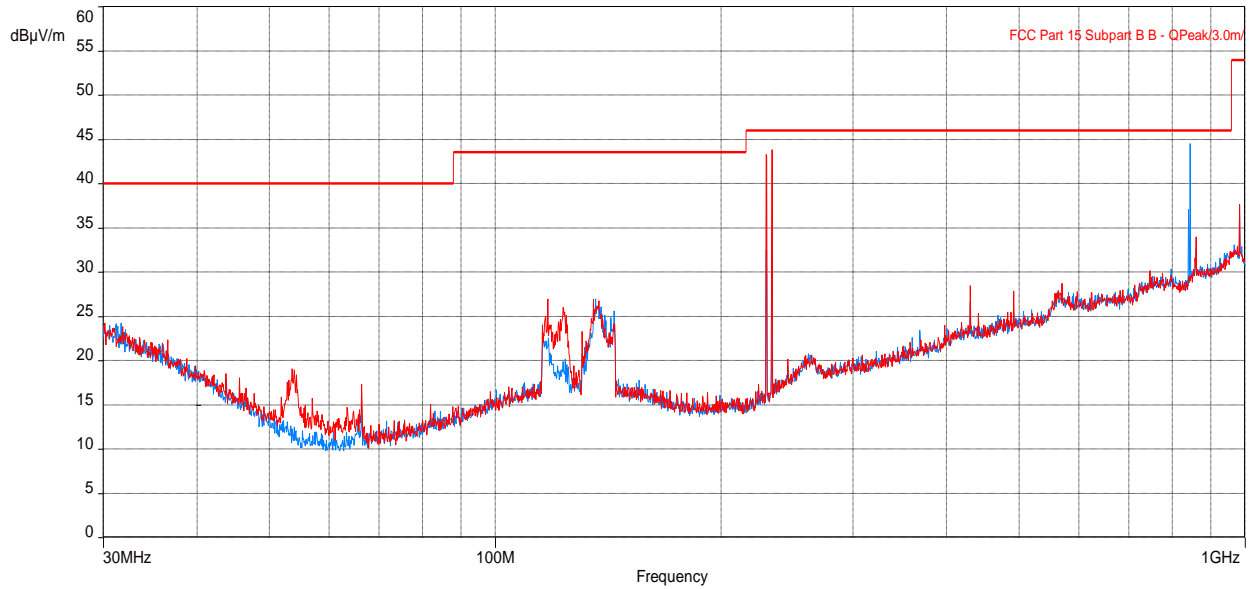

Table 47: RE test results from 30 to 1000 MHz for FCC Part 15 (2 x LTE+NBIoT GB – Mid channel)

Frequency (MHz)	Level Quasi Peak (dBµV/m)	Limit Quasi-peak (dBµV/m)	Margin to FCC part 15 Class B (dB)	Height (m)	Azimuth (deg)	Polarization	Correction (dB)
983.0334518	38.02	53.98	-15.96	3.02	240.00	Horizontal	8.78
229.9491697	37.86	46.02	-8.16	2.27	304.75	Vertical	-8.24
234.0492597	36.25	46.02	-9.77	2.97	220.75	Horizontal	-7.81
844.7044423	23.91	46.02	-22.11	2.11	9.50	Horizontal	6.45

Table 48: RE test results from 30 to 1000 MHz for FCC Part 24/27 (2 x LTE+NBIoT GB – Mid channel)

Frequency (MHz)	Level (dBµV/m)	EIRP Limit (dBµV/m)	Margin to (dB)	Height (m)	Azimuth (deg)	Polarization	Correction (dB)
983.0334518	38.02	82.2	-44.18	3.02	240.00	Horizontal	8.78
229.9491697	37.86	82.2	-44.34	2.27	304.75	Vertical	-8.24
234.0492597	36.25	82.2	-45.95	2.97	220.75	Horizontal	-7.81
844.7044423	23.91	82.2	-58.29	2.11	9.50	Horizontal	6.45

Note: In the table/Plot above, no emissions exceed the Part 24/Part 27 radiated spurious emissions limit when converted to dBuV/m. For final spurious emissions measurements to FCC Part 24/Part 27, see antenna port conducted emissions in applicable test report.

Figure 39: Plot of RE at 3m from 1 to 3 GHz (2 x LTE+NBIoT GB – Mid channel)

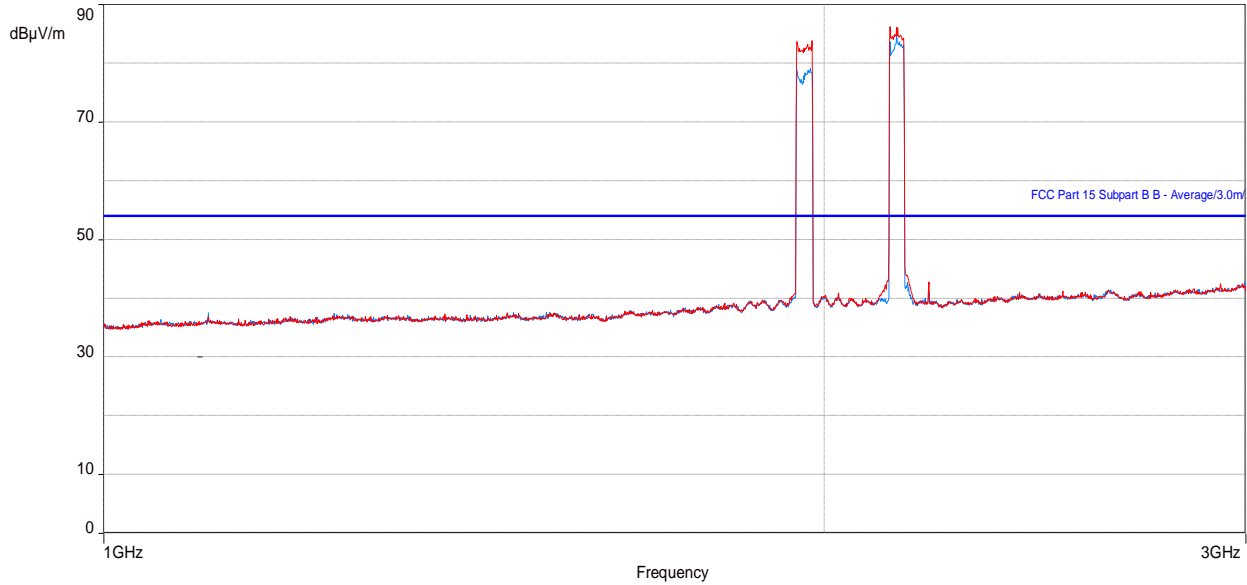

Note: Peaks above the limit are leakage of the EUT's fundamentals from the 50-ohm terminations.

Table 49: RE test results from 1 to 3 GHz for FCC Part 15 (2 x LTE+NBIoT GB – Mid channel)

Frequency (MHz)	Level Average (dBµV/m)	Limit Average (dBµV/m)	Margin to FCC part 15 Class B (dB)	Height (m)	Azimuth (degrees)	Polarization	Correction (dB)
2027.506444	39.06	53.96	-14.90	3.82	55.00	Vertical	7.15
2211.825033	39.60	53.96	-14.36	2.56	284.25	Horizontal	6.85
2211.824326	41.01	53.96	-12.95	3.46	305.75	Vertical	6.85

Table 50: RE test results from 1 to 3 GHz for Part 24/27 (2 x LTE+NBIoT GB – Mid channel)

Frequency (MHz)	Level (dBµV/m)	EIRP Limit (dBµV/m)	Margin to (dB)	Height (m)	Azimuth (degrees)	Polarization	Correction (dB)
2027.506444	39.06	82.2	-43.14	3.82	55.00	Vertical	7.15
2211.825033	39.60	82.2	-42.60	2.56	284.25	Horizontal	6.85
2211.824326	41.01	82.2	-41.19	3.46	305.75	Vertical	6.85

Note: In the table/Plot above, no emissions exceed the Part 24/Part 27 radiated spurious emissions limit when converted to dBµV/m, except for the fundamentals. For final spurious emissions measurements to FCC Part 24/Part 27, see antenna port conducted emissions in applicable test report.

Figure 40: Plot of RE at 3m from 3 to 10 GHz (2 x LTE+NBIoT GB – Mid channel)

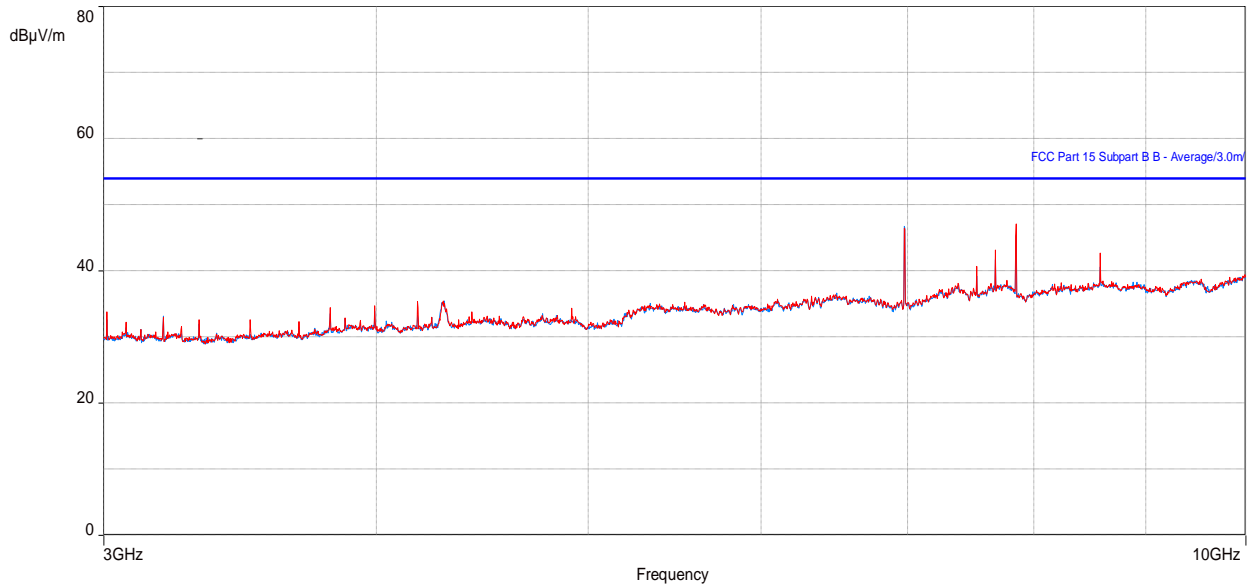

Table 51: RE test results from 3 to 10 GHz for FCC Part 15 (2 x LTE+NBIoT GB – Mid channel)

Frequency (MHz)	Level Average (dBµV/m)	Limit Average (dBµV/m)	Margin to FCC part 15 Class B (dB)	Height (m)	Azimuth (degrees)	Polarization	Correction (dB)
6979.952277	47.62	53.96	-6.34	2.93	4.75	Horizontal	2.69
7679.949072	41.71	53.96	-12.25	1.66	283.25	Vertical	5.23
7849.947082	46.40	53.96	-7.56	1.04	62.25	Vertical	4.49
8579.941313	42.19	53.96	-11.77	3.88	276.00	Vertical	5.42

Table 52: RE test results from 3 to 10 GHz for Part 24/27 (2 x LTE+NBIoT GB – Mid channel)

Frequency (MHz)	Level (dBµV/m)	EIRP Limit (dBµV/m)	Margin to (dB)	Height (m)	Azimuth (degrees)	Polarization	Correction (dB)
6979.952277	47.62	82.2	-34.58	2.93	4.75	Horizontal	2.69
7679.949072	41.71	82.2	-40.49	1.66	283.25	Vertical	5.23
7849.947082	46.40	82.2	-35.8	1.04	62.25	Vertical	4.49
8579.941313	42.19	82.2	-40.01	3.88	276.00	Vertical	5.42

Note: In the table/Plot above, no emissions exceed the Part 24/Part 27 radiated spurious emissions limit when converted to dBuV/m. For final spurious emissions measurements to FCC Part 24/Part 27, see antenna port conducted emissions in applicable test report.

Figure 41: Plot of RE at 3m from 10 to 18 GHz (2 x LTE+NBIoT GB – Mid channel)

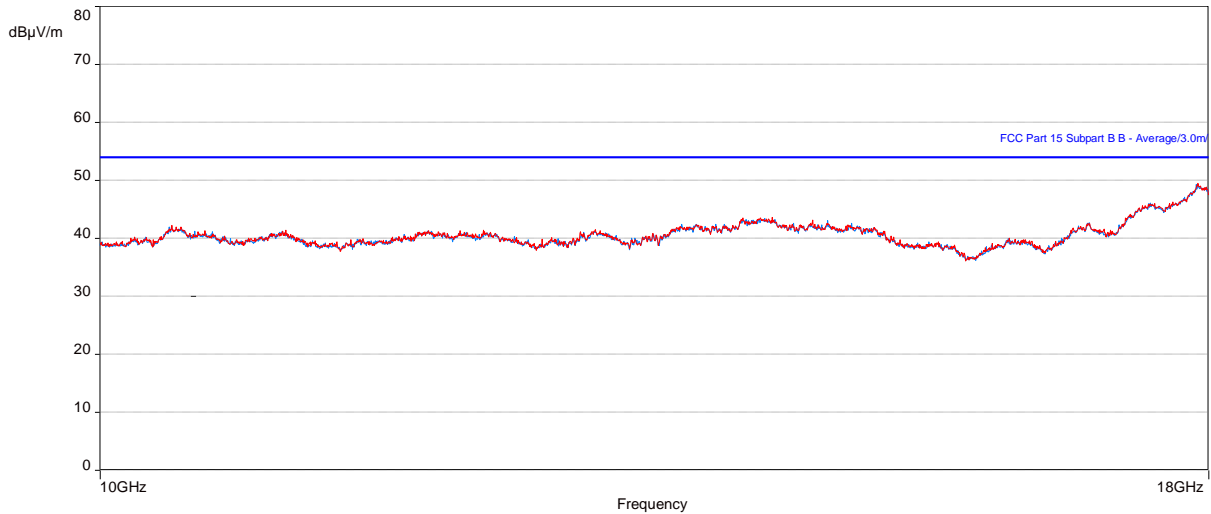

Table 53: RE test results from 10 to 18 GHz for FCC Part 15 (2 x LTE+NBIoT GB – Mid channel)

Frequency (MHz)	Level Average (dBµV/m)	Limit Average (dBµV/m)	Margin to FCC part 15 Class B (dB)	Height (m)	Azimuth (degrees)	Polarization	Correction (dB)
17884.68845	46.20	53.96	-7.76	4.00	234.75	Horizontal	20.11
17885.08303	46.26	53.96	-7.70	4.00	321.25	Horizontal	20.11
17896.76635	46.73	53.96	-7.23	4.00	24.50	Vertical	20.38

Table 54: RE test results from 10 to 18 GHz for Part 24/27 (2 x LTE+NBIoT GB – Mid channel)

Frequency (MHz)	Level (dBµV/m)	EIRP Limit (dBµV/m)	Margin to (dB)	Height (m)	Azimuth (degrees)	Polarization	Correction (dB)
17884.68845	46.20	82.2	-36.00	4.00	234.75	Horizontal	20.11
17885.08303	46.26	82.2	-35.94	4.00	321.25	Horizontal	20.11
17896.76635	46.73	82.2	-35.47	4.00	24.50	Vertical	20.38

Note: In the table/Plot above, no emissions exceed the Part 24/Part 27 radiated spurious emissions limit when converted to dBuV/m. For final spurious emissions measurements to FCC Part 24/Part 27, see antenna port conducted emissions in applicable test report.

Figure 42: Plot of RE at 1m from 18 to 26.5 GHz (2 x LTE+NBlOT GB – Mid channel)

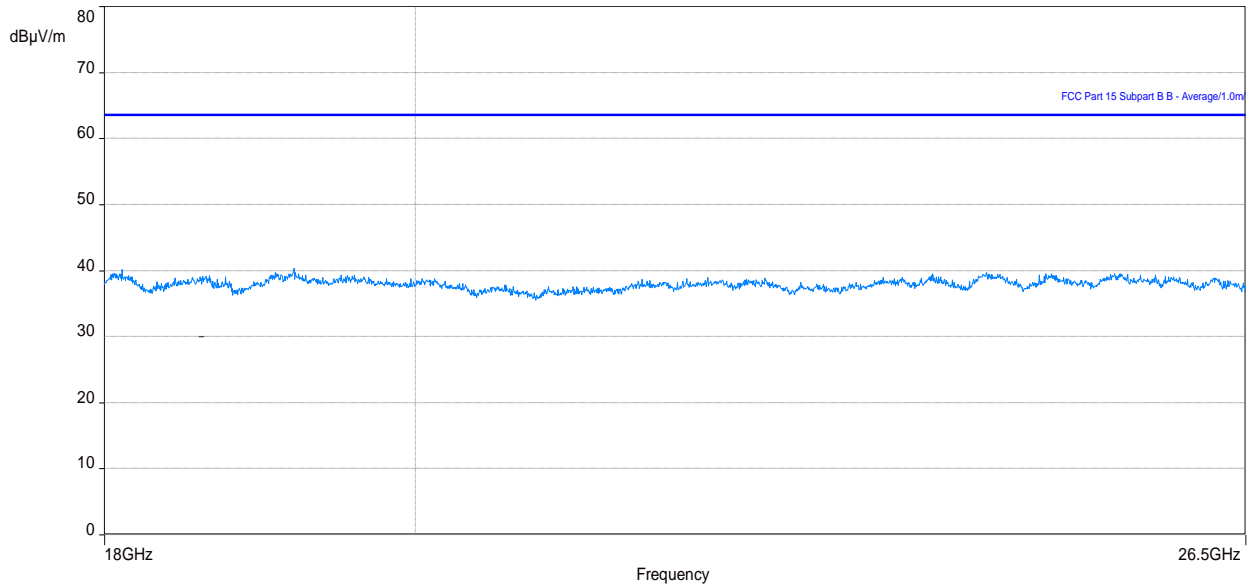

Note 1: In the plot above No Emissions exceeds the FCC Part 15/ICES 003 limit.

Note 2: In the plot above, no emissions exceed the Part 24/27 radiated spurious emissions limit when converted to dBuV/m. For final spurious emissions measurements to FCC Part 24/27, see antenna port conducted emissions in applicable test report.



3.2.10 Test results of RE (Multi RAT/Carrier, **MR1**- NBloT GB+WCDMA, Mid channel)

Test location: 10-meter Ambient Free Chamber (AFC)

Date tested: 3-16, February 2021

Tested by: Krupal Patel & Tom Ott

Test configurations are identified in the section [Configurations of the EUT](#).

For the following test results that have supporting data tables, negative margin values indicate a pass.

Figure 43: Plot of RE at 3 m – 30 to 1000 MHz (Config - MR1, Mid channel)

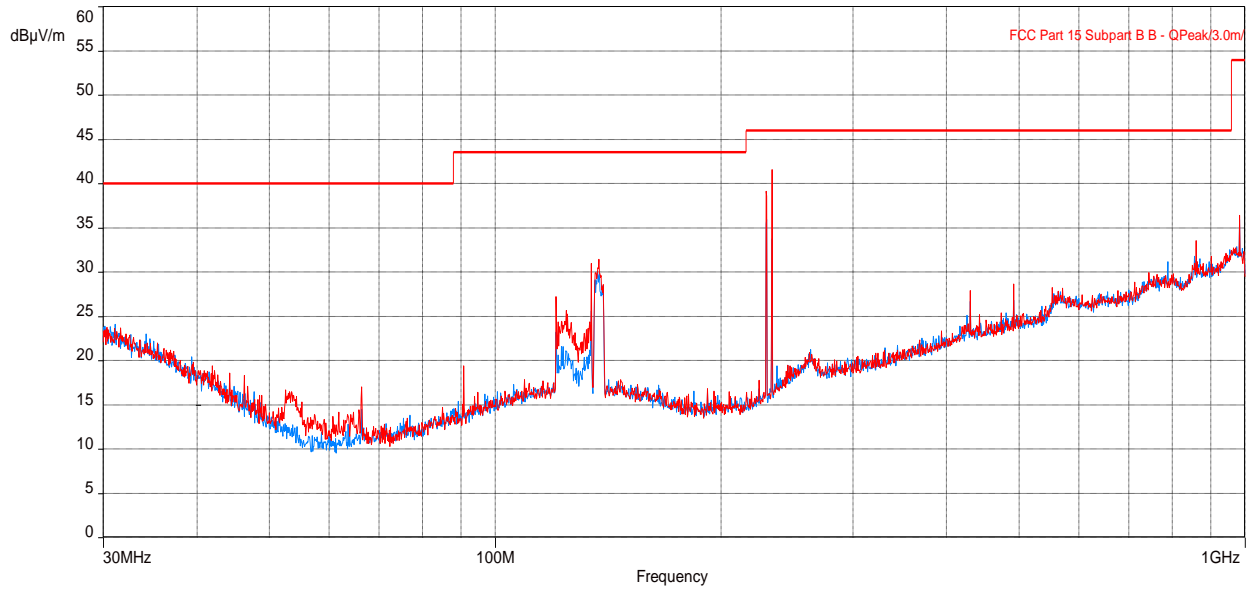

Table 55: RE test results from 30 to 1000 MHz for FCC Part 15 (Config - MR1, Mid channel)

Frequency (MHz)	Level Quasi Peak (dBµV/m)	Limit Quasi-peak (dBµV/m)	Margin to FCC part 15 Class B (dB)	Height (m)	Azimuth (deg)	Polarization	Correction (dB)
229.9491697	37.89	46.02	-8.13	2.36	148.75	Vertical	-8.24
983.0334518	37.66	53.98	-16.32	1.90	290.75	Horizontal	8.78
233.9492467	37.36	46.02	-8.66	1.04	163.25	Vertical	-7.82
230.0492146	35.18	46.02	-10.84	1.14	12.00	Horizontal	-8.23

Table 56: RE test results from 30 to 1000 MHz for FCC Part 24/27 (Config - MR1, Mid channel)

Frequency (MHz)	Level (dBµV/m)	EIRP Limit (dBµV/m)	Margin to (dB)	Height (m)	Azimuth (deg)	Polarization	Correction (dB)
229.9491697	37.89	82.2	-44.31	2.36	148.75	Vertical	-8.24
983.0334518	37.66	82.2	-44.54	1.90	290.75	Horizontal	8.78
233.9492467	37.36	82.2	-44.84	1.04	163.25	Vertical	-7.82
230.0492146	35.18	82.2	-47.02	1.14	12.00	Horizontal	-8.23

Note: In the table/Plot above, no emissions exceed the Part 24/Part 27 radiated spurious emissions limit when converted to dBuV/m. For final spurious emissions measurements to FCC Part 24/Part 27, see antenna port conducted emissions in applicable test report.

Figure 44: Plot of RE at 3m from 1 to 3 GHz (Config - MR1, Mid channel)

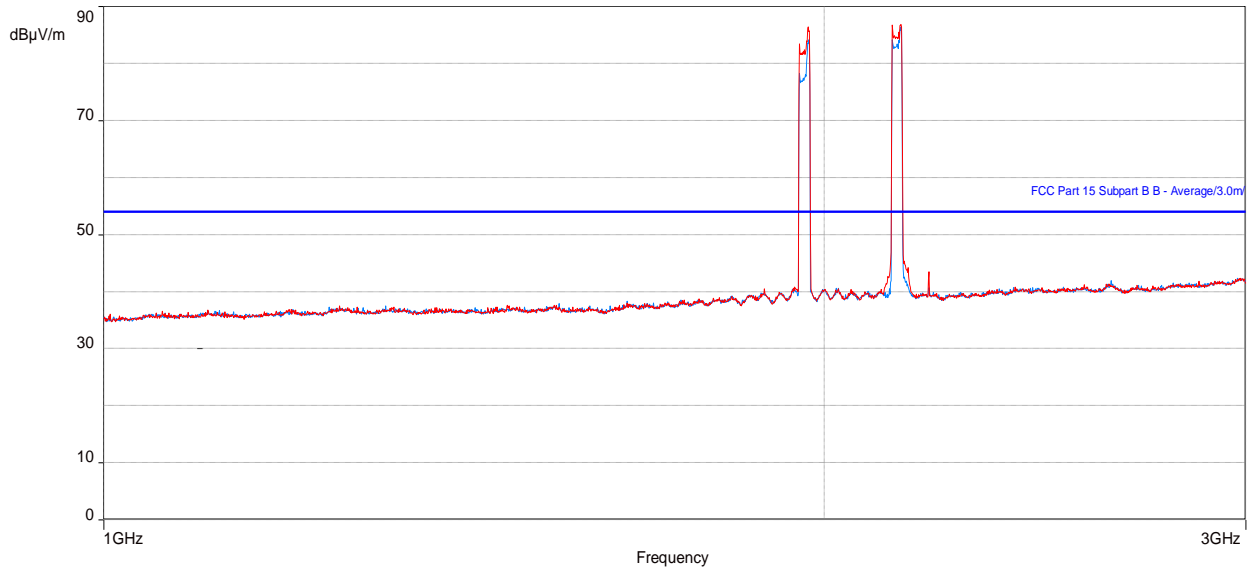

Note: Peaks above the limit are leakage of the EUT's fundamentals from the 50-ohm terminations.

Table 57: RE test results from 1 to 3 GHz for FCC Part 15 (Config - MR1, Mid channel)

Frequency (MHz)	Level Average (dBµV/m)	Limit Average (dBµV/m)	Margin to FCC part 15 Class B (dB)	Height (m)	Azimuth (degrees)	Polarization	Correction (dB)
1888.017021	36.43	53.96	-17.53	3.14	139.25	Vertical	6.53
2211.825641	41.75	53.96	-12.21	1.00	355.00	Vertical	6.85
2636.550608	37.79	53.96	-16.17	1.05	118.50	Horizontal	8.41

Table 58: RE test results from 1 to 3 GHz for Part 24/27 (Config - MR1, Mid channel)

Frequency (MHz)	Level (dBµV/m)	EIRP Limit (dBµV/m)	Margin to (dB)	Height (m)	Azimuth (degrees)	Polarization	Correction (dB)
1888.017021	36.43	82.2	-45.77	3.14	139.25	Vertical	6.53
2211.825641	41.75	82.2	-40.45	1.00	355.00	Vertical	6.85
2636.550608	37.79	82.2	-44.41	1.05	118.50	Horizontal	8.41

Note: In the table/Plot above, no emissions exceed the Part 24/Part 27 radiated spurious emissions limit when converted to dBuV/m, except for the fundamentals. For final spurious emissions measurements to FCC Part 24/Part 27, see antenna port conducted emissions in applicable test report.

Figure 45: Plot of RE at 3m from 3 to 10 GHz (Config - MR1, Mid channel)

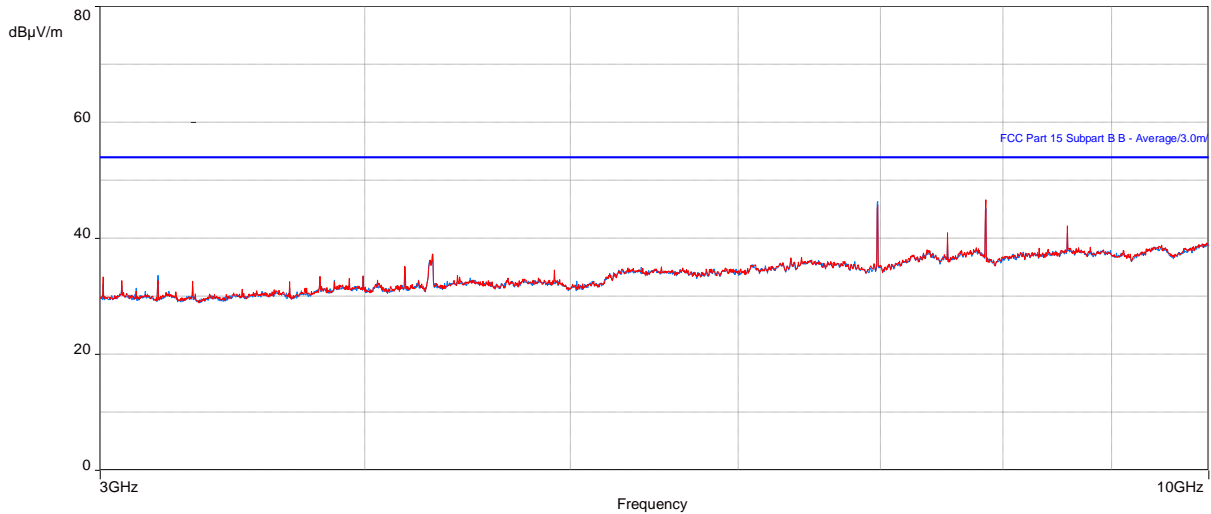

Table 59: RE test results from 3 to 10 GHz for FCC Part 15 (Config - MR1, Mid channel)

Frequency (MHz)	Level Average (dBµV/m)	Limit Average (dBµV/m)	Margin to FCC part 15 Class B (dB)	Height (m)	Azimuth (degrees)	Polarization	Correction (dB)
6980.151923	46.02	53.96	-7.94	3.00	0.00	Horizontal	2.69
7849.966313	46.88	53.96	-7.08	1.46	40.75	Vertical	4.49
8580.140385	42.18	53.96	-11.78	3.88	276.25	Vertical	5.43

Table 60: RE test results from 3 to 10 GHz for Part 24/27 (Config - MR1, Mid channel)

Frequency (MHz)	Level (dBµV/m)	EIRP Limit (dBµV/m)	Margin to (dB)	Height (m)	Azimuth (degrees)	Polarization	Correction (dB)
6980.151923	46.02	82.2	-36.18	3.00	0.00	Horizontal	2.69
7849.966313	46.88	82.2	-35.32	1.46	40.75	Vertical	4.49
8580.140385	42.18	82.2	-40.02	3.88	276.25	Vertical	5.43

Note: In the table/Plot above, no emissions exceed the Part 24/Part 27 radiated spurious emissions limit when converted to dBuV/m. For final spurious emissions measurements to FCC Part 24/Part 27, see antenna port conducted emissions in applicable test report.

Figure 46: Plot of RE at 3m from 10 to 18 GHz (Config - MR1, Mid channel)

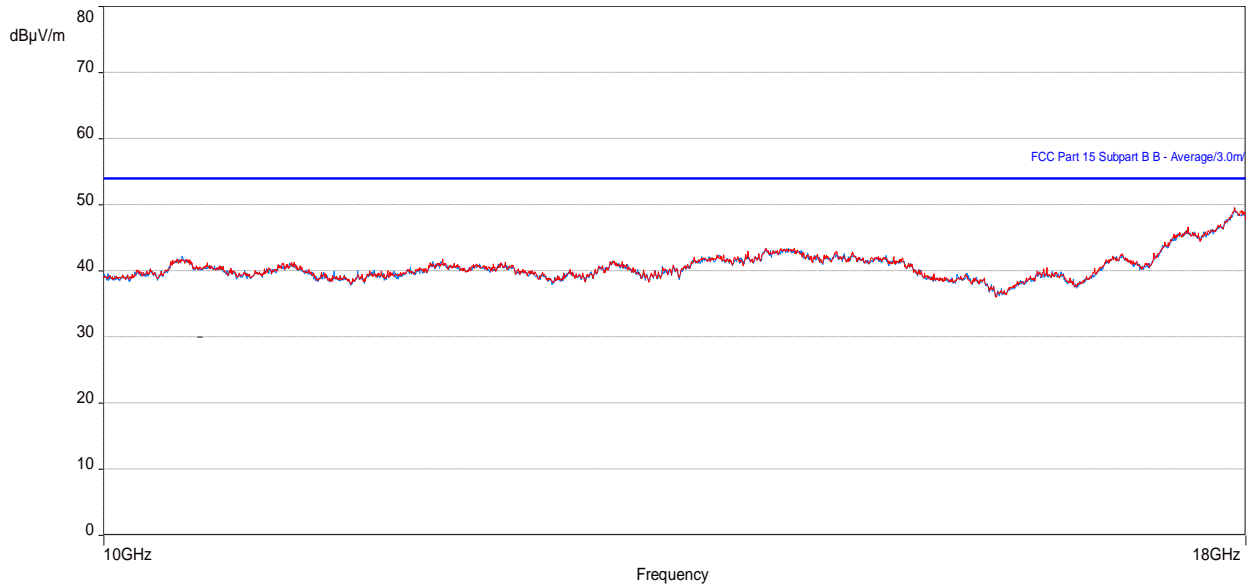

Table 61: RE test results from 10 to 18 GHz for FCC Part 15 (Config - MR1, Mid channel)

Frequency (MHz)	Level Average (dBµV/m)	Limit Average (dBµV/m)	Margin to FCC part 15 Class B (dB)	Height (m)	Azimuth (degrees)	Polarization	Correction (dB)
17897.69135	46.69	53.96	-7.27	3.96	10.00	Horizontal	20.40
17909.39229	46.67	53.96	-7.29	4.00	350.25	Vertical	20.39

Table 62: RE test results from 10 to 18 GHz for Part 24/27 (Config - MR1, Mid channel)

Frequency (MHz)	Level (dBµV/m)	EIRP Limit (dBµV/m)	Margin to (dB)	Height (m)	Azimuth (degrees)	Polarization	Correction (dB)
17897.69135	46.69	82.2	-35.51	3.96	10.00	Horizontal	20.40
17909.39229	46.67	82.2	-35.53	4.00	350.25	Vertical	20.39

Note: In the table/Plot above, no emissions exceed the Part 24/Part 27 radiated spurious emissions limit when converted to dBuV/m. For final spurious emissions measurements to FCC Part 24/Part 27, see antenna port conducted emissions in applicable test report.

Figure 47: Plot of RE at 1m from 18 to 26.5 GHz (Config - MR1, Mid channel)

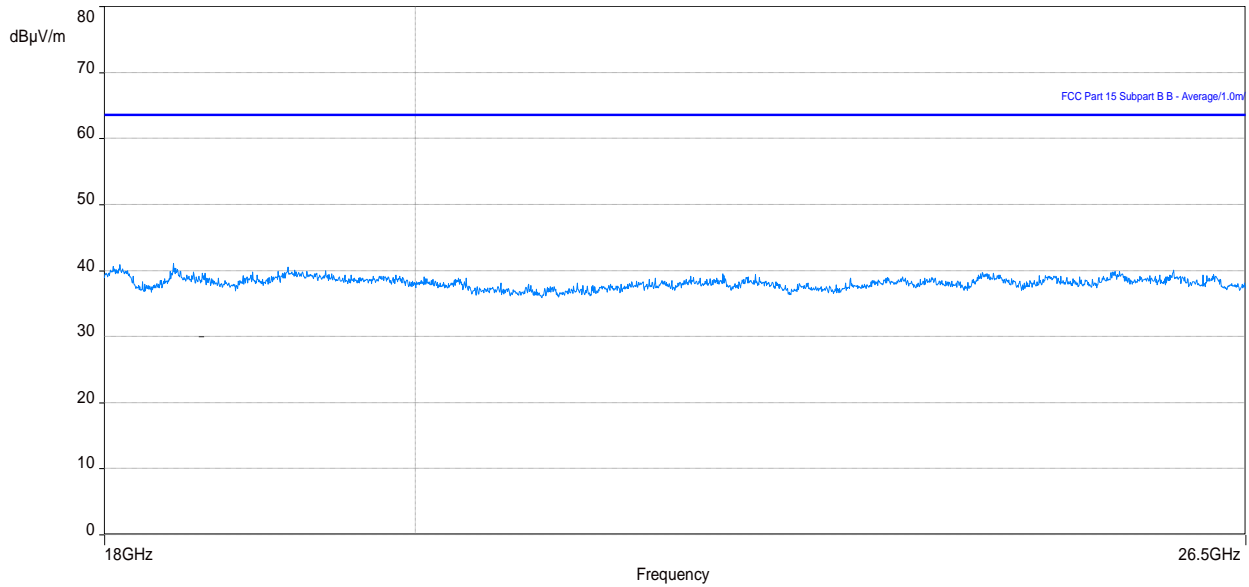

Note 1: In the plot above No Emissions exceeds the FCC Part 15/ICES 003 limit.

Note 2: In the plot above, no emissions exceed the Part 24/27 radiated spurious emissions limit when converted to dBuV/m. For final spurious emissions measurements to FCC Part 24/27, see antenna port conducted emissions in applicable test report.



3.2.11 Test results of RE (Multi RAT/Carrier, [MR 2- NBLoT GB+NR](#), Mid channel)

Test location: 10-meter Ambient Free Chamber (AFC)

Date tested: 3-16, February 2021

Tested by: Krupal Patel & Tom Ott

Test configurations are identified in the section [Configurations of the EUT](#).

For the following test results that have supporting data tables, negative margin values indicate a pass.

Figure 48: Plot of RE at 3 m – 30 to 1000 MHz (Config – MR2, Mid channel)

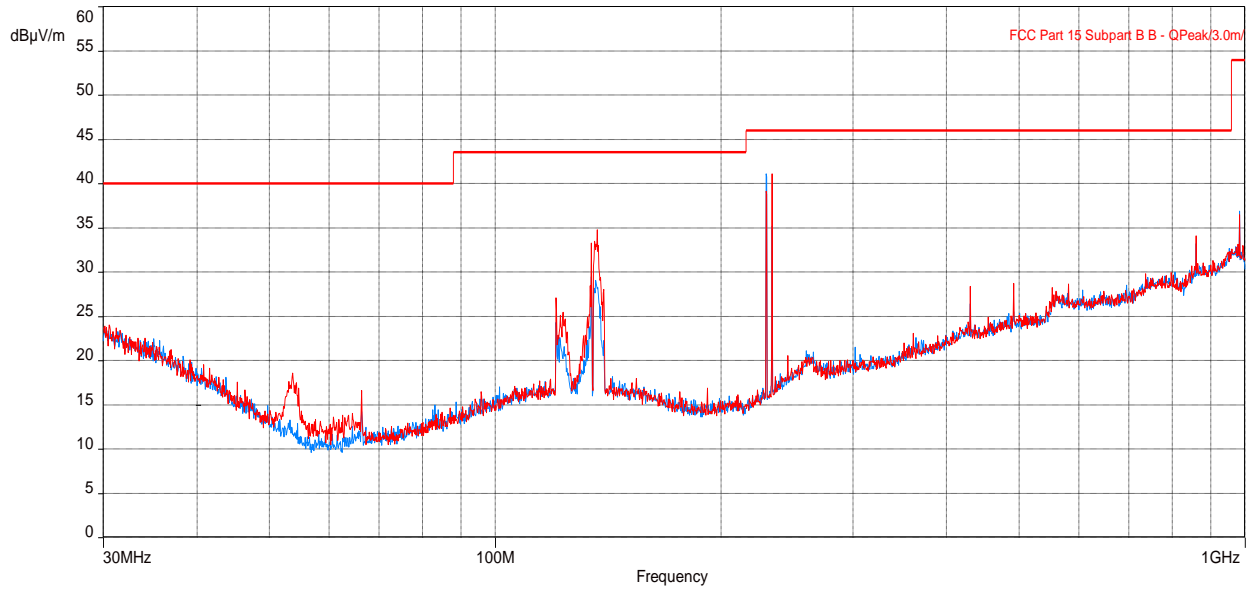

Table 63: RE test results from 30 to 1000 MHz for FCC Part 15 (Config – MR2, Mid channel)

Frequency (MHz)	Level Quasi Peak (dBµV/m)	Limit Quasi-peak (dBµV/m)	Margin to FCC part 15 Class B (dB)	Height (m)	Azimuth (deg)	Polarization	Correction (dB)
983.0331731	37.76	53.98	-16.22	1.91	290.75	Horizontal	8.78
234.0492915	37.08	46.02	-8.94	3.94	146.50	Vertical	-7.81
229.9990962	35.12	46.02	-10.90	2.28	261.75	Vertical	-8.24

Table 64: RE test results from 30 to 1000 MHz for FCC Part 24/27 (Config – MR2, Mid channel)

Frequency (MHz)	Level (dBµV/m)	EIRP Limit (dBµV/m)	Margin to (dB)	Height (m)	Azimuth (deg)	Polarization	Correction (dB)
983.0331731	37.76	82.2	-44.44	1.91	290.75	Horizontal	8.78
234.0492915	37.08	82.2	-45.12	3.94	146.50	Vertical	-7.81
229.9990962	35.12	82.2	-47.08	2.28	261.75	Vertical	-8.24

Note: In the table/Plot above, no emissions exceed the Part 24/Part 27 radiated spurious emissions limit when converted to dBuV/m. For final spurious emissions measurements to FCC Part 24/Part 27, see antenna port conducted emissions in applicable test report.

Figure 49: Plot of RE at 3m from 1 to 3 GHz (Config – MR2, Mid channel)

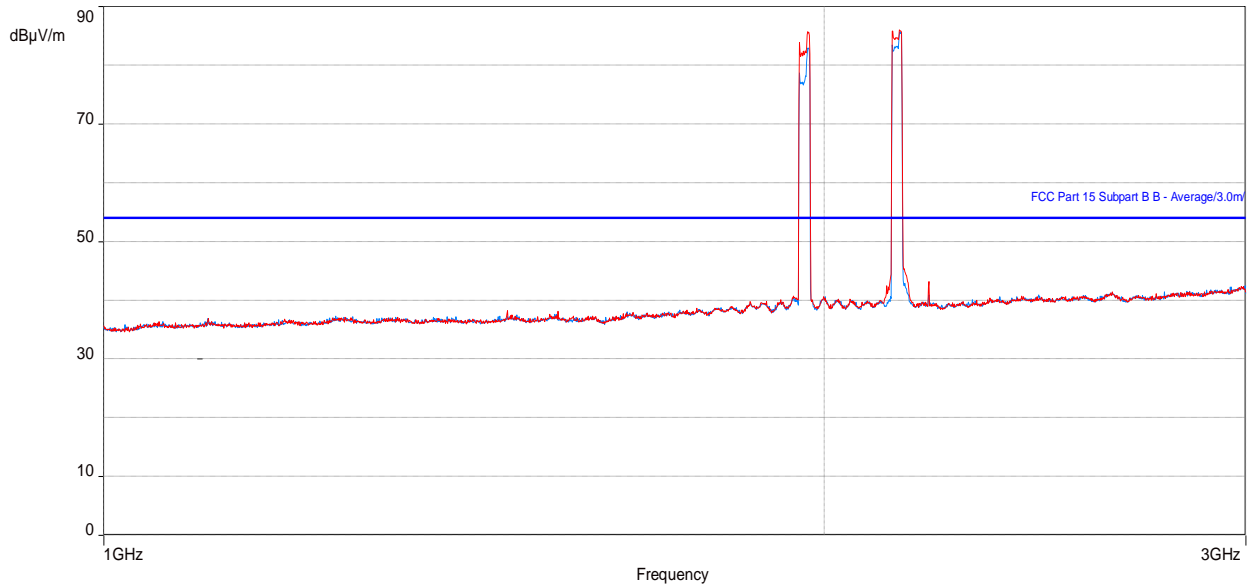

Note: Peaks above the limit are leakage of the EUT’s fundamentals from the 50-ohm terminations.

Table 65: RE test results from 1 to 3 GHz for FCC Part 15 (Config – MR2, Mid channel)

Frequency (MHz)	Level Average (dBµV/m)	Limit Average (dBµV/m)	Margin to FCC part 15 Class B (dB)	Height (m)	Azimuth (degrees)	Polarization	Correction (dB)
1892.157372	36.05	53.96	-17.91	2.14	357.25	Vertical	6.57
2211.824326	39.24	53.96	-14.72	3.48	359.75	Horizontal	6.85
2211.825033	41.56	53.96	-12.40	3.47	304.75	Vertical	6.85

Table 66: RE test results from 1 to 3 GHz for Part 24/27 (Config – MR2, Mid channel)

Frequency (MHz)	Level (dBµV/m)	EIRP Limit (dBµV/m)	Margin to (dB)	Height (m)	Azimuth (degrees)	Polarization	Correction (dB)
1892.157372	36.05	82.2	-46.15	2.14	357.25	Vertical	6.57
2211.824326	39.24	82.2	-42.96	3.48	359.75	Horizontal	6.85
2211.825033	41.56	82.2	-40.64	3.47	304.75	Vertical	6.85

Note: In the table/Plot above, no emissions exceed the Part 24/Part 27 radiated spurious emissions limit when converted to dBuV/m, except for the fundamentals. For final spurious emissions measurements to FCC Part 24/Part 27, see antenna port conducted emissions in applicable test report.

Figure 50: Plot of RE at 3m from 3 to 10 GHz (Config – MR2, Mid channel)

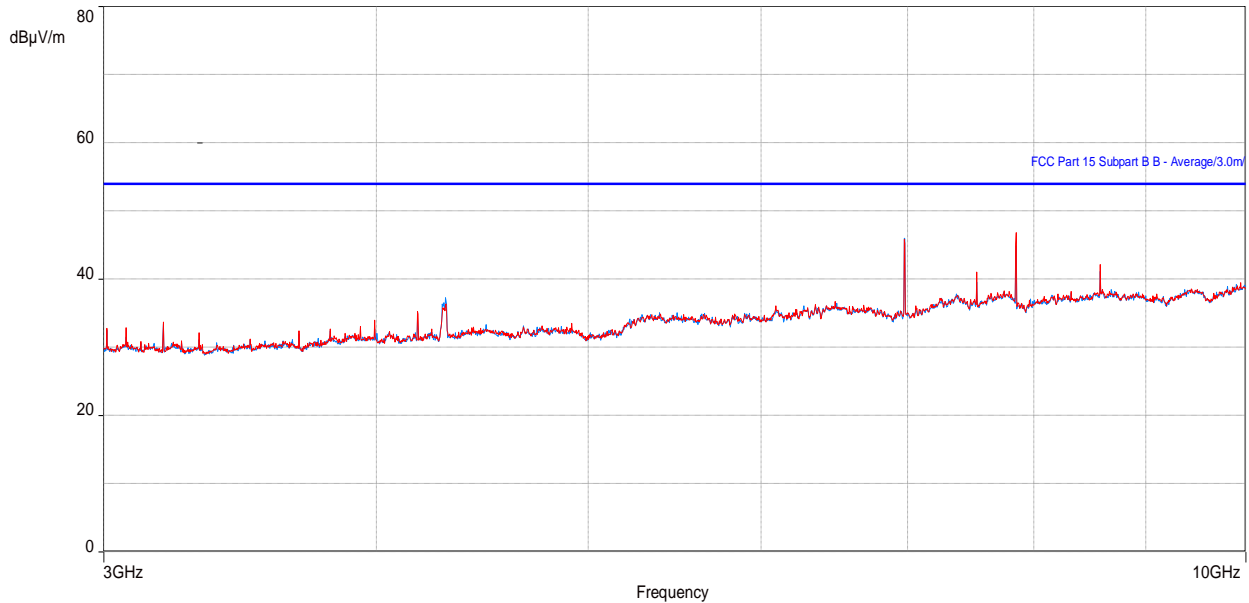

Table 67: RE test results from 3 to 10 GHz for FCC Part 15 (Config – MR2, Mid channel)

Frequency (MHz)	Level Average (dBµV/m)	Limit Average (dBµV/m)	Margin to FCC part 15 Class B (dB)	Height (m)	Azimuth (degrees)	Polarization	Correction (dB)
6979.971508	46.03	53.96	-7.93	3.00	0.00	Horizontal	2.69
7529.969585	40.94	53.96	-13.02	2.49	40.50	Vertical	4.74
7849.967341	46.77	53.96	-7.19	1.46	40.50	Vertical	4.49
8579.963174	41.96	53.96	-12.00	3.88	271.00	Vertical	5.42

Table 68: RE test results from 3 to 10 GHz for Part 24/27 (Config – MR2, Mid channel)

Frequency (MHz)	Level (dBµV/m)	EIRP Limit (dBµV/m)	Margin to (dB)	Height (m)	Azimuth (degrees)	Polarization	Correction (dB)
6979.971508	46.03	82.2	-36.17	3.00	0.00	Horizontal	2.69
7849.967341	46.77	82.2	-35.43	1.46	40.50	Vertical	4.49
8579.963174	41.96	82.2	-40.24	3.88	271.00	Vertical	5.42

Note: In the table/Plot above, no emissions exceed the Part 24/Part 27 radiated spurious emissions limit when converted to dBuV/m. For final spurious emissions measurements to FCC Part 24/Part 27, see antenna port conducted emissions in applicable test report.

Figure 51: Plot of RE at 3m from 10 to 18 GHz (Config – MR2, Mid channel)

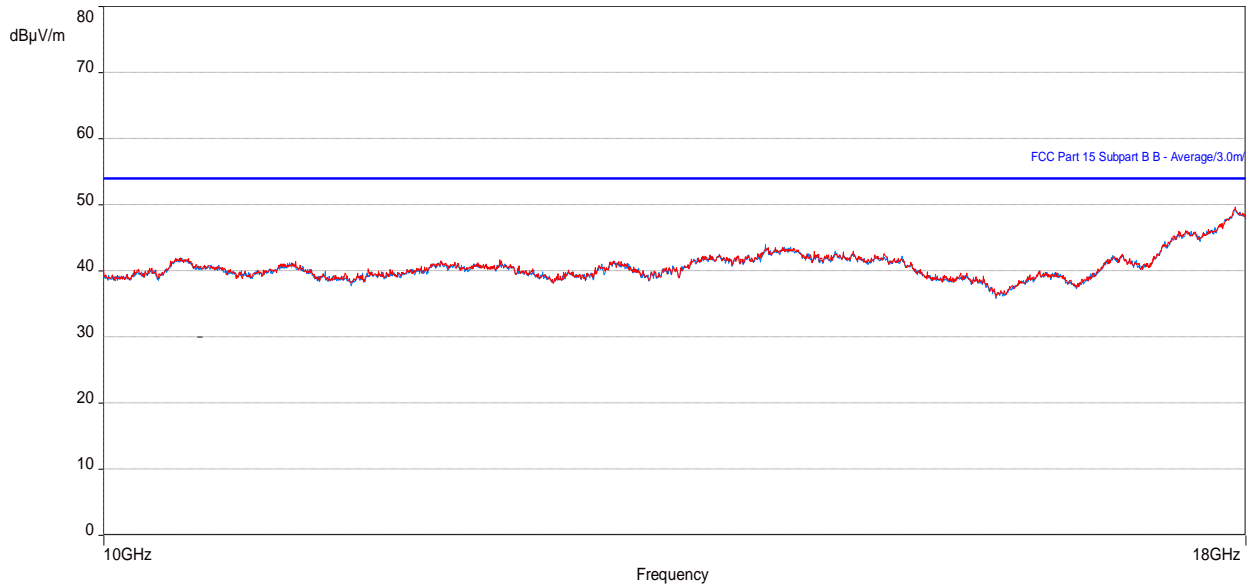

Table 69: RE test results from 10 to 18 GHz for FCC Part 15 (Config – MR2, Mid channel)

Frequency (MHz)	Level Average (dBµV/m)	Limit Average (dBµV/m)	Margin to FCC part 15 Class B (dB)	Height (m)	Azimuth (degrees)	Polarization	Correction (dB)
17897.70995	46.67	53.96	-7.29	4.00	0.00	Horizontal	20.40
17916.54582	46.42	53.96	-7.54	1.00	2.50	Vertical	20.33

Table 70: RE test results from 10 to 18 GHz for Part 24/27 (Config – MR2, Mid channel)

Frequency (MHz)	Level (dBµV/m)	EIRP Limit (dBµV/m)	Margin to (dB)	Height (m)	Azimuth (degrees)	Polarization	Correction (dB)
17897.70995	46.67	82.2	-35.53	4.00	0.00	Horizontal	20.40
17916.54582	46.42	82.2	-35.78	1.00	2.50	Vertical	20.33

Note: In the table/Plot above, no emissions exceed the Part 24/Part 27 radiated spurious emissions limit when converted to dBuV/m. For final spurious emissions measurements to FCC Part 24/Part 27, see antenna port conducted emissions in applicable test report.

Figure 52: Plot of RE at 1m from 18 to 26.5 GHz (Config – MR2, Mid channel)

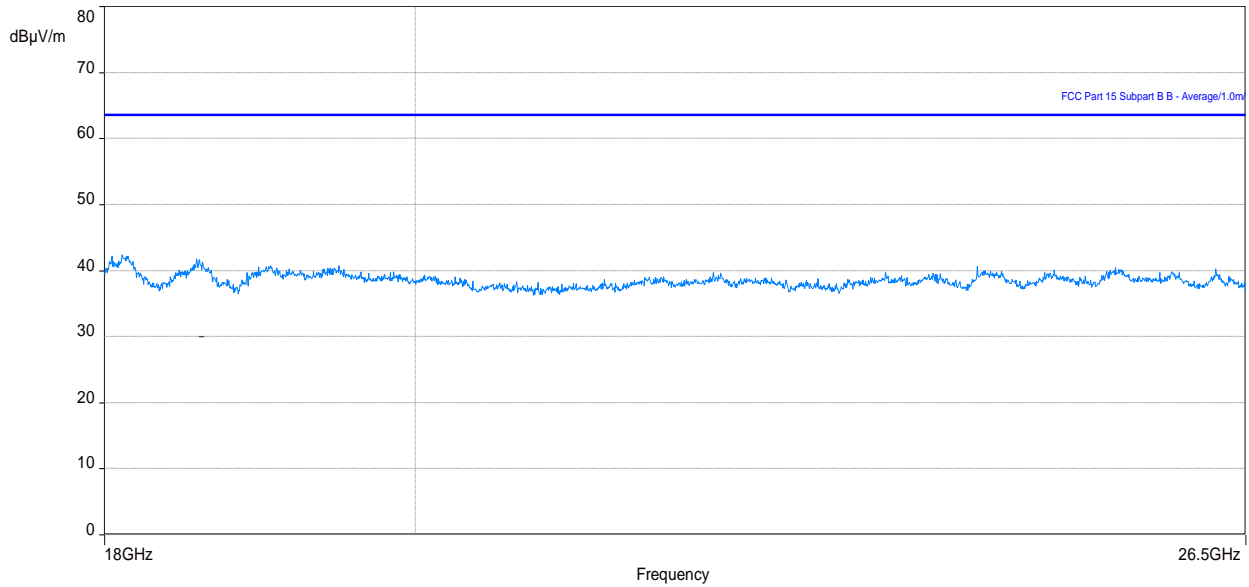

Note 1: In the plot above No Emissions exceeds the FCC Part 15/ICES 003 limit.

Note 2: In the plot above, no emissions exceed the Part 24/27 radiated spurious emissions limit when converted to dBuV/m. For final spurious emissions measurements to FCC Part 24/27, see antenna port conducted emissions in applicable test report.

3.2.12 Radiated Emissions test setup pictures

Figure 53: EUT Setup for RE tests (Closeup)



Figure 54: EUT Setup for RE tests at 30 MHz to 1 GHz



Figure 55: EUT Setup for RE tests for above 1 GHz

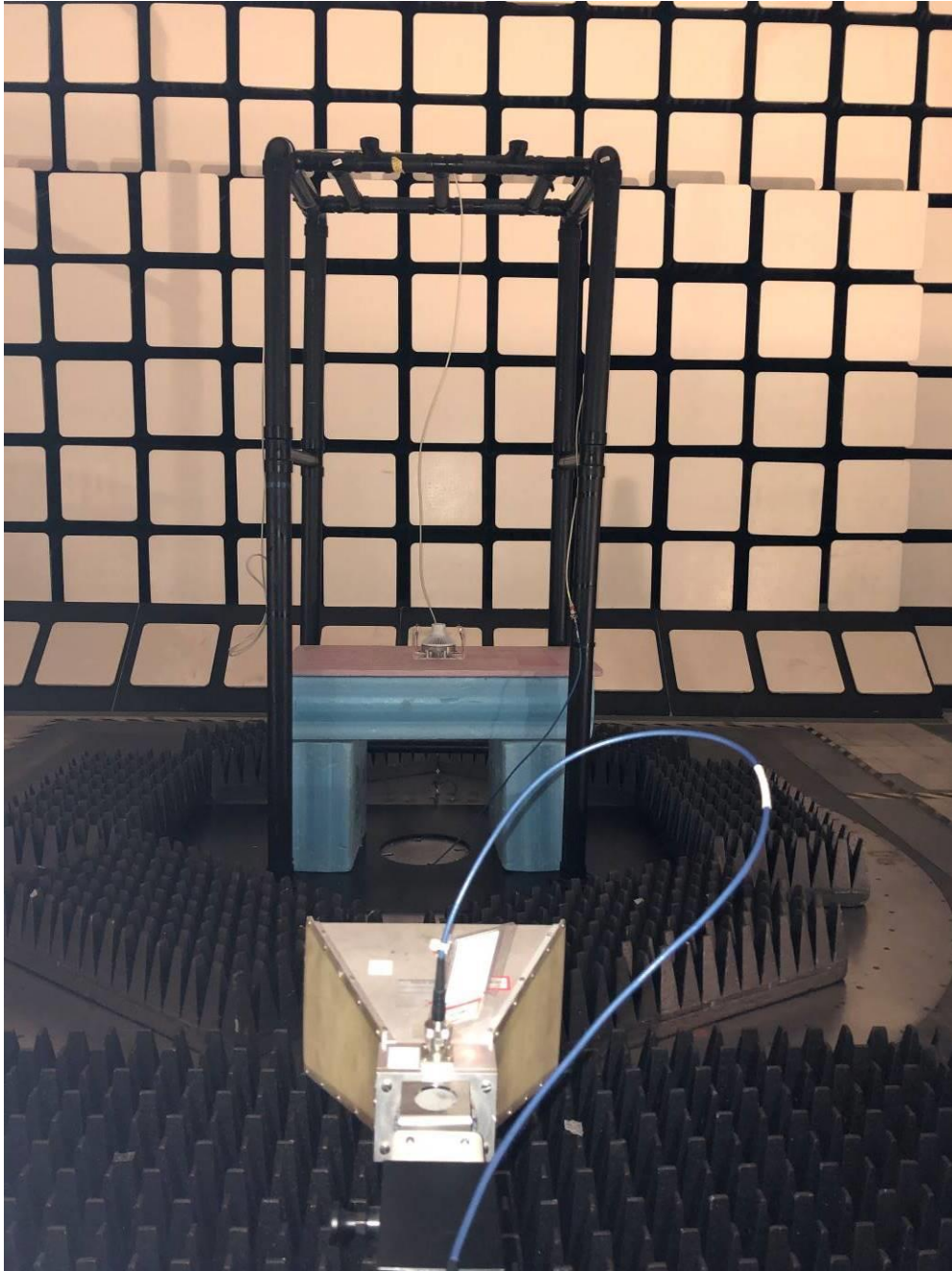

3.2.13 Test equipment

The equipment used for E-field RE testing was as follows.

Table 71: Test equipment used for RE

Description	Make	Model number	Asset ID	Calibr. date	Calibr. due
EMC Automation Software	Nexio V3.18	BAT-EMC	F0163649	Not required	
EMI Receiver	Rohde & Schwarz	ESU26	SSG013729	2020-03-19	2021-03-19
Coaxial Cable	Huber & Suhner	104PEA	SSG012041	2021-01-05	2022-01-05
Coaxial Cable	Huber & Suhner	106A	SSG012455	2021-01-05	2022-01-05
Pre-Amplifier	Hp	8447D	LAVE04346	2020-09-10	2021-09-10
Coaxial Cable	Huber & Suhner	106A	SSG012711	2021-01-05	2022-01-05
Bilog Antenna	Teseq	6111D	SSG013955	2019-12-03	2021-03-03
EMI Receiver	Rohde & Schwarz	ESU40	SSG013672	2020-10-29	2021-10-29
Coaxial Cable	Micro-Coax	UFA 210B-1-1500-504504	SSG012376	2021-01-06	2022-01-06
Pre-Amplifier	BNR	LNA	SSG012360	2020-11-16	2021-11-16
Double Ridged Horn Antenna	Emco	3115	SSG012508	2020-05-11	2021-05-11
Coaxial Cable	Huber & Suhner	ST18/Nm/Nm/36	SSG012785	2021-01-06	2022-01-06
RF Filter: High Pass	Microwave Circuits inc.	H3G02G1	SSG012728	2021-01-06	2022-01-06
Attenuator	Narda	N/A	SSG013687	2021-01-06	2022-01-06
Attenuator 10dB	Weinschel	6071	SSG013009	2021-01-06	2022-01-06
Horn Antenna (18 - 26.5 GHz)	Emco	3160-09	SSG012292	2019-08-26	2021-08-26
Horn Antenna (26.5 - 40 GHz)	Emco	3160-10	SSG012294	2019-08-26	2021-08-26
Coaxial Cable	Huber & Suhner	101 PEA, Sucoflex	SSG012290	2020-11-04	2022-11-04

3.2.14 Test conclusion

The RD 4442 B25B66A has passed the E-field Radiated Emission (RE) tests with respect to the standards/sections listed in section [Executive summary](#).

4. References

The documents, regulations, and standards that are referenced throughout this test report are listed alphabetically as follows.

1. ANSI C63.2-2009, American National Standards Institute for Electromagnetic Noise and Field Strength Instrumentation, 10 Hz to 40 GHz – Specifications.
2. ANSI C63.4-2014, American National Standards Institute for Methods of Measurement of Radio-Noise Emission from Low-Voltage Electrical and Electronic Equipment in the Range of 9 kHz to 40 GHz.
3. CISPR 16 Publications (all parts and sections), Specification for Radio Disturbance and Immunity Measuring Apparatus and Methods - Part 1: Radio Disturbance and Immunity Measuring Apparatus.
4. CISPR 22 (2008, +IS 1, + IS 2, + IS 3: 2012), Information technology equipment - Radio disturbance characteristics - Limits and methods of measurement.
5. FCC Rules for Radio Frequency Devices, Title 47 of the Code of Federal Regulations, Part 2, U.S. Federal Communications Commission.
6. FCC Rules for Radio Frequency Devices, Title 47 of the Code of Federal Regulations, Part 15 Radio Frequency Devices, U.S. Federal Communications Commission.
7. FCC Rules for Radio Frequency Devices, Title 47 of the Code of Federal Regulations, Part 24 – PERSONAL COMMUNICATIONS SERVICES, U.S. Federal Communications Commission.
8. FCC Rules for Radio Frequency Devices, Title 47 of the Code of Federal Regulations, Part 27 Miscellaneous Wireless Communications Services, U.S. Federal Communications Commission.
9. ICES-003 Issue 6 (2016), Spectrum Management and Telecommunications, Interference-Causing Equipment Standard: Information Technology Equipment (ITE) – Limits and methods of measurement.
10. Radio Standards Specification RSS-133, issue 6 (January 2018), 2 GHz Personal Communication Services, Ministry of Industry, Government of Canada.
11. Radio Standards Specification RSS-139, issue 3 (July 2015), Advanced Wireless Services (AWS) Equipment Operating in the Bands 1710 - 1780 MHz and 2110-2180 MHz. Ministry of Industry, Government of Canada.
12. RSS-Gen – General Requirements for Compliance of Radio Apparatus, Issue 5 (March 2019); Ministry of Industry, Government of Canada.

4.1 Appendix A: Abbreviations

The abbreviations of terms used in this document are as follows.

Term	Definition
A	6 dB Coaxial Attenuator (Conducted Immunity)
AAN	Asymmetric Artificial Network (ISN)
AE	Auxiliary equipment
AFC	Ambient Free Chamber
ANSI	American National Standards Institute
AVG	Average detector
BiLog	Biconical Log-Periodic Hybrid antenna (a registered trademark of Schaffner-Chase EMC Limited, 1993)
CDN	Coupling-decoupling Network
CE	Conducted Emissions
CISPR	Comité International Spécial Perturbation Radioélectrique (International Special Committee on Radio Interference)
CSA	Canadian Standards Association
DN/P	Decoupling / Protection Network
EMC	Electromagnetic Compatibility
EMI	Electromagnetic Interference
EUT	equipment under test
GND	Ground
HCP	Horizontal Coupling Plane
HME	Harmonics Measurement Equipment
HV	High Voltage
HVP	High Voltage Probe
h/w	hardware
IC	Industry Canada
ICES	Canadian Specification: ICES-003, Issue 3, "Spectrum Management: Interference-causing equipment standard (Digital Apparatus)
IEC	International Electro Technical Association
ISN	Impedance Stabilization Network
ms	millisecond, unless otherwise specified
NA, na	not applicable
PA	Broadband Power Amplifier
PK	Peak Detector



Term	Definition
PS	Power Supply
QP	Quasi-peak Detector
QPA	Quasi-peak Adapter (for the Spectrum Analyzer)
R	100-ohm Injection Resistor (Conducted Immunity)
RBW	Resolution Bandwidth
RE	Radiated Emissions
RF	Radio-Frequency
s/w	software
SA	Spectrum Analyzer, the CISPR 16, ANSI C63.2 Compliant EMI meter
STP	Shielded Twisted Pair
T	50-ohm Coaxial Termination (Conducted Emissions / Immunity)
TL	Transient Limiter
UFA	Uniform field Area
VBW	Video Bandwidth



TÜV SÜD Canada Inc

EMC Test Report

End of Document