



Add value.
Inspire trust.

Report On

FCC and ISED Testing of the Ericsson Remote Radio Unit LTE + NB-IoT, NR, NR + LTE, WCDMA + LTE NB-IoT RD 4442 B25B66A, KRY 901 386/1 and RD 2243 B25, KRY 901 402/1 (1900 MHz), with compatible Main Unit in a Base Station configuration in accordance with in accordance with FCC CFR 47 Part 2, FCC CFR 47 Part 24, ISED RSS-GEN and Industry Canada RSS-133

COMMERCIAL-IN-CONFIDENCE

FCC ID: TA8AKRY901386-1

IC: 287AB-AS9013861

FCC ID: TA8AKRY901402-1

IC: 287AB-AS9014021

PREPARED BY

A handwritten signature in black ink, appearing to read 'G. Atchells', positioned above a horizontal line.

APPROVED BY

A handwritten signature in black ink, appearing to read 'S. Drysdale', positioned above a horizontal line.

DATED

Mar. 15th 2021

Authorised Signatory

Document 7169009108.1 Report 01 Issue 1

March 2021



CONTENTS

Section	Page No
1	REPORT INFORMATION 2
1.1	Report Details 3
1.2	Brief Summary of Results 4
1.3	Configuration Description 5
1.4	Declaration of Build Status 6
1.5	Product Information 8
1.6	Test Setup 9
1.7	Test Conditions 10
1.8	Deviation From The Standard 10
1.9	Modification Record 10
1.10	Additional Information 10
2	TEST DETAILS 11
2.1	Maximum Peak Output Power and Peak to Average Ratio - Conducted 12
2.2	Occupied Bandwidth 53
2.3	Band Edge 54
2.4	Transceiver Spurious Emissions 68
3	TEST EQUIPMENT USED 82
3.1	Test Equipment Used 83
3.2	Measurement Uncertainty 84
4	ACCREDITATION, DISCLAIMERS AND COPYRIGHT 85
4.1	Accreditation, Disclaimers and Copyright 86
4.2	Module List 87



SECTION 1

REPORT INFORMATION



1.1 REPORT DETAILS

Manufacturer	Ericsson
Address	349 Terry Fox Drive Ottawa Ontario K2K 2V6 Canada
Product Name & Product Number	RD 4442 B25B66A
IC Model Name	KRY 901 386/1
Serial Number(s)	TD3T308261 (for RD 4442 B25B66A)
Software Version	R79JC
Hardware Version	RIB
Test Specification/Issue/Date	FCC CFR 47 Part 2: 2019 FCC CFR 47 Part 24: 2019 ISED RSS-GEN: Issue 5 March 2019 Amendment 1 Industry Canada RSS-133: Issue 6: January 2018 Amendment 1
Test Plan	RD 4442 B25B66A_RA_testplan_NR_LTE(NBIOT)_WCDMA_Revised
Start of Test	28 January 2021
Finish of Test	29 January 2021
Name of Engineer(s)	Glen Westwell
Related Document(s)	KDB 971168 D01 v02r02 KDB 662911 D01 v02r01

ENGINEERING STATEMENT

The measurements shown in this report were made in accordance with the procedures described on test pages. All reported testing was carried out on a sample equipment to demonstrate compliance with FCC CFR 47 Part 2: 2019, FCC CFR 47 Part 24: 2019, ISED RSS-GEN: Issue 5 March 2019 Amendment 1, Industry Canada RSS-133: Issue 6: January 2018 Amendment 1. The sample tested was found to comply with the requirements defined in the applied rules.

Test Engineer(s);

Glen Westwell



1.2 BRIEF SUMMARY OF RESULTS

A brief summary of results for each configuration, in accordance with FCC CFR 47 Part 2, FCC CFR 47 Part 24, ISED RSS-GEN and Industry Canada RSS-133 is shown below.

Section	Specification Clause				Test Description	Result
	FCC CFR 47 Part 2	FCC CFR 47 Part 24	RSS-GEN	RSS-133		
2.1	2.1046	24.232	-	6.4	Maximum Peak Output Power and Peak to Average Ratio - Conducted	Pass
2.2	2.1049	24.238 (b)	6.7	6.5	Occupied Bandwidth	Pass
2.3	2.1051	24.238 (b)	-	6.5	Band Edge	Pass
2.4	2.1051	24.238 (a)	6.13 / 7.4	6.5	Transceiver Spurious Emissions	Pass



1.3 CONFIGURATION DESCRIPTION

Configuration A					
RAT	NO. Of Carriers	Carrier Bandwidth	Carrier Frequency Configuration (MHz)		
			Bottom	Middle	Top
LTE	1	10 MHz	1935.0	1962.5	1990.0
		15 MHz	1937.5	1962.5	1987.5
		20 MHz	1940.0	1962.5	1985.0
NR	1	5 MHz	1932.5	1962.5	1992.5
		10 MHz	1935.0	1962.5	1990.0
		15 MHz	1937.5	1962.5	1987.5
		20 MHz	1940.0	1962.5	1985.0

Configuration B					
RAT	No. of Carriers	Carrier Bandwidth	Carrier Frequency Configuration (MHz)		
			Bottom	Middle	Top
LTE NR LTE+NR	6	5 MHz	1932.5+1937.5+1942.5+	1952.5+1957.5+1962.5+	1967.5+1972.5+1977.5
			1947.5+1952.5+1957.5	1967.5+1972.5+1977.5	1982.5+1987.5+1992.5
2LTE10 (NB-IoT) + 4WCDMA5	6	10+5 MHz	1935.0+1945.0+1950.0+	1947.5+1957.5+1965.0+	1960.0+1970.0+1977.5
			1952.5+1957.5+1960.0	1967.5+1972.5_1977.5	1982.5+1987.5+1992.5



1.4 DECLARATION OF BUILD STATUS

MAIN EUT	
MANUFACTURING DESCRIPTION	Radio Dot
MANUFACTURER	Ericsson
TYPE	Remote Radio Base Station
PART NUMBER	RD 4442 B25B66A: KRY 901 386/1 RD 2243 B25: KRY 901 402/1 RD 2243 B66A: KRY 901 404/1
SERIAL NUMBER	TD3T308261 (for RD 4442 B25B66A)
HARDWARE VERSION	R1B
SOFTWARE VERSION	R79JC
TRANSMITTER OPERATING RANGE	B25 1930 – 1995 MHz B66A 2110 – 2180 MHz
RECEIVER OPERATING RANGE	B25 1850 – 1915 MHz B66A 1710 – 1780 MHz
COUNTRY OF ORIGIN	China
INTERMEDIATE FREQUENCIES	DL: 110 – 150MHz, UL: 40 – 80MHz
EMISSION DESIGNATOR(S): (i.e. G1D, GXW)	WCDMA: 5M00F9W LTE: 5M00W7D, 10M0W7D, 15M0W7D, 20M0W7D NB IoT Guardband: 10M0W7D, 15M0W7D, 20M0W7D NR: 5M00F9W, 10M0F9W, 15M0F9W, 20M0F9W
MODULATION TYPES: (i.e. GMSK, QPSK)	WCDMA: QPSK, 16QAM, 64QAM LTE: QPSK, 16QAM, 64QAM, 256QAM NR: QPSK, 16QAM, 64QAM, 256QAM
HIGHEST INTERNALLY GENERATED FREQUENCY	2.2 GHz
OUTPUT POWER (W or dBm)	4x 0.05 W (17dBm)
Antenna Gain (max)	B25: 1.8dBi B66A: 2.9 dBi
FCC ID	Tested EUT: TA8AKRY901386-1 Non-tested variant: TA8AKRY901402-1 Non-tested variant: TA8AKRY901404-1
INDUSTRY CANADA ID	Tested EUT: 287AB-AS9013861 Non-tested variant: 287AB-AS9014021 Non-tested variant: 287AB-AS9014041
TECHNICAL DESCRIPTION (a brief description of the intended use and operation)	<p>The RD 4442 B25B66A (KRY 901 386/1) is a dual band Remote Radio Unit forming part of the Ericsson Radio Base Station (RBS) equipment. The RD provides radio access for mobile and fixed devices and is intended for the indoor environment. The radio operates over 4 Transmit ports in MRO; Single, Multi-Carrier, and MIMO transmission with a maximum rated RF Output of 0.050W per port over an operational temperature of 5°C to +40°C. The unit is designed to be ceiling mounted.</p> <p>The RD 2243 B25 product is a single band radio identical to the dual band RD 4442 B25B66A product except that B66A circuits have been de-populated.</p> <p>The RD 2243 B66A product is a single band radio identical to the dual band RD 4442 B25B66A product except that B25 circuits have been de-populated.</p>



Signature:

A handwritten signature in blue ink, appearing to be 'DL' or similar initials, written over a dotted line.

Denis Lalonde

Date: 17 March 2021

Declaration of Build Status Serial Number: TD3T308261

No responsibility will be accepted by TÜV SÜD UK Limited as to the accuracy of the information declared in this document by the manufacturer.

1.5 PRODUCT INFORMATION

1.5.1 Technical Description

The Equipment Under Test (EUT) RD 4442 B25B66A - KRY 901 386/1 is an Ericsson AB Radio Unit working in the public mobile service 1900 MHz band which provides communication connections to 1900 MHz network. The RD 4442 B25B66A - KRY 901 386/1 operates from a -48V DC supply.

The Equipment Under Test (EUT) is shown in the photograph below. A full technical description can be found in the Manufacturer's documentation.

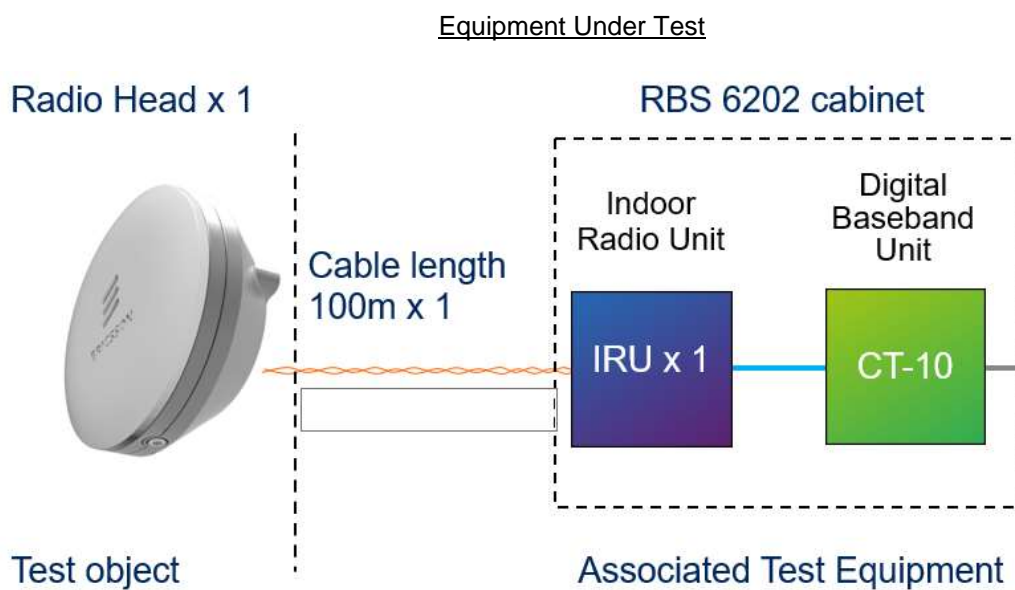



1.6 TEST SETUP

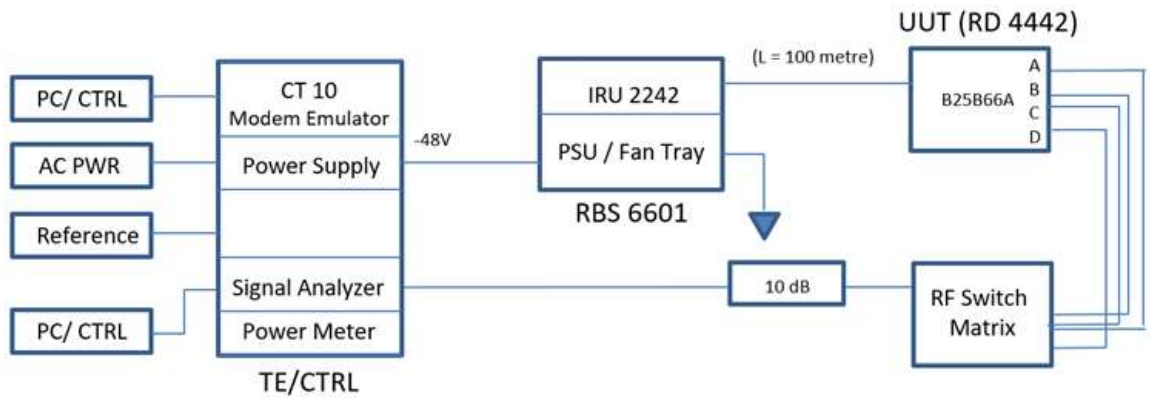



1.7 TEST CONDITIONS

For all tests the EUT was set up in accordance with the relevant test standard and to represent typical operating conditions. Tests were applied with the EUT situated as described in the Test Method for each Test.

The EUT was powered from a -48V DC supply.

FCC Measurement Facility Registration Number: CA4810

ISED Accreditation
ISED#24015, TÜV SÜD, Ottawa, Canada

Under our group A2LA Accreditation, TÜV SÜD conducted the following tests at the Ericsson facility in Ottawa.

Test Name	Name of Engineer(s)
Maximum Peak Output Power and Peak to Average Ratio - Conducted	Glen Westwell
Occupied Bandwidth	Glen Westwell
Band Edge	Glen Westwell
Transceiver Spurious Emissions	Glen Westwell
Frequency Stability	Glen Westwell

1.8 DEVIATION FROM THE STANDARD

No deviations from the applicable test standards or test plan were made during testing.

1.9 MODIFICATION RECORD

No modifications were made to the EUT during testing.

1.10 ADDITIONAL INFORMATION

1. This filing is for a Class 2 Permissive change to add NR and NB-IoT GB modulations to a previously certified Radio for use in the USA and Canada under the following ID's:

FCC ID: TA8AKRY901386-1 and TA8AKRY901402-1
ISED ID: 287AB-AS9013861 and 287AB-AS9014021

2. This device is electrically identical as originally certified as no hardware changes have been made.

3. Transmitter performance was measured for top, mid & bottom channels, where applicable, across both antenna ports as presented in the average power measurement tables. Maximum power performance was determined to be, antenna port A.

4. Frequency Stability has been verified at time of original certification.



SECTION 2

TEST DETAILS



2.1 MAXIMUM PEAK OUTPUT POWER AND PEAK TO AVERAGE RATIO - CONDUCTED

2.1.1 Specification Reference

FCC CFR 47 Part 24, Clause 24.232
Industry Canada RSS-133, Clause 6.4
FCC CFR 47 Part 2, Clause 2.1046

2.1.2 Date of Test and Modification State

29 January 2021 - Modification State 0

2.1.3 Test Equipment Used

The major items of test equipment used for the above tests are identified in Section 3.1.

2.1.4 Environmental Conditions

Ambient Temperature	25.0°C
Relative Humidity	23.2%

2.1.5 Test Method

All measurements were made in accordance with FCC KDB 971168 D01, clause 5.2.1 and summed in accordance with FCC KDB 662911 D01.

- The declared Maximum Antenna Gain to be used with this product, as Declared by the Manufacturer is 1.8 dBi. The EIRP is calculated as the sum of the measured power plus the antenna gain.



2.1.6 Test Results

Configuration A

Maximum Output Power 17/Port dBm

Antenna	Modulation	Carrier Bandwidth	Peak to Average Ratio (PAR) / Output Power			
			Channel Position B			
			PAR (dB)	Average Power		
dBm	EIRP (dBm)	EIRP dBm/MHz				
A	LTE: QPSK	10.0 MHz	8.05	16.50	18.30	10.15
B	LTE: QPSK	10.0 MHz	-	16.10	17.90	10.15
Total			-	19.31	21.11	13.16
A	LTE: QPSK	15.0 MHz	8.18	16.48	18.28	8.34
B	LTE: QPSK	15.0 MHz	-	16.43	18.23	8.34
Total			-	19.47	21.27	11.35
A	LTE: QPSK	20.0 MHz	8.16	16.47	18.27	7.18
B	LTE: QPSK	20.0 MHz	-	16.43	18.23	7.18
Total			-	19.46	21.26	10.19
A	NR: QPSK	5.0 MHz	7.46	16.29	18.09	12.24
B	NR: QPSK	5.0 MHz	-	16.35	18.15	12.24
Total			-	19.33	21.13	15.25
A	NR: QPSK	10.0 MHz	7.75	16.61	18.41	9.63
B	NR: QPSK	10.0 MHz	-	16.35	18.15	9.63
Total			-	19.49	21.29	12.64
A	NR: QPSK	15.0 MHz	8.22	16.51	18.31	8.24
B	NR: QPSK	15.0 MHz	-	16.30	18.10	8.24
Total			-	19.42	21.22	12.64
A	NR: QPSK	20.0 MHz	8.17	16.49	18.29	7.04
B	NR: QPSK	20.0 MHz	-	16.46	18.26	7.05
Total			-	19.49	21.29	10.05

Remarks

1. Transmitter performance was measured for top, mid, bottom channels across both antenna ports as represented in the average power measurement tables. Maximum power performance was determined to be antenna port A.
2. The plot results presented represent typical performance for all bands and antenna ports based on transmitter port A performance.
3. Plot data performance are on file and available on request.
4. An NB-IoT GB carrier is included in the 10MHz LTE RAT for evaluation as part of this submission.
5. The antenna gain for the B25 frequencies of DOT 4442 B25B66A is 1.8 dBi.



Antenna Port A Carrier Power - Modulation LTE: QPSK - Carrier Bandwidth 10.0 MHz - Channel Position B



Antenna Port A Pk-Av Ratio - Modulation LTE: QPSK - Carrier Bandwidth 10.0 MHz - Channel Position B

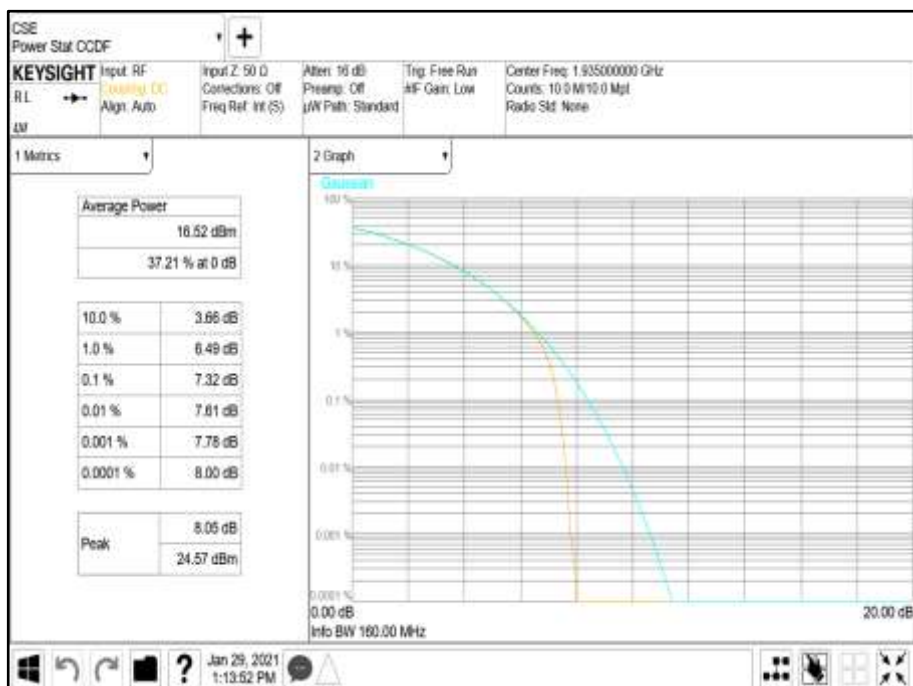



Antenna Port A PSD - Modulation LTE: QPSK - Carrier Bandwidth 10.0 MHz - Channel Position B



Antenna Port A Carrier Power - Modulation LTE: QPSK - Carrier Bandwidth 15.0 MHz - Channel Position B





Antenna Port A Pk-Av Ratio - Modulation LTE: QPSK - Carrier Bandwidth 15.0 MHz - Channel Position B

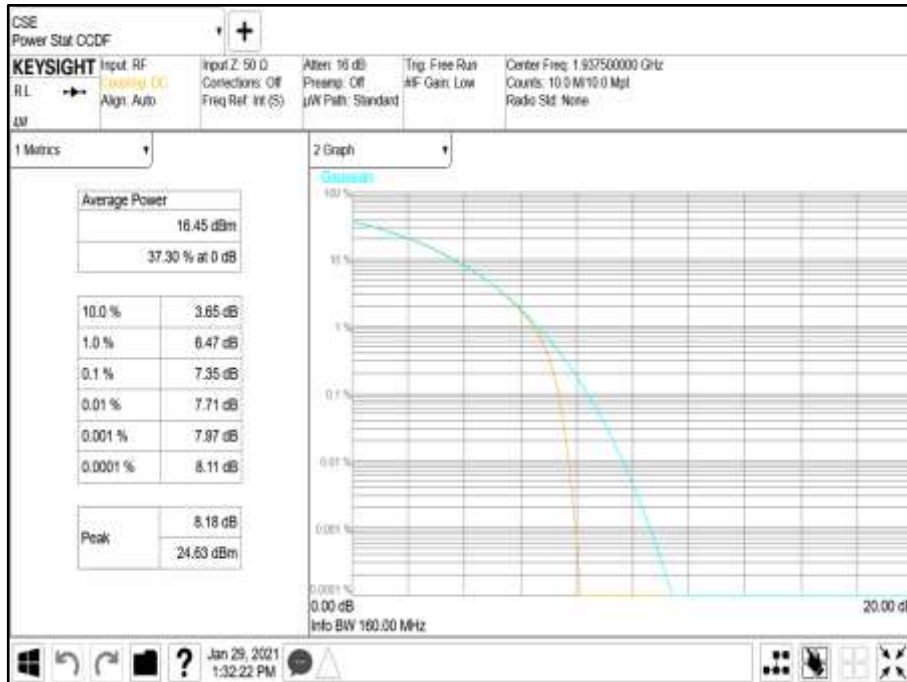

Antenna Port A PSD - Modulation LTE: QPSK - Carrier Bandwidth 15.0 MHz - Channel Position B





Antenna Port A Carrier Power - Modulation LTE: QPSK - Carrier Bandwidth 20.0 MHz - Channel Position B



Antenna Port A Pk-Av Ratio - Modulation LTE: QPSK - Carrier Bandwidth 20.0 MHz - Channel Position B

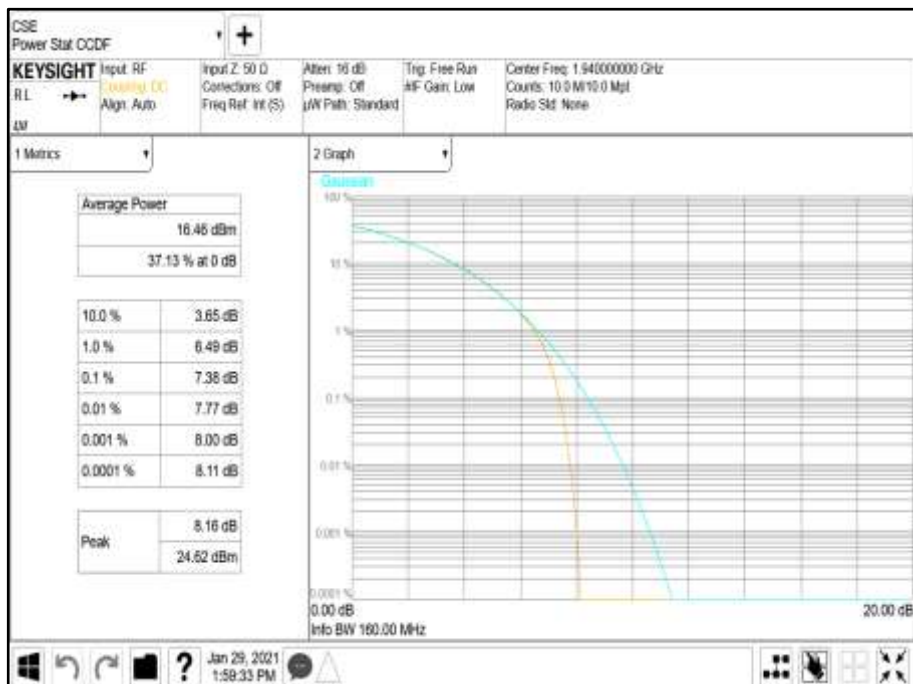



Antenna Port A PSD - Modulation LTE: QPSK - Carrier Bandwidth 20.0 MHz - Channel Position B



Antenna Port A Carrier Power - Modulation NR: QPSK - Carrier Bandwidth 5.0 MHz - Channel Position B





Antenna Port A Pk-Av Ratio - Modulation NR: QPSK - Carrier Bandwidth 5.0 MHz - Channel Position B

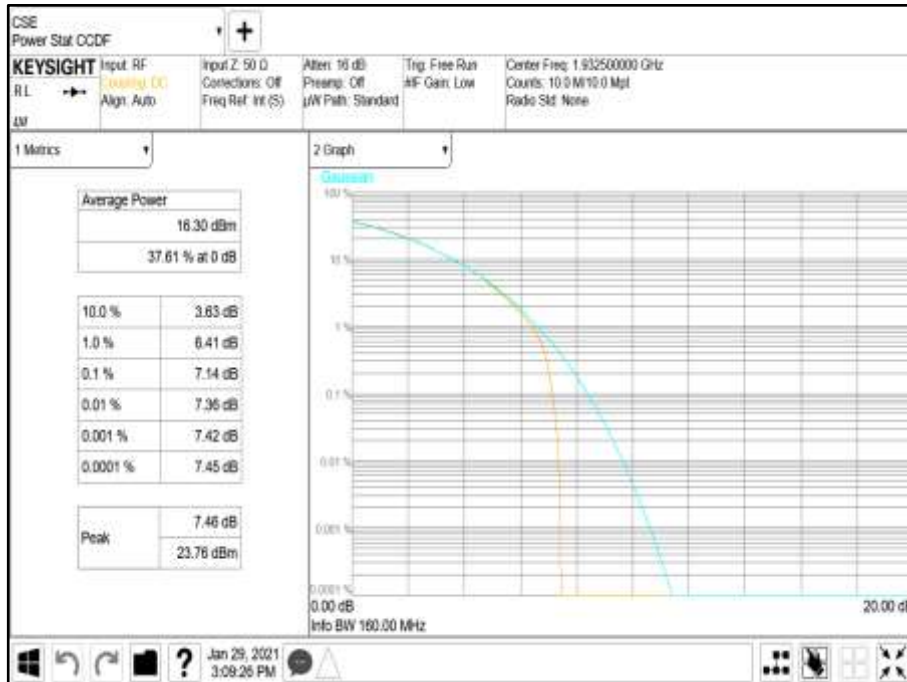

Antenna Port A PSD - Modulation NR: QPSK - Carrier Bandwidth 5.0 MHz - Channel Position B

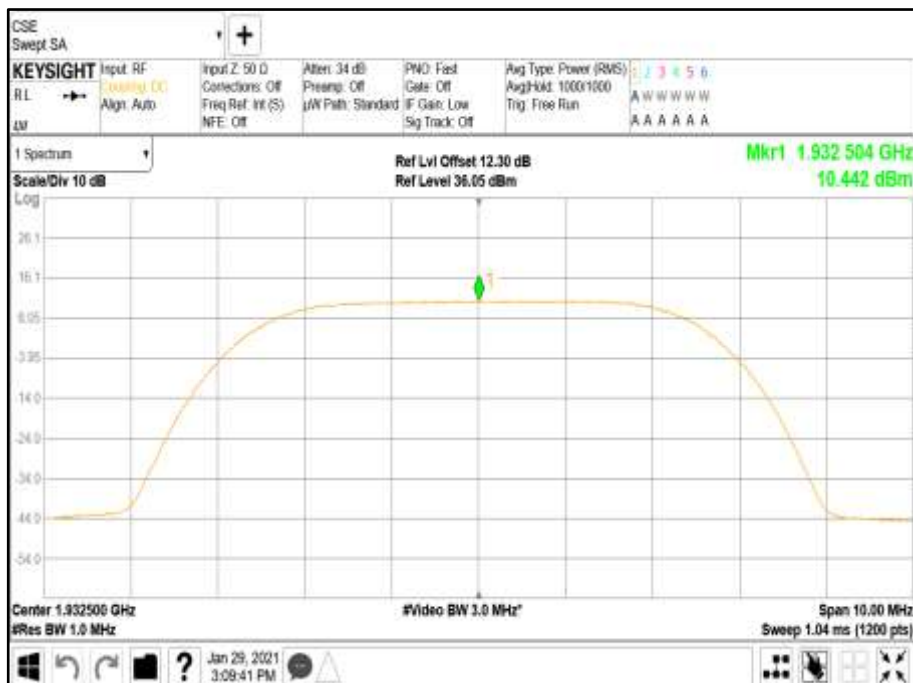



Antenna Port A Carrier Power - Modulation NR: QPSK - Carrier Bandwidth 10.0 MHz - Channel Position B



Antenna Port A Pk-Av Ratio - Modulation NR: QPSK - Carrier Bandwidth 10.0 MHz - Channel Position B

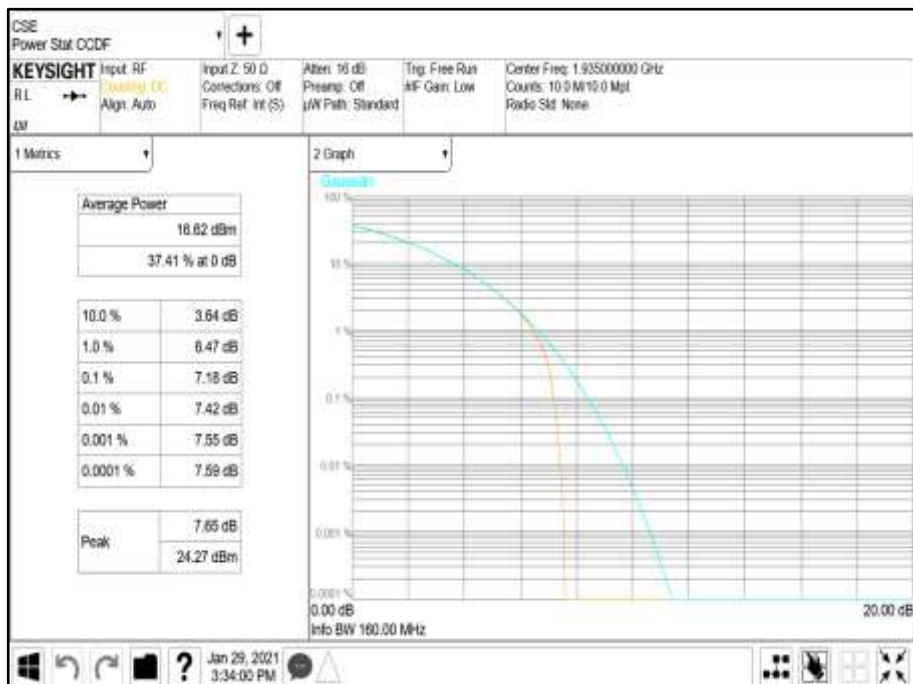



Antenna Port A PSD - Modulation NR: QPSK - Carrier Bandwidth 10.0 MHz - Channel Position B



Antenna Port A Carrier Power - Modulation NR: QPSK - Carrier Bandwidth 15.0 MHz - Channel Position B





Antenna Port A Pk-Av Ratio - Modulation NR: QPSK - Carrier Bandwidth 15.0 MHz - Channel Position B

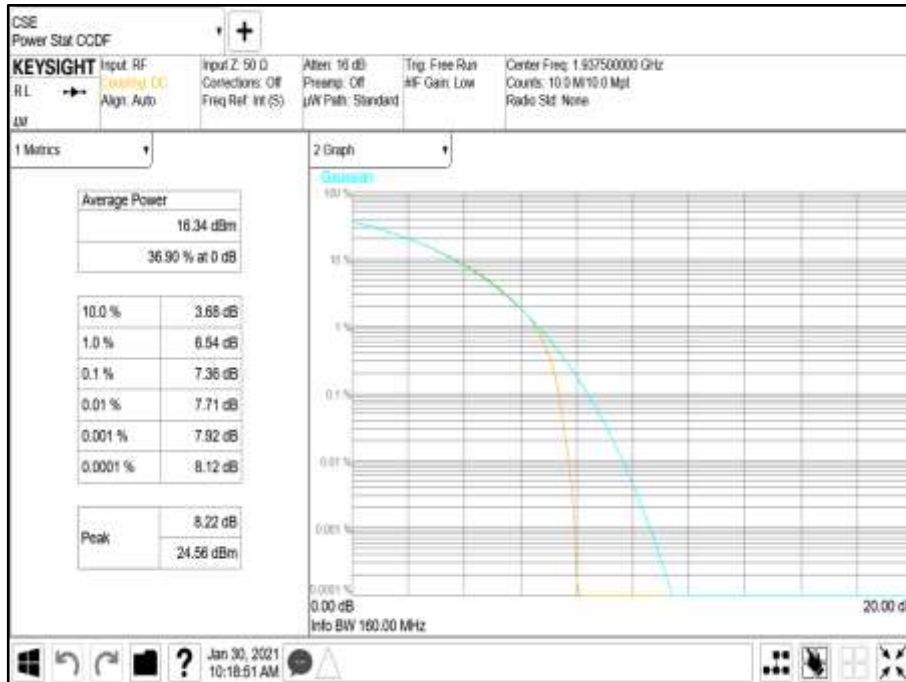

Antenna Port A PSD - Modulation NR: QPSK - Carrier Bandwidth 15.0 MHz - Channel Position B





Antenna Port A Carrier Power - Modulation NR: QPSK - Carrier Bandwidth 20.0 MHz - Channel Position B



Antenna Port A Pk-Av Ratio - Modulation NR: QPSK - Carrier Bandwidth 20.0 MHz - Channel Position B

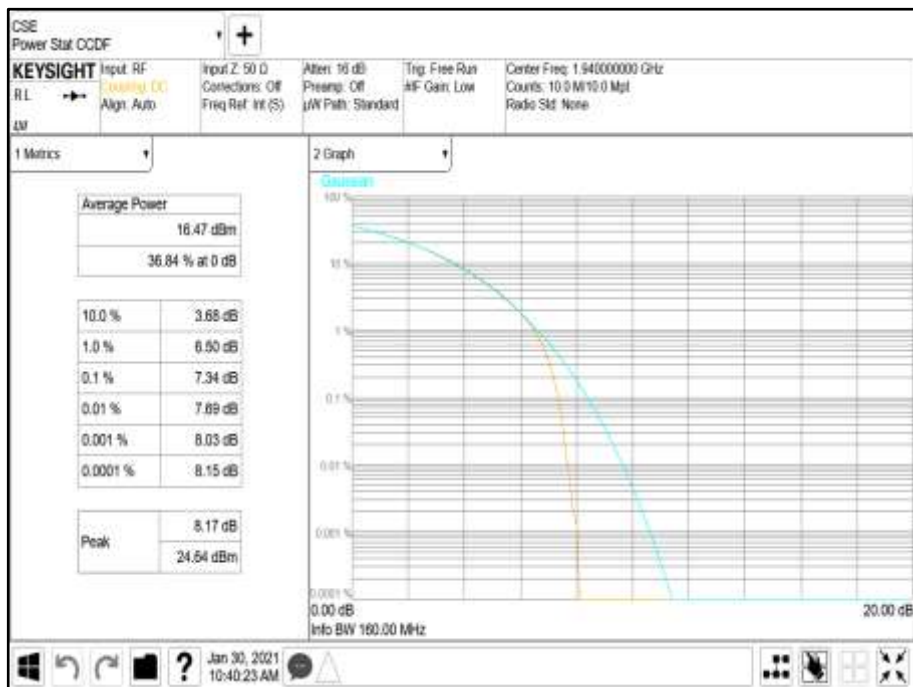



Antenna Port A PSD - Modulation NR: QPSK - Carrier Bandwidth 20.0 MHz - Channel Position B





Configuration A

Maximum Output Power 17/Port dBm

Antenna	Modulation	Carrier Bandwidth	Peak to Average Ratio (PAR) / Output Power			
			Channel Position M			
			PAR (dB)	Average Power		
dBm	EIRP (dBm)	EIRP dBm/MHz				
A	LTE: QPSK	10.0 MHz	7.70	16.10	17.90	8.93
B	LTE: QPSK	10.0 MHz	-	16.25	18.05	8.93
Total			-	19.19	20.99	11.94
A	LTE: QPSK	15.0 MHz	7.86	16.27	18.07	8.06
B	LTE: QPSK	15.0 MHz	-	16.41	18.21	8.06
Total			-	19.35	21.15	11.07
A	LTE: QPSK	20.0 MHz	7.70	16.31	18.11	6.5
B	LTE: QPSK	20.0 MHz	-	16.26	18.06	6.5
Total			-	19.30	21.10	9.51
A	NR: QPSK	5.0 MHz	7.53	16.20	18.00	12.09
B	NR: QPSK	5.0 MHz	-	16.29	18.09	12.09
Total			-	19.26	21.06	15.1
A	NR: QPSK	10.0 MHz	7.57	16.63	18.43	9.27
B	NR: QPSK	10.0 MHz	-	16.49	18.29	9.27
Total			-	19.57	21.37	12.28
A	NR: QPSK	15.0 MHz	7.66	16.37	18.17	7.42
B	NR: QPSK	15.0 MHz	-	16.22	18.02	7.42
Total			-	19.31	21.11	10.43
A	NR: QPSK	20.0 MHz	7.67	16.34	18.14	6.23
B	NR: QPSK	20.0 MHz	-	16.27	18.07	6.23
Total			-	19.32	21.12	9.24



Antenna Port A Carrier Power - Modulation LTE: QPSK - Carrier Bandwidth 10.0 MHz - Channel Position M



Antenna Port A Pk-Av Ratio - Modulation LTE: QPSK - Carrier Bandwidth 10.0 MHz - Channel Position M

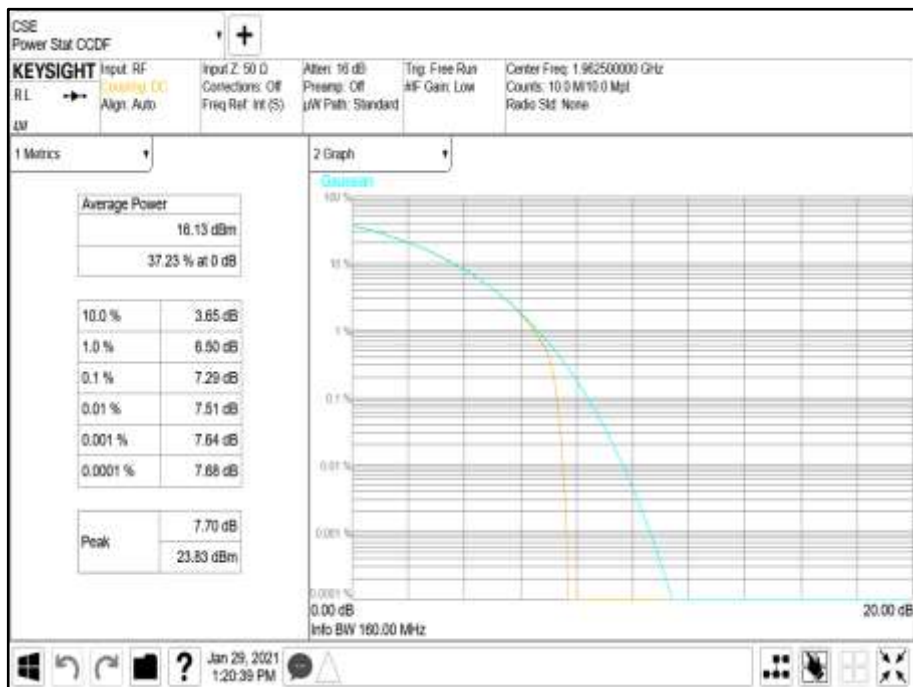



Antenna Port A PSD - Modulation LTE: QPSK - Carrier Bandwidth 10.0 MHz - Channel Position M



Antenna Port A Carrier Power - Modulation LTE: QPSK - Carrier Bandwidth 15.0 MHz - Channel Position M

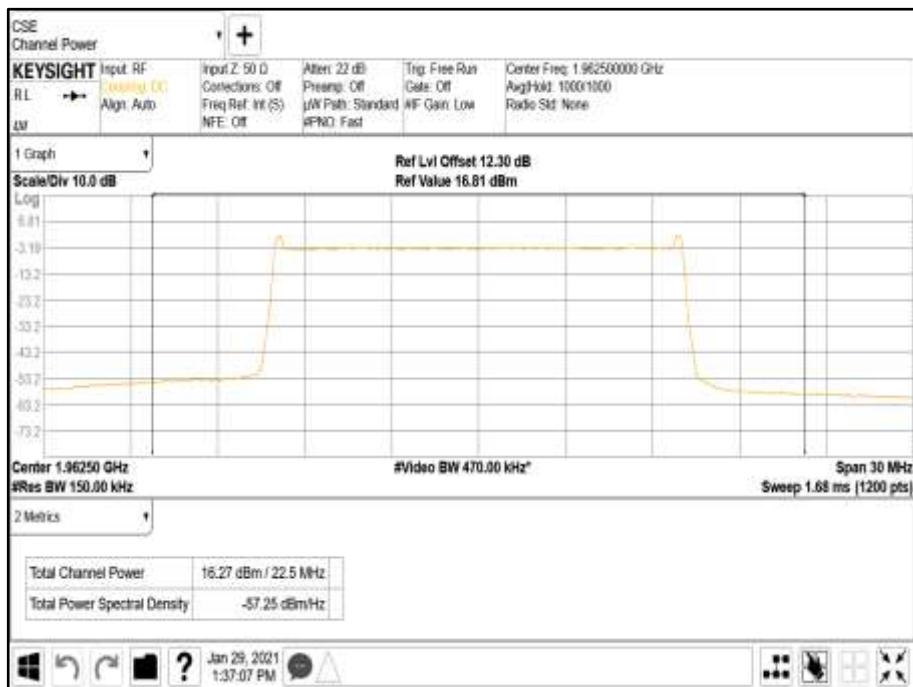



Antenna Port A Pk-Av Ratio - Modulation LTE: QPSK - Carrier Bandwidth 15.0 MHz - Channel Position M

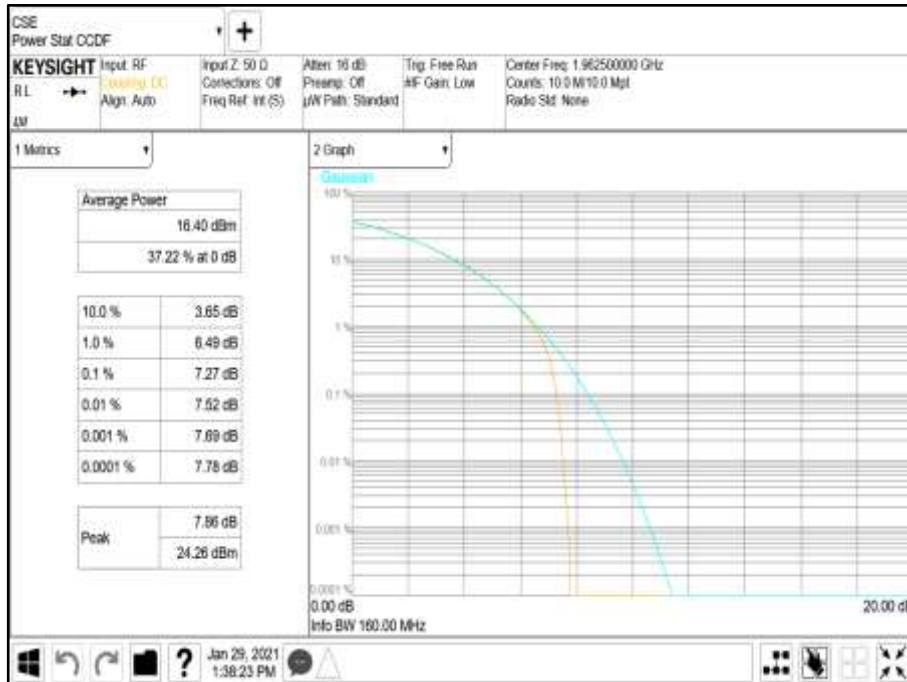

Antenna Port A PSD - Modulation LTE: QPSK - Carrier Bandwidth 15.0 MHz - Channel Position M





Antenna Port A Carrier Power - Modulation LTE: QPSK - Carrier Bandwidth 20.0 MHz - Channel Position M



Antenna Port A Pk-Av Ratio - Modulation LTE: QPSK - Carrier Bandwidth 20.0 MHz - Channel Position M

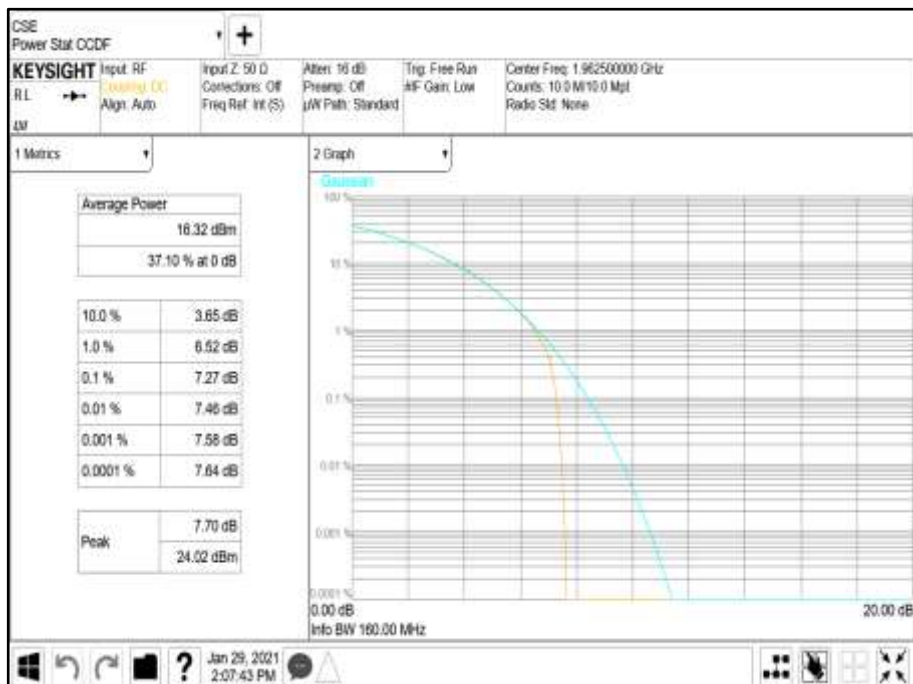



Antenna Port A PSD - Modulation LTE: QPSK - Carrier Bandwidth 20.0 MHz - Channel Position M



Antenna Port A Carrier Power - Modulation NR: QPSK - Carrier Bandwidth 5.0 MHz - Channel Position M





Antenna Port A Pk-Av Ratio - Modulation NR: QPSK - Carrier Bandwidth 5.0 MHz - Channel Position M

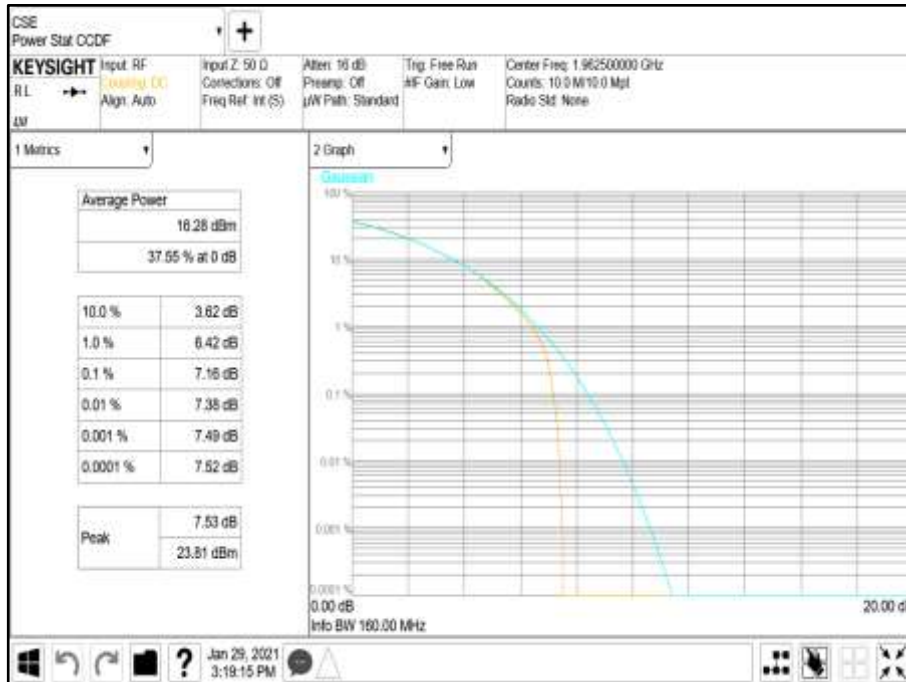

Antenna Port A PSD - Modulation NR: QPSK - Carrier Bandwidth 5.0 MHz - Channel Position M

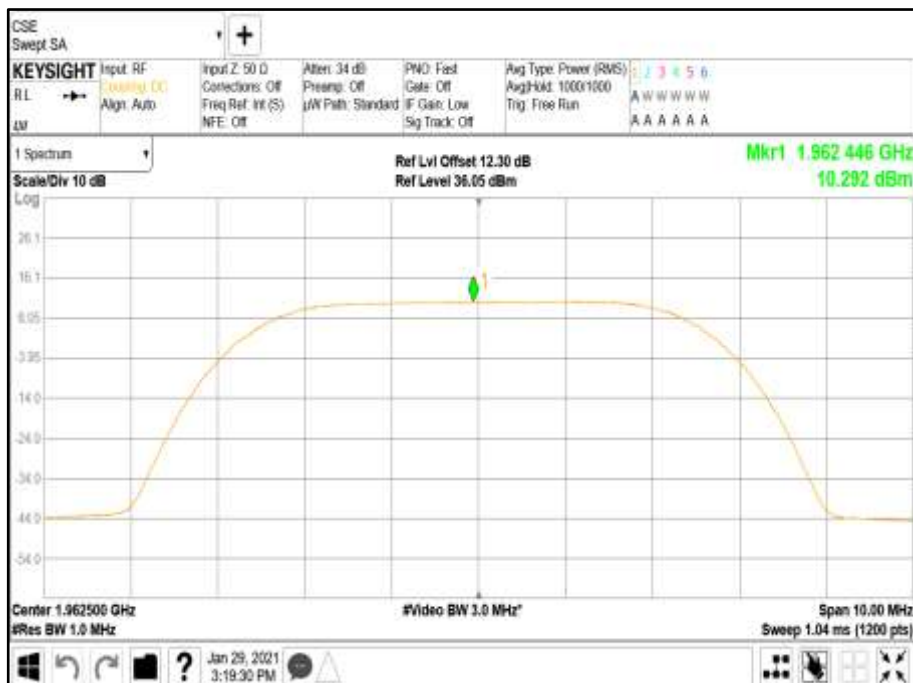



Antenna Port A Carrier Power - Modulation NR: QPSK - Carrier Bandwidth 10.0 MHz - Channel Position M



Antenna Port A Pk-Av Ratio - Modulation NR: QPSK - Carrier Bandwidth 10.0 MHz - Channel Position M

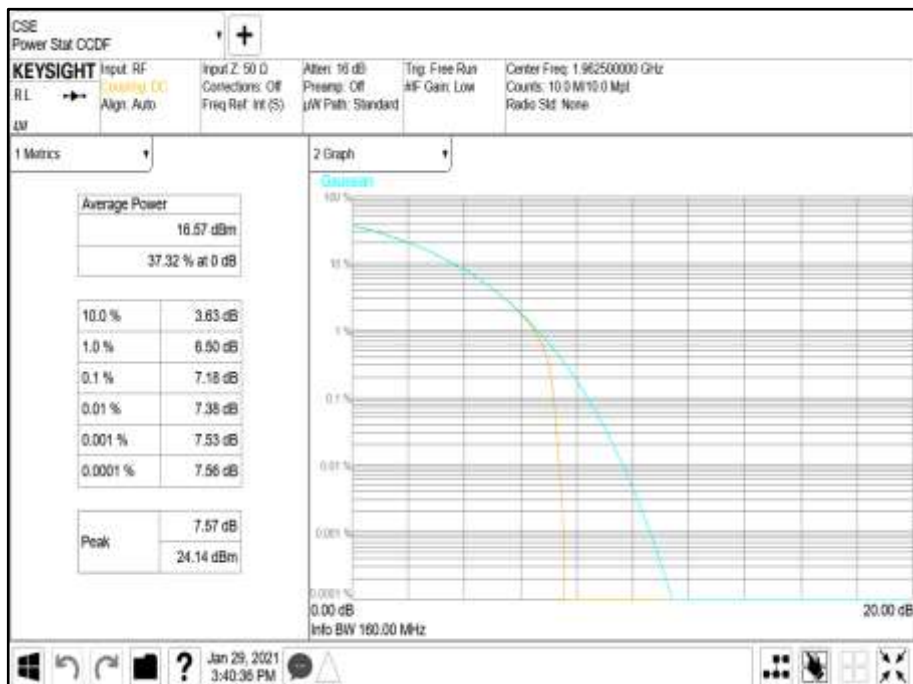



Antenna Port A PSD - Modulation NR: QPSK - Carrier Bandwidth 10.0 MHz - Channel Position M



Antenna Port A Carrier Power - Modulation NR: QPSK - Carrier Bandwidth 15.0 MHz - Channel Position M





Antenna Port A Pk-Av Ratio - Modulation NR: QPSK - Carrier Bandwidth 15.0 MHz - Channel Position M



Antenna Port A PSD - Modulation NR: QPSK - Carrier Bandwidth 15.0 MHz - Channel Position M





Antenna Port A Carrier Power - Modulation NR: QPSK - Carrier Bandwidth 20.0 MHz - Channel Position M



Antenna Port A Pk-Av Ratio - Modulation NR: QPSK - Carrier Bandwidth 20.0 MHz - Channel Position M

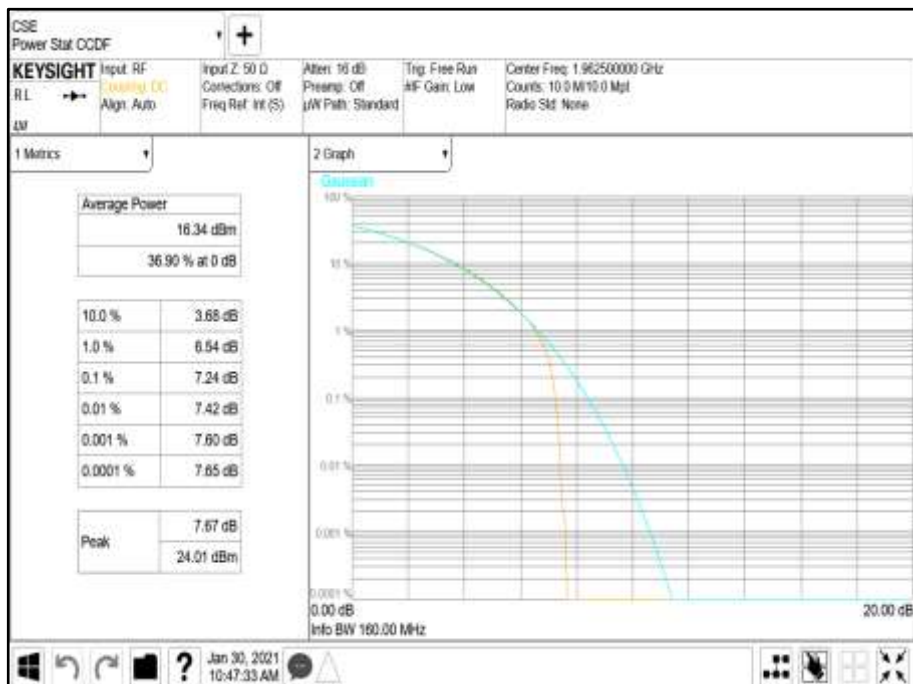



Antenna Port A PSD - Modulation NR: QPSK - Carrier Bandwidth 20.0 MHz - Channel Position M





Configuration A

Maximum Output Power 17/Port dBm

Antenna	Modulation	Carrier Bandwidth	Peak to Average Ratio (PAR) / Output Power			
			Channel Position T			
			PAR (dB)	Average Power		
dBm	EIRP (dBm)	EIRP dBm/MHz				
A	LTE: QPSK	10.0 MHz	8.05	16.27	18.07	9.3
B	LTE: QPSK	10.0 MHz	-	16.21	18.01	9.3
Total			-	19.25	21.05	12.31
A	LTE: QPSK	15.0 MHz	8.16	16.32	18.12	7.41
B	LTE: QPSK	15.0 MHz	-	16.39	18.19	7.41
Total			-	19.37	21.17	10.42
A	LTE: QPSK	20.0 MHz	8.27	16.11	17.91	6.13
B	LTE: QPSK	20.0 MHz	-	16.16	17.96	6.13
Total			-	19.15	20.95	9.14
A	NR: QPSK	5.0 MHz	7.54	16.07	17.87	12.4
B	NR: QPSK	5.0 MHz	-	16.57	18.37	12.4
Total			-	19.34	21.14	15.41
A	NR: QPSK	10.0 MHz	7.85	16.59	18.39	9.28
B	NR: QPSK	10.0 MHz	-	16.43	18.23	9.28
Total			-	19.52	21.32	12.29
A	NR: QPSK	15.0 MHz	7.92	16.16	17.96	7.59
B	NR: QPSK	15.0 MHz	-	16.32	18.12	7.59
Total			-	19.25	21.05	10.6
A	NR: QPSK	20.0 MHz	8.20	16.36	18.16	6.47
B	NR: QPSK	20.0 MHz	-	16.34	18.14	6.47
Total			-	19.36	21.16	9.48



Antenna Port A Carrier Power - Modulation LTE: QPSK - Carrier Bandwidth 10.0 MHz - Channel Position T



Antenna Port A Pk-Av Ratio - Modulation LTE: QPSK - Carrier Bandwidth 10.0 MHz - Channel Position T

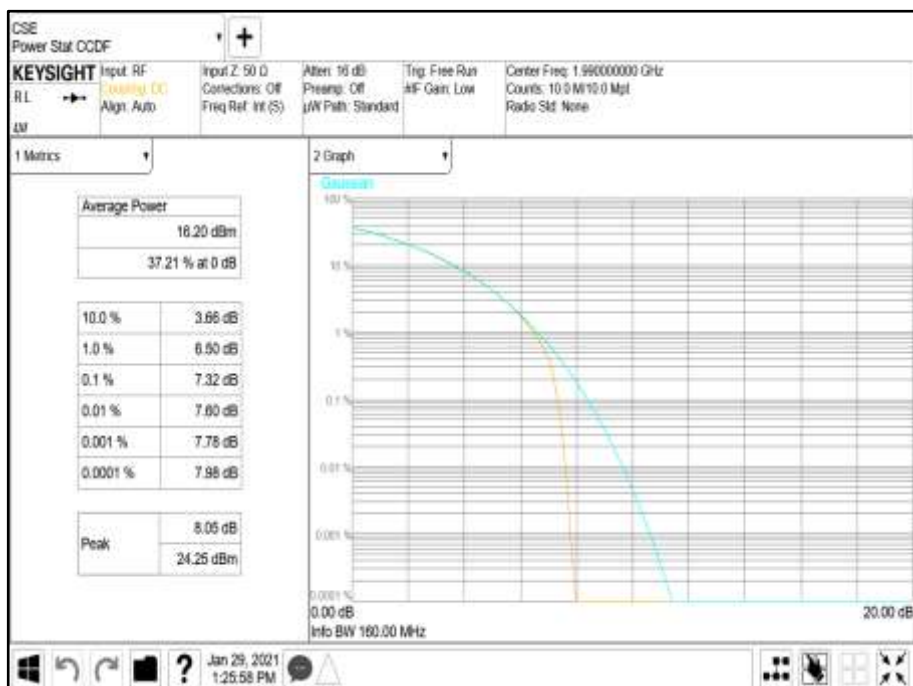



Antenna Port A PSD - Modulation LTE: QPSK - Carrier Bandwidth 10.0 MHz - Channel Position T



Antenna Port A Carrier Power - Modulation LTE: QPSK - Carrier Bandwidth 15.0 MHz - Channel Position T

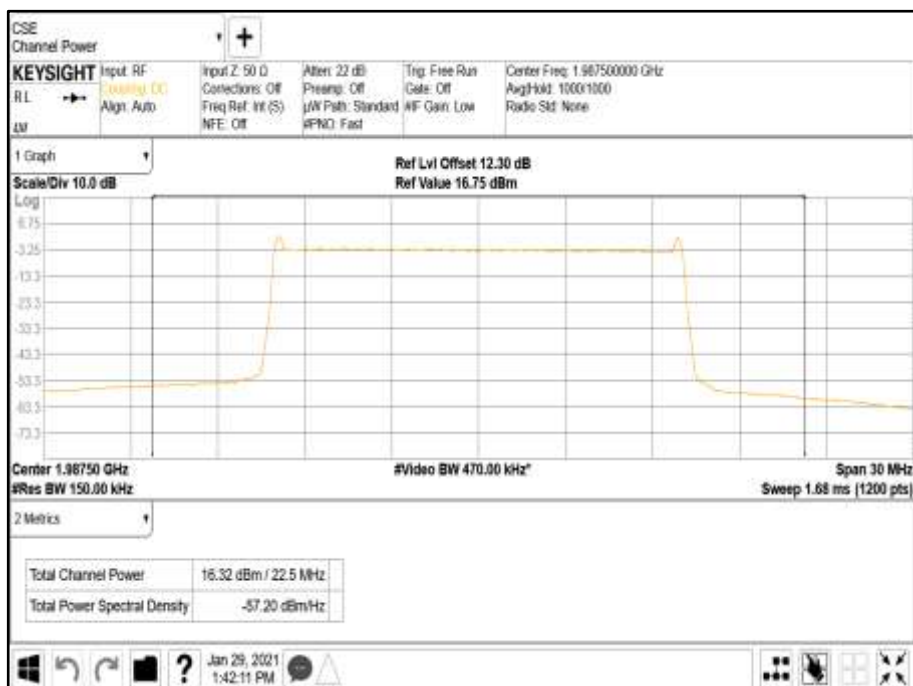



Antenna Port A Pk-Av Ratio - Modulation LTE: QPSK - Carrier Bandwidth 15.0 MHz - Channel Position T

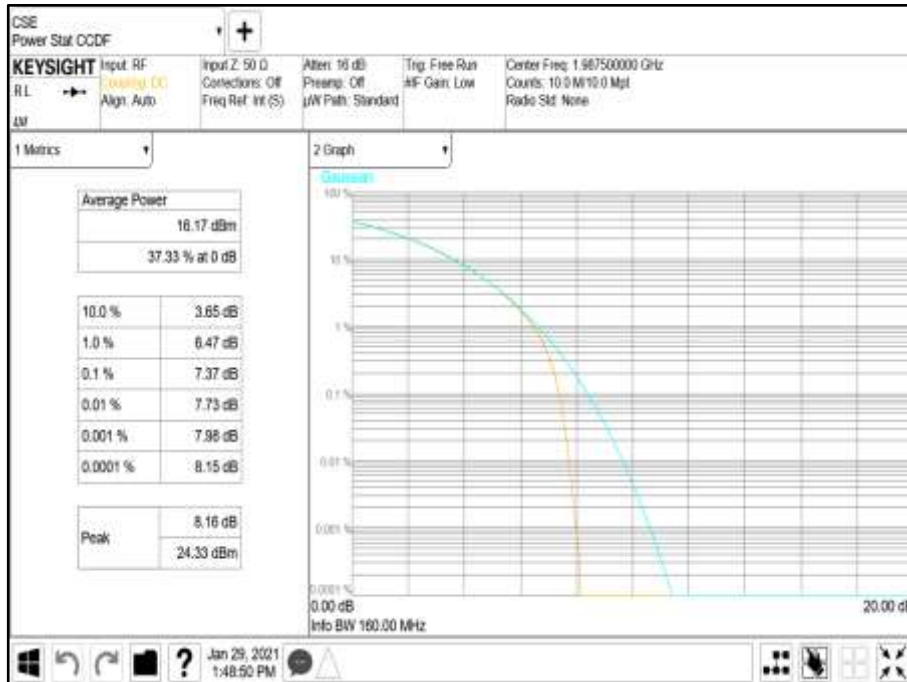

Antenna Port A PSD - Modulation LTE: QPSK - Carrier Bandwidth 15.0 MHz - Channel Position T





Antenna Port A Carrier Power - Modulation LTE: QPSK - Carrier Bandwidth 20.0 MHz - Channel Position T



Antenna Port A Pk-Av Ratio - Modulation LTE: QPSK - Carrier Bandwidth 20.0 MHz - Channel Position T

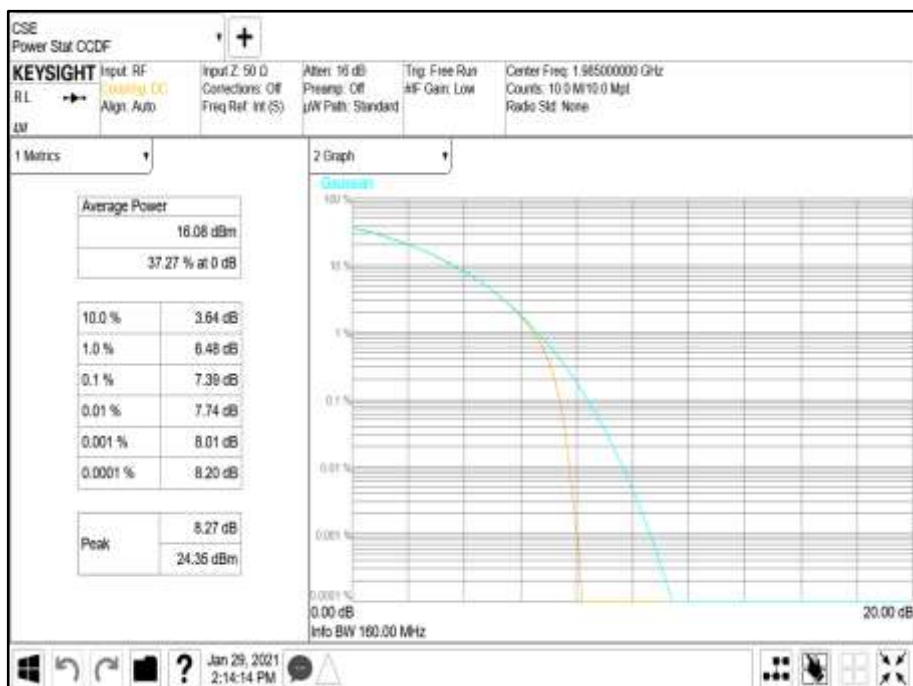



Antenna Port A PSD - Modulation LTE: QPSK - Carrier Bandwidth 20.0 MHz - Channel Position T



Antenna Port A Carrier Power - Modulation NR: QPSK - Carrier Bandwidth 5.0 MHz - Channel Position T





Antenna Port A Pk-Av Ratio - Modulation NR: QPSK - Carrier Bandwidth 5.0 MHz - Channel Position T



Antenna Port A PSD - Modulation NR: QPSK - Carrier Bandwidth 5.0 MHz - Channel Position T

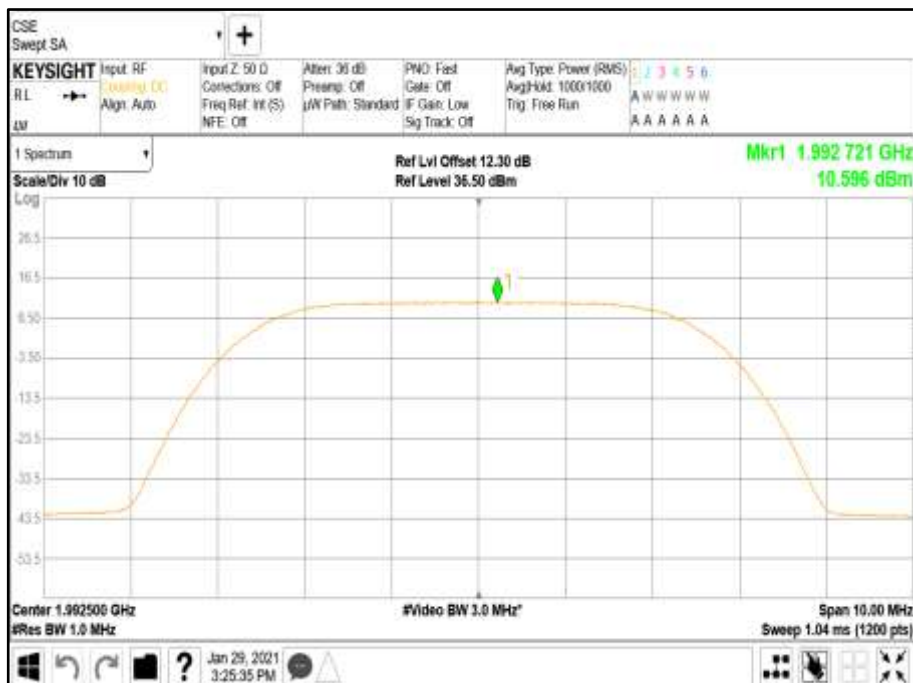



Antenna Port A Carrier Power - Modulation NR: QPSK - Carrier Bandwidth 10.0 MHz - Channel Position T



Antenna Port A Pk-Av Ratio - Modulation NR: QPSK - Carrier Bandwidth 10.0 MHz - Channel Position T

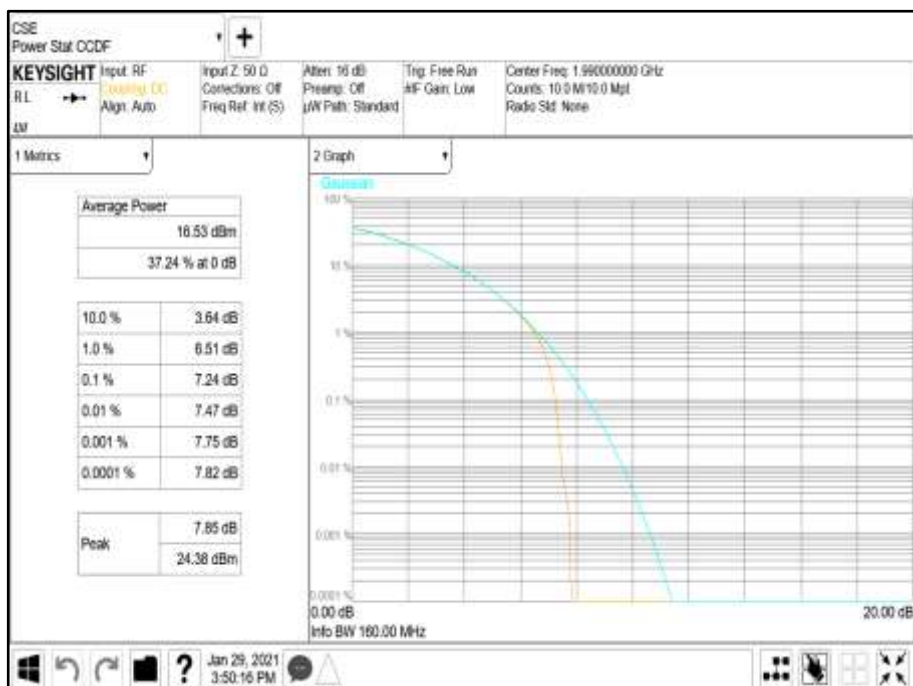



Antenna Port A PSD - Modulation NR: QPSK - Carrier Bandwidth 10.0 MHz - Channel Position T



Antenna Port A Carrier Power - Modulation NR: QPSK - Carrier Bandwidth 15.0 MHz - Channel Position T





Antenna Port A Pk-Av Ratio - Modulation NR: QPSK - Carrier Bandwidth 15.0 MHz - Channel Position T

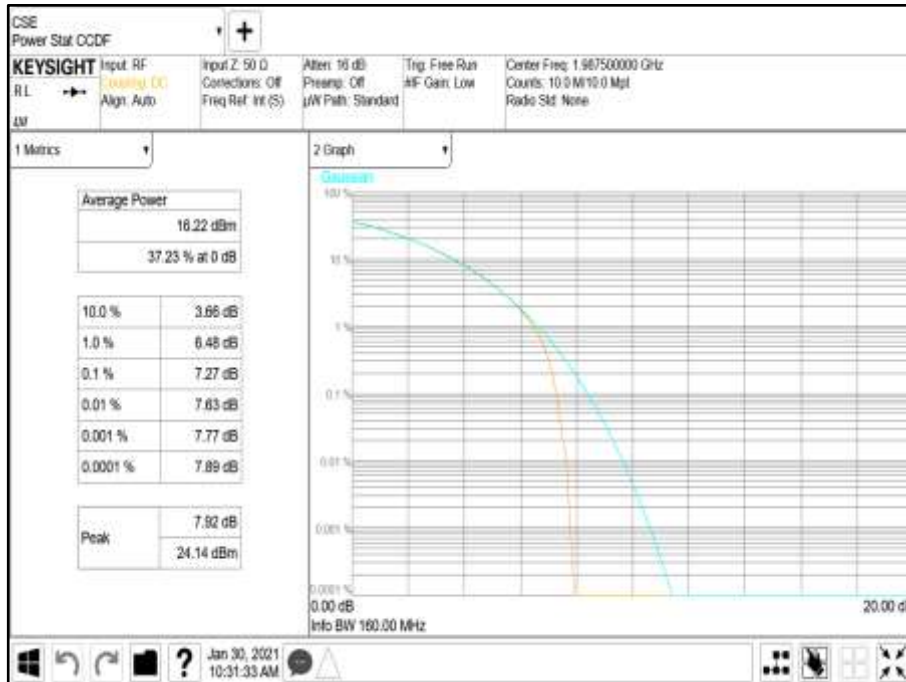

Antenna Port A PSD - Modulation NR: QPSK - Carrier Bandwidth 15.0 MHz - Channel Position T





Antenna Port A Carrier Power - Modulation NR: QPSK - Carrier Bandwidth 20.0 MHz - Channel Position T



Antenna Port A Pk-Av Ratio - Modulation NR: QPSK - Carrier Bandwidth 20.0 MHz - Channel Position T

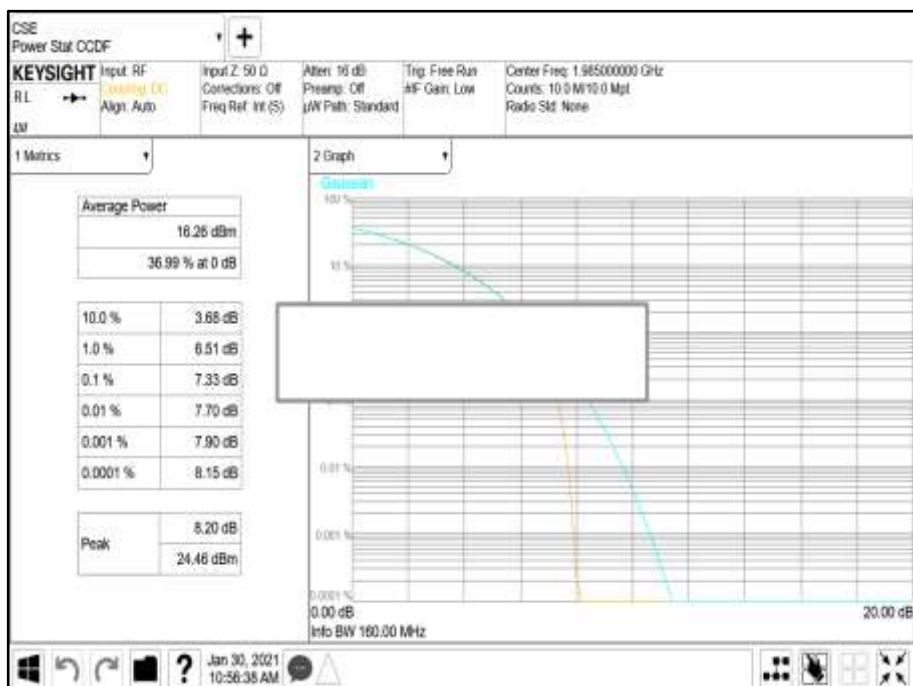



Antenna Port A PSD - Modulation NR: QPSK - Carrier Bandwidth 20.0 MHz - Channel Position
T





Configuration B

Maximum Output Power 17/Port dBm

Antenna	Modulation	Carrier Bandwidth	Peak to Average Ratio (PAR) / Output Power		
			Channel Position B		
			PAR (dB)	Average Power	
dBm	EIRP (dBm)				
A	LTE: QPSK	5.0+5.0+5.0+5.0+5.0+5.0 MHz	-	16.49	18.29
B	LTE: QPSK	5.0+5.0+5.0+5.0+5.0+5.0 MHz	-	16.25	18.05
Total			-	19.38	21.18
A	NR: QPSK	5.0+5.0+5.0+5.0+5.0+5.0 MHz	-	16.42	18.22
B	NR: QPSK	5.0+5.0+5.0+5.0+5.0+5.0 MHz	-	16.42	18.22
Total			-	19.43	21.23
A	LTE + NR: QPSK	5.0+5.0+5.0+5.0+5.0+5.0 MHz	-	16.56	18.36
B	LTE + NR: QPSK	5.0+5.0+5.0+5.0+5.0+5.0 MHz	-	16.32	18.12
Total			-	19.45	21.25
A	LTE + WCDMA: QPSK	10.0+10.0+5.0+5.0+5.0+5.0 MHz	-	16.29	18.09
B	LTE + WCDMA: QPSK	10.0+10.0+5.0+5.0+5.0+5.0 MHz	-	16.09	17.89
Total			-	19.20	21.00

Remarks

1. Six carrier transmitter performance is presented.
2. The plot results represent typical radio performance across all channels.
3. The highest power transmitter configuration is presented for compliance.
4. Plot data performance for all transmitter ports and channels are on file and available on request.



Antenna A - Modulation LTE: QPSK - Carrier Bandwidth 5.0+5.0+5.0+5.0+5.0+5.0 MHz - Channel Position B



Antenna A - Modulation NR: QPSK - Carrier Bandwidth 5.0+5.0+5.0+5.0+5.0+5.0 MHz - Channel Position B

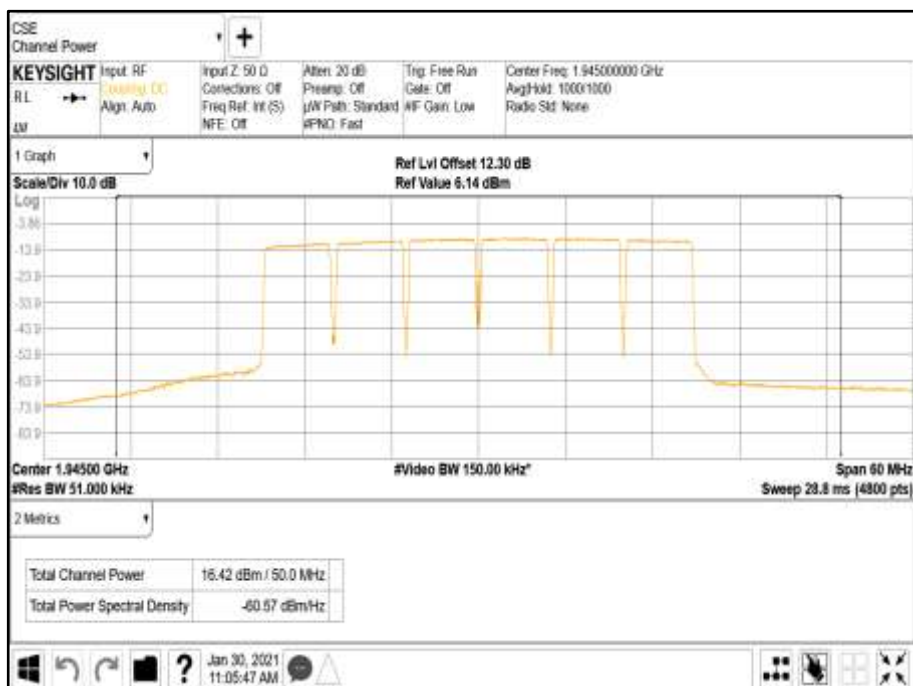



Antenna A - Modulation LTE+NR: QPSK - Carrier Bandwidth 5.0+5.0+5.0+5.0+5.0+5.0 MHz - Channel Position B



Antenna A - Modulation LTE+WCDMA: QPSK - Carrier Bandwidth 10.0+10.0+5.0+5.0+5.0+5.0 MHz - Channel Position B





Limit	
Peak Power	≤ 1640 W/MHz or $\leq +62.15$ dBm
Peak to Average Ratio	13 dB



2.2 OCCUPIED BANDWIDTH

2.2.1 Specification Reference

FCC CFR 47 Part 24, Clause 24.238 (b)
 ISED RSS-GEN, Clause 6.7
 Industry Canada RSS-133, Clause 6.5
 FCC CFR 47 Part 2, Clause 2.1049

2.2.2 Date of Test and Modification State

29 January 2021 - Modification State 0

2.2.3 Test Equipment Used

The major items of test equipment used for the above tests are identified in Section 3.1.

2.2.4 Environmental Conditions

Ambient Temperature 25.0°C
 Relative Humidity 23.2%

2.2.5 Test Method

All measurements were made in accordance with FCC KDB 971168 D01.

2.2.6 Test Results

Configuration A

Maximum Output Power 17/Port dBm

Modulation	Carrier Bandwidth	Result (MHz)	
		Channel Bandwidth	
		Occupied Bandwidth	-26 dB Bandwidth
LTE: QPSK	LTE: 10.0 MHz	9.39	9.64
LTE: QPSK	LTE: 15.0 MHz	13.99	14.35
LTE: QPSK	LTE: 20.0 MHz	18.42	18.90
NR: QPSK	NR: 5.0 MHz	4.46	4.72
NR: QPSK	NR: 10.0 MHz	9.26	9.63
NR: QPSK	NR: 15.0 MHz	14.07	14.59
NR: QPSK	NR: 20.0 MHz	18.81	19.55

Remarks

Representative occupied bandwidth performance results presented. Plot data performance for all transmitter ports and channel positions are on file and available on request.



2.3 BAND EDGE

2.3.1 Specification Reference

FCC CFR 47 Part 24, Clause 24.238 (b)
 Industry Canada RSS-133, Clause 6.5
 FCC CFR 47 Part 2, Clause 2.1051

2.3.2 Date of Test and Modification State

28 January 2021 - Modification State 0

2.3.3 Test Equipment Used

The major items of test equipment used for the above tests are identified in Section 3.1.

2.3.4 Environmental Conditions

Ambient Temperature 25.0 - 25.1°C
 Relative Humidity 23.1 - 23.2%

2.3.5 Test Method

All measurements were made in accordance with FCC KDB 971168 D01, Clause 6.0.

Band Edge measurements were used an Integration Bandwidth of at least 1% of the measured 26dB Bandwidth.

This product has 2 transmitter ports. To account for this, the limit was tightened by $10 * \text{Log}(N)$, where N is equal to the number of MIMO antenna ports.

For dual port, the limit was calculated as being $-13 \text{ dBm} - 10 * \text{Log}(2) = -16 \text{ dBm}$.

2.3.6 Test Results

Configuration A

Maximum Output Power 17/Port dBm

Modulation	Carrier Bandwidth	Band Edge (MHz)	
		Channel Position B	Channel Position T
LTE: QPSK	LTE: 10.0 MHz	1,935.0	1,990.0
LTE: QPSK	LTE: 15.0 MHz	1,937.5	1,987.5
LTE: QPSK	LTE: 20.0 MHz	1,940.0	1,985.0
NR: QPSK	NR: 5.0 MHz	1,932.5	1,992.5
NR: QPSK	NR: 10.0 MHz	1,935.0	1,990.0
NR: QPSK	NR: 15.0 MHz	1,937.5	1,987.5
NR: QPSK	NR: 20.0 MHz	1,940.0	1,985.0

Remarks

1. Bandedge data was captured from the transmit port with maximum measured power.
2. Worst case bandedge data presented.



Modulation LTE: QPSK - Carrier Bandwidth LTE: 10.0 MHz - Channel Position B

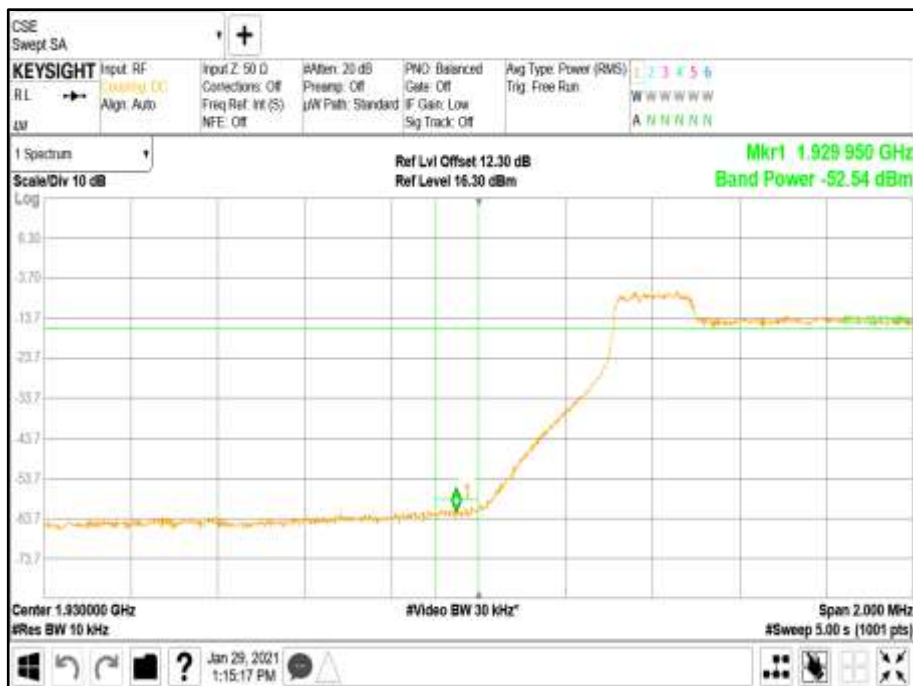

Modulation LTE: QPSK - Carrier Bandwidth LTE: 10.0 MHz - Channel Position T





Modulation LTE: QPSK - Carrier Bandwidth LTE: 15.0 MHz - Channel Position B



Modulation LTE: QPSK - Carrier Bandwidth LTE: 15.0 MHz - Channel Position T



Modulation LTE: QPSK - Carrier Bandwidth LTE: 20.0 MHz - Channel Position B

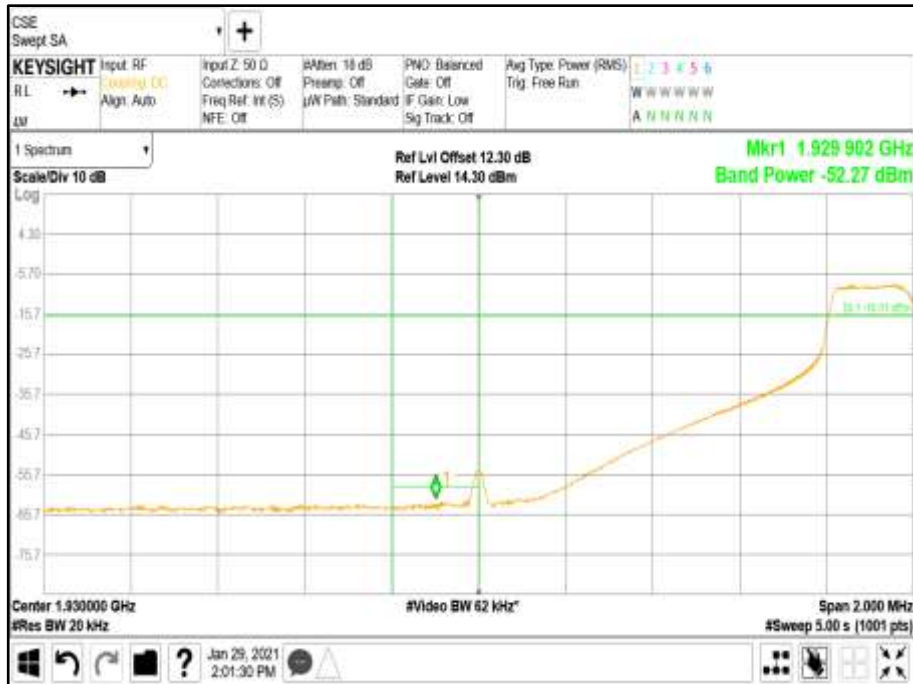

Modulation LTE: QPSK - Carrier Bandwidth LTE: 20.0 MHz - Channel Position T





Modulation NR: QPSK - Carrier Bandwidth NR: 5.0 MHz - Channel Position B

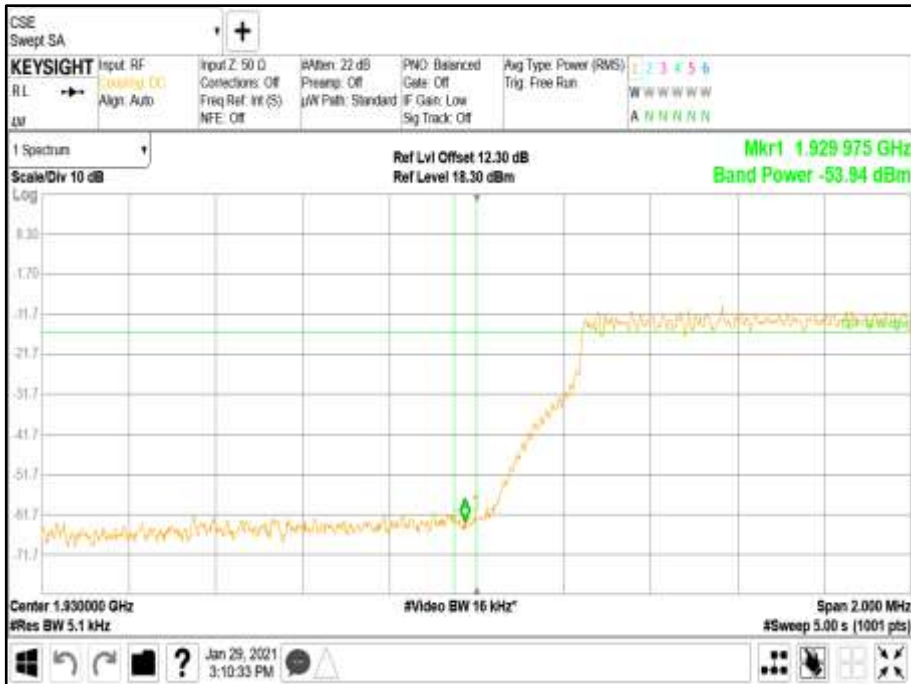

Modulation NR: QPSK - Carrier Bandwidth NR: 5.0 MHz - Channel Position T

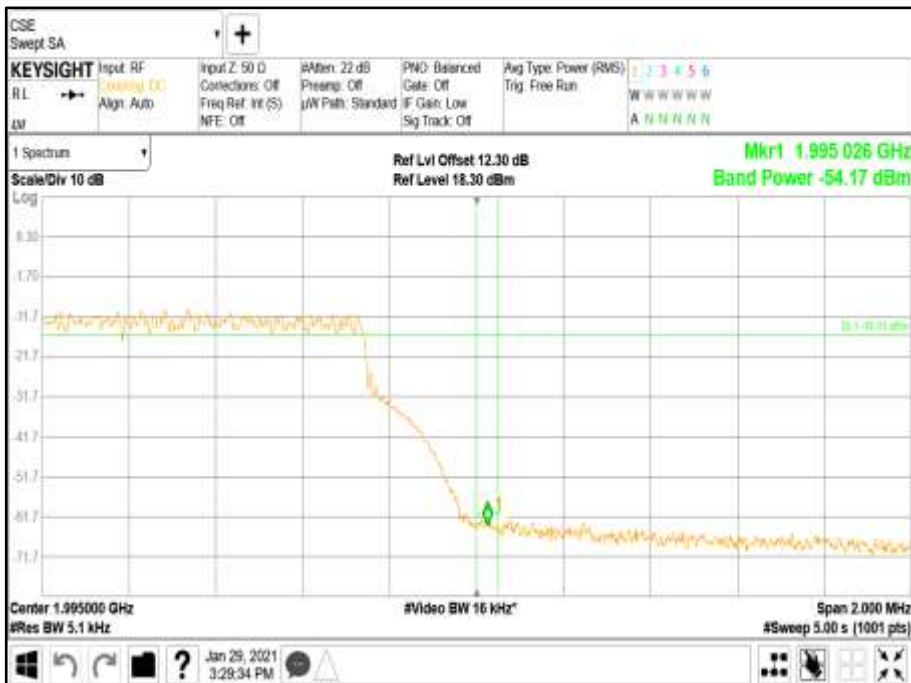



Modulation NR: QPSK - Carrier Bandwidth NR: 10.0 MHz - Channel Position B

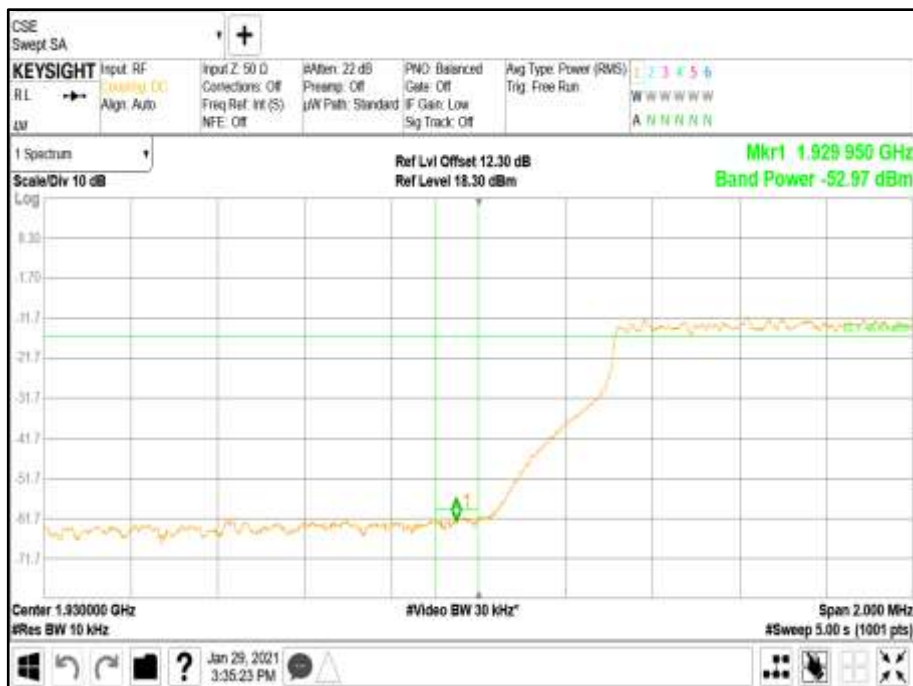

Modulation NR: QPSK - Carrier Bandwidth NR: 10.0 MHz - Channel Position T

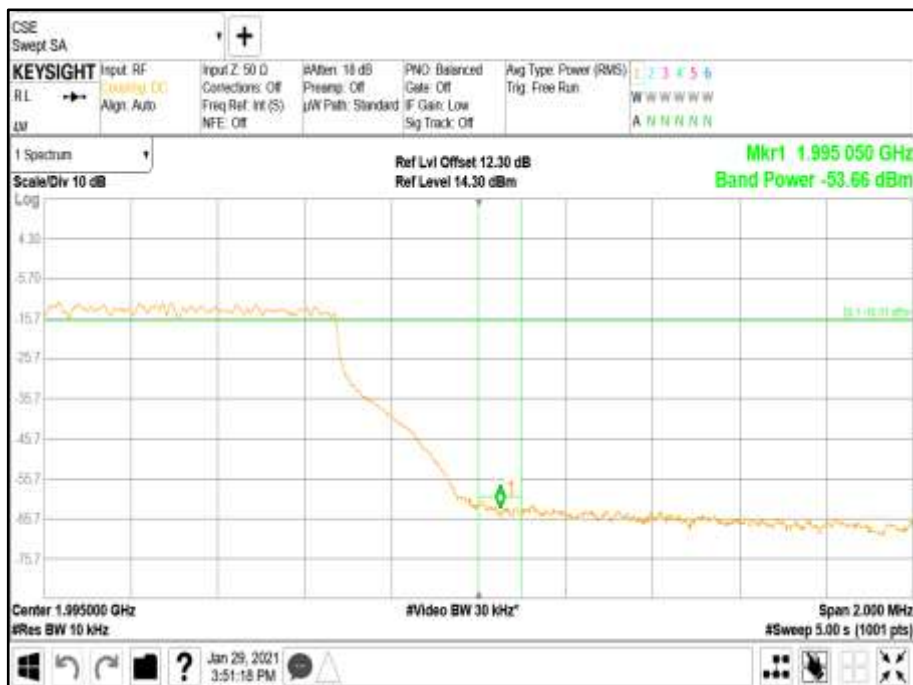



Modulation NR: QPSK - Carrier Bandwidth NR: 15.0 MHz - Channel Position B

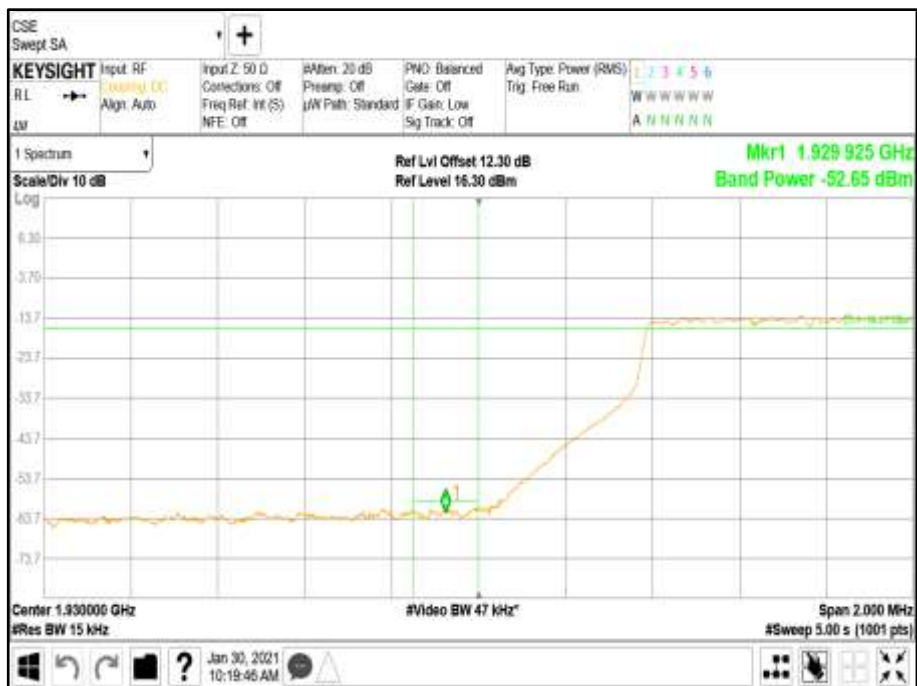

Modulation NR: QPSK - Carrier Bandwidth NR: 15.0 MHz - Channel Position T





Modulation NR: QPSK - Carrier Bandwidth NR: 20.0 MHz - Channel Position B

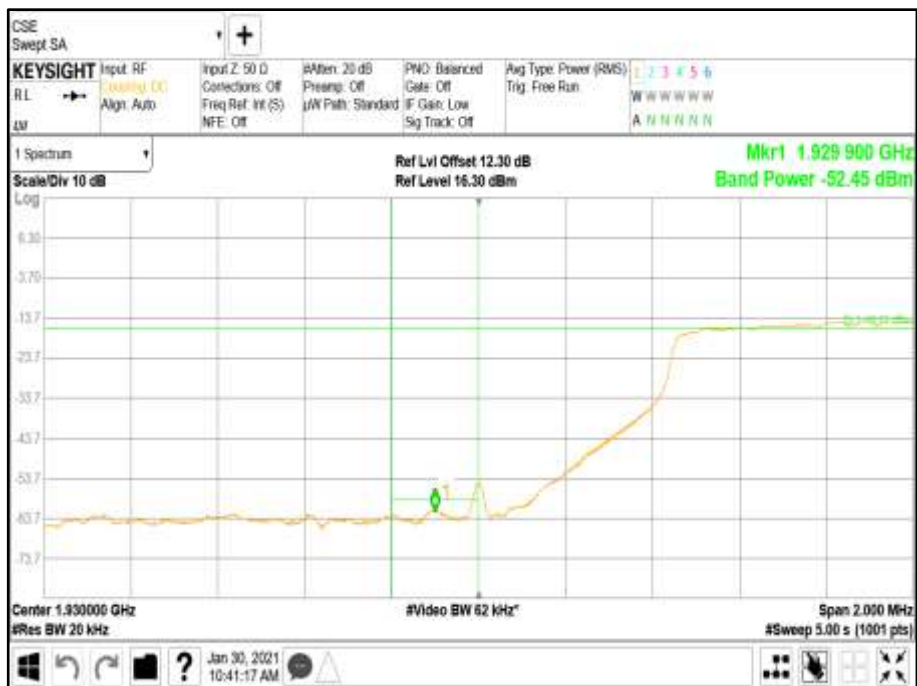

Modulation NR: QPSK - Carrier Bandwidth NR: 20.0 MHz - Channel Position T





Configuration B

Maximum Output Power 17/Port dBm

Antenna	Modulation	Carrier Bandwidth	Band Edge (MHz)	
			Channel Position B	Channel Position T
A	LTE: QPSK	5.0+5.0+5.0+5.0+5.0+5.0 MHz	1932.5+1937.5+1942.5+1947.5+1952.5+1957.5	1967.5+1972.5+1977.5+1982.5+1987.5+1992.5
A	NR: QPSK	5.0+5.0+5.0+5.0+5.0+5.0 MHz	1932.5+1937.5+1942.5+1947.5+1952.5+1957.5	1967.5+1972.5+1977.5+1982.5+1987.5+1992.5
A	LTE + NR QPSK	5.0+5.0+5.0+5.0+5.0+5.0 MHz	1932.5+1937.5+1942.5+1947.5+1952.5+1957.5	1967.5+1972.5+1977.5+1982.5+1987.5+1992.5
A	LTE + WCDMA QPSK	10.0+10.0+5.0+5.0+5.0+5.0 MHz	1935.0+1945.0+1952.5+1957.5+1962.5+1967.5	1960.0+1970.0+1977.5+1982.5+1987.5+1992.5

Remarks

Six carrier transmitter performance is presented. The plot results represent typical radio performance. Plot data performance for all transmitter ports and channels are on file and available on request.



Antenna A - Modulation LTE: QPSK - Carrier Bandwidth 5.0+5.0+5.0+5.0+5.0+5.0 MHz - Channel Position B



Antenna A - Modulation LTE: QPSK - Carrier Bandwidth 5.0+5.0+5.0+5.0+5.0+5.0 MHz - Channel Position T





Antenna A - Modulation NR: QPSK - Carrier Bandwidth 5.0+5.0+5.0+5.0+5.0+5.0 MHz - Channel Position B



Antenna A - Modulation NR: QPSK - Carrier Bandwidth 5.0+5.0+5.0+5.0+5.0+5.0 MHz - Channel Position T





Antenna A - Modulation LTE + NR QPSK - Carrier Bandwidth 5.0+5.0+5.0+5.0+5.0+5.0 MHz - Channel Position B



Antenna A - Modulation LTE + NR QPSK - Carrier Bandwidth 5.0+5.0+5.0+5.0+5.0+5.0 MHz - Channel Position T





Antenna A - Modulation LTE + WCDMA QPSK - Carrier Bandwidth 10.0+10.0+5.0+5.0+5.0+5.0 MHz - Channel Position B

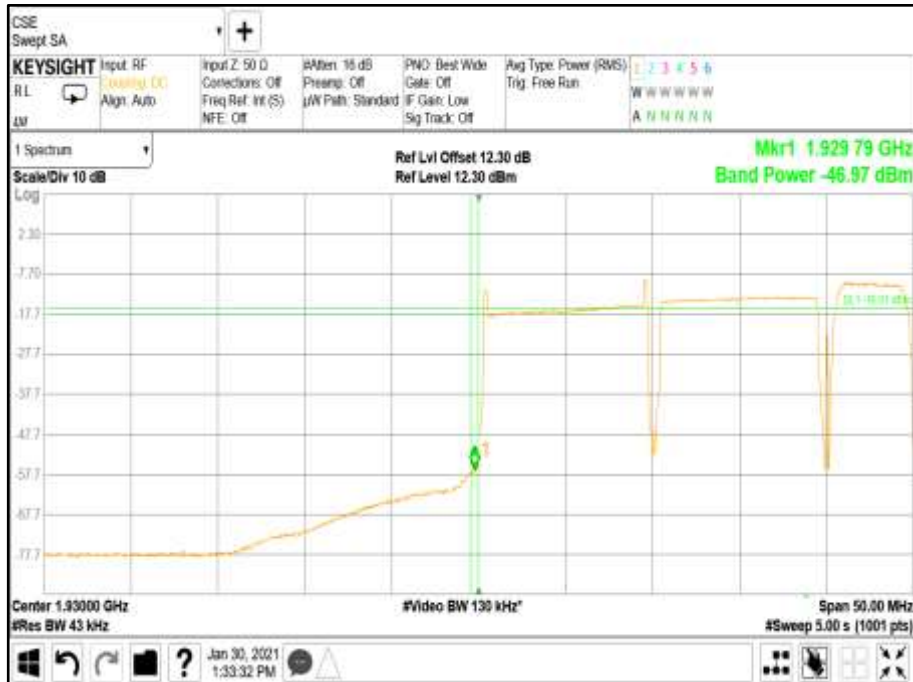

Antenna A - Modulation LTE + WCDMA QPSK - Carrier Bandwidth 10.0+10.0+5.0+5.0+5.0+5.0 MHz - Channel Position T





Limit	
	-16 dBm



2.4 TRANSCEIVER SPURIOUS EMISSIONS

2.4.1 Specification Reference

FCC CFR 47 Part 24, Clause 24.238 (a)
ISED RSS-GEN, Clause 6.13
Industry Canada RSS-133, Clause 6.5
FCC CFR 47 Part 2, Clause 2.1051

2.4.2 Date of Test and Modification State

28 January 2021 - Modification State 0

2.4.3 Test Equipment Used

The major items of test equipment used for the above tests are identified in Section 3.1.

2.4.4 Environmental Conditions

Ambient Temperature	25.0 - 25.1°C
Relative Humidity	23.1 - 23.2%

2.4.5 Test Method

All measurements were made in accordance with FCC KDB 971168 D01, Clause 6.1.

This product has 2 transmitter ports. To account for this, the limit was tightened by $10 * \text{Log}(N)$, where N is equal to the number of MIMO antenna ports.

For dual port, the limit was calculated as being $-13 \text{ dBm} - 10 * \text{Log}(2) = -16 \text{ dBm}$.

2.4.6 Test Results

Configuration A

Maximum Output Power 17/Port dBm

Remarks

1. Transceiver spurious emissions have been searched for all channel bandwidths and antenna ports.
2. Representative spurious emissions performance has been presented for all modulations.
3. Plot data performance for all transmitter ports, channel bandwidths, and channel positions are on file and available on request.



Modulation LTE: QPSK - Carrier Bandwidth 10.0 MHz - Channel Position M - Band 1.00 - Range 0.009 to 4000 MHz

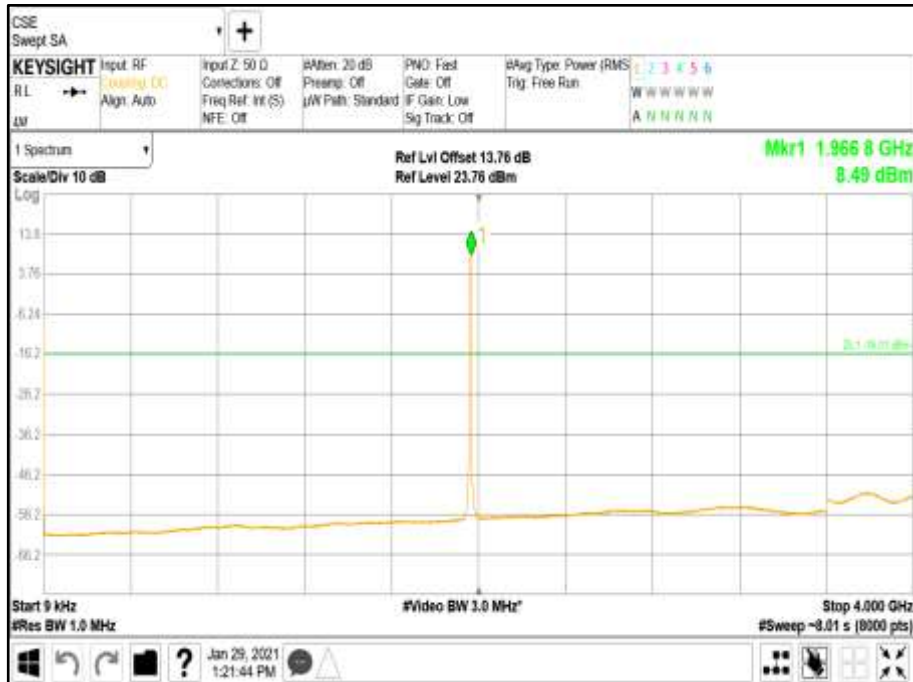

Modulation LTE: QPSK - Carrier Bandwidth 10.0 MHz - Channel Position M - Band 2.00 - Range 4000 to 12000 MHz

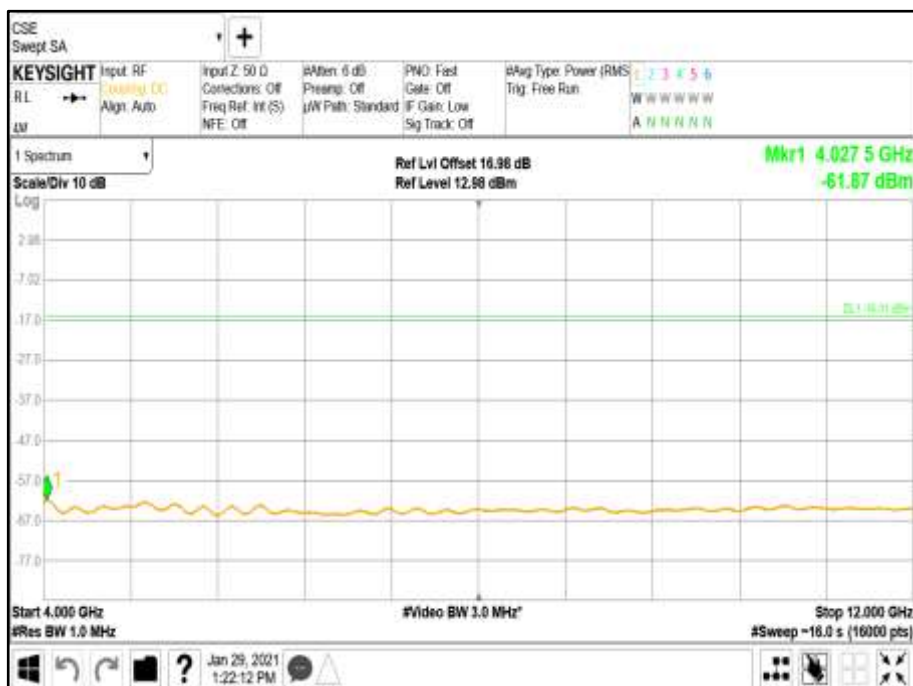



Modulation LTE: QPSK - Carrier Bandwidth 10.0 MHz - Channel Position M - Band 3.00 - Range 12000 to 20000 MHz



Modulation NR: QPSK - Carrier Bandwidth 5.0 MHz - Channel Position M - Band 1.00 - Range 0.009 to 4000 MHz

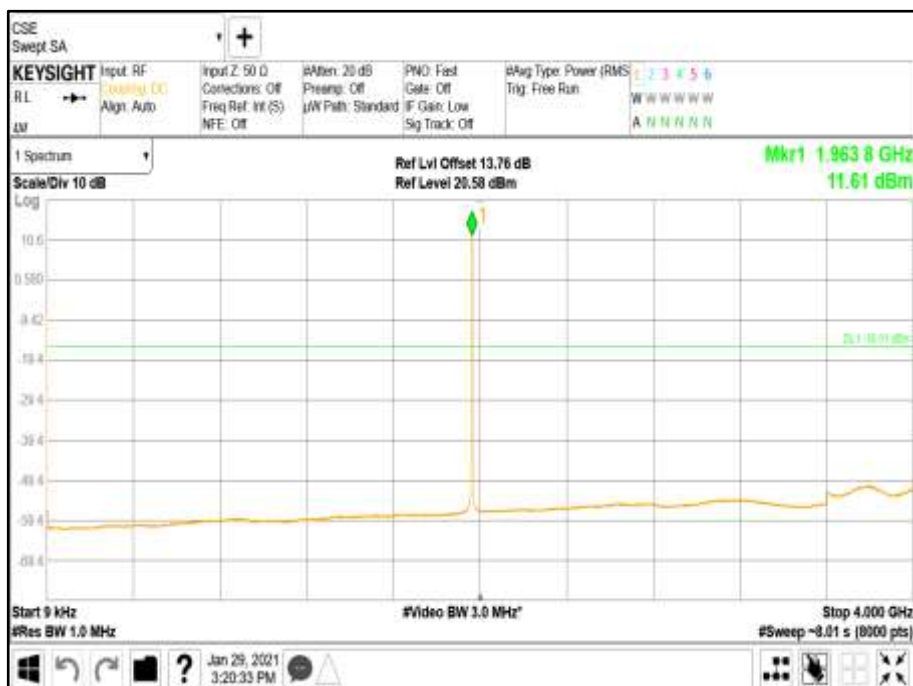



Modulation NR: QPSK - Carrier Bandwidth 5.0 MHz - Channel Position M - Band 2.00 - Range 4000 to 12000 MHz

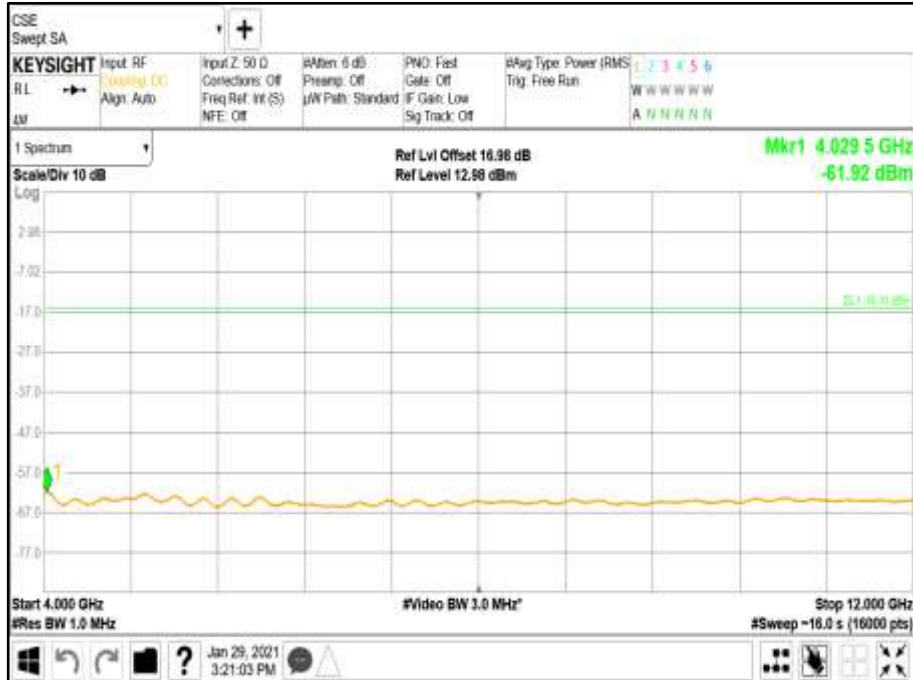

Modulation NR: QPSK - Carrier Bandwidth 5.0 MHz - Channel Position M - Band 3.00 - Range 12000 to 20000 MHz





Modulation Receiver Spurious - Carrier Bandwidth 5.0 MHz - Channel Position M - Band 1.00 - Range 30 to 1000 MHz

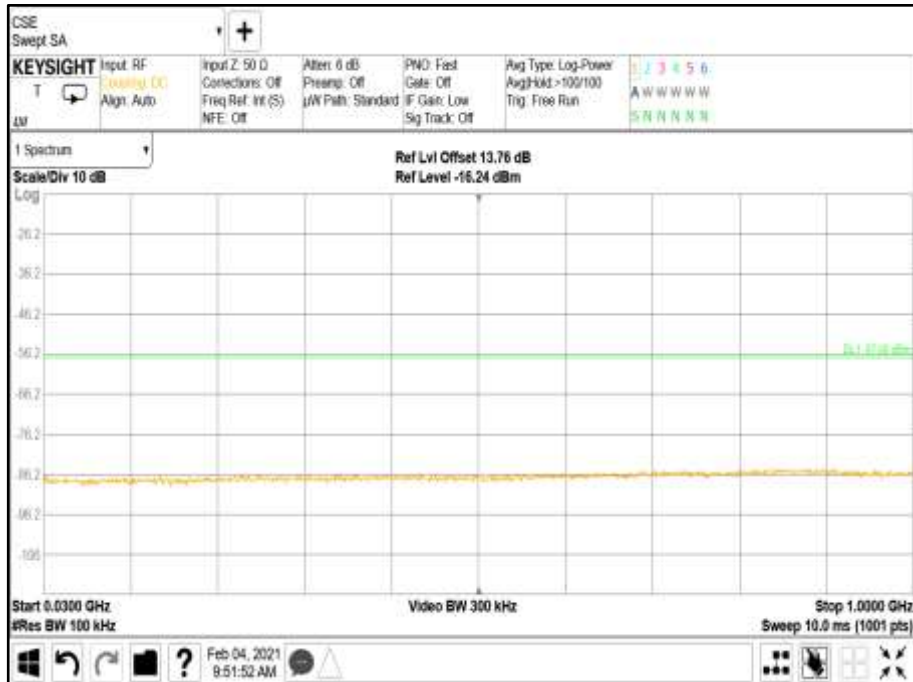

Modulation Receiver Spurious - Carrier Bandwidth 5.0 MHz - Channel Position M - Band 2.00 - Range 1000 to 20000 MHz

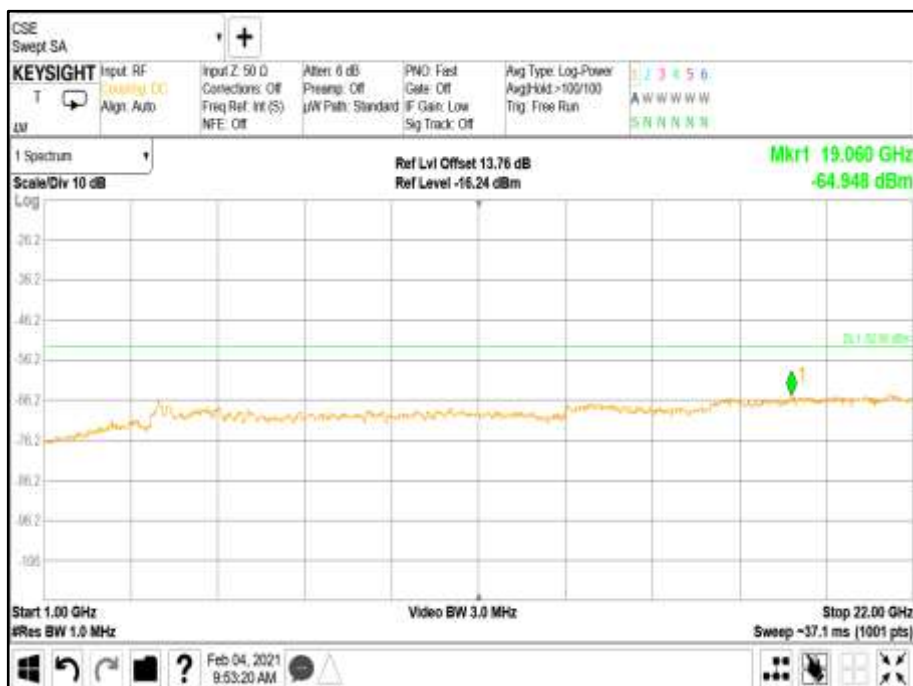



Configuration B

Maximum Output Power 17/Port dBm

Remarks

1. Spurious emissions have been searched for all channel bandwidths and antenna ports.
2. Representative spurious emissions performance has been presented for all modulations.
3. Plot data performance for all transmitter ports, channel bandwidths, and channel positions are on file and available on request.



Modulation LTE: QPSK - Carrier Bandwidth 10.0 MHz - Channel Position M - Band 1.00 - Range 0.009 to 4000 MHz



Modulation LTE: QPSK - Carrier Bandwidth 10.0 MHz - Channel Position M - Band 2.00 - Range 4000 to 12000 MHz

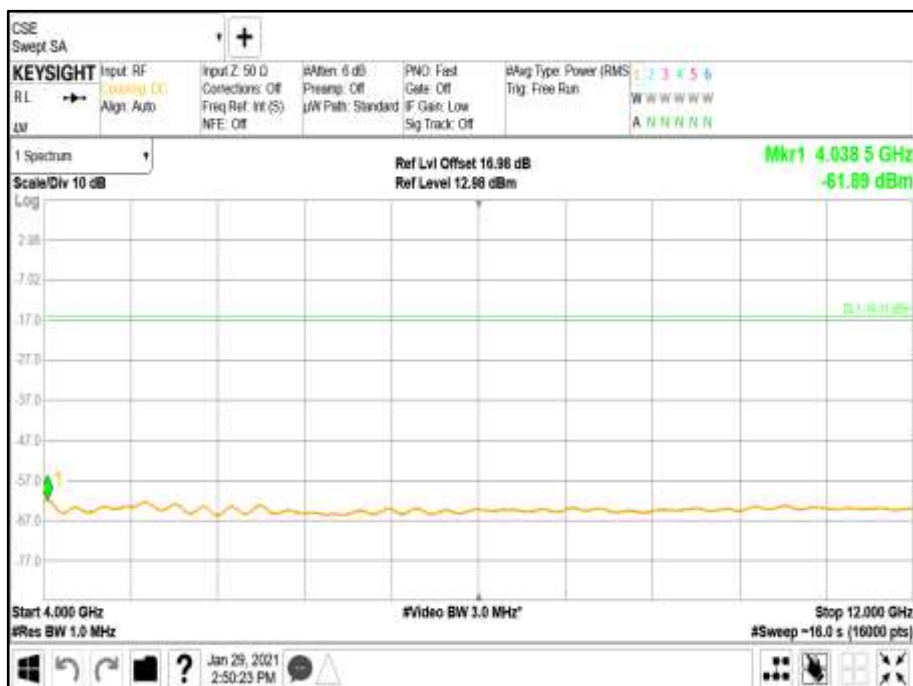



Modulation LTE: QPSK - Carrier Bandwidth 10.0 MHz - Channel Position M - Band 3.00 - Range 12000 to 20000 MHz



Modulation NR: QPSK - Carrier Bandwidth 5.0 MHz - Channel Position M - Band 1.00 - Range 0.009 to 4000 MHz





Modulation NR: QPSK - Carrier Bandwidth 5.0 MHz - Channel Position M - Band 2.00 - Range 4000 to 12000 MHz

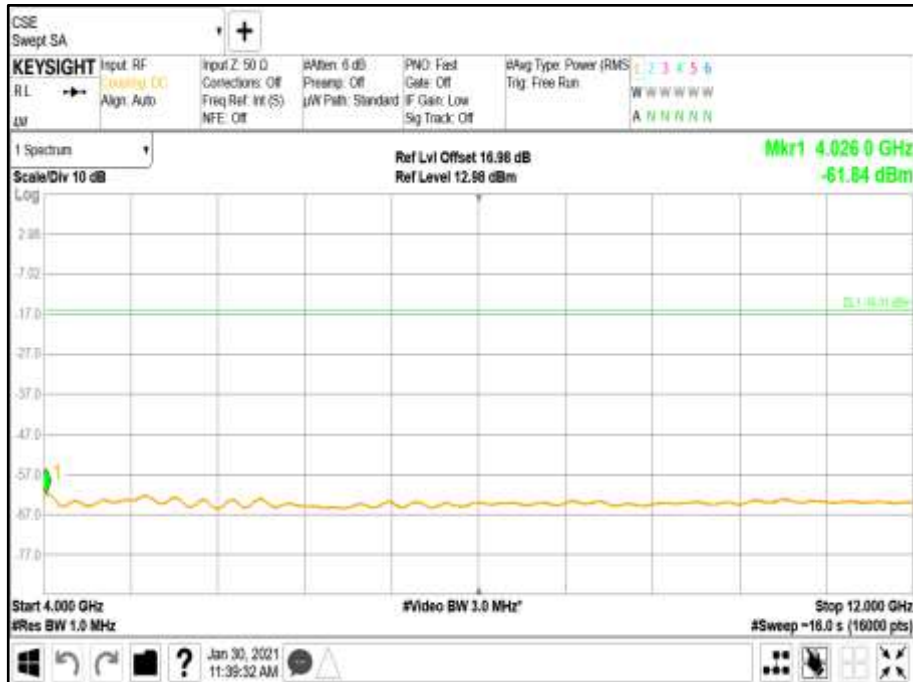

Modulation NR: QPSK - Carrier Bandwidth 5.0 MHz - Channel Position M - Band 3.00 - Range 12000 to 20000 MHz





Modulation LTE+NR: QPSK - Carrier Bandwidth 5.0 MHz - Channel Position M - Band 1.00 - Range 0.009 to 4000 MHz



Modulation LTE+NR: QPSK - Carrier Bandwidth 5.0 MHz - Channel Position M - Band 2.00 - Range 4000 to 12000 MHz

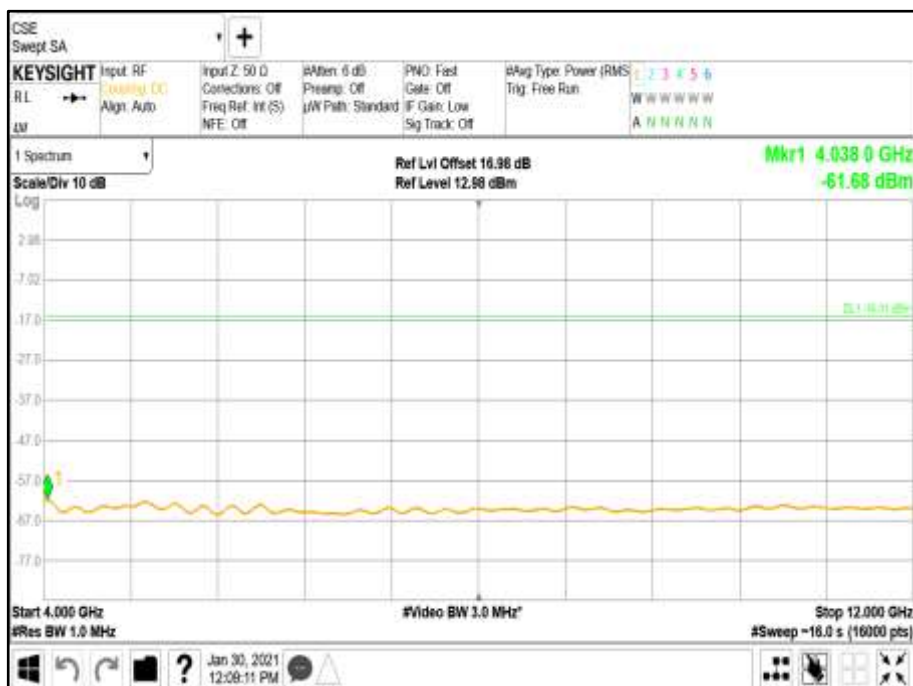



Modulation LTE+NR: QPSK - Carrier Bandwidth 5.0 MHz - Channel Position M - Band 3.00 - Range 12000 to 20000 MHz



Modulation LTE+WCDMA: QPSK - Carrier Bandwidth 5.0 MHz - Channel Position M - Band 1.00 - Range 0.009 to 4000 MHz





Modulation LTE+WCDMA: QPSK - Carrier Bandwidth 5.0 MHz - Channel Position M - Band 2.00 - Range 4000 to 12000 MHz

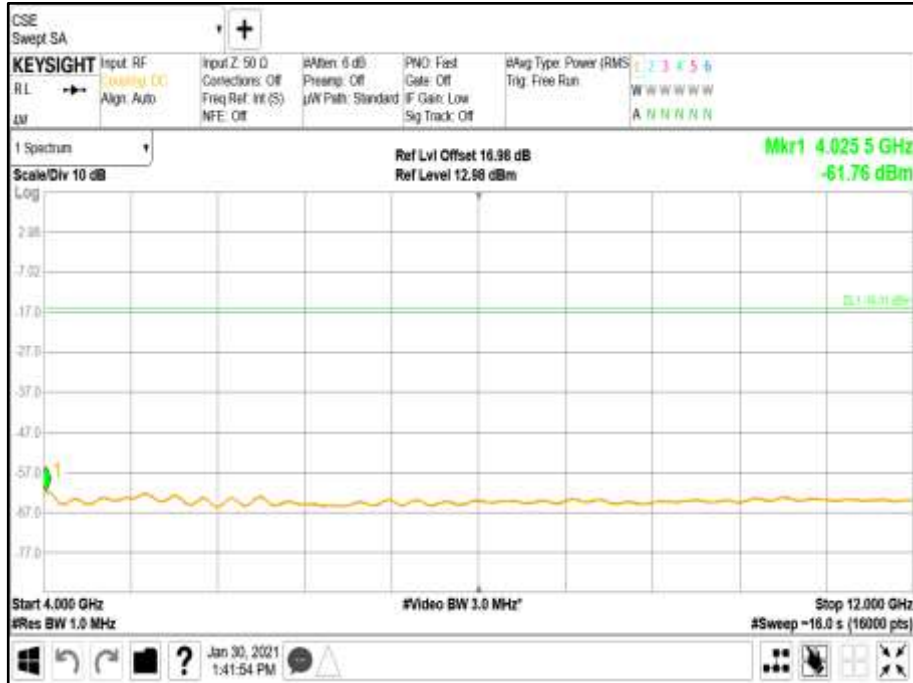

Modulation LTE+WCDMA: QPSK - Carrier Bandwidth 5.0 MHz - Channel Position M - Band 3.00 - Range 12000 to 20000 MHz





Modulation Receiver Spurious - Carrier Bandwidth 5.0 MHz - Channel Position M - Band 1.00 - Range 30 MHz to 1000 MHz

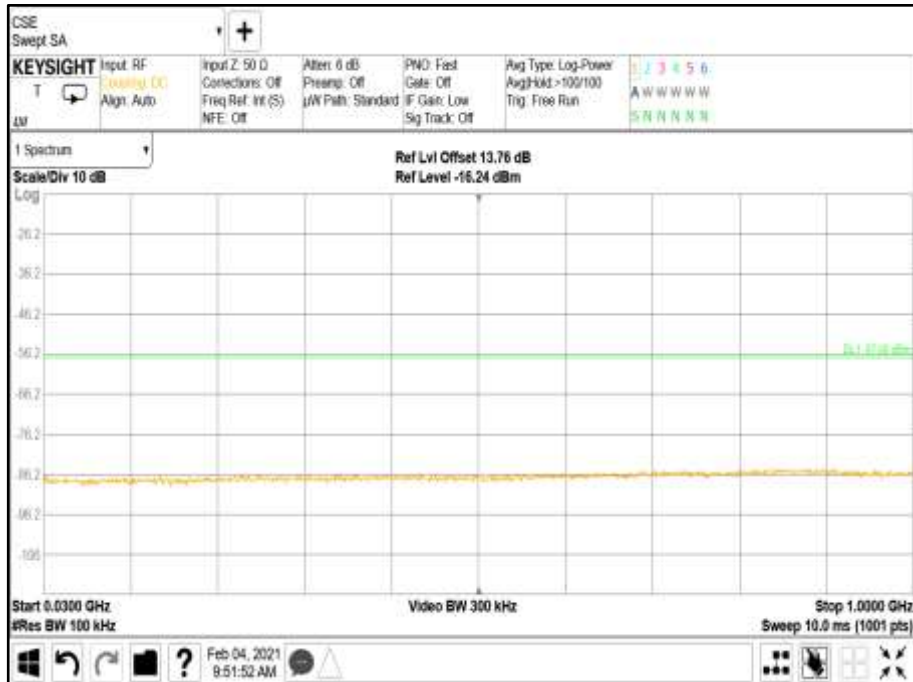

Modulation Receiver Spurious - Carrier Bandwidth 5.0 MHz - Channel Position M - Band 2.00 - Range 1000 to 20000 MHz

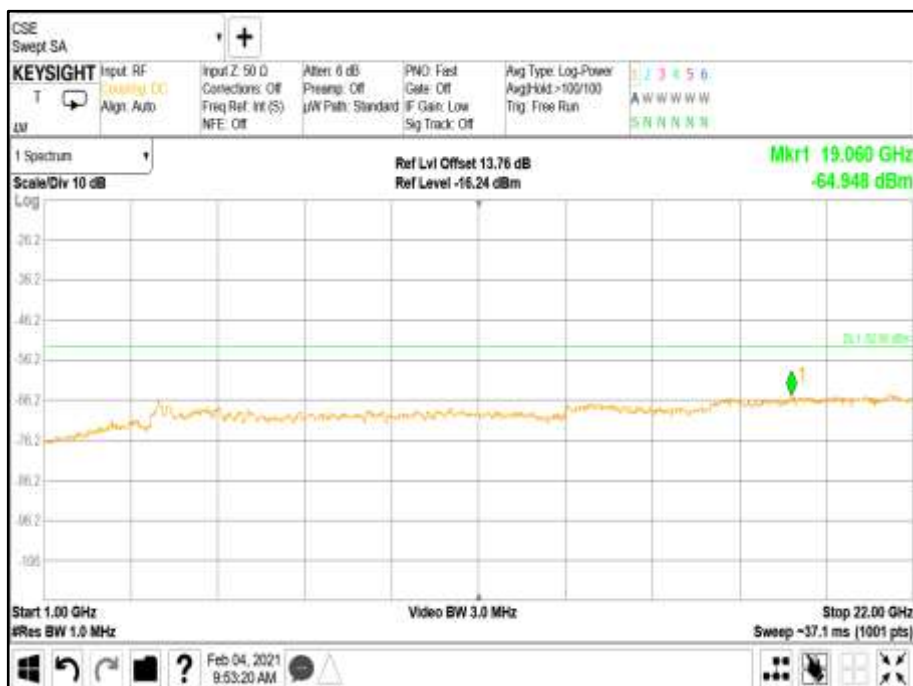



Limit	-16 dBm RSS-GEN limit for Rx emissions = -57 dBm $f < 1\text{GHz}$ -53 dBm $f > 1\text{GHz}$
-------	---



SECTION 3

TEST EQUIPMENT USED



3.1 TEST EQUIPMENT USED

List of absolute measuring and other principal items of test equipment.

Instrument	Manufacturer	Type No.	TE No.	Calibration Period (months)	Calibration Due
Spectrum Analyzer	Keysight	PXA N9030B	MY57144347	24	24/04/2022
Thermometer	VWR	61161-364	192595396.00	24	25/10/2021
PSU	Xantrex	XKW60-50	E00109862	-	O/P Mon
Attenuator (10dB)	Mini-Circuits	BW-K10-2W44+	-	-	O/P Mon
RF Switch	Ericsson	RARSW 4x1	1.00	-	O/P Mon
Switching Control Unit	HP	11713A	3748A060876	-	O/P Mon
Climate Chamber	Burnsco	RTC-37P-3-3	-07-07	-	O/P Mon

N/A – Not Applicable

O/P Mon – Output Monitored with Calibrated Equipment



3.2 MEASUREMENT UNCERTAINTY

For a 95% confidence level, the measurement uncertainties for defined systems are:-

Test Discipline	Frequency / Parameter	MU	
Conducted Maximum Peak Output Power	30 MHz to 20 GHz Amplitude	± 0.7 dB	
Conducted Emissions	30 MHz to 20 GHz Amplitude	± 2.1 dB	
Frequency Stability	30 MHz to 2 GHz	± 5.0 Hz	
Occupied Bandwidth	Up to 20 MHz Bandwidth	5 MHz Bandwidth	± 11547 Hz
		10 MHz Bandwidth	± 23094 Hz
		15 MHz Bandwidth	± 34641 Hz
		20 MHz Bandwidth	± 46188 Hz
Band Edge	30 MHz to 20 GHz Amplitude	±0.8 dB	
Radiated Spurious Emissions	30 MHz to 1 GHz	± 5.2 dB	
	1 GHz to 40GHz	± 6.3 dB	

Measurement Uncertainty Decision Rule

Determination of conformity with the specification limits is based on the decision rule according to IEC Guide 115: 2007, clause 4.4.3 and 4.5.1.



SECTION 4

ACCREDITATION, DISCLAIMERS AND COPYRIGHT



4.1 ACCREDITATION, DISCLAIMERS AND COPYRIGHT



Testing Laboratory
Certificate #2955.19

This report relates only to the actual item/items tested.

This report does not imply product endorsement by any government, accreditation agency, or TÜV SÜD Canada Inc.

Opinions or interpretations expressed in this report, if any, are outside the scope of TÜV SÜD Canada Inc. accreditations. Any opinions expressed do not necessarily reflect the opinions of TÜV SÜD Canada Inc., unless otherwise stated.

This report relates only to the actual item/items tested

© 2021 TÜV SÜD



4.2 MODULE LIST

Configuration			
Product	Product No	R-State	Serial No
CT11	LPC 102 494/1	R2A	T01G495060
SUP 6601	1/BFL 901 009/1	R3B	BR81278870
IRU 2242	KRC 161 444/3	R1C	D826463200
RD 4442 B25B66A (EUT)	KRY 901 386/1	R1B	TD3T308261
Software Version:	CXP 901 3268/14	Revision:	R79JC