



Product Service

**Choose certainty.
Add value.**

Report On

FCC and IC Testing of the
Ericsson Remote Radio Unit WCDMA and LTE RD 4442 B25B66A, KRY 901
386/1 and RD 2243 B25, KRY 901 402/1 (1900 MHz), with compatible Main Unit
in a Base Station configuration in accordance with FCC CFR 47 Part 2, FCC
CFR 47 Part 24, Industry Canada RSS-GEN and Industry Canada RSS-133

COMMERCIAL-IN-CONFIDENCE

FCC ID: TA8AKRY901386-1
IC: 287AB-AS9013861
FCC ID: TA8AKRY901402-1
IC: 287AB-AS9014021

PREPARED BY

Maggie Whiting
Key Account Manager

APPROVED BY

Scott Drysdale
Authorised Signatory

DATED

11/16.2017

November 2017





CONTENTS

Section	Page No
1	REPORT INFORMATION 3
1.1	Report Details 4
1.2	Brief Summary of Results 5
1.3	Configuration Description 6
1.4	Declaration of Build Status 8
2	MAIN EUT 8
1.5	Product Information 10
1.6	Test Setup 11
1.7	Test Conditions 12
1.8	Deviation From The Standard 12
1.9	Modification Record 12
1.10	Alternative Test Site 12
1.11	Additional Information 12
3	TEST DETAILS 13
2.1	Maximum Peak Output Power and Peak to Average Ratio - Conducted 14
2.2	Occupied Bandwidth 42
2.3	Band Edge 62
2.4	Transmitter Spurious Emissions 93
2.5	Frequency Stability 180
4	TEST EQUIPMENT USED 182
3.1	Test Equipment Used 183
3.2	Measurement Uncertainty 185
5	ACCREDITATION, DISCLAIMERS AND COPYRIGHT 186
4.1	Accreditation, Disclaimers and Copyright 187
ANNEX A	Module Lists A.2



Product Service

SECTION 1

REPORT INFORMATION



Product Service

1.1 REPORT DETAILS

Manufacturer	Ericsson
Address	349 Terry Fox Drive Ottawa Ontario K2K 2V6 Canada
Product Name	RD 4442 B25B66A
Product Number	KRY 901 386/1
IC Model Name	287AB-AS9013861
Serial Number(s)	TD3T308275
Software Version	R65FH08
Hardware Version	R1A
Non-Tested Variant	RD 2243 B25 – KRY 901 402/1
Test Specification/Issue/Date	FCC CFR 47 Part 2: 2016 FCC CFR 47 Part 24: 2016 Industry Canada RSS-GEN: Issue 4: 2014 Industry Canada RSS-133: Issue 6: 2013
Start of Test	10 October 2017
Finish of Test	23 October 2017
Name of Test Personnel(s)	Scott Drysdale
Related Document(s)	KDB 971168 D01 v02r02 KDB 662911 D01 v02r01



Product Service

1.2 BRIEF SUMMARY OF RESULTS

A brief summary of results for each configuration, in accordance with FCC CFR 47 Part 2, FCC CFR 47 Part 24, Industry Canada RSS-GEN and Industry Canada RSS-133 is shown below.

Section	Specification Clause				Test Description	Result
	FCC CFR 47 Part 2	FCC CFR 47 Part 24	RSS-GEN	RSS-133		
2.1	2.1046	24.232 (a)	-	6.4	Maximum Peak Output Power, ERP, and Peak to Average Ratio - Conducted	Pass
2.2	2.1049	24.238 (b)	6.6	-	Occupied Bandwidth	Pass
2.3	2.1051	24.238 (b)	-	6.5	Band Edge	Pass
2.4	2.1051	24.238 (a)	-	6.5	Transmitter Spurious Emissions	Pass
2.5	2.1055	24.235	-	6.3	Frequency Stability	Pass
-	-	15.111	-		Receiver Spurious Emissions	N/A ¹

N/A¹ – Not Applicable, as this is a transceiver.



1.3 CONFIGURATION DESCRIPTION

The RD 4442 B25B66A / KRY 901 386/1 supports Single, Multi Carrier and Mixed Mode operation from either a single or dual port configuration.

The RD 4442 B25B66A supports LTE Test Models E-TM1.1, E-TM3.1, E-TM3.1a E-TM3.2 and WCDMA Test Models TM1, TM5 and TM6 in Band 2 (1930 MHz – 1995 MHz).

The LTE Test Models (as defined in 3GPP TS 36.141) E-TM1.1, E-TM3.1, E-TM3.1a and E-TM3.2 were used to represent QPSK, 64QAM, 256QAM and 16QAM modulation respectively.

The WCDMA Test Models (as defined in 3GPP TS 25.141) TM1, TM5 and TM6 were used to represent QPSK, 16QAM and 64QAM modulation respectively.

The RD 4442 B25B66A has been tested and authorized for LTE and WCDMA SC, MC and MM transmission. The Test Model used, unless otherwise stated, for LTE was E-TM1.1 and WCDMA TM5.

TX test cases: Maximum Conducted Output Power, Spurious Emissions at Antenna Terminals (± 1 MHz) and Conducted Spurious Emissions, measurements were performed on both RF Ports using a test limit accounting for MIMO operation with 4 ports. All RF ports were tested for RF Carrier Power and results recorded using the Measure and Sum approach to account for MIMO operation. The test limits shown are representative of the worst case. All testing was performed with the EUT transmitting at maximum RF power unless otherwise stated.

The EUT was powered via POE (Power Over Ethernet) from the IRU 2242 using a -48V DC Power supply.

WCDMA B25 (1930 MHz – 1995 MHz) Channel Configurations

All tests except MC Band Edge Emissions

Configuration	RAT	No. of Carriers	Carrier Bandwidth (MHz)	Carrier Frequency Configuration (MHz)		
				Bottom (BRFBW)	Middle (MRFBW)	Top (TRFBW)
1	W	1	5 / 4.2	1932.4	1962.4	1992.6
2	W	2	5	1932.4 + 1937.4	1960.0 + 1965.0	1987.6 + 1992.6
3	W	4	5	1932.4 + 1937.4 + 1942.4 + 1947.4	1955.0 + 1960.0 + 1965.00 + 1970.00	1977.6 + 1982.6 + 1987.60 + 1992.60

Table 1

MC Band Edge Emissions

Configuration	RAT	No. of Carriers	Carrier Bandwidth (MHz)	Carrier Frequency Configuration (MHz)	
				BRFBW (Bottom Edge)	TRFBW (Top Edge)
2 (BE)	W	2	5	1932.4 + 1937.4	1987.6 + 1992.6

Table 2



LTE B25 (1930 MHz – 1995 MHz) Channel Configurations

All tests except MC Band Edge Emissions

Configuration	RAT	No. of Carriers	Carrier Bandwidth (MHz)	Carrier Frequency Configuration (MHz)		
				Bottom (BRFBW)	Middle (MRFBW)	Top (TRFBW)
4	L	1	5	1932.5	1962.5	1992.5
4	L	1	10	1935	1962.5	1990.0
4	L	1	15	1937.5	1962.5	1987.5
4	L	1	20	1940	1962.5	1985.0
5	L	2	5	1932.5 + 1937.5	1960.0 + 1965.0	1987.5 + 1992.5
5	L	2	10	1935.0 + 1945.0	1957.5 + 1967.5	1980.0 + 1990.0
5	L	2	15	1937.5 + 1952.5	1955.0 + 1970.0	1972.5 + 1987.5
5	L	2	20	1940.0 + 1960.0	1952.5 + 1972.5	1965.0 + 1985.0

Table 3

MC Band Edge Emissions

Configuration	RAT	No. of Carriers	Carrier Bandwidth (MHz)	Carrier Frequency Configuration (MHz)	
				BRFBW (Bottom Edge)	TRFBW (Top Edge)
5 (BE)	L	2	5	1932.5 + 1937.5	1987.5 + 1992.5
5 (BE)	L	2	10	1935 + 1945	1980.0 + 1990.0
5 (BE)	L	2	15	1937.5 + 1952.5	1972.5 + 1987.5
5 (BE)	L	2	20	1940 + 1960	1965.0 + 1985.0

Table 4

WCDMA/LTE (MM) B25 (1930 MHz – 1995 MHz) Channel Configurations

All tests except Band Edge Emissions

Configuration	RAT	No. of Carriers	Carrier Bandwidth (MHz)	Carrier Frequency Configuration (MHz)		
				BRFBW	MRFBW	TRFBW
6	W + L	2	5 + 15	-	1955.0 (W) + 1965.0 (L)	-
7	W + W + W + W + L + L	6	5 + 5 + 5 + 5 + 10 + 10	-	1950.0 (W) + 1955.0 (W) + 1960.0 (W) + 1965.0 (W) + 1970 (L) + 1975 (L)	-

Table 5

Band Edge Emissions

Configuration	RAT	No. of Carriers	Carrier Bandwidth (MHz)	Carrier Frequency Configuration (MHz)	
				BRFBW (Bottom Edge)	TRFBW (Top Edge)
6 (BE)	W + L	2	5 + 5	1932.4 (W) + 1937.4 (L)	1992.5 (L) + 1987.6 (W)

Table 6



1.4 DECLARATION OF BUILD STATUS

MAIN EUT	
MANUFACTURING DESCRIPTION	Radio Dot
MANUFACTURER	Ericsson
TYPE	Remote Radio Base Station
PART NUMBER	RD 4442 B25B66A: KRY 901 386/1 RD 2243 B25: KRY 901 402/1 RD 2243 B66A: KRY 901 404/1
SERIAL NUMBER	TD3T308275 (for RD 4442 B25B66A)
HARDWARE VERSION	R1A
SOFTWARE VERSION	R65FH08
TRANSMITTER OPERATING RANGE	B25 1930 – 1995 MHz B66A 2110 – 2180 MHz
RECEIVER OPERATING RANGE	B25 1850 – 1915 MHz B66A 1710 – 1780 MHz
COUNTRY OF ORIGIN	China
INTERMEDIATE FREQUENCIES	DL: 110 – 150MHz, UL: 40 – 80MHz
EMISSION DESIGNATOR(S): (i.e. G1D, GXW)	LTE 5M00 W7D 10M0 W7D 15M0 W7D 20M0 W7D WCDMA 5M00 F9W
MODULATION TYPES: (i.e. GMSK, QPSK)	LTE: QPSK, 16QAM, 64QAM, 256QAM WCDMA: QPSK, 16QAM, 64QAM
HIGHEST INTERNALLY GENERATED FREQUENCY	2.2 GHz
OUTPUT POWER (W or dBm)	4x 0.05 W (17dBm)
FCC ID	Tested EUT: TA8AKRY901386-1 Non-tested variant: TA8AKRY901402-1 Non-tested variant: TA8AKRY901404-1
INDUSTRY CANADA ID	Tested EUT: 287AB-AS9013861 Non-tested variant: 287AB-AS9014021 Non-tested variant: 287AB-AS9014041
TECHNICAL DESCRIPTION (a brief description of the intended use and operation)	<p>The RD 4442 B25B66A (KRY 901 386/1) is a dual band Remote Radio Unit forming part of the Ericsson Radio Base Station (RBS) equipment. The RD provides radio access for mobile and fixed devices and is intended for the indoor environment. The radio operates over 4 Transmit ports in MRO;Single, Multi-Carrier, and MIMO transmission with a maximum rated RF Output of 0.050W per port over an operational temperature of 5°C to +40°C. The unit is designed to be ceiling mounted.</p> <p>The RD 2243 B25 product is a single band radio identical to the dual band RD 4442 B25B66A product except that B66A circuits have been de-populated.</p> <p>The RD 2243 B66A product is a single band radio identical to the dual band RD 4442 B25B66A product except that B25 circuits have been de-populated.</p>



Product Service

Signature:

A handwritten signature in blue ink, appearing to be 'D. Lalonde', written over a dotted line.

Denis Lalonde

Date: 25 October 2017

Declaration of Build Status Serial Number: TD3T308275

No responsibility will be accepted by TÜV SÜD Product Service UK Limited as to the accuracy of the information declared in this document by the manufacturer.

1.5 PRODUCT INFORMATION

1.5.1 Technical Description

The Equipment Under Test (EUT) RD 4442 B25B66A - KRY 901 386/1 is an Ericsson AB Radio Unit working in the public mobile service 1900 and 2100 MHz band which provides communication connections to 1900 and 2100 MHz network. The RD 4442 B25B66A - KRY 901 386/1 operates from a -48V DC supply.

The RD 2243 B25 product is a single band radio identical to the dual band RD 4442 B25B66A product except that B66A circuits have been depopulated.

The Equipment Under Test (EUT) is shown in the photograph below. A full technical description can be found in the Manufacturer's documentation.



Equipment Under Test



Product Service

1.6 TEST SETUP

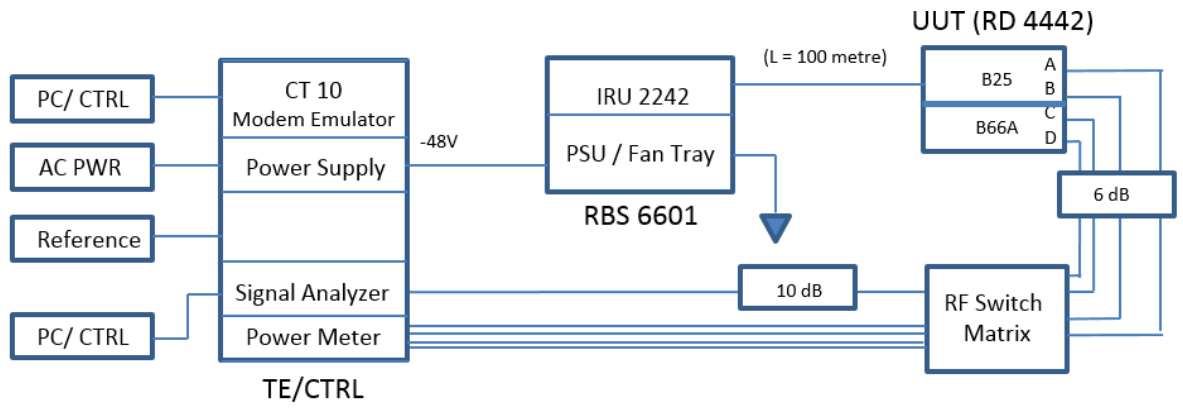



1.7 TEST CONDITIONS

For all tests, the EUT was set up in accordance with the relevant test standard and to represent typical operating conditions. Tests were applied with the EUT situated in a shielded enclosure, test laboratories or a chamber as appropriate.

The EUT was powered from a -48V DC supply.

FCC Measurement Facility Accreditation Designation Number: CA6845
TUV SUD Canada (Laval)

1.8 DEVIATION FROM THE STANDARD

No deviations from the applicable test standards or test plan were made during testing.

1.9 MODIFICATION RECORD

No modifications were made to the EUT during testing.

1.10 ALTERNATIVE TEST SITE

Under our Accreditation, TÜV SÜD Canada, Laval conducted the following tests at Ericsson in Ottawa.

Test Name	Name of Test Personnel(s)
Maximum Peak Output Power and Peak to Average Ratio - Conducted	Scott Drysdale
Occupied Bandwidth	Scott Drysdale
Band Edge	Scott Drysdale
Transmitter Spurious Emissions	Scott Drysdale
Frequency Stability	Scott Drysdale

1.11 ADDITIONAL INFORMATION

Testing performed with Gavin Gan and Denis Lalonde of Ericsson - Ottawa.

The RD 4442 B25B66A (KRY 901 386/1) is a dual band Remote Radio Unit forming part of the Ericsson Radio Base Station (RBS) equipment. The RD provides radio access for mobile and fixed devices and is intended for the indoor environment. The radio operates over 4 Transmit ports in MRO, Single, Multi-Carrier, and MIMO transmission with a maximum rated RF Output of 0.050W per port over an operational temperature of 5°C to +40°C. The unit is designed to be ceiling mounted.

The RD 2243 B25 product is a single band radio identical to the dual band RD 4442 B25B66A product except that B66A circuits have been de-populated.

The RD 2243 B66A product is a single band radio identical to the dual band RD 4442 B25B66A product except that B25 circuits have been de-populated.



Product Service

SECTION 2

TEST DETAILS



2.1 MAXIMUM PEAK OUTPUT POWER AND PEAK TO AVERAGE RATIO - CONDUCTED

2.1.1 Specification Reference

FCC CFR 47 Part 2, Clause 2.1046
 FCC CFR 47 Part 24, Clause 24.232 (a)
 Industry Canada RSS-133, Clause 6.4

2.1.2 Date of Test and Modification State

11,12, 13, 16 October 2017 - Modification State 0

2.1.3 Test Equipment Used

The major items of test equipment used for the above tests are identified in Section 3.1.

2.1.4 Environmental Conditions

Ambient Temperature 23°C
 Relative Humidity 50%

2.1.5 Test Method

All measurements were made in accordance with FCC KDB 971168 D01, clause 5.2.1 and summed in accordance with FCC KDB 662911 D01.

2.1.6 Test Results

Configuration 1

Maximum Output Power 17 dBm

Antenna	WCDMA Modulation	WCDMA Carrier Bandwidth	Peak to Average Ratio (PAR) / Output Power		
			PAR (dB)	Channel Position B	
				Average Power	
			dBm	dBm/MHz	
A	16QAM	5.0 MHz	7.10	16.27	11.03
B	16QAM	5.0 MHz	7.08	16.40	11.33
Total			-	19.35	14.19

Maximum Output Power 18.8 dBm (Including 1.8 dBi Antenna Gain)

Antenna	WCDMA Modulation	WCDMA Carrier Bandwidth	Peak to Average Ratio (PAR) / Output Power		
			PAR (dB)	Channel Position B	
				EIRP	
			dBm	dBm/MHz	
A	16QAM	5.0 MHz	7.10	18.07	12.83
B	16QAM	5.0 MHz	7.08	18.2	13.13
Total			-	21.15	15.99



Product Service

WCDMA Modulation 16QAM - WCDMA Carrier Bandwidth 5.0 MHz - Antenna A

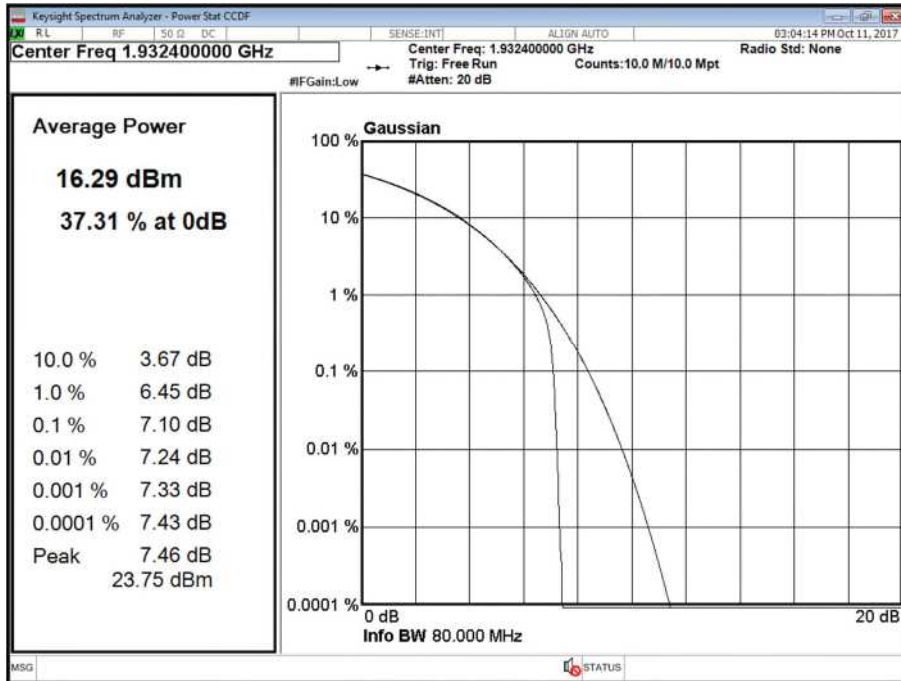

WCDMA Modulation 16QAM - WCDMA Carrier Bandwidth 5.0 MHz - Antenna B

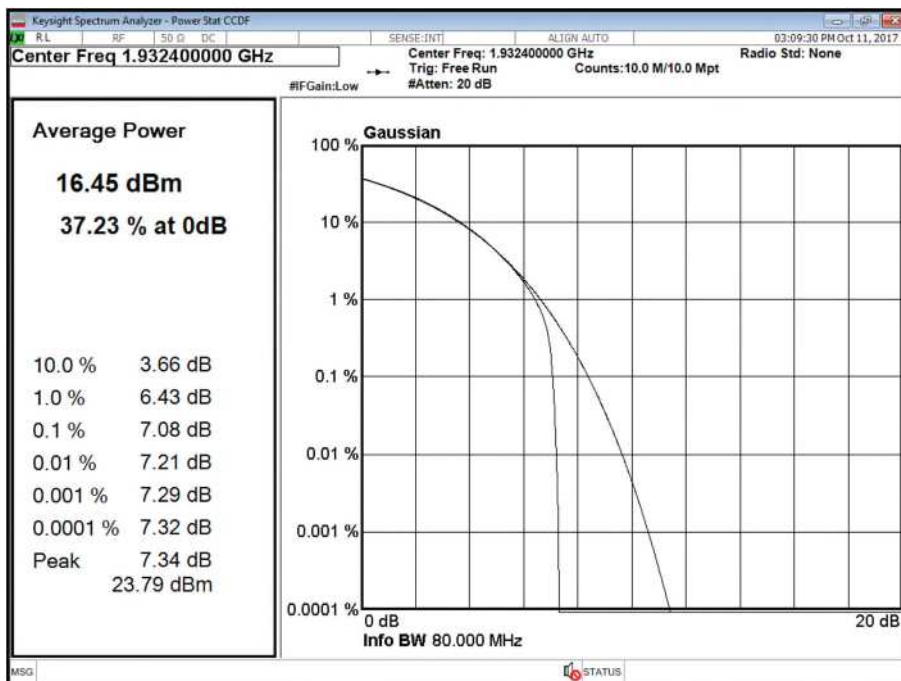



Product Service

Configuration 1

Maximum Output Power 17 dBm

Antenna	WCDMA Modulation	WCDMA Carrier Bandwidth	Peak to Average Ratio (PAR) / Output Power		
			Channel Position M		
			PAR (dB)	Average Power	
dBm	dBm/MHz				
A	16QAM	5.0 MHz	7.14	16.09	10.88
B	16QAM	5.0 MHz	7.11	16.26	11.05
Total			-	19.19	13.98

Maximum Output Power 18.8 dBm (Including 1.8 dBi Antenna Gain)

Antenna	WCDMA Modulation	WCDMA Carrier Bandwidth	Peak to Average Ratio (PAR) / Output Power		
			Channel Position M		
			PAR (dB)	EIRP	
dBm	dBm/MHz				
A	16QAM	5.0 MHz	7.14	17.89	12.68
B	16QAM	5.0 MHz	7.11	18.06	12.85
Total			-	20.99	15.78

WCDMA Modulation 16QAM - WCDMA Carrier Bandwidth 5.0 MHz - Antenna A

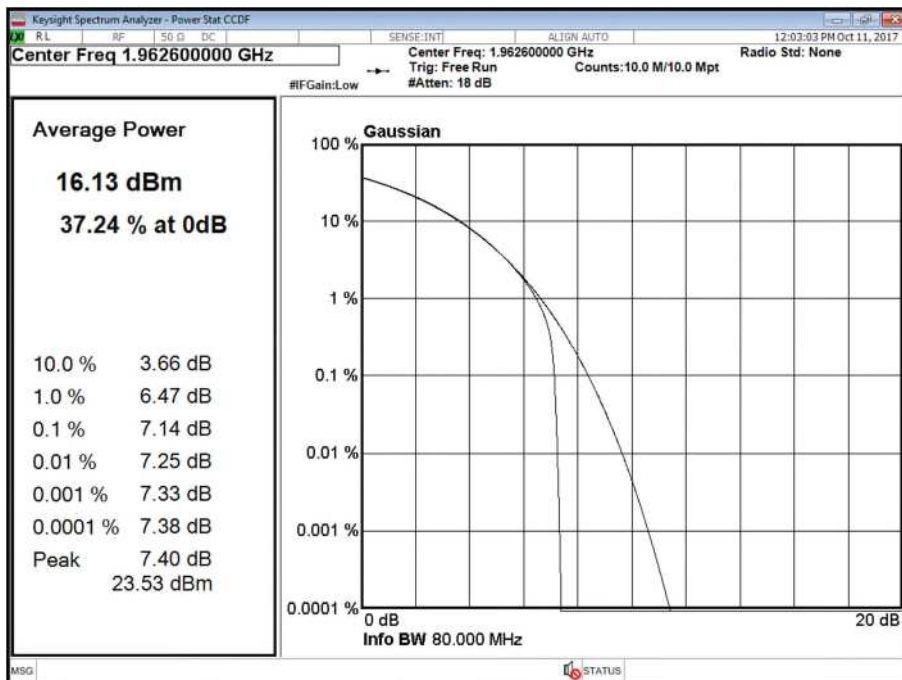



Product Service

WCDMA Modulation 16QAM - WCDMA Carrier Bandwidth 5.0 MHz - Antenna B

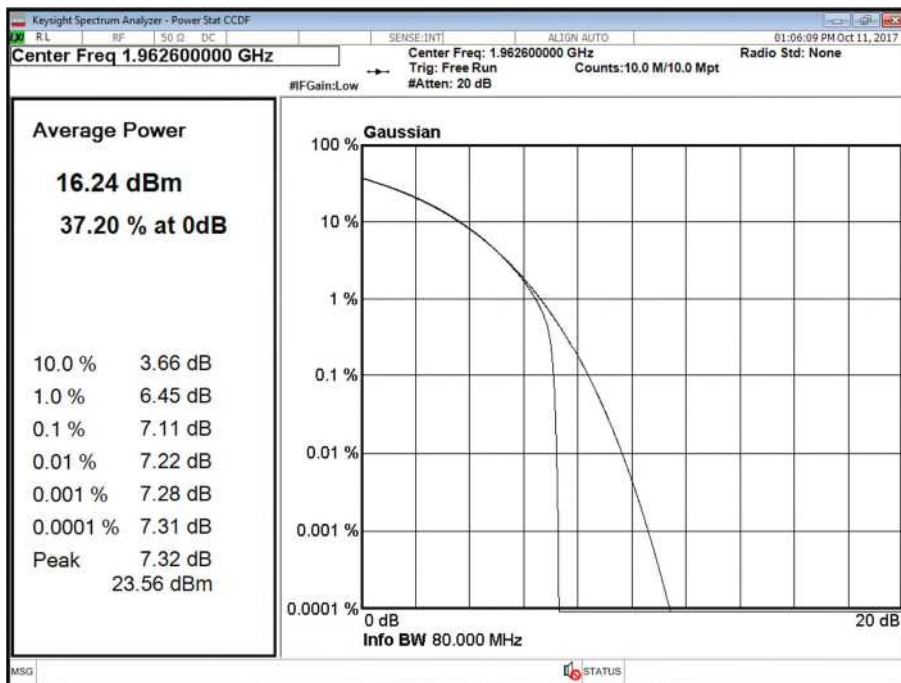

Configuration 1

Maximum Output Power 17 dBm

Antenna	WCDMA Modulation	WCDMA Carrier Bandwidth	Peak to Average Ratio (PAR) / Output Power		
			PAR (dB)	Channel Position T	
				Average Power	
			dBm	dBm/MHz	
A	16QAM	5.0 MHz	7.11	15.98	11.02
B	16QAM	5.0 MHz	7.10	16.10	11.01
Total			-	19.05	14.03

Maximum Output Power 18.8 dBm (Including 1.8 dBi Antenna Gain)

Antenna	WCDMA Modulation	WCDMA Carrier Bandwidth	Peak to Average Ratio (PAR) / Output Power		
			PAR (dB)	Channel Position T	
				EIRP	
			dBm	dBm/MHz	
A	16QAM	5.0 MHz	7.11	17.78	12.82
B	16QAM	5.0 MHz	7.10	17.90	12.81
Total			-	20.85	15.83



Product Service

WCDMA Modulation 16QAM - WCDMA Carrier Bandwidth 5.0 MHz - Antenna A

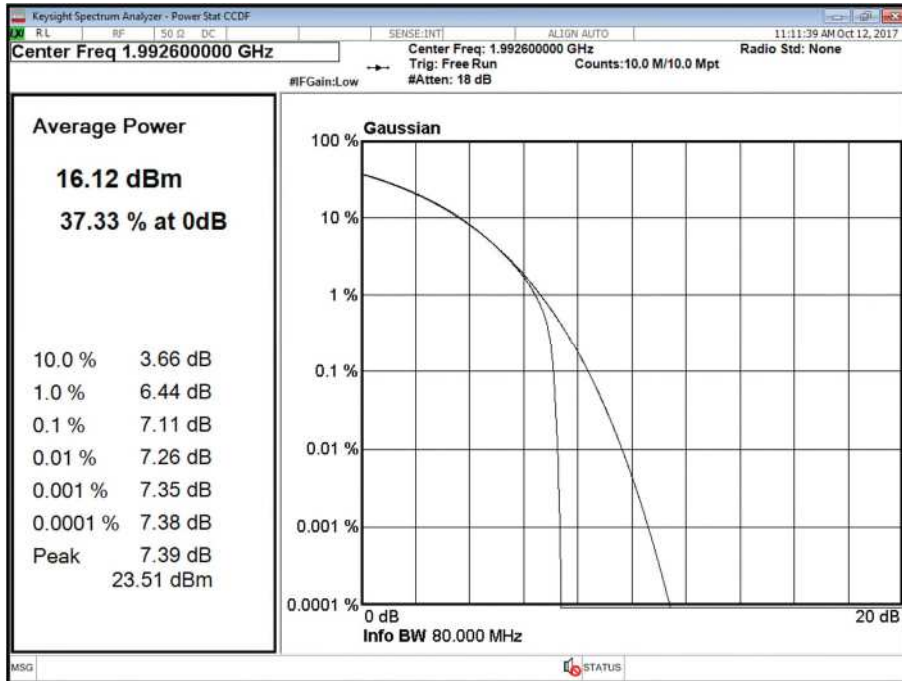

WCDMA Modulation 16QAM - WCDMA Carrier Bandwidth 5.0 MHz - Antenna B

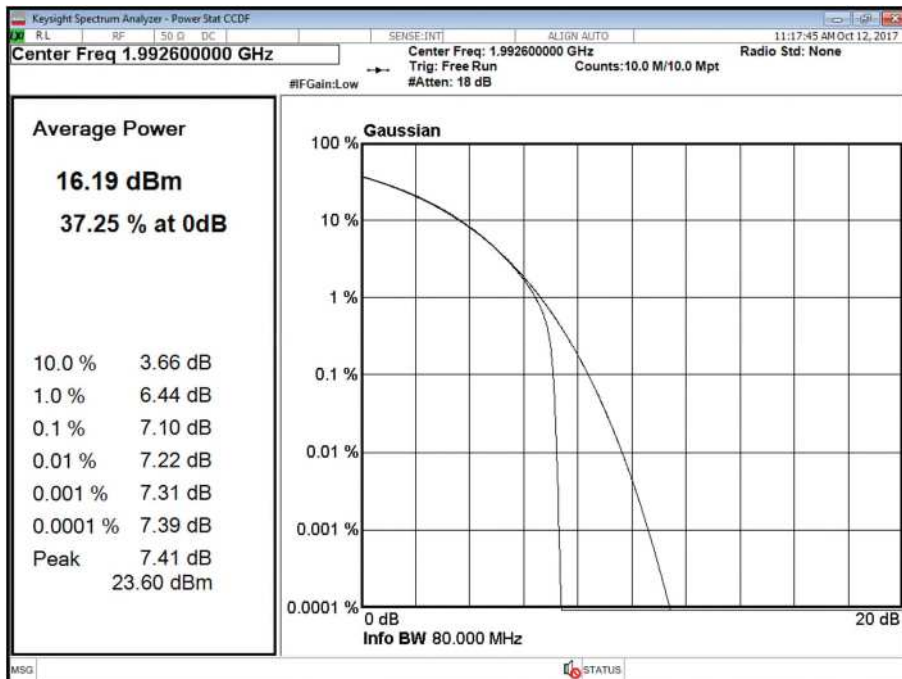



Product Service

Configuration 2 – Channel B

Maximum Output Power 17 dBm

Antenna	WCDMA Modulation	WCDMA Carrier Bandwidth	Peak to Average Ratio (PAR) / Output Power		
			Channel Position B		
			PAR (dB)	Average Power	
dBm	dBm/MHz				
A	16QAM	5.0 MHz	-	16.53	9.13
B	16QAM	5.0 MHz	-	16.43	8.81
Total			-	19.49	11.98

Maximum Output Power 18.8 dBm (Including 1.8 dBi Antenna Gain)

Antenna	WCDMA Modulation	WCDMA Carrier Bandwidth	Peak to Average Ratio (PAR) / Output Power		
			Channel Position B		
			PAR (dB)	EIRP	
dBm	dBm/MHz				
A	16QAM	5.0 MHz	-	18.33	10.93
B	16QAM	5.0 MHz	-	18.23	10.61
Total			-	21.29	13.78

Configuration 2 – Channel M

Maximum Output Power 17 dBm

Antenna	WCDMA Modulation	WCDMA Carrier Bandwidth	Peak to Average Ratio (PAR) / Output Power		
			Channel Position M		
			PAR (dB)	Average Power	
dBm	dBm/MHz				
A	16QAM	5.0 MHz	-	16.46	8.09
B	16QAM	5.0 MHz	-	16.52	8.72
Total			-	19.50	11.4

Maximum Output Power 18.8 dBm (Including 1.8 dBi Antenna Gain)

Antenna	WCDMA Modulation	WCDMA Carrier Bandwidth	Peak to Average Ratio (PAR) / Output Power		
			Channel Position M		
			PAR (dB)	EIRP	
dBm	dBm/MHz				
A	16QAM	5.0 MHz	-	18.26	9.89
B	16QAM	5.0 MHz	-	18.32	10.52
Total			-	21.30	13.20



Product Service

Configuration 2 – Channel T

Maximum Output Power 17 dBm

Antenna	WCDMA Modulation	WCDMA Carrier Bandwidth	Peak to Average Ratio (PAR) / Output Power		
			Channel Position T		
			PAR (dB)	Average Power	
dBm	dBm/MHz				
A	16QAM	5.0 MHz		16.13	8.06
B	16QAM	5.0 MHz		16.30	8.31
Total			-	19.23	11.2

Maximum Output Power 18.8 dBm (Including 1.8 dBi Antenna Gain)

Antenna	WCDMA Modulation	WCDMA Carrier Bandwidth	Peak to Average Ratio (PAR) / Output Power		
			Channel Position T		
			PAR (dB)	EIRP	
dBm	dBm/MHz				
A	16QAM	5.0 MHz		17.93	9.86
B	16QAM	5.0 MHz		18.10	10.11
Total			-	21.03	13.00

Configuration 3

Maximum Output Power 17 dBm

Antenna	WCDMA Modulation	WCDMA Carrier Bandwidth	Peak to Average Ratio (PAR) / Output Power		
			Channel Position B		
			PAR (dB)	Average Power	
dBm	dBm/MHz				
A	16QAM	5.0 MHz		16.47	5.76
B	16QAM	5.0 MHz		16.53	6.21
Total			-	19.51	8.99

Maximum Output Power 18.8 dBm (Including 1.8 dBi Antenna Gain)

Antenna	WCDMA Modulation	WCDMA Carrier Bandwidth	Peak to Average Ratio (PAR) / Output Power		
			Channel Position B		
			PAR (dB)	EIRP	
dBm	dBm/MHz				
A	16QAM	5.0 MHz		18.27	7.56
B	16QAM	5.0 MHz		18.33	8.01
Total			-	21.31	10.79



Product Service

Configuration 3

Maximum Output Power 17 dBm

Antenna	WCDMA Modulation	WCDMA Carrier Bandwidth	Peak to Average Ratio (PAR) / Output Power		
			Channel Position M		
			PAR (dB)	Average Power	
dBm	dBm/MHz				
A	16QAM	5.0 MHz		16.45	5.28
B	16QAM	5.0 MHz		16.39	5.7
Total			-	19.43	8.49

Maximum Output Power 18.8 dBm (Including 1.8 dBi Antenna Gain)

Antenna	WCDMA Modulation	WCDMA Carrier Bandwidth	Peak to Average Ratio (PAR) / Output Power		
			Channel Position M		
			PAR (dB)	EIRP	
dBm	dBm/MHz				
A	16QAM	5.0 MHz		18.25	7.08
B	16QAM	5.0 MHz		18.19	7.50
Total			-	21.23	10.29

Configuration 3

Maximum Output Power 17 dBm

Antenna	WCDMA Modulation	WCDMA Carrier Bandwidth	Peak to Average Ratio (PAR) / Output Power		
			Channel Position T		
			PAR (dB)	Average Power	
dBm	dBm/MHz				
A	16QAM	5.0 MHz		16.20	5.43
B	16QAM	5.0 MHz		16.53	5.29
Total			-	19.38	8.36

Maximum Output Power 18.8 dBm (Including 1.8 dBi Antenna Gain)

Antenna	WCDMA Modulation	WCDMA Carrier Bandwidth	Peak to Average Ratio (PAR) / Output Power		
			Channel Position T		
			PAR (dB)	EIRP	
dBm	dBm/MHz				
A	16QAM	5.0 MHz		18.0	7.23
B	16QAM	5.0 MHz		18.33	7.09
Total			-	21.18	10.16



Product Service

Configuration 4

Maximum Output Power 17 dBm

Antenna	LTE Modulation	LTE Carrier Bandwidth	Peak to Average Ratio (PAR) / Output Power		
			Channel Position B		
			PAR (dB)	Average Power	
dBm	dBm/MHz				
A	QPSK	5.0 MHz	7.13	16.58	10.74
B	QPSK	5.0 MHz	7.12	16.29	10.47
Total			-	19.45	13.62
A	QPSK	10.0 MHz	7.23	16.43	8.13
B	QPSK	10.0 MHz	7.20	16.43	8.27
Total			-	19.44	11.21
A	QPSK	15.0 MHz	7.30	16.38	6.60
B	QPSK	15.0 MHz	7.27	16.52	6.78
Total			-	19.46	9.70
A	QPSK	20.0 MHz	7.29	16.32	5.29
B	QPSK	20.0 MHz	7.28	16.50	5.50
Total			-	19.42	8.41

Maximum Output Power 18.8 dBm (Including 1.8 dBi Antenna Gain)

Antenna	LTE Modulation	LTE Carrier Bandwidth	Peak to Average Ratio (PAR) / Output Power		
			Channel Position B		
			PAR (dB)	EIRP	
dBm	dBm/MHz				
A	QPSK	5.0 MHz	7.13	18.38	12.54
B	QPSK	5.0 MHz	7.12	18.09	12.27
Total			-	21.25	15.42
A	QPSK	10.0 MHz	7.23	18.23	9.93
B	QPSK	10.0 MHz	7.20	18.23	10.07
Total			-	21.24	13.01
A	QPSK	15.0 MHz	7.30	18.18	8.40
B	QPSK	15.0 MHz	7.27	18.32	8.58
Total			-	21.26	11.50
A	QPSK	20.0 MHz	7.29	18.12	7.09
B	QPSK	20.0 MHz	7.28	18.30	7.30
Total			-	21.22	10.21



Product Service

LTE Modulation QPSK - LTE Carrier Bandwidth 5.0 MHz - Antenna A

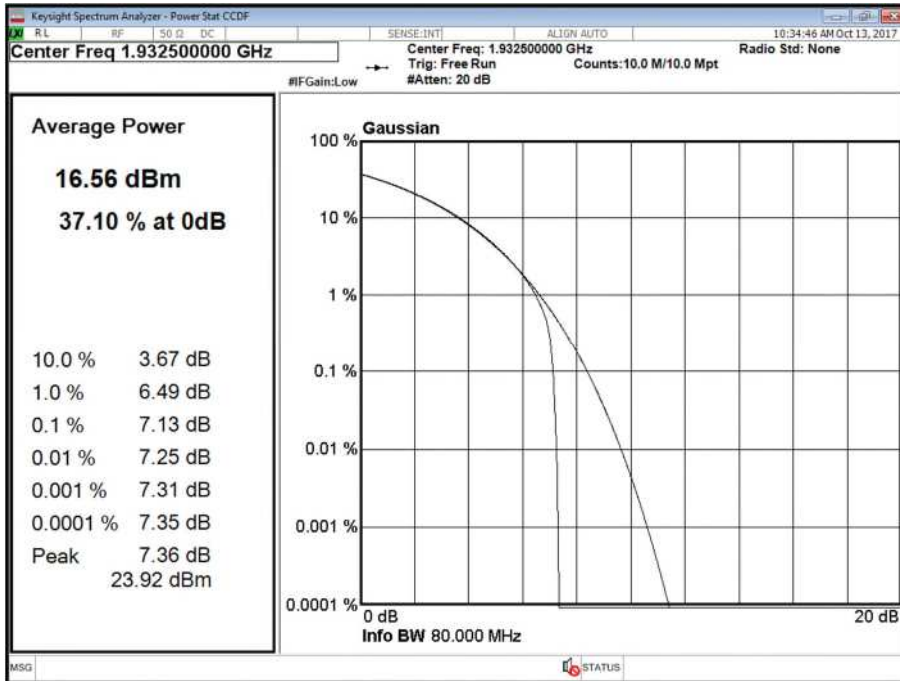

LTE Modulation QPSK - LTE Carrier Bandwidth 5.0 MHz - Antenna B

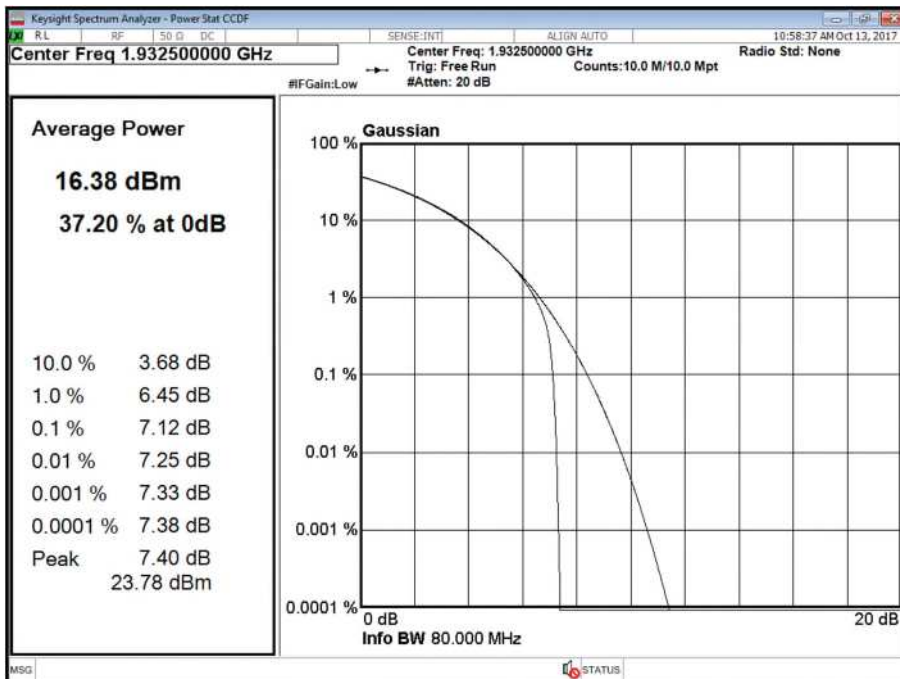



Product Service

LTE Modulation QPSK - LTE Carrier Bandwidth 10.0 MHz - Antenna A

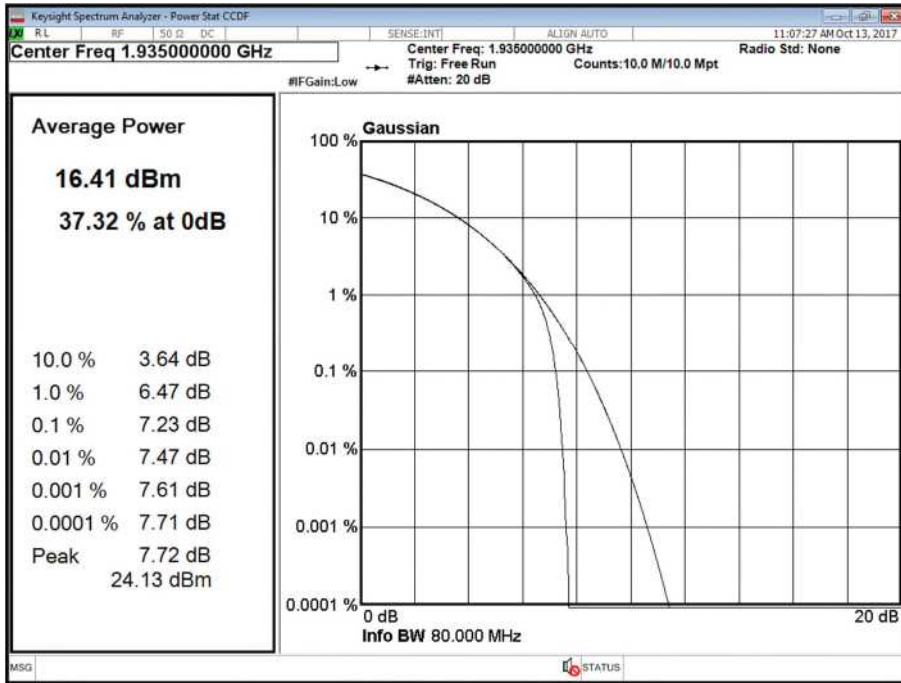

LTE Modulation QPSK - LTE Carrier Bandwidth 10.0 MHz - Antenna B

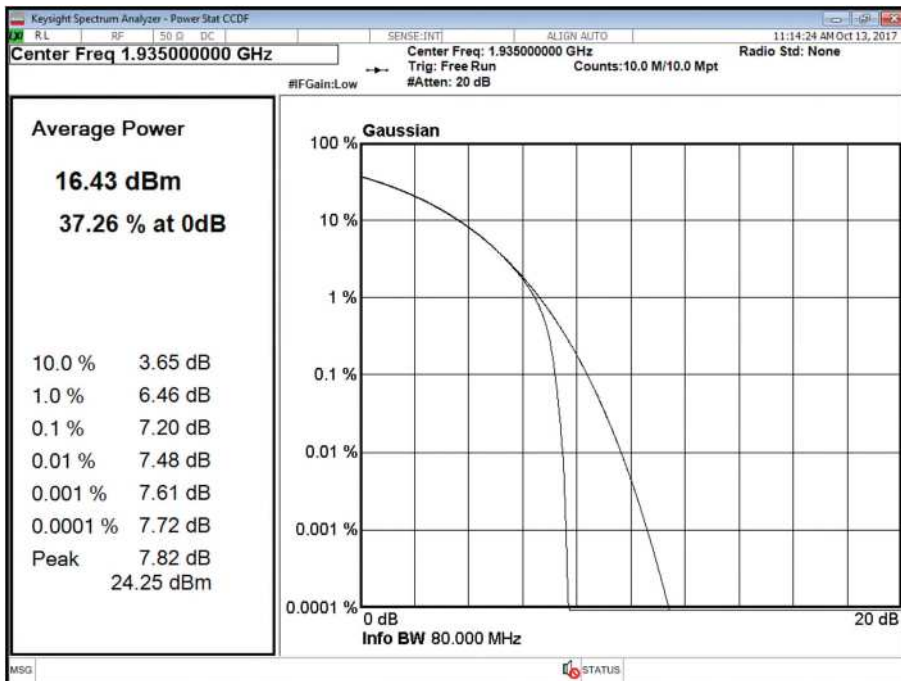



Product Service

LTE Modulation QPSK - LTE Carrier Bandwidth 15.0 MHz - Antenna A

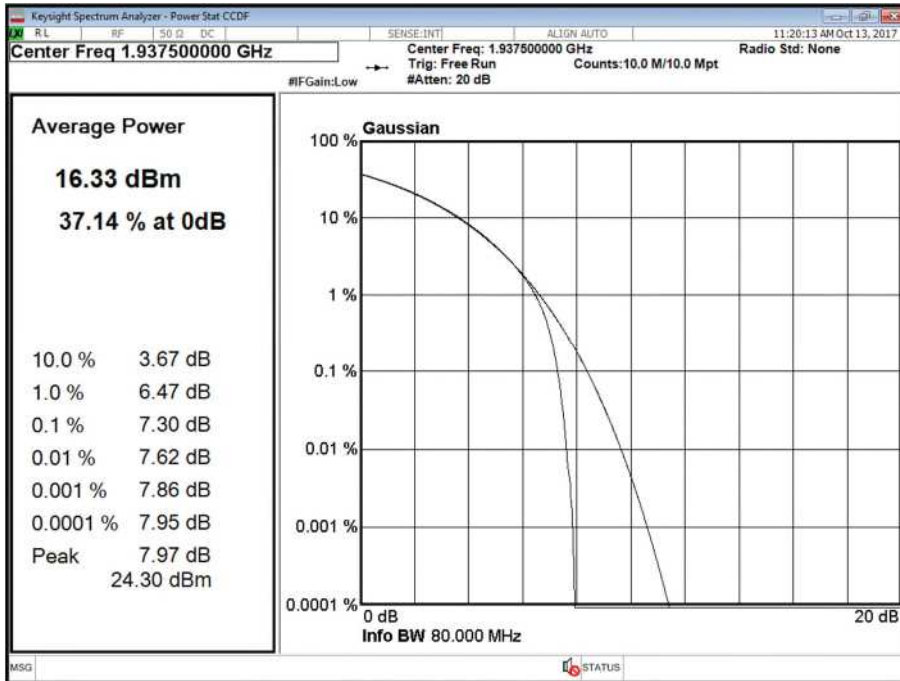

LTE Modulation QPSK - LTE Carrier Bandwidth 15.0 MHz - Antenna B

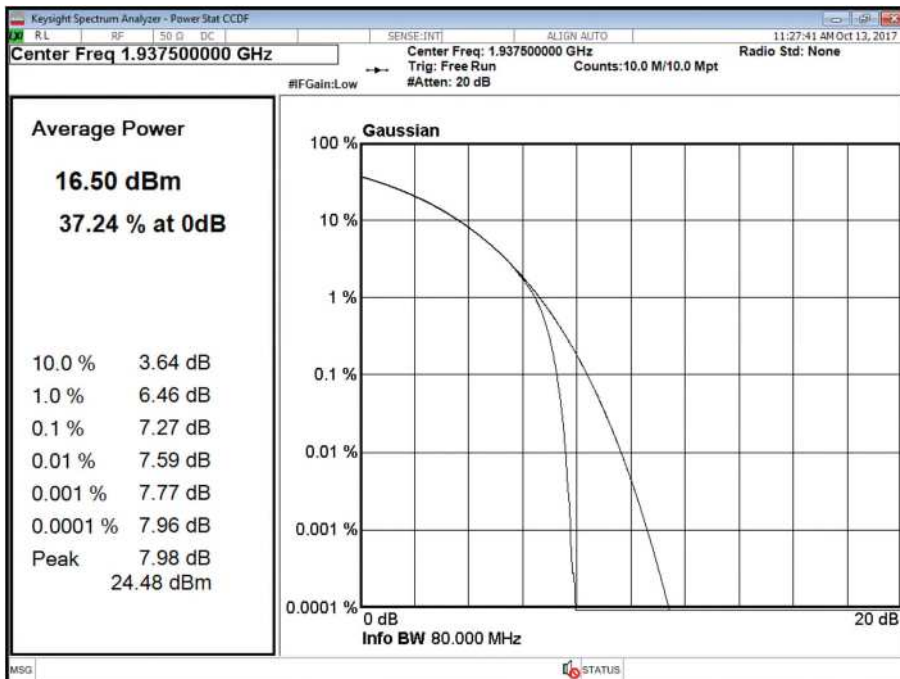



Product Service

LTE Modulation QPSK - LTE Carrier Bandwidth 20.0 MHz - Antenna A

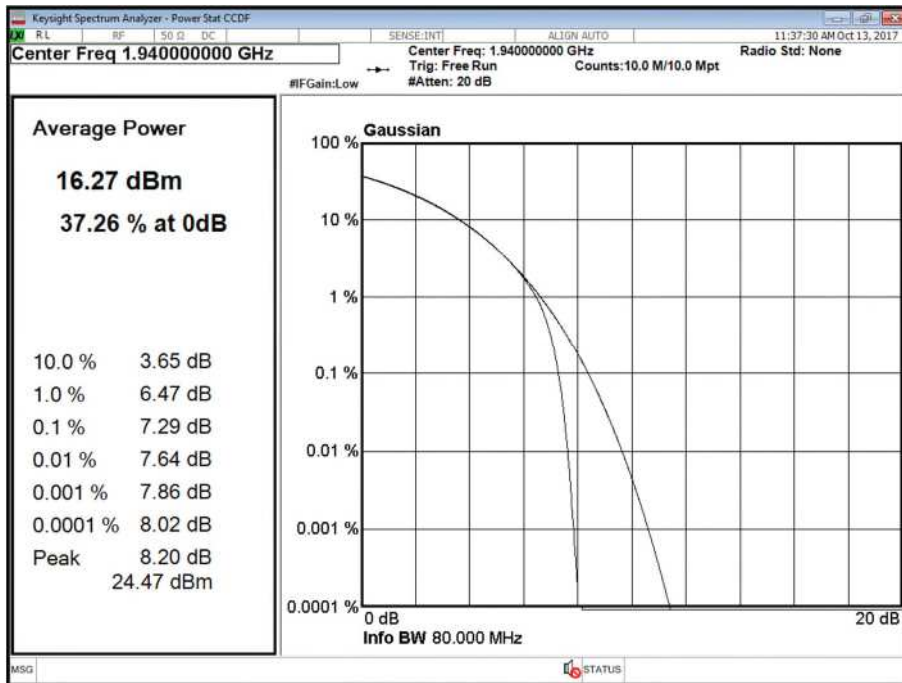

LTE Modulation QPSK - LTE Carrier Bandwidth 20.0 MHz - Antenna B

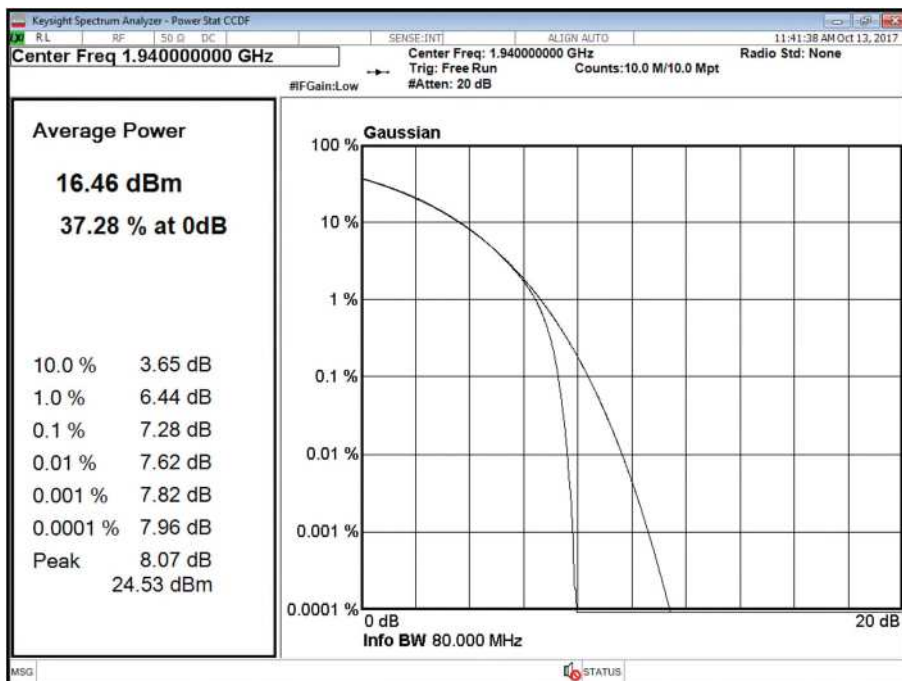



Product Service

Configuration 4

Maximum Output Power 17 dBm

Antenna	LTE Modulation	LTE Carrier Bandwidth	Peak to Average Ratio (PAR) / Output Power		
			Channel Position M		
			PAR (dB)	Average Power	
dBm	dBm/MHz				
A	QPSK	5.0 MHz	7.14	16.27	10.33
B	QPSK	5.0 MHz	7.16	16.42	10.49
Total			-	19.36	13.42
A	QPSK	10.0 MHz	7.20	16.37	7.76
B	QPSK	10.0 MHz	7.17	16.51	7.96
Total			-	19.45	10.87
A	QPSK	15.0 MHz	7.22	16.41	6.03
B	QPSK	15.0 MHz	7.21	16.55	6.42
Total			-	19.49	9.24
A	QPSK	20.0 MHz	7.19	16.18	4.59
B	QPSK	20.0 MHz	7.20	16.36	5.09
Total			-	19.28	7.86

Maximum Output Power 18.8 dBm (Including 1.8 dBi Antenna Gain)

Antenna	LTE Modulation	LTE Carrier Bandwidth	Peak to Average Ratio (PAR) / Output Power		
			Channel Position M		
			PAR (dB)	EIRP	
dBm	dBm/MHz				
A	QPSK	5.0 MHz	7.14	18.07	12.13
B	QPSK	5.0 MHz	7.16	18.22	12.29
Total			-	21.16	15.22
A	QPSK	10.0 MHz	7.20	18.17	9.56
B	QPSK	10.0 MHz	7.17	18.31	9.76
Total			-	21.25	12.67
A	QPSK	15.0 MHz	7.22	18.21	7.83
B	QPSK	15.0 MHz	7.21	18.35	8.22
Total			-	21.29	11.04
A	QPSK	20.0 MHz	7.19	17.98	6.39
B	QPSK	20.0 MHz	7.20	18.16	6.89
Total			-	21.08	9.66



Product Service

LTE Modulation QPSK - LTE Carrier Bandwidth 5.0 MHz - Antenna A

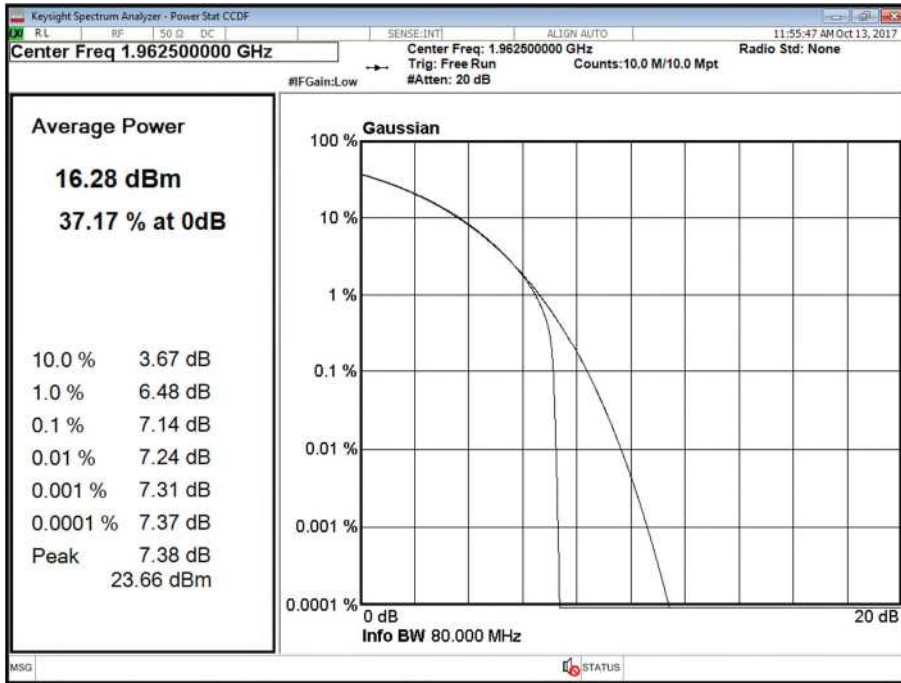

LTE Modulation QPSK - LTE Carrier Bandwidth 5.0 MHz - Antenna B

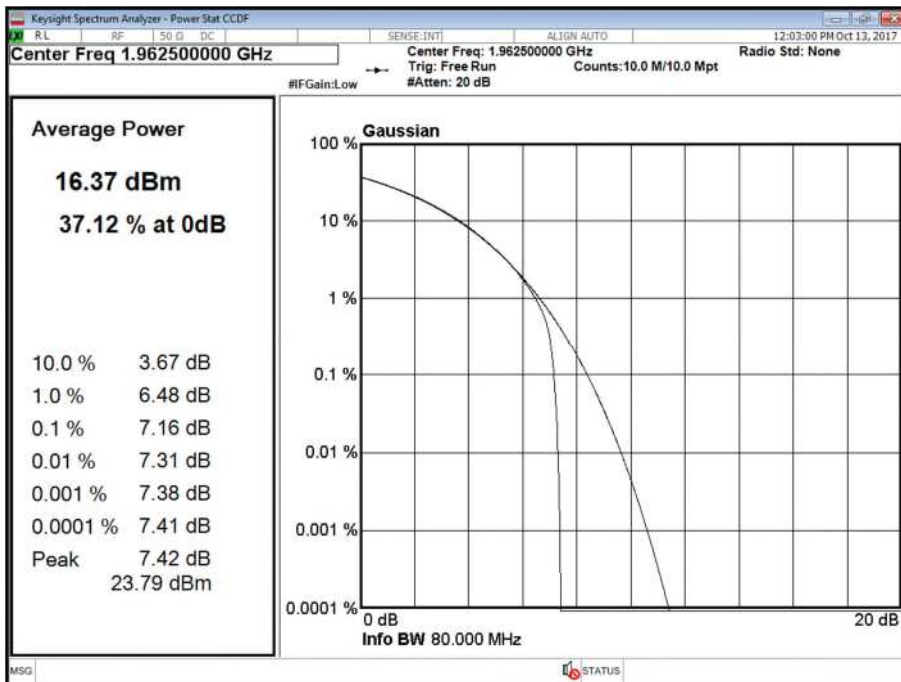



Product Service

LTE Modulation QPSK - LTE Carrier Bandwidth 10.0 MHz - Antenna A

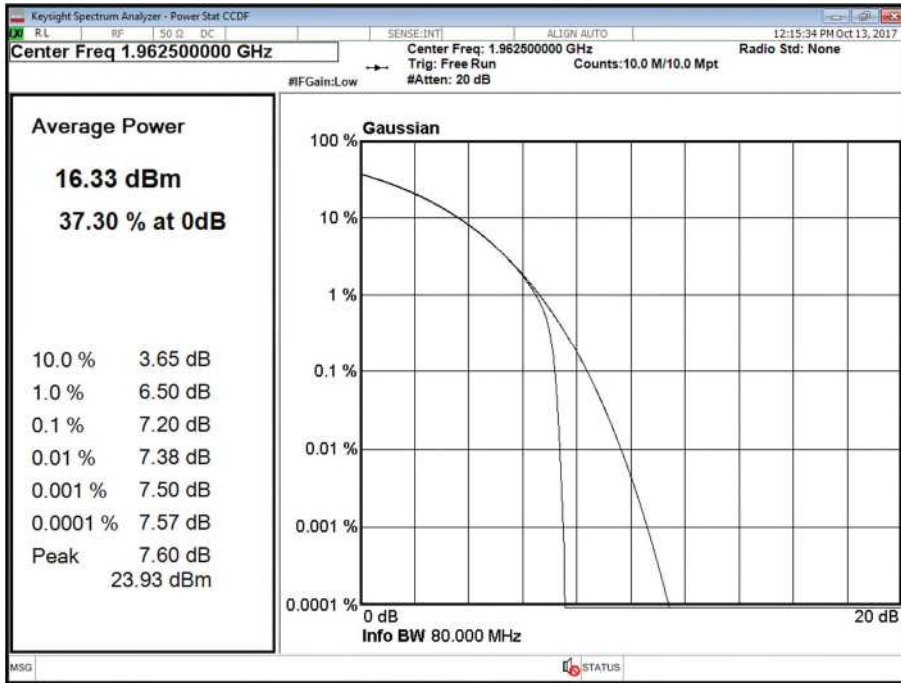

LTE Modulation QPSK - LTE Carrier Bandwidth 10.0 MHz - Antenna B

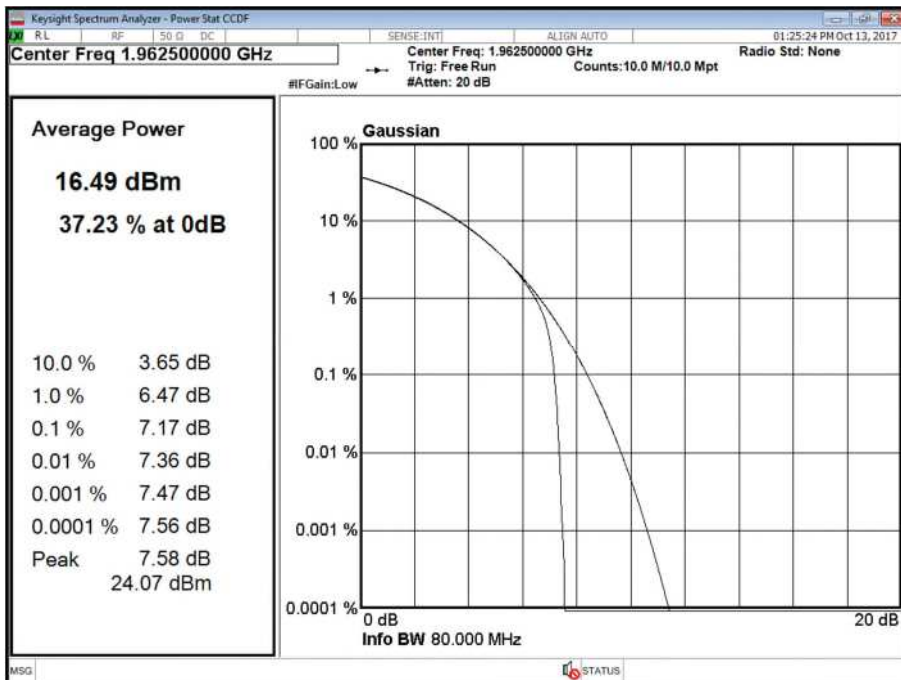



Product Service

LTE Modulation QPSK - LTE Carrier Bandwidth 15.0 MHz - Antenna A

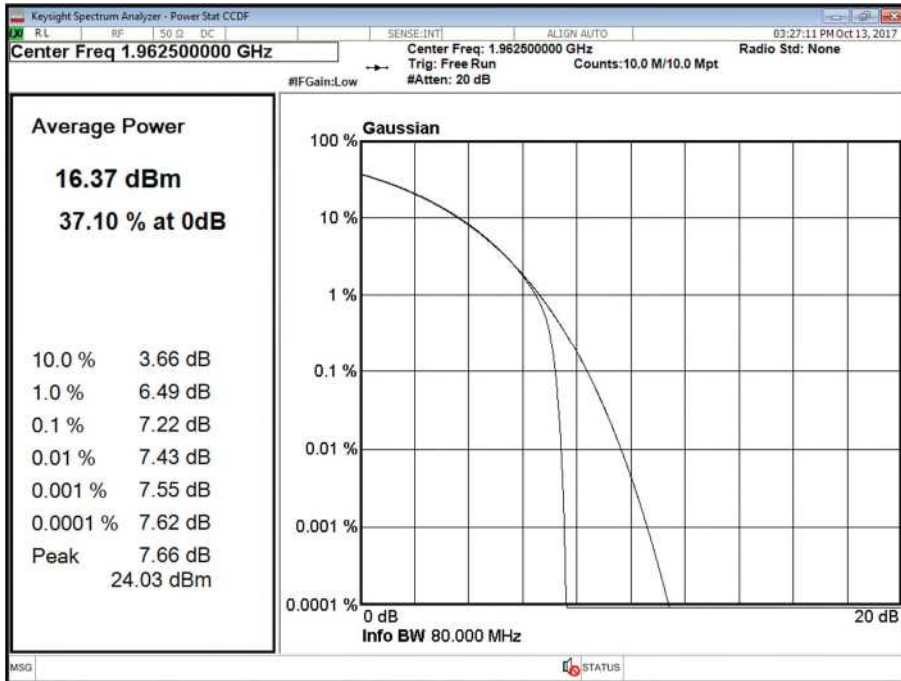

LTE Modulation QPSK - LTE Carrier Bandwidth 15.0 MHz - Antenna B

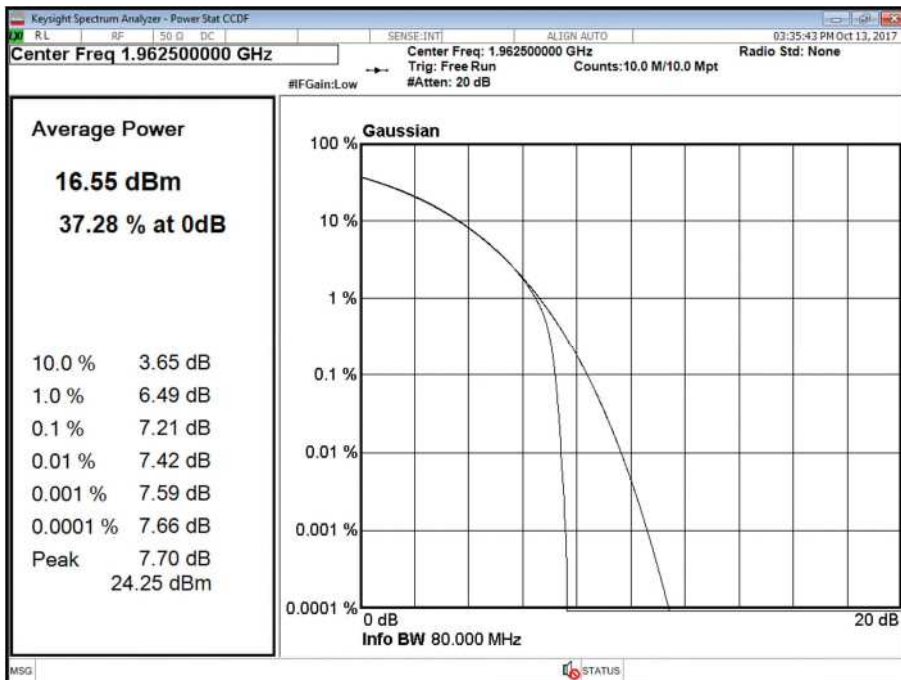



Product Service

LTE Modulation QPSK - LTE Carrier Bandwidth 20.0 MHz - Antenna A

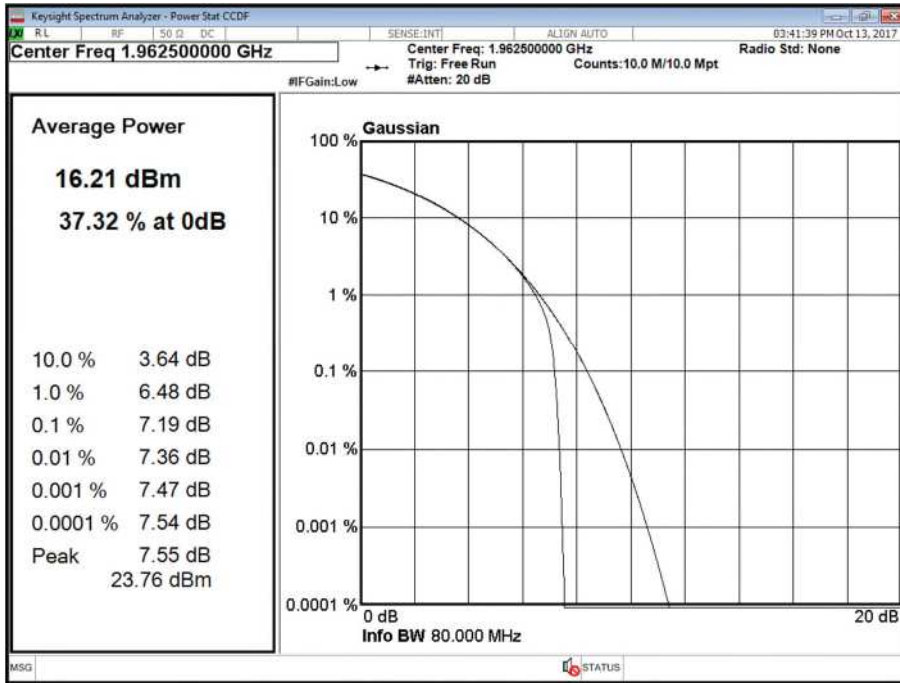

LTE Modulation QPSK - LTE Carrier Bandwidth 20.0 MHz - Antenna B

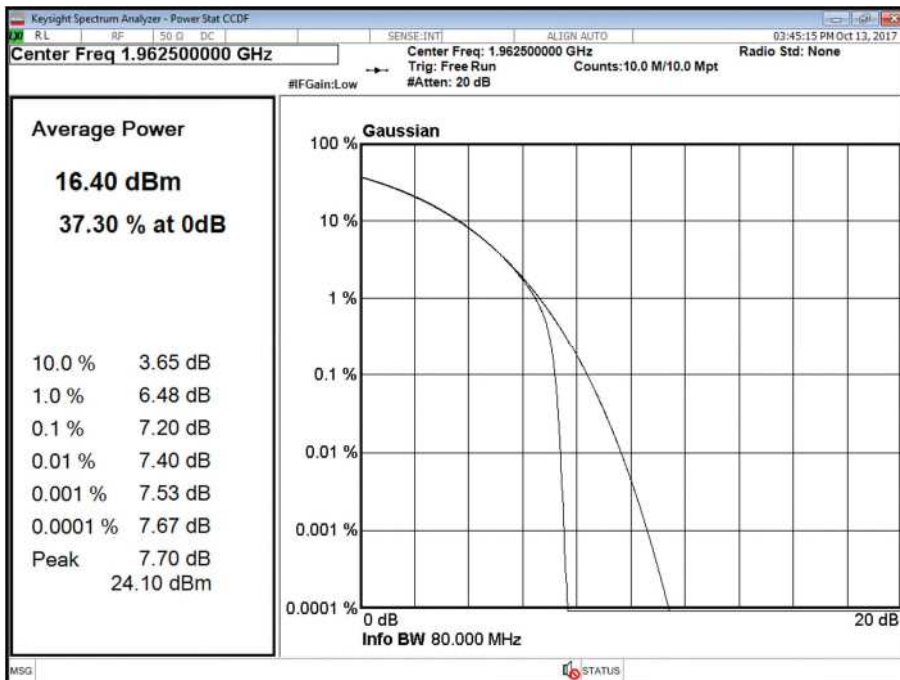



Product Service

Configuration 4

Maximum Output Power 17 dBm

Antenna	LTE Modulation	LTE Carrier Bandwidth	Peak to Average Ratio (PAR) / Output Power		
			Channel Position T		
			PAR (dB)	Average Power	
dBm	dBm/MHz				
A	QPSK	5.0 MHz	7.13	16.06	10.24
B	QPSK	5.0 MHz	7.16	16.25	10.46
Total			-	19.17	13.36
A	QPSK	10.0 MHz	7.21	16.10	7.45
B	QPSK	10.0 MHz	7.21	16.53	7.96
Total			-	19.33	10.72
A	QPSK	15.0 MHz	7.27	16.35	5.88
B	QPSK	15.0 MHz	7.29	16.36	5.88
Total			-	19.37	8.89
A	QPSK	20.0 MHz	7.29	16.34	4.77
B	QPSK	20.0 MHz	7.31	16.28	4.65
Total			-	19.32	7.72

Maximum Output Power 18.8 dBm (Including 1.8 dBi Antenna Gain)

Antenna	LTE Modulation	LTE Carrier Bandwidth	Peak to Average Ratio (PAR) / Output Power		
			Channel Position T		
			PAR (dB)	EIRP	
dBm	dBm/MHz				
A	QPSK	5.0 MHz	7.13	17.86	12.04
B	QPSK	5.0 MHz	7.16	18.05	12.26
Total			-	20.97	15.16
A	QPSK	10.0 MHz	7.21	17.90	9.25
B	QPSK	10.0 MHz	7.21	18.33	9.76
Total			-	21.13	12.52
A	QPSK	15.0 MHz	7.27	18.15	7.68
B	QPSK	15.0 MHz	7.29	18.16	7.68
Total			-	21.17	10.69
A	QPSK	20.0 MHz	7.29	18.14	6.57
B	QPSK	20.0 MHz	7.31	18.08	6.45
Total			-	21.12	9.52



Product Service

LTE Modulation QPSK - LTE Carrier Bandwidth 5.0 MHz - Antenna A

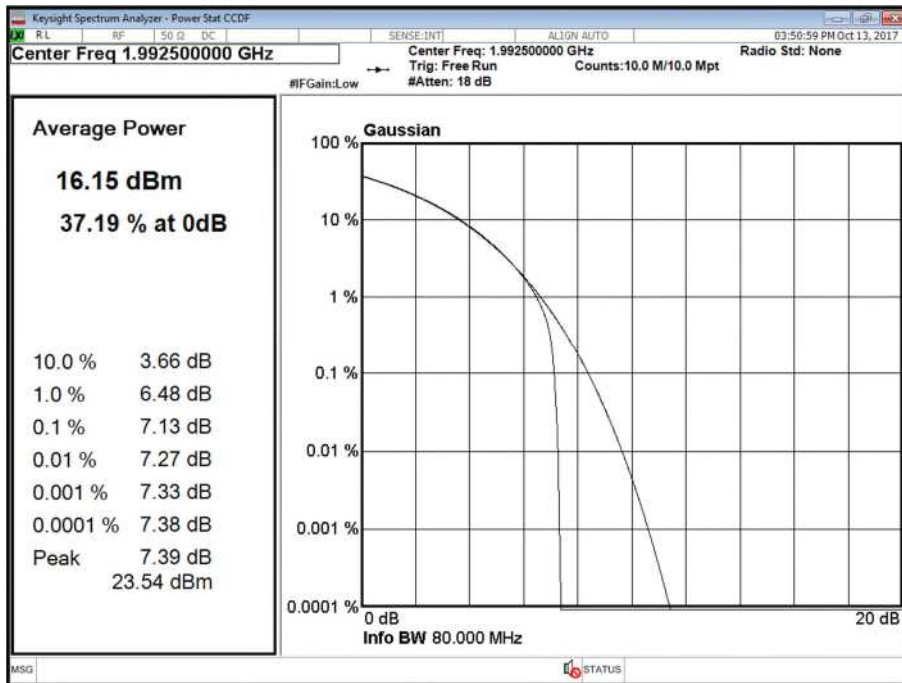

LTE Modulation QPSK - LTE Carrier Bandwidth 5.0 MHz - Antenna B

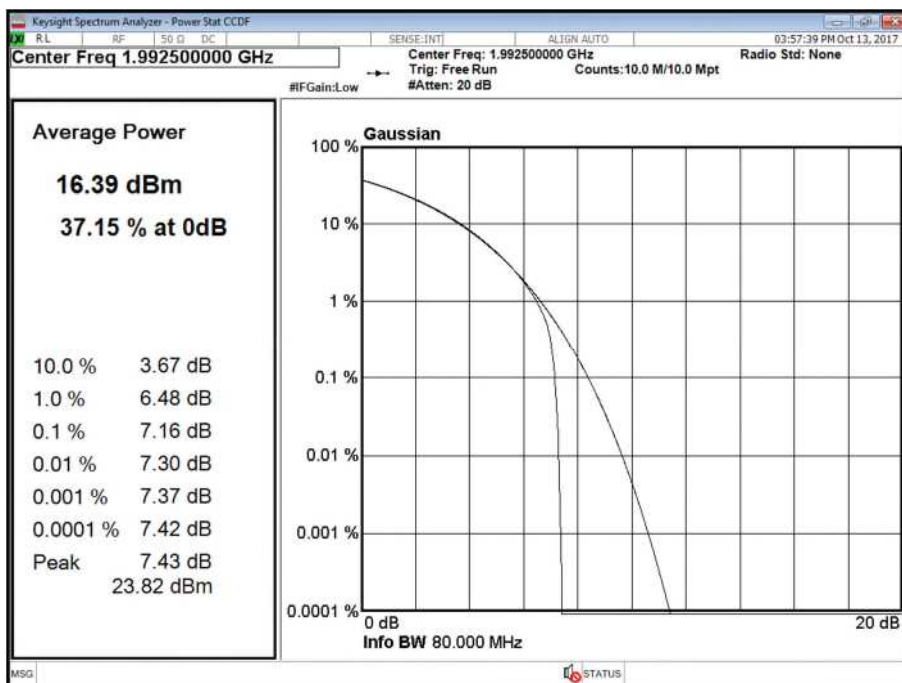



Product Service

LTE Modulation QPSK - LTE Carrier Bandwidth 10.0 MHz - Antenna A

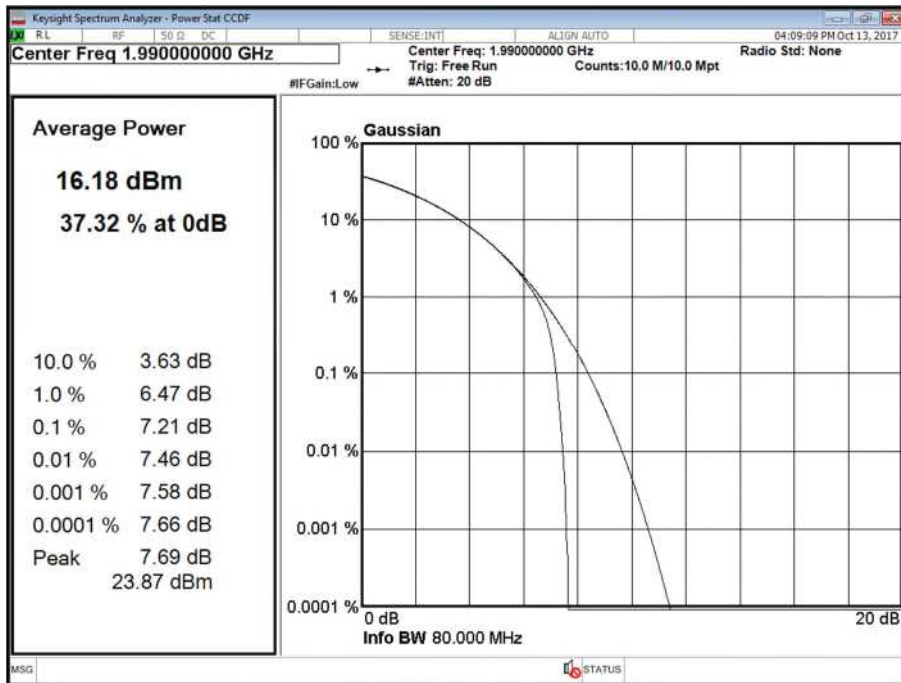

LTE Modulation QPSK - LTE Carrier Bandwidth 10.0 MHz - Antenna B

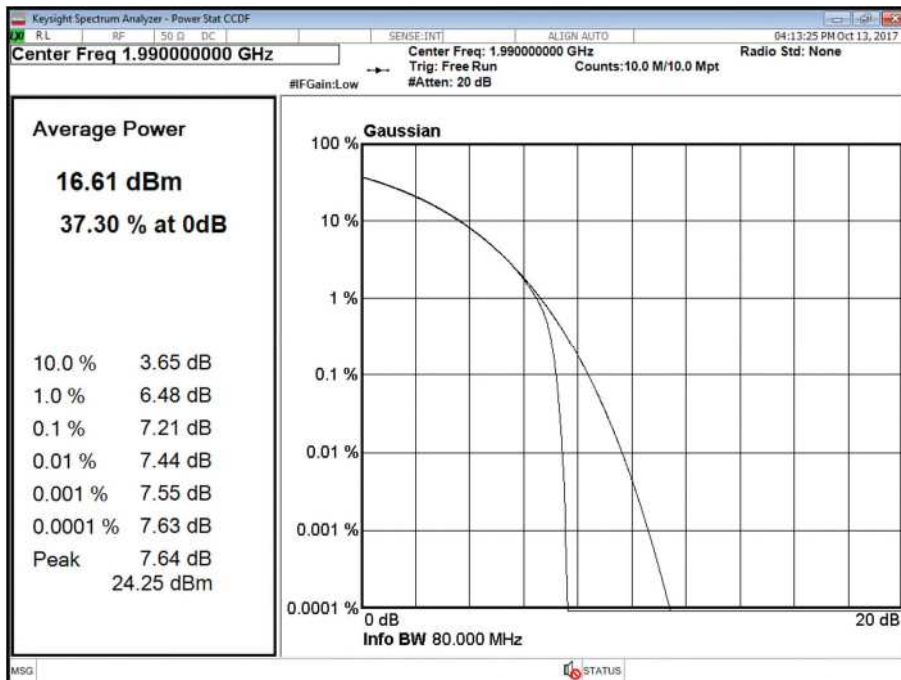



Product Service

LTE Modulation QPSK - LTE Carrier Bandwidth 15.0 MHz - Antenna A

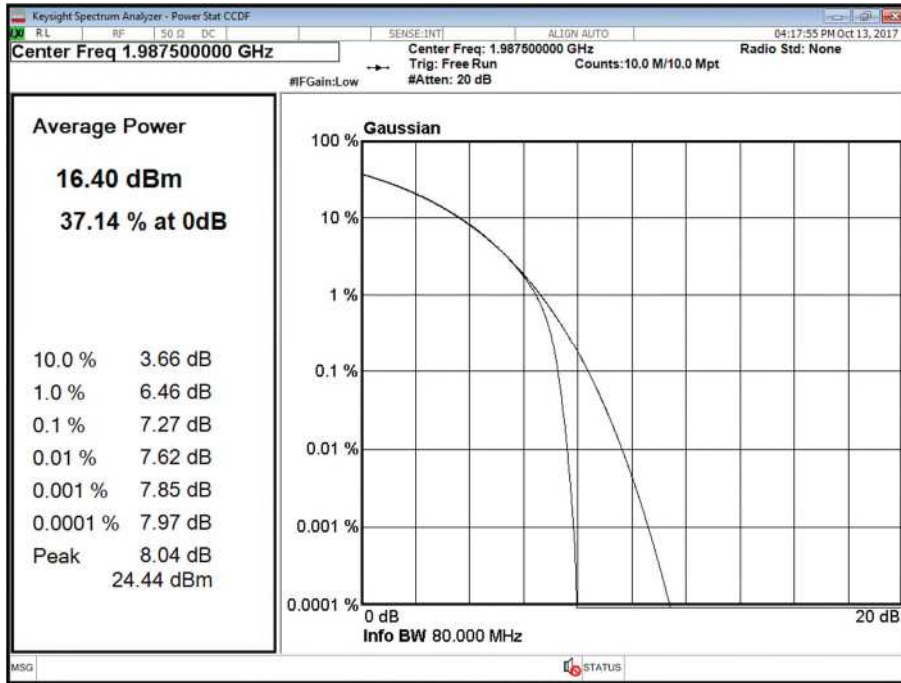

LTE Modulation QPSK - LTE Carrier Bandwidth 15.0 MHz - Antenna B

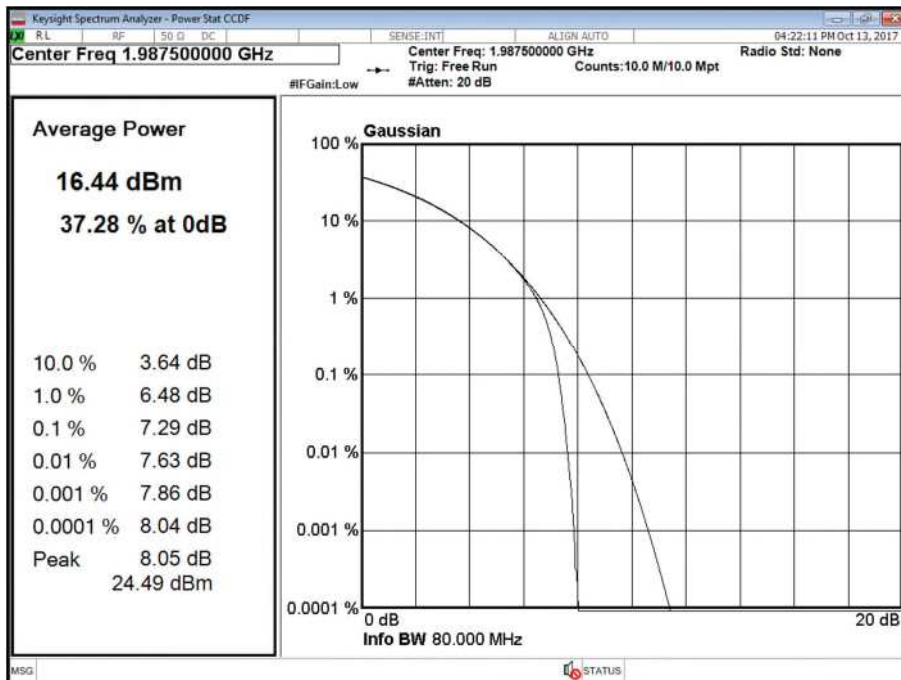



Product Service

LTE Modulation QPSK - LTE Carrier Bandwidth 20.0 MHz - Antenna A

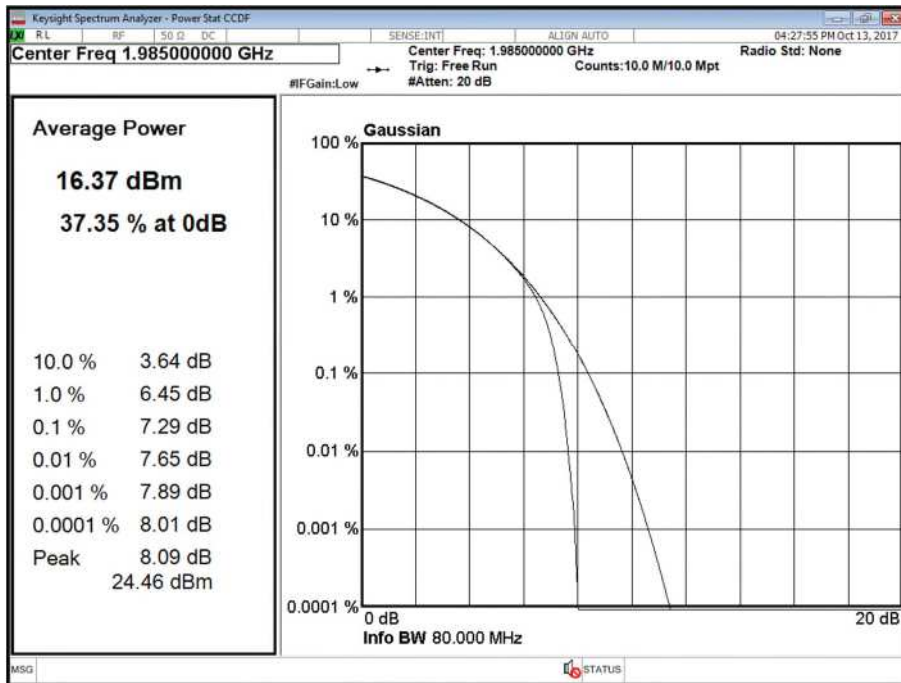

LTE Modulation QPSK - LTE Carrier Bandwidth 20.0 MHz - Antenna B

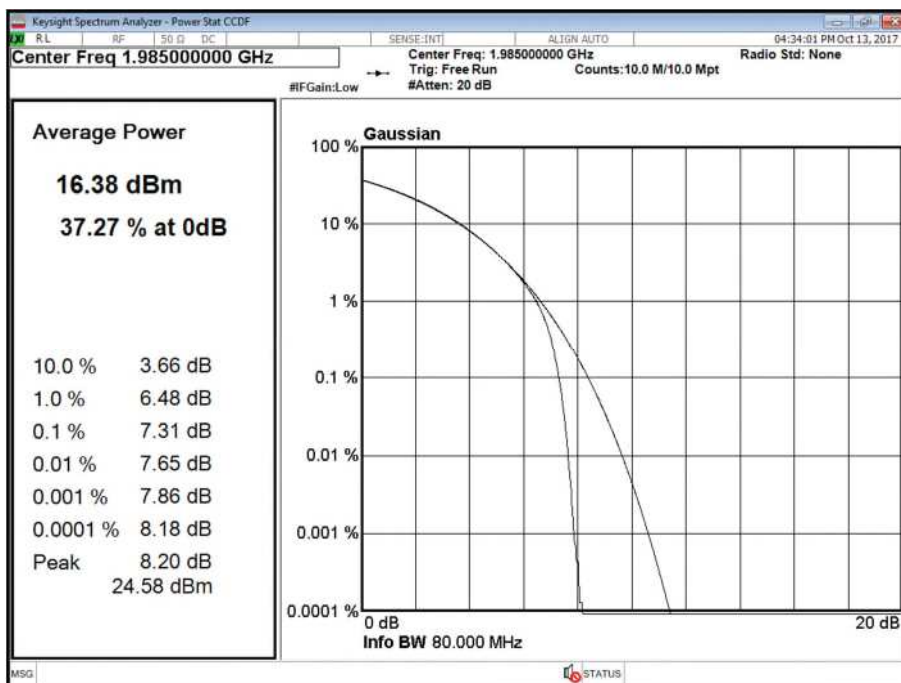



Product Service

Configuration 5

Maximum Output Power 17 dBm

Antenna	LTE Modulation	LTE Carrier Bandwidth	Peak to Average Ratio (PAR) / Output Power		
			Channel Position B		
			PAR (dB)	Average Power	
dBm	dBm/MHz				
A	QPSK	5.0 MHz	-	16.43	8.32
B	QPSK	5.0 MHz	-	16.36	8.14
Total			-	19.41	11.24
A	QPSK	10.0 MHz	-	16.48	5.57
B	QPSK	10.0 MHz	-	16.40	5.87
Total			-	19.45	8.73
A	QPSK	15.0 MHz	-	16.38	3.74
B	QPSK	15.0 MHz	-	16.53	3.83
Total			-	19.47	6.80
A	QPSK	20.0 MHz	-	16.55	2.31
B	QPSK	20.0 MHz	-	16.47	2.24
Total			-	19.52	5.29

Maximum Output Power 18.8 dBm (Including 1.8 dBi Antenna Gain)

Antenna	LTE Modulation	LTE Carrier Bandwidth	Peak to Average Ratio (PAR) / Output Power		
			Channel Position B		
			PAR (dB)	EIRP	
dBm	dBm/MHz				
A	QPSK	5.0 MHz	-	18.23	10.12
B	QPSK	5.0 MHz	-	18.16	9.94
Total			-	21.21	13.04
A	QPSK	10.0 MHz	-	18.28	7.37
B	QPSK	10.0 MHz	-	18.2	7.67
Total			-	21.25	10.53
A	QPSK	15.0 MHz	-	18.18	5.54
B	QPSK	15.0 MHz	-	18.33	5.63
Total			-	21.27	8.60
A	QPSK	20.0 MHz	-	18.35	4.11
B	QPSK	20.0 MHz	-	18.27	4.04
Total			-	21.32	7.09



Product Service

Configuration 5

Maximum Output Power 17 dBm

Antenna	LTE Modulation	LTE Carrier Bandwidth	Peak to Average Ratio (PAR) / Output Power		
			Channel Position M		
			PAR (dB)	Average Power	
dBm	dBm/MHz				
A	QPSK	5.0 MHz	-	16.44	7.84
B	QPSK	5.0 MHz	-	16.62	8.04
Total			-	19.54	10.95
A	QPSK	10.0 MHz	-	16.26	4.80
B	QPSK	10.0 MHz	-	16.36	5.01
Total			-	19.32	7.92
A	QPSK	15.0 MHz	-	16.20	3.13
B	QPSK	15.0 MHz	-	16.38	3.37
Total			-	19.30	6.26
A	QPSK	20.0 MHz	-	16.22	1.81
B	QPSK	20.0 MHz	-	16.50	2.47
Total			-	19.37	5.16

Maximum Output Power 18.8 dBm (Including 1.8 dBi Antenna Gain)

Antenna	LTE Modulation	LTE Carrier Bandwidth	Peak to Average Ratio (PAR) / Output Power		
			Channel Position M		
			PAR (dB)	EIRP	
dBm	dBm/MHz				
A	QPSK	5.0 MHz	-	18.24	9.64
B	QPSK	5.0 MHz	-	18.42	9.84
Total			-	31.34	12.75
A	QPSK	10.0 MHz	-	18.06	6.6
B	QPSK	10.0 MHz	-	18.16	6.81
Total			-	21.12	9.72
A	QPSK	15.0 MHz	-	18.00	4.93
B	QPSK	15.0 MHz	-	18.18	5.17
Total			-	21.10	8.06
A	QPSK	20.0 MHz	-	18.02	3.61
B	QPSK	20.0 MHz	-	18.30	4.27
Total			-	21.17	6.96



Product Service

Configuration 5

Maximum Output Power 17 dBm

Antenna	LTE Modulation	LTE Carrier Bandwidth	Peak to Average Ratio (PAR) / Output Power		
			Channel Position T		
			PAR (dB)	Average Power	
dBm	dBm/MHz				
A	QPSK	5.0 MHz	-	16.15	7.44
B	QPSK	5.0 MHz	-	16.30	7.64
Total			-	19.24	10.55
A	QPSK	10.0 MHz	-	16.30	4.92
B	QPSK	10.0 MHz	-	16.43	4.87
Total			-	19.38	7.91
A	QPSK	15.0 MHz	-	16.30	3.38
B	QPSK	15.0 MHz	-	16.34	3.04
Total			-	19.33	6.22
A	QPSK	20.0 MHz	-	16.24	2.40
B	QPSK	20.0 MHz	-	16.44	2.32
Total			-	19.35	5.37

Maximum Output Power 18.8 dBm (Including 1.8 dBi Antenna Gain)

Antenna	LTE Modulation	LTE Carrier Bandwidth	Peak to Average Ratio (PAR) / Output Power		
			Channel Position T		
			PAR (dB)	EIRP	
dBm	dBm/MHz				
A	QPSK	5.0 MHz	-	17.95	9.24
B	QPSK	5.0 MHz	-	18.1	9.44
Total			-	21.04	12.35
A	QPSK	10.0 MHz	-	18.10	6.72
B	QPSK	10.0 MHz	-	18.23	6.67
Total			-	21.18	9.71
A	QPSK	15.0 MHz	-	18.10	5.18
B	QPSK	15.0 MHz	-	18.14	4.84
Total			-	21.13	8.02
A	QPSK	20.0 MHz	-	18.04	4.20
B	QPSK	20.0 MHz	-	18.24	4.12
Total			-	21.15	7.17



Product Service

Configuration 6

Maximum Output Power 17 dBm

Antenna	WCDMA / LTE Modulation	WCDMA / LTE Carrier Bandwidth	Peak to Average Ratio (PAR) / Output Power		
			Channel Position M _{RFBW}		
			PAR (dB)	Average Power	
dBm	dBm/MHz				
A	16QAM / QPSK	5.0 MHz / 5.0 MHz		16.18	8.06
B	16QAM / QPSK	5.0 MHz / 5.0 MHz		16.49	8.08
Total			-	19.34	11.07
A	16QAM / QPSK	5.0 MHz / 10.0 MHz		16.57	7.71
B	16QAM / QPSK	5.0 MHz / 10.0 MHz		16.30	7.79
Total			-	19.45	10.75
A	16QAM / QPSK	5.0 MHz / 15.0 MHz		16.23	7.58
B	16QAM / QPSK	5.0 MHz / 15.0 MHz		16.53	7.84
Total			-	19.39	10.71
A	16QAM / QPSK	5.0 MHz / 20.0 MHz		16.24	7.42
B	16QAM / QPSK	5.0 MHz / 20.0 MHz		16.29	7.51
Total			-	19.28	10.47

Maximum Output Power 18.8 dBm (Including 1.8 dBi Antenna Gain)

Antenna	WCDMA / LTE Modulation	WCDMA / LTE Carrier Bandwidth	Peak to Average Ratio (PAR) / Output Power		
			Channel Position M _{RFBW}		
			PAR (dB)	EIRP	
dBm	dBm/MHz				
A	16QAM / QPSK	5.0 MHz / 5.0 MHz		17.98	9.86
B	16QAM / QPSK	5.0 MHz / 5.0 MHz		18.29	9.88
Total			-	21.14	12.87
A	16QAM / QPSK	5.0 MHz / 10.0 MHz		18.37	9.51
B	16QAM / QPSK	5.0 MHz / 10.0 MHz		18.10	9.59
Total			-	21.25	12.55
A	16QAM / QPSK	5.0 MHz / 15.0 MHz		18.03	9.38
B	16QAM / QPSK	5.0 MHz / 15.0 MHz		18.33	9.64
Total			-	21.19	12.51
A	16QAM / QPSK	5.0 MHz / 20.0 MHz		18.04	9.22
B	16QAM / QPSK	5.0 MHz / 20.0 MHz		18.09	9.31
Total			-	21.08	12.27



Product Service

Configuration 7

Maximum Output Power 17 dBm

Antenna	WCDMA / LTE Modulation	WCDMA / LTE Carrier Bandwidth	Peak to Average Ratio (PAR) / Output Power		
			Channel Position M_{RFBW}		
			PAR (dB)	Average Power	
dBm	dBm/MHz				
A	16QAM / QPSK	5.0 MHz / 5.0 MHz		16.2	6.25
B	16QAM / QPSK	5.0 MHz / 5.0 MHz		16.43	6.52
Total			-	19.33	9.40
A	16QAM / QPSK	5.0 MHz / 10.0 MHz		16.3	9.77
B	16QAM / QPSK	5.0 MHz / 10.0 MHz		16.34	10.06
Total			-	19.33	12.83

Configuration 7

Maximum Output Power 18.8 dBm (Including 1.8 dBi Antenna Gain)

Antenna	WCDMA / LTE Modulation	WCDMA / LTE Carrier Bandwidth	Peak to Average Ratio (PAR) / Output Power		
			Channel Position M_{RFBW}		
			PAR (dB)	EIRP	
dBm	dBm/MHz				
A	16QAM / QPSK	5.0 MHz / 5.0 MHz		18.0	8.05
B	16QAM / QPSK	5.0 MHz / 5.0 MHz		18.23	8.32
Total			-	21.13	11.2
A	16QAM / QPSK	5.0 MHz / 10.0 MHz		18.1	11.57
B	16QAM / QPSK	5.0 MHz / 10.0 MHz		18.14	11.86
Total			-	21.13	14.73

Limit	
Peak Power	1640W or 62.1 dBm
Peak to Average Ratio	13 dB



2.2 OCCUPIED BANDWIDTH

2.2.1 Specification Reference

FCC CFR 47 Part 2, Clause 2.1049
 FCC CFR 47 Part 24, Clause 24.238 (b)
 Industry Canada RSS-GEN, Clause 6.6

2.2.2 Date of Test and Modification State

12, 13 October 2017 - Modification State 0

2.2.3 Test Equipment Used

The major items of test equipment used for the above tests are identified in Section 3.1.

2.2.4 Environmental Conditions

Ambient Temperature 23°C
 Relative Humidity 50%

2.2.5 Test Method

All measurements were made in accordance with FCC KDB 971168 D01.

2.2.6 Test Results

Configuration 1

Maximum Output Power 17 dBm

Antenna	WCDMA Modulation	WCDMA Carrier Bandwidth	Result (KHz)					
			Channel Position B		Channel Position M		Channel Position T	
			Occupied Bandwidth	-26 dB Bandwidth	Occupied Bandwidth	-26 dB Bandwidth	Occupied Bandwidth	-26 dB Bandwidth
A	QPSK	4.2 MHz	3,850.86	4,124.10	3,842.77	4,118.63	3,845.36	4,122.19
B	QPSK	4.2 MHz	3,844.80	4,120.55	3,844.17	4,123.59	3,841.62	4,119.69
A	QPSK	5.0 MHz	4,154.98	4,655.80	4,162.85	4,658.47	4,149.24	4,649.89
B	QPSK	5.0 MHz	4,156.01	4,648.98	4,156.76	4,651.78	4,144.23	4,654.68



Product Service

Antenna A - Bandwidth QPSK - Channel B

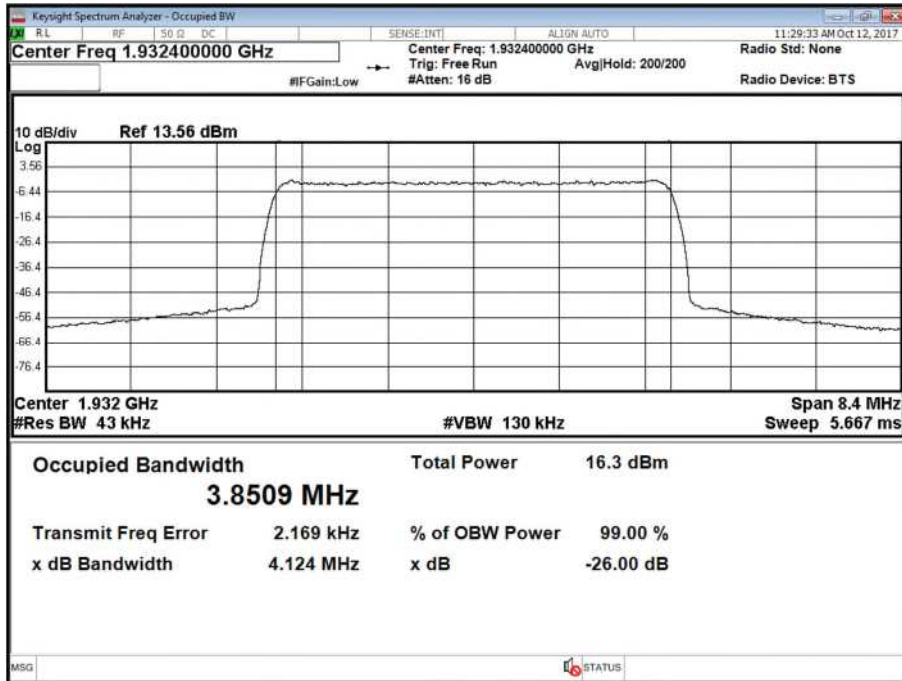

Antenna B - Bandwidth QPSK - Channel B

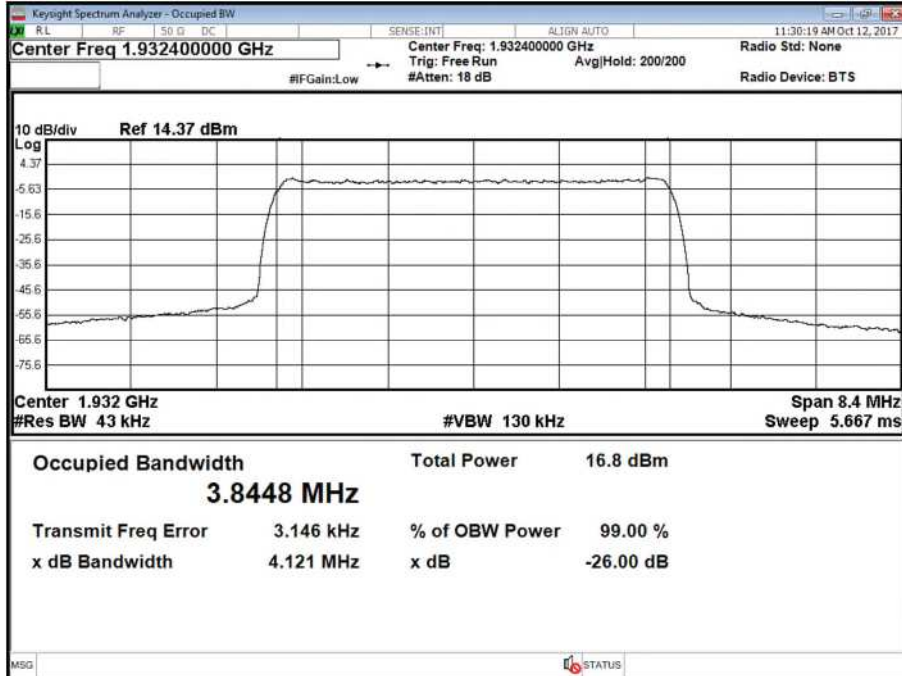



Product Service

Antenna A - Bandwidth QPSK - Channel M

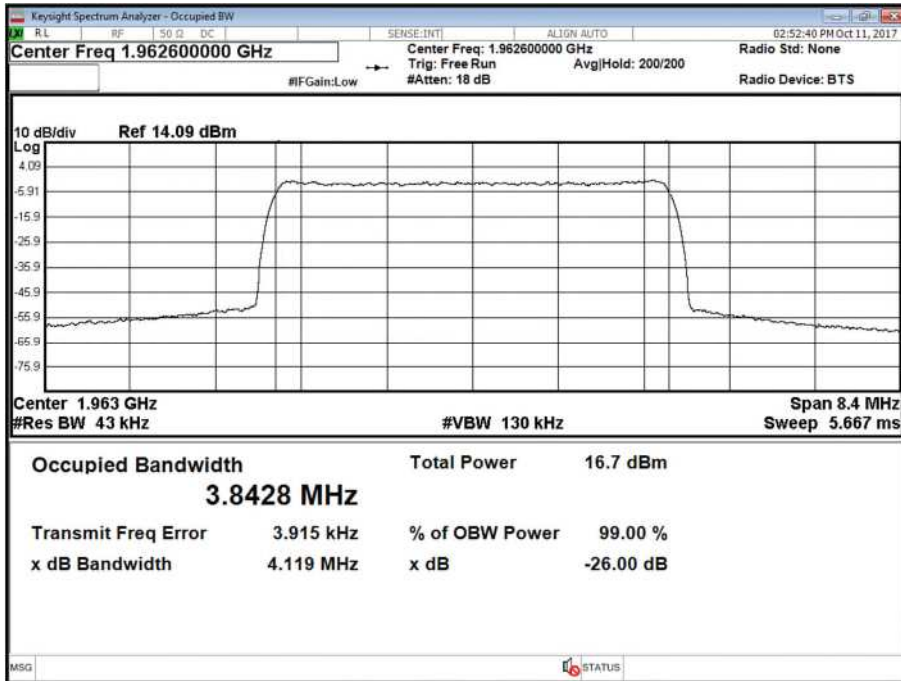

Antenna B - Bandwidth QPSK - Channel M A

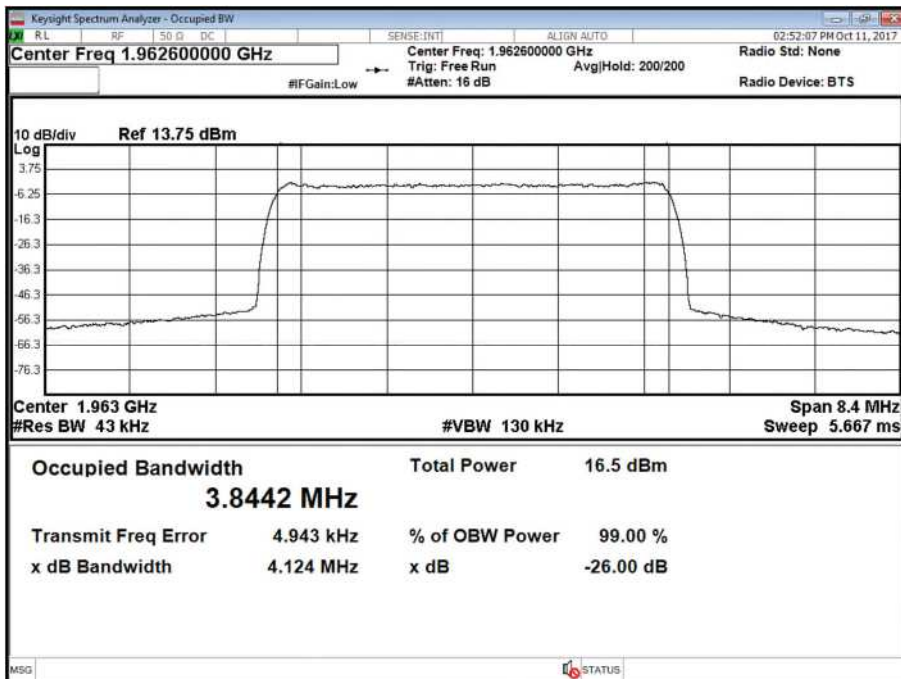



Product Service

Antenna A - Bandwidth QPSK - Channel T

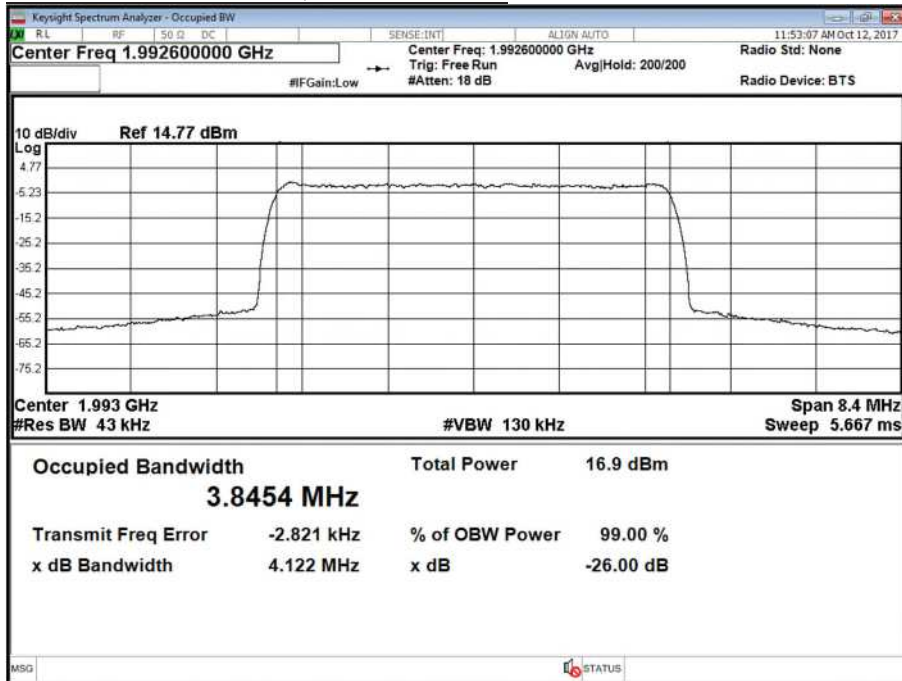

Antenna B - Bandwidth QPSK - Channel T

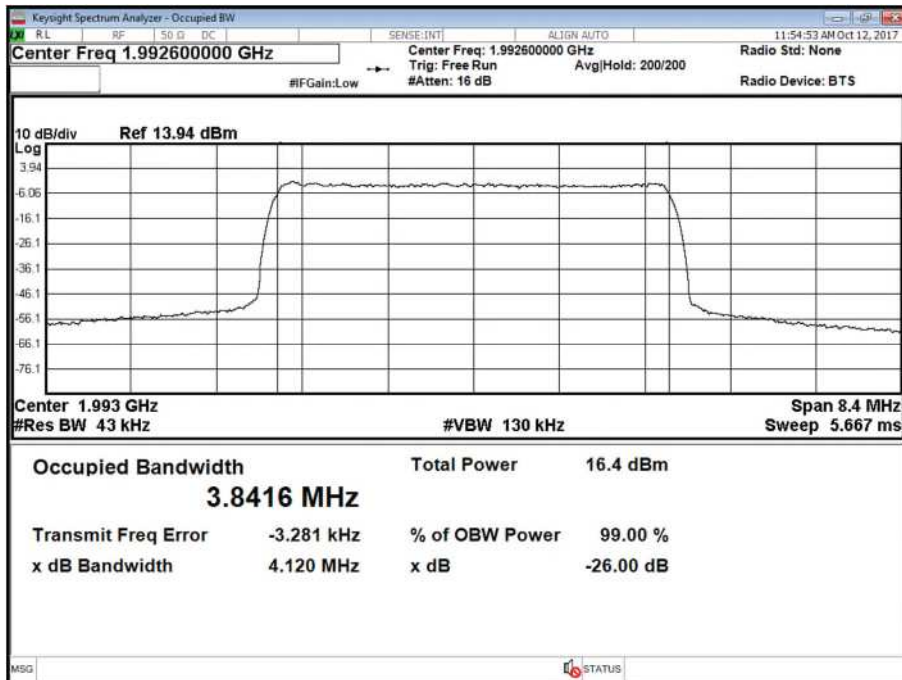



Product Service

Antenna A - Bandwidth QPSK - Channel B

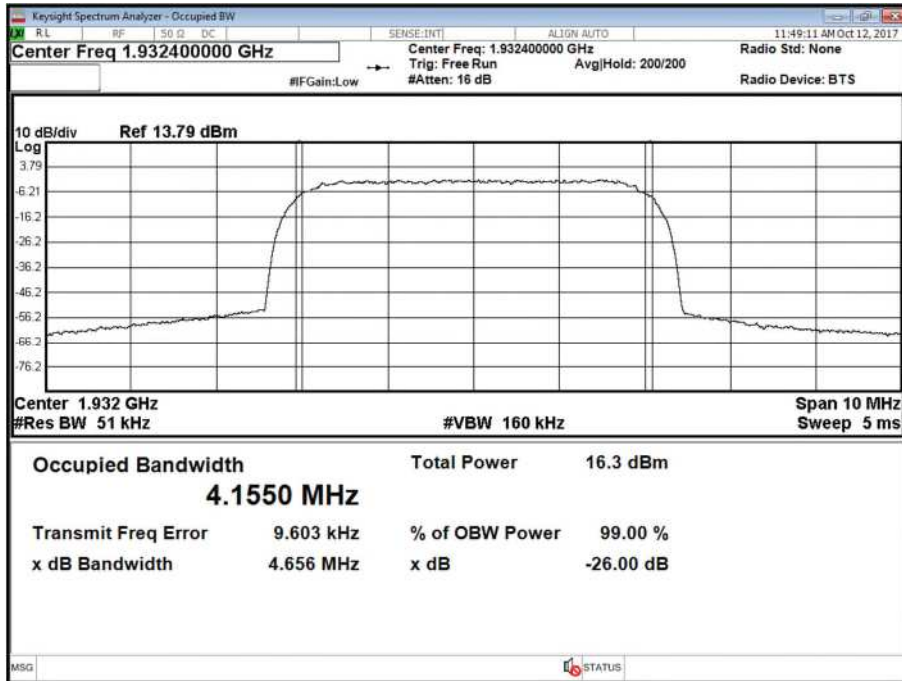

Antenna B - Bandwidth QPSK - Channel B

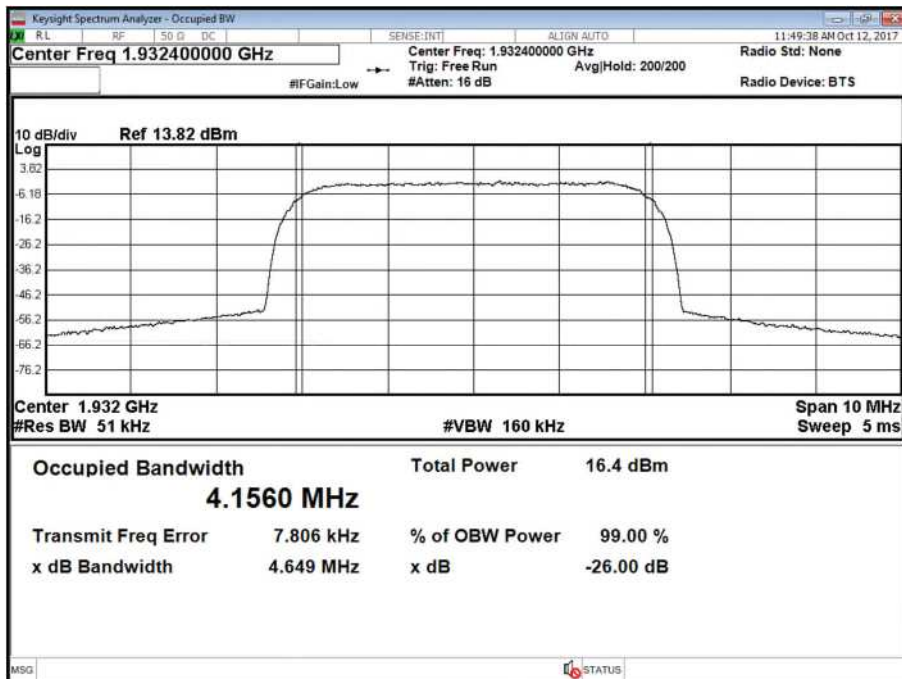



Product Service

Antenna A - Bandwidth QPSK - Channel M

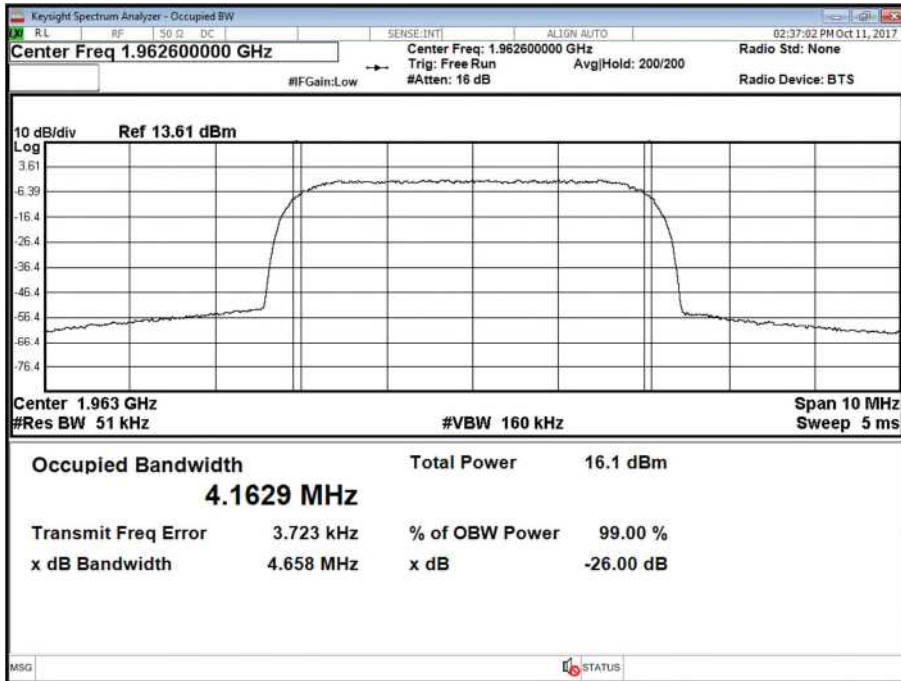

Antenna B - Bandwidth QPSK - Channel M

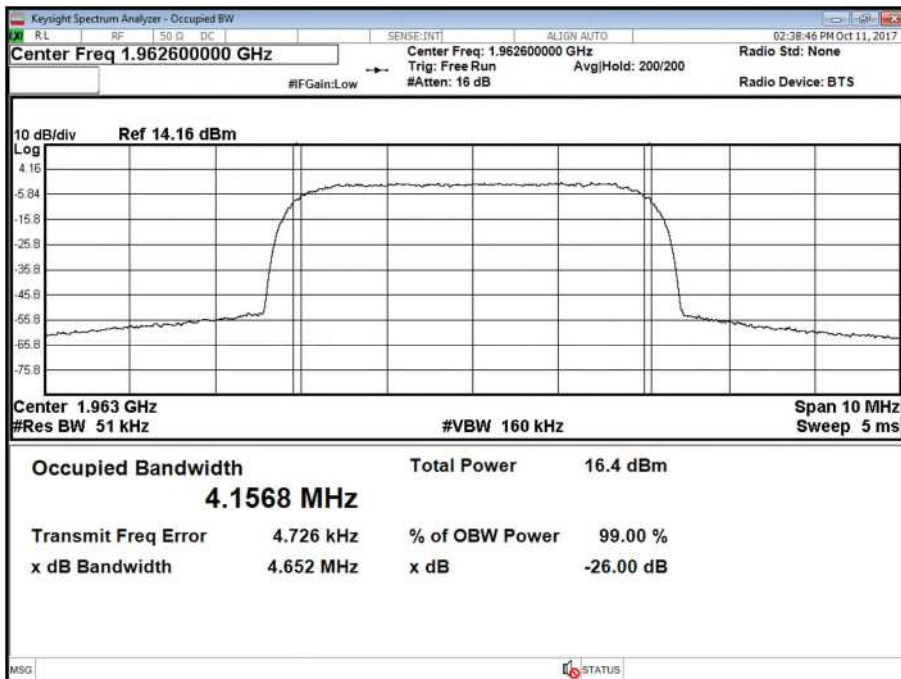



Product Service

Antenna A - Bandwidth QPSK - Channel T

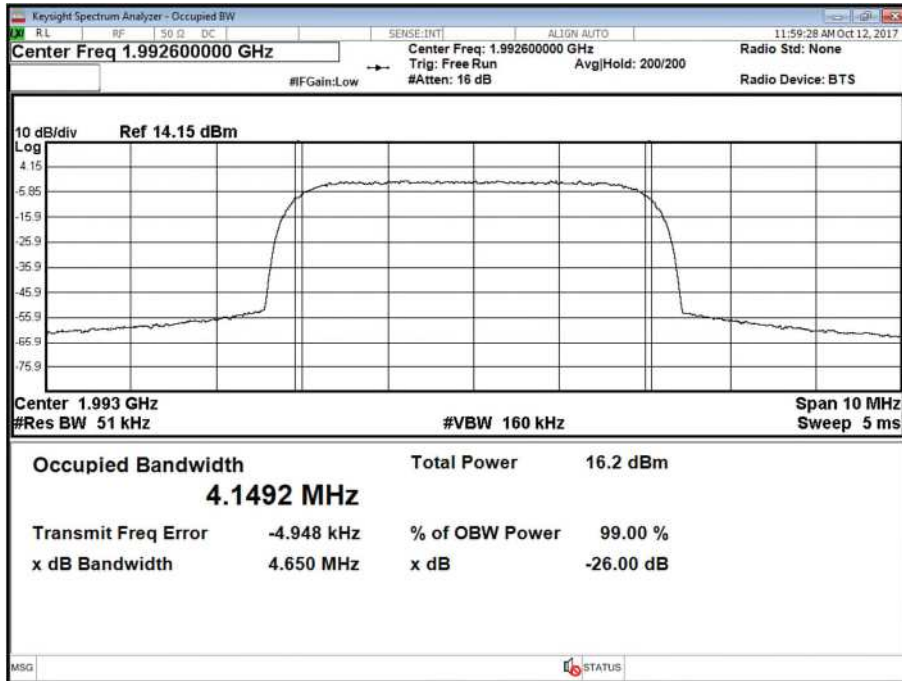

Antenna B - Bandwidth QPSK - Channel T

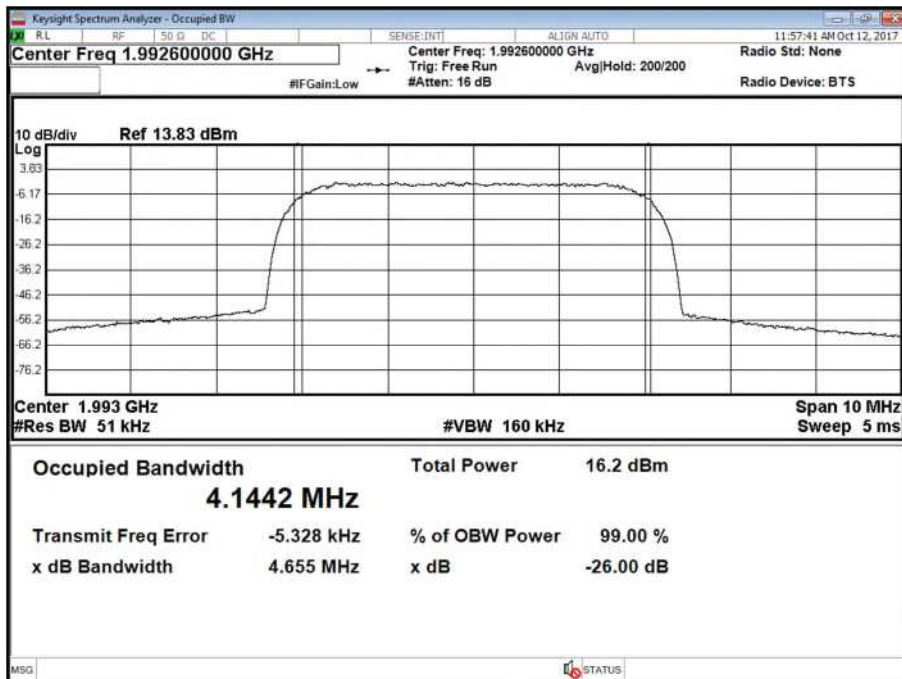



Product Service

Configuration 4

Maximum Output Power 17 dBm

Antenna	LTE Modulation	LTE Carrier Bandwidth	Result (KHz)					
			Channel Position B		Channel Position M		Channel Position T	
			Occupied Bandwidth	-26 dB Bandwidth	Occupied Bandwidth	-26 dB Bandwidth	Occupied Bandwidth	-26 dB Bandwidth
A	QPSK	5.0 MHz	4,472.30	4,715.27	4,474.29	4,717.15	4,471.50	4,722.26
B	QPSK	5.0 MHz	4,472.92	4,719.86	4,471.88	4,719.35	4,463.90	4,721.34
A	QPSK	10.0 MHz	8,934.88	9,347.83	8,932.74	9,333.46	8,927.07	9,357.82
B	QPSK	10.0 MHz	8,932.62	9,315.85	8,929.60	9,338.82	8,931.84	9,338.27
A	QPSK	15.0 MHz	13,376.50	13,959.18	13,397.63	13,921.84	13,385.76	13,950.74
B	QPSK	15.0 MHz	13,378.24	13,900.05	13,381.19	13,963.40	13,382.83	13,920.40
A	QPSK	20.0 MHz	17,809.55	18,506.67	17,850.25	18,588.80	17,828.84	18,511.11
B	QPSK	20.0 MHz	17,818.67	18,528.49	17,861.95	18,540.92	17,836.80	18,529.00

Antenna A - Bandwidth QPSK – Channel B

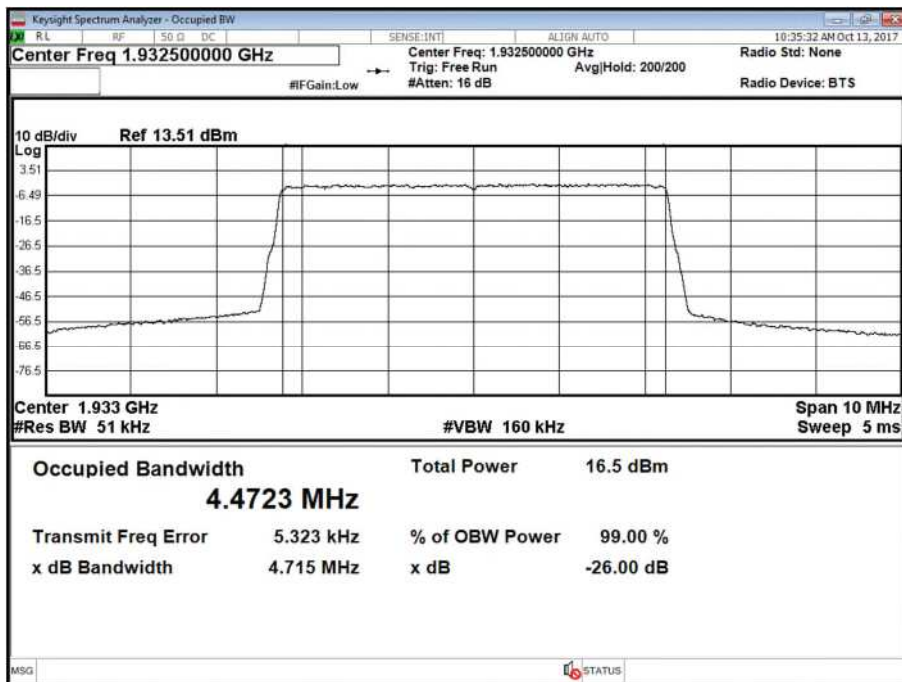



Product Service

Antenna B - Bandwidth QPSK - Channel B

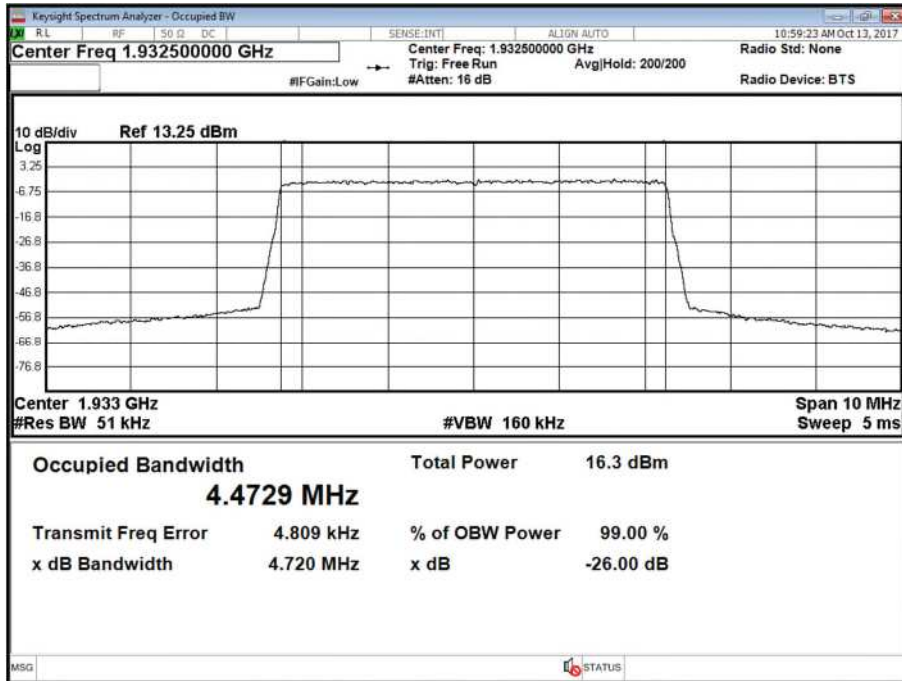

Antenna A - Bandwidth QPSK - Channel M

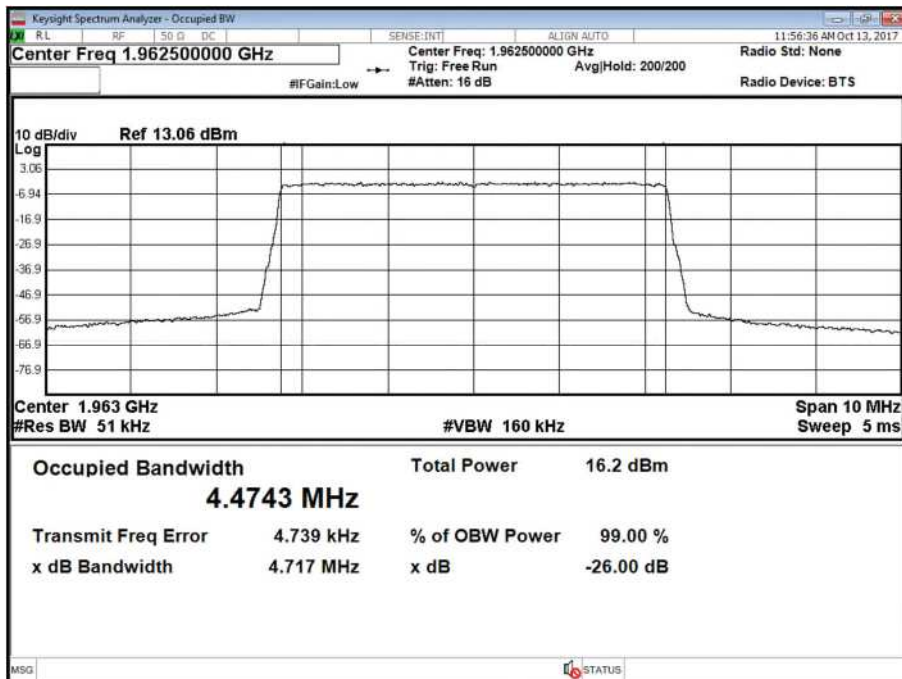



Product Service

Antenna B - Bandwidth QPSK - Channel M

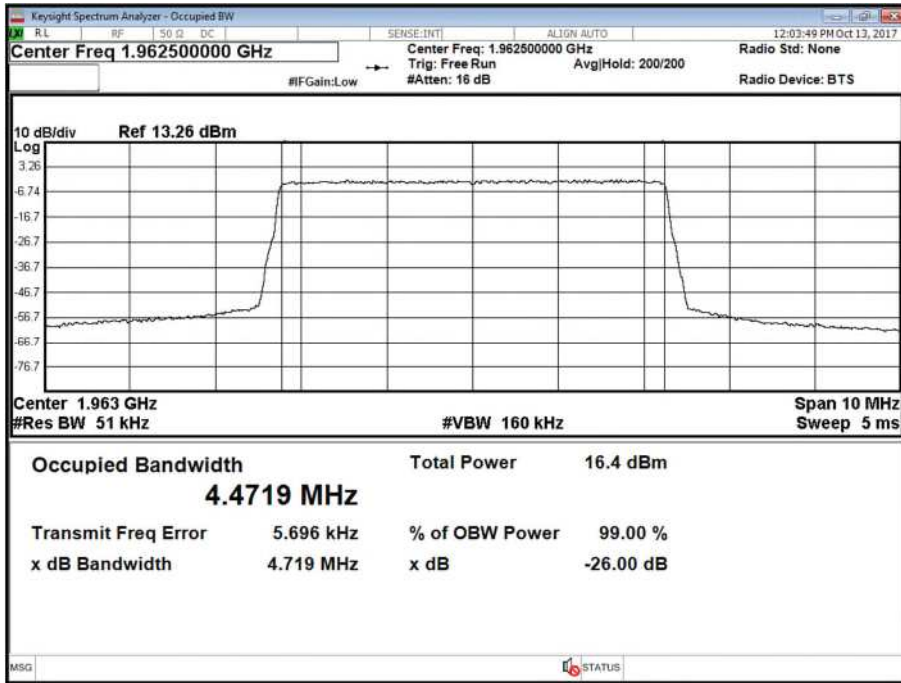

Antenna A - Bandwidth QPSK - Channel T

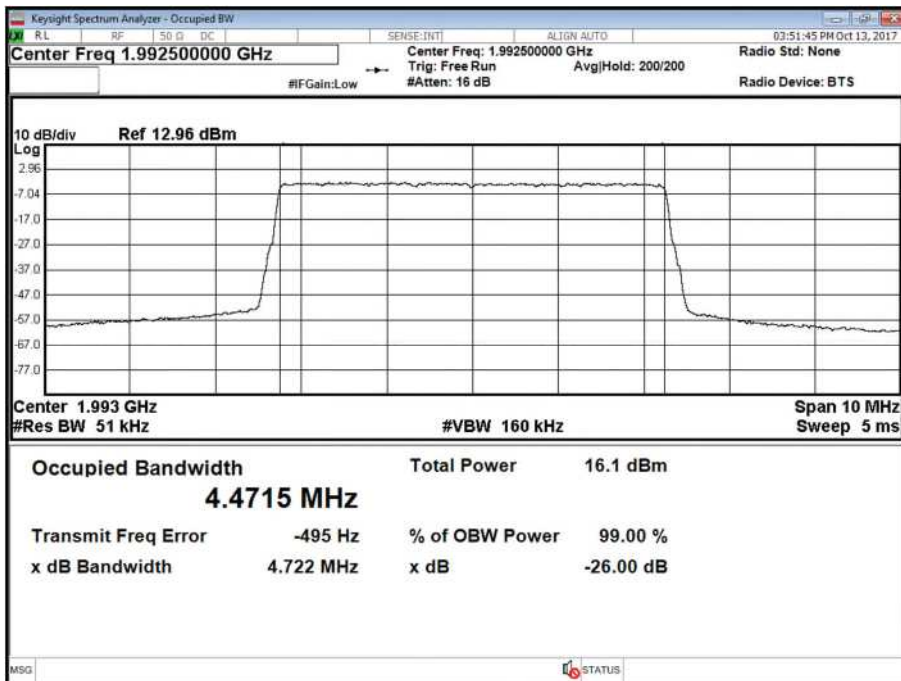



Product Service

Antenna B - Bandwidth QPSK - Channel T

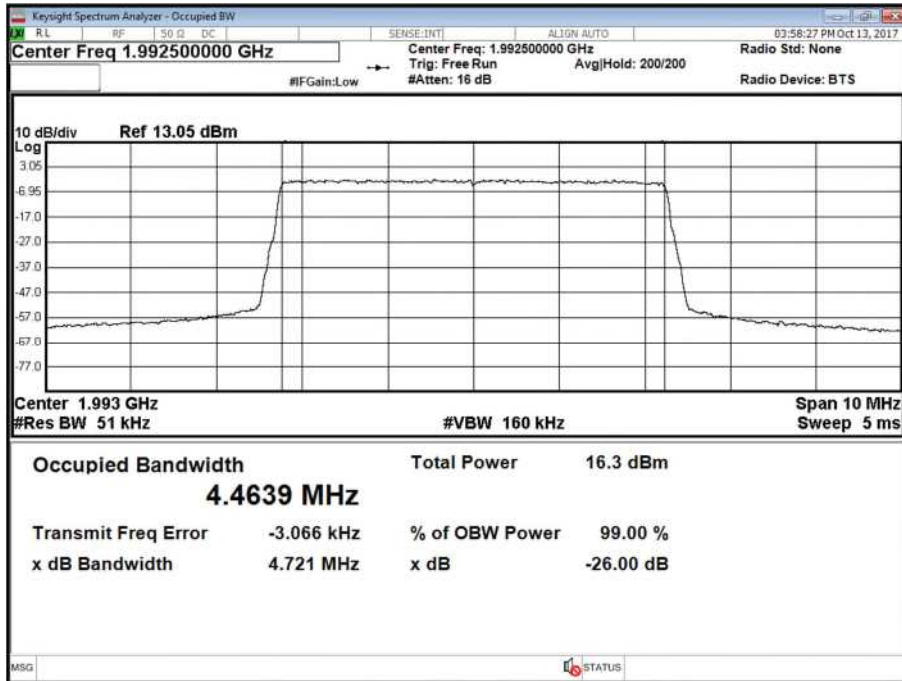

Antenna A - Bandwidth QPSK - Channel B

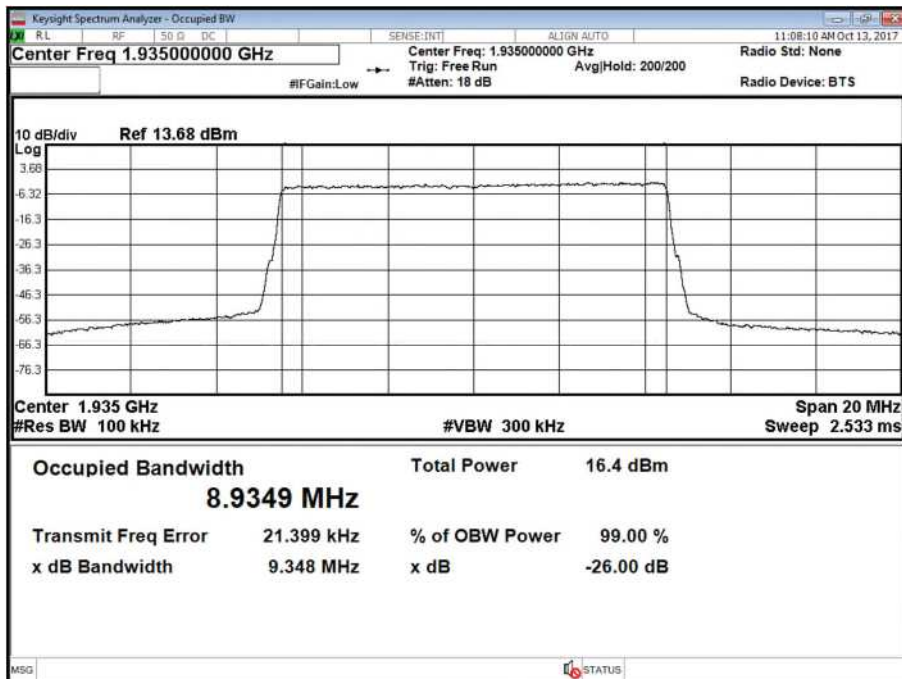



Product Service

Antenna B - Bandwidth QPSK - Channel B

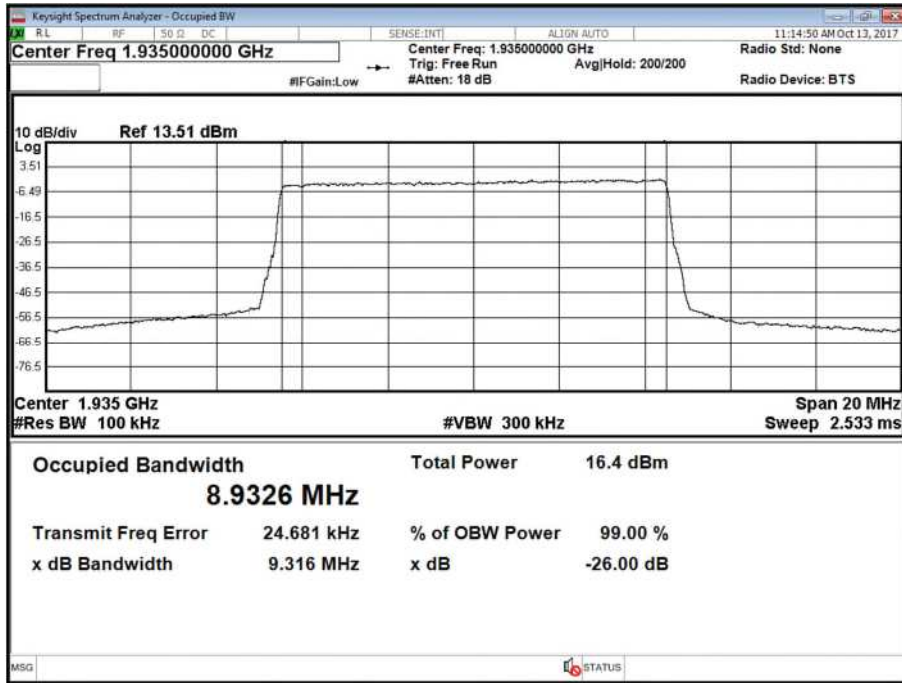

Antenna A - Bandwidth QPSK - Channel M

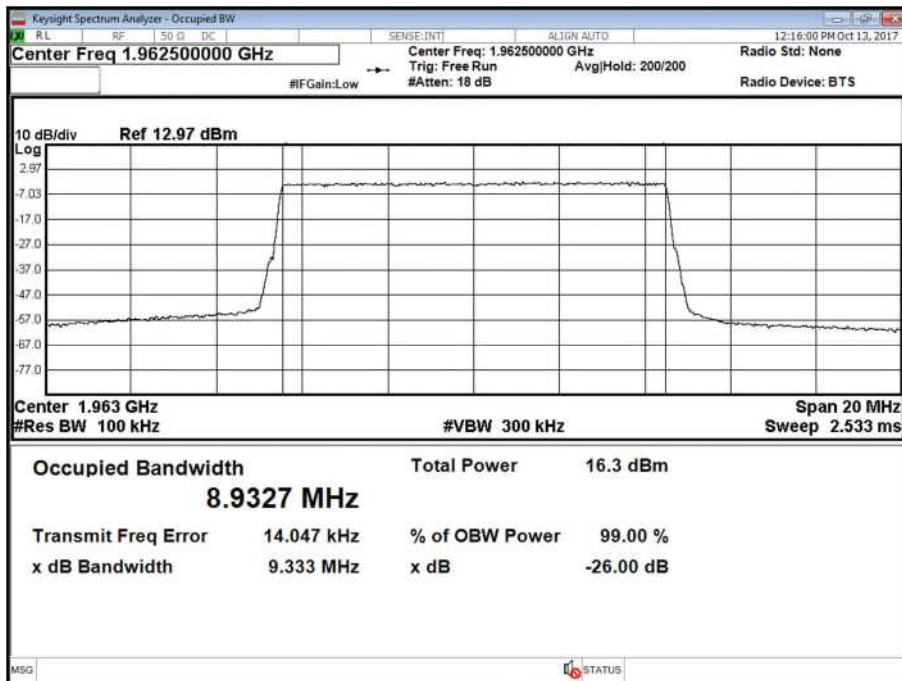



Product Service

Antenna B - Bandwidth QPSK - Channel M

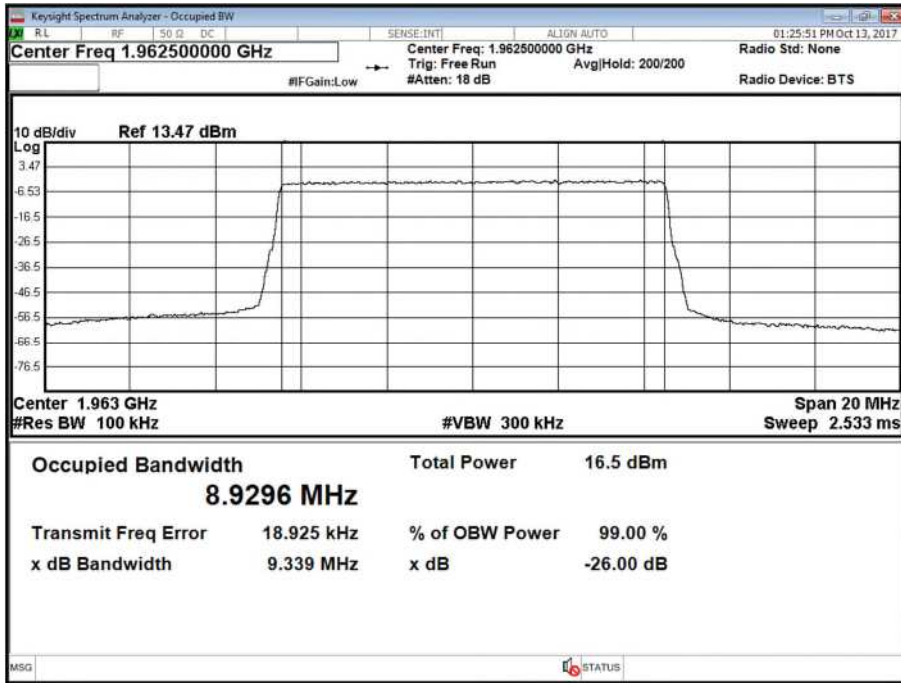

Antenna A - Bandwidth QPSK - Channel T

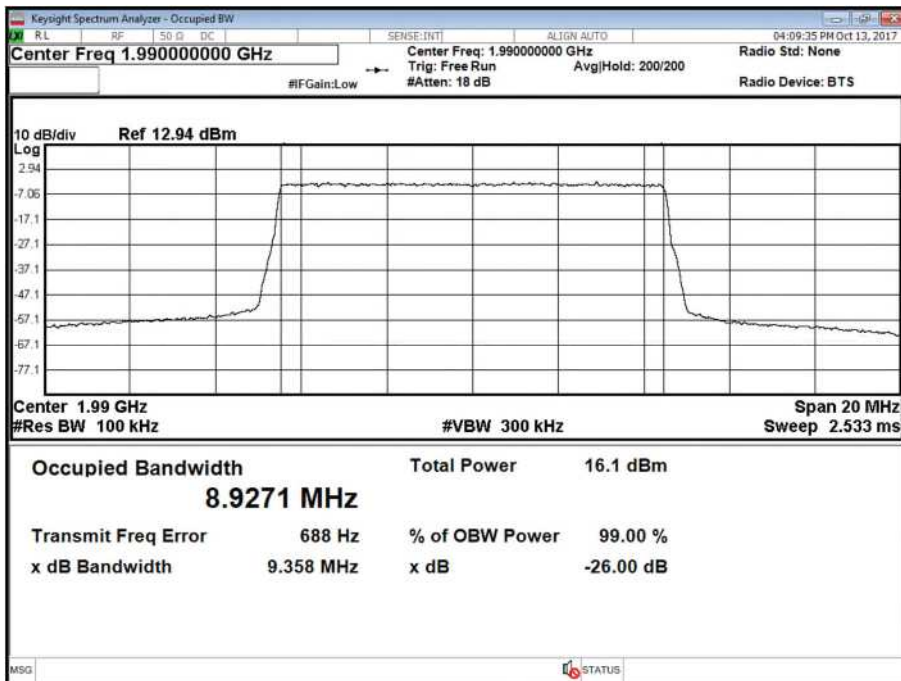



Product Service

Antenna B - Bandwidth QPSK - Channel T

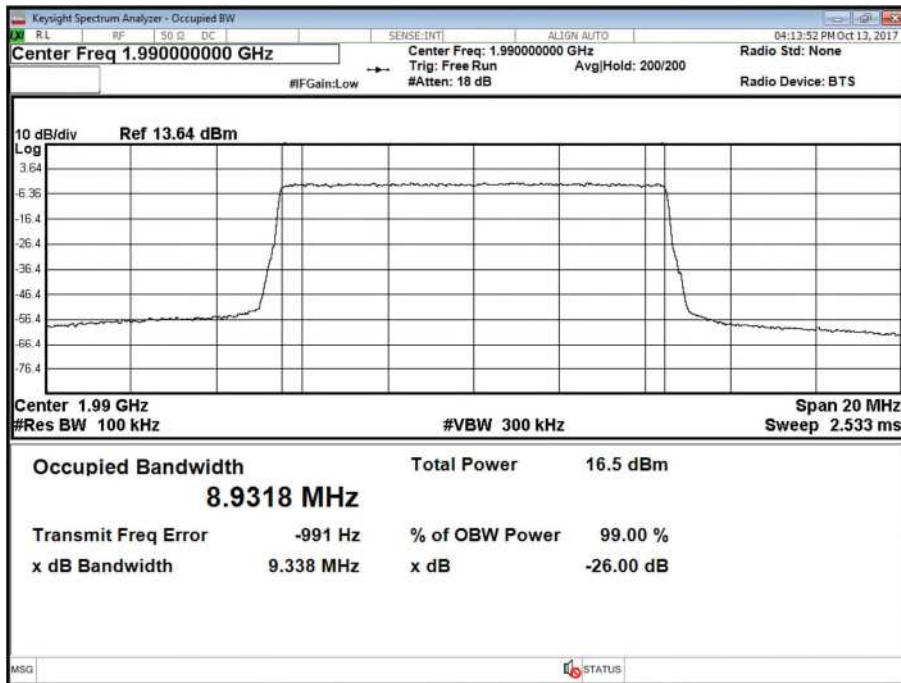

Antenna A - Bandwidth QPSK - Channel B

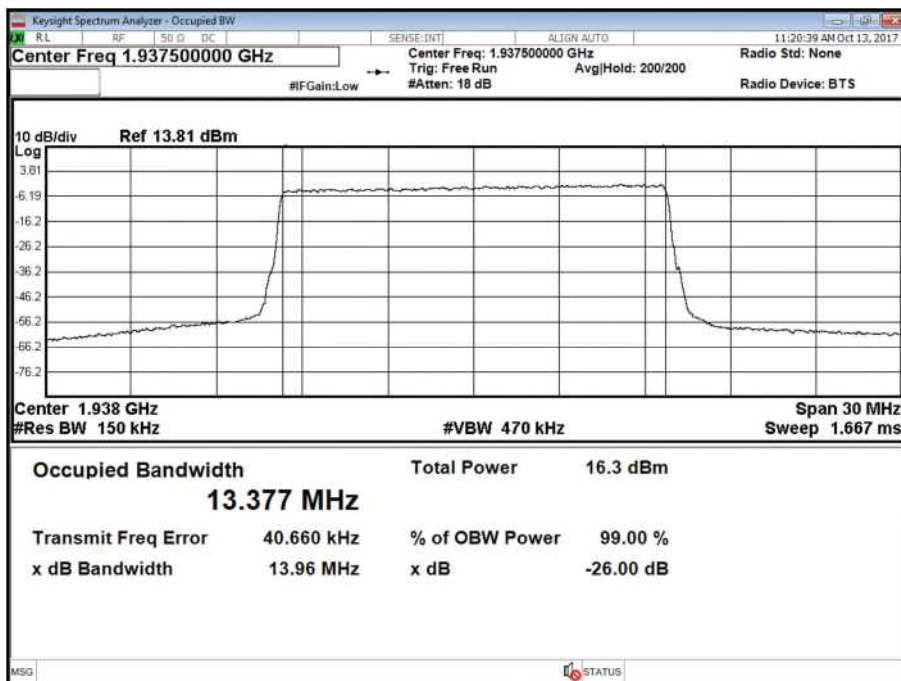



Product Service

Antenna B - Bandwidth QPSK - Channel B

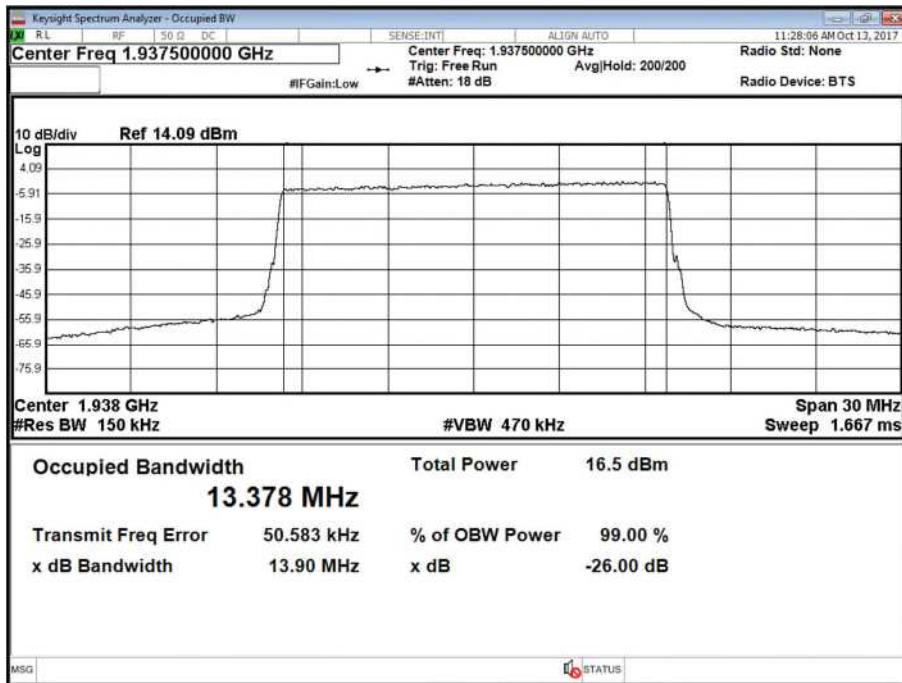

Antenna A - Bandwidth QPSK - Channel M

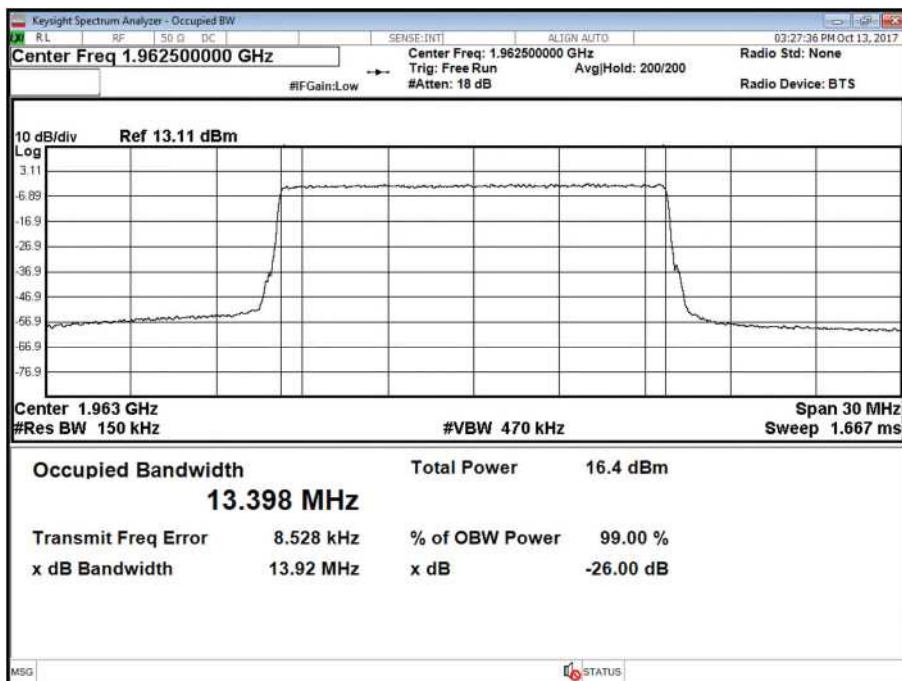



Product Service

Antenna B - Bandwidth QPSK - Channel M

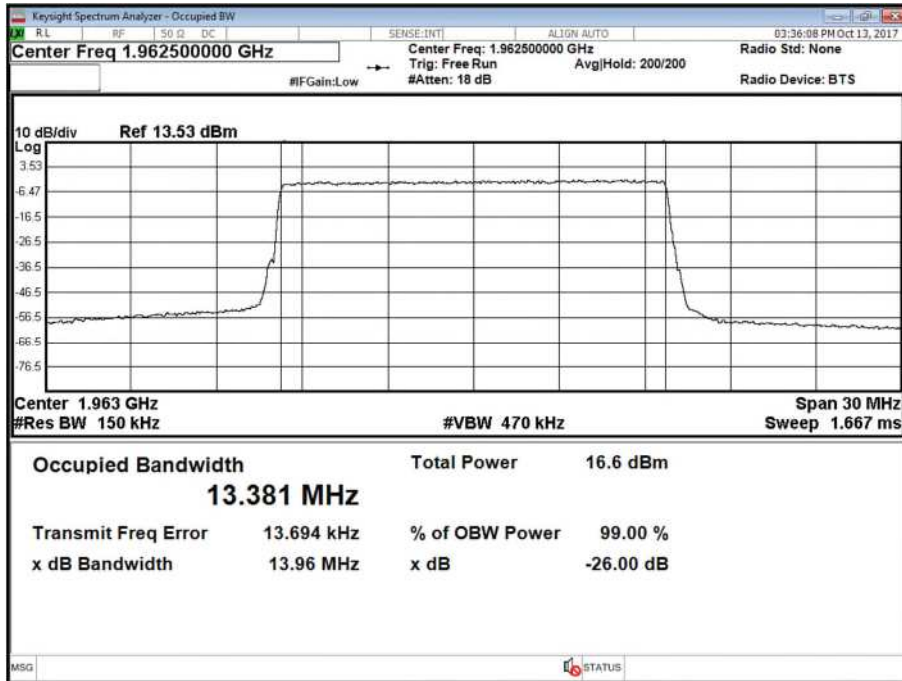

Antenna A - Bandwidth QPSK - Channel T

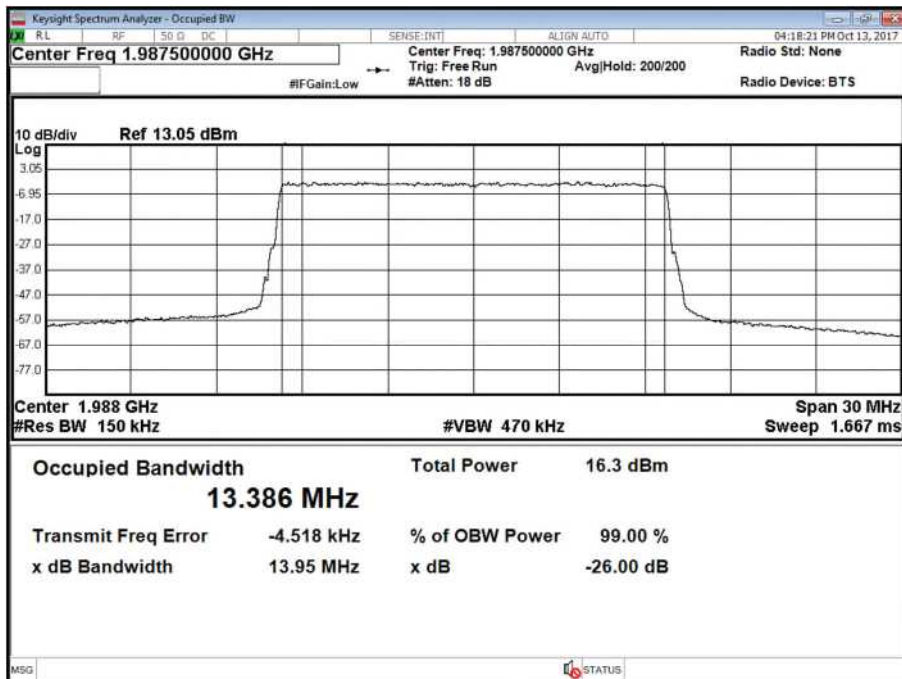



Product Service

Antenna B - Bandwidth QPSK - Channel T

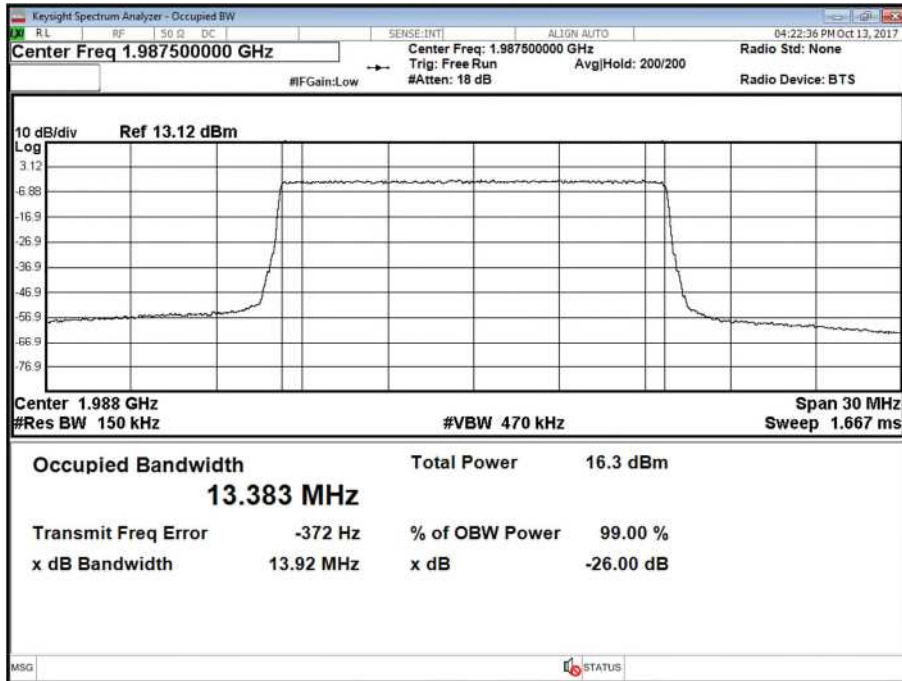

Antenna A - Bandwidth QPSK - Channel B

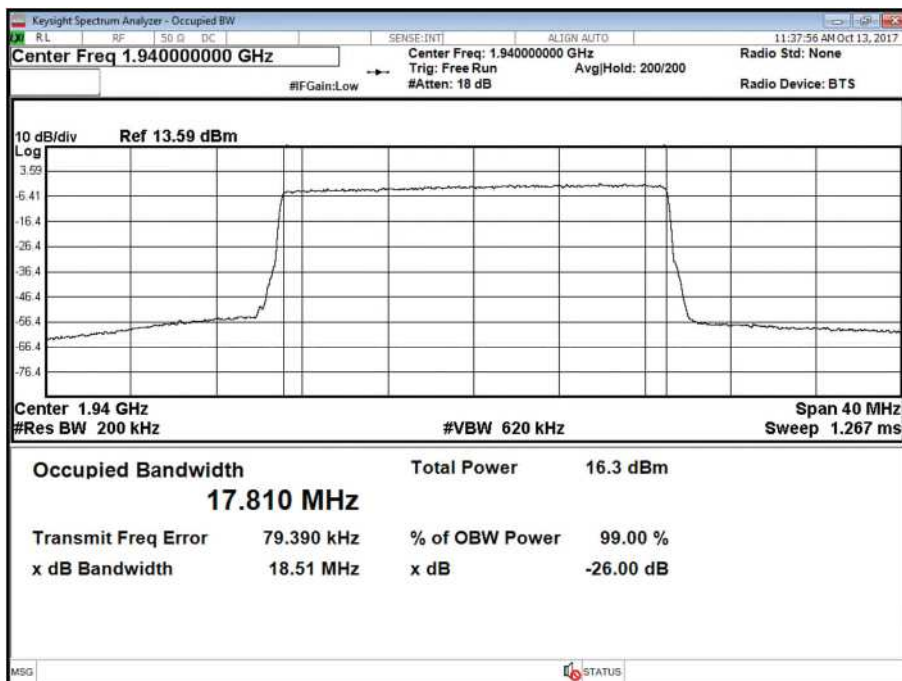



Product Service

Antenna B - Bandwidth QPSK - Channel B

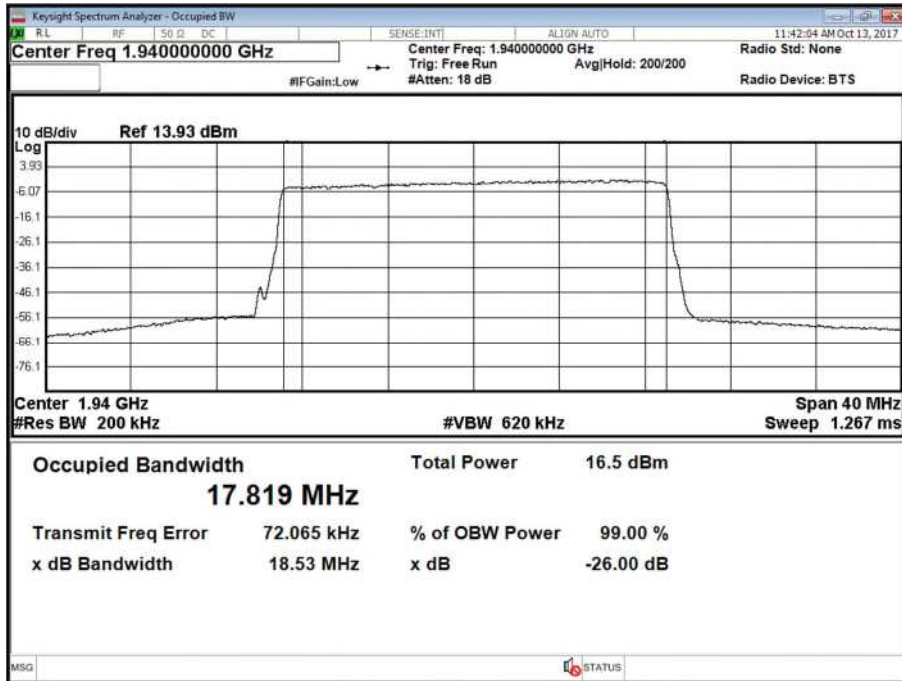

Antenna A - Bandwidth QPSK - Channel M

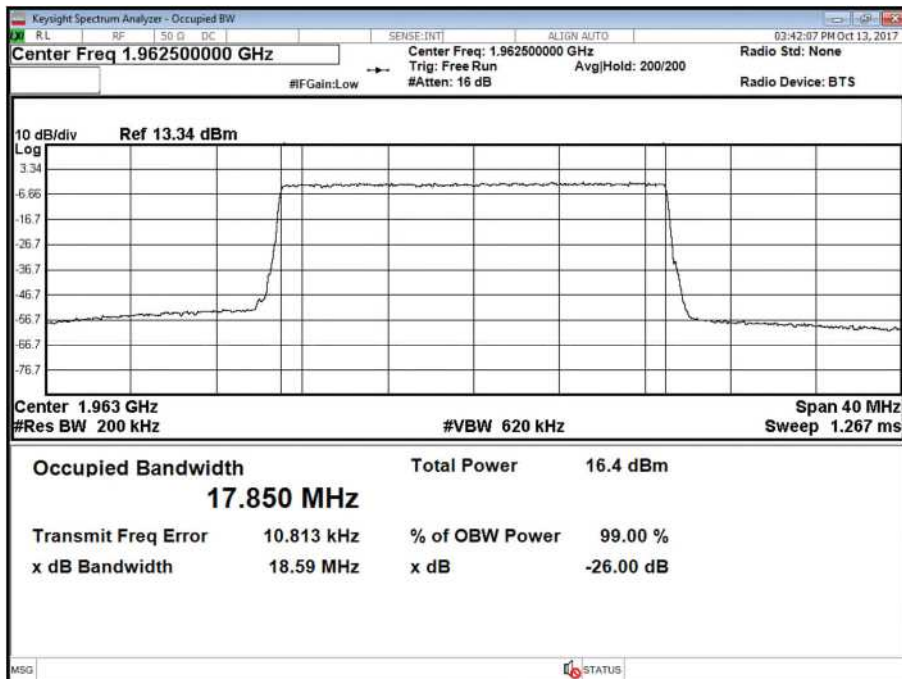



Product Service

Antenna B - Bandwidth QPSK - Channel M

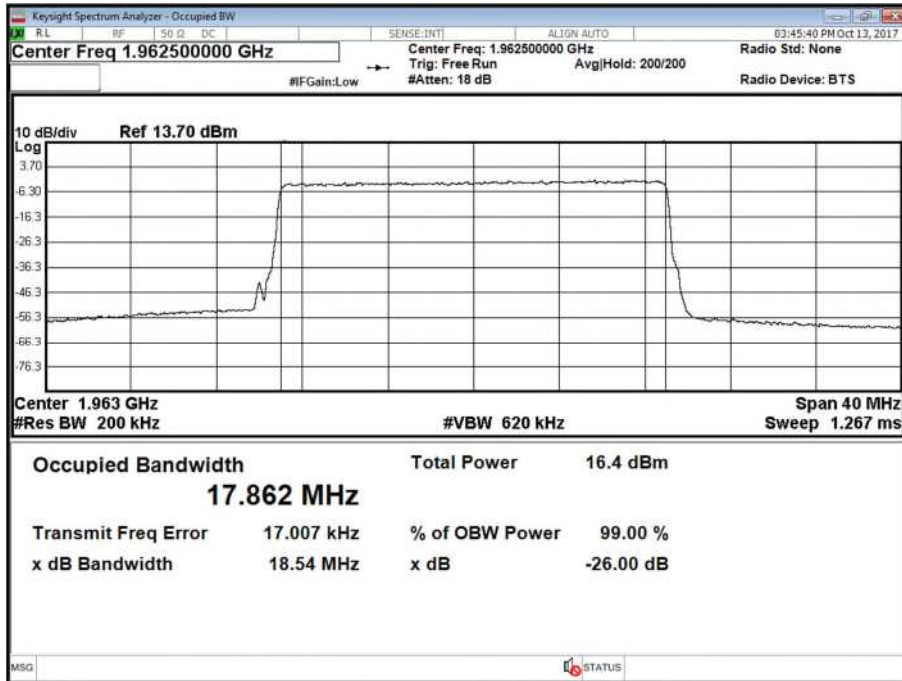

Antenna A - Bandwidth QPSK - Channel T

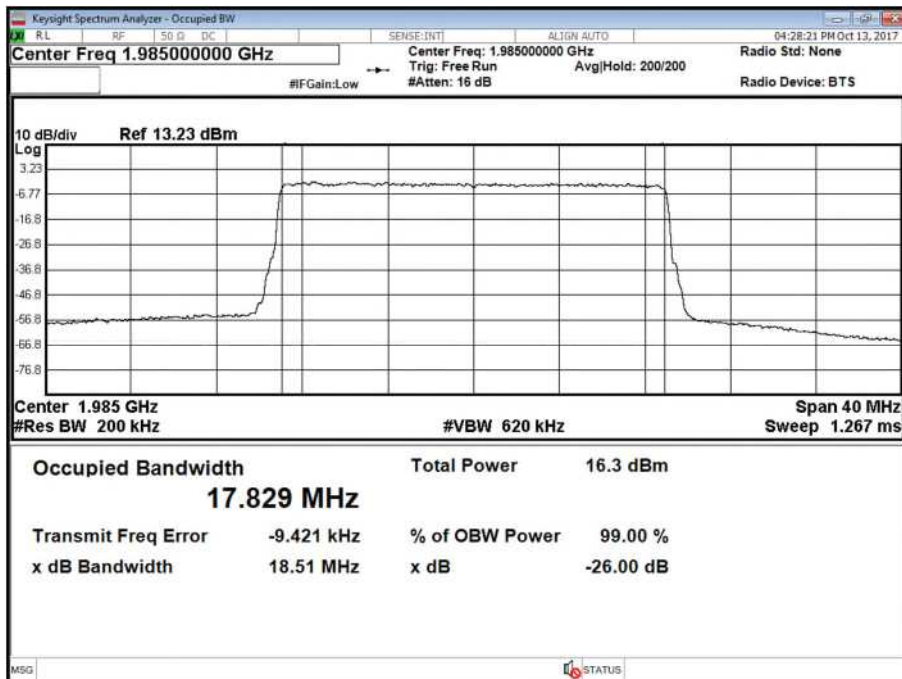



Product Service

Antenna B - Bandwidth QPSK - Channel T

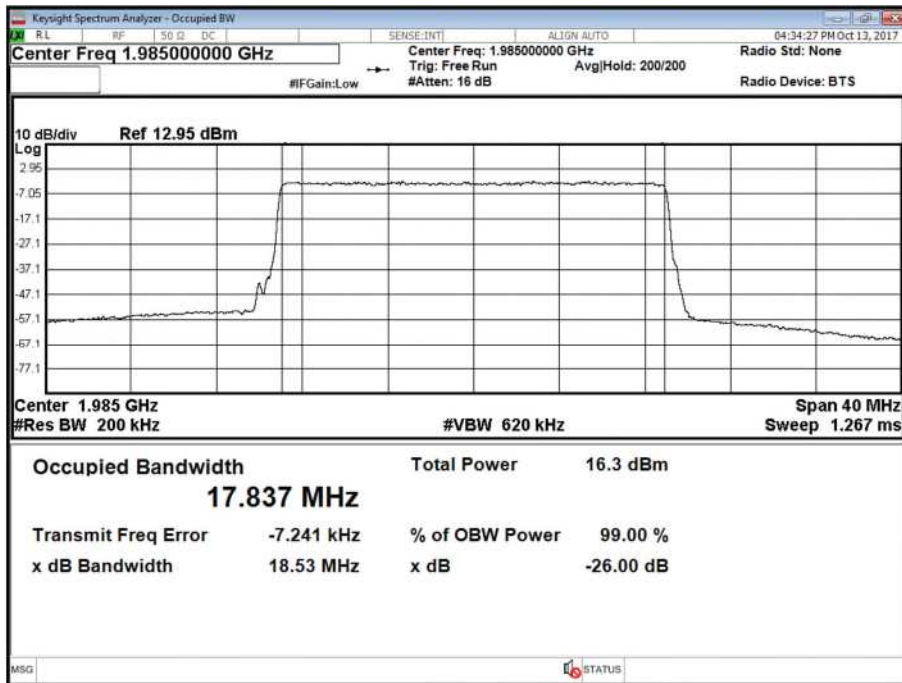



2.3 BAND EDGE

2.3.1 Specification Reference

FCC CFR 47 Part 2, Clause 2.1051
FCC CFR 47 Part 24, Clause 24.238 (b)
Industry Canada RSS-133, Clause 6.5

2.3.2 Date of Test and Modification State

12, 13, 16, 17 October 2017 - Modification State 0

2.3.3 Test Equipment Used

The major items of test equipment used for the above tests are identified in Section 3.1.

2.3.4 Environmental Conditions

Ambient Temperature 23°C
Relative Humidity 50%

2.3.5 Test Method

All measurements were made in accordance with FCC KDB 971168 D01 Clause 6. The EUT was connected to a Spectrum Analyser via an attenuator and switching box. The path loss between the EUT and the Spectrum Analyser was measured using a Network Analyser. The measured path loss was entered as a Reference Level Offset in the Spectrum Analyser. The Spectrum Analyser RBW was adjusted to be at least 1% of the measured 26dB Bandwidth. Using an RMS detector, the frequency spectrum up to 1MHz away from the Band Edge was investigated. The B25 EUT has 2 transmit ports, but can be configured to operate with 2 devices co-located. Therefore, the test limits used were calculated on a worst-case basis accounting for an effective 4 port MIMO configuration. Testing was performed on this port with a test limit of $43+10\log(P) - 10\log(4) = -19$ dBm.

2.3.6 Test Results

Configuration 1

Maximum Output Power 17 dBm

Antenna	WCDMA Modulation	WCDMA Carrier Bandwidth	Band Edge (MHz)	
			Channel Position B	Channel Position T
A	16QAM	5.0 MHz	1,932.4	1,992.6
B	16QAM	5.0 MHz	1,932.4	1,992.6



Product Service

Antenna A - WCDMA Modulation 16QAM - Channel B

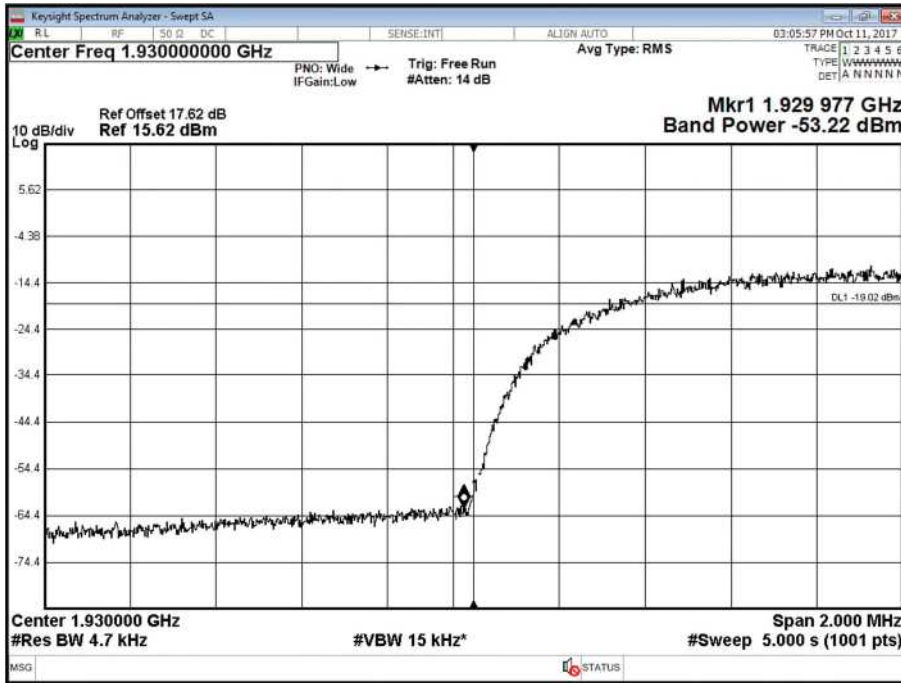

Antenna B - WCDMA Modulation 16QAM - Channel B

