



Choose Scandinavian trust

Radio Test report – AIR 1641 B2/25a B66a

Project number:

391738-1TRFWL-R1

Applicant:

Ericsson Canada

Product:

AIR 1641

Model:

AIR 1641 B2/25a B66a

Part number:

KRD 901 800/1

FCC ID:

TA8AKRD901800-1

ISED Reg. Number

287AB-AS9018001

HVIN:

AS9018001

Requirements/Summary:

Standard	Environmental phenomenon	Compliance
FCC 47 CFR Part 27	Miscellaneous wireless communications services	Yes
FCC 47 CFR Part 24, Subpart E	Broadband Personal Communications Services (PCS)	Yes
RSS-133 Issue 6 A1, Jan 18, 2018	2 GHz Personal Communications Services	Yes
RSS-139 Issue 3, July 16, 2015	Advanced Wireless Services (AWS) Equipment Operating in the Bands 1710–1780 MHz and 2110–2180 MHz	Yes
RSS-170 Issue 3, July 9, 2015	Ancillary Terrestrial Component (ATC) Equipment Operating in the Mobile-Satellite Service (MSS) Bands	Yes

Date of issue: February 25, 2020

Andrey Adelberg, Senior EMC/Wireless Specialist

Tested by

Signature

Predrag Golic, EMC Specialist

Tested by

Signature

David Duchesne, Senior EMC/Wireless Specialist

Reviewed by

Signature



Two test locations

Company name	Nemko Canada Inc.	
Address	303 River Road	349 Terry Fox
City	Ottawa	Ottawa
Province	Ontario	Ontario
Postal code	K1V 1H2	K2K 2V6
Country	Canada	Canada
Telephone	+1 613 737 9680	+1 613 963 8000
Facsimile	+1 613 737 9691	
Toll free	+1 800 563 6336	
Website	www.nemko.com	
Site number	FCC test site registration number: CA2040, IC: 2040A-4 (3 m semi anechoic chamber)	

Limits of responsibility

Note that the results contained in this report relate only to the items tested and were obtained in the period between the date of initial receipt of samples and the date of issue of the report.

This test report has been completed in accordance with the requirements of ISO/IEC 17025. All results contain in this reAnt Are within Nemko Canada's ISO/IEC 17025 accreditation.

Copyright notification

Nemko Canada Inc. authorizes the applicant to reproduce this report provided it is reproduced in its entirety and for use by the company's employees only. Any use which a third party makes of this report, or any reliance on or decisions to be made based on it, are the responsibility of such third parties.

Nemko Canada Inc. accepts no responsibility for damages, if any, suffered by any third party as a result of decisions made or actions based on this report.

© Nemko Canada Inc.

Table of contents

Table of contents	3
Section 1. Report summary	4
1.1 Applicant and manufacturer	4
1.2 Test specifications	4
1.3 Test method	4
1.4 Statement of compliance	4
1.5 Test report revision history	4
Section 2. Summary of test results	5
2.1 FCC Part 27 test results	5
2.2 FCC Part 24 test results	5
2.3 RSS-133 test results	5
2.4 RSS-139 test results	5
2.5 RSS-170 test results	5
Section 3. Equipment under test (EUT) details	6
3.1 Sample information	6
3.2 EUT information	6
3.3 Product description and theory of operation	7
3.4 EUT test details	8
3.5 EUT setup diagram	11
3.6 Setup photographs	12
Section 4. Engineering considerations	14
4.1 Modifications incorporated in the EUT	14
4.2 Technical judgment	14
4.3 Deviations from laboratory tests procedures	14
Section 5. Test conditions	15
5.1 Atmospheric conditions	15
5.2 Power supply range	15
Section 6. Measurement uncertainty	16
6.1 Uncertainty of measurement	16
Section 7. Test equipment	17
7.1 Test equipment list	17
Section 8. Testing data	18
8.1 FCC 27.50(d) and RSS-139, 4.1, RSS-170, 5.3 Maximum output power at RF antenna connector (B66)	18
8.2 FCC 24.232(a)(2) and RSS-133, 6.4 Transmitter output power (EIRP) and antenna height (B2/25a)	28
8.3 FCC 27.53 and RSS-139, 4.2, RSS-170, 5.4 Spurious emissions at RF antenna connector (Band 66)	38
8.4 FCC 27.53 and RSS-139, 4.2, RSS-170, 5.4 Radiated spurious emissions (Band 66 & Band 2/25)	55
8.5 FCC 24.238(a) and RSS-133, 6.5.1 Spurious out-of-band emissions (Band 2/25a)	59
8.6 FCC Part 2.1049 and RSS-Gen, 6.7 Occupied bandwidth (Band 66)	81
8.7 FCC Part 2.1049 and RSS-Gen, 6.7 Occupied bandwidth (Band 2/25a)	84
8.8 FCC 27.54 and RSS-139, Section 6.4 Frequency stability (Band 66)	87
8.9 FCC 24.235 and RSS-133, 6.3 Frequency stability (Band 2/25a)	88
8.10 RSS-133, 6.6 Receiver Spurious Emissions	89
Section 9. Block diagrams of test setups	90
9.1 Radiated emissions set-up for frequencies below 1 GHz	90
9.2 Radiated emissions set-up for frequencies above 1 GHz	90
9.3 Conducted emissions set-up	91

Section 1. Report summary

1.1 Applicant and manufacturer

Company name	Ericsson Canada Inc.
Address	349 Terry Fox Drive, Ottawa, ON, Canada, K2K 2V6

1.2 Test specifications

FCC 47 CFR Part 2	Frequency Allocations and Radio Treaty Matters; General Rules and Regulations
FCC 47 CFR Part 24, Subpart E	Broadband Personal Communications Services (PCS)
FCC 47 CFR Part 27	Miscellaneous wireless communications services (2110–2200 MHz)
RSS-133 Issue 6 A1, Jan 18, 2018	2 GHz Personal Communications Services
RSS-139 Issue 3, July 16, 2015	Advanced Wireless Services (AWS) equipment operating in the bands 1710–1780 MHz and 2110–2180 MHz
SRSP-510, Issue 5, Feb. 2009	Technical Requirements for Personal Communications Services (PCS) in the Bands 1850–1915 MHz and 1930–1995 MHz
RSS-170 Issue 3, July 9, 2015	Ancillary Terrestrial Component (ATC) Equipment Operating in the Mobile-Satellite Service (MSS) Bands
RSS-Gen, Issue 5, April 2018	General Requirements for Compliance of Radio Apparatus

Equipment operating in the ancillary terrestrial component (ATC) of the frequency bands 2000–2020 MHz and 2180–2200 MHz is certified under RSS-170.

1.3 Test method

ANSI C63.26-2015	American National Standard for Compliance Testing of Transmitters Used in Licensed Radio Services
KDB 662911 D01	Multiple Transmitter Output v02r01
KDB 662911 D02	MIMO with Cross-Polarized Antennas v01

1.4 Statement of compliance

In the configuration tested, the EUT was found compliant. Testing was completed against all relevant requirements of the test standard. Results obtained indicate that the product under test complies in full with the requirements tested.

This report (**391738-1TRFWL-R1**) applies to the AIR 1641 B2/25a and B66 with model number KR D 901 800/1. See “Summary of test results” for full details.

EUT Configuration(s):

LTE: 10, 15, 20 MHz (1-2 Carriers)

LTE + NB IoT (GB, IB): 10, 15, 20 MHz

1.5 Test report revision history

Table 1.5-1: Test report revision history

Revision #	Details of changes made to test report
TRFWL-R1	Original report issued

Section 2. Summary of test results

2.1 FCC Part 27 test results

Part	Test description	Verdict
§27.50(b)	Maximum output power at RF antenna connector	Pass
§27.53	Spurious emissions at RF antenna connector	Pass
§27.53	Radiated spurious emissions (conducted and radiated)	Pass
§27.54	Frequency stability	Pass
§2.1049	Occupied bandwidth	Pass

2.2 FCC Part 24 test results

Part	Test description	Verdict
§24.229	Frequencies	Pass ¹
§24.232(a)(2)	Power and antenna height limits for base stations with BW greater than 1 MHz	Pass
§24.235	Frequency stability	Pass
§24.238(a)	Emission limitations for Broadband PCS equipment – out of band emissions (conducted and radiated)	Pass
§2.1049	Occupied bandwidth	Pass

Notes: ¹EUT transmits within 1930–1995 MHz frequency range

2.3 RSS-133 test results

Part	Test description	Verdict
6.1	Frequency Plan	Pass ¹
6.2	Types of Modulation	Pass ²
6.3	Frequency stability	Pass
6.4	Transmitter Output Power and Equivalent Isotropically Radiated Power	Pass
6.5	Transmitter Unwanted Emissions (conducted and radiated)	Pass
6.6	Receiver Spurious Emissions	Pass
RSS-Gen, 6.7	Occupied bandwidth	Pass

Notes: ¹EUT transmits within 1930–1995 MHz frequency range. ²EUT employs digital modulation (QPSK to 256-QAM)

2.4 RSS-139 test results

Part	Test description	Verdict
4.1	Transmitter output power and Equivalent Isotropic Radiated Power (e.i.r.p.)	Pass
4.2	Spurious emissions at RF antenna connector	Pass
4.2	Radiated spurious emissions (conducted and radiated)	Pass
6.4	Transmitter frequency stability	Pass
RSS-Gen, 6.7	Occupied bandwidth	Pass

2.5 RSS-170 test results

Part	Test description	Verdict
5.3	Transmitter output power and Equivalent Isotropic Radiated Power (e.i.r.p.)	Pass
5.4	Spurious emissions at RF antenna connector	Pass
5.4	Radiated spurious emissions (conducted and radiated)	Pass
5.2	Frequency stability	Pass
RSS-Gen, 6.7	Occupied bandwidth	Pass

Note: ATC Base Station Equipment operating in bands 2000–2020 MHz and 2180–2200 MHz

The unwanted emissions of ATC base station equipment transmitting in the bands 2000–2020 MHz and 2180–2200 MHz shall comply with the following:

- (1) The power of any unwanted emissions at frequencies outside the equipment's operating frequency block shall be attenuated below the transmitter power P (dBW), by $43 + 10 \log p$ (watts), dB.
- (2) For equipment operating in the band 2180–2200 MHz, in addition to (1), the power of any emissions on all frequencies between 2200 MHz and 2290 MHz shall not exceed an e.i.r.p. of $-100.6 \text{ dBW}/4 \text{ kHz}$ ($-70.6 \text{ dBm}/4 \text{ kHz}$).

* This requirement is for implementation and is enforced at the time of licensing. Therefore, results are not included in this report.

Section 3. Equipment under test (EUT) details

3.1 Sample information

Receipt date	January 20, 2020
Nemko sample ID number	None

3.2 EUT information

Product name	AIR 1641
Model	AIR 1641 B2/25a B66a
Part number	KRD 901 800/1
Revision	R1D
Serial number	E23B014781
Antenna ports	16 TX/RX Ports
RF BW / IBW	B25 IBW DL: 65 MHz B25 IBW UL: 65 MHz B66 IBW DL: 90 MHz B66 IBW UL: 70 MHz
FDD	B2/25: 80 MHz B66: 400 MHz
Frequency	B25 TX (DL): 1930–1995 MHz B25 RX (UL): 1850–1915 MHz B66 TX (DL): 2110–2200 MHz B66 RX (UL): 1710–1780 MHz
Nominal O/P per Antenna port	20 W (43 dBm): 10 W (40 dBm) per Band
Nominal O/P per Band	Single Carrier: 1 × 10 W (40 dBm) 2 Carrier: 2 × 5 W (40 dBm total)
Accuracy (nominal)	±0.1 ppm
Nominal voltage	-48 V _{DC} @ 40 A
RAT	LTE: SC, MC, IoT (GB, IB)
Modulation	LTE: QPSK, 16 QAM, 64 QAM, 256 QAM
Channel bandwidth	LTE: 10, 15, 20 MHz
Channel bandwidth LTE + NB IoT	LTE + NB IoT: GB, IB (200 kHz) LTE BW: 10, 15, 20 MHz (IB, GB)
Maximum combined OBW per port	B2/25: 65 MHz B66: 90 MHz
CPRI	10 Gbps
Channel raster	LTE: 100 kHz
Regulatory requirements	Radio: FCC Part 2, 24, 27, RSS-Gen, RSS-133, RSS-139, RSS-170 EMC: FCC Part 15, ICES-003 Safety: IEC/EN 62368-1, UL/CSA 62368-1 IEC/EN 60950-22, UL 50E
Emission Designator	LTE: 10M0W7D, 15M0W7D, 20M0W7D
Supported Configurations	Single Antenna, TX Diversity, MIMO, Carrier Aggregation
Operating temperature	-40 °C to +55 °C
Total Power based on IBW	160 W/band; Total (Radio) 320 W (16 × 20 W)
Supported carrier / port	LTE: (1-2) LTE + IoT: GB (1-2), IB (1-2)

3.3 Product description and theory of operation

EUT description of the methods used to exercise the EUT and all relevant ports:

Description/theory of operation	<p>The AIR 1641 B2/25a B66a (KRD 901 800/1) is a multi-standard remote Dual Band radio forming part of the Ericsson RBS (Radio Base Station) equipment. The AIR (Antenna Integrated Radio) 1641 provides radio access for mobile and fixed devices and is designed for the outdoor environment. The AIR 1641 operates over 2 bands (Band 2/25 and Band 66) via 16 TX/RX ports connected directly into an integrated antenna. Radio unit installation is designed for pole, wall or mast mount options. A fiber optic interface (4) provides the RRU/RBS control and digital interface between the Radio and the RBS. The AIR 1641 product is convection cooled and shall be mounted vertically.</p> <p>Output RF Power is rated at 16 × 10 W (per Band). Altitude during operation: Below 4000 m</p> <p>The AIR 1641 is a synthesized Transceiver designed for use in the 3GPP (Third Generation Partnership Project) for LTE (Long Term Evolution) - E-UTRA Base Station. AIR 1641 B2/25a B66a is a 16TX/16RX remote radio unit (RRU). This RRU operates in Band 2/25 as defined by 3GPP. TX (DL): 1930–1995 MHz, RX (UL): 1850–1915 MHz and Band 66 TX (DL): 2110–2200 MHz, RX (UL): 1710–1780 MHz For LTE, the AIR 1641 B2/25a B66a supports modulations QPSK, 16QAM, 64QAM and 256QAM. Channel Bandwidth is configurable for 10, 15 or 20 MHz. The Radio transmits in single carrier mode and multi carrier mode within the Band Specific IBW (Instantaneous Band Width). NB IoT is supported for IB and GB.</p> <p>The AIR 1641 supports single and multi-beam FD MIMO (Multiple Input Multiple Output) and Carrier Aggregation for LTE.</p> <p>Test Configuration:</p> <p>KRC 161 800/1: The radio functionality and performance is evaluated without the antenna attached. This configuration replaces the antenna with the Ericsson RDNB (Radio Distribution Network Board) providing access to the RF Ports for compliance measurements. The RDNB is an ODM supplied assembly (KRE 105 341/1R) designed to plug into and support the radio equipment assessment, test and compliance verification.</p>																																																											
Ant Description	<table border="1"> <thead> <tr> <th>Port</th> <th>Description</th> </tr> </thead> <tbody> <tr> <td>ANT 1–16</td> <td>RF Output ports from 1 to 16</td> </tr> <tr> <td>Alarm</td> <td>Alarm</td> </tr> <tr> <td>Data 1</td> <td>Optical Interface Data 1</td> </tr> <tr> <td>Data 2</td> <td>Optical Interface Data 2</td> </tr> <tr> <td>Data 3</td> <td>Optical Interface Data 3</td> </tr> <tr> <td>Data 4</td> <td>Optical Interface Data 4</td> </tr> <tr> <td>DC Input</td> <td>–48 V_{DC}</td> </tr> <tr> <td>MMI</td> <td>Display - Radio Status</td> </tr> <tr> <td>GND</td> <td>Ground</td> </tr> </tbody> </table>					Port	Description	ANT 1–16	RF Output ports from 1 to 16	Alarm	Alarm	Data 1	Optical Interface Data 1	Data 2	Optical Interface Data 2	Data 3	Optical Interface Data 3	Data 4	Optical Interface Data 4	DC Input	–48 V _{DC}	MMI	Display - Radio Status	GND	Ground																																			
Port	Description																																																											
ANT 1–16	RF Output ports from 1 to 16																																																											
Alarm	Alarm																																																											
Data 1	Optical Interface Data 1																																																											
Data 2	Optical Interface Data 2																																																											
Data 3	Optical Interface Data 3																																																											
Data 4	Optical Interface Data 4																																																											
DC Input	–48 V _{DC}																																																											
MMI	Display - Radio Status																																																											
GND	Ground																																																											
Physical	<table border="1"> <tbody> <tr> <td>Dimensions</td> <td colspan="4">1555 mm × 635 mm × 320 mm (H × W × D)</td> </tr> <tr> <td>Weight</td> <td colspan="4">101 kg</td> </tr> <tr> <td>Operating Temperature</td> <td colspan="4">–40 to +55 °C</td> </tr> <tr> <td>Mounting</td> <td colspan="4">Pole, Wall, Mast Mount</td> </tr> <tr> <td>Cooling</td> <td colspan="4">Convection (forced air)</td> </tr> </tbody> </table>					Dimensions	1555 mm × 635 mm × 320 mm (H × W × D)				Weight	101 kg				Operating Temperature	–40 to +55 °C				Mounting	Pole, Wall, Mast Mount				Cooling	Convection (forced air)																																	
Dimensions	1555 mm × 635 mm × 320 mm (H × W × D)																																																											
Weight	101 kg																																																											
Operating Temperature	–40 to +55 °C																																																											
Mounting	Pole, Wall, Mast Mount																																																											
Cooling	Convection (forced air)																																																											
Software details	CXP9017316%12-R81JC																																																											
Radio Hardware Configuration	<table border="1"> <thead> <tr> <th>Product: KRD 901 800/1</th> <th>R1D</th> <th>KRC 161 800/1</th> <th>R1D</th> <th>Description</th> </tr> </thead> <tbody> <tr> <td>KRY 901 800/1</td> <td>R1C</td> <td>KRY 901 800/1</td> <td>R1C</td> <td>Radio Unit</td> </tr> <tr> <td>ROA 128 6840/625</td> <td>R1C</td> <td>ROA 128 6840/625</td> <td>R1C</td> <td>Radio PCP (4)</td> </tr> <tr> <td>ROA 128 6850/625</td> <td>R1B</td> <td>ROA 128 6850/625</td> <td>R1B</td> <td>FIB PCP</td> </tr> <tr> <td>ROA 128 6860/625</td> <td>R1B</td> <td>ROA 128 6860/625</td> <td>R1B</td> <td>PCB PCP</td> </tr> <tr> <td>KRF 901 800</td> <td>R1A</td> <td>KRF 901 800</td> <td>R1A</td> <td>Filter Unit (4)</td> </tr> <tr> <td>NTB 101 0679/1</td> <td>R1B</td> <td>NTB 101 0679/1</td> <td>R1B</td> <td>Parts</td> </tr> <tr> <td>KRY 901 850/1</td> <td>R1B</td> <td>KRY 901 850/1</td> <td>R1B</td> <td>I/O Assembly</td> </tr> <tr> <td>ROA 128 6850/99</td> <td>R1B</td> <td>ROA 128 6850/99</td> <td>R1B</td> <td>PCB SFP Daughter Card</td> </tr> <tr> <td>KRE 105 322</td> <td>R1B</td> <td>KRE 105 341/1R</td> <td>R1B</td> <td>Antenna / RDNB</td> </tr> <tr> <td>NTB 101 0678/1</td> <td>R1B</td> <td>NTB 101 0678/1</td> <td>R1B</td> <td>Parts</td> </tr> </tbody> </table>					Product: KRD 901 800/1	R1D	KRC 161 800/1	R1D	Description	KRY 901 800/1	R1C	KRY 901 800/1	R1C	Radio Unit	ROA 128 6840/625	R1C	ROA 128 6840/625	R1C	Radio PCP (4)	ROA 128 6850/625	R1B	ROA 128 6850/625	R1B	FIB PCP	ROA 128 6860/625	R1B	ROA 128 6860/625	R1B	PCB PCP	KRF 901 800	R1A	KRF 901 800	R1A	Filter Unit (4)	NTB 101 0679/1	R1B	NTB 101 0679/1	R1B	Parts	KRY 901 850/1	R1B	KRY 901 850/1	R1B	I/O Assembly	ROA 128 6850/99	R1B	ROA 128 6850/99	R1B	PCB SFP Daughter Card	KRE 105 322	R1B	KRE 105 341/1R	R1B	Antenna / RDNB	NTB 101 0678/1	R1B	NTB 101 0678/1	R1B	Parts
Product: KRD 901 800/1	R1D	KRC 161 800/1	R1D	Description																																																								
KRY 901 800/1	R1C	KRY 901 800/1	R1C	Radio Unit																																																								
ROA 128 6840/625	R1C	ROA 128 6840/625	R1C	Radio PCP (4)																																																								
ROA 128 6850/625	R1B	ROA 128 6850/625	R1B	FIB PCP																																																								
ROA 128 6860/625	R1B	ROA 128 6860/625	R1B	PCB PCP																																																								
KRF 901 800	R1A	KRF 901 800	R1A	Filter Unit (4)																																																								
NTB 101 0679/1	R1B	NTB 101 0679/1	R1B	Parts																																																								
KRY 901 850/1	R1B	KRY 901 850/1	R1B	I/O Assembly																																																								
ROA 128 6850/99	R1B	ROA 128 6850/99	R1B	PCB SFP Daughter Card																																																								
KRE 105 322	R1B	KRE 105 341/1R	R1B	Antenna / RDNB																																																								
NTB 101 0678/1	R1B	NTB 101 0678/1	R1B	Parts																																																								
Product Identification Label	 <div style="border: 1px solid black; padding: 5px; display: inline-block;"> <p>FCC ID: TA8AKRD901800-1 IC: 287AB-AS9018001 AS9018001</p> </div>																																																											

3.4 EUT test details

EUT setup/configuration rationale:

Down link	RAT	Modulation	Performance Requirement	Test Model / Configuration	
	LTE	QPSK	N/A	E-TM1.1	
	LTE	16QAM	N/A	E-TM3.2	
	LTE	64QAM	N/A	E-TM3.1	
LTE	256QAM	N/A	E-TM3.1a		
Up link	RAT	Modulation	Performance Requirement	Input Signal	Test Model / Configuration
	LTE	QPSK	N/A		E-UTRA-UL

Single carrier B25

Bandwidth, MHz	LTE Transmit / DL, MHz					
	B	EARFCN	M	EARFCN	T	EARFCN
5	1932.5	66461	1962.5	66761	1992.5	67061
10	1935.0	66486	1962.5	66761	1990.0	67036
15	1937.5	66511	1962.5	66761	1987.5	67011
20	1940.0	66536	1962.5	66761	1985.0	66986

Bandwidth, MHz	LTE Receive / UL, MHz					
	B	EARFCN	M	EARFCN	T	EARFCN
5	1852.5	131997	1882.5	132297	1912.5	132597
10	1855.0	132022	1882.5	132297	1910.0	132572
15	1857.5	132047	1882.5	132297	1907.5	132547
20	1860.0	132072	1882.5	132297	1905.0	132522

Single carrier B66

Bandwidth, MHz	LTE Transmit / DL, MHz					
	B	EARFCN	M	EARFCN	T	EARFCN
5	2112.5	66461	2155.0	66886	2197.5	67311
10	2115.0	66486	2155.0	66886	2195.0	67286
15	2117.5	66511	2155.0	66886	2192.5	67261
20	2120.0	66536	2155.0	66886	2190.0	67236

Bandwidth, MHz	LTE Receive / UL, MHz					
	B	EARFCN	M	EARFCN	T	EARFCN
5	1712.5	131997	1745.0	132322	1777.5	132647
10	1715.0	132022	1745.0	132322	1775.0	132622
15	1717.5	132047	1745.0	132322	1772.5	132597
20	1720.0	132072	1745.0	132322	1770.0	132572

B25 LTE Multi-Carrier for Band Edge Emissions:

Bandwidth, MHz	Transmit / DL, MHz							
	B1	EARFCN	B2	EARFCN	T2	EARFCN	T1	EARFCN
5	1932.5	66461	1937.5	66511	1987.5	67011	1992.5	67061
10	1935.0	66486	1945.0	66586	1980.0	66936	1990.0	67036
15	1937.5	66511	1952.5	66661	1972.5	66861	1987.5	67011
20	1940.0	66536	1960.0	66736	1965.0	66786	1985.0	66986

Bandwidth, MHz	Receive / UL, MHz							
	B1	EARFCN	B2	EARFCN	T2	EARFCN	T1	EARFCN
5	1852.5	131997	1857.5	132047	1907.5	132547	1912.5	132597
10	1855.0	132022	1865.0	132122	1900.0	132472	1910.0	132572
15	1857.5	132047	1872.5	132197	1892.5	132397	1907.5	132547
20	1860.0	132072	1880.0	132272	1885.0	132322	1905.0	132522

B66 LTE Multi-Carrier for Band Edge Emissions:

Bandwidth, MHz	Transmit / DL, MHz							
	B1	EARFCN	B2	EARFCN	T2	EARFCN	T1	EARFCN
5	2112.5	66461	2117.5	66511	2192.5	67261	2197.5	67311
10	2115.0	66486	2125.0	66586	2185.0	67186	2195.0	67286
15	2117.5	66511	2132.5	66661	2177.5	67111	2192.5	67261
20	2120.0	66536	2140.0	66736	2170.0	67036	2190.0	67236

Bandwidth, MHz	Receive / UL, MHz							
	B1	EARFCN	B2	EARFCN	T2	EARFCN	T1	EARFCN
5	1712.5	131997	1717.5	132047	1772.5	132597	1777.5	132647
10	1715.0	132022	1725.0	132122	1765.0	132522	1775.0	132622
15	1717.5	132047	1732.5	132197	1757.5	132447	1772.5	132597
20	1720.0	132072	1740.0	132272	1750.0	132372	1770.0	132572

B25 LTE Multiple-Carriers for spurious emissions (IBW=65MHz):

Bandwidth (MHz)	Transmit / DL (MHz)			
	C1	EARFCN	C2	EARFCN
5	1932.5	66461	1992.5	67061
10	1935.0	66486	1990.0	67036
15	1937.5	66511	1987.5	67011
20	1940.0	66536	1985.0	66986

Bandwidth (MHz)	Receive / UL (MHz)			
	C1	EARFCN	C2	EARFCN
5	1852.5	131997	1912.5	132597
10	1855.0	132022	1910.0	132572
15	1857.5	132047	1907.5	132547
20	1860.0	132072	1905.0	132522

B66 LTE Multiple-Carriers for spurious emissions (IBW=70)

Bandwidth (MHz)	Transmit / DL (MHz)			
	C1	EARFCN	C2	EARFCN
5	2112.5	66461	2177.5	67111
10	2115.0	66486	2175.0	67086
15	2117.5	66511	2172.5	67061
20	2120.0	66536	2170.0	67036

Bandwidth (MHz)	Receive / UL (MHz)			
	C1	EARFCN	C2	EARFCN
5	1712.5	131997	1777.5	132647
10	1715.0	132022	1775.0	132622
15	1717.5	132047	1772.5	132597
20	1720.0	132072	1770.0	132572

EUT Monitoring Method / Equipment:

Support equipment	<p>Node EMC Test System</p> <ul style="list-style-type: none"> - Anritsu MS 2691 VSA/Sig Gen - HP Laptop - Timing and Synchronization box (GPS) - Ethernet Switch - Isolation Transformer <p>RBS 6601, BFM 901 009/1:</p> <ul style="list-style-type: none"> - DUS 4101 KDU 137 624/ 11, R4G, S/N: T48X68357 - DUS SW: CXP102051/27-R18A179 - Input Voltage: -48 V_{DC}
-------------------	---

3.5 EUT setup diagram

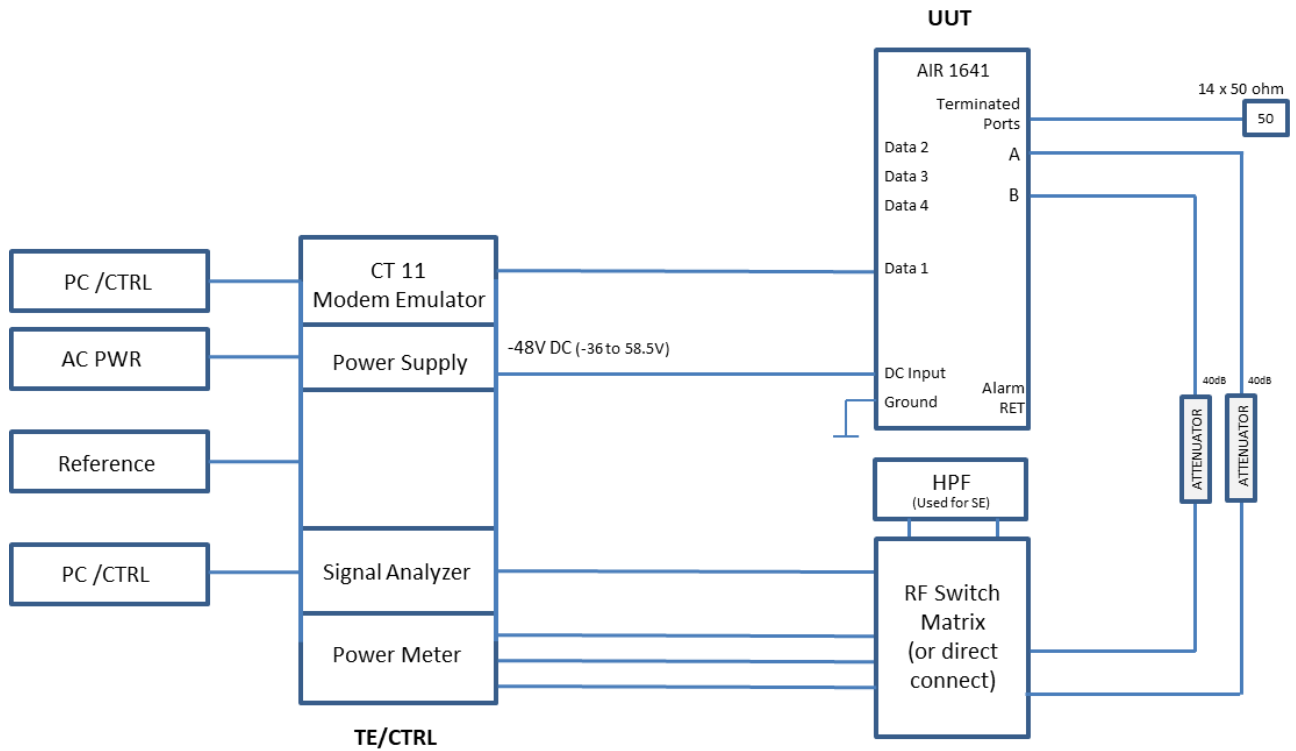

Figure 3.5-1: Setup diagram – Radio Compliance

3.6 Setup photographs

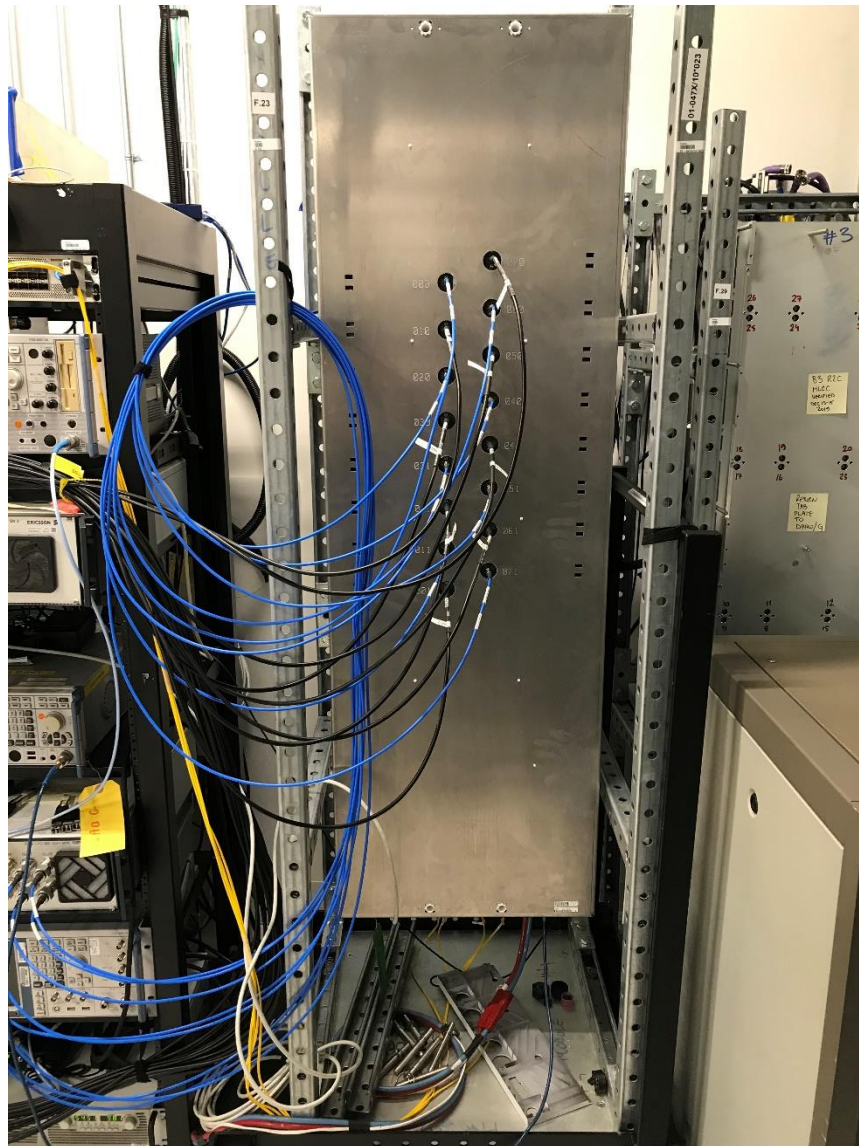

Figure 3.6-1: Set up photo for Radio Compliance Testing

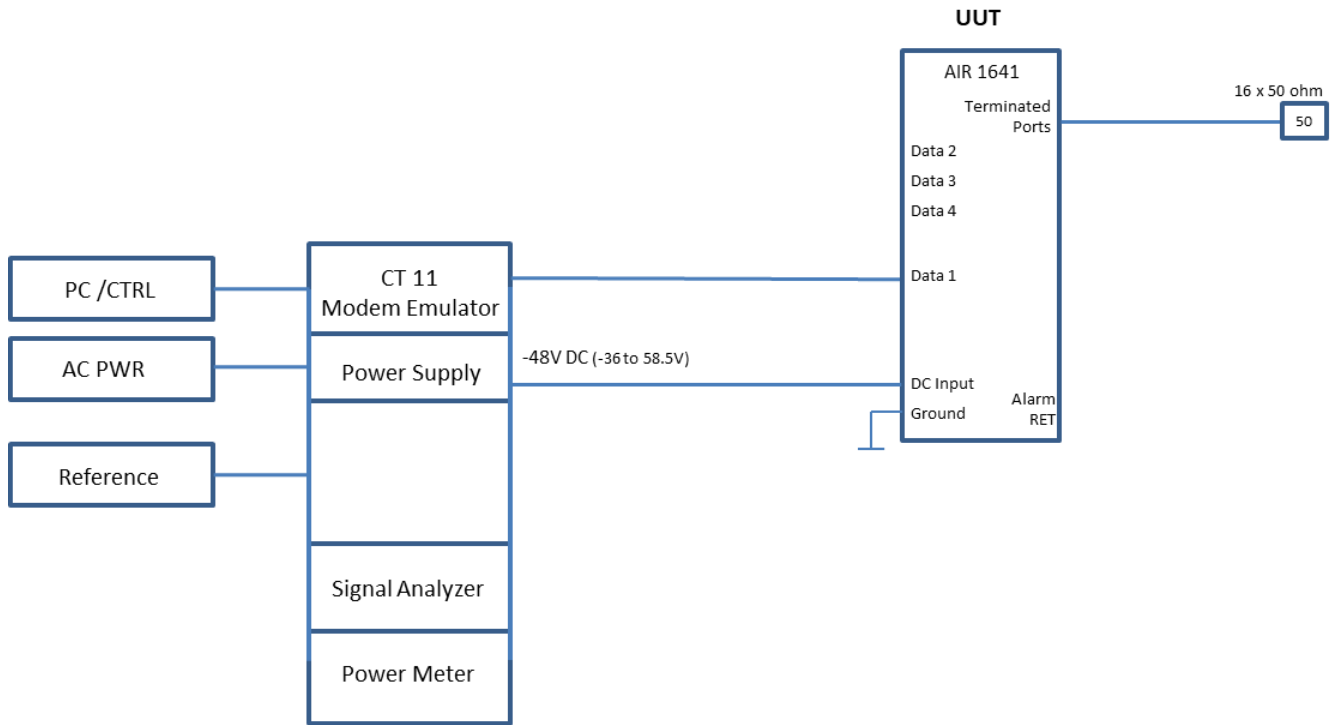

Figure 3.6-2: EUT Set-up diagram for Radiated Compliance Testing

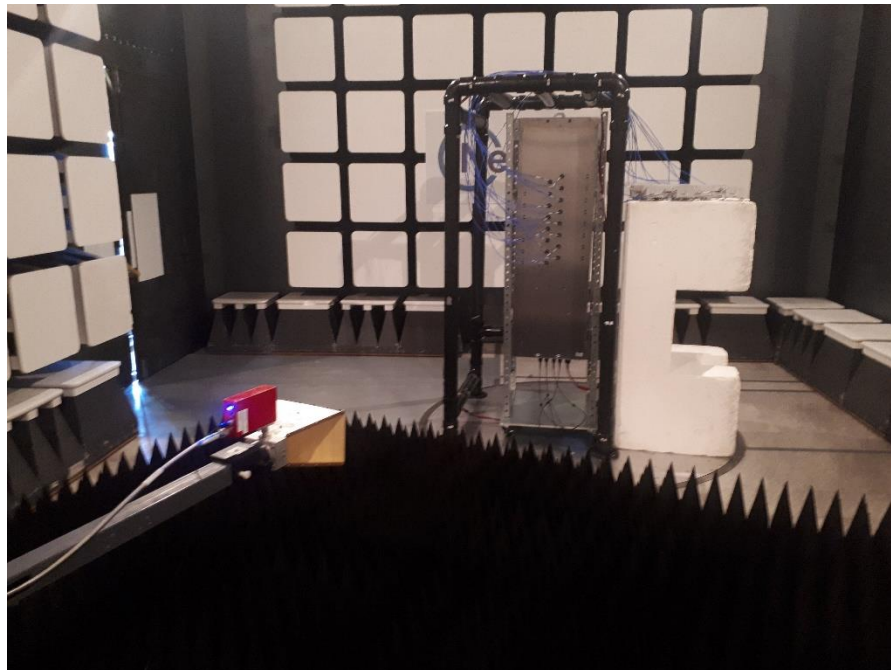

Figure 3.6-3: EUT Set-up photo for Radiated Compliance Testing

Section 4. Engineering considerations

4.1 Modifications incorporated in the EUT

There were no modifications performed to the EUT during this assessment.

4.2 Technical judgment

The testing was performed in accordance with the test plan, which suggested to measure output power on all 16 antenna ports, to find the port with the highest output power and perform the rest of the testing on that one representing antenna port.

4.3 Deviations from laboratory tests procedures

No deviations were made from laboratory procedures.

Section 5. Test conditions

5.1 Atmospheric conditions

Temperature	15–30 °C
Relative humidity	20–75 %
Air pressure	860–1060 mbar

When it is impracticable to carry out tests under these conditions, a note to this effect stating the ambient temperature and relative humidity during the tests shall be recorded and stated.

5.2 Power supply range

The normal test voltage for equipment to be connected to the mains shall be the nominal mains voltage. For the purpose of the present document, the nominal voltage shall be the declared voltage, or any of the declared voltages $\pm 5\%$, for which the equipment was designed.

Section 6. Measurement uncertainty

6.1 Uncertainty of measurement

Measurement uncertainty budgets for the tests are detailed below. Measurement uncertainty calculations assume a coverage factor of $K = 2$ with 95% certainty.

Test name	Measurement uncertainty, dB
All antenna port measurements	0.55
Conducted spurious emissions	1.13
Radiated spurious emissions	3.78
AC power line conducted emissions	3.55

Section 7. Test equipment

7.1 Test equipment list

Table 7.1-1: Equipment list

Equipment	Manufacturer	Model no.	Asset no.	Cal cycle	Next cal.
3 m EMI test chamber	TDK	SAC-3	FA002047	1 year	January 24, 2021
Flush mount turntable	Sunol	FM2022	FA002082	—	NCR
Controller	Sunol	SC104V	FA002060	—	NCR
Antenna mast	Sunol	TLT2	FA002061	—	NCR
DC Power source	Ametek	SGA80X125C-0AAA	FA002737	—	VOU
Receiver/spectrum analyzer	Rohde & Schwarz	ESU 26	FA002043	1 year	May 8, 2020
Preamp (1–18 GHz)	ETS Lindgren	124334	FA002877	1 year	November 4, 2020
Biconical antenna (30–300 MHz)	Sunol	BC2	FA002078	1 year	October 31, 2020
Log periodic antenna (200–5000 MHz)	Sunol	LP5	FA002077	1 year	October 31, 2020
Horn antenna (1–18 GHz)	EMCO	3115	FA000825	1 year	October 31, 2020
Horn antenna (18–26.5 GHz)	Electro-metrics	SH-50/60-1	FA000479	—	VOU
Pre-amplifier (18–26 GHz)	Narda	BBS-1826N612	FA001550	—	VOU
50 Ω coax cable	C.C.A.	None	FA002556	1 year	April 18, 2020
50 Ω coax cable	Huber + Suhner	None	FA003099	1 year	May 10, 2020
Spectrum Analyser	Keysight	PXA N9030A	MY55410202	1 year	September 24, 2020
PSU (DC)	Xantrex	XKW60-50	1001425551	—	NCR
USB Power Sensor	Keysight	U2044XA	MY58090002	2 year	April 16, 2020
USB Power Sensor	Keysight	U2044XA	MY58040008	2 year	April 16, 2020
USB Power Sensor	Keysight	U2044XA	MY57510012	2 year	April 15, 2020
USB Power Sensor	Keysight	U2044XA	MY57520003	2 year	April 15, 2020
RF Swtich	Ericsson	RARFSW4X1	1	—	NCR
Switch Driver	Hewlett Packard	11713A	3748A06076	—	NCR
PSU (DC)	Leader	730-3D	9801135	—	NCR
Testing Equipment*	Ericsson	CT11	T01G495060	—	NCR

Note: NCR - no calibration required, VOU - verify on use.

* Testing equipment (CT11) is the test equipment that drives the radios traffic.

Section 8. Testing data

8.1 FCC 27.50(d) and RSS-139, 4.1, RSS-170, 5.3 Maximum output power at RF antenna connector (B66)

8.1.1 Definitions and limits

§ 27.50(d) Operation within the bands: 2110–2155 MHz and 2155–2180 MHz.

(1) The power of each fixed or base station transmitting in the 1995–2000 MHz, 2110–2155 MHz, 2155–2180 MHz or 2180–2200 MHz band and located in any county with population density of 100 or fewer persons per square mile, based upon the most recently available population statistics from the Bureau of the Census, is limited to:

- (i) An equivalent isotropically radiated power (EIRP) of 3280 watts when transmitting with an emission bandwidth of 1 MHz or less;
- (ii) An EIRP of 3280 watts/MHz when transmitting with an emission bandwidth greater than 1 MHz.

(2) The power of each fixed or base station transmitting in the 1995–2000 MHz, the 2110–2155 MHz 2155–2180 MHz band, or 2180–2200 MHz band and situated in any geographic location other than that described in paragraph (d)(1) of this section is limited to:

- (i) An equivalent isotropically radiated power (EIRP) of 1640 watts when transmitting with an emission bandwidth of 1 MHz or less;
- (ii) An EIRP of 1640 watts/MHz when transmitting with an emission bandwidth greater than 1 MHz.

(3) A licensee operating a base or fixed station in the 2110–2155 MHz band utilizing a power greater than 1640 watts EIRP and greater than 1640 watts/MHz EIRP must coordinate such operations in advance with all Government and non-Government satellite entities in the 2025–2110 MHz band. A licensee operating a base or fixed station in the 2110–2180 MHz band utilizing power greater than 1640 watts EIRP and greater than 1640 watts/MHz EIRP must be coordinated in advance with the following licensees authorized to operate within 120 kilometers (75 miles) of the base or fixed station operating in this band: All Broadband Radio Service (BRS) licensees authorized under this part in the 2155–2160 MHz band and all advanced wireless services (AWS) licensees authorized to operate on adjacent frequency blocks in the 2110–2180 MHz band.

(5) Equipment employed must be authorized in accordance with the provisions of §24.51. Power measurements for transmissions by stations authorized under this section may be made either in accordance with a Commission-approved average power technique or in compliance with paragraph (d)(6) of this section. In measuring transmissions in this band using an average power technique, the peak-to-average ratio (PAR) of the transmission may not exceed 13 dB.

(6) Peak transmit power must be measured over any interval of continuous transmission using instrumentation calibrated in terms of an rms-equivalent voltage. The measurement results shall be properly adjusted for any instrument limitations, such as detector response times, limited resolution bandwidth capability when compared to the emission bandwidth, sensitivity, etc., so as to obtain a true peak measurement for the emission in question over the full bandwidth of the channel.

RSS-139, Section 4.1

The transmitter power shall be measured in terms of a root-mean-square (RMS) average value.

RSS-139, Section 6.5

Consult SRSP-513 for e.i.r.p. limits on fixed and base stations operating in the band 2110–2180 MHz.

In addition, the peak to average power ratio (PAPR) of the equipment shall not exceed 13 dB for more than 0.1% of the time, using a signal that corresponds to the highest PAPR during periods of continuous transmission.

RSS-170, Section 5.3.1

Consult SRSP-519 for e.i.r.p. limits on ATC base stations operating in the bands 2000–2020 MHz and 2180–2200 MHz.

SRSP-513, Section 5.1

5.1.1 Fixed and base stations

5.1.1.1 For fixed and base stations operating within the frequency range 2110–2180 MHz with a channel bandwidth equal to or less than 1 MHz, the maximum permissible equivalent isotropically radiated power (e.i.r.p.) is 1640 watts with an antenna height above average terrain (HAAT) up to 300 metres.

5.1.1.2 For fixed and base stations operating within the frequency range 2110–2180 MHz with a channel bandwidth greater than 1 MHz, the maximum permissible e.i.r.p. is 1640 watts/MHz e.i.r.p. (i.e. no more than 1640 watts e.i.r.p. in any 1 MHz band segment) with an antenna height above average terrain (HAAT) up to 300 metres.

5.1.1.3 Fixed and base stations located in geographic areas at a distance greater than 26 km from large or medium population centres, and transmitting within the frequency range 2110–2180 MHz, may increase their e.i.r.p. up to a maximum of 3280 watts/MHz (i.e. no more than 3280 watts e.i.r.p. in any 1 MHz band segment), with an antenna HAAT up to 300 metres.

Within 26 km of any large or medium population centre, fixed and base stations may operate at increased e.i.r.p. if more than 50% of the population within a particular sector's coverage is located outside these large and medium population centres.

Fixed and base stations with increased e.i.r.p. must not be used to provide coverage to large and medium population centres. However, some incidental coverage of these large and medium population centres by stations with increased e.i.r.p. is permitted.

This provision also applies for fixed and base stations with a channel bandwidth equal to or less than 1 MHz (i.e. the e.i.r.p. may be increased up to a maximum of 3280 watts).

5.1.1.4 Fixed and base station antenna heights above average terrain may exceed 300 metres with a reduction in e.i.r.p. The maximum permissible e.i.r.p. for installations with antenna HAAT in excess of 300 metres is given in the following table:

Table 8.1-1: Reduction to Maximum Allowable E.I.R.P. for HAAT > 300 m

HAAT (m)	Maximum EIRP, W/MHz
HAAT ≤ 300	1640 (or 3280 ¹)
300 < HAAT ≤ 500	1070
500 < HAAT ≤ 1000	490
1000 < HAAT ≤ 1500	270
1500 < HAAT ≤ 2000	160

Note: ¹for fixed and base stations with a channel bandwidth equal to or less than 1 MHz

SRSP-519, Section 5.1

The equivalent isotropically radiated power (e.i.r.p.) of base stations shall not exceed 1640 W when transmitting with an emission bandwidth of 1 MHz or less, and 1640 W/MHz when transmitting with an emission bandwidth greater than 1 MHz.

Base stations located outside of large or medium population may increase their e.i.r.p. to a maximum of 3280 W when transmitting with an emission bandwidth of 1 MHz or less, and to 3280 W/MHz when transmitting with an emission bandwidth greater than 1 MHz.

A licensee operating a base station utilizing an e.i.r.p greater than 1640 W/MHz must coordinate in advance with all AWS-4 licensees authorized to operate on adjacent frequency blocks within the same band.

Base station antenna heights above average terrain may exceed 300 m with a corresponding reduction in e.i.r.p. in accordance with Table above

8.1.2 Test summary

Test date	January 20, 2020
Test engineer	Andrey Adelberg

8.1.3 Observations, settings and special notes

Output power was measured with RMS power meter per ANSI C63.26 Paragraph 5.2.4.2 method. PSD was measured using method described in paragraph 5.2.4.4.

Antenna sub-array gain is 14.5 dBi with uncorrelated signals.

Test receiver settings for PSD measurements:

Detector mode	RMS
Resolution bandwidth	1 MHz
Video bandwidth	>RBW
Measurement mode	Power over emission bandwidth
Trace mode	Averaging
Measurement time	Auto

8.1.4 Test data

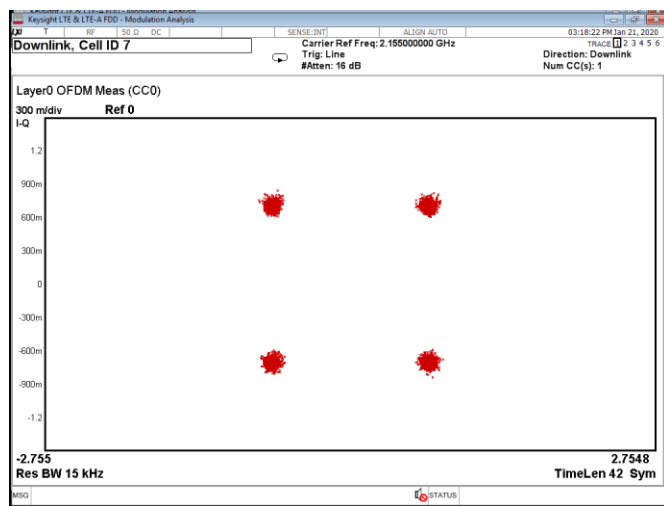

Figure 8.1-1: Modulation characteristics, QPSK

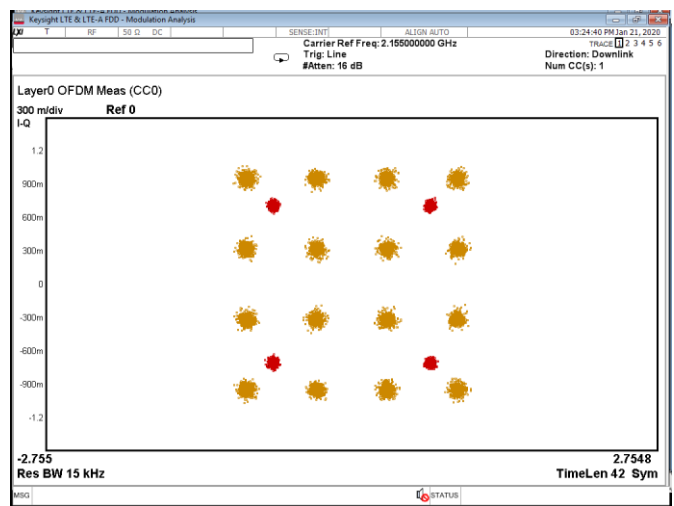

Figure 8.1-2: Modulation characteristics, 16QAM

Section 8
Test name
Specification

Testing data
 FCC 27.50(d) and RSS-139, 4.1, RSS-170, 5.3 Maximum output power at RF antenna connector
 FCC Part 27 and RSS-139 Issue 3, RSS-170 Issue 3

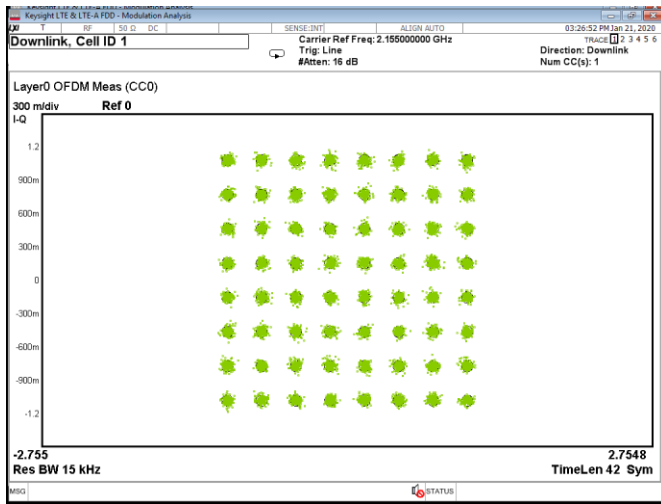

Figure 8.1-3: Modulation characteristics, 64QAM

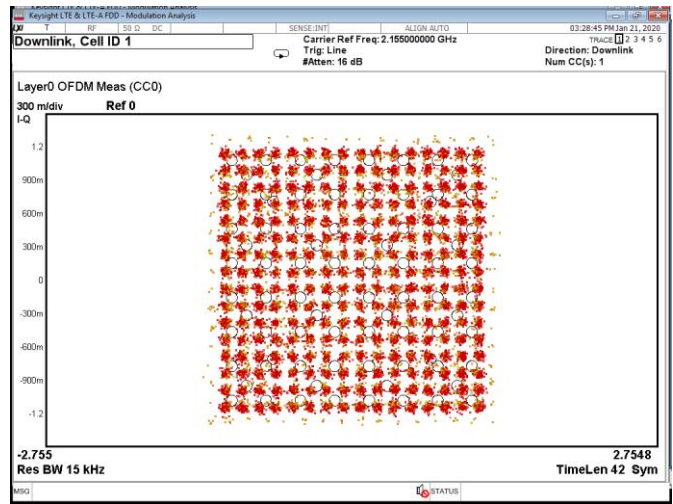

Figure 8.1-4: Modulation characteristics, 256QAM

Table 8.1-2: Output power measurement results

Port	RF output power, dBm	RF output power, W	Dual band combined power, dBm	Dual band combined power, W
000	39.22	8.356	42.63	18.323
010	39.35	8.610	42.77	18.923
020	39.44	8.790	42.73	18.750
030	39.41	8.730	42.83	19.187
031	39.28	8.472	42.66	18.450
021	39.49	8.892	42.84	19.231
011	39.23	8.375	42.62	18.281
001	39.27	8.453	42.67	18.493
070	39.19	8.299	42.64	18.365
060	39.48	8.872	42.83	19.187
050	39.29	8.492	42.67	18.493
040	39.44	8.790	42.84	19.231
041	39.28	8.472	42.71	18.664
051	39.43	8.770	42.77	18.923
061	39.23	8.375	42.70	18.621
071	39.26	8.433	42.68	18.535

Note: The measurement results in the table above were obtained during single band and multi band operation. 10 MHz channel BW (worst case) was used. Frequency of carriers were 2155.0 MHz and 1962.5 MHz for dual band config.

Note: it was determined that the highest level of output power is at antenna port **021**. This port was considered as a representative one and all the rest of the measurements were performed on it.

Table 8.1-3: Output power density measurement results of a single-carrier operation for Port 021

Remarks	Frequency, MHz	RF power density, dBm/MHz	Antenna gain, dBi	EIRP, dBm/MHz	EIRP limit, dBm/MHz	Margin, dB
QPSK, 10 MHz, Low channel	2115.0	29.69	14.50	44.19	62.15	17.96
16QAM, 10 MHz, Low channel	2115.0	30.35	14.50	44.85	62.15	17.30
64QAM, 10 MHz, Low channel	2115.0	29.60	14.50	44.10	62.15	18.05
256QAM, 10 MHz, Low channel	2115.0	29.76	14.50	44.26	62.15	17.89
16QAM, 10 MHz, Mid channel	2155.0	30.72	14.50	45.22	62.15	16.93
16QAM, 10 MHz, High channel	2195.0	29.79	14.50	44.29	62.15	17.86
QPSK, 15 MHz, Low channel	2117.5	28.11	14.50	42.61	62.15	19.54
16QAM, 15 MHz, Low channel	2117.5	28.81	14.50	43.31	62.15	18.84
64QAM, 15 MHz, Low channel	2117.5	28.24	14.50	42.74	62.15	19.41
256QAM, 15 MHz, Low channel	2117.5	27.95	14.50	42.45	62.15	19.70
16QAM, 15 MHz, Mid channel	2155.0	29.53	14.50	44.03	62.15	18.12
16QAM, 15 MHz, High channel	2192.5	28.94	14.50	43.44	62.15	18.71
QPSK, 20 MHz, Low channel	2120.0	27.09	14.50	41.59	62.15	20.56
16QAM, 20 MHz, Low channel	2120.0	27.26	14.50	41.76	62.15	20.39
64QAM, 20 MHz, Low channel	2120.0	27.01	14.50	41.51	62.15	20.64
256QAM, 20 MHz, Low channel	2120.0	27.02	14.50	41.52	62.15	20.63
16QAM, 20 MHz, Mid channel	2155.0	27.71	14.50	42.21	62.15	19.94
16QAM, 20 MHz, High channel	2190.0	27.39	14.50	41.89	62.15	20.26

Linear sum of 8 ports of each polarization was based on the worst-case scenario, then all ports transmit at the maximum found power density of 30.72 dBm/MHz. Maximum PSD sum = $30.72 \text{ dBm/MHz} + 10 \times \text{Log}_{10}(8) = 39.75 \text{ dBm/MHz}$

Table 8.1-4: Total EIRP calculation for a single-carrier operation

Maximum PSD sum, dBm/MHz	Antenna Gain, dBi	Antenna Array Column Gain ¹ , dB	EIRP per polarization ² , dBm/MHz	EIRP per polarization, W/MHz
39.75	14.50	9.00	63.25	2113.489

Notes: ¹ Antenna Array Column Gain = $10 \times \text{Log}_{10}(8)$
²EIRP = PSD Sum + Antenna Gain + Antenna Array Column Gain
Total EIRP calculation for a single Macro Narrow traffic beam: $39.75 + 25 \text{ dBi (directional beam)} = 64.75 \text{ dBm}$ or 2985 W

Table 8.1-5: Output power density measurement results of a two-carrier operation for Port 021

Frequency, MHz	RF power density, dBm/MHz	Antenna gain, dBi	EIRP, dBm/MHz	EIRP limit, dBm/MHz	Margin, dB
2115 + 2125	27.45	14.50	41.95	62.15	20.20
2150 + 2160	27.72	14.50	42.22	62.15	19.93
2185 + 2195	27.22	14.50	41.72	62.15	20.43
2117.5 + 2132.5	26.05	14.50	40.55	62.15	21.60
2147.5 + 2162.5	26.28	14.50	40.78	62.15	21.37
2177.5 + 2192.5	26.17	14.50	40.67	62.15	21.48
2120 + 2140	24.52	14.50	39.02	62.15	23.13
2145 + 2165	24.65	14.50	39.15	62.15	23.00
2170 + 2190	24.66	14.50	39.16	62.15	22.99

Linear sum of 8 ports of each polarization was based on the worst-case scenario, then all ports transmit at the maximum found power density of 27.72 dBm/MHz. Maximum PSD sum = $27.72 \text{ dBm/MHz} + 10 \times \text{Log}_{10}(8) = 36.75 \text{ dBm/MHz}$

Table 8.1-6: Total EIRP calculation for a two-carrier operation

Maximum PSD sum, dBm/MHz	Antenna Gain, dBi	Antenna Array Column Gain ¹ , dB	EIRP per polarization ² , dBm/MHz	EIRP per polarization, W/MHz
36.75	14.50	9.00	60.25	1059.473

Notes: ¹ Antenna Array Column Gain = $10 \times \text{Log}_{10}(8)$; ²EIRP = PSD Sum + Antenna Gain + Antenna Array Column Gain

Table 8.1-7: Output power density measurement results of LTE and IoT operation for Port 021

Remarks	Frequency, MHz	RF power density, dBm/MHz	Antenna gain, dBi	EIRP, dBm/MHz	EIRP limit, dBm/MHz	Margin, dB
10 MHz low channel with 2 × GB IoT	2115.0	29.63	14.50	44.13	62.15	18.02
10 MHz mid channel with 2 × GB IoT	2155.0	30.10	14.50	44.60	62.15	17.55
10 MHz high channel with 2 × GB IoT	2195.0	29.75	14.50	44.25	62.15	17.90
15 MHz low channel with 2 × GB IoT	2117.5	28.10	14.50	42.60	62.15	19.55
15 MHz mid channel with 2 × GB IoT	2155.0	28.56	14.50	43.06	62.15	19.09
15 MHz high channel with 2 × GB IoT	2192.5	28.15	14.50	42.65	62.15	19.50
20 MHz low channel with 2 × GB IoT	2120.0	27.12	14.50	41.62	62.15	20.53
20 MHz mid channel with 2 × GB IoT	2155.0	27.44	14.50	41.94	62.15	20.21
20 MHz high channel with 2 × GB IoT	2190.0	27.42	14.50	41.92	62.15	20.23

Linear sum of 8 ports of each polarization was based on the worst-case scenario, then all ports transmit at the maximum found power density of 30.10 dBm/MHz. Maximum PSD sum = 30.10 dBm/MHz + 10 × Log₁₀(8) = 39.13 dBm/MHz

Table 8.1-8: Total EIRP calculation for LTE + IoT operation

Maximum PSD sum, dBm/MHz	Antenna Gain, dBi	Antenna Array Column Gain ¹ , dB	EIRP per polarization ² , dBm/MHz	EIRP per polarization, W/MHz
39.13	14.50	9.00	62.63	1832.694

Notes: ¹ Antenna Array Column Gain = 10 Log(8)
²EIRP = PSD Sum + Antenna Gain + Antenna Array Column Gain

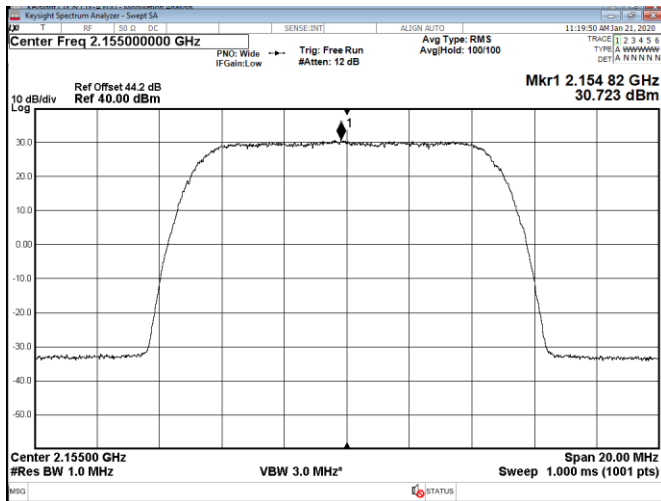

Figure 8.1-5: PSD of 10 MHz channel bandwidth, single carrier operation, sample plot

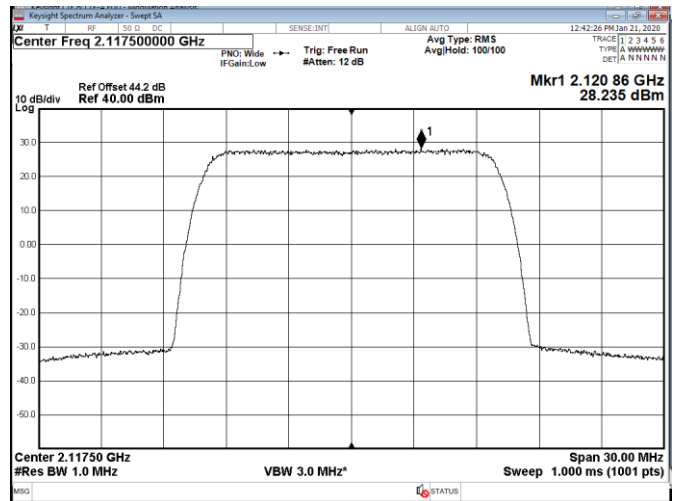

Figure 8.1-6: PSD of 15 MHz channel bandwidth, single carrier operation, sample plot

Section 8
Test name
Specification

Testing data
 FCC 27.50(d) and RSS-139, 4.1, RSS-170, 5.3 Maximum output power at RF antenna connector
 FCC Part 27 and RSS-139 Issue 3, RSS-170 Issue 3

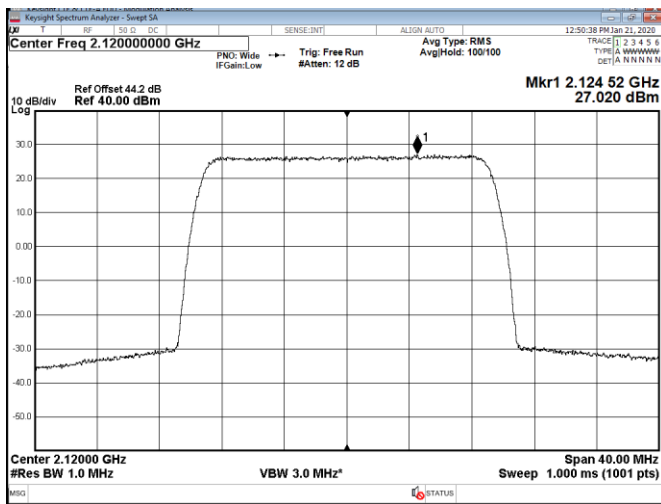

Figure 8.1-7: PSD of 20 MHz channel bandwidth, single carrier operation, sample plot

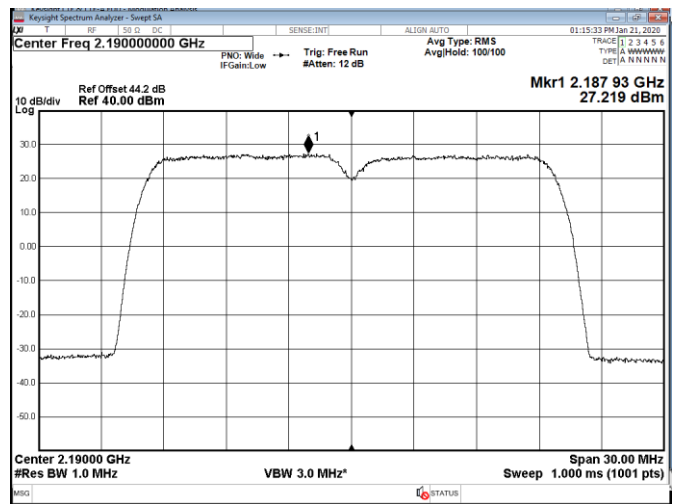

Figure 8.1-8: PSD of 10 MHz channel bandwidth, two-carrier operation, sample plot

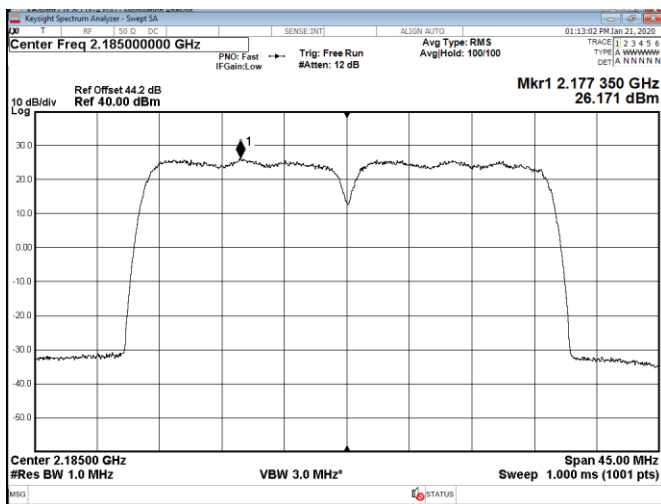

Figure 8.1-9: PSD of 15 MHz channel bandwidth, two-carrier operation, sample plot

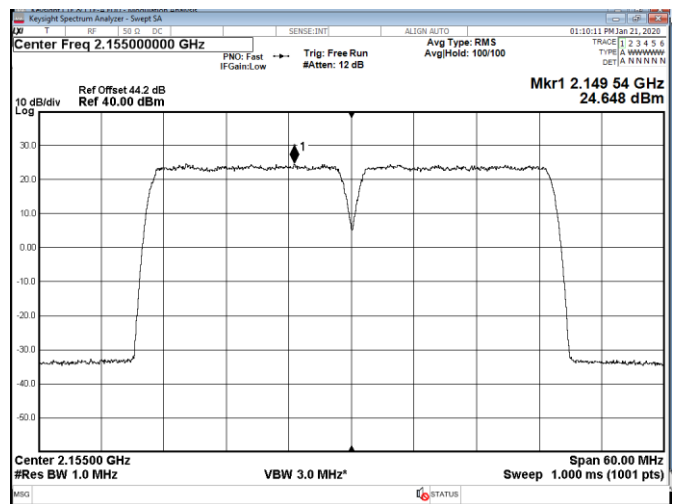

Figure 8.1-10: PSD of 20 MHz channel bandwidth, two-carrier operation, sample plot

Section 8
Test name
Specification

Testing data
 FCC 27.50(d) and RSS-139, 4.1, RSS-170, 5.3 Maximum output power at RF antenna connector
 FCC Part 27 and RSS-139 Issue 3, RSS-170 Issue 3

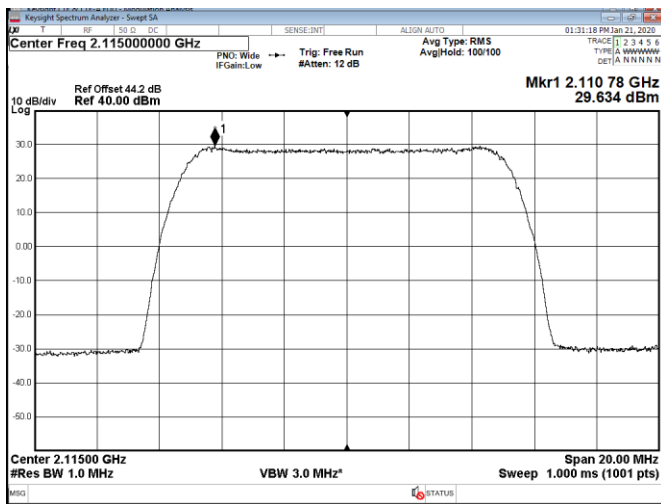

Figure 8.1-11: PSD of 10 MHz channel bandwidth, LTE and IoT operation, sample plot

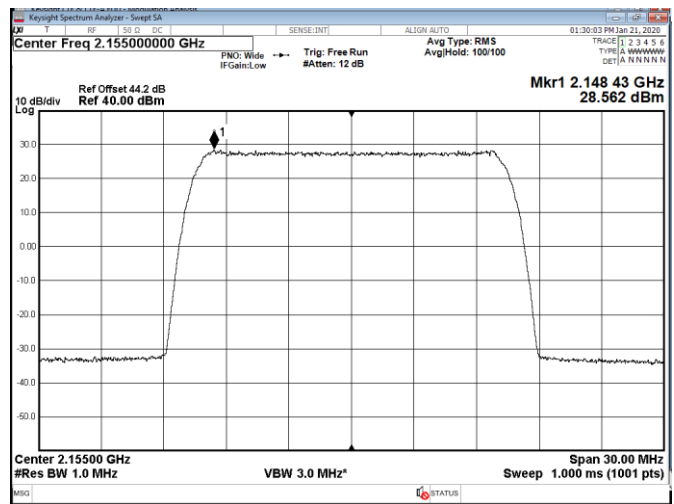

Figure 8.1-12: PSD of 15 MHz channel bandwidth, LTE and IoT operation, sample plot

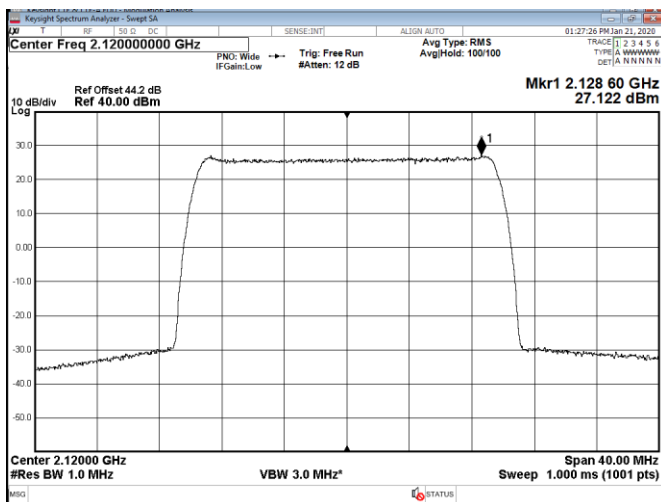

Figure 8.1-13: PSD of 20 MHz channel bandwidth, LTE and IoT operation, sample plot

Table 8.1-9: Complementary Cumulative Distribution Function (CCDF) of the PAPR reduction measurement results for single carrier operation

Remarks	Frequency, MHz	0.1% CCDF, dB	PAPR reduction limit, dB	Margin, dB
QPSK, 10 MHz, Low channel	2115.0	7.37	13.00	5.63
16QAM, 10 MHz, Low channel	2115.0	7.36	13.00	5.64
64QAM, 10 MHz, Low channel	2115.0	7.37	13.00	5.63
256QAM, 10 MHz, Low channel	2115.0	7.38	13.00	5.62
16QAM, 10 MHz, Mid channel	2155.0	7.36	13.00	5.64
16QAM, 10 MHz, High channel	2195.0	7.37	13.00	5.63
QPSK, 15 MHz, Low channel	2117.5	7.39	13.00	5.61
16QAM, 15 MHz, Low channel	2117.5	7.39	13.00	5.61
64QAM, 15 MHz, Low channel	2117.5	7.40	13.00	5.60
256QAM, 15 MHz, Low channel	2117.5	7.40	13.00	5.60
16QAM, 15 MHz, Mid channel	2155.0	7.37	13.00	5.63
16QAM, 15 MHz, High channel	2192.5	7.39	13.00	5.61
QPSK, 20 MHz, Low channel	2120.0	7.41	13.00	5.59
16QAM, 20 MHz, Low channel	2120.0	7.39	13.00	5.61
64QAM, 20 MHz, Low channel	2120.0	7.42	13.00	5.58
256QAM, 20 MHz, Low channel	2120.0	7.41	13.00	5.59
16QAM, 20 MHz, Mid channel	2155.0	7.38	13.00	5.62
16QAM, 20 MHz, High channel	2190.0	7.40	13.00	5.60

Table 8.1-10: Complementary Cumulative Distribution Function (CCDF) of the PAPR reduction measurement results for LTE + IoT operation

Remarks	Frequency, MHz	RF power density, dBm/MHz	Antenna gain, dBi	EIRP, dBm/MHz
10 MHz low channel with 2 x GB IoT	2115.0	7.54	13.00	5.46
10 MHz mid channel with 2 x GB IoT	2155.0	7.55	13.00	5.45
10 MHz high channel with 2 x GB IoT	2195.0	7.54	13.00	5.46
15 MHz low channel with 2 x GB IoT	2117.5	7.50	13.00	5.50
15 MHz mid channel with 2 x GB IoT	2155.0	7.49	13.00	5.51
15 MHz high channel with 2 x GB IoT	2192.5	7.50	13.00	5.50
20 MHz low channel with 2 x GB IoT	2120.0	7.47	13.00	5.53
20 MHz mid channel with 2 x GB IoT	2155.0	7.46	13.00	5.54
20 MHz high channel with 2 x GB IoT	2190.0	7.48	13.00	5.52

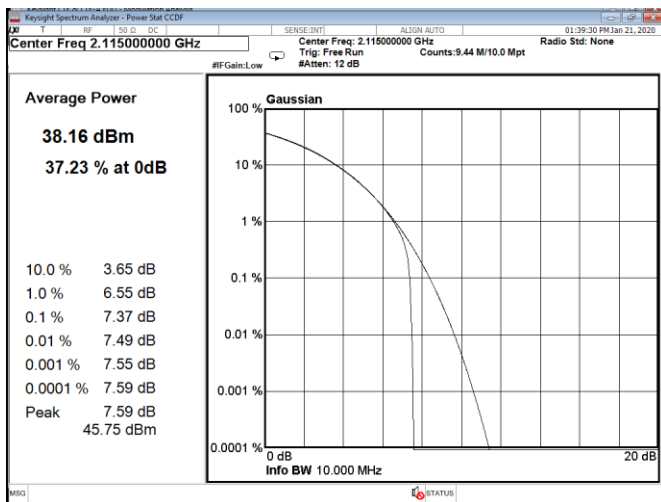

Figure 8.1-14: CCDF sample plot, 10 MHz channel

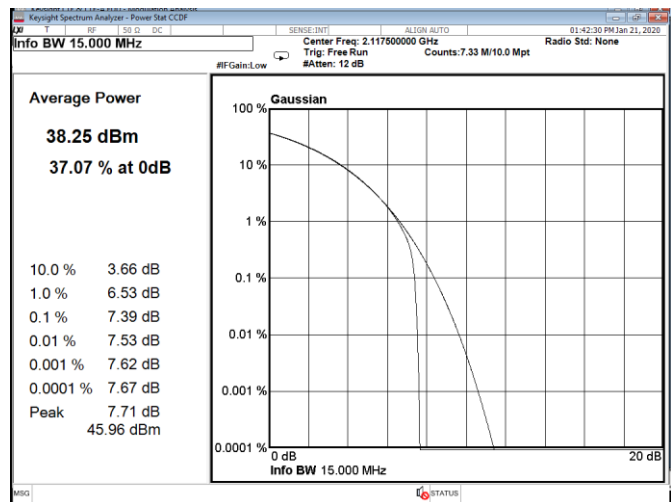

Figure 8.1-15: CCDF sample plot, 15 MHz channel

Section 8
Test name
Specification

Testing data
 FCC 27.50(d) and RSS-139, 4.1, RSS-170, 5.3 Maximum output power at RF antenna connector
 FCC Part 27 and RSS-139 Issue 3, RSS-170 Issue 3

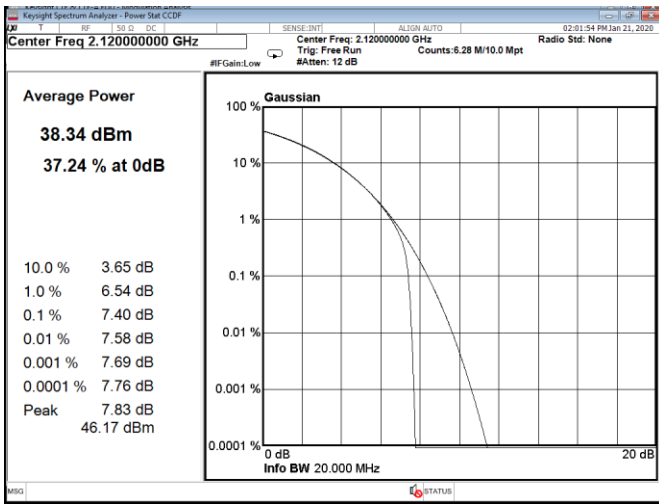

Figure 8.1-16: CCDF sample plot, 20 MHz channel

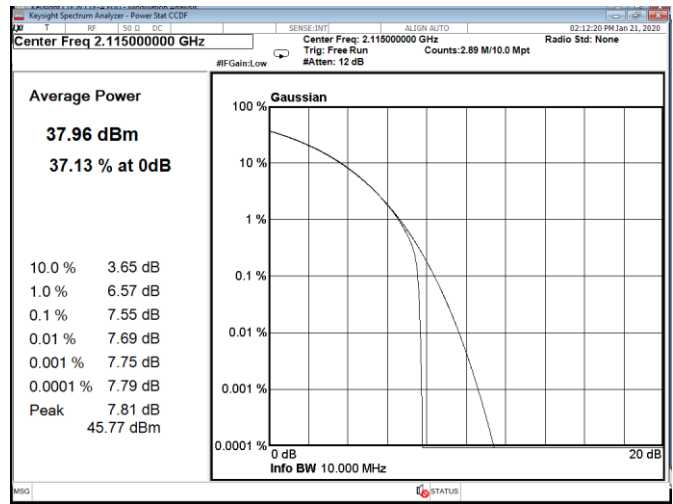

Figure 8.1-17: CCDF sample plot, 10 MHz channel LTE + IoT

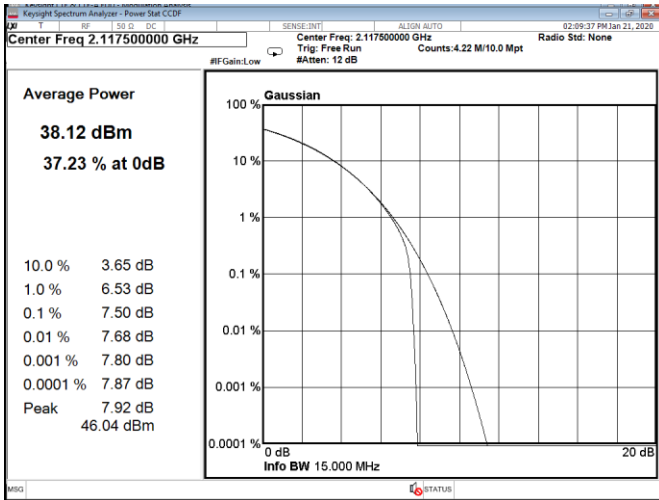

Figure 8.1-18: CCDF sample plot, 15 MHz channel LTE + IoT

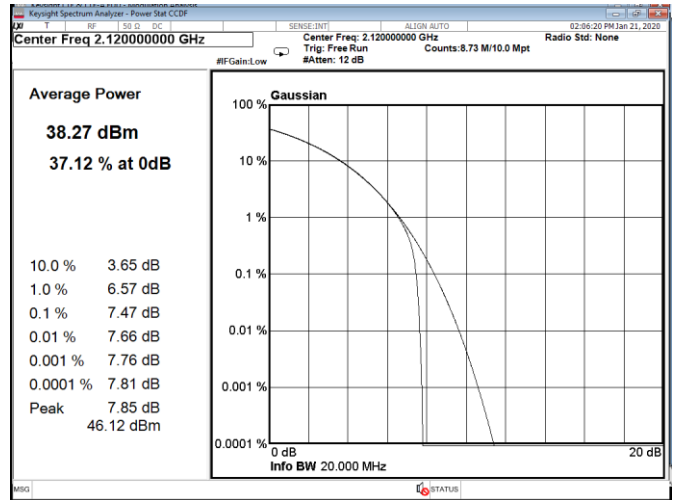

Figure 8.1-19: CCDF sample plot, 20 MHz channel LTE + IoT

8.2 FCC 24.232(a)(2) and RSS-133, 6.4 Transmitter output power (EIRP) and antenna height (B2/25a)

8.2.1 Definitions and limits

§24.232(a)(2)

Base stations with an emission bandwidth greater than 1 MHz are limited to 1640 watts/MHz equivalent isotropically radiated power (EIRP) with an antenna height up to 300 meters HAAT, except as described in paragraph (b) below.

(2) Base station antenna heights may exceed 300 meters HAAT with a corresponding reduction in power; see table below.

(b)(1) Base stations that are located in counties with population densities of 100 persons or fewer per square mile, based upon the most recently available population statistics from the Bureau of the Census, with an emission bandwidth of 1 MHz or less are limited to 3280 watts equivalent isotropically radiated power (EIRP) with an antenna height up to 300 meters HAAT.

(d) Power measurements for transmissions by stations authorized under this section may be made either in accordance with a Commission-approved average power technique or in compliance with paragraph (e) of this section. In both instances, equipment employed must be authorized in accordance with the provisions of §24.51. In measuring transmissions in this band using an average power technique, the peak-to-average ratio (PAR) of the transmission may not exceed 13 dB.

RSS-133, Section 6.4

The equivalent isotropically radiated power (e.i.r.p.) for transmitters shall not exceed the limits given in SRSP-510. In addition, the transmitter's peak-to-average power ratio (PAPR) shall not exceed 13 dB for more than 0.1% of the time using a signal corresponding to the highest PAPR during periods of continuous transmission.

SRSP-510, Section 5.1

5.1.1 Base stations

For base stations with a channel bandwidth greater than 1 MHz, the maximum e.i.r.p. is limited to 3280 watts/MHz e.i.r.p. (i.e., no more than 3280 watts e.i.r.p. in any 1 MHz band segment) with an antenna height above average terrain (HAAT) up to 300 metres. Fixed or base stations operating in urban areas are limited to a maximum allowable e.i.r.p. of 1640 watts/MHz e.i.r.p. Base station antenna heights above average terrain may exceed 300 metres with a corresponding reduction in e.i.r.p. according to the following table.

Table 8.2-1: Reduction to Maximum Allowable E.I.R.P. for HAAT > 300 m

HAAT (m)	Maximum EIRP, W/MHz
HAAT ≤ 300	1640
300 < HAAT ≤ 500	1070
500 < HAAT ≤ 1000	490
1000 < HAAT ≤ 1500	270
1500 < HAAT ≤ 2000	160

8.2.2 Test summary

Test date	January 21, 2020
Test engineer	Andrey Adelberg

8.2.3 Observations, settings and special notes

Output power was measured with RMS power meter per ANSI C63.26 Paragraph 5.2.4.2 method. PSD was measured using method described in paragraph 5.2.4.4.

Antenna sub-array gain is 14.5 dBi with uncorrelated signals.

Test receiver settings for PSD measurements:

Detector mode	RMS
Resolution bandwidth	1 MHz
Video bandwidth	>RBW
Measurement mode	Power over emission bandwidth
Trace mode	Averaging
Measurement time	Auto

8.2.4 Test data

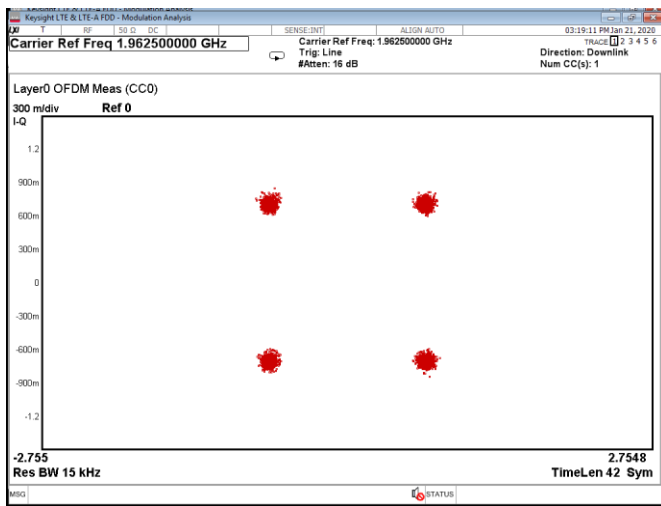

Figure 8.2-1: Modulation characteristics, QPSK

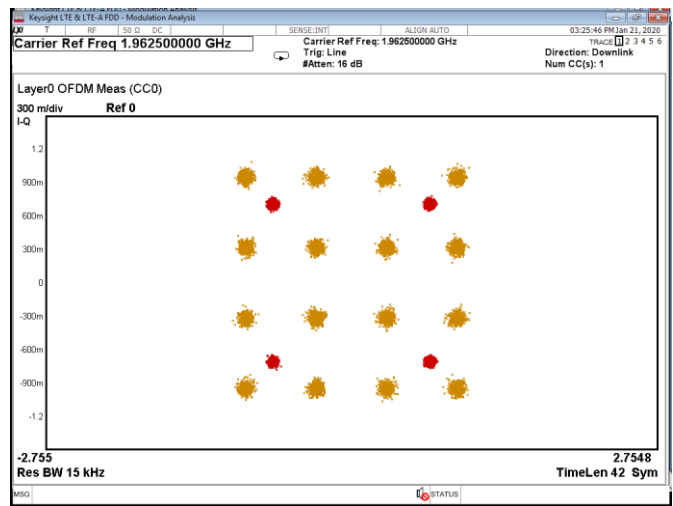
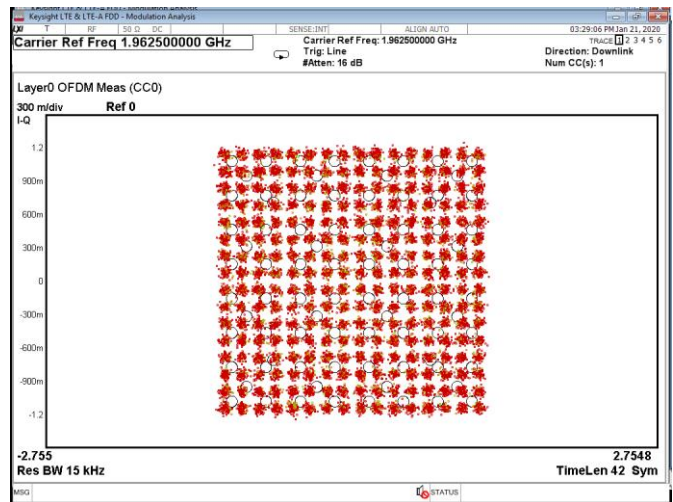
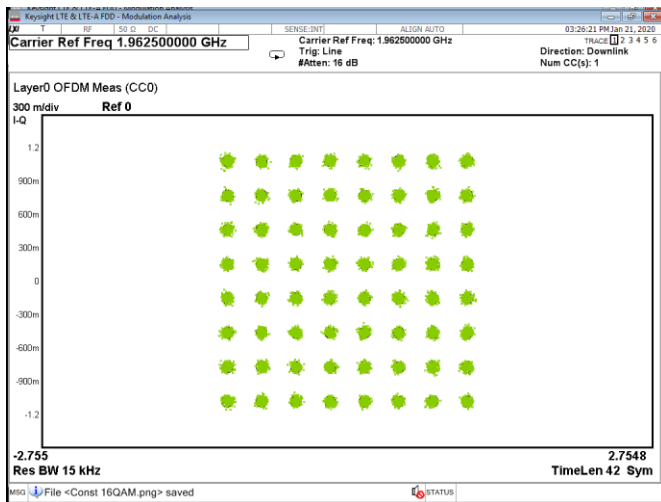

Figure 8.2-2: Modulation characteristics, 16QAM



Section 8
Test name
Specification

Testing data
FCC 24.232(a)(2) and RSS-133, 6.4 Transmitter output power (EIRP) and antenna height
FCC Part 24 and RSS-133 Issue 6



Figure 8.2-3: Modulation characteristics, 64QAM

Figure 8.2-4: Modulation characteristics, 256QAM