



CAICT

No. 23T04Z80631-01



TEST REPORT

No. 23T04Z80631-01

for

Ericsson AB Antenna Integrated Radio Unit

AIR 1672 B48 B77D

FCC ID: TA8AKRD901258

In accordance with FCC CFR 47 Part 27

Issued Date: 2024-01-23

Note:

The test results in this test report relate only to the devices specified in this report. This report shall not be reproduced except in full without the written approval of CTTL.

Test Laboratory:

CTTL-Telecommunication Technology Labs, CAICT

No.52, Huayuan North Road, Haidian District, Beijing, P. R. China 100191.

Tel: +86(0)10-62304633-2512, Fax: +86(0)10-62304633-2504

Email: cttl_terminals@caict.ac.cn, website: www.caict.ac.cn



REPORT HISTORY

Report Number	Revision	Description	Issue Date
23T04Z80631-01	Rev.0	1 st edition	2024-01-09
23T04Z80631-01	Rev.1	Editorial modification	2024-01-23

Note: the latest revision of the test report supersedes all previous version.

CONTENTS

1. TEST LABORATORY	4
1.1. INTRODUCTION & ACCREDITATION.....	4
1.2. TESTING LOCATION	4
1.3. PROJECT DATE	4
1.4. SIGNATURE.....	4
2. CLIENT INFORMATION.....	5
2.1. APPLICANT INFORMATION	5
2.2. MANUFACTURER INFORMATION	5
3. EQUIPMENT UNDER TEST (EUT).....	6
3.1. ABOUT EUT	6
3.2. GENERAL DESCRIPTION	7
3.3. CONFIGURATION DESCRIPTION	7
4. REFERENCE DOCUMENTS	9
4.1. REFERENCE DOCUMENTS FOR TESTING	9
5. TEST SETUP	10
6. LABORATORY ENVIRONMENT	12
7. SUMMARY OF TEST RESULTS	13
8. TEST EQUIPMENT UTILIZED	14
9. MEASUREMENT UNCERTAINTY	14
ANNEX A: MEASUREMENT RESULTS.....	15
A.1 MAXIMUM OUTPUT POWER.....	15
A.2 OCCUPIED BANDWIDTH.....	20
A.3 TRANSMITTER UNWANTED EMISSIONS AT BAND EDGE	34
A.4 TRANSMITTER UNWANTED EMISSIONS - CONDUCTED SPURIOUS EMISSION	45
A.5 RADIATED SPURIOUS EMISSION	55
A.6 FREQUENCY STABILITY	66
ANNEX B: ACCREDITATION CERTIFICATE.....	68

1. Test Laboratory

1.1. Introduction & Accreditation

Telecommunication Technology Labs, CAICT is an ISO/IEC 17025:2017 accredited test laboratory under American Association for Laboratory Accreditation (A2LA) with lab code 7049.01, and is also an FCC accredited test laboratory (CN1349), and ISED accredited test laboratory (CAB identifier:CN0066). The detail accreditation scope can be found on A2LA website.

1.2. Testing Location

Location 1: CTTL (huayuan North Road)

Address: No. 52, Huayuan North Road, Haidian District, Beijing,
P. R. China100191

Location 2: CTTL (BDA)

Address: No.18A, Kangding Street, Beijing Economic-Technology
Development Area, Beijing, P. R. China 100176

1.3. Project date

Testing Start Date: 2023-12-11

Testing End Date: 2023-12-29

1.4. Signature



Dong Yuan

(Prepared this test report)



Zhou Yu

(Reviewed this test report)



Zhao Hui Lin

Deputy Director of the laboratory
(Approved this test report)



2. Client Information

2.1. Applicant Information

Company Name: Ericsson (China) Communications Company Ltd.
Address /Post: Ericsson Tower, No.5 Lize East Street, Chaoyang District, Beijing
100102, P.R.China
Contact: Tingting Wang
Email: tingting.wang@ericsson.com
Telephone: +86 18618510508

2.2. Manufacturer Information

Company Name: Ericsson AB
Address /Post: Isafjordsgatan 10, Kista, SE-164 80 Stockholm
Sweden
Contact: /
Email: /
Telephone: /

3. Equipment Under Test (EUT)

3.1. About EUT

Description	Antenna Integrated Radio Unit
Product Name	AIR 1672 B48 B77D
Product Number	KRD 901 258/1, KRD 901 258/11 (with antenna) KRD 901 258/2, KRD 901 258/21 (CAB unit for test)
FCC ID	TA8AKRD901258
Antenna Gain	19.5dBi
Maximum rated output power	80W
Power source	100-240VAC 50/60Hz
Serial Number	EA8B851960
Hardware Version	R1A
Software Version	UP: CXP2020666/2_R1A127, PIS: CXP2021151/1_R14A92
Frequency range	RX: 3700MHz-3980MHz, TX: 3700MHz-3980MHz
Number of Antenna ports	16
Maximum RF bandwidth (IBW)	280MHz
Maximum Number of supported carriers per port	up to 2 carriers
Supported modulations	QPSK, 16QAM, 64QAM and 256QAM
Supported Channel bandwidth	NR:20/40/60/80/100 MHz
Date of receipt	2023-12-11

3.2. General Description

The Equipment Under Test (EUT) AIR 1672 B48 B77D is an Ericsson Radio Unit working in the wireless communication services 3700-3980MHz band which provides communication connections to 3700-3980MHz network. The AIR 1672 B48 B77D operates from 100-240V AC power source.

The EUT includes 16 TX/RX ports. It can operate in NR mode. It can be configured to transmit in MIMO mode which was used for measurements as the worst configuration. The complete testing was performed with the EUT transmitting at maximum RF power unless otherwise stated. The path loss between the EUT and the spectrum analyzer was measured and recorded for the test band using signal generator and spectrum analyzer. The worst case path loss was entered into the spectrum analyzer as an offset.

A full technical description can be found in the Manufacturer's documentation.

3.3. Configuration Description

The following settings were used to represent all traffic scenarios. The output power was measured on the bottom, middle and top channel of all applicable antenna ports. By measuring the output power of QPSK, 16QAM, 64QAM and 256QAM for NR on one of the antenna ports, it was determined that 256QAM was the worst case modulation scheme and was used for all testing.

Complete testing was carried out on the worst case antenna port which was established as being the highest output power from the applicable measured ports on worst case modulation scheme. This antenna port was Port 5 for NR mode.

The settings below were used for all measurements unless otherwise noted:

NR

Configuration	Carrier	Carrier Bandwidth	Carrier Frequency Configuration (MHz)		
			Bottom	Middle	Top
NR-MIMO-1C	1NR	20MHz	3710.01	3840.00	3969.99
NR-MIMO-1C	1NR	40MHz	3720.00	3840.00	3960.00
NR-MIMO-1C	1NR	60MHz	3730.02	3840.00	3949.98
NR-MIMO-1C	1NR	80MHz	3740.01	3840.00	3939.99
NR-MIMO-1C	1NR	100MHz	3750.00	3840.00	3930.00
NR-MIMO-2C	2NR	20MHz	-	3710.01+3969.99	-
NR-MIMO-2C	2NR	40MHz	-	3720.00+3960.00	-
NR-MIMO-2C	2NR	60MHz	-	3730.02+3949.98	-
NR-MIMO-2C	2NR	80MHz	-	3740.01+3939.99	-
NR-MIMO-2C	2NR	100MHz	-	3750.00+3930.00	-
NR-MIMO-CA	2NR	100MHz	-	3790.02+3890.01	-
NR-MIMO-1C-BE	1NR	20MHz	3710.01	N/A	3969.99
NR-MIMO-1C-BE	1NR	40MHz	3720.00	N/A	3960.00
NR-MIMO-1C-BE	1NR	60MHz	3730.02	N/A	3949.98
NR-MIMO-1C-BE	1NR	80MHz	3740.01	N/A	3939.99
NR-MIMO-1C-BE	1NR	100MHz	3750.00	N/A	3930.00
NR-MIMO-2C-BE	2NR	20MHz	3710.01+3730.02	N/A	3950.01+3969.99
NR-MIMO-2C-BE	2NR	40MHz	3720.00+3760.02	N/A	3920.01+3960.00
NR-MIMO-2C-BE	2NR	60MHz	3730.02+3790.02	N/A	3890.01+3949.98
NR-MIMO-2C-BE	2NR	80MHz	3740.01+3820.02	N/A	3860.01+3939.99
NR-MIMO-2C-BE	2NR	100MHz	3750.00+3849.99	N/A	3830.01+3930.00

N/A – Not Applicable

4. Reference Documents

4.1. Reference Documents for testing

The following documents listed in this section are referred for testing.

Reference	Title	Version
FCC Part 27	MISCELLANEOUS WIRELESS COMMUNICATIONS SERVICES	10-1-22 Edition
FCC Part 2	FREQUENCY ALLOCATIONS AND RADIO TREATY MATTERS; GENERAL RULES AND REGULATIONS	10-1-22 Edition
ANSI 63.26	American National Standard for Compliance Testing of Transmitters Used in Licensed Radio Services	2015
ANSI/TIA-603-E	Land Mobile FM or PM Communications Equipment Measurement and Performance Standards	2016
KDB 971168 D01	MEASUREMENT GUIDANCE FOR CERTIFICATION OF LICENSED DIGITAL TRANSMITTERS	v03r01
KDB 662911 D01	Emissions Testing of Transmitters with Multiple Outputs in the Same Band	v02r01

5. TEST SETUP

Test Setup, Conducted Measurement:

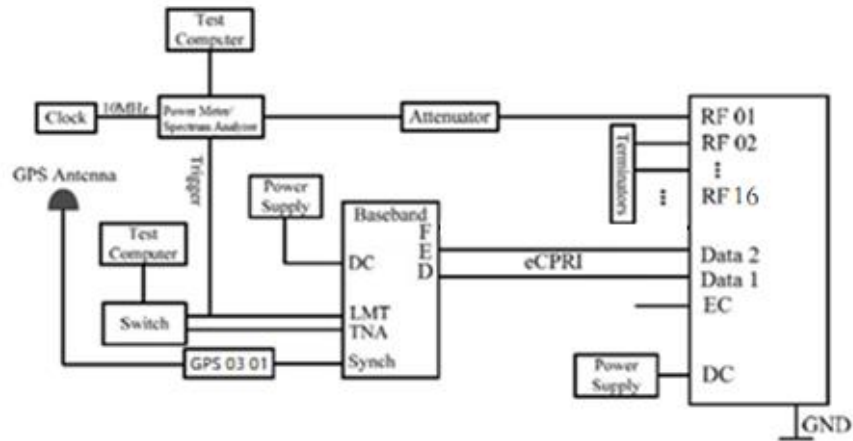

No.	Auxiliary Equipment	Model Type	Version
1	Test Computer	HP EliteBook 8540w	-
2	Baseband	KDU 137 0015/1	R3C
3	Power supply unit	AFV-P-2500B	-
4	Terminator	SHX 6G	-
5	Attenuator	Rosenberger 53AS120-K20	-

Test Setup, Radiated Measurement:

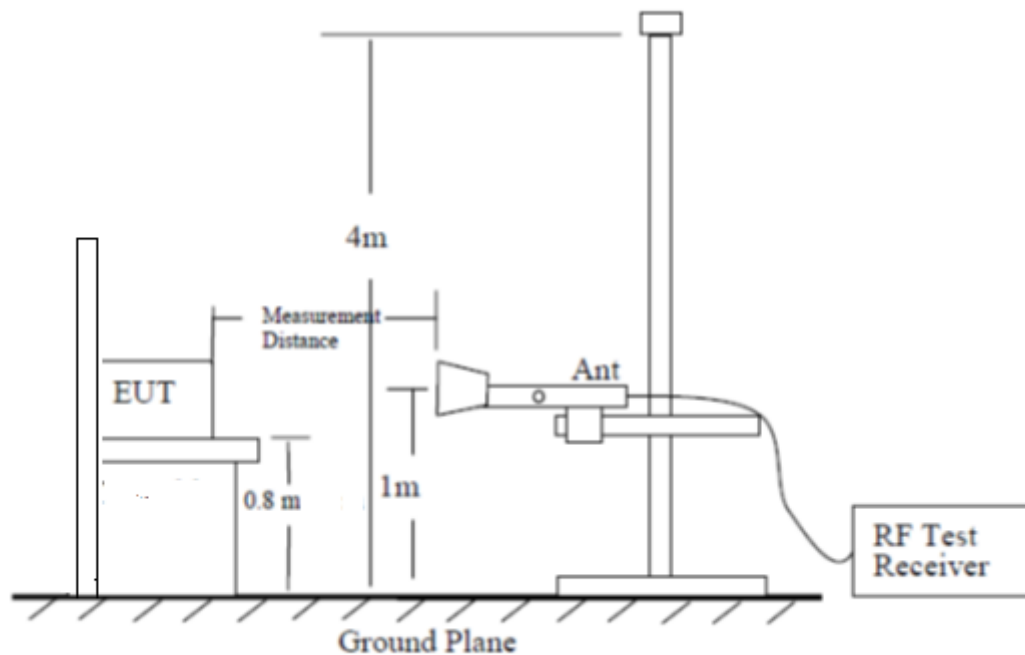

30MHz-1GHz Radiated Measurement setup (Semi-anechoic chamber)

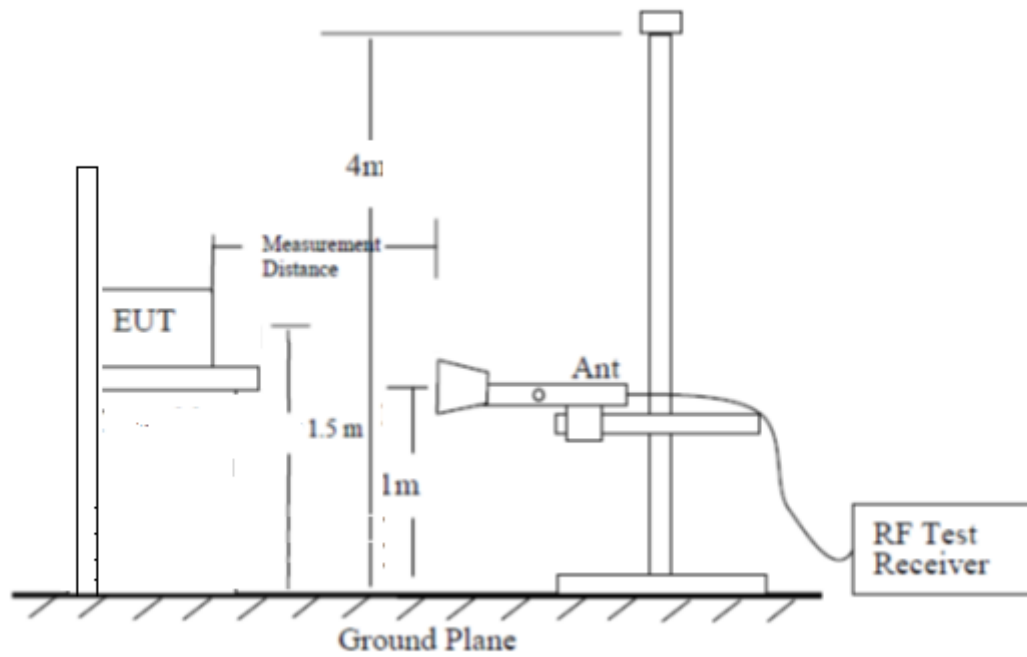

1GHz-40GHz Radiated Measurement setup (Full-anechoic chamber)

6. LABORATORY ENVIRONMENT

Control room / conducted chamber did not exceed following limits along the testing:

Temperature	Min. = 15 °C, Max. = 35 °C
Relative humidity	Min. =20 %, Max. = 80 %
Shielding effectiveness	> 110 dB
Electrical insulation	>2 MΩ
Ground system resistance	< 0.5 Ω

Semi-anechoic chamber(10 meters×6.7 meters×6.15 meters) did not exceed following limits along the testing:

Temperature	Min. = 15 °C, Max. = 30 °C
Relative humidity	Min. = 35 %, Max. = 60 %
Shielding effectiveness	> 100 dB
Electrical insulation	>2 MΩ
Ground system resistance	< 0.5 Ω
Normalised site attenuation (NSA)	<±3.5 dB, 3 m distance
Site voltage standing-wave ratio (S_{VSWR})	Between 0 and 6 dB, from 1GHz to 18GHz
Uniformity of field strength	Between 0 and 6 dB, from 80 to 3000 MHz

7. SUMMARY OF TEST RESULTS

Items	Test Name	Clause in FCC rules	Verdict
1	Maximum Output Power	27.50(j), 2.1046	Pass
2	Occupied Bandwidth	27.53(m), 2.1049	Pass
3	Transmitter unwanted emissions at Band Edge	27.53(l), 2.1051	Pass
4	Transmitter unwanted emissions - Conducted Spurious Emission	27.53(l), 2.1051	Pass
5	Radiated Spurious Emission	27.53(l), 2.1053	Pass
6	Frequency Stability	27.54, 2.1055	Pass

8. Test Equipment Utilized

Description	TYPE	series number	MANUFACTURE	CAL DUE DATE	CALIBRATION INTERVAL
Power Supply	AFV-P-2500B	F118060012	Preen	2024-04-29	13 months
20dB Attenuator	53AS120-K20	74842	Rosenberger	-	-
Spectrum Analyzer	N9030	MY57142378	Keysight	2024-04-01	13 months
Climate Chamber	GPS-4	0010-003512	Espec	2024-04-21	13 months
Test Receiver	ESU26	100376	R&S	2024-05-30	12 months
Test Receiver	ESW44	103015	R&S	2024-02-11	12 months
Antenna	VULB 9163	01177	SCHWARZBECK	2024-09-03	12 months
Antenna	3117	00119024	ETS	2024-07-13	12 months
Antenna	LB-180400-25-C-KF	J211060826	A-INFO	2024-05-11	12 months

9. MEASUREMENT UNCERTAINTY

For a 95% confidence level, the measurement uncertainties for defined systems are:

Test Discipline	Measurement Uncertainty
Conducted Maximum Peak Output Power	0.5dB
Occupied Bandwidth	1.1Hz
Conducted Unwanted Emissions	2.3dB
Frequency Stability	$<\pm 1 \times 10^{-7}$
Radiated Unwanted Emissions	<1GHz 5.88dB, k=2 >1GHz 4.72dB, k=2

Measurement uncertainty is not taken into account when stating conformity with a specified requirement.

ANNEX A: MEASUREMENT RESULTS

A.1 Maximum Output Power

A.1.1 Reference

FCC CFR 47 Part 2, Clause 2.1046

FCC CFR 47 Part 27, Clause 27.50(j)

A.1.2 Method of Measurements

During the process of testing, the EUT was configured to transmit on maximum power and proper modulation. The transmitter power shall be measured in terms of a root-mean-square (RMS) average value. In case of the EUT was configured to MIMO mode, since the EUT transmits on all antennas simultaneously in the same frequency range, using the Measure-and-Sum approach, the output power at all antennas were tested, and the total output power were then summed mathematically in linear power units according to FCC KDB 662911 D01.

A peak to average ratio measurement is performed at the conducted ports of the EUT for single carrier for single RAT mode. The spectrum analyzers Complementary Cumulative Distribution Function (CCDF) was used and 0.1% probability value recorded.

A.1.3 Limit

EIRP: Non-Rural ≤ 1640 W/MHz, Rural ≤ 3280 W/MHz

Peak to Average Ratio: ≤ 13 dB

A.1.4 Measurement result

Configuration NR-MIMO-1C 40.0MHz

Maximum Output Power 36.99dBm per port for NR Channel Bandwidth 40MHz

Port	Modulation/ Carrier Bandwidth (MHz)	Output Power								
		Channel position B			Channel position M			Channel position T		
		POWER (dBm)	POWER (dBm/MHz)	PAR (dB)	POWER (dBm)	POWER (dBm/MHz)	PAR (dB)	POWER (dBm)	POWER (dBm/MHz)	PAR (dB)
0	256QAM/40.0	36.44	25.29	7.45	36.32	24.52	7.46	36.24	24.35	7.58
1	256QAM/40.0	36.53	25.55	7.49	36.32	24.66	7.51	36.35	24.37	7.62
2	256QAM/40.0	36.39	24.51	7.47	36.29	24.28	7.47	36.26	24.19	7.58
3	256QAM/40.0	36.37	24.41	7.50	36.30	24.30	7.57	36.27	24.25	7.67
4	256QAM/40.0	36.23	24.22	7.54	36.21	24.31	7.56	36.13	24.16	7.62
5	256QAM/40.0	36.66	25.69	7.48	36.56	24.75	7.48	36.45	24.53	7.62
6	256QAM/40.0	36.28	24.21	7.53	36.32	24.15	7.54	36.31	24.19	7.69
7	256QAM/40.0	36.29	24.23	7.58	36.35	24.25	7.59	36.29	24.15	7.65
8	256QAM/40.0	36.25	24.62	7.57	36.32	24.41	7.56	36.24	24.26	7.65
9	256QAM/40.0	36.29	24.19	7.51	36.16	24.11	7.61	36.32	24.12	7.69
10	256QAM/40.0	36.41	25.47	7.46	36.44	24.67	7.47	36.26	24.39	7.57
11	256QAM/40.0	36.24	24.22	7.56	36.23	24.13	7.56	36.30	24.16	7.66
12	256QAM/40.0	36.26	25.09	7.57	36.25	24.28	7.58	36.28	24.27	7.69
13	256QAM/40.0	36.21	24.14	7.50	36.23	24.19	7.49	36.29	24.15	7.61
14	256QAM/40.0	36.42	25.59	7.50	36.46	24.53	7.50	36.25	24.49	7.62
15	256QAM/40.0	36.21	24.12	7.47	36.29	24.17	7.47	36.23	24.16	7.61
Total Power 0-15		48.39	36.80	-	48.36	36.40	-	48.32	36.30	-
Total Power 0-15+19.5dBi		67.89	56.30	-	67.86	55.90	-	67.82	55.80	-

Configuration NR-MIMO-1C 20.0MHz

Maximum Output Power 33.98dBm per port for NR Channel Bandwidth 20MHz

Port	Modulation/ Carrier Bandwidth (MHz)	Output Power								
		Channel position B			Channel position M			Channel position T		
		POWER (dBm)	POWER (dBm/MHz)	PAR (dB)	POWER (dBm)	POWER (dBm/MHz)	PAR (dB)	POWER (dBm)	POWER (dBm/MHz)	PAR (dB)
5	256QAM/20.0	33.89	25.39	8.02	33.94	24.70	8.00	33.87	24.42	8.05
Calculated Total Power+19.5dBi		65.44	56.94	-	65.49	56.25	-	65.42	55.97	-

Configuration NR-MIMO-1C 60.0MHz, 80.0MHz, 100.0MHz

Maximum Output Power 36.99dBm per port for NR Channel Bandwidth 60MHz, 80MHz and 100MHz

Port	Modulation/ Carrier Bandwidth (MHz)	Output Power								
		Channel position B			Channel position M			Channel position T		
		POWER (dBm)	POWER (dBm/MHz)	PAR (dB)	POWER (dBm)	POWER (dBm/MHz)	PAR (dB)	POWER (dBm)	POWER (dBm/MHz)	PAR (dB)
5	256QAM/60.0	36.68	23.19	7.52	36.52	23.29	7.51	36.37	22.52	7.63
Calculated Total Power+19.5dBi		68.23	54.74	-	68.07	54.84	-	67.92	54.07	-
5	256QAM/80.0	36.83	22.03	7.45	36.57	22.31	7.44	36.31	21.47	7.65
Calculated Total Power+19.5dBi		68.38	53.58	-	68.12	53.86	-	67.86	53.02	-
5	256QAM/100.0	36.67	20.92	7.49	36.47	20.88	7.48	36.22	20.69	7.70
Calculated Total Power+19.5dBi		68.22	52.47	-	68.02	52.43	-	67.77	52.24	-

Configuration NR-MIMO-1C 40.0M

Maximum Output Power 36.99dBm per port for NR Channel Bandwidth 40MHz

Port	Modulation/ Carrier Bandwidth (MHz)	Output Power								
		Channel position B			Channel position M			Channel position T		
		POWER (dBm)	POWER (dBm/MHz)	PAR (db)	POWER (dBm)	POWER (dBm/MHz)	PAR (db)	POWER (dBm)	POWER (dBm/MHz)	PAR (db)
5	QPSK/40.0	36.36	24.59	7.49	36.36	24.32	7.49	36.26	24.27	7.57
Calculated Total Power+19.5dBi		67.91	56.14	-	67.91	55.87	-	67.81	55.82	-
5	16QAM/40.0	36.39	25.41	7.49	36.30	24.64	7.50	36.22	24.49	7.55
Calculated Total Power+19.5dBi		67.94	56.96	-	67.85	56.19	-	67.77	56.04	-
5	64QAM/40.0	36.53	24.62	7.50	36.45	24.36	7.49	36.31	24.33	7.62
Calculated Total Power+19.5dBi		68.08	56.17	-	68.00	55.91	-	67.86	55.88	-
5	256QAM/40.0	36.66	25.69	7.48	36.56	24.75	7.48	36.45	24.53	7.62
Calculated Total Power+19.5dBi		68.21	57.24	-	68.11	56.30	-	68.00	56.08	-

Configuration NR-MIMO-2C 20.0MHz, 40MHz, 60MHz, 80MHz, 100MHz

Maximum Output Power 36.99dBm per port for NR 2C 20MHz, 40MHz, 60MHz,80MHz and 100MHz

Port	Modulation/ Carrier Bandwidth (MHz)	Output Power		
		Channel position M		
		POWER (dBm)	POWER (dBm/MHz)	PAR (db)
5	256QAM/20.0x2	36.35	25.30	-
Calculated Total Power+19.5dBi		67.90	56.85	-
5	256QAM/40.0x2	36.47	21.89	-
Calculated Total Power+19.5dBi		68.02	53.44	-
5	256QAM/60.0x2	36.45	20.45	-
Calculated Total Power+19.5dBi		68.00	52.00	-
5	256QAM/80.0x2	36.63	19.06	-
Calculated Total Power+19.5dBi		68.18	50.61	-
5	256QAM/100.0x2	36.57	17.97	-
Calculated Total Power+19.5dBi		68.12	49.52	-

Port 5, 256QAM NR 40.0M Channel position M, Output Power

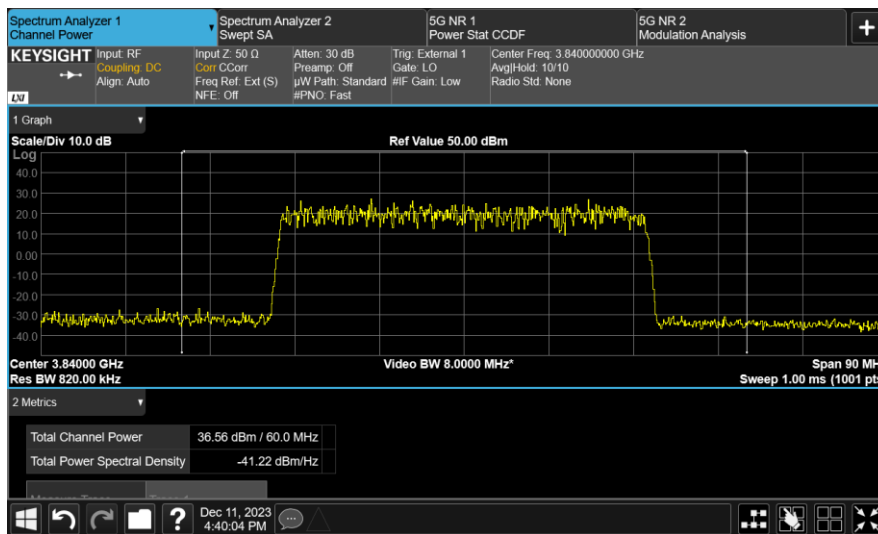

Port 5, 256QAM NR 40.0M Channel position M, PSD

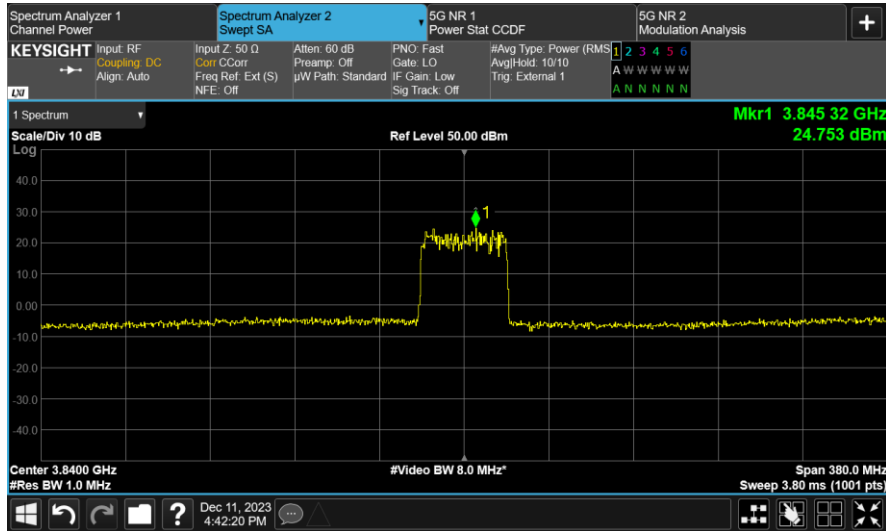

Port 5, 256QAM NR 40.0M Channel position M, PAPR

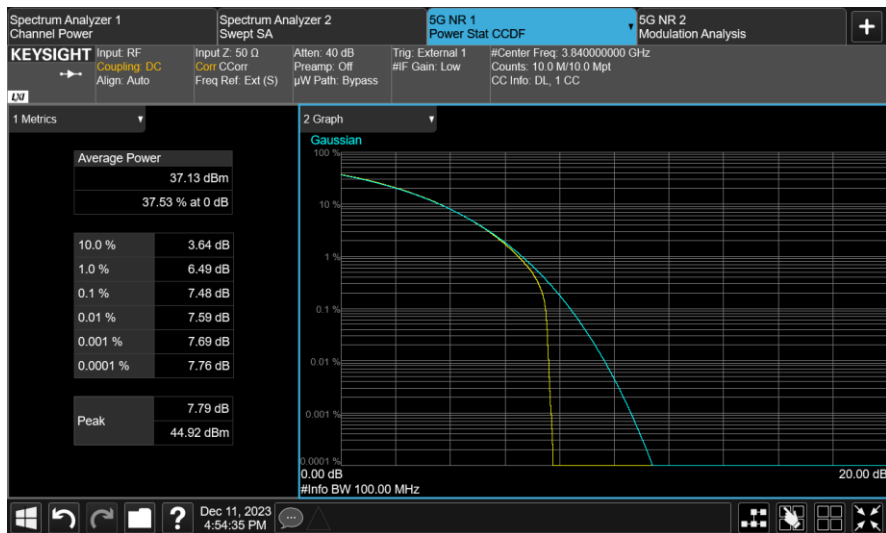

A.2 Occupied Bandwidth

A.2.1 Reference

FCC CFR 47 Part 2, Clause 2.1049

FCC CFR 47 Part 27, Clause 27.53 (m)

A.2.2 Method of Measurements

The EUT was set to transmit at maximum power. Using the Occupied Bandwidth measurement function in the spectrum analyzer, the occupied bandwidth was measured in accordance with ANSI 63.26.

- a) The spectrum analyzer center frequency is set to the nominal EUT channel center frequency. The frequency span for the spectrum analyzer shall be set wide enough to capture all modulation products including the emission skirts (i.e., two to five times the OBW).
- b) The nominal IF filter bandwidth (3 dB RBW) shall be in the range of 1 to 5 % of the anticipated OBW, and the VBW shall be at least 3 times the RBW.
- c) Set the reference level of the instrument as required to keep the signal from exceeding the maximum input mixer level for linear operation. In general, the peak of the spectral envelope must be at least $10\log(\text{OBW} / \text{RBW})$ below the reference level.
- d) Use the 99% power bandwidth function of the spectrum analyzer and report the measured bandwidth.

A.2.3 Measurement result

Configuration NR-MIMO-1C

-26dBc Occupied Bandwidth

Antenna	Modulation / Bandwidth	Occupied Bandwidth (MHz)		
		Channel Position B	Channel Position M	Channel Position T
5	256QAM/ 20.0 MHz	19.06	19.06	19.06
5	256QAM/ 40.0 MHz	39.25	39.28	39.25
5	256QAM/ 60.0 MHz	60.20	60.19	60.16
5	256QAM/ 80.0 MHz	80.78	80.78	80.77
5	256QAM/ 100.0 MHz	101.50	101.50	101.50

Antenna	Channel Position	Bandwidth	Occupied Bandwidth (MHz)		
			QPSK	16QAM	64QAM
5	M	20.0 MHz	19.17	19.01	19.00
5	M	40.0 MHz	39.63	39.41	39.63
5	M	60.0 MHz	60.18	60.47	60.09
5	M	80.0 MHz	81.17	80.91	80.97
5	M	100.0 MHz	101.50	101.60	101.40

99% Occupied Bandwidth

Antenna	Modulation / Bandwidth	Occupied Bandwidth (MHz)		
		Channel Position B	Channel Position M	Channel Position T
5	256QAM/ 20.0 MHz	18.20	18.20	18.18
5	256QAM/ 40.0 MHz	37.90	37.90	37.89
5	256QAM/ 60.0 MHz	57.93	57.72	57.86
5	256QAM/ 80.0 MHz	77.69	77.66	77.52
5	256QAM/ 100.0 MHz	97.45	97.45	97.26

Antenna	Channel Position	Bandwidth	Occupied Bandwidth (MHz)		
			QPSK	16QAM	64QAM
5	M	20.0 MHz	18.21	18.19	18.28
5	M	40.0 MHz	37.94	37.98	37.77
5	M	60.0 MHz	57.60	57.42	57.70
5	M	80.0 MHz	77.56	77.65	77.31
5	M	100.0 MHz	97.41	97.39	97.32

Port 5, 256QAM NR 20.0M Channel position B

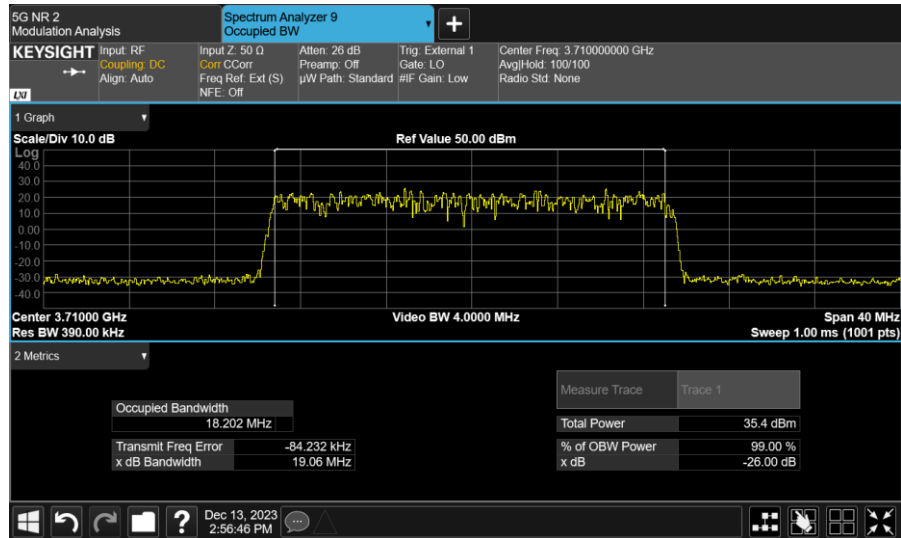

Port 5, 256QAM 20.0M Channel position M

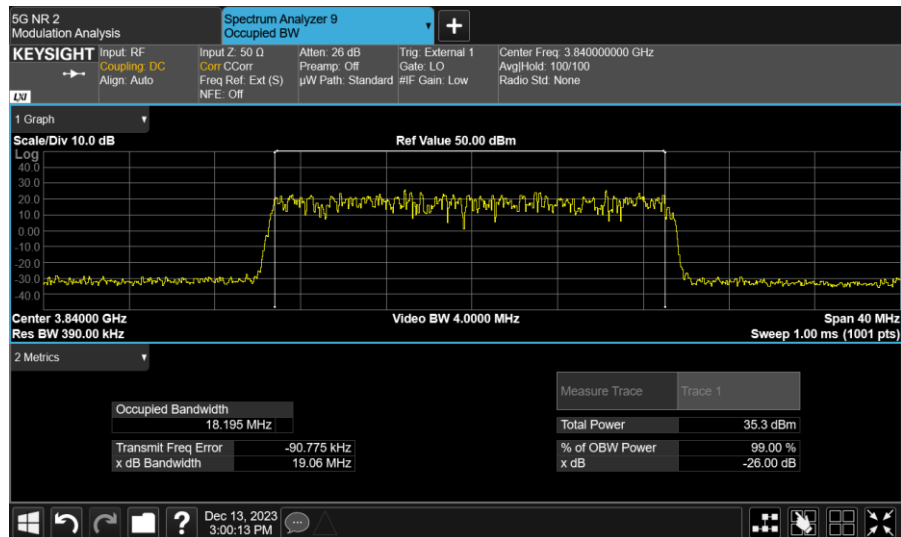

Port 5, 256QAM 20.0M Channel position T



Port 5, 256QAM 40.0M Channel position B

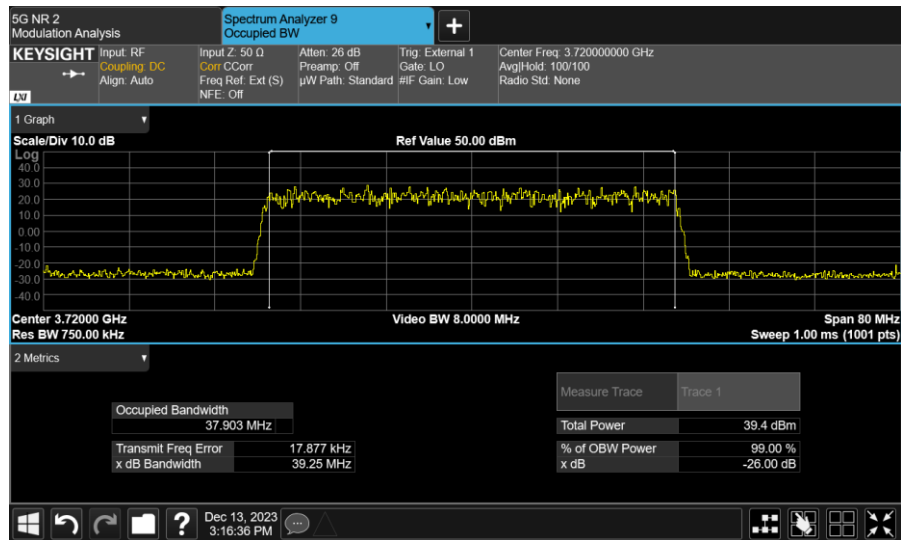

Port 5, 256QAM 40.0M Channel position M

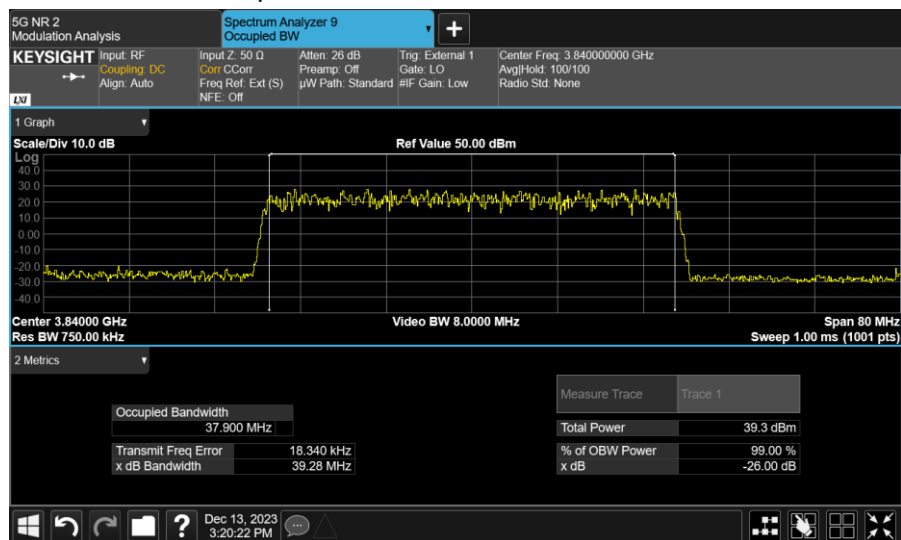

Port 5, 256QAM 40.0M Channel position T

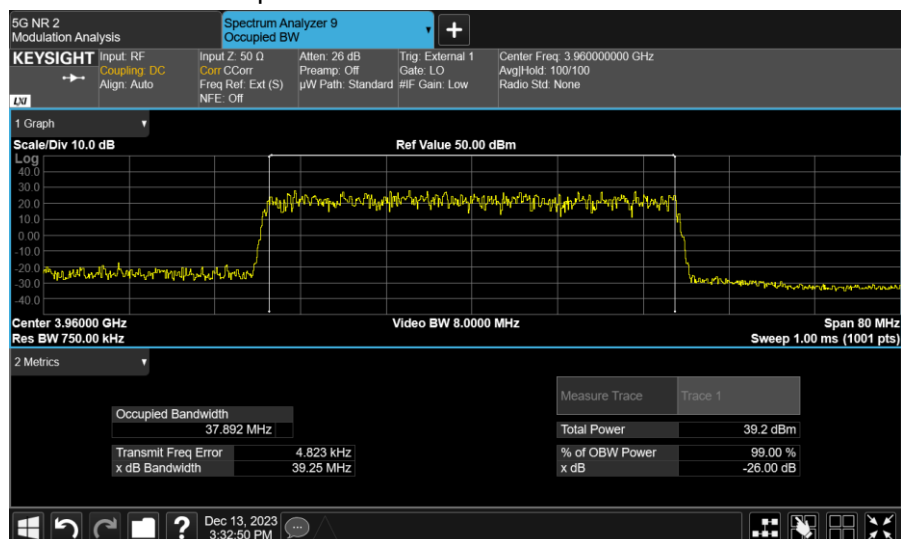

Port 5, 256QAM 60.0M Channel position B

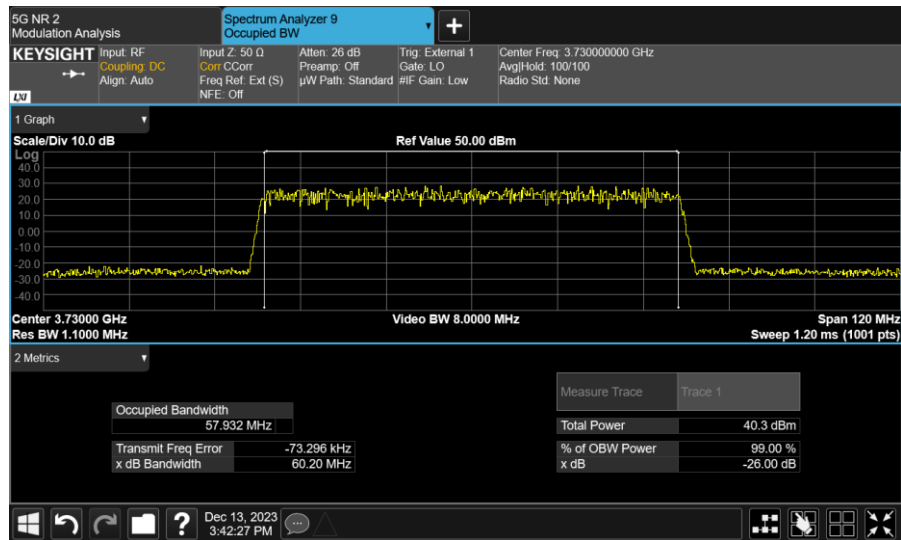

Port 5, 256QAM 60.0M Channel position M

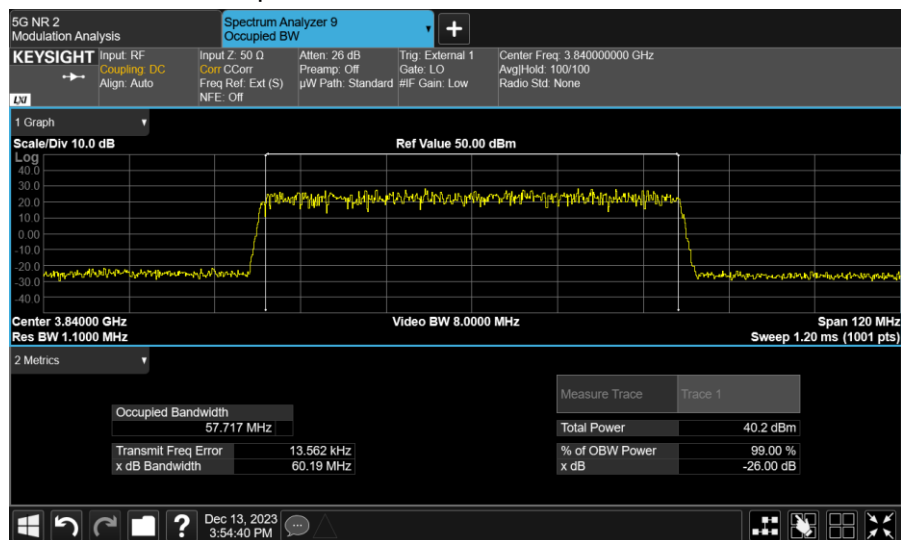

Port 5, 256QAM 60.0M Channel position T

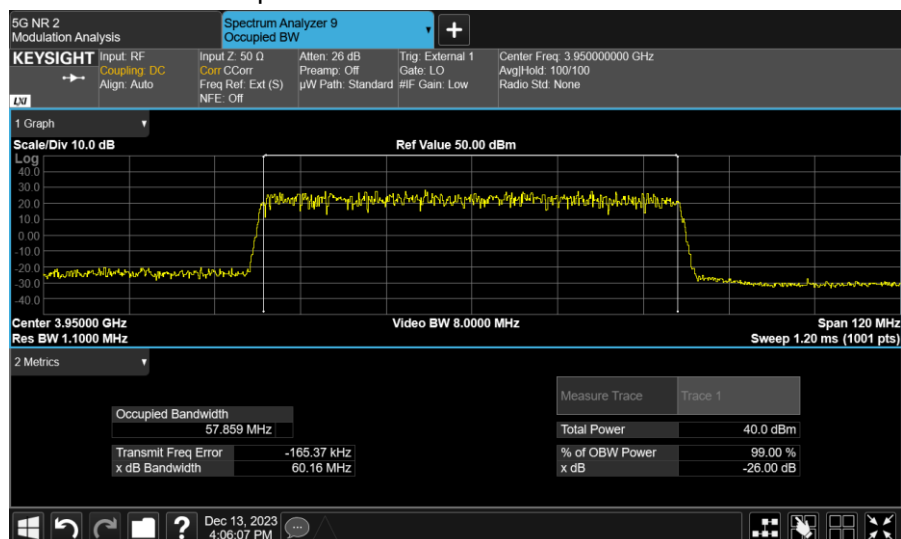

Port 5, 256QAM 80.0M Channel position B

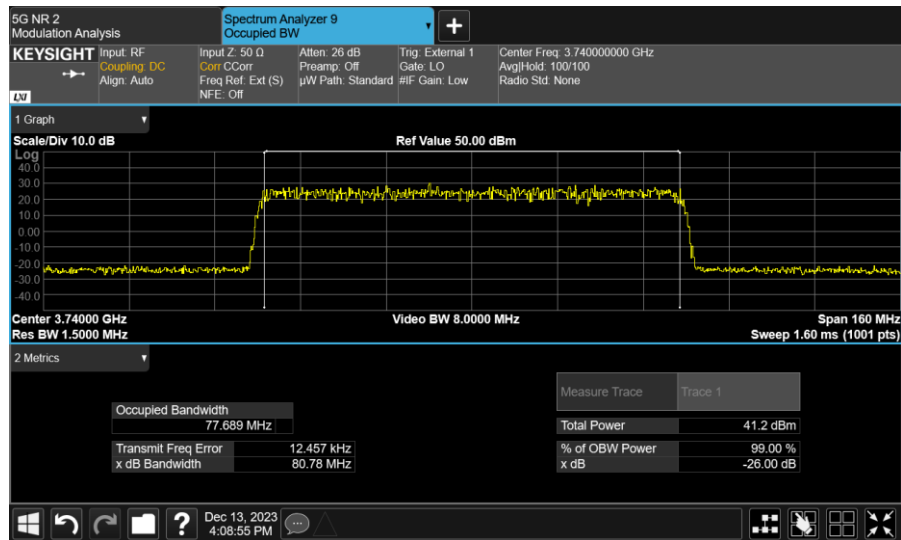

Port 5, 256QAM 80.0M Channel position M

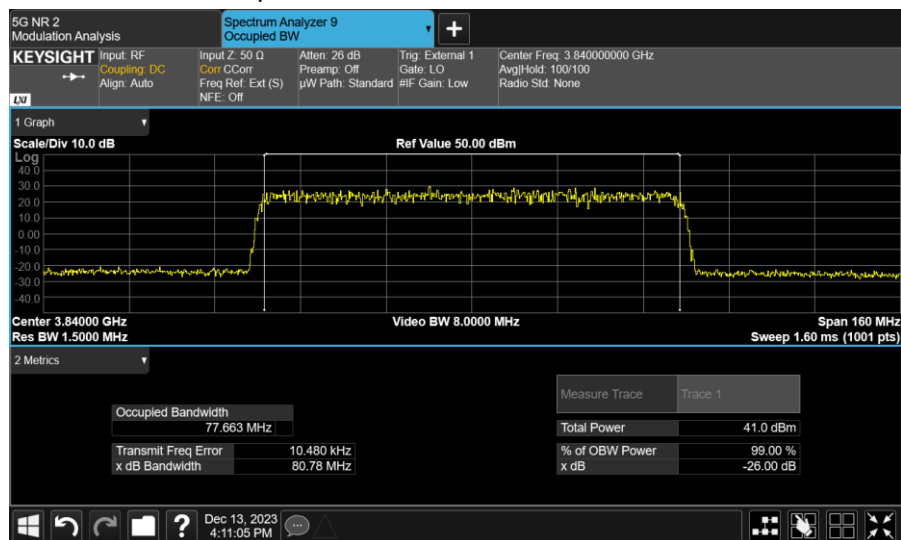

Port 5, 256QAM 80.0M Channel position T

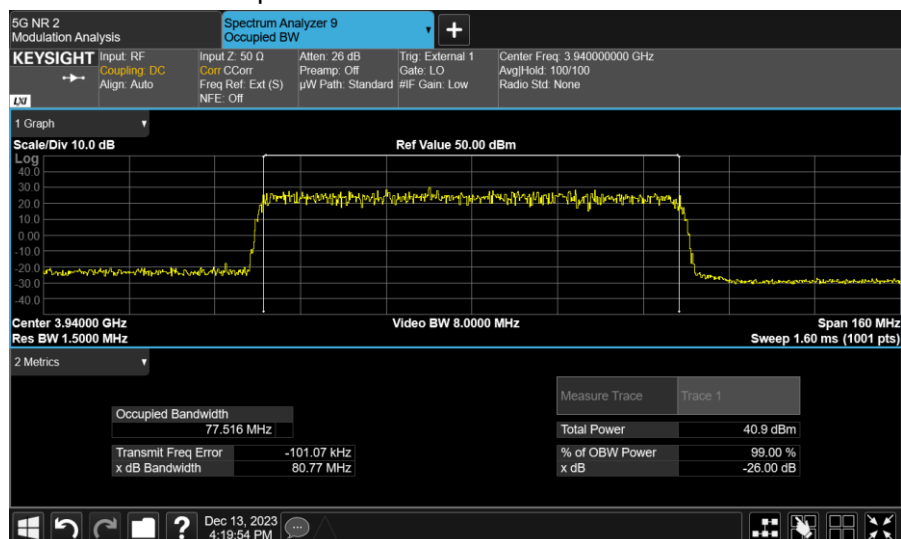

Port 5, 256QAM 100.0M Channel position B

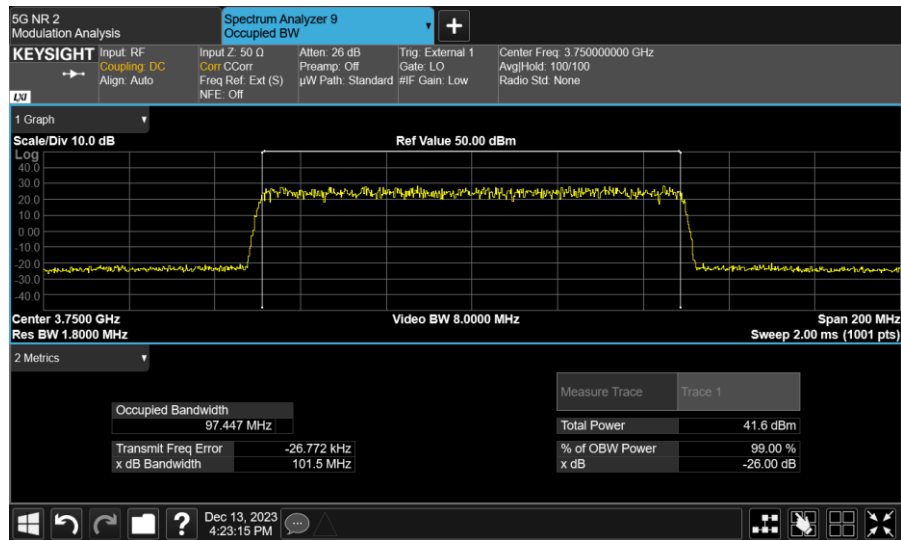

Port 5, 256QAM 100.0M Channel position M

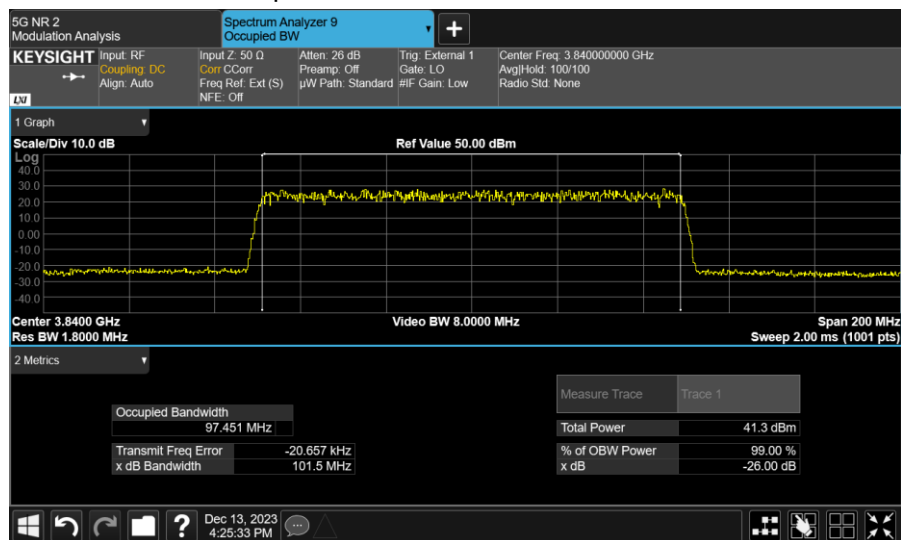

Port 5, 256QAM 100.0M Channel position T

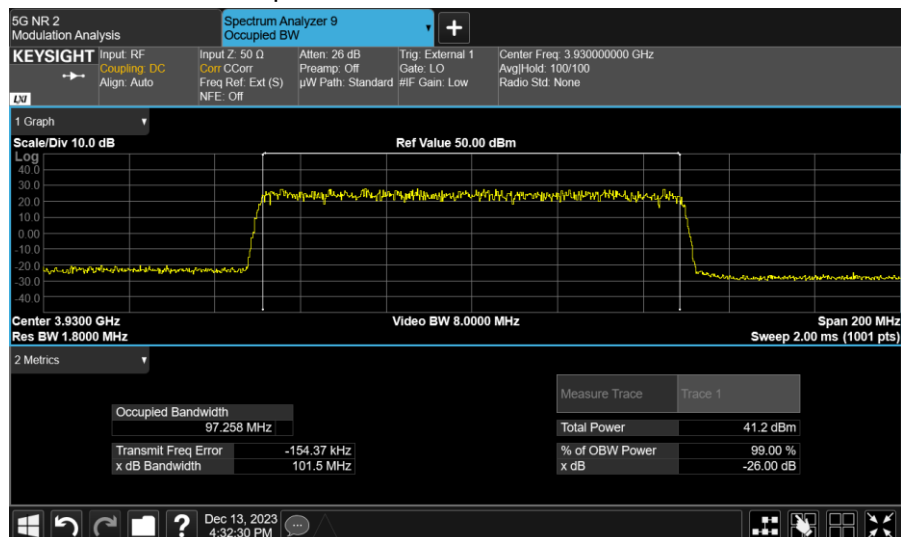

Port 5, QPSK 20.0M Channel position M

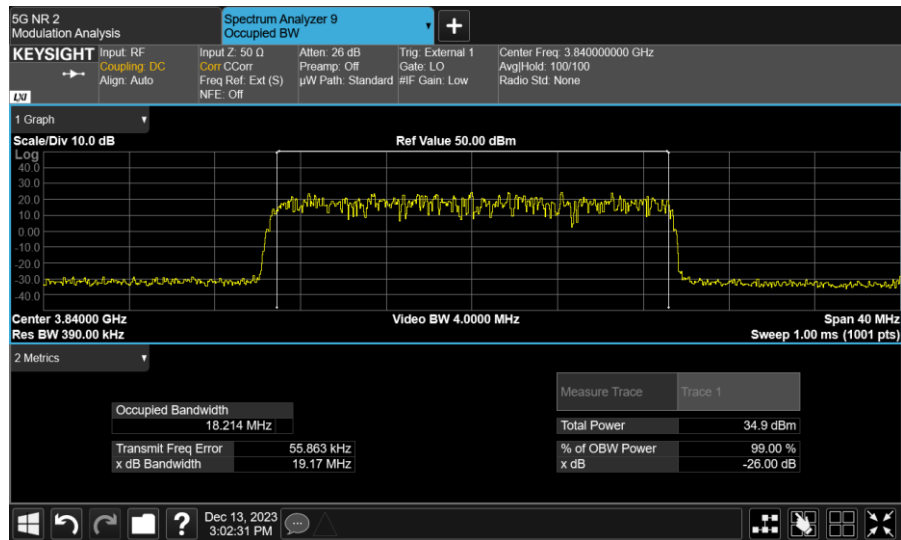

Port 5, 16QAM 20.0M Channel position M

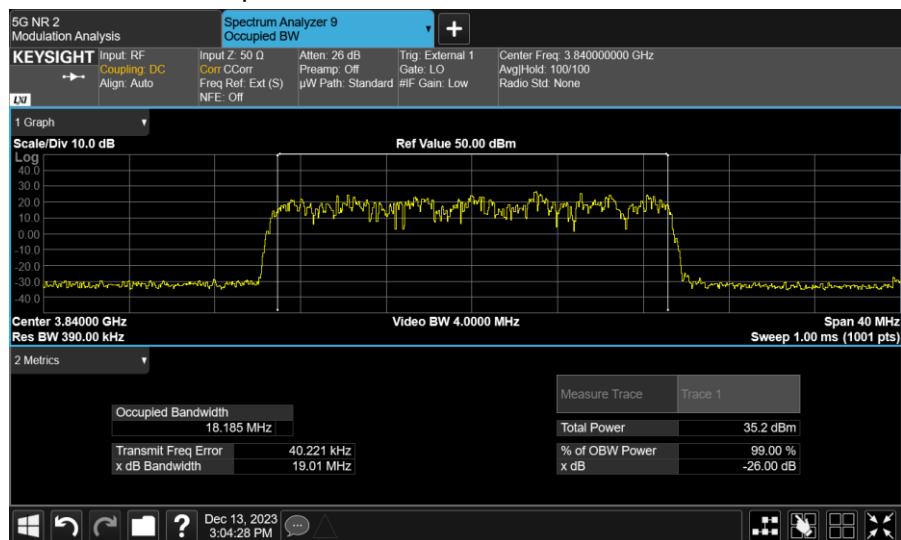

Port 5, 64QAM 20.0M Channel position M

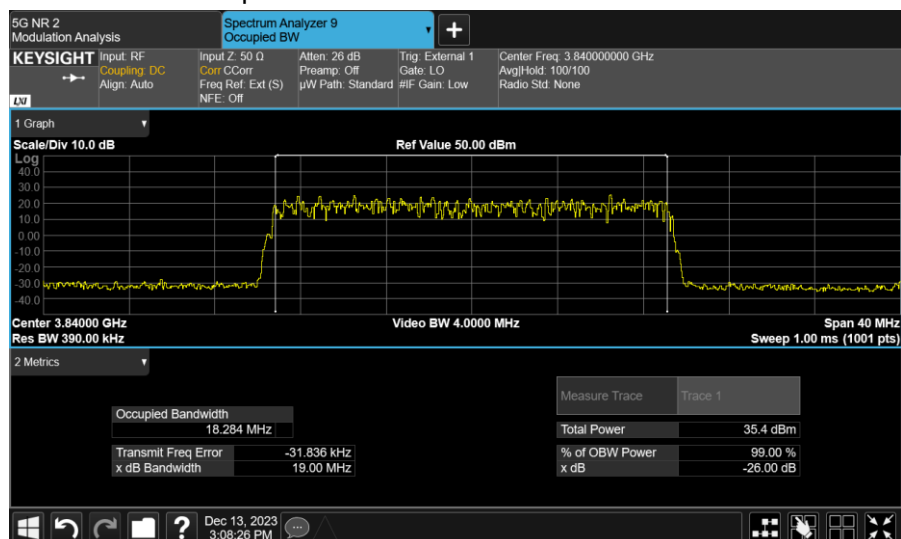

Port 5, QPSK 40.0M Channel position M

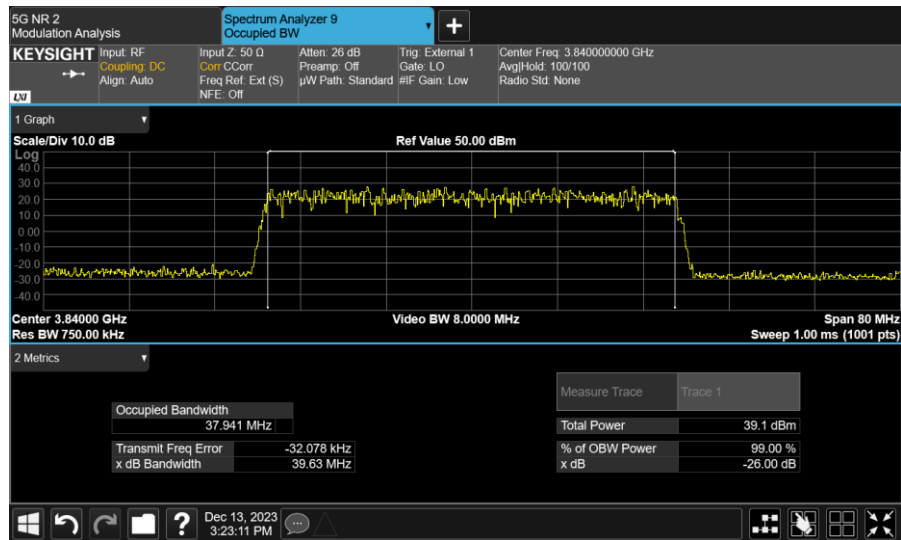

Port 5, 16QAM 40.0M Channel position M

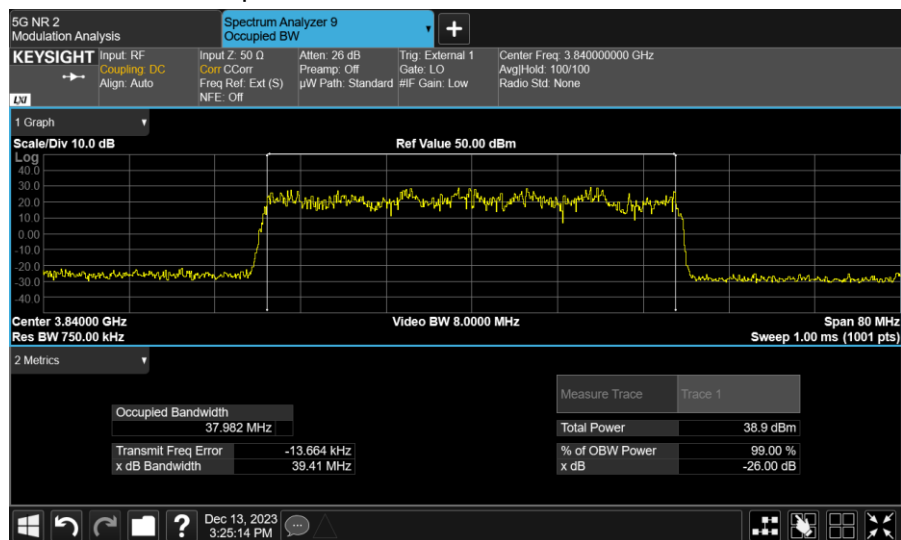

Port 5, 64QAM 40.0M Channel position M

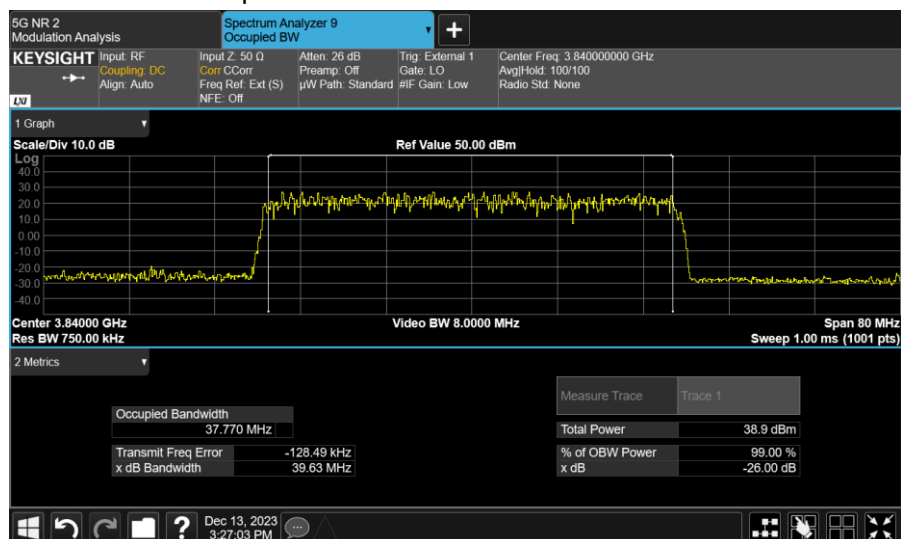

Port 5, QPSK 60.0M Channel position M

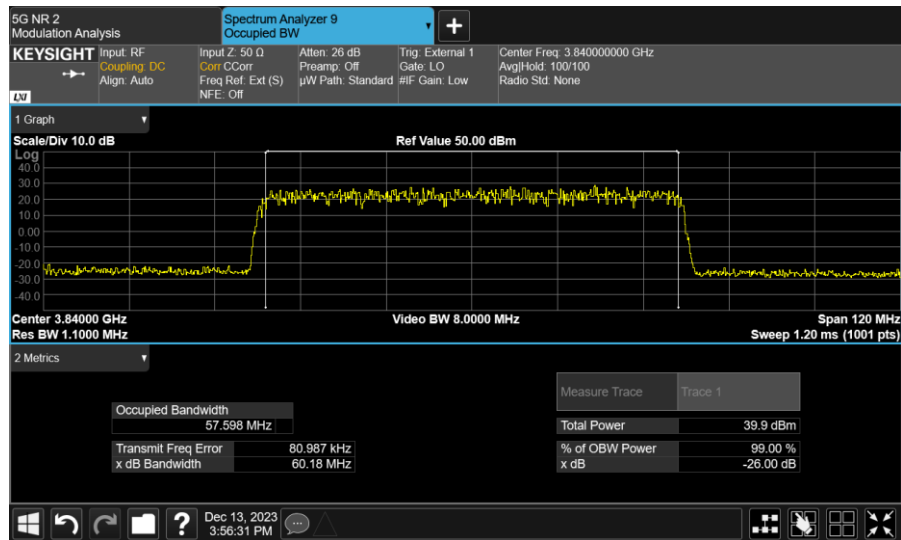

Port 5, 16QAM 60.0M Channel position M

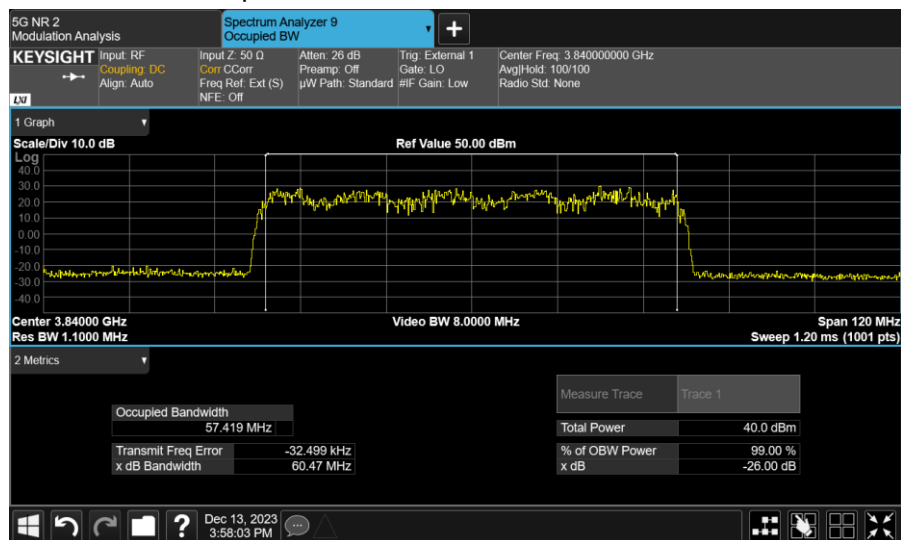

Port 5, 64QAM 60.0M Channel position M

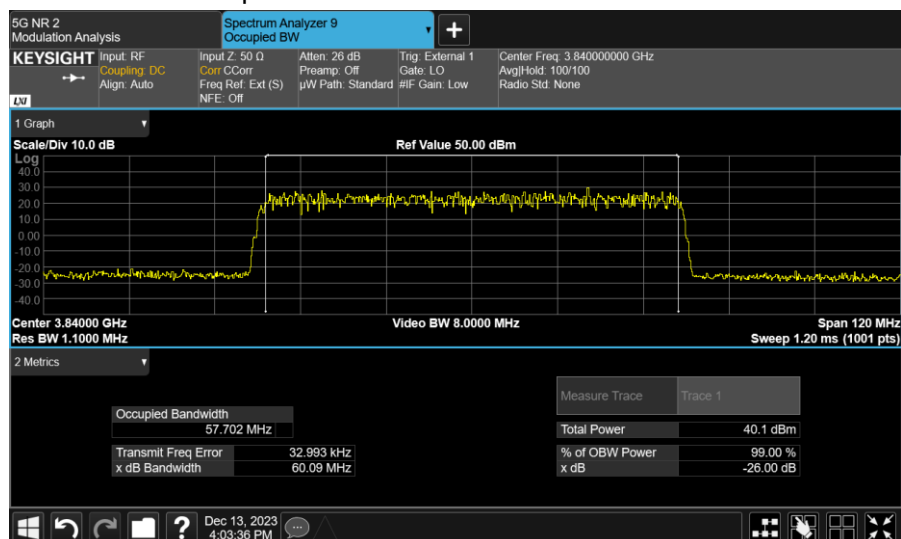

Port 5, QPSK 80.0M Channel position M

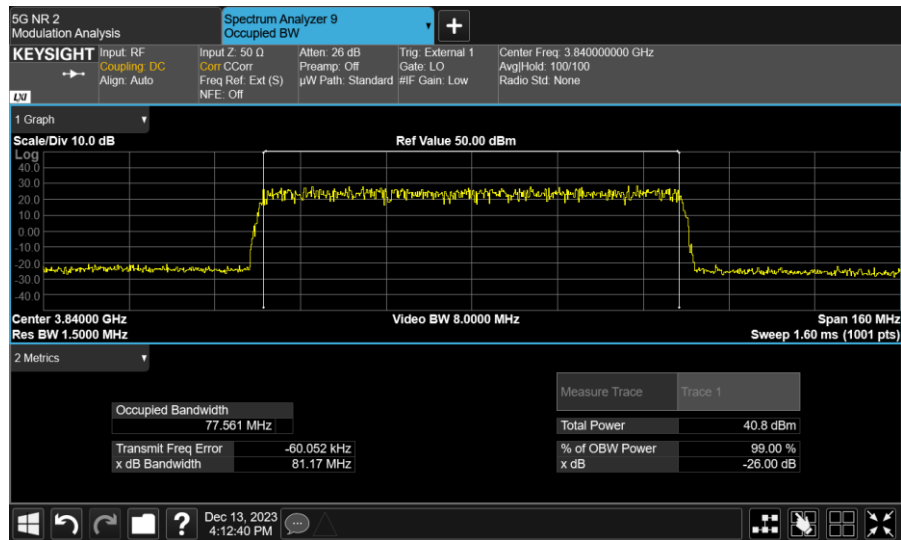

Port 5, 16QAM 80.0M Channel position M

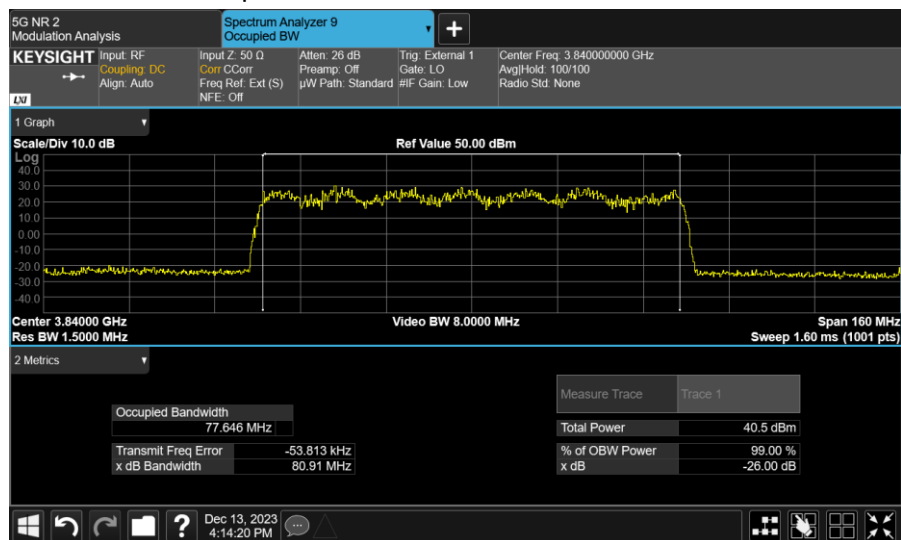

Port 5, 64QAM 80.0M Channel position M

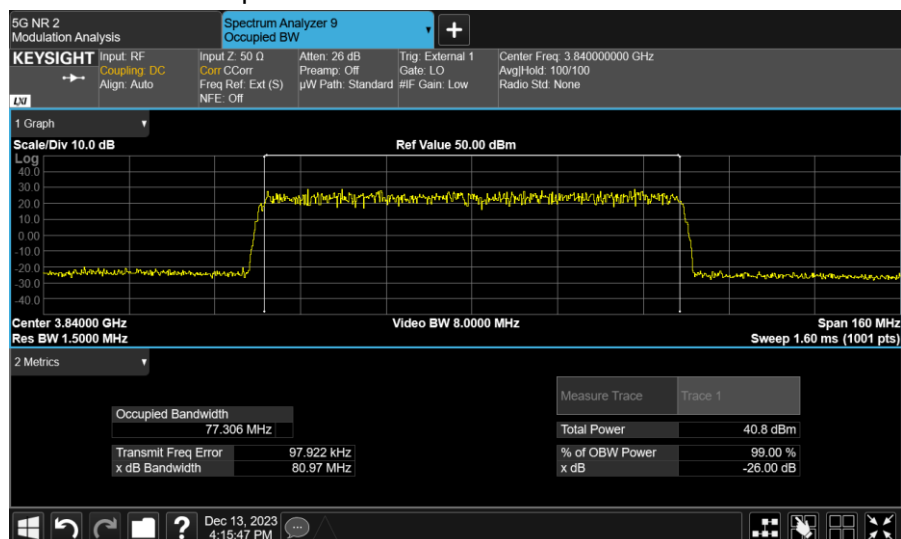

Port 5, QPSK 100.0M Channel position M

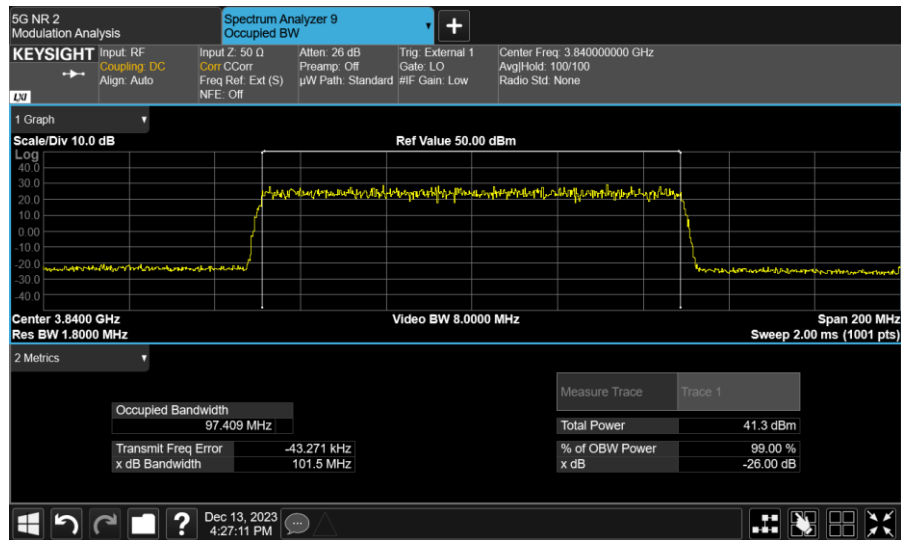

Port 5, 16QAM 100.0M Channel position M

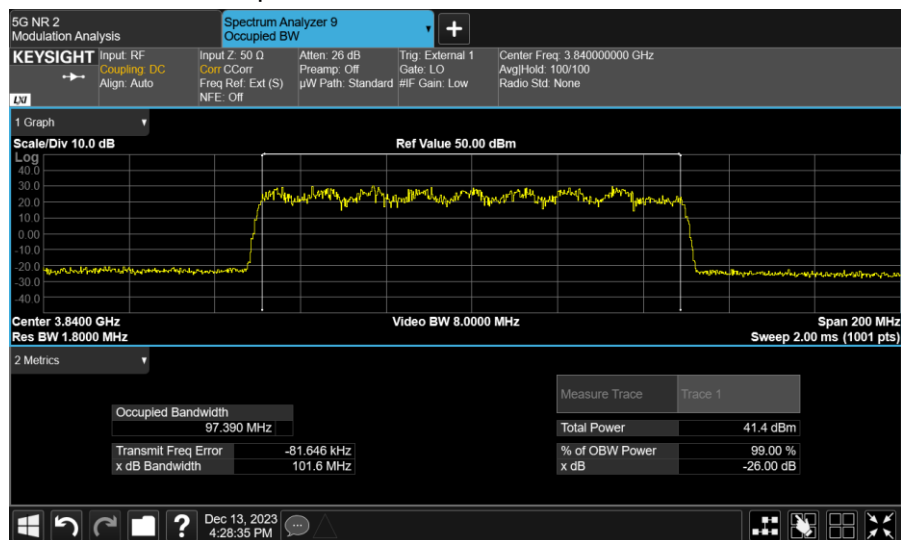

Port 5, 64QAM 100.0M Channel position M

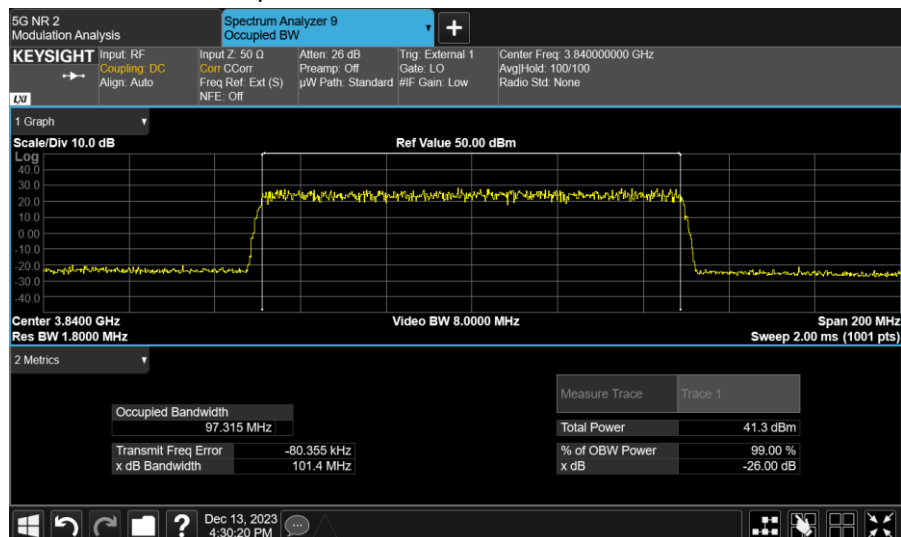

Configuration NR-MIMO-CA
 -26dBc Occupied Bandwidth

Antenna	Modulation / Bandwidth	Occupied Bandwidth (MHz)
		Channel Position M
5	256QAM/ CA 2C-100.0 MHz	204.30

99% Occupied Bandwidth

Antenna	Modulation / Bandwidth	Occupied Bandwidth (MHz)
		Channel Position M
5	256QAM/ CA 2C-100.0 MHz	196.13

Port 5, 256QAM CA 2C-100.0M Channel position M

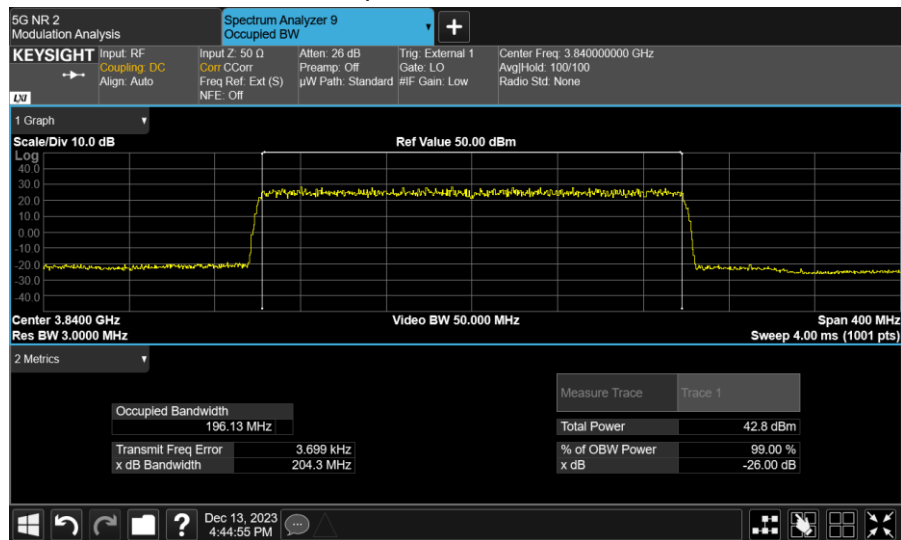

A.3 Transmitter unwanted emissions at Band Edge

A.3.1 Reference

FCC CFR 47 Part 2, Clause 2.1051

FCC CFR 47 Part 27, Clause 27.53(l)

A.3.2 Method of measurement

The conducted power of any emission outside the licensee's authorized bandwidth shall not exceed -13 dBm/MHz.

For MIMO mode configurations, the limit was adjusted with a correction of -12.05dB [10Log16] by using the Measure and Add 10Log(N) dB technique according to KDB 662911 D01 Multiple Transmitter Output accounting for simultaneous transmission from antenna ports. Then the limit was adjusted to -25.05dBm.

In the 1 MHz bands immediately outside and adjacent to the frequency block, a resolution bandwidth of at least one percent of the emission bandwidth of the fundamental emission of the transmitter may be employed and a RBW of 1MHz for measurements of emissions > 1MHz away from the band edges.

The limit was adjusted with -10.11dB [10Log(39/400)] to compensate for the reduced measurement bandwidth 39kHz for emission less than 1MHz away from the NR 40MHz and 2C 20MHz band edges.

The limit was adjusted with -9.86dB [10Log(62/600)] to compensate for the reduced measurement bandwidth 62kHz for emission less than 1MHz away from the NR 60MHz band edges.

The limit was adjusted with -9.90dB [10Log(82/800)] to compensate for the reduced measurement bandwidth 82kHz for emission less than 1MHz away from the NR 80MHz and 2C 40MHz band edges.

The limit was adjusted with -10.00dB [10Log(100/1000)] to compensate for the reduced measurement bandwidth 100kHz for emission less than 1MHz away from the NR 100MHz, 2C 60MHz, 2C 80MHz and 2C 100MHz band edges.

Spectrum analyzer detector was set as RMS.

A.3.3 Measurement limit

The conducted power of any emission outside the licensee's authorized bandwidth shall not exceed -13 dBm/MHz.

A.3.4 Measurement result

Configuration NR-MIMO-1C, 256QAM

Band Edge Frequency	Channel Bandwidth	RBW	Limit(dBm)
3700MHz	NR 20.0 MHz	200kHz/1MHz	-25.05/-25.05
3980MHz	NR 20.0 MHz	200kHz/1MHz	-25.05/-25.05

Port 5, Channel Position B, 20.0 MHz

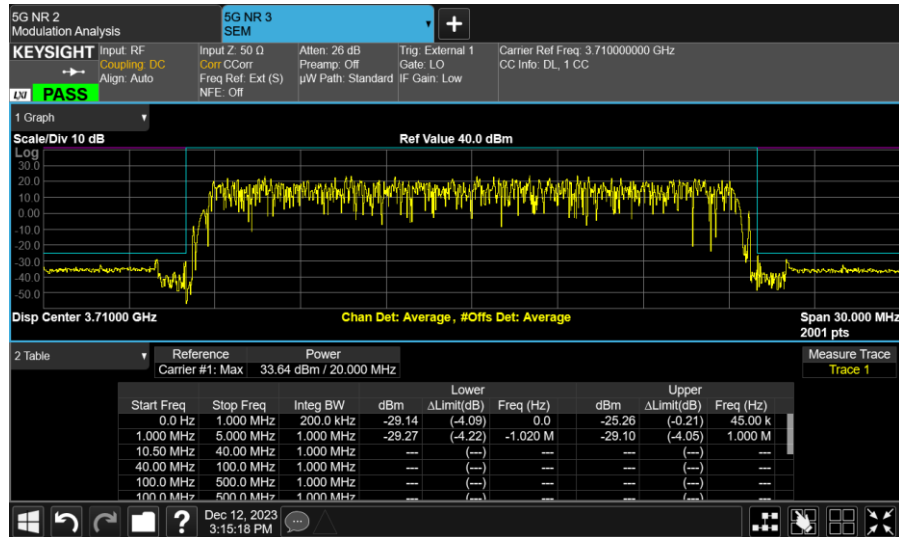

Port 5, Channel Position T, 20.0 MHz

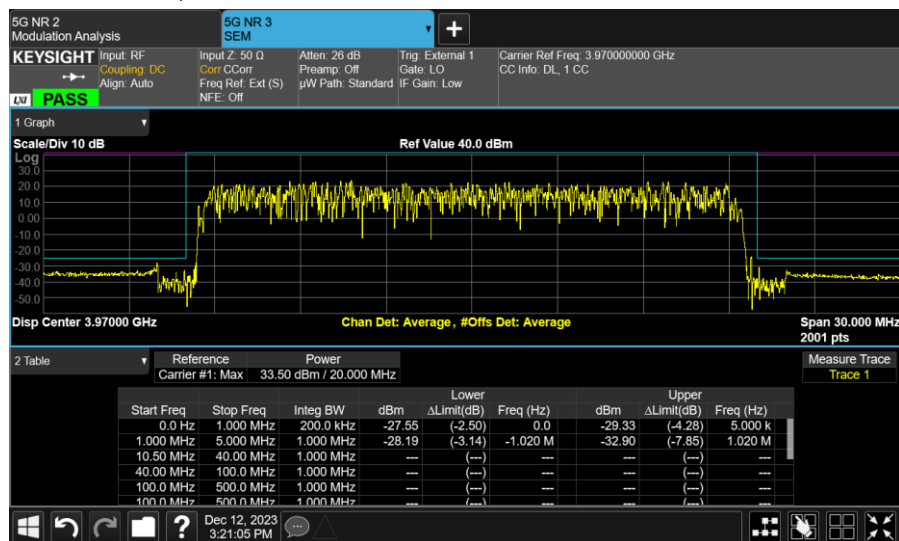

Configuration NR-MIMO-1C, 256QAM

Band Edge Frequency	Channel Bandwidth	RBW	Limit(dBm)
3700MHz	NR 40.0 MHz	39kHz/1MHz	-35.16/-25.05
3980MHz	NR 40.0 MHz	39kHz/1MHz	-35.16/-25.05

Port 5, Channel Position B, 40.0 MHz

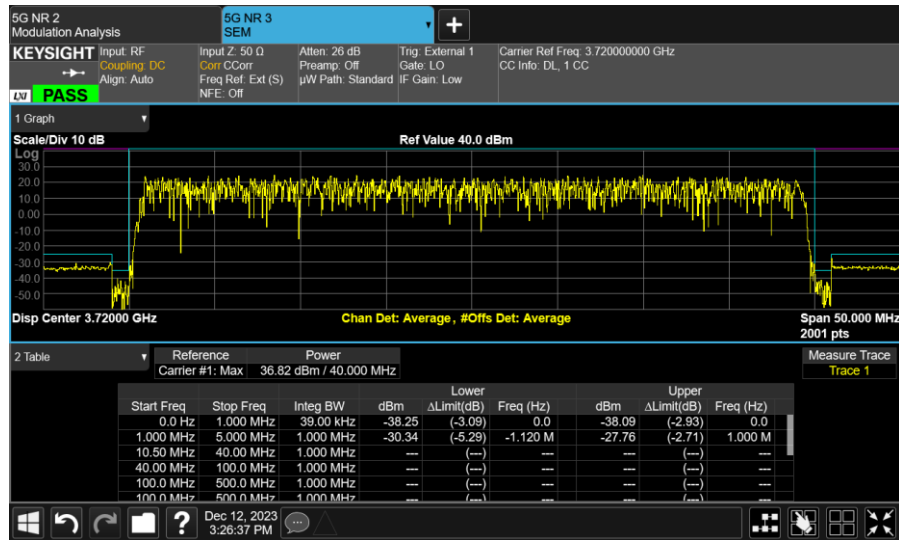

Port 5, Channel Position T, 40.0 MHz

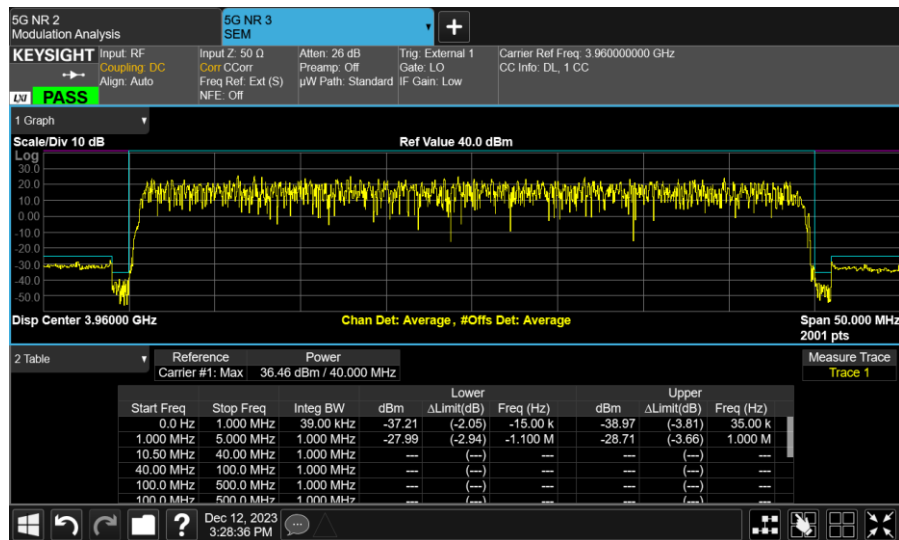

Configuration NR-MIMO-1C, 256QAM

Band Edge Frequency	Channel Bandwidth	RBW	Limit(dBm)
3700MHz	NR 60.0 MHz	62kHz/1MHz	-34.91/-25.05
3980MHz	NR 60.0 MHz	62kHz/1MHz	-34.91/-25.05

Port 5, Channel Position B, 60.0 MHz

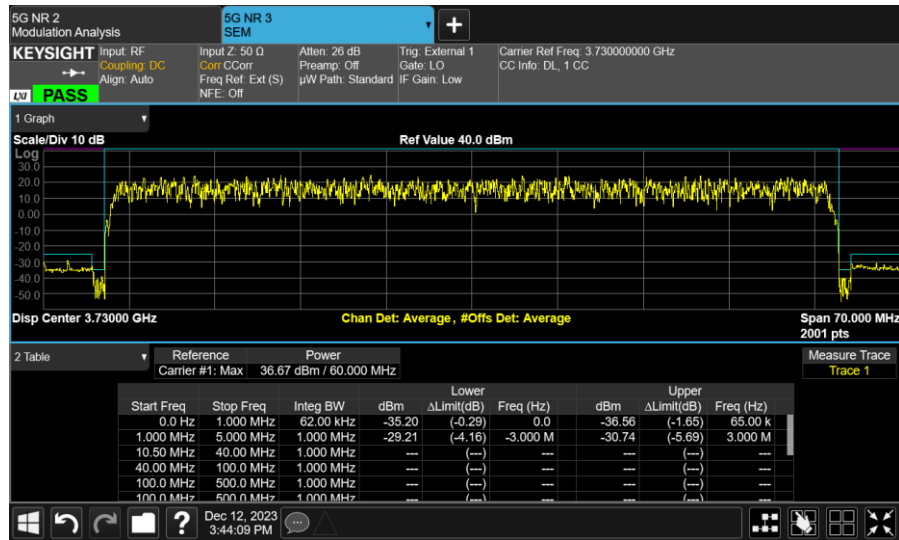

Port 5, Channel Position T, 60.0 MHz

