

Ericsson AB

RF TEST REPORT

Report Type:
FCC Part 27 RF report

PRODUCT NAME:
AIR 6419 B41

REPORT NUMBER:
230501093SHA-001

ISSUE DATE:
May 18, 2023

DOCUMENT CONTROL NUMBER:
TTRFFCC Part 27_V1 © 2018 Intertek



Applicant: Ericsson AB
Isafjordsgatan 10 SE-164 80 Stockholm 16480 Sweden

Manufacturer: Ericsson AB
Isafjordsgatan 10 SE-164 80 Stockholm 16480 Sweden

FCC ID: TA8AKRD901212

SUMMARY:

The equipment is tested according to the following standard(s) or Specification:

FCC CFR 47 Part 27: MISCELLANEOUS WIRELESS COMMUNICATIONS SERVICES

PREPARED BY:

Victor Yang

Project Engineer
Victor Yang

REVIEWED BY:

Jackson Huang

Reviewer
Jackson Huang

This report is for the exclusive use of Intertek's Client and is provided pursuant to the agreement between Intertek and its Client. Intertek's responsibility and liability are limited to the terms and conditions of the agreement. Intertek assumes no liability to any party, other than to the Client in accordance with the agreement, for any loss, expense or damage occasioned by the use of this report. Only the Client is authorized to permit copying or distribution of this report and then only in its entirety. Any use of the Intertek name or one of its marks for the sale or advertisement of the tested material, product or service must first be approved in writing by Intertek. The observations and test results in this report are relevant only to the sample tested. This report by itself does not imply that the material, product, or service is or has ever been under an Intertek certification program.

TEST REPORT

Content

REVISION HISTORY	4
MEASUREMENT RESULT SUMMARY	5
1 GENERAL INFORMATION	6
1.1 DESCRIPTION OF EQUIPMENT UNDER TEST (EUT)	6
1.2 TECHNICAL SPECIFICATION	7
1.3 DESCRIPTION OF TEST FACILITY	8
2 TEST SPECIFICATIONS	9
2.1 RELATED DOCUMENTS	9
2.2 PRODUCT INFORMATION.....	9
2.3 CONFIGURATION DESCRIPTION.....	10
2.4 TEST SETUP.....	11
2.5 TEST ENVIRONMENT CONDITION:.....	12
2.6 INSTRUMENT LIST	13
2.7 MEASUREMENT UNCERTAINTY	14
3 MAXIMUM OUTPUT POWER AND PEAK TO AVERAGE POWER RATIO AND EIRP	15
3.1 LIMIT	15
3.2 MEASUREMENT PROCEDURE	15
3.3 MEASUREMENT RESULT	16
4 OCCUPIED BANDWIDTH	19
4.1 MEASUREMENT PROCEDURE	19
4.2 MEASUREMENT RESULT	20
5 UNWANTED EMISSIONS AT BAND EDGE	22
5.1 LIMIT	22
5.2 MEASUREMENT PROCEDURE	22
5.3 MEASUREMENT RESULT	23
6 CONDUCTED UNWANTED EMISSION	26
6.1 LIMIT	26
6.2 MEASUREMENT PROCEDURE	26
6.3 MEASUREMENT RESULT	27

Revision History

Report No.	Version	Description	Issued Date
230501093SHA-001	Rev. 01	Initial issue of report	May 18, 2023

Measurement result summary

TEST ITEM	FCC REFERANCE	RESULT
Max Output Power and Peak to Average Power Ratio and EIRP	27.50(h) 2.1046	Pass
Occupied Bandwidth	27.53(m) 2.1049	Pass
Unwanted Emissions at Band Edge	27.53(m) 2.1051	Pass
Conducted Unwanted Emission	27.53(m) 2.1051	Pass

1 GENERAL INFORMATION

1.1 Description of Equipment Under Test (EUT)

Description:	Antenna Integrated Radio
Product name:	AIR 6419 B41
	KRD 901 212/1 (with un-security software and antenna) KRD 901 212/11 (with security software and antenna) KRD 901 212/3* (with un-security software and CAB board for testing purpose) KRD 901 212/31 (with security software and CAB board for testing purpose)
Product number:	Note *: This is the tested unit.
Serial Number(s)	E23E162080
Rating:	-48V DC
Software Version:	PIS: CXP2030038/7_R46A123, UP: CXP2010174/1_R72A133
Hardware Version:	R1E
Sample received date:	May 10, 2023
Date of test:	May 10, 2023 ~ May 12, 2023

TEST REPORT

1.2 Technical Specification

Frequency Range:	TX/RX: 2496-2690 MHz
Number of Antenna ports:	64 TX/RX
Supported RAT:	LTE, NR
Max RF bandwidth (IBW):	194 MHz
Supported Number of Carriers:	LTE SRO: 5, MRO: 3 NR SRO & MRO: 2 Total MRO: 5
Supported modulation:	QPSK, 16QAM, 64QAM, 256QAM
Supported Channel Bandwidth:	LTE: 10, 15, 20 MHz NR: 10, 15, 20, 30, 40, 50, 60, 70, 80, 90, 100 MHz
Declaration output power:	Maximum 4W/MHz up to 320W
Antenna:	25.8 dBi

TEST REPORT

1.3 Description of Test Facility

Conducted testing:

Name:	Intertek Testing Services Shanghai
Address 1:	Building 86, No. 1198 Qinzhou Road(North), Shanghai 200233, P.R. China
Address 2:	No. 5 Lize East Street, Ericsson Tower, Chaoyang District, Beijing 100102 P.R.C.
Telephone:	+86 21 61278200
Telefax:	+86 21 54262353
The test facility is recognized, certified, or accredited by these organizations:	FCC Accredited Lab Designation Number: CN0175
	IC Registration Lab CAB identifier.: CN0014
	A2LA Accreditation Lab Certificate Number: 3309.02

2 TEST SPECIFICATIONS

2.1 Related documents

FCC Part 27 (2021)

FCC Part 2 (2021)

ANSI C63.26:2015

KDB 971168 D01 v03r01

KDB 662911 D01 v02r01

2.2 Product Information

The Equipment Under Test (EUT) AIR 6419 B41 is an Ericsson Radio Unit working in the wireless communication services 2496-2690 MHz band which provides communication connections to 2496-2690 MHz network. AIR 6419 B41 operates from a -48V DC.

AIR 6419 B41 has 4 variants. Their difference is listed as below, and others are same.

KRD 901 212/1 (with un-security software and antenna)

KRD 901 212/11 (with security software and antenna)

KRD 901 212/3 (with un-security software and CAB board for testing purpose)

KRD 901 212/31 (with security software and CAB board for testing purpose)

Full tests were performed on KRD 901 212/3.

The EUT includes 64 TX/RX ports. It can be configured to transmit in MIMO mode, and MIMO mode was used for measurements as the worst configuration. The complete testing was performed with the EUT transmitting at maximum RF power unless otherwise stated.

A full technical description can be found in the Manufacturer's documentation.

TEST REPORT

2.3 Configuration Description

The following settings were used to represent all traffic scenarios. The output power was measured on the bottom, middle and top channel of all applicable antenna ports. By measuring the output power of QPSK, 16QAM, 64QAM and 256QAM on one of the antenna ports, it was determined that QPSK for NR was the worst case modulation schemes and were used for all testing.

Complete testing was carried out on the worst case antenna port which was established as being the highest output power from the 64 measured ports on worst case modulation scheme. This antenna port was Port 22 for all modes.

The settings below were used for all measurements unless otherwise noted:

Configuration	Carrier	NR Carrier Bandwidth (MHz)	Carrier Frequency Configuration (MHz)		
			Bottom	Middle	Top
NR-1C	1	15	2503.50	2593.02	2682.51
NR-2C	2	15	-	2503.50+2682.48	-

Configuration	Carrier	NR Carrier Bandwidth (MHz)	Carrier Frequency Configuration (MHz)		
			Bottom	Middle	Top
NR-1C-BE	1	15	2503.50	-	2682.51
NR-2C-BE	2	15	2503.50+2518.50	-	2667.51+2682.51

Configuration	Carrier	NR Carrier Bandwidth (MHz)	Carrier Frequency Configuration (MHz)		
			Bottom	Middle	Top
NR-1C-CE	1	15	2503.50	-	2682.51
NR-2C-CE	2	15	-	2503.50+2682.51	-

2.4 Test Setup

Conducted Measurement:

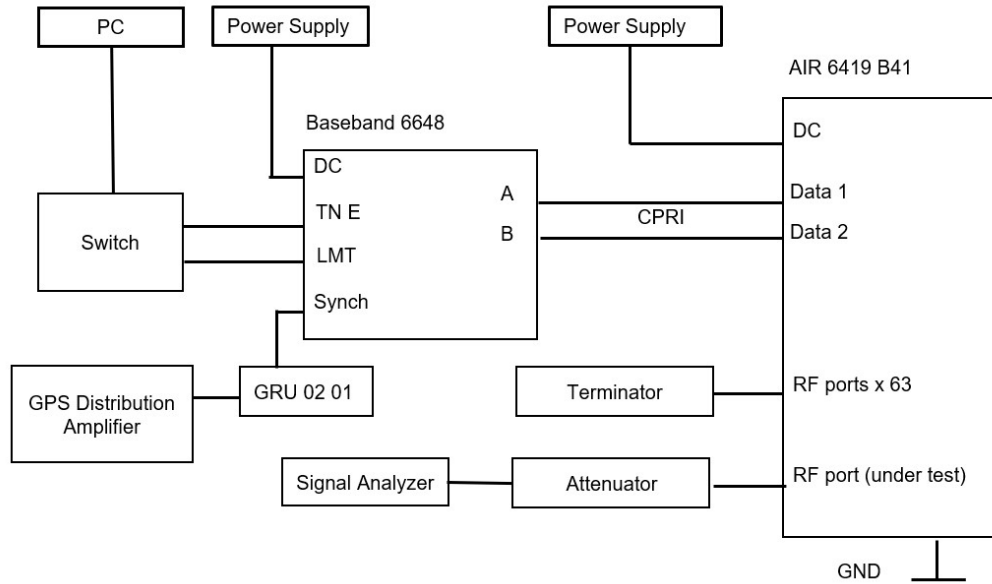

No.	Auxiliary Equipment	Product Number / Model Type	Version
1	PC	PowerEdge R230	-
2	DC Power Supply	N5767A/US17N6926P	-
3	DC Power Supply	N5767A/US22A1518R	-
4	Baseband 6648	KDU1370015/1	R3D
5	GRU 02 01	NCD 901 41/1	R1E
6	GPS Distribution Amplifier	58536A	-
7	Switch	LS-S5024E-CN	-
8	Terminator	HBTE-CT020-6-SM-15	-
9	Attenuator	DTS30GH-30-18G-SMAFM	-

2.5 Test environment condition:

Test items	Temperature	Humidity
Max Output Power and Peak to Average Power Ratio and EIRP	20°C to 24°C	45%RH to 55%RH
Occupied Bandwidth		
Unwanted Emissions at Band Edge		
Conducted Unwanted Emission		
Radiated Unwanted Emissions	21°C	51% RH
Frequency Stability	Please refer to clause 8	

2.6 Instrument list

Intertek Testing Services Shanghai					
Used	Equipment	Manufacturer	Type	S/N	Due date
<input checked="" type="checkbox"/>	PXA Signal Analyzer	Keysight	N9030A	MY54490394	2024.4.7
<input type="checkbox"/>	Signal Generator	R&S	SMU200A	104834	2024.4.2
<input type="checkbox"/>	Climatic Chamber	赛宝	CEEC-WR16H-50W	15-095	2023.9.19
<input checked="" type="checkbox"/>	Humiture meter	托普	TPJ-20	TP161108085	2024.2.21
<input checked="" type="checkbox"/>	Power sensor	R&S	NRP-Z11	107279	2023.7.14
<input checked="" type="checkbox"/>	Power sensor	R&S	NRP-Z21	104785	2023.7.14
<input checked="" type="checkbox"/>	Power meter	R&S	NRX	101690_BAMS-1002017384	2023. 8.9

2.7 Measurement uncertainty

The measurement uncertainty represents an expanded uncertainty expressed at approximately the 95% confidence level using a coverage factor of $k=2$.

Test item	Measurement uncertainty
Maximum output power	0.73dB
Occupied Bandwidth	0.88%
Unwanted Emissions at Band Edge	3.03dB
Conducted Unwanted Emission	3.03dB

TEST REPORT

3 Maximum Output Power and Peak to Average Power Ratio and EIRP

Test result: Pass

3.1 Limit

Output Power:

$$\text{EIRP} \leq 33 \text{ dBW} + 10\log(X/Y) \text{ dBW} + 10\log(360/\text{Beamwidth}) \text{ dBW}$$

X = actual channel bandwidth

Y = 5.5 or 6 MHz

(Y=6, Beamwidth=65 as declared by manufacturer)

Peak to Average Ratio: ≤ 13 dB

3.2 Measurement Procedure

The EUT was configured to transmit on maximum power and proper modulation. The transmitter power shall be measured in terms of a root-mean-square (RMS) average value.

A peak to average ratio measurement is performed at the conducted ports of the EUT for single carrier for single RAT mode. The spectrum analyzers Complementary Cumulative Distribution Function (CCDF) was used and 0.1% probability value recorded.

3.3 Measurement result

Configuration NR-1C

Antenna Port	Modulation	Carrier Bandwidth (MHz)	Output power / Peak-to-Average Ratio (PAR)								
			Channel position B			Channel position M			Channel position T		
			Power (dBm)	Power (dBm /MHz)	PAR (dB)	Power (dBm)	Power (dBm /MHz)	PAR (dB)	Power (dBm)	Power (dBm /MHz)	PAR (dB)
1	QPSK	15	28.71	17.71	8.35	28.81	17.79	8.35	28.88	18.05	8.35
2	QPSK	15	29.19	18.26	8.36	28.95	17.98	8.35	29.06	18.17	8.34
3	QPSK	15	28.75	17.83	8.42	28.54	17.52	8.42	28.60	17.80	8.41
4	QPSK	15	28.72	17.83	8.45	28.70	17.52	8.45	28.84	17.97	8.43
5	QPSK	15	28.84	17.97	8.40	28.71	17.70	8.39	28.83	17.96	8.37
6	QPSK	15	29.01	18.13	8.33	28.93	17.94	8.35	29.04	18.19	8.34
7	QPSK	15	28.98	18.04	8.42	28.89	17.91	8.42	28.92	18.05	8.40
8	QPSK	15	29.07	18.10	8.39	28.87	17.87	8.37	28.99	18.12	8.35
9	QPSK	15	28.91	17.99	8.38	28.74	17.74	8.38	28.87	18.05	8.36
10	QPSK	15	28.80	17.85	8.41	28.74	17.78	8.40	28.76	17.91	8.38
11	QPSK	15	28.97	17.98	8.36	28.79	17.80	8.35	28.80	18.03	8.33
12	QPSK	15	28.89	17.95	8.40	28.80	17.82	8.38	29.01	18.06	8.36
13	QPSK	15	28.70	17.78	8.44	28.59	17.58	8.44	28.64	17.89	8.44
14	QPSK	15	28.67	17.73	8.43	28.52	17.53	8.41	28.71	17.93	8.40
15	QPSK	15	28.81	17.82	8.34	28.74	17.73	8.34	28.85	18.04	8.33
16	QPSK	15	28.85	17.92	8.34	28.83	17.85	8.34	28.84	18.05	8.31
17	QPSK	15	29.23	18.26	8.22	29.07	18.06	8.24	29.17	18.27	8.21
18	QPSK	15	29.31	18.27	8.27	29.07	18.07	8.23	29.32	18.51	8.21
19	QPSK	15	29.04	18.11	8.33	28.84	17.85	8.31	29.01	18.14	8.29
20	QPSK	15	29.01	18.11	8.39	28.90	17.88	8.33	29.04	18.14	8.38
21	QPSK	15	28.91	18.02	8.27	28.82	17.83	8.27	28.92	18.08	8.26
22	QPSK	15	29.48	18.55	8.22	29.31	18.29	8.21	29.50	18.69	8.20
23	QPSK	15	28.96	18.02	8.32	28.79	17.84	8.31	28.99	18.19	8.29
24	QPSK	15	29.24	18.28	8.25	29.14	18.12	8.26	29.29	18.44	8.22
25	QPSK	15	29.20	18.25	8.25	29.12	18.07	8.24	29.32	18.34	8.22
26	QPSK	15	29.07	18.17	8.30	28.97	17.96	8.30	29.18	18.25	8.28
27	QPSK	15	29.25	18.29	8.21	29.06	18.06	8.21	29.22	18.40	8.17
28	QPSK	15	29.14	18.24	8.28	29.02	18.02	8.25	29.28	18.49	8.23
29	QPSK	15	28.78	17.89	8.46	28.65	17.65	8.35	28.94	18.05	8.34
30	QPSK	15	28.92	17.97	8.32	28.81	17.82	8.31	28.95	18.13	8.30
31	QPSK	15	29.21	18.26	8.23	29.11	18.01	8.23	29.21	18.42	8.22
32	QPSK	15	29.26	18.26	8.22	29.09	18.04	8.21	29.25	18.38	8.17
33	QPSK	15	29.18	18.24	8.23	29.07	18.08	8.22	29.28	18.40	8.20
34	QPSK	15	29.25	18.29	8.24	29.06	17.90	8.23	29.27	18.41	8.21
35	QPSK	15	28.96	18.07	8.33	28.90	17.91	8.31	29.05	18.16	8.32
36	QPSK	15	28.92	18.02	8.36	28.77	17.74	8.36	28.99	18.13	8.34

TEST REPORT

37	QPSK	15	29.15	18.19	8.29	29.02	17.97	8.30	29.08	18.18	8.27
38	QPSK	15	29.19	18.22	8.23	29.11	18.12	8.22	29.24	18.35	8.23
39	QPSK	15	29.04	18.14	8.31	28.91	17.92	8.32	28.98	18.06	8.30
40	QPSK	15	29.01	18.09	8.26	28.92	17.97	8.27	29.11	18.23	8.24
41	QPSK	15	29.14	18.18	8.28	29.03	18.01	8.27	29.15	18.30	8.25
42	QPSK	15	29.09	18.17	8.33	28.98	18.01	8.32	29.20	18.31	8.33
43	QPSK	15	29.30	18.39	8.24	29.18	18.16	8.24	29.45	18.54	8.22
44	QPSK	15	29.21	18.22	8.32	29.05	18.04	8.30	29.19	18.32	8.28
45	QPSK	15	29.01	18.06	8.39	28.94	17.90	8.37	28.93	18.12	8.39
46	QPSK	15	29.02	18.08	8.36	28.91	17.88	8.33	29.10	18.33	8.32
47	QPSK	15	29.13	18.19	8.26	29.17	18.15	8.26	29.30	18.48	8.24
48	QPSK	15	29.33	18.36	8.26	29.17	18.19	8.26	29.36	18.56	8.23
49	QPSK	15	29.04	18.11	8.31	28.89	17.86	8.30	29.02	18.23	8.26
50	QPSK	15	29.17	18.25	8.32	29.03	18.04	8.32	29.12	18.23	8.31
51	QPSK	15	28.89	17.95	8.39	28.71	17.72	8.38	28.79	18.00	8.37
52	QPSK	15	28.82	17.94	8.44	28.77	17.70	8.44	28.84	17.99	8.42
53	QPSK	15	29.03	18.04	8.35	28.87	17.88	8.34	28.95	18.00	8.34
54	QPSK	15	29.12	18.19	8.30	28.91	17.92	8.30	29.04	18.21	8.28
55	QPSK	15	28.92	18.00	8.39	28.77	17.78	8.36	28.91	17.99	8.35
56	QPSK	15	29.26	18.33	8.33	29.06	18.04	8.33	29.34	18.52	8.31
57	QPSK	15	28.97	18.01	8.33	28.82	17.82	8.32	28.89	18.02	8.31
58	QPSK	15	28.91	18.00	8.37	28.84	17.83	8.37	29.02	18.12	8.35
59	QPSK	15	28.95	18.05	8.29	28.80	17.79	8.30	28.92	18.13	8.29
60	QPSK	15	28.89	17.97	8.37	28.86	17.84	8.35	29.02	18.20	8.33
61	QPSK	15	28.62	17.70	8.41	28.56	17.47	8.43	28.62	17.81	8.39
62	QPSK	15	28.82	17.90	8.40	28.73	17.64	8.38	28.84	18.06	8.38
63	QPSK	15	28.90	18.00	8.31	28.81	17.81	8.31	29.00	18.20	8.30
64	QPSK	15	28.97	18.09	8.31	28.93	17.90	8.29	29.08	18.23	8.29
Total			47.08	36.15	-	46.96	35.95	-	47.10	36.25	-
Antenna gain			25.8	-	-	25.8	-	-	25.8	-	-
EIRP limit			74.41	-	-	74.41	-	-	74.41	-	-

Configuration NR-2C

Antenna Port	Modulation	Carrier Bandwidth (MHz)	Output power / Peak-to-Average Ratio (PAR)								
			Channel position B			Channel position M			Channel position T		
			Power (dBm)	Power (dBm /MHz)	PAR (dB)	Power (dBm)	Power (dBm /MHz)	PAR (dB)	Power (dBm)	Power (dBm /MHz)	PAR (dB)
22	QPSK	15	-	-	-	28.78	14.92	-	-	-	-
10log64			-	-	-	18.06	18.06	-	-	-	-
Total			-	-	-	46.84	32.98	-	-	-	-
Antenna gain			-	-	-	25.8	-	-	-	-	-
EIRP limit			-	-	-	74.41	-	-	-	-	-

4 Occupied Bandwidth

Test result: Pass

4.1 Measurement Procedure

The EUT was set to transmit at maximum power and testing was carried out on bottom, middle and top channels. Using the Occupied Bandwidth measurement function in the spectrum analyzer, the 26dB bandwidth was measured in accordance with FCC KDB 971168 D01 Clause 4.2.

The measurement method is from KDB 971168 4.2:

- a) The spectrum analyzer center frequency is set to the nominal EUT channel center frequency. The frequency span for the spectrum analyzer shall be set wide enough to capture all modulation products including the emission skirts (i.e., two to five times the OBW).
- b) The nominal IF filter bandwidth (3 dB RBW) shall be in the range of 1 to 5 % of the anticipated OBW, and the VBW shall be at least 3 times the RBW.
- c) Set the reference level of the instrument as required to keep the signal from exceeding the maximum input mixer level for linear operation. In general, the peak of the spectral envelope must be at least $10\log(\text{OBW} / \text{RBW})$ below the reference level.
- d) Set the detection mode to peak, and the trace mode to max hold.
- e) Use the 99 % power bandwidth function of the spectrum analyzer and report the measured bandwidth.

TEST REPORT

4.2 Measurement result

Configuration NR- 1C

99% Occupied Bandwidth

Antenna Port	Modulation	Bandwidth	Occupied Bandwidth (MHz)		
			Channel Position B	Channel Position M	Channel Position T
22	QPSK	15MHz	13.604	13.589	13.596

-26dBc Occupied Bandwidth

Antenna Port	Modulation	Bandwidth	Occupied Bandwidth (MHz)		
			Channel Position B	Channel Position M	Channel Position T
22	QPSK	15MHz	14.66	14.71	14.71

15MHz, Channel position B

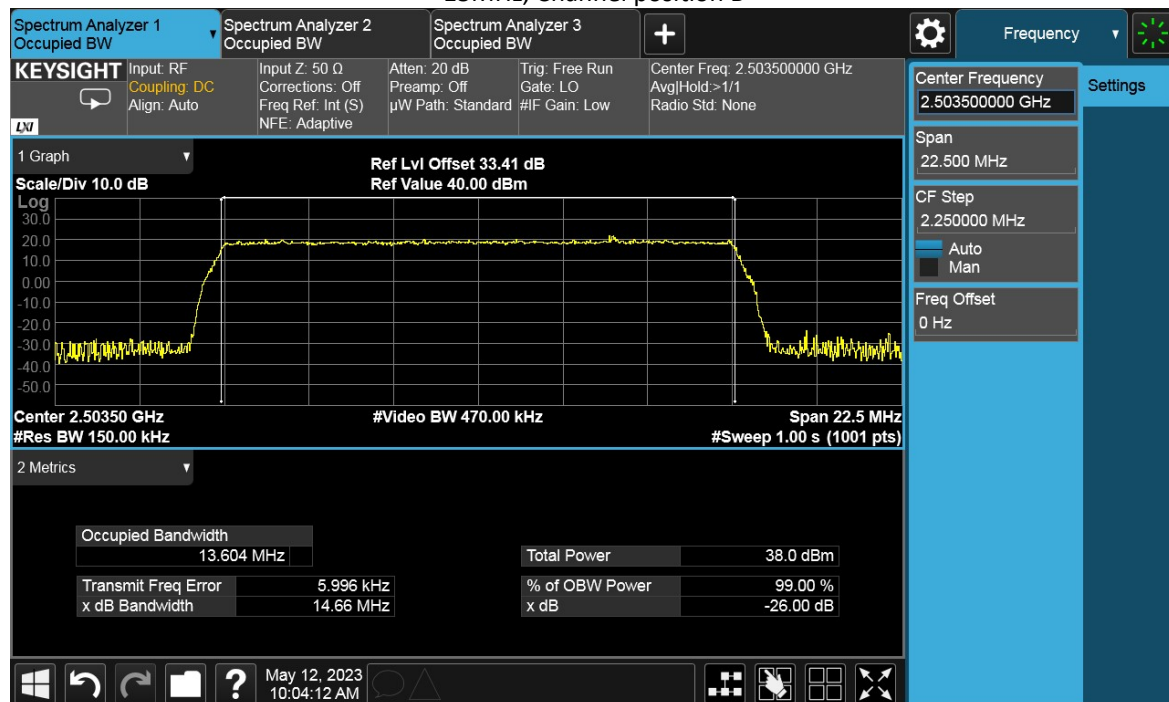

15MHz, Channel position M

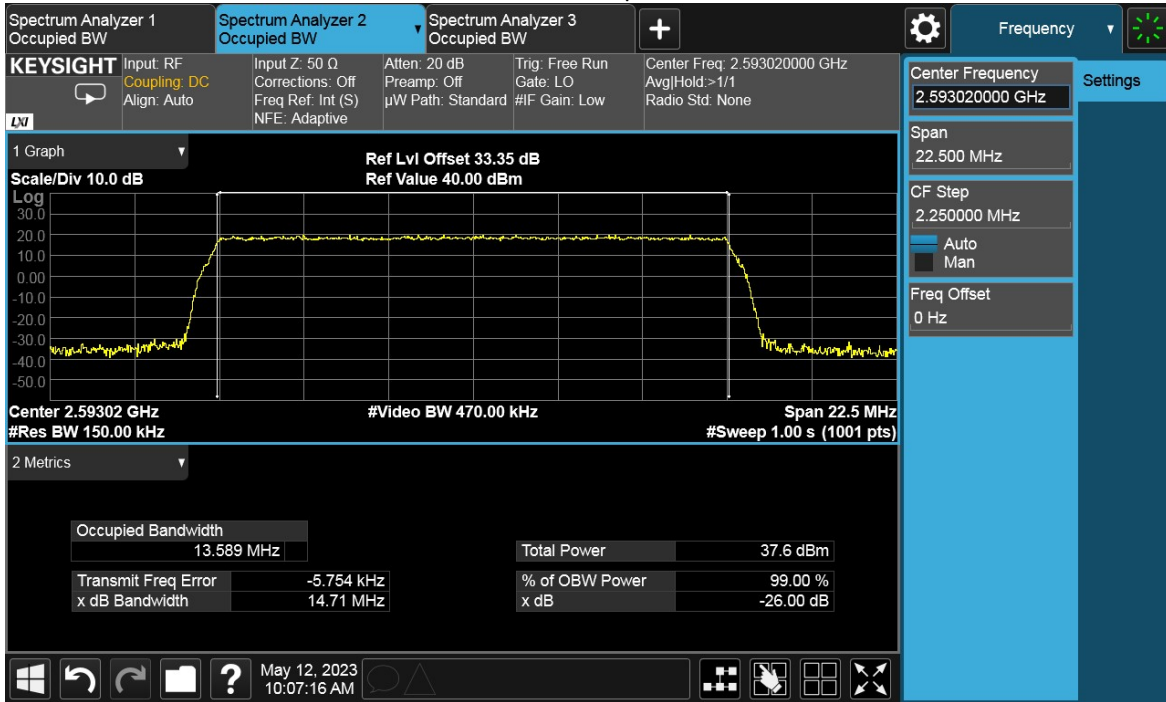

15MHz, Channel position T

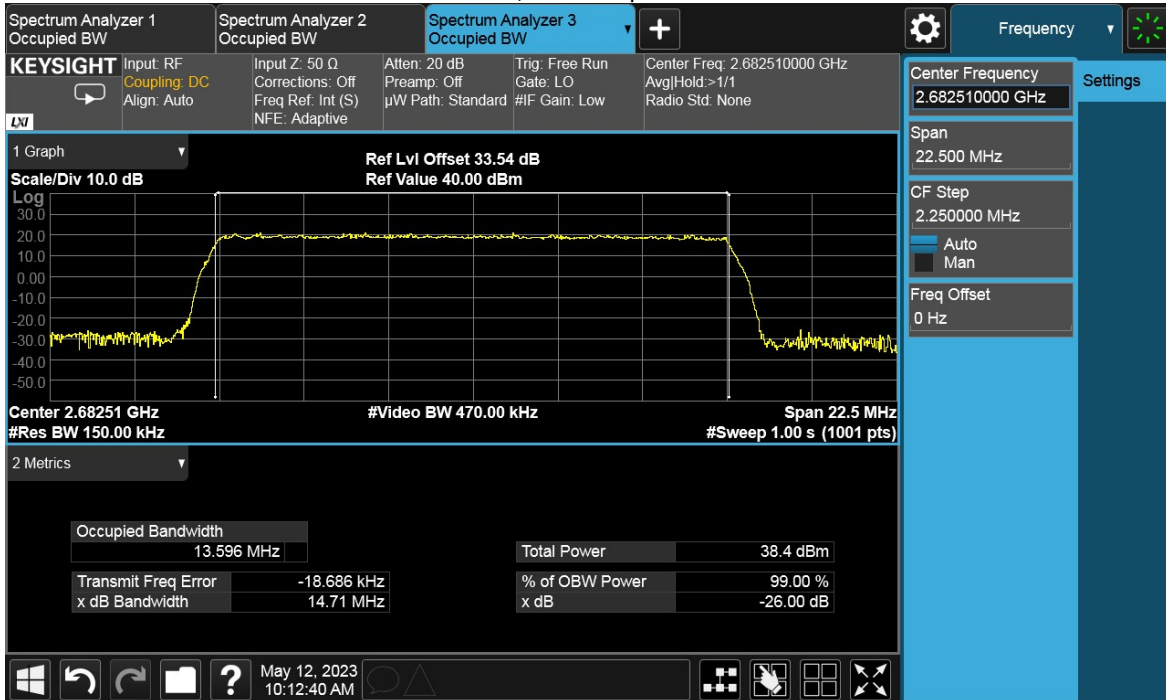

TEST REPORT**5 Unwanted Emissions at Band Edge****Test result: Pass****5.1 Limit**

The power of any emission outside of the authorized operating frequency ranges must be attenuated below the transmitting power (P) by a factor of at least $43 + 10\log(P)$ dB.

5.2 Measurement Procedure

The power of any emission outside of the authorized operating frequency ranges must be attenuated below the transmitting power (P) by a factor of at least $43 + 10\log(P)$ dB.

For MIMO mode configurations, the limit was adjusted with a correction of -18.06dB [$10\log(1/64)$] by using the Measure and Add $10\log(N)$ dB technique according to KDB 662911 D01 Multiple Transmitter Output accounting for simultaneous transmission from antenna ports . Then the limit was adjusted to -31.06dBm .

In the 1 MHz bands immediately outside and adjacent to the frequency block, a resolution bandwidth of at least one percent of the emission bandwidth of the fundamental emission of the transmitter may be employed and a RBW of 1MHz for measurements of emissions $> 1\text{MHz}$ away from the band edges.

Spectrum analyzer detector was set as RMS.

TEST REPORT

5.3 Measurement result

Configuration NR-1C-UE

Antenna Port	Channel Position	Modulation	Channel Bandwidth (MHz)	RBW (kHz)	Limit (dBm)
22	B	QPSK	15	150	-31.06
22	T	QPSK	15	150	-31.06

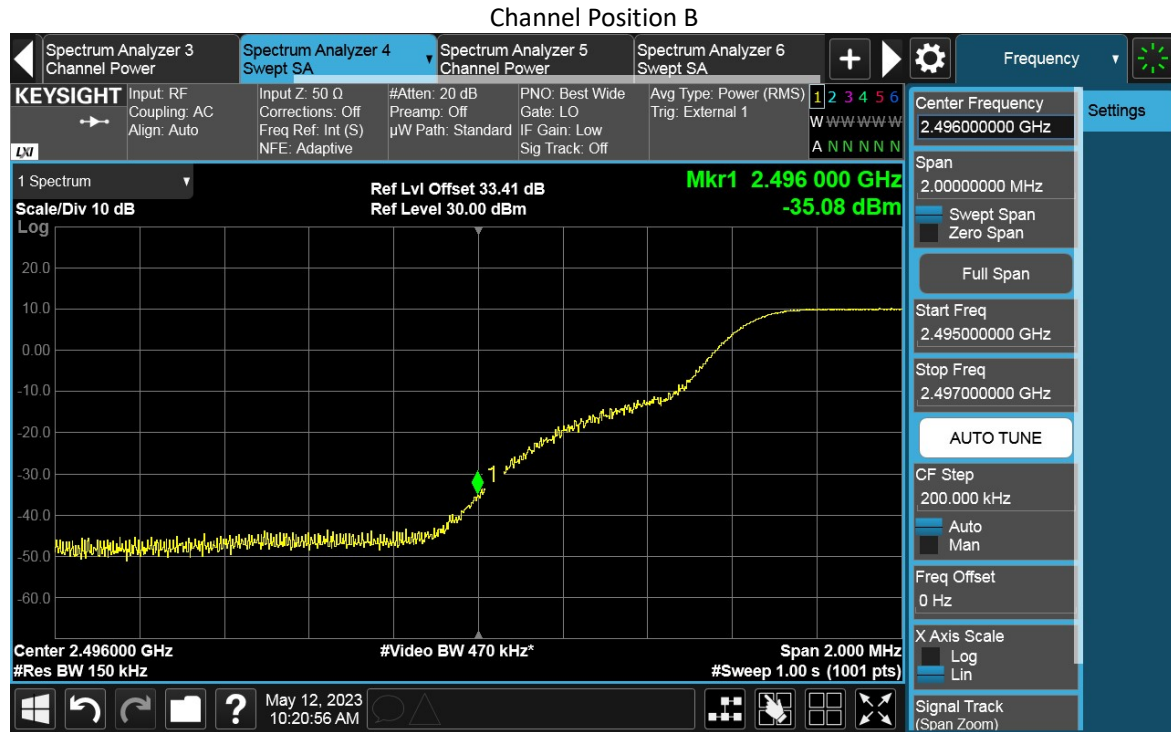

Channel Position T

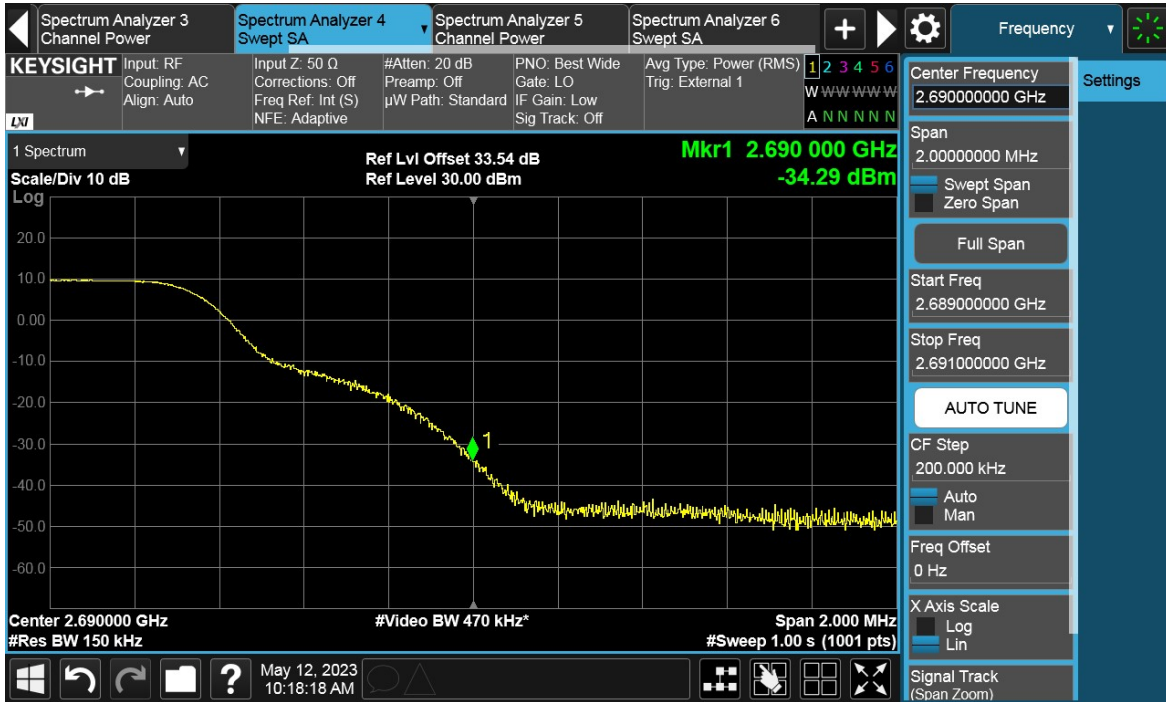

Configuration NR-2C-UE

Antenna Port	Channel Position	Modulation	Channel Bandwidth (MHz)	RBW (kHz)	Limit (dBm)
22	B	QPSK	15	150	-31.06
22	T	QPSK	15	150	-31.06

Channel Position B

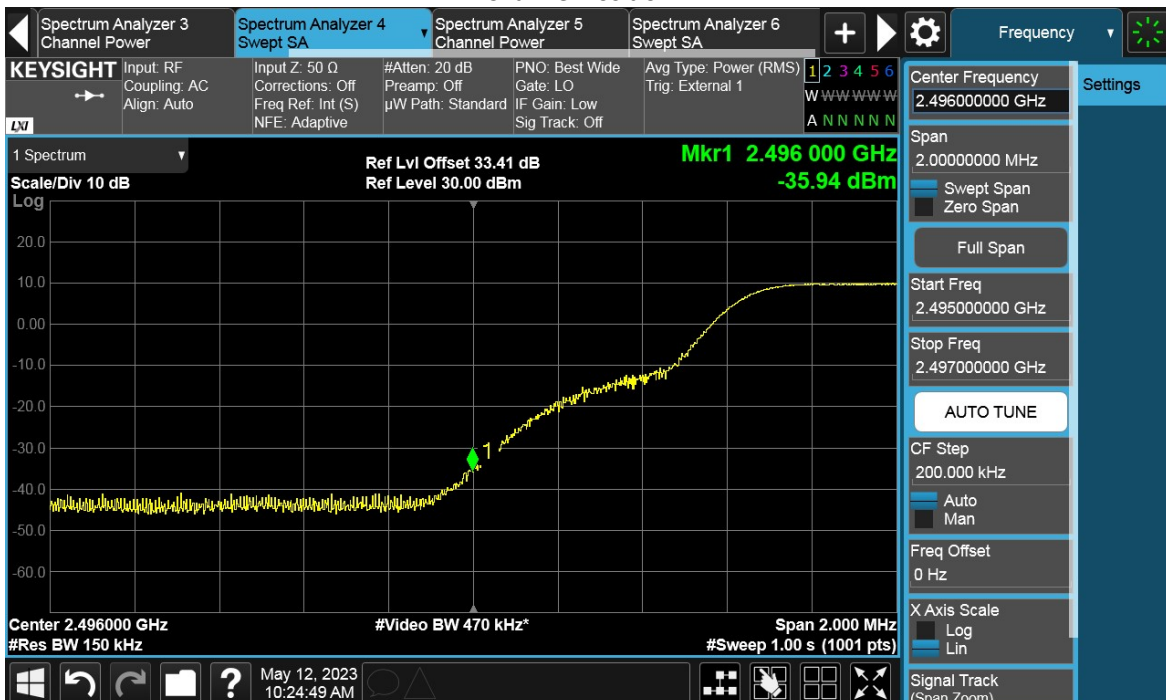

Channel Position T

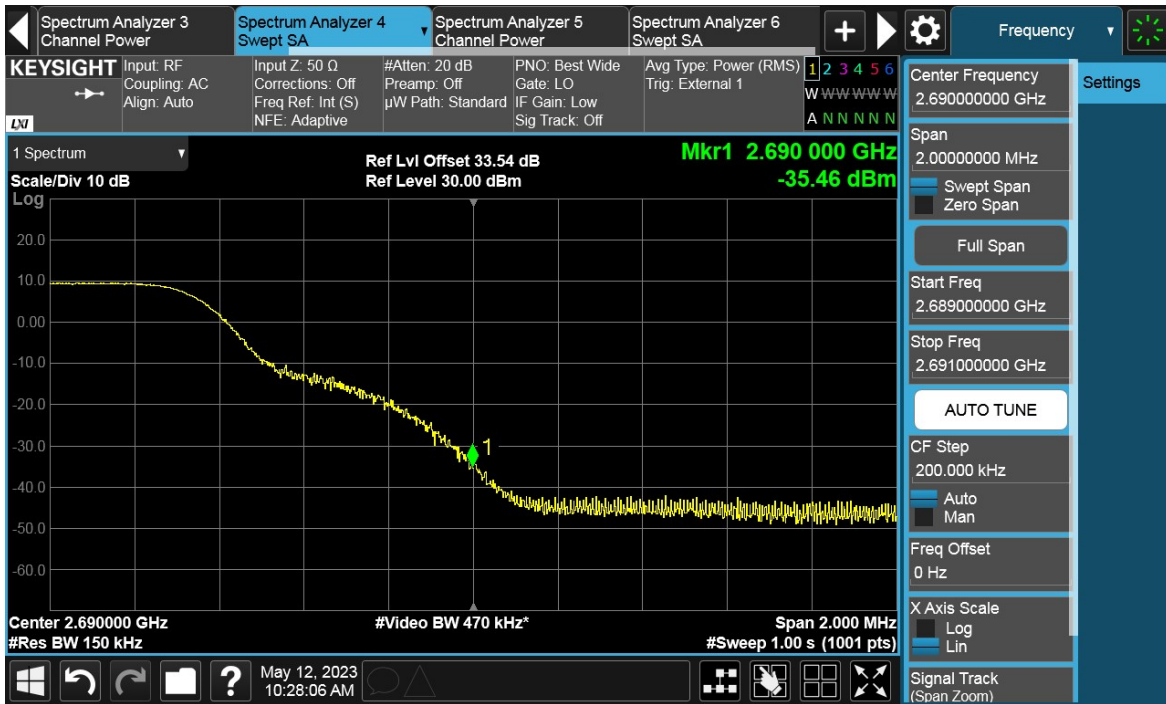

TEST REPORT**6 Conducted Unwanted Emission**

Test result: Pass

6.1 Limit

The power of any emission outside of the authorized operating frequency ranges must be attenuated below the transmitting power (P) by a factor of at least $43 + 10\log(P)$ dB.

6.2 Measurement Procedure

In accordance with FCC rules, the power of any emission outside of the authorized operating frequency ranges must be attenuated below the transmitting power (P) by a factor of at least $43 + 10\log(P)$ dB.

The spurious emissions from the antenna terminal were measured. The transmitter output power was attenuated using an attenuator and the frequency spectrum investigated from 9kHz to 27GHz. The resolution bandwidth of 1MHz was employed for frequency band 9kHz to 27GHz. The spectrum analyzer detector was set to RMS.

For MIMO mode configurations, the limit was adjusted with a correction of -18.06dB [$10\log(1/64)$] by using the Measure and Add $10\log(N)$ dB technique according to KDB 662911 D01 Multiple Transmitter Output accounting for simultaneous transmission from antenna ports. Then the limit was adjusted to -31.06dBm .

TEST REPORT

6.3 Measurement result

Configuration NR-1C-UE

Antenna Port	Channel Position	Modulation	Channel Bandwidth (MHz)	RBW (kHz)	Limit (dBm)
22	B	QPSK	15	1000	-31.06
22	T	QPSK	15	1000	-31.06

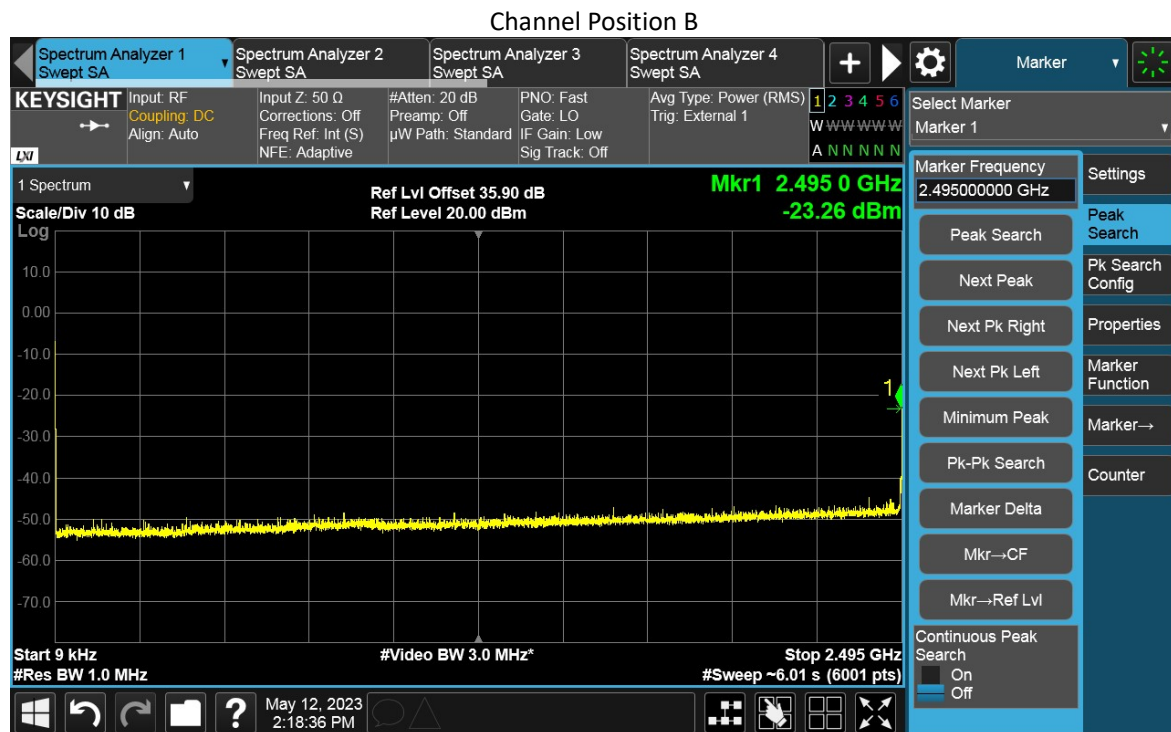

Total Quality. Assured.

TEST REPORT

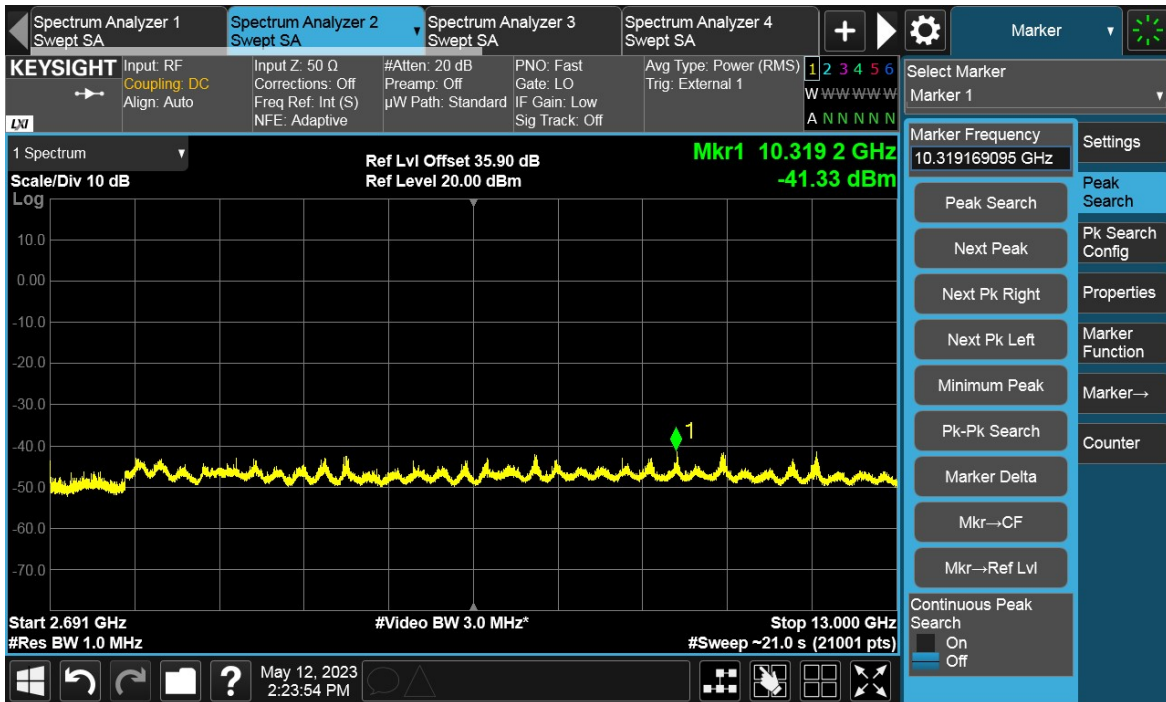
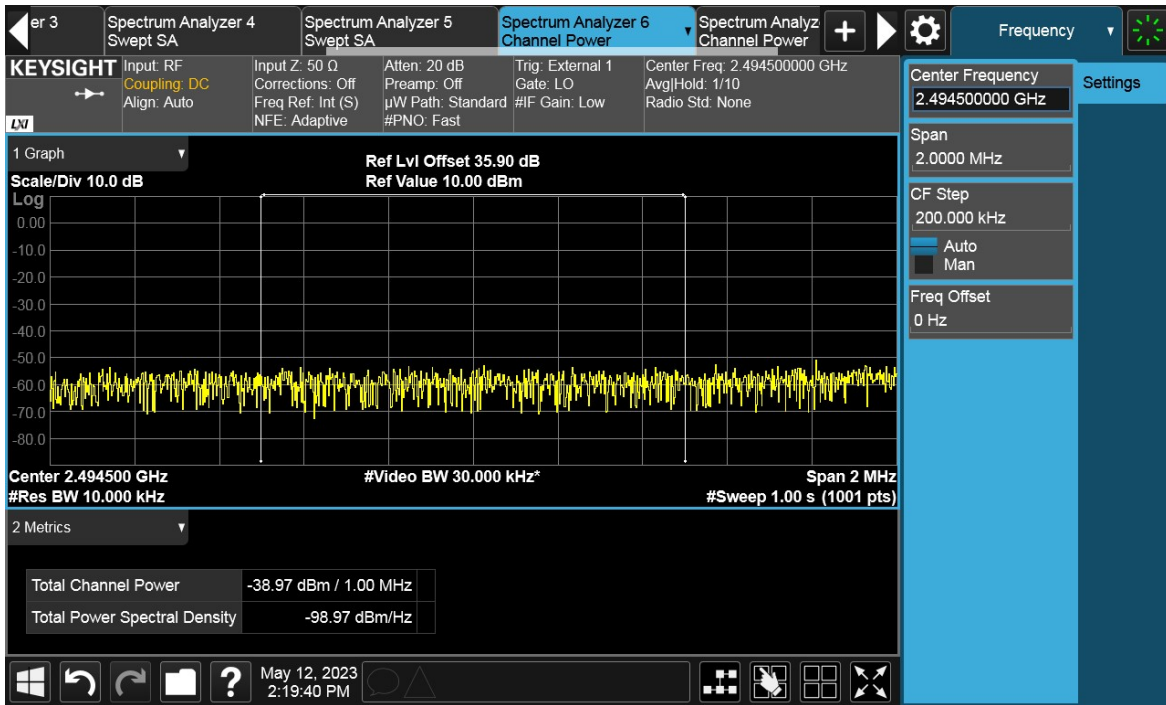

Total Quality. Assured.

TEST REPORT

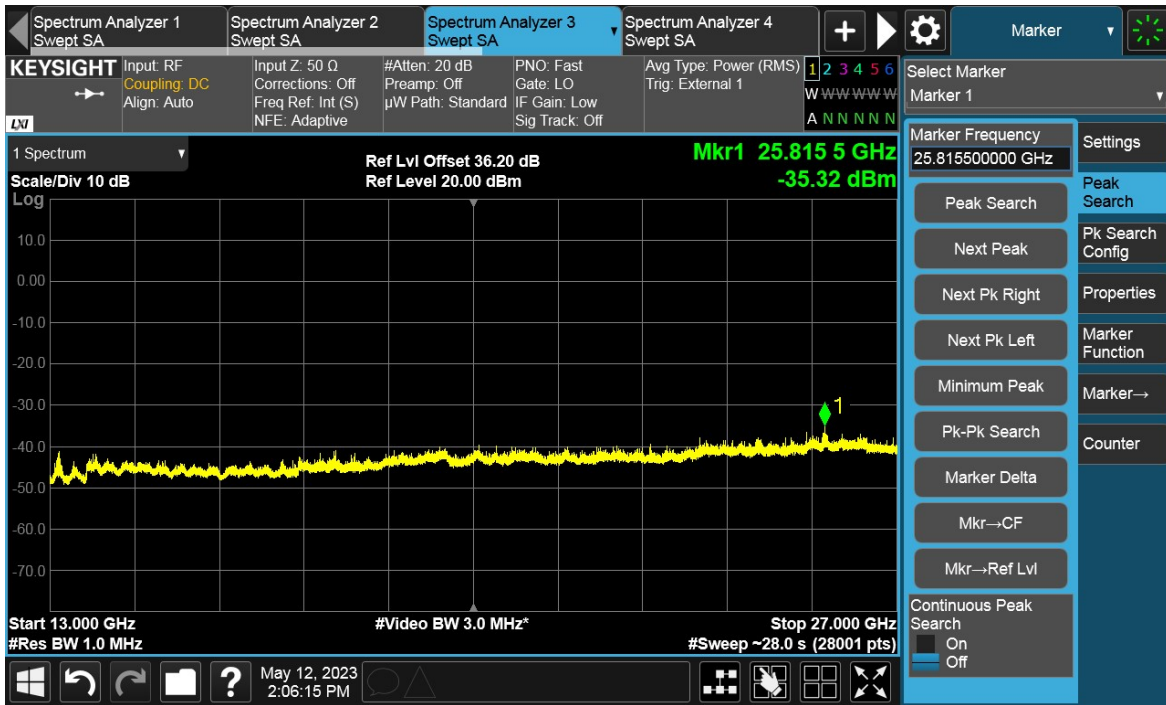

Channel Position T

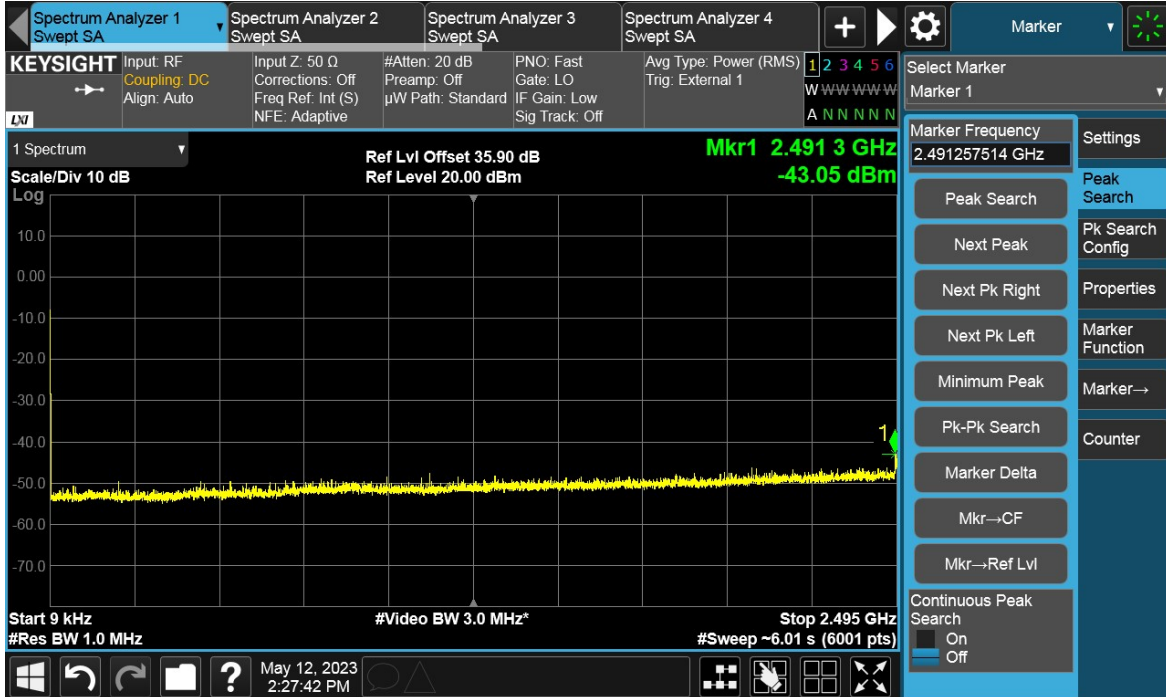

Total Quality. Assured.

TEST REPORT

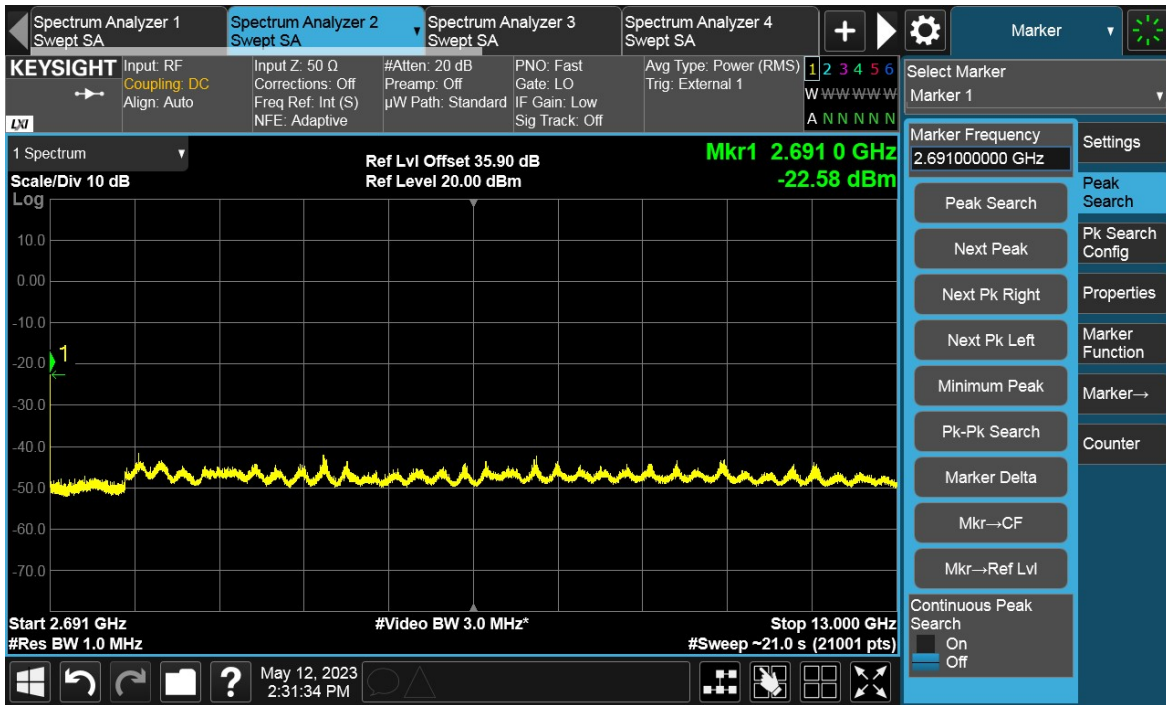

TEST REPORT

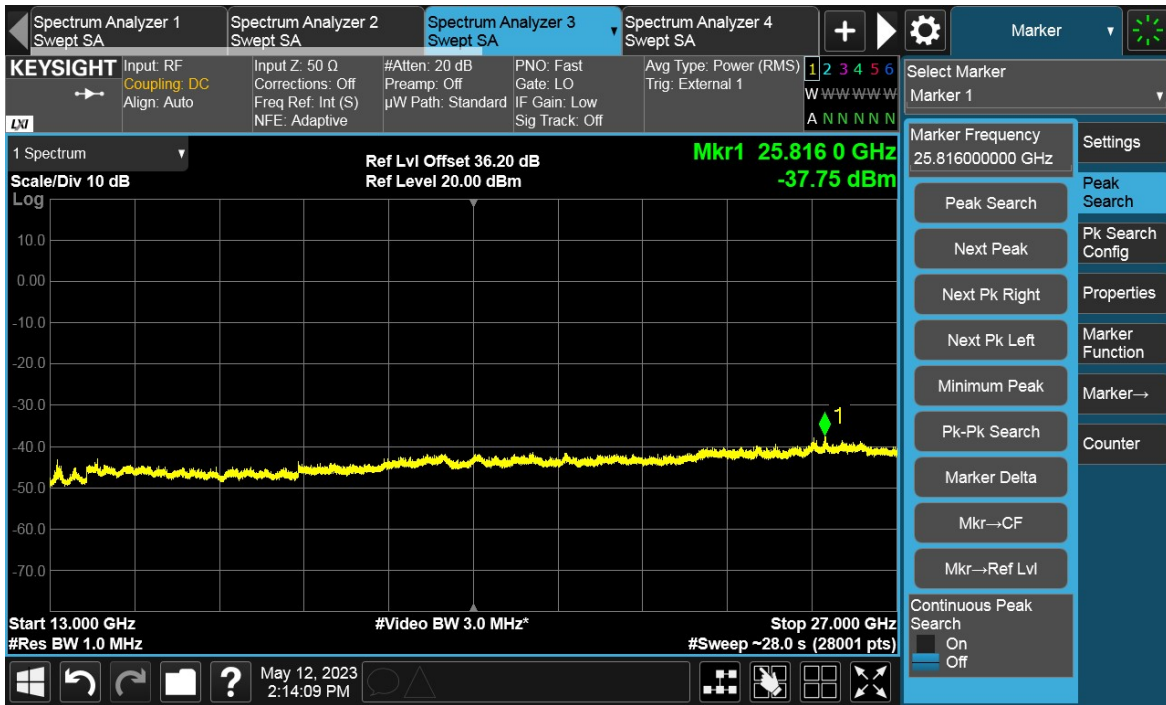
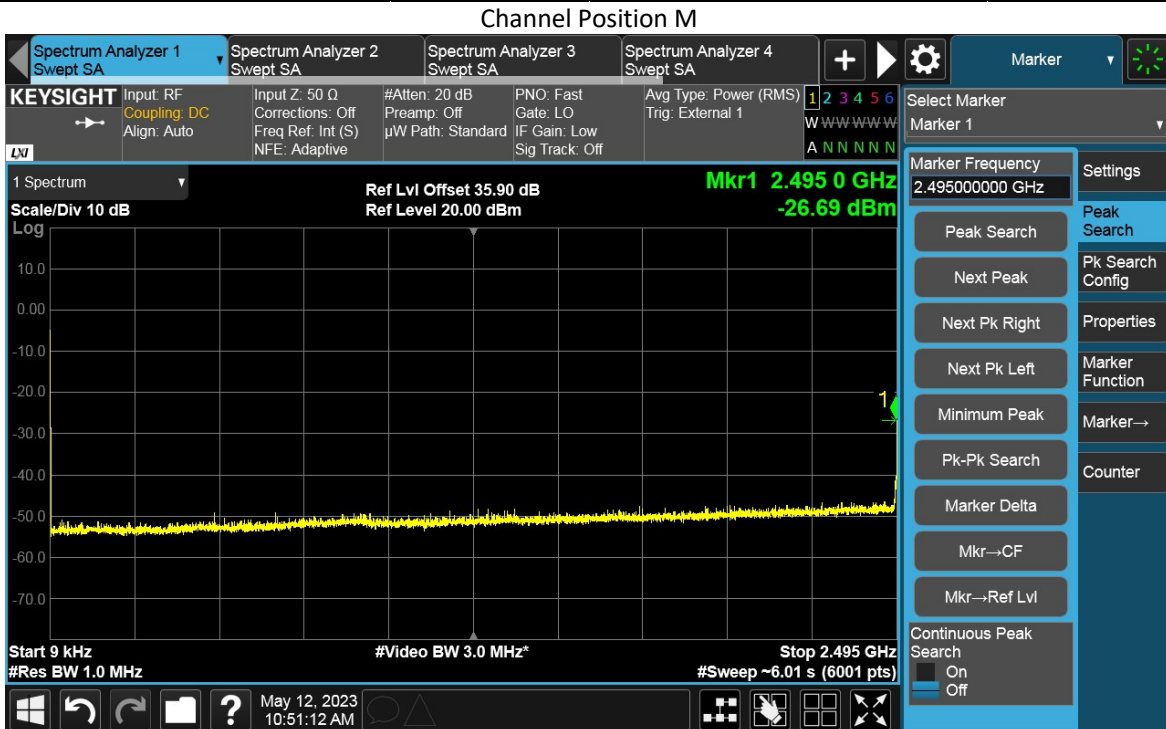

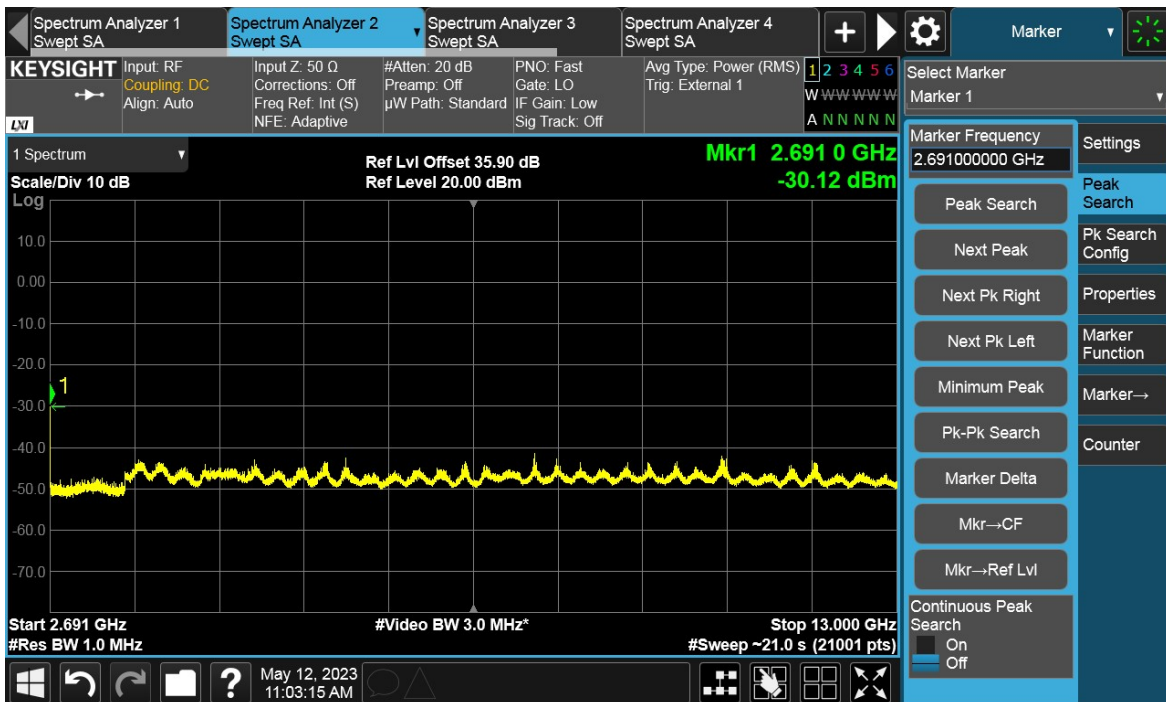
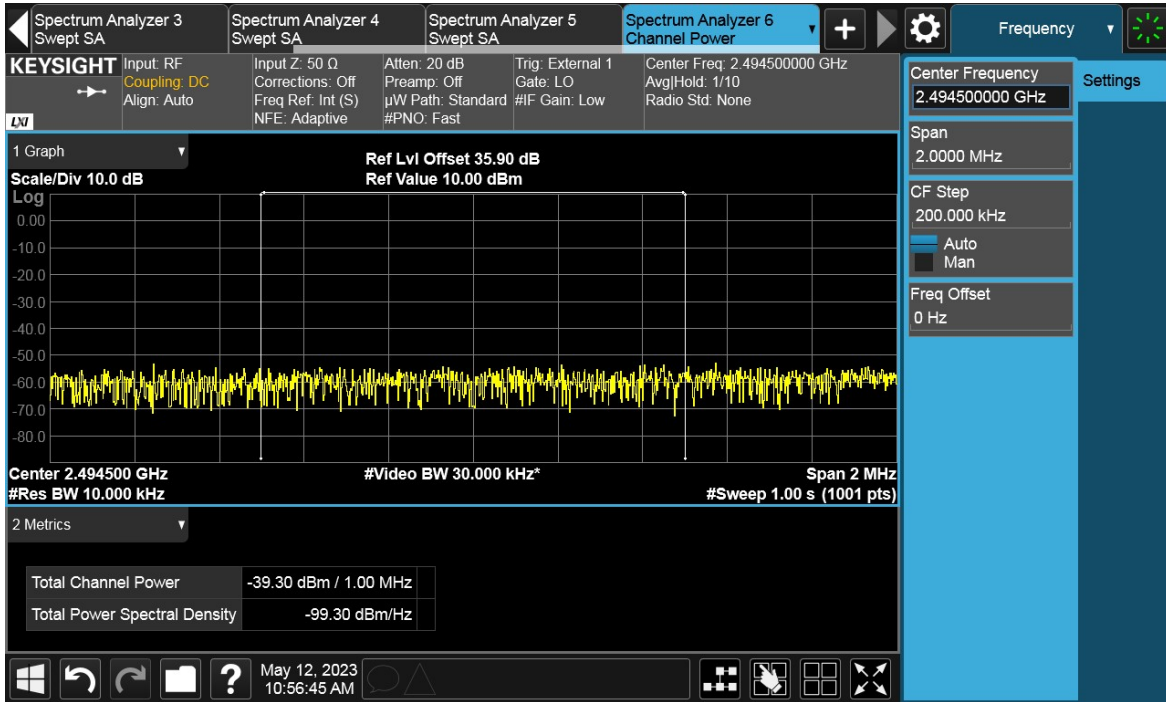

TEST REPORT

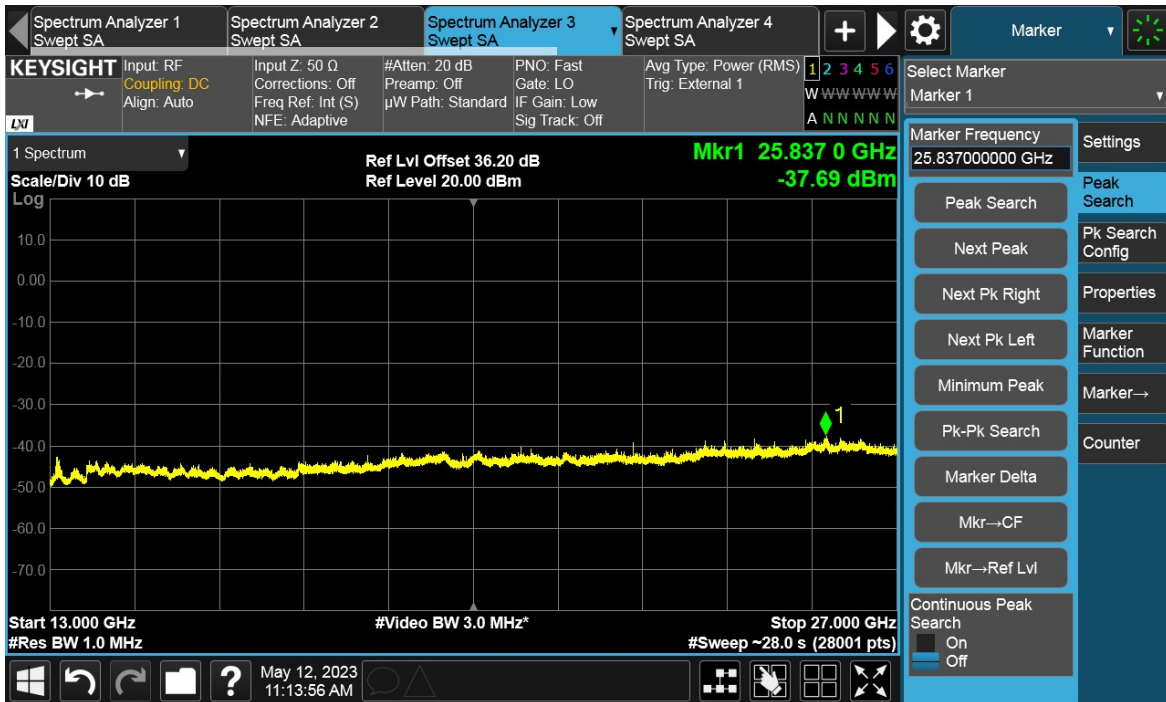
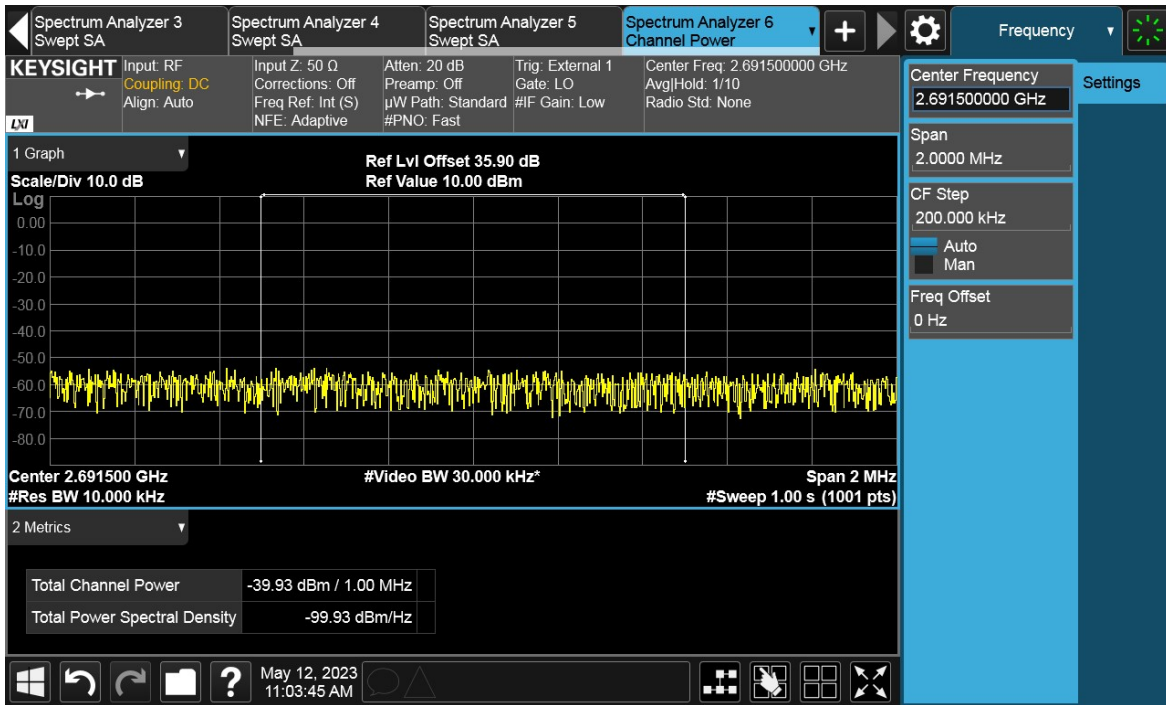

Total Quality. Assured.

TEST REPORT



***** END *****