



Product Service

Choose certainty.
Add value.



Report On

FCC and IC Testing of the
Ericsson KRD 901 060/* (RBS 6402) LTE Band 25 Base Station In
accordance with FCC CFR 47 Part 2 and 24 and Industry Canada
RSS-133 and RSS-GEN

COMMERCIAL-IN-CONFIDENCE

FCC ID: TA8AKRD901060 and TA8AKRD90106083

IC: 287AB-AS901060 and 287AB-AS90106083

PREPARED BY

Maggie Whiting
Key Account Manager

APPROVED BY

Steve Scarfe
Authorised Signatory

DATED

05 July 2016

Document 75930746 Report 04 Issue 2

July 2016

CONTENTS

Section	Page No
1	REPORT INFORMATION 2
1.1	Report Details 3
1.2	Brief Summary of Results 4
1.3	Configuration Description 5
1.4	Declaration of Build Status 6
1.5	Product Information 7
1.6	Test Setup 8
1.7	Test Conditions 9
1.8	Deviation From The Standard 9
1.9	Modification Record 9
1.10	Alternative Test Site 9
2	TEST DETAILS 10
2.1	Maximum Peak Output Power and Peak to Average Ratio - Conducted 11
2.2	Occupied Bandwidth 69
2.3	Band Edge 95
2.4	Transmitter Spurious Emissions 117
2.5	Frequency Stability 160
3	TEST EQUIPMENT USED 162
3.1	Test Equipment Used 163
3.2	Measurement Uncertainty 166
4	ACCREDITATION, DISCLAIMERS AND COPYRIGHT 167
4.1	Accreditation, Disclaimers and Copyright 168
ANNEX A	Module Lists A.2



Product Service

SECTION 1

REPORT INFORMATION

1.1 REPORT DETAILS

Manufacturer	Ericsson
Address	Box 3 Stockholm 17281 Sweden
Product Name	RBS 6402
Product Number	KRD 901 060/*
Brief Description	RBS 6402 KRD 901 060/* Band 2, Band 25, Band 4 and Band 7 LTE is a small RBS that is part of the Ericsson heterogeneous network small cell toolbox. It can be mounted on walls and ceilings. RBS 6402 is powered by AC/DC adapter or Power Over Ethernet (PoE). The TA8AKRD90106083/ 287AB-AS90106083 is a variant of the TA8AKRD901060/ 287AB-AS901060 and does not require testing because it has the same hardware but with and LTE-U module which is in standby/silent mode (not configurable).
Serial Number(s)	C829930748
Software Version	RASW_20150612_1 (with single carrier) and RASW_20150702 (with dual carriers)
Hardware Version	R3A
Test Specification/Issue/Date	FCC CFR 47 Part 2: 2014 FCC CFR 47 Part 24: 2014 Industry Canada RSS-133: Issue 6: 2013 Industry Canada RSS-GEN: Issue 4: 2014
Start of Test	22 June 2015
Finish of Test	10 July 2015
Name of Engineer(s)	N Forsyth
Related Document(s)	KDB 971168 D01

ENGINEERING STATEMENT

The measurements shown in this report were made in accordance with the procedures described on test pages. All reported testing was carried out on a sample equipment to demonstrate limited compliance with FCC CFR Part 2, FCC CFR Part 24, Industry Canada RSS-133 and Industry Canada RSS-GEN. The sample tested was found to comply with the requirements defined in the applied rules.

Test Engineer(s);

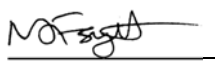
Nic Forsyth

Mohamed Toubella

1.2 BRIEF SUMMARY OF RESULTS

A brief summary of results for each configuration, in accordance with FCC CFR 47 Part 2, 24 and Industry Canada RSS-133 and RSS-GEN is shown below.

Section	Spec Clause				Test Description	Result
	Part 2	Part 24	RSS 133	RSS GEN		
2.1	2.1046	24.232 (a)	6.4	-	Maximum Peak Output Power – Conducted	Pass
2.2	2.1049	24.238 (b)	-	6.6	Occupied Bandwidth	Pass
2.3	2.1051	24.238 (b)	6.5	-	Spurious Emissions at Band Edge	Pass
2.4	2.1051	24.238 (a)	6.5	-	Conducted Spurious Emissions	Pass
2.5	2.1055	24.235	6.3	-	Frequency Stability Under Temperature Variations	Pass
2.6	2.1055	24.235	6.3	-	Frequency Stability Under Voltage Variations	Pass
-	2.1053	24.238	6.1	-	Transmitter Radiated Emissions	Pass*

* See test report from Intertek, Sweden Report Reference Number 1512825STO-002, Ed. 1

**This report has been up issued to Issue 2 and should be read in place of Issue 1.
 This report has been up issued to Issue 2 to add the non tested variant
 FCC ID: TA8AKRD90106083 and IC: 287AB-AS90106083**

1.3 CONFIGURATION DESCRIPTION

The RBS 6402 supports LTE single and dual carrier and is capable of 4 port, single carrier and 2 port, dual carrier MIMO operation.

In addition, the EUT supports Test Models E-TM1.1, E-TM3.2 and E-TM3.1 as defined in 3GPP TS 36.141. Test Model E-TM1.1 was used to represent QPSK modulation only, Test Model E-TM3.2 was used to represent 16QAM modulation, and Test Model E-TM3.1 was used to represent 64QAM modulation.

All RF ports were tested for RF Carrier Power and results recorded using the Measure and Sum approach to account for MIMO operation. All testing was performed with the EUT transmitting at maximum RF power unless otherwise stated.

Single Carrier Channel Configurations

Configuration	RAT	Number of Carriers	Bandwidth	Carrier Frequency Configuration (MHz)		
				Bottom	Middle	Top
A	LTE	1	5 MHz	1932.5	1960.0	1992.5
			10 MHz	1935.0	1960.0	1990.0
			15 MHz	1937.5	1960.0	1987.5
			20 MHz	1940.0	1960.0	1985.0

Dual Carrier Channel Configurations

Configuration	RAT	Number of Carriers	Bandwidth	Carrier Frequency Configuration (MHz)		
				Bottom	Middle	Top
B	LTE	2	5 MHz	1932.5 + 1937.5	1957.5 + 1962.5	1987.5 + 1992.5
			10 MHz	1935.0 + 1945.0	1955.0 + 1965.0	1980.0 + 1990.0
			15 MHz	1937.5 + 1952.5	1952.5 + 1967.5	1972.5 + 1987.5
			20 MHz	1940.0 + 1960.0	1950.0 + 1970.0	1965.0 + 1985.0

Dual Carrier Channel Configurations – Spurious Emissions at Band Edge

Configuration	RAT	Number of Carriers	Bandwidth	Carrier Frequency Configuration (MHz)		
				Bottom	Middle	Top
B	LTE	2	5 MHz	1932.5 + 1967.5	1942.5 + 1977.5	1957.5 + 1992.5
			10 MHz	1935.0 + 1970.0	1945.0 + 1975.0	1955.0 + 1990.0
			15 MHz	1937.5 + 1972.5	1947.5 + 1972.5	1952.5 + 1987.5
			20 MHz	1940.0 + 1975.0	1950.0 + 1970.0	1950.0 + 1985.0

1.4 DECLARATION OF BUILD STATUS

Manufacturer	Ericsson AB		
Model number(s)	RBS 6402		
Identification/Type(s)	KRD 901 060/		
Cabinet type(s)	Indoor		
Cabinet identification(s)	N/A		
Number of sectors	1		
Number of carriers	1		
Base station class	Local Area		
Maximum rated output power(s)	4 x 250mW		
Duplex Mode	FDD		
Frequency Band	1900 MHz Band 2		
	1900 MHz Band 25		
	2100 MHz Band 4		
	2600 MHz Band 7		
Modulation type(s)	QPSK		
	16 QAM		
	64 QAM		
Channel Bandwidth(s)	LTE: 5MHz, 10MHz, 15MHz, 20MHz		
Transmit diversity	Yes ¹		
Receive diversity	Yes ²		
MIMO	LTE 4x4 MIMO		
ITU designation or class of emission	LTE: 4M48G7D, 8M93G7D, 13M4G7D, 17M9G7D, 4M48W7D, 8M93W7D, 13M4W7D, 17M9W7D		
Environment temperature range(s)	Minimum	Maximum	
	0 C	+50 C (+40 C without fan)	
AC Power source	Yes		
	Voltage Range(s)		
	Minimum VAC	Nominal VAC	Maximum VAC
	100	230	240
DC Power source	Yes (PoE)		
	Voltage Range(s)		
	Minimum VDC	Nominal VDC	Maximum VDC
	37	48	58
Options	Type	Model	

(The * in the model number KRD901 060/* denotes 1, 2, 4, 6, 7, 8, 9, 83 depending on different H00 and S00 configurations)

¹ Each transmitter path is declared to be equivalent.

² Each receiver path is declared to be equivalent.

I hereby declare that I am entitled to sign on behalf of the manufacturer and that the information supplied is correct and complete.

Signature:

Name : Mika Savilakso
 Position held : Senior Developer, Regulatory Approvals
 Date :30.06.2016

1.5 PRODUCT INFORMATION

1.5.1 Technical Description

The Equipment Under Test (EUT) is shown in the photograph below. A full technical description can be found in the Manufacturer's documentation.



Equipment Under Test

1.6 TEST SETUP

Test Setup, Conducted Measurement:

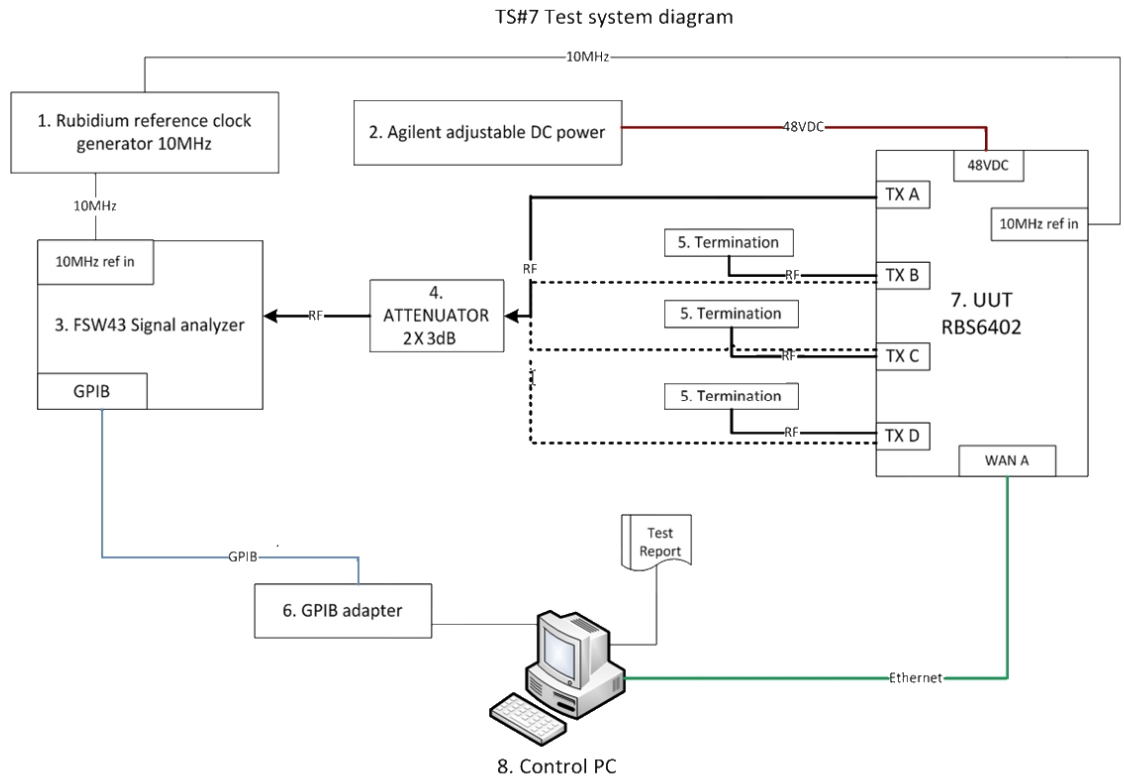

See Section 3 for a list of the test equipment used in the test.

Test Setup, Radiated Measurement:

See test report from Intertek, Sweden Report Reference Number 1512825STO-002, Ed. 1

1.7 TEST CONDITIONS

For all tests the EUT was set up in accordance with the relevant test standard and to represent typical operating conditions. Tests were applied with the EUT situated in a shielded enclosure, test laboratories or a chamber as appropriate.

The EUT was powered from a -48V DC supply.

1.8 DEVIATION FROM THE STANDARD

No deviations from the applicable test standards or test plan were made during testing.

1.9 MODIFICATION RECORD

No modifications were made to the EUT during testing.

1.10 ALTERNATIVE TEST SITE

Under our group UKAS Accreditation, TÜV SÜD Product Service conducted the tests at Ericsson in Oulu, Finland.



Product Service

SECTION 2

TEST DETAILS

2.1 MAXIMUM PEAK OUTPUT POWER AND PEAK TO AVERAGE RATIO - CONDUCTED

2.1.1 Specification Reference

FCC CFR 47 Part 2, Clause 2.1046
 FCC CFR 47 Part 24, Clause 24.232(a)
 Industry Canada RSS-133, Clause 6.4

2.1.2 Date of Test and Modification State

22 June, 02, 06 and 09 July 2015 - Modification State 0

2.1.3 Test Equipment Used

The major items of test equipment used for the above tests are identified in Section 3.1.

2.1.4 Environmental Conditions

Ambient Temperature 22.5 - 24°C
 Relative Humidity 34.1 - 46.8%

2.1.5 Test Method

All measurements were made in accordance with FCC KDB 971168 D01 and summed in accordance with FCC KDB 662911 D01.

2.1.6 Test Results

Configuration A

Maximum Output Power 24 dBm

Modulation	Carrier Bandwidth (MHz)	Antenna	Output Power / Peak to Average Ratio (PAR)				
			Channel Position B				
			PAR (dB)	Average Power (dBm)	Average EIRP (dBm)	Average EIRP (dBm/MHz)	Average EIRP (W/MHz)
QPSK	5.0 MHz	A	6.98	23.75	28.75	21.76	0.15
		B	6.93	24.18	29.18	22.19	0.17
		C	6.94	23.90	28.90	21.91	0.16
		D	6.97	24.43	29.43	22.44	0.18
Total			-	30.09	35.09	28.10	0.65
QPSK	20.0 MHz	A	7.39	23.40	28.40	15.39	0.03
		B	7.29	24.36	29.36	16.35	0.04
		C	7.28	23.80	28.80	15.79	0.04
		D	7.45	24.39	29.39	16.38	0.04
Total			-	30.03	35.03	28.04	0.64

Modulation QPSK - Bandwidth 5.0 MHz - Antenna A - Channel Position B



Date: 22 JUN 2015 15:02:39

Modulation QPSK - Bandwidth 5.0 MHz - Antenna B - Channel Position B



Date: 22 JUN 2015 15:15:27

Modulation QPSK - Bandwidth 5.0 MHz - Antenna C - Channel Position B



Date: 22 JUN 2015 16:04:33

Modulation QPSK - Bandwidth 5.0 MHz - Antenna D - Channel Position B



Date: 22 JUN 2015 16:17:22

Modulation QPSK - Bandwidth 20.0 MHz - Antenna A - Channel Position B



Date: 22 JUN 2015 15:31:05

Modulation QPSK - Bandwidth 20.0 MHz - Antenna B - Channel Position B



Date: 22 JUN 2015 15:43:37

Modulation QPSK - Bandwidth 20.0 MHz - Antenna C - Channel Position B



Date: 22 JUN 2015 16:33:02

Modulation QPSK - Bandwidth 20.0 MHz - Antenna D - Channel Position B



Date: 22 JUN 2015 16:45:32

Configuration A

Maximum Output Power 24 dBm

Modulation	Carrier Bandwidth (MHz)	Antenna	Output Power / Peak to Average Ratio (PAR)				
			Channel Position M				
			PAR (dB)	Average Power (dBm)	Average EIRP (dBm)	Average EIRP (dBm/MHz)	Average EIRP (W/MHz)
QPSK	5.0 MHz	A	6.81	23.49	28.49	21.50	0.14
		B	6.84	24.09	29.09	22.10	0.16
		C	6.81	23.87	28.87	21.88	0.15
		D	6.84	24.47	29.47	22.48	0.18
Total			-	30.02	35.02	28.03	0.63
QPSK	10.0 MHz	A	6.85	23.28	28.28	18.28	0.07
		B	6.88	24.05	29.05	19.05	0.08
		C	6.84	23.95	28.95	18.95	0.08
		D	6.85	24.58	29.58	19.58	0.09
Total			-	30.01	35.01	28.02	0.63
QPSK	15.0 MHz	A	6.86	23.45	28.45	16.69	0.05
		B	6.89	24.17	29.17	17.41	0.06
		C	6.87	23.91	28.91	17.15	0.05
		D	6.89	24.58	29.58	17.82	0.06
Total			-	30.07	35.07	28.08	0.64
QPSK	20.0 MHz	A	6.94	23.51	28.51	15.50	0.04
		B	6.94	24.14	29.14	16.13	0.04
		C	6.92	23.99	28.99	15.98	0.04
		D	6.96	24.63	29.63	16.62	0.05
Total			-	30.11	35.11	28.12	0.65

Modulation QPSK - Bandwidth 5.0 MHz - Antenna A - Channel Position M

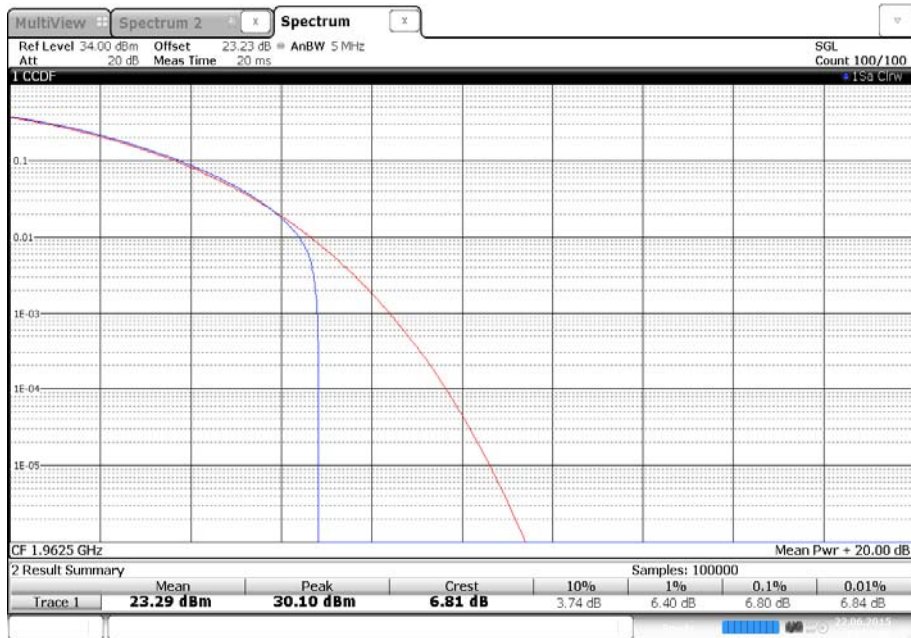

Date: 22 JUN 2015 15:03:43

Modulation QPSK - Bandwidth 5.0 MHz - Antenna B - Channel Position M



Date: 22 JUN 2015 15:16:32

Modulation QPSK - Bandwidth 5.0 MHz - Antenna C - Channel Position M

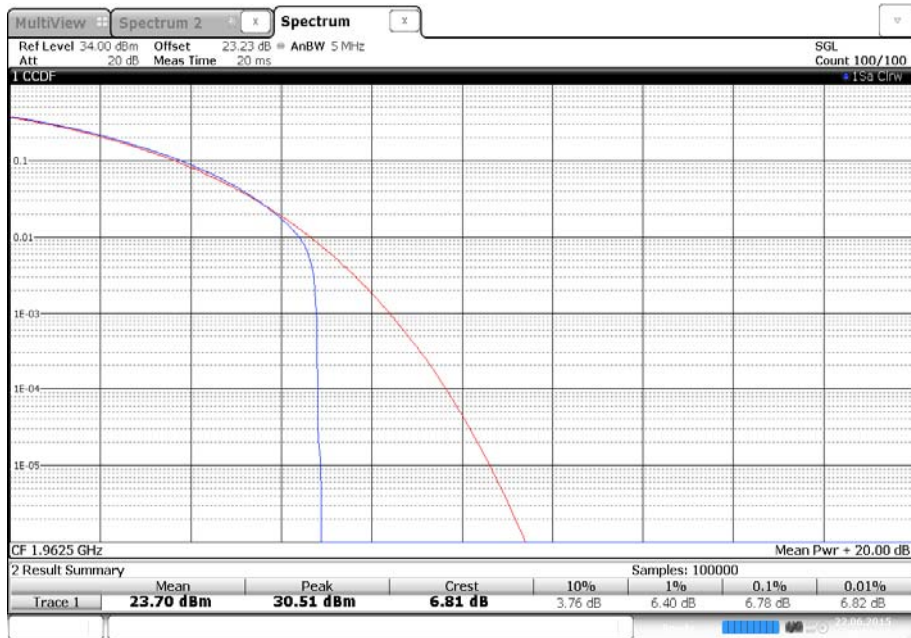

Date: 22 JUN 2015 16:05:37

Modulation QPSK - Bandwidth 5.0 MHz - Antenna D - Channel Position M



Date: 22 JUN 2015 16:18:26

Modulation QPSK - Bandwidth 10.0 MHz - Antenna A - Channel Position M



Date: 23 JUN 2015 09:05:23

Modulation QPSK - Bandwidth 10.0 MHz - Antenna B - Channel Position M



Date: 23 JUN 2015 09:09:36

Modulation QPSK - Bandwidth 10.0 MHz - Antenna C - Channel Position M



Date: 23 JUN 2015 08:35:58

Modulation QPSK - Bandwidth 10.0 MHz - Antenna D - Channel Position M



Date: 23 JUN 2015 08:40:11

Modulation QPSK - Bandwidth 15.0 MHz - Antenna A - Channel Position M



Date: 23 JUN 2015 09:16:43

Modulation QPSK - Bandwidth 15.0 MHz - Antenna B - Channel Position M



Date: 23 JUN 2015 09:20:53

Modulation QPSK - Bandwidth 15.0 MHz - Antenna C - Channel Position M



Date: 23 JUN 2015 08:47:18

Modulation QPSK - Bandwidth 15.0 MHz - Antenna D - Channel Position M



Date: 23 JUN 2015 08:51:28

Modulation QPSK - Bandwidth 20.0 MHz - Antenna A - Channel Position M



Date: 22 JUN 2015 15:32:08

Modulation QPSK - Bandwidth 20.0 MHz - Antenna B - Channel Position M



Date: 22 JUN 2015 15:44:39

Modulation QPSK - Bandwidth 20.0 MHz - Antenna C - Channel Position M



Date: 22 JUN 2015 16:34:04

Modulation QPSK - Bandwidth 20.0 MHz - Antenna D - Channel Position M



Date: 22 JUN 2015 16:46:34

Configuration A

Maximum Output Power 24 dBm

Modulation	Carrier Bandwidth (MHz)	Antenna	Output Power / Peak to Average Ratio (PAR)				
			Channel Position T				
			PAR (dB)	Average Power (dBm)	Average EIRP (dBm)	Average EIRP (dBm/MHz)	Average EIRP (W/MHz)
QPSK	5.0 MHz	A	6.86	23.19	28.19	21.20	0.13
		B	6.85	24.14	29.14	22.15	0.16
		C	6.88	23.67	28.67	21.68	0.15
		D	6.84	24.60	29.60	22.61	0.18
Total			-	29.95	34.95	27.96	0.63
QPSK	20.0 MHz	A	7.23	23.36	28.36	15.35	0.03
		B	7.34	23.93	28.93	15.92	0.04
		C	7.32	23.78	28.78	15.77	0.04
		D	7.28	24.51	29.51	16.50	0.04
Total			-	29.94	34.94	27.95	0.62

Modulation QPSK - Bandwidth 5.0 MHz - Antenna A - Channel Position T

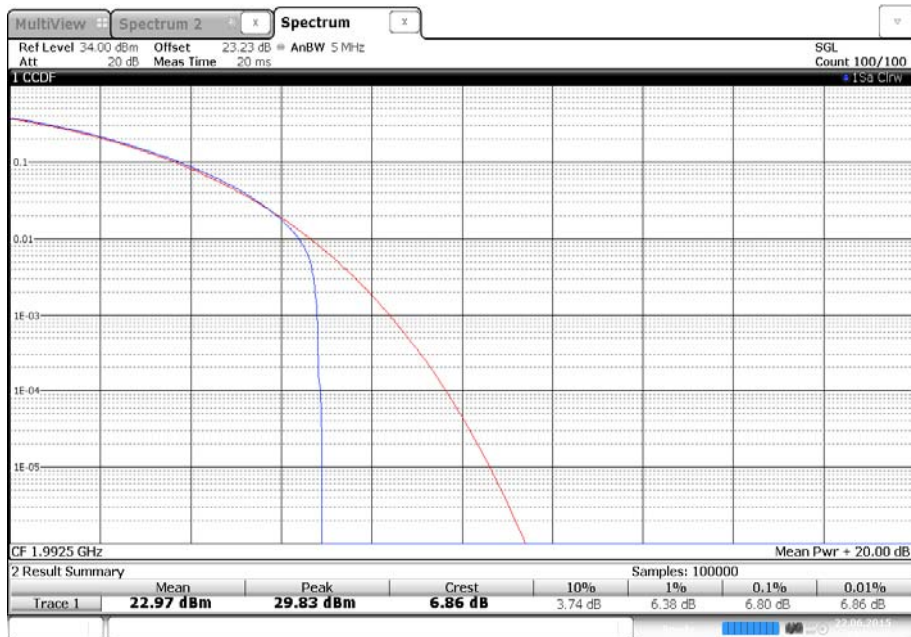

Date: 22 JUN 2015 15:04:47

Modulation QPSK - Bandwidth 5.0 MHz - Antenna B - Channel Position T



Date: 22 JUN 2015 15:17:36

Modulation QPSK - Bandwidth 5.0 MHz - Antenna C - Channel Position T



Date: 22 JUN 2015 16:08:41

Modulation QPSK - Bandwidth 5.0 MHz - Antenna D - Channel Position T



Date: 22 JUN 2015 16:19:30

Modulation QPSK - Bandwidth 20.0 MHz - Antenna A - Channel Position T



Date: 22 JUN 2015 15:33:10

Modulation QPSK - Bandwidth 20.0 MHz - Antenna B - Channel Position T



Date: 22 JUN 2015 15:45:42

Modulation QPSK - Bandwidth 20.0 MHz - Antenna C - Channel Position T



Date: 22 JUN 2015 16:35:07

Modulation QPSK - Bandwidth 20.0 MHz - Antenna D - Channel Position T



Date: 22 JUN 2015 16:47:37

Configuration A

Maximum Output Power 24 dBm

Modulation	Carrier Bandwidth (MHz)	Antenna	Output Power / Peak to Average Ratio (PAR)				
			Channel Position B				
			PAR (dB)	Average Power (dBm)	Average EIRP (dBm)	Average EIRP (dBm/MHz)	Average EIRP (W/MHz)
16QAM	5.0 MHz	A	6.92	24.10	29.10	22.11	0.16
		B	6.92	24.17	29.17	22.18	0.17
		C	6.92	23.93	28.93	21.94	0.16
		D	6.90	24.49	29.49	22.50	0.18
Total			-	30.20	35.20	28.21	0.66
16QAM	20.0 MHz	A	7.44	23.73	28.73	15.72	0.04
		B	7.35	24.29	29.29	16.28	0.04
		C	7.30	23.87	28.87	15.86	0.04
		D	7.41	24.51	29.51	16.50	0.04
Total			-	30.13	35.13	28.14	0.65

Modulation 16QAM - Bandwidth 5.0 MHz - Antenna A - Channel Position B

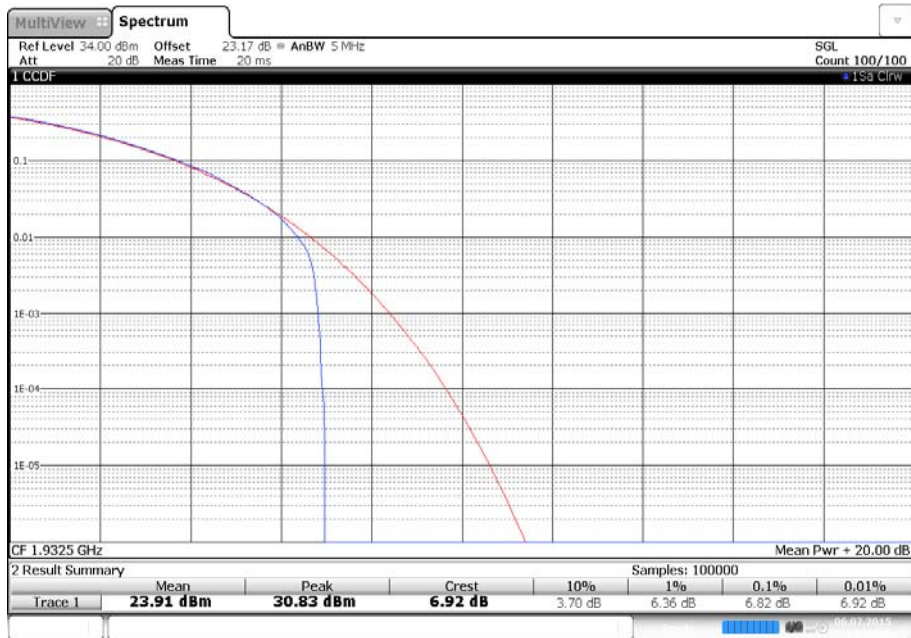

Date: 6 JUL 2015 14:59:07

Modulation 16QAM - Bandwidth 5.0 MHz - Antenna B - Channel Position B

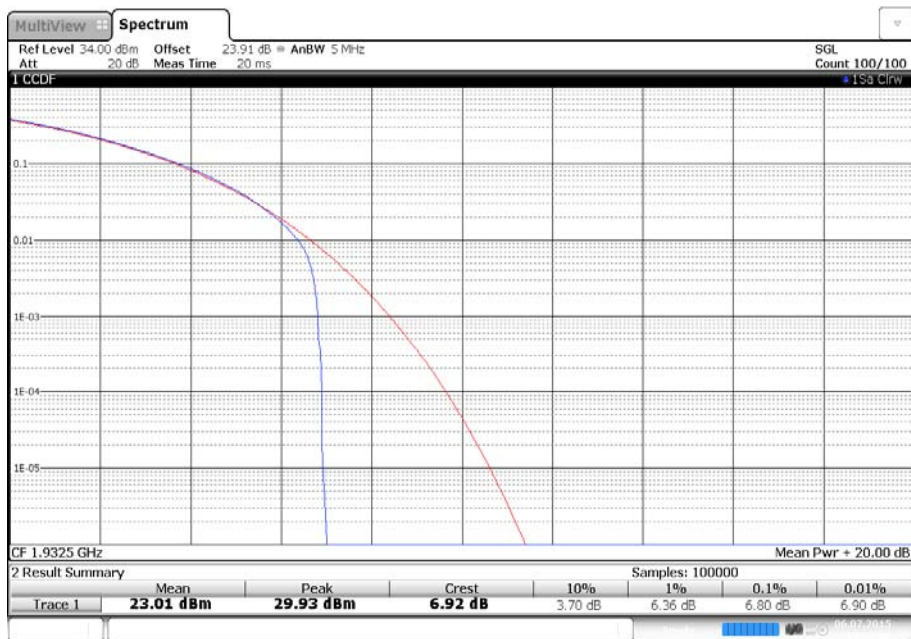

Date: 6 JUL 2015 15:12:06

Modulation 16QAM - Bandwidth 5.0 MHz - Antenna C - Channel Position B



Date: 6 JUL 2015 22:08:44

Modulation 16QAM - Bandwidth 5.0 MHz - Antenna D - Channel Position B

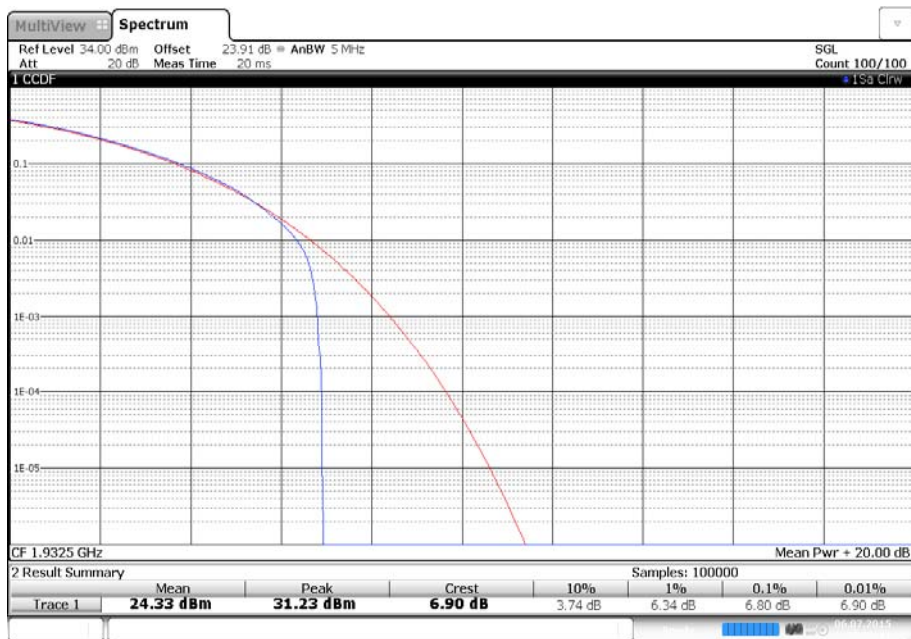

Date: 6 JUL 2015 22:21:41

Modulation 16QAM - Bandwidth 20.0 MHz - Antenna A - Channel Position B

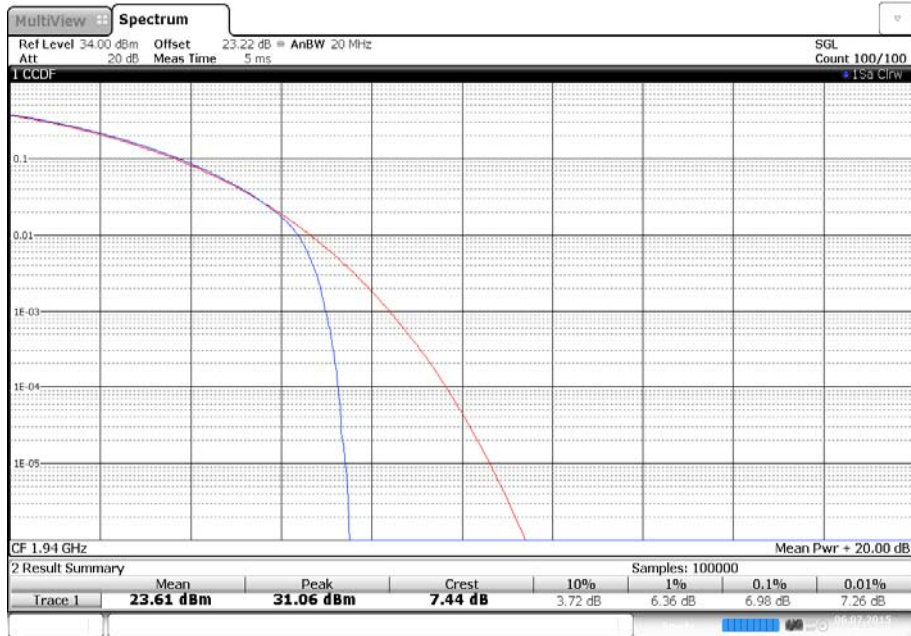

Date: 6 JUL 2015 17:49:39

Modulation 16QAM - Bandwidth 20.0 MHz - Antenna B - Channel Position B

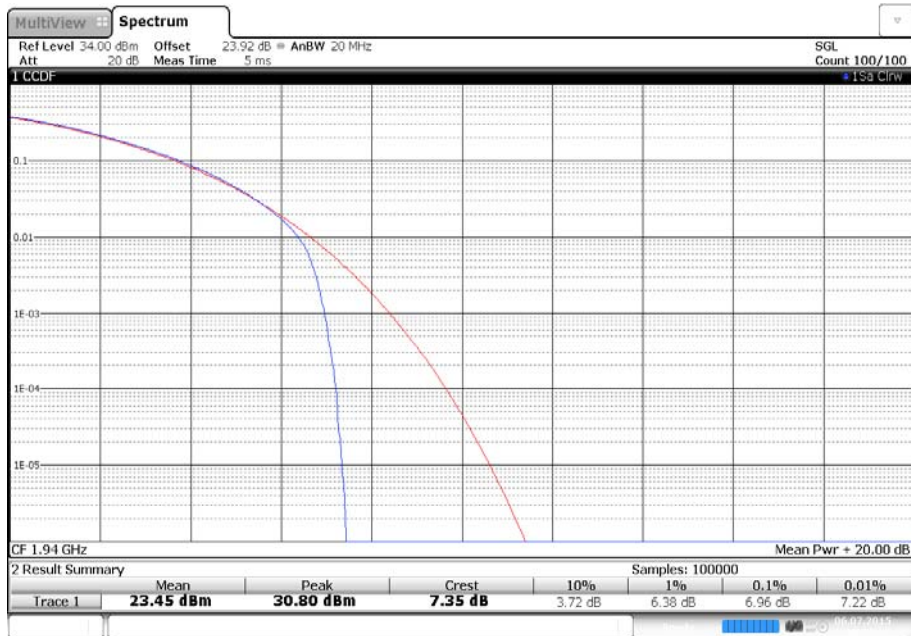

Date: 6 JUL 2015 18:02:22

Modulation 16QAM - Bandwidth 20.0 MHz - Antenna C - Channel Position B

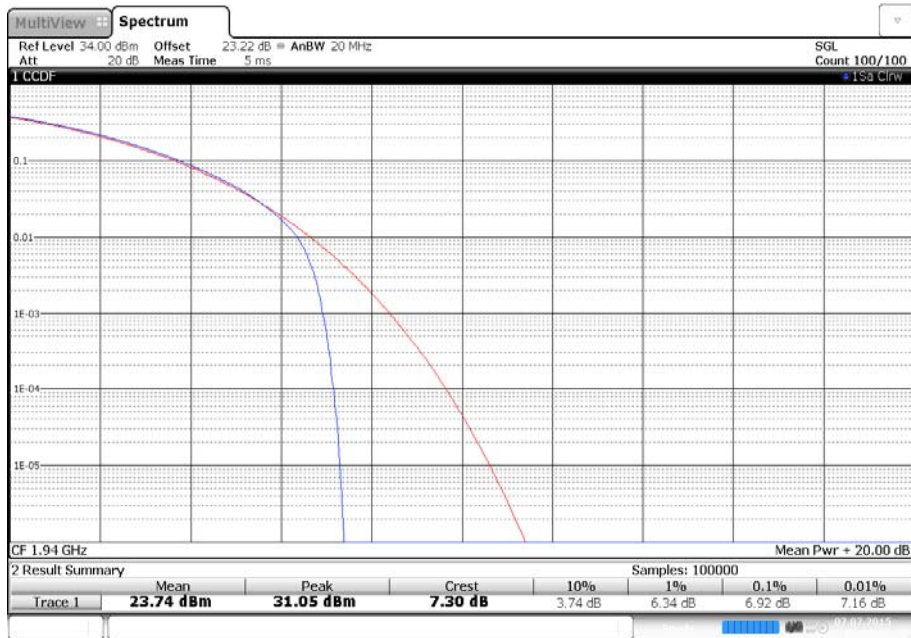

Date: 7.JUL.2015 01:00:28

Modulation 16QAM - Bandwidth 20.0 MHz - Antenna D - Channel Position B



Date: 7.JUL.2015 01:13:08

Configuration A

Maximum Output Power 24 dBm

Modulation	Carrier Bandwidth (MHz)	Antenna	Output Power / Peak to Average Ratio (PAR)				
			Channel Position M				
			PAR (dB)	Average Power (dBm)	Average EIRP (dBm)	Average EIRP (dBm/MHz)	Average EIRP (W/MHz)
16QAM	5.0 MHz	A	6.83	23.66	28.66	21.67	0.15
		B	6.82	24.19	29.19	22.20	0.17
		C	6.90	23.91	28.91	21.92	0.16
		D	6.83	24.61	29.61	22.62	0.18
Total			-	30.13	35.13	28.14	0.65
16QAM	10.0 MHz	A	6.92	23.73	28.73	18.73	0.07
		B	6.88	24.32	29.32	19.32	0.09
		C	6.88	23.91	28.91	18.91	0.08
		D	6.89	24.74	29.74	19.74	0.09
Total			-	30.21	35.21	28.22	0.66
16QAM	15.0 MHz	A	6.89	23.72	28.72	16.96	0.05
		B	6.89	24.23	29.23	17.47	0.06
		C	6.87	23.98	28.98	17.22	0.05
		D	6.89	24.82	29.82	18.06	0.06
Total			-	30.23	35.23	28.24	0.67
16QAM	20.0 MHz	A	6.94	23.71	28.71	15.70	0.04
		B	6.99	24.30	29.30	16.29	0.04
		C	6.89	24.03	29.03	16.02	0.04
		D	6.91	24.74	29.74	16.73	0.05
Total			-	30.23	35.23	28.24	0.67

Modulation 16QAM - Bandwidth 5.0 MHz - Antenna A - Channel Position M

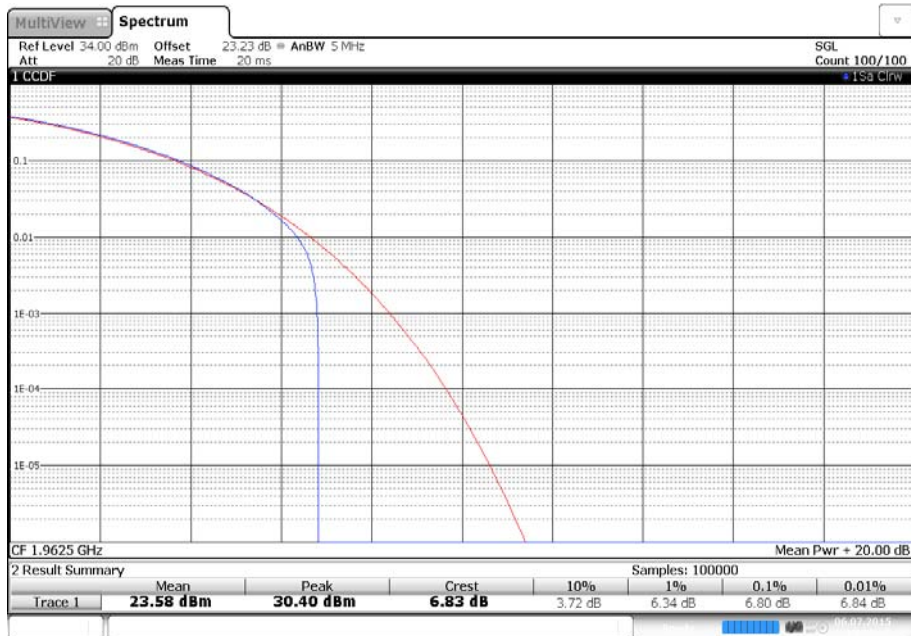

Date: 6 JUL 2015 15:00:12

Modulation 16QAM - Bandwidth 5.0 MHz - Antenna B - Channel Position M

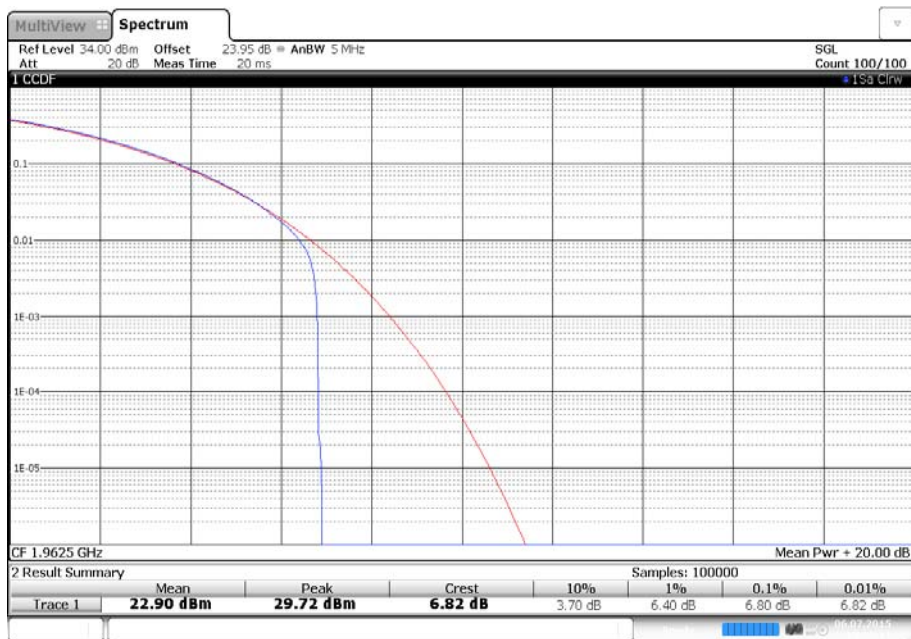

Date: 6 JUL 2015 15:13:10

Modulation 16QAM - Bandwidth 5.0 MHz - Antenna C - Channel Position M

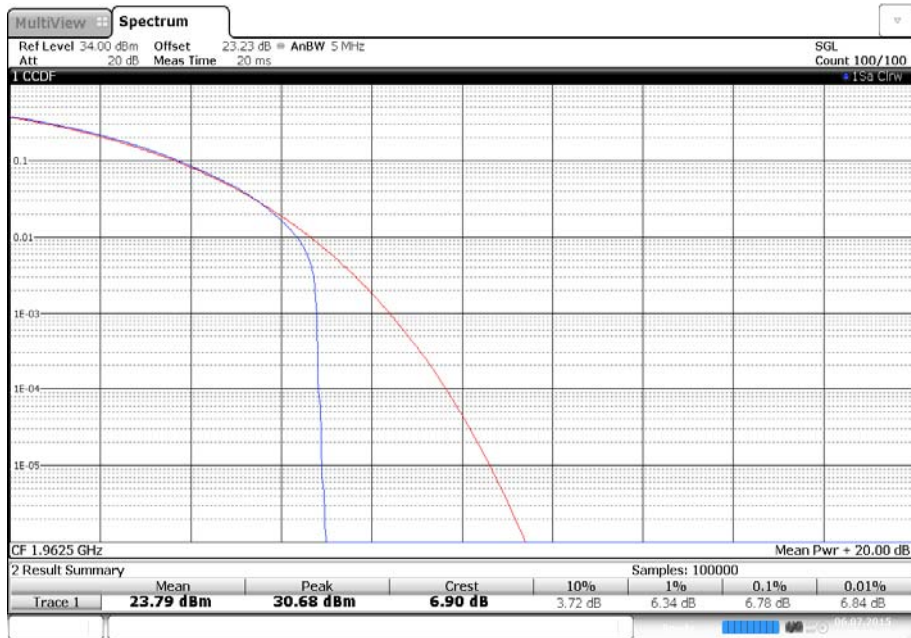

Date: 6 JUL 2015 22:09:49

Modulation 16QAM - Bandwidth 5.0 MHz - Antenna D - Channel Position M

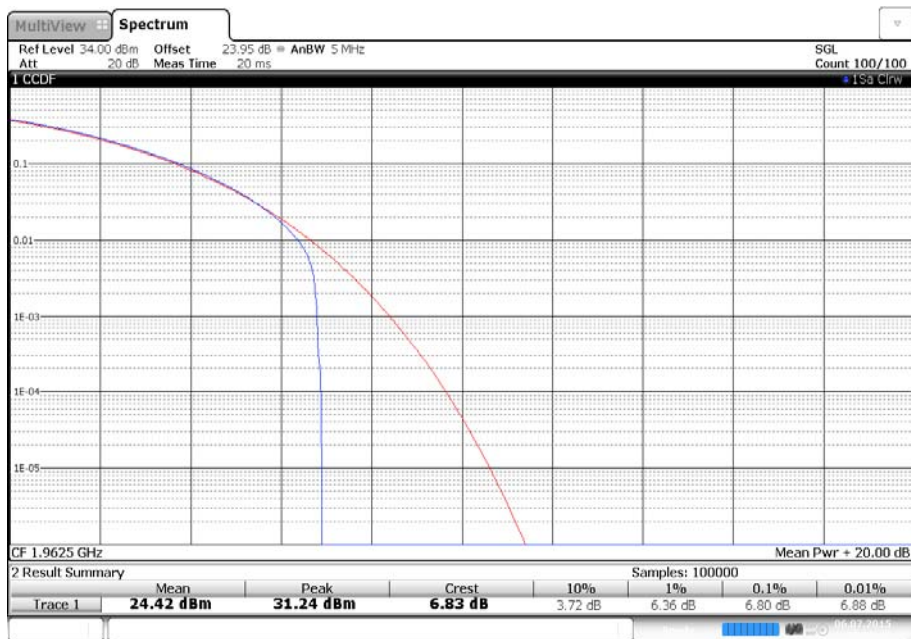

Date: 6 JUL 2015 22:22:47

Modulation 16QAM - Bandwidth 10.0 MHz - Antenna A - Channel Position M



Date: 6 JUL 2015 15:56:29

Modulation 16QAM - Bandwidth 10.0 MHz - Antenna B - Channel Position M



Date: 6 JUL 2015 16:09:14

Modulation 16QAM - Bandwidth 10.0 MHz - Antenna C - Channel Position M

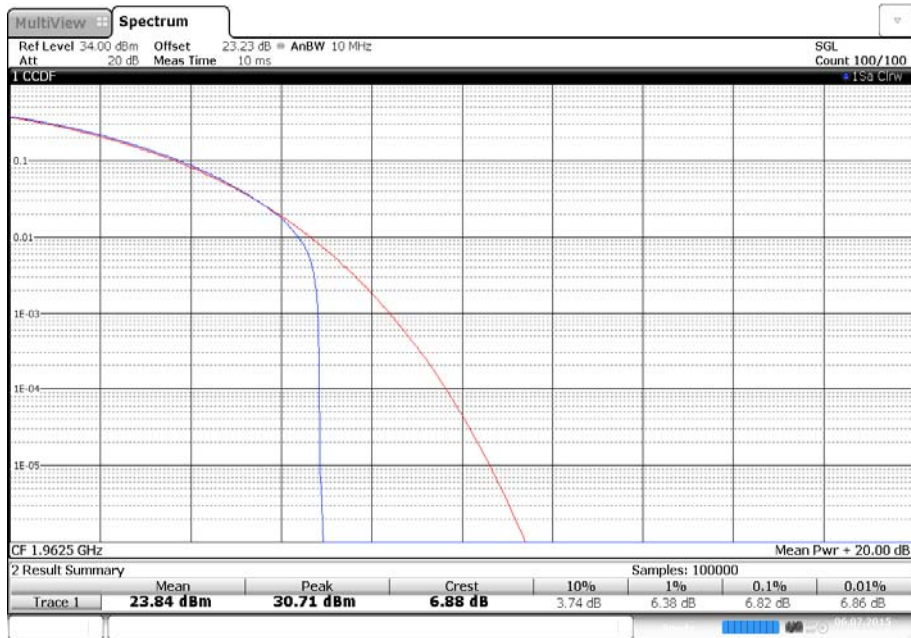

Date: 6 JUL 2015 23:07:13

Modulation 16QAM - Bandwidth 10.0 MHz - Antenna D - Channel Position M

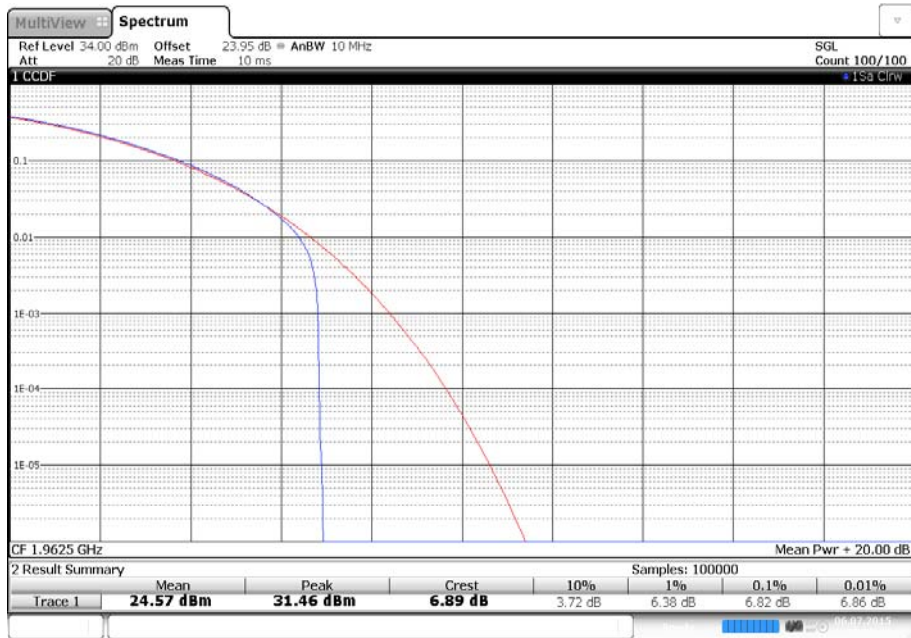

Date: 6 JUL 2015 23:20:59

Modulation 16QAM - Bandwidth 15.0 MHz - Antenna A - Channel Position M



Date: 6 JUL 2015 16:55:14

Modulation 16QAM - Bandwidth 15.0 MHz - Antenna B - Channel Position M



Date: 6 JUL 2015 17:07:52

Modulation 16QAM - Bandwidth 15.0 MHz - Antenna C - Channel Position M

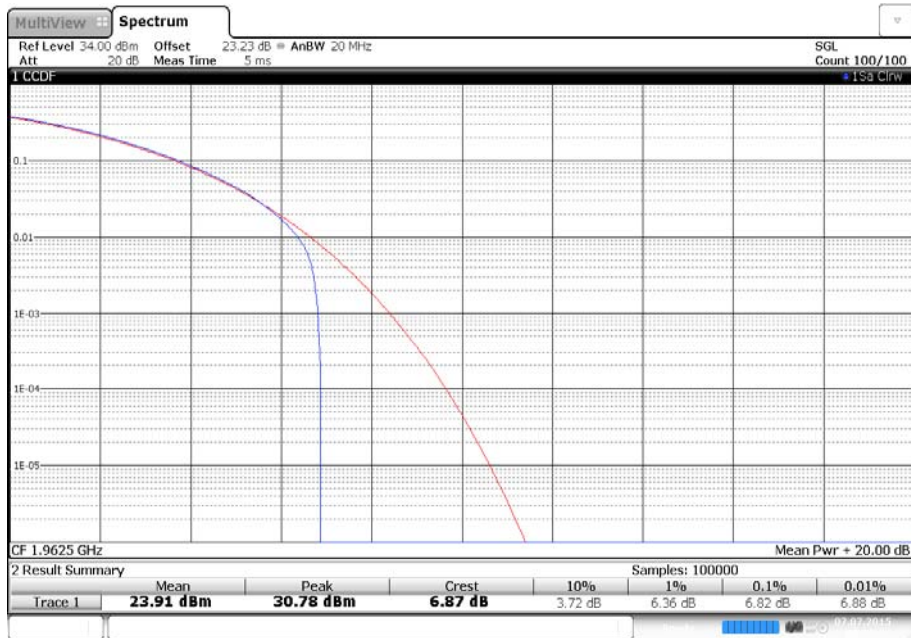

Date: 7.JUL.2015 00:05:57

Modulation 16QAM - Bandwidth 15.0 MHz - Antenna D - Channel Position M

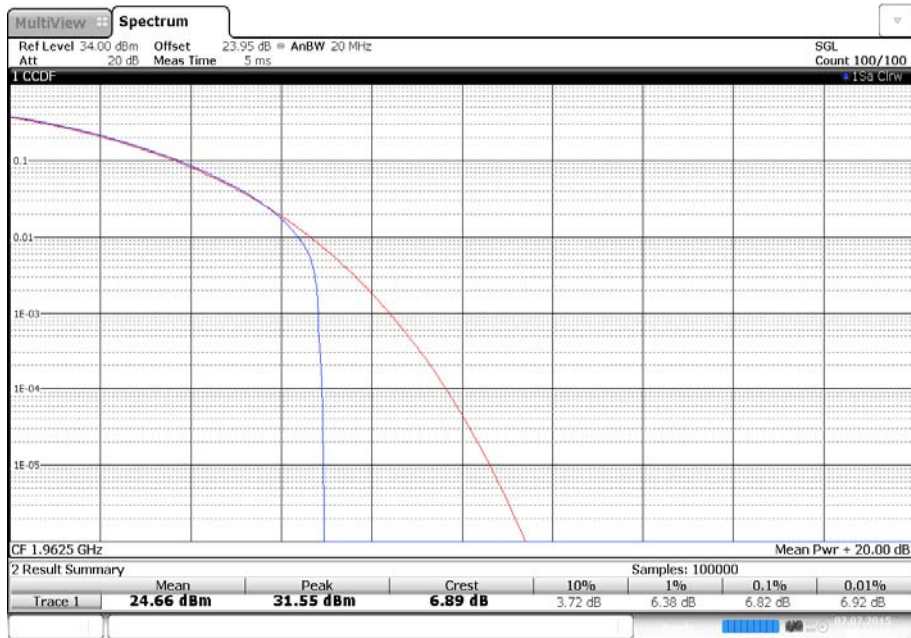

Date: 7.JUL.2015 00:16:36

Modulation 16QAM - Bandwidth 20.0 MHz - Antenna A - Channel Position M



Date: 6 JUL 2015 17:50:43

Modulation 16QAM - Bandwidth 20.0 MHz - Antenna B - Channel Position M

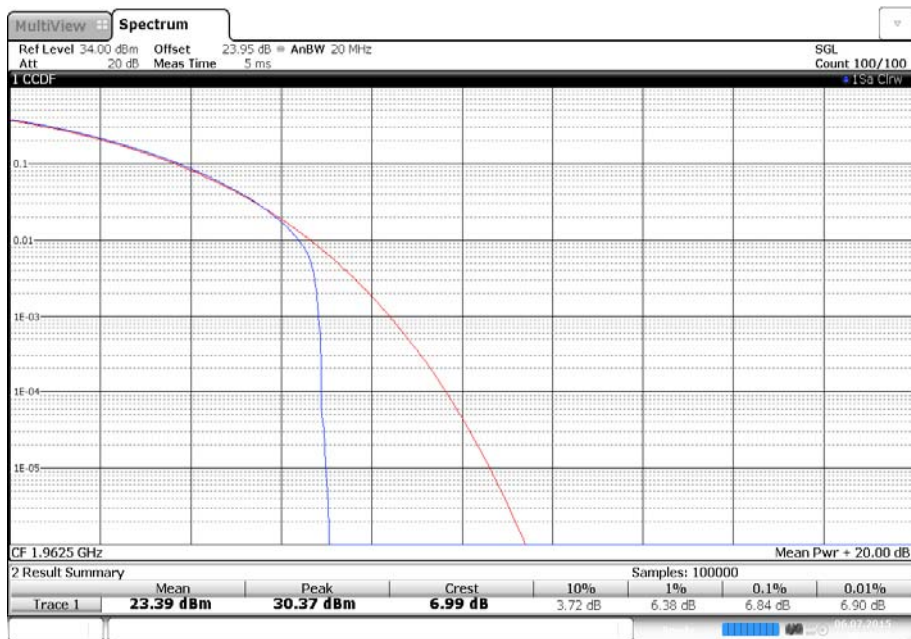

Date: 6 JUL 2015 18:03:25

Modulation 16QAM - Bandwidth 20.0 MHz - Antenna C - Channel Position M



Date: 7.JUL.2015 01:01:31

Modulation 16QAM - Bandwidth 20.0 MHz - Antenna D - Channel Position M

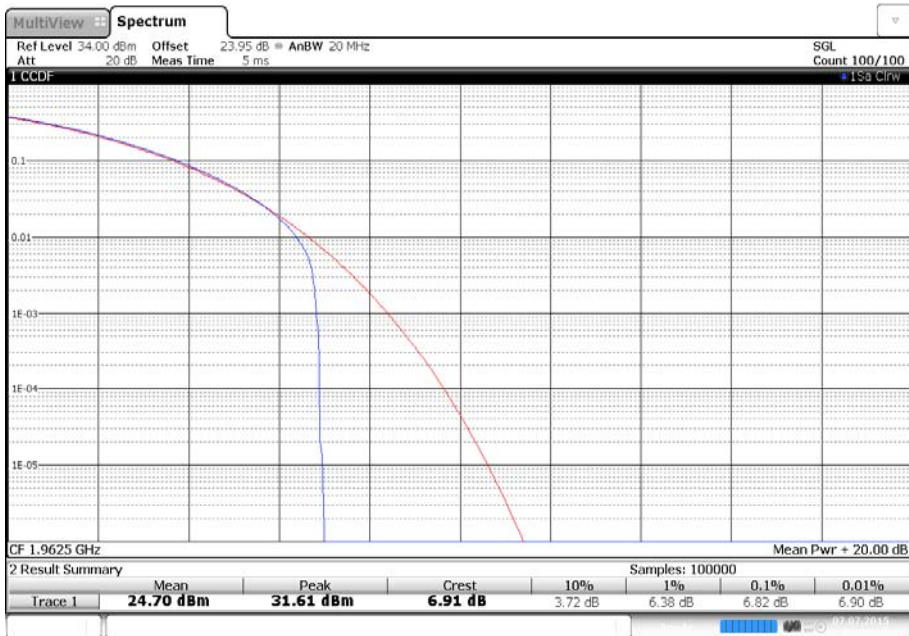

Date: 7.JUL.2015 01:14:12

Configuration A

Maximum Output Power 24 dBm

Modulation	Carrier Bandwidth (MHz)	Antenna	Output Power / Peak to Average Ratio (PAR)				
			Channel Position T				
			PAR (dB)	Average Power (dBm)	Average EIRP (dBm)	Average EIRP (dBm/MHz)	Average EIRP (W/MHz)
16QAM	5.0 MHz	A	6.88	23.49	28.49	21.50	0.14
		B	6.83	24.17	29.17	22.18	0.17
		C	6.89	23.68	28.68	21.69	0.15
		D	6.84	24.66	29.66	22.67	0.18
Total			-	30.04	35.04	28.05	0.64
16QAM	20.0 MHz	A	7.44	23.64	28.64	15.63	0.04
		B	7.24	24.06	29.06	16.05	0.04
		C	7.24	23.83	28.83	15.82	0.04
		D	7.27	24.69	29.69	16.68	0.05
Total			-	30.09	35.09	28.10	0.65

Modulation 16QAM - Bandwidth 5.0 MHz - Antenna A - Channel Position T

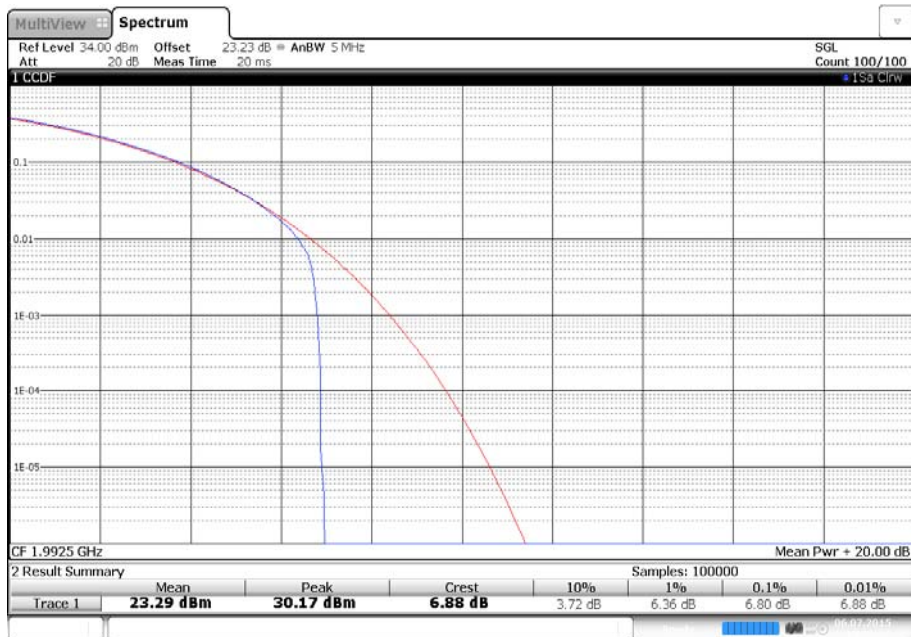

Date: 6 JUL 2015 15:01:16

Modulation 16QAM - Bandwidth 5.0 MHz - Antenna B - Channel Position T

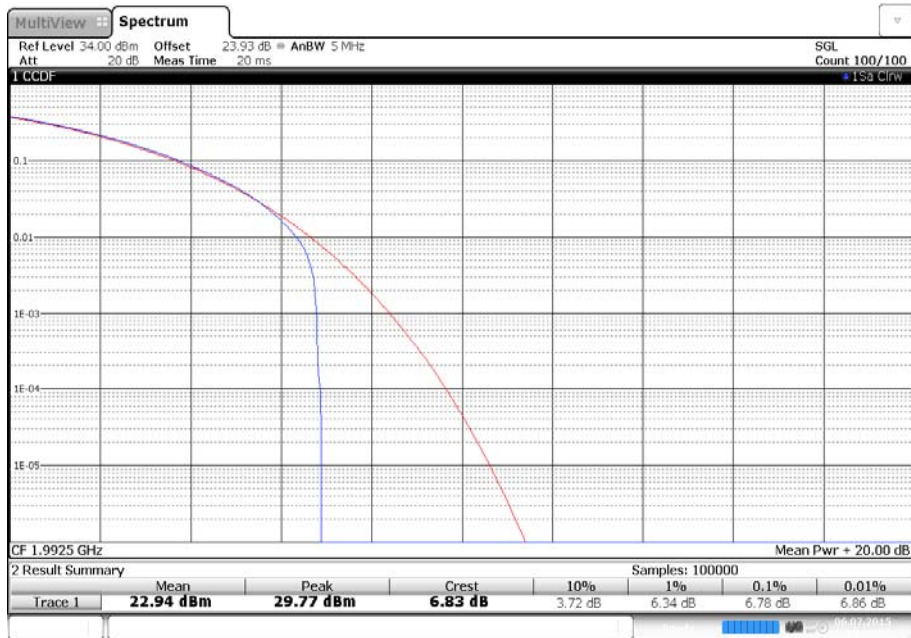

Date: 6 JUL 2015 15:14:15

Modulation 16QAM - Bandwidth 5.0 MHz - Antenna C - Channel Position T

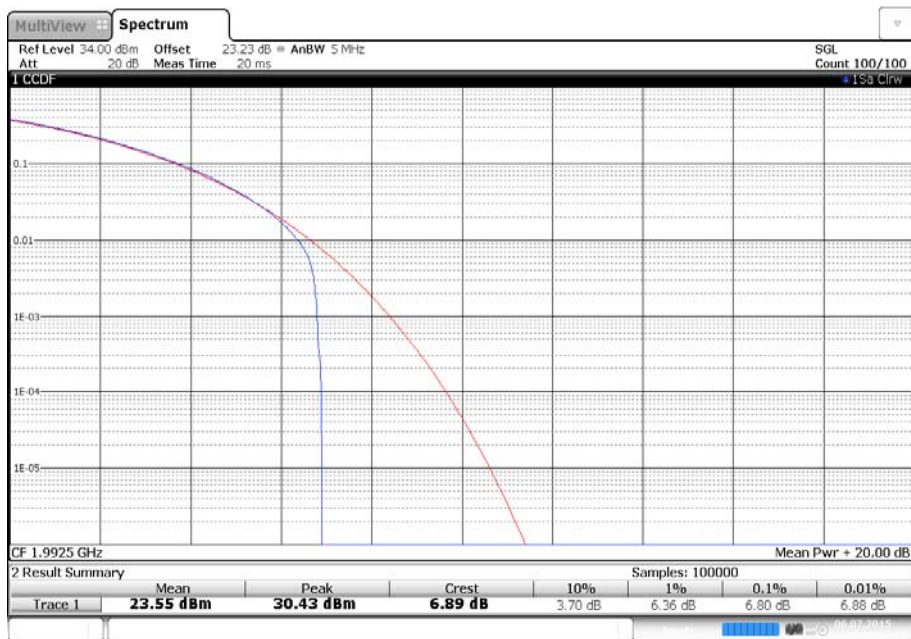

Date: 6 JUL 2015 22:10:54

Modulation 16QAM - Bandwidth 5.0 MHz - Antenna D - Channel Position T



Date: 6 JUL 2015 22:23:51

Modulation 16QAM - Bandwidth 20.0 MHz - Antenna A - Channel Position T

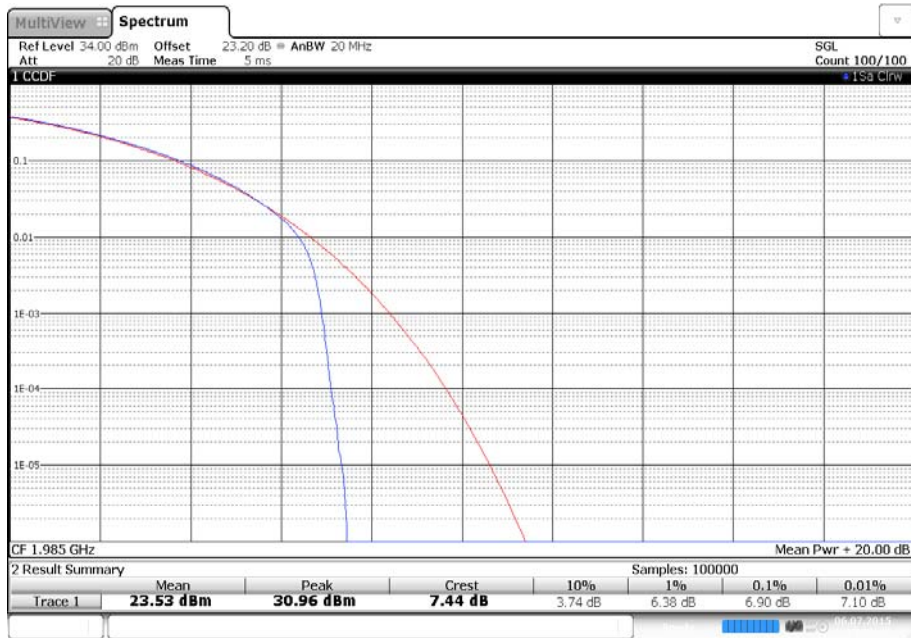

Date: 6 JUL 2015 17:51:47

Modulation 16QAM - Bandwidth 20.0 MHz - Antenna B - Channel Position T

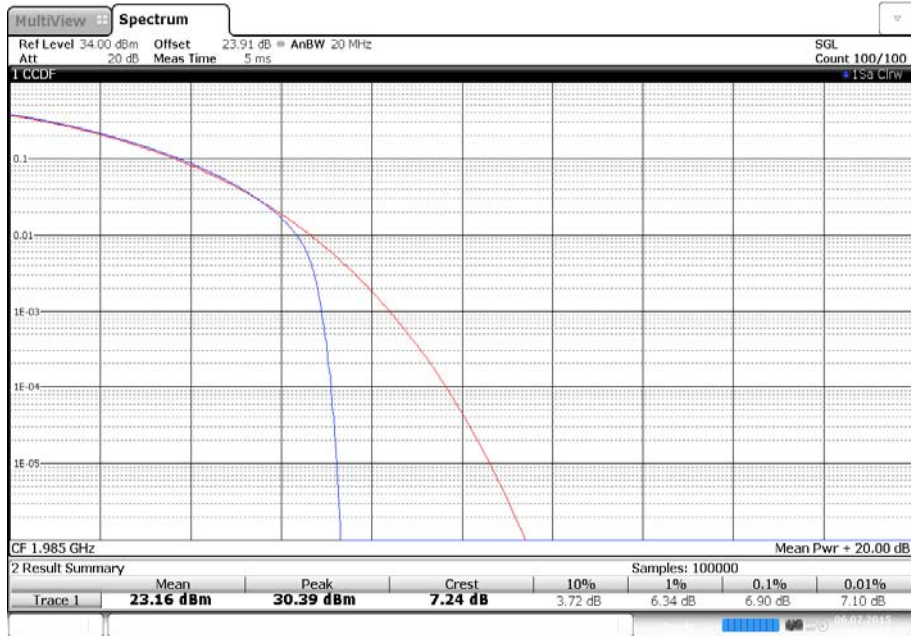

Date: 6 JUL 2015 18:04:28

Modulation 16QAM - Bandwidth 20.0 MHz - Antenna C - Channel Position T



Date: 7 JUL 2015 01:02:34

Modulation 16QAM - Bandwidth 20.0 MHz - Antenna D - Channel Position T



Date: 7.JUL.2015 01:15:15

Configuration A

Maximum Output Power 24 dBm

Modulation	Carrier Bandwidth (MHz)	Antenna	Output Power / Peak to Average Ratio (PAR)				
			Channel Position B				
			PAR (dB)	Average Power (dBm)	Average EIRP (dBm)	Average EIRP (dBm/MHz)	Average EIRP (W/MHz)
64QAM	5.0 MHz	A	7.00	24.05	29.05	22.06	0.16
		B	6.96	24.37	29.37	22.38	0.17
		C	6.93	23.93	28.93	21.94	0.16
		D	6.96	24.37	29.37	22.38	0.17
Total			-	30.20	35.20	28.22	0.66
64QAM	20.0 MHz	A	7.41	23.76	28.76	15.75	0.04
		B	7.44	24.32	29.32	16.31	0.04
		C	7.45	23.85	28.85	15.84	0.04
		D	7.47	24.51	29.51	16.50	0.04
Total			-	30.14	35.14	28.15	0.65

Modulation 64QAM - Bandwidth 5.0 MHz - Antenna A - Channel Position B



Date: 6 JUL 2015 14:30:50

Modulation 64QAM - Bandwidth 5.0 MHz - Antenna B - Channel Position B

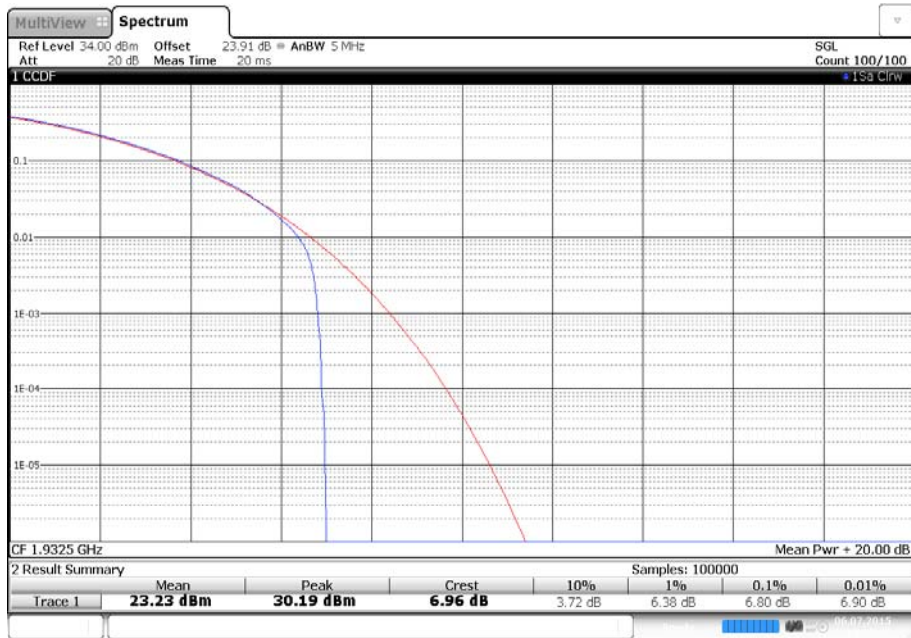

Date: 6 JUL 2015 14:43:44

Modulation 64QAM - Bandwidth 5.0 MHz - Antenna C - Channel Position B



Date: 6 JUL 2015 21:40:17

Modulation 64QAM - Bandwidth 5.0 MHz - Antenna D - Channel Position B

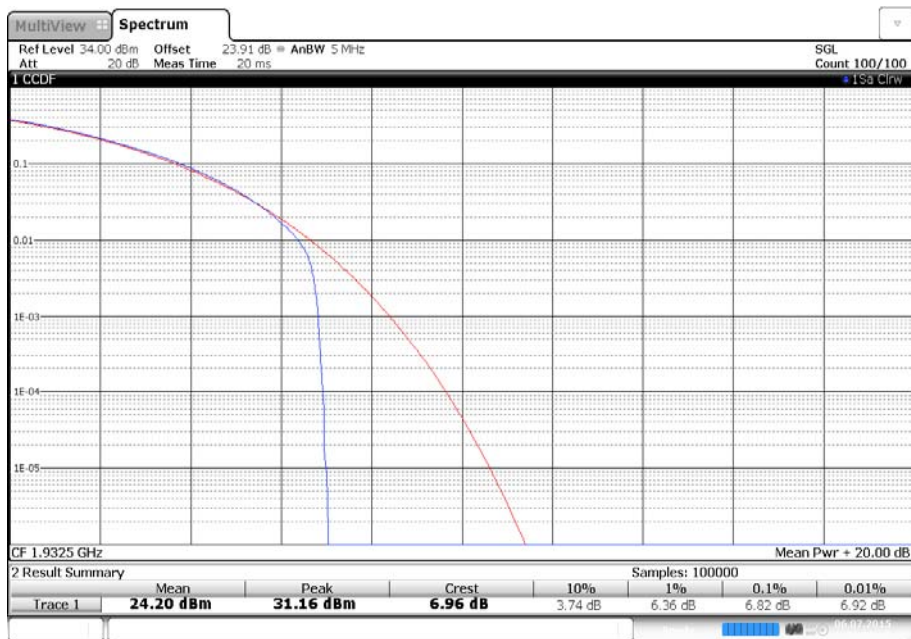

Date: 6 JUL 2015 21:53:13

Modulation 64QAM - Bandwidth 20.0 MHz - Antenna A - Channel Position B



Date: 6 JUL 2015 17:21:54

Modulation 64QAM - Bandwidth 20.0 MHz - Antenna B - Channel Position B



Date: 6 JUL 2015 17:34:34

Modulation 64QAM - Bandwidth 20.0 MHz - Antenna C - Channel Position B

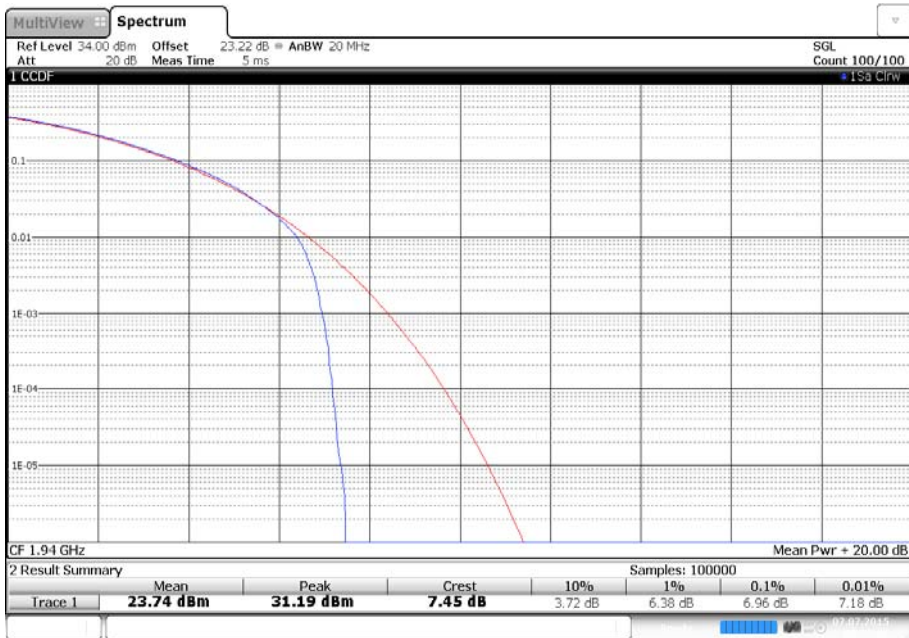

Date: 7.JUL.2015 00:32:43

Modulation 64QAM - Bandwidth 20.0 MHz - Antenna D - Channel Position B



Date: 7.JUL.2015 00:45:24

Configuration A

Maximum Output Power 24 dBm

Modulation	Carrier Bandwidth (MHz)	Antenna	Output Power / Peak to Average Ratio (PAR)				
			Channel Position M				
			PAR (dB)	Average Power (dBm)	Average EIRP (dBm)	Average EIRP (dBm/MHz)	Average EIRP (W/MHz)
64QAM	5.0 MHz	A	6.81	23.66	28.66	21.67	0.15
		B	6.86	24.17	29.17	22.18	0.17
		C	6.83	23.92	28.92	21.93	0.16
		D	6.83	24.60	29.60	22.61	0.18
Total			-	30.12	35.12	28.13	0.65
64QAM	10.0 MHz	A	6.86	23.76	28.76	18.76	0.08
		B	6.91	24.20	29.20	19.20	0.08
		C	6.85	23.94	28.94	18.94	0.08
		D	6.88	24.74	29.74	19.74	0.09
Total			-	30.20	35.20	28.21	0.66
64QAM	15.0 MHz	A	6.90	23.81	28.81	17.05	0.05
		B	6.96	24.42	29.42	17.66	0.06
		C	6.88	23.93	28.93	17.17	0.05
		D	6.92	24.86	29.86	18.10	0.06
Total			-	30.30	35.30	28.31	0.68
64QAM	20.0 MHz	A	6.98	23.77	28.77	15.76	0.04
		B	6.93	24.34	29.34	16.33	0.04
		C	6.91	24.05	29.05	16.04	0.04
		D	6.98	24.78	29.78	16.77	0.05
Total			-	30.27	35.27	28.28	0.67