



Choose Scandinavian trust

Radio Test report – Radio 4460 B25 B66 C

Project number:

462657-1TRFWL-R1

Applicant:

Ericsson Canada Inc.

Product name:

Radio 4460

Model (PMN):

Radio 4460 44B2/25 44B66 C

Part number:

KRC 161 912/3

FCC ID:

TA8AKRC161912-3

ISED Reg. Number:

287AB-AS1619123

HVIN:

AS1619123

FVIN:

CXP 901 3268/15-R90CJ

Requirements/Summary:

Standard	Environmental phenomenon	Compliance
FCC 47 CFR Part 27	Miscellaneous wireless communications services	Yes
FCC 47 CFR Part 24, Subpart E	Broadband Personal Communications Services (PCS)	Yes
RSS-133 Issue 6 A1, Jan 18, 2018	2 GHz Personal Communications Services	Yes
RSS-139 Issue 3, July 16, 2015	Advanced Wireless Services (AWS) Equipment Operating in the Bands 1710–1780 MHz and 2110–2180 MHz	Yes
RSS-170 Issue 3, July 9, 2015	Ancillary Terrestrial Component (ATC) Equipment Operating in the Mobile-Satellite Service (MSS) Bands AWS-4 (2180–2200MHz) Limitation as per IC P9 Licensing Agreement https://www.ic.gc.ca/eic/site/smt-gst.nsf/eng/sf11536.html	Yes

Date of issue: May 12, 2022

Moustapha Salah Toubeh, EMC/RF Specialist

Tested by

Signature

Andrey Adelberg, Senior EMC/Wireless Specialist

Reviewed by

Signature



Two test locations

Company name	Nemko Canada Inc.	
Address	303 River Road	349 Terry Fox
City	Ottawa	Ottawa
Province	Ontario	Ontario
Postal code	K1V 1H2	K2K 2V6
Country	Canada	Canada
Telephone	+1 613 737 9680	+1 613 963 8000
Facsimile	+1 613 737 9691	
Toll free	+1 800 563 6336	
Website	www.nemko.com	
Site number	FCC test site registration number: CA2040, IC: 2040A-4 (3 m semi anechoic chamber)	

Limits of responsibility

Note that the results contained in this report relate only to the items tested and were obtained in the period between the date of initial receipt of samples and the date of issue of the report.

This test report has been completed in accordance with the requirements of ISO/IEC 17025. All results contain in this reAnt Are within Nemko Canada's ISO/IEC 17025 accreditation.

Copyright notification

Nemko Canada Inc. authorizes the applicant to reproduce this report provided it is reproduced in its entirety and for use by the company's employees only. Any use which a third party makes of this report, or any reliance on or decisions to be made based on it, are the responsibility of such third parties.

Nemko Canada Inc. accepts no responsibility for damages, if any, suffered by any third party as a result of decisions made or actions based on this report.

© Nemko Canada Inc.

Table of contents

Table of contents	3
Section 1. Report summary	4
1.1 Applicant and manufacturer	4
1.2 Test specifications	4
1.3 Test method	4
1.4 Statement of compliance	4
1.5 Test report revision history	4
Section 2. Summary of test results	5
2.1 Testing location	5
2.2 Testing period	5
2.3 Sample information	5
2.4 FCC Part 27/24 test results	6
2.5 RSS-133/139/170 test results	6
Section 3. Equipment under test (EUT) details	7
3.1 EUT information	7
3.2 Product description and theory of operation	9
3.3 EUT test details	10
3.4 EUT setup diagram	21
3.5 Setup photographs	22
3.6 Setup photographs, continued	23
Section 4. Engineering considerations	24
4.1 Modifications incorporated in the EUT	24
4.2 Technical judgment	24
4.3 Deviations from laboratory tests procedures	24
Section 5. Test conditions	25
5.1 Atmospheric conditions	25
5.2 Power supply range	25
Section 6. Measurement uncertainty	26
6.1 Uncertainty of measurement	26
Section 7. Test equipment	27
7.1 Test equipment list	27
Section 8. Testing data	28
8.1 Maximum output power at RF antenna connector (Band 66)	28
8.2 Transmitter output power (EIRP) and antenna height (Band 25)	39
8.3 Spurious emissions at RF antenna connector (Band 66)	49
8.4 Radiated spurious emissions (Band 66 & 2/25)	66
8.5 Spurious out-of-band emissions (Band 25)	70
8.6 Occupied bandwidth (Band 66)	85
8.7 Occupied bandwidth (Band 25)	87
Section 9. Block diagrams of test setups	89
9.1 Radiated emissions set-up for frequencies below 1 GHz	89
9.2 Radiated emissions set-up for frequencies above 1 GHz	89
9.3 Conducted emissions set-up	90

Section 1. Report summary

1.1 Applicant and manufacturer

Company name	Ericsson Canada Inc.
Address	349 Terry Fox Drive, Ottawa, ON, Canada, K2K 2V6

1.2 Test specifications

FCC 47 CFR Part 2	Frequency Allocations and Radio Treaty Matters; General Rules and Regulations
FCC 47 CFR Part 24, Subpart E	Broadband Personal Communications Services (PCS)
FCC 47 CFR Part 27	Miscellaneous wireless communications services (2110–2200 MHz)
RSS-133 Issue 6 A1, Jan. 18, 2018	2 GHz Personal Communications Services
RSS-139 Issue 3, July 16, 2015	Advanced Wireless Services (AWS) equipment operating in the bands 1710–1780 MHz and 2110–2180 MHz
SRSP-510, Issue 5, February 2009	Technical Requirements for Personal Communications Services (PCS) in the Bands 1850–1915 MHz and 1930–1995 MHz
RSS-170 Issue 3, July 9, 2015*	Ancillary Terrestrial Component (ATC) Equipment Operating in the Mobile-Satellite Service (MSS) Bands
RSS-Gen, Issue 5, April 2018	General Requirements for Compliance of Radio Apparatus

*Equipment operating in the ancillary terrestrial component (ATC) of the frequency bands 2000–2020 MHz and 2180–2200 MHz is certified under RSS-170. Limitations specified under Industry Canada P9 Licensing Agreement applied as per <https://www.ic.gc.ca/eic/site/smt-gst.nsf/eng/sf11536.html>

1.3 Test method

ANSI C63.26-2015	American National Standard for Compliance Testing of Transmitters Used in Licensed Radio Services
KDB 662911 D01	Multiple Transmitter Output v02r01
KDB 662911 D02	MIMO with Cross-Polarized Antennas v01

1.4 Statement of compliance

In the configuration tested, the EUT was found compliant. Testing was completed against customer test plan. Results obtained indicate that the product under test complies in full with the requirements tested.

This test report (462657-1TRFWL -R1 is a C2PC to the 454153-1TRFWL-R1 report) applies to the Radio 4460 44B2/25 44B66 C with part number KRC 161 912/3. See “Summary of test results” for full details.

EUT Configuration(s) SRO/MRO:

B25:

LTE: 5, 10, 15, 20 MHz (Max 6 Carriers)

NR: 5, 10, 15, 20, 25, 30, 40 MHz, (Max 6 Carriers)

WCDMA/CDMA/GSM: Max 1 Carrier

LTE + NR

LTE/NR + WCDMA/CDMA/GSM

WCDMA+GSM

B66:

LTE: 5, 10, 15, 20 MHz (Max 6 Carriers)

NR: 5, 10, 15, 20, 25, 30, 40 MHz (Max 6 Carriers)

WCDMA: Max 1 Carrier

LTE + NR

LTE/NR + WCDMA

1.5 Test report revision history

Table 1.5-1: Test report revision history

Revision #	Date of issue	Details of changes made to test report
TRF	May 12, 2022	Original report issued



Section 2. Summary of test results

2.1 Testing location

Test location (s) Ottawa

2.2 Testing period

Test start date March 29, 2022 Test end date March 30, 2022

2.3 Sample information

Receipt date March 29, 2022 Nemko sample ID number 1

2.4 FCC Part 27/24 test results

Table 2.4-1: FCC results summary

Part	Test description	Verdict
§27.50(b)	Maximum output power at RF antenna connector	Pass
§27.53	Spurious emissions at RF antenna connector	Pass
§27.53	Radiated spurious emissions (conducted and radiated)	Pass
§24.229	Frequencies	Pass ¹
§24.232(a)(2)	Power and antenna height limits for base stations with BW greater than 1 MHz	Pass
§24.238(a)	Emission limitations for Broadband PCS equipment – out of band emissions (conducted and radiated)	Pass
§2.1049	Occupied bandwidth	Pass

Notes: Only tests applicable to C2PC have been performed

¹EUT transmits within 1930–1995 MHz frequency range

2.5 RSS-133/139/170 test results

Table 2.5-1: ISED results summary

Part	Test description	Verdict
RSS-133, 6.1	Frequency Plan	Pass ¹
RSS-133, 6.2	Types of Modulation	Pass ²
RSS-133, 6.4	Transmitter Output Power and Equivalent Isotropically Radiated Power	Pass
RSS-133, 6.5	Transmitter Unwanted Emissions (conducted and radiated)	Pass
RSS-139, 4.1	Transmitter output power and Equivalent Isotropic Radiated Power (e.i.r.p.)	Pass
RSS-139, 4.2	Spurious emissions at RF antenna connector	Pass
RSS-139, 4.2	Radiated spurious emissions (conducted and radiated)	Pass
RSS-170, 5.3	Transmitter output power and Equivalent Isotropic Radiated Power (e.i.r.p.)	Pass
RSS-170, 5.4	Spurious emissions at RF antenna connector	Pass
RSS-170, 5.4	Radiated spurious emissions (conducted and radiated)	Pass
RSS-Gen, 6.7	Occupied bandwidth	Pass

Notes: Only tests applicable to C2PC have been performed

¹EUT transmits within 1930–1995 MHz frequency range

²EUT employs digital modulation (QPSK to 256-QAM)

ATC Base Station Equipment operating in bands 2000–2020 MHz and 2180–2200 MHz

The unwanted emissions of ATC base station equipment transmitting in the bands 2000–2020 MHz and 2180–2200 MHz shall comply with the following:

- (1) The power of any unwanted emissions at frequencies outside the equipment's operating frequency block shall be attenuated below the transmitter power P (dBW), by $43 + 10 \log p$ (watts), dB.
- (2) For equipment operating in the band 2180–2200 MHz, in addition to (1), the power of any emissions on all frequencies between 2200 MHz and 2290 MHz shall not exceed an e.i.r.p. of $-100.6 \text{ dBW}/4 \text{ kHz}$ ($-70.6 \text{ dBm}/4 \text{ kHz}$).*

*** This requirement is for implementation and is enforced at the time of licensing. Therefore, results are not included in this report.**

Note: Requirement number (2) above is amended as detailed in the following ISED document: <https://www.ic.gc.ca/eic/site/smt-gst.nsf/eng/sf11536.html>

Section 3. Equipment under test (EUT) details

3.1 EUT information

Product name	Radio 4460	
Model	Radio 4460 44B2/25 44B66 C	
Part number	KRC 161 912/3	
Revision	R3B	
Serial number	E23D452220	
Antenna ports	4 TX/RX Ports	
RF BW / IBW	B2 IBW DL: 60 MHz B2 IBW UL: 60 MHz B25 IBW DL: 65 MHz B25 IBW UL: 65 MHz	B66 IBW DL: 90 MHz B66 IBW UL: 70 MHz
FDD	B2/25: 80 MHz	B66: 400 MHz
Frequency	B2 TX (DL): 1930 – 1990 MHz B2 RX (UL): 1850 – 1910 MHz B25 TX (DL): 1930–1995 MHz B25 RX (UL): 1850–1915 MHz	B66 TX (DL): 2110–2200 MHz B66 RX (UL): 1710–1780 MHz
Nominal O/P per Antenna port	140 W (51.46 dBm): 80 W per Band	
Nominal O/P per Antenna port per Band	Single Carrier: 1 × 80 W (49.03 dBm/Carrier) 2 Carrier: 2 × 40 W (46.02 dBm/Carrier total) 3 Carrier: 3 × 26.7 W (44.26 dBm/Carrier total)	
Accuracy (nominal)	±0.1 ppm	
Nominal voltage	-48 V _{DC} @ 40 A	
RAT	B2: LTE, (LTE+NB-IoT (IB, GB)), NR, GSM, WCDMA, CDMA B25: LTE, (LTE+NB-IoT (IB, GB)), NR	B66: LTE, (LTE+NB-IoT (IB, GB)), NR, WCDMA (B4)
Modulation	LTE: QPSK, 16 QAM, 64 QAM, 256 QAM NR: QPSK, 16 QAM, 64 QAM, 256 QAM NB-IoT: QPSK WCDMA: QPSK, 16 QAM, 64 QAM GSM: GMSK, 8-PSK, AQPSK CDMA: QPSK, 8-PSK, 16 QAM	
Channel bandwidth	LTE: 5, 10, 15, 20 MHz NR: 5, 10, 15, 20, 25, 30, 40 MHz WCDMA: 5 MHz CDMA: 1.25 MHz GSM: 200 kHz	
Channel bandwidth LTE + NB-IoT	LTE+NB-IoT IB: 5, 10, 15, 20 MHz LTE+NB-IoT GB: 10, 15, 20 MHz NB-IoT (GB, IB): 200 kHz	
Maximum combined OBW per port	B25: 65 MHz	B66: 90 MHz
CPRI	2.5G, 4.9G, 9.8G, 10.1 Gbps	

Section 3:

Equipment under test (EUT) details



Channel raster	LTE: 100 kHz NR: 100 kHz WCDMA / GSM: 200 kHz CDMA: 50 kHz			
Regulatory requirements	Radio: FCC Part 2, 24, 27, RSS-Gen, RSS-133, RSS-139, (RSS-170 / IC P9 Licensing Agreement AWS-4)			
	EMC: FCC Part 15, ICES-003			
Emission Designator	Safety: IEC/EN 62368-1, UL/CSA 62368-1			
	IEC/EN 60950-22, UL 50E /CAN/CSA, IEC/EN 60529, Type 3 Enclosure			
Emission Designator	LTE: 5M00W7D, 10M0W7D, 15M0W7D, 20M0W7D NR: 5M00W7D, 10M0W7D, 15M0W7D, 20M0W7D, 25M0W7D, 30M0W7D, 40M0W7D WCDMA: 5M00F9W GSM: 200KG7W CDMA: 1M25F9W			
Supported Configurations	Single Antenna, TX Diversity, MIMO, Carrier Aggregation, Ericsson Spectral Sharing (ESS)			
Operating temperature	-40 °C to +55 °C			
Total Power based on IBW	560 W total / radio (4 ports × 140 W)			
Supported carriers /band/ port SRO/MRO	Up to 6 carriers.			
	LTE: Max 6 NR: Max 6 LTE + NB-IoT: GB Max 2, IB Max 2 WCDMA/CDMA/GSM: Max 1			
Carrier Configuration: B2/25: W, G, C are limited to B2 B66: W is limited to B4	B2/25		B66	
	SRO: LTE, NR, W, G, C MRO: L+NR, L+W, L+G, L+C, NR+W, NR+G, NR+C, C+NR+L, G+NR+L, W+NR+L		SRO: LTE, NR, WCDMA MRO: L+NR, L+W, NR+W, W+NR+L	
Total Power based on IBW	560 W (57.48 dBm) Total / Radio			140 W / Port (max)
Radio Band Power (max.)	Configurations /Port:		B2/25:	B66:
	1		80 W	60 W
	2		60 W	80 W
	3		70 W	70 W
RAT SC Carrier Power (max)	RAT	BW	PWR/Carrier(max) 4W/MHz Configuration	PWR/Carrier(max) 6W/MHz Configuration
	LTE/NR	5 MHz	20 W	30 W
	LTE/NR	10 MHz	40 W	60 W
	LTE/NR	15 MHz	60 W	80 W
	LTE/NR	20 MHz	80 W	80 W
	NR	25	80W	80W
	NR	30	80W	80W
	NR	40	80W	80W
	WCDMA	5 MHz	20 W	20 W
	GSM	200 kHz	20 W	20 W
	CDMA	1.25 MHz	20 W	20 W

3.2 Product description and theory of operation

EUT description of the methods used to exercise the EUT and all relevant ports:

Description/theory of operation	<p>Radio 4460 44B2B/B25 44B66 C (KRC 161 912/3) is a multi-standard remote Dual Band radio forming part of the Ericsson RBS (Radio Base Station) equipment. Radio 4460 provides radio access for mobile and fixed devices and is designed for the outdoor environment. Radio 4460 operates over 2 bands (Band 2/25 and Band 66) via 4 TX/RX ports connected directly into an integrated antenna. Radio unit installation is designed for pole, wall or rail mount options. A fiber optic interface (4) provides the RRU/RBS control and digital interface between the Radio and the RBS. Radio 4460 product is convection cooled and shall be mounted vertically.</p> <p>Output RF Power is rated at 4 x 140 W. Altitude during operation: Below 4000 m</p> <p>Radio 4460 is a synthesized Transceiver designed for use in the 3GPP (Third Generation Partnership Project) for LTE (Long Term Evolution) - E-UTRA Base Station, NR (New Radio), WCDMA, GSM and CDMA. Radio 4460 B2/25 B66 C is a 4TX/4RX remote radio unit (RRU). This RRU operates in Band 2/25 as defined by 3GPP. TX (DL): 1930–1995 MHz, RX (UL): 1850–1915 MHz and Band 66 TX (DL): 2110–2200 MHz, RX (UL): 1710–1780 MHz</p> <p>For LTE/NR, Radio 4460 B2/25 B66 supports modulations QPSK, 16QAM, 64QAM and 256QAM. Channel Bandwidth is configurable for LTE 5, 10, 15 or 20 MHz, NR 5, 10, 15, 20, 25, 30, 40 MHz. For WCDMA: QPSK, 16QAM, 64QAM; for GSM: GMSK, 8-PSK, AQPSK; for CDMA: QPSK, 8-PSK, 16QAM. The Radio transmits SRO/MRO in single carrier mode and multi carrier mode within the Band Specific IBW (Instantaneous Band Width). LTE NB-IoT is supported for IB and GB.</p> <p>Radio 4460 supports single and multi-beam FD MIMO (Multiple Input Multiple Output), Carrier Aggregation and ESS/DSS).</p>																																	
Ports/Interface	<table border="1"> <thead> <tr> <th>Port</th> <th>Description</th> </tr> </thead> <tbody> <tr> <td>ANT 1–16</td> <td>RF Output ports from 1 to 4</td> </tr> <tr> <td>Alarm</td> <td>Alarm</td> </tr> <tr> <td>ALD</td> <td>Antenna Line Device</td> </tr> <tr> <td>Data 1</td> <td>Optical Interface Data 1</td> </tr> <tr> <td>Data 2</td> <td>Optical Interface Data 2</td> </tr> <tr> <td>Data 3</td> <td>Optical Interface Data 3</td> </tr> <tr> <td>Data 4</td> <td>Optical Interface Data 4</td> </tr> <tr> <td>DC Input 1-2</td> <td>-48 V_{DC}</td> </tr> <tr> <td>MMI</td> <td>Display - Radio Status</td> </tr> <tr> <td>GND</td> <td>Ground</td> </tr> </tbody> </table>	Port	Description	ANT 1–16	RF Output ports from 1 to 4	Alarm	Alarm	ALD	Antenna Line Device	Data 1	Optical Interface Data 1	Data 2	Optical Interface Data 2	Data 3	Optical Interface Data 3	Data 4	Optical Interface Data 4	DC Input 1-2	-48 V _{DC}	MMI	Display - Radio Status	GND	Ground											
Port	Description																																	
ANT 1–16	RF Output ports from 1 to 4																																	
Alarm	Alarm																																	
ALD	Antenna Line Device																																	
Data 1	Optical Interface Data 1																																	
Data 2	Optical Interface Data 2																																	
Data 3	Optical Interface Data 3																																	
Data 4	Optical Interface Data 4																																	
DC Input 1-2	-48 V _{DC}																																	
MMI	Display - Radio Status																																	
GND	Ground																																	
Physical	<table border="1"> <tbody> <tr> <td>Dimensions</td> <td>398 mm x 494 mm x 316 mm (H x W x D)</td> </tr> <tr> <td>Weight</td> <td>49 kg</td> </tr> <tr> <td>Operating Temperature</td> <td>-40 to +55 °C</td> </tr> <tr> <td>Mounting</td> <td>Pole, Wall, Rail Mount</td> </tr> <tr> <td>Cooling</td> <td>Convection (forced air)</td> </tr> </tbody> </table>	Dimensions	398 mm x 494 mm x 316 mm (H x W x D)	Weight	49 kg	Operating Temperature	-40 to +55 °C	Mounting	Pole, Wall, Rail Mount	Cooling	Convection (forced air)																							
Dimensions	398 mm x 494 mm x 316 mm (H x W x D)																																	
Weight	49 kg																																	
Operating Temperature	-40 to +55 °C																																	
Mounting	Pole, Wall, Rail Mount																																	
Cooling	Convection (forced air)																																	
Software details	CXP 901 3268/15_R90CJ																																	
Radio Hardware Configuration	<table border="1"> <thead> <tr> <th>Product: KRC 161 912/3</th> <th>R3B</th> <th>Description</th> </tr> </thead> <tbody> <tr> <td>NTB 101 1912/1</td> <td>R1E</td> <td>Parts</td> </tr> <tr> <td>NTB 101 1913/1</td> <td>R1C</td> <td>Parts</td> </tr> <tr> <td>1/KRC 161 912/3</td> <td>R3B</td> <td>Radio Unit (2)</td> </tr> <tr> <td>ROA 128 8480/1</td> <td>R1J</td> <td>Radio PCP</td> </tr> <tr> <td>ROZ 104 8488/1</td> <td>R3A</td> <td>DC-DC Circuit</td> </tr> <tr> <td>ROR 101 8480/25</td> <td>R1F</td> <td>PAM B25 (2)</td> </tr> <tr> <td>ROR 101 8480/66</td> <td>R1C</td> <td>PAM B66 (2)</td> </tr> <tr> <td>KRF 901 591</td> <td>R1F</td> <td>Filter Unit</td> </tr> <tr> <td>NTB 101 1914/1</td> <td>R1E</td> <td>Parts</td> </tr> <tr> <td>..NTB 101 1915/1</td> <td>R1D</td> <td>Parts</td> </tr> </tbody> </table>	Product: KRC 161 912/3	R3B	Description	NTB 101 1912/1	R1E	Parts	NTB 101 1913/1	R1C	Parts	1/KRC 161 912/3	R3B	Radio Unit (2)	ROA 128 8480/1	R1J	Radio PCP	ROZ 104 8488/1	R3A	DC-DC Circuit	ROR 101 8480/25	R1F	PAM B25 (2)	ROR 101 8480/66	R1C	PAM B66 (2)	KRF 901 591	R1F	Filter Unit	NTB 101 1914/1	R1E	Parts	..NTB 101 1915/1	R1D	Parts
Product: KRC 161 912/3	R3B	Description																																
NTB 101 1912/1	R1E	Parts																																
NTB 101 1913/1	R1C	Parts																																
1/KRC 161 912/3	R3B	Radio Unit (2)																																
ROA 128 8480/1	R1J	Radio PCP																																
ROZ 104 8488/1	R3A	DC-DC Circuit																																
ROR 101 8480/25	R1F	PAM B25 (2)																																
ROR 101 8480/66	R1C	PAM B66 (2)																																
KRF 901 591	R1F	Filter Unit																																
NTB 101 1914/1	R1E	Parts																																
..NTB 101 1915/1	R1D	Parts																																
Product Identification / Markings and Labels																																		

3.3 EUT test details

EUT setup/configuration rationale for Down link:

RAT	Modulation	Performance Requirement	Test Model / Configuration
LTE/NR	QPSK	N/A	E-TM1.1
LTE/NR	16QAM	N/A	E-TM3.2
LTE/NR	64QAM	N/A	E-TM3.1
LTE/NR	256QAM	N/A	E-TM3.1a
WCDMA	QPSK	N/A	TM1
WCDMA	16QAM	N/A	TM5
WCDMA	64QAM	N/A	TM6
CDMA	QPSK	N/A	TM2
GSM	GMSK	N/A	TM1

LTE Single Carrier B25

Bandwidth, MHz	LTE Transmit / DL, MHz					
	B	EARFCN	M	EARFCN	T	EARFCN
5	1932.5	8065	1962.5	8365	1992.5	8665
10	1935.0	8090	1962.5	8365	1990.0	8640
15	1937.5	8115	1962.5	8365	1987.5	8615
20	1940.0	8140	1962.5	8365	1985.0	8590

Bandwidth, MHz	LTE Receive / UL, MHz					
	B	EARFCN	M	EARFCN	T	EARFCN
5	1852.5	26065	1882.5	26365	1912.5	26665
10	1855.0	26090	1882.5	26365	1910.0	26640
15	1857.5	26115	1882.5	26365	1907.5	26615
20	1860.0	26140	1882.5	26365	1905.0	26590

NR Single Carrier B25

Bandwidth, MHz	Transmit / DL, MHz					
	B	NR-ARFCN	M	NR-ARFCN	T	NR-ARFCN
5	1932.5	386500	1962.5	392500	1992.5	398500
10	1935.0	387000	1962.5	392500	1990.0	398000
15	1937.5	387500	1962.5	392500	1987.5	397500
20	1940.0	388000	1962.5	392500	1985.0	397000
25	1942.5	388500	1962.5	392500	1982.5	396500
30	1945.0	389000	1962.5	392500	1980.0	396000
40	1950.0	390000	1962.5	392500	1975.0	395000

Bandwidth, MHz	Receive / UL, MHz					
	B	NR-ARFCN	M	NR-ARFCN	T	NR-ARFCN
5	1852.5	370500	1882.5	376500	1912.5	382500
10	1855.0	371000	1882.5	376500	1910.0	382000
15	1857.5	371500	1882.5	376500	1907.5	381500
20	1860.0	372000	1882.5	376500	1905.0	381000
25	1862.5	372500	1882.5	376500	1902.5	380500
30	1865.0	373000	1882.5	376500	1900.0	380000
40	1870.0	374000	1882.5	376500	1895.0	379000

EUT test details, continued

WCDMA Single Carrier B2

Bandwidth, MHz	Transmit / DL, MHz					
	B	UARFCN	M	UARFCN	T	UARFCN
5	1932.4	9662	1960	9800	1987.6	9938

Bandwidth, MHz	Receive / UL, MHz					
	B	Channel	M	EARFCN	T	Channel
1.25	1851.250	25	1880.000	600	1908.750	1175

GSM Single Carrier B2

Bandwidth, MHz	Transmit / DL, MHz					
	B	ARFCN	M	ARFCN	T	ARFCN
0.2	1930.2	512	1960	661	1989.8	810

Bandwidth, MHz	Receive / UL, MHz					
	B	ARFCN	M	ARFCN	T	ARFCN
0.2	1850.2	512	1880.0	661	1909.8	810

CDMA Single Carrier B2

Bandwidth, MHz	Transmit / DL, MHz					
	B	Channel	M	Channel	T	Channel
1.25	1931.250	25	1960.000	600	1988.750	1175

Bandwidth, MHz	Receive / UL, MHz					
	B	Channel	M	EARFCN	T	Channel
1.25	1851.250	25	1880.000	600	1908.750	1175

LTE Single Carrier B66

Bandwidth, MHz	LTE Transmit / DL, MHz					
	B	EARFCN	M	EARFCN	T	EARFCN
5	2112.5	66461	2155.0	66886	2197.5	67311
10	2115.0	66486	2155.0	66886	2195.0	67286
15	2117.5	66511	2155.0	66886	2192.5	67261
20	2120.0	66536	2155.0	66886	2190.0	67236

Bandwidth, MHz	LTE Receive / UL, MHz					
	B	EARFCN	M	EARFCN	T	EARFCN
5	1712.5	131997	1745.0	132322	n/a	n/a
10	1715.0	132022	1745.0	132322	n/a	n/a
15	1717.5	132047	1745.0	132322	n/a	n/a
20	1720.0	132072	1745.0	132322	n/a	n/a

EUT test details, continued

NR Single Carrier B66

Bandwidth, MHz	Transmit / DL, MHz					
	B	NR-ARFCN	M	NR-ARFCN	T	NR-ARFCN
5	2112.5	422500	2155.0	431000	2197.5	439500
10	2115.0	423000	2155.0	431000	2195.0	439000
15	2117.5	423500	2155.0	431000	2192.5	438500
20	2120.0	424000	2155.0	431000	2190.0	438000
25	2122.5	424500	2155.0	431000	2187.5	437500
30	2125.0	425000	2155.0	431000	2185.0	437000
40	2130.0	426000	2155.0	431000	2180.0	436000

Bandwidth, MHz	Receive / UL, MHz					
	B	NR-ARFCN	M	NR-ARFCN	T	NR-ARFCN
5	1712.5	342500	1755.0	351000	n/a	n/a
10	1715.0	343000	1755.0	351000	n/a	n/a
15	1717.5	343500	1755.0	351000	n/a	n/a
20	1720.0	344000	1755.0	351000	n/a	n/a
25	1722.5	344500	1745	349000	1767.5	353500
30	1725.0	345000	1745	349000	1765.0	353000
40	1730.0	346000	1745	349000	1760.0	352000



EUT test details, continued

WCDMA Single Carrier B66 (B4 portion)

Bandwidth, MHz	Transmit / DL, MHz					
	B	UARFCN	M	UARFCN	T	UARFCN
5	2112.4	1537	2132.6	1638	2152.6	1738

Bandwidth, MHz	Receive / UL, MHz					
	B	UARFCN	M	UARFCN	T	UARFCN
5	1712.4	1312	1732.6	1413	1752.6	1513

B25 LTE Multiple-Carriers for Band Edge and Spurious Emissions:

Bandwidth, MHz	Transmit / DL, MHz							
	B1	EARFCN	B2	EARFCN	T2	EARFCN	T1	EARFCN
10	1935.0	8090	1945.0	8190	1980.0	8540	1990.0	8640

Bandwidth, MHz	Receive / UL, MHz							
	B1	EARFCN	B2	EARFCN	T2	EARFCN	T1	EARFCN
10	1855.0	26090	1865.0	26190	1900.0	26540	1910.0	26640

B25 LTE Multiple-Carriers for Band Edge and Spurious Emissions:

Bandwidth, MHz	Transmit / DL, MHz											
	B1	EARFCN	B2	EARFCN	B3	EARFCN	T3	EARFCN	T2	EARFCN	T1	EARFCN
10	1935.0	8090	1945.0	8190	1955.0	8290	1970.0	8440	1980.0	8540	1990.0	8640

Bandwidth, MHz	Receive / UL, MHz											
	B1	EARFCN	B2	EARFCN	B3	EARFCN	T3	EARFCN	T2	EARFCN	T1	EARFCN
10	1855.0	26090	1865.0	26190	1875.0	26290	1890.0	26440	1900.0	26540	1910.0	26640

B25 LTE Multiple-Carriers for Band Edge and Spurious Emissions:

Bandwidth, MHz	Transmit / DL, MHz							
	B1	B2	B3	B4	T4	T3	T2	T1
5	1932.5	1937.5	1942.5	1947.5	1977.5	1982.5	1987.5	1992.5

Bandwidth, MHz	Receive / UL, MHz							
	B1	B2	B3	B4	T4	T3	T2	T1
5	1852.5	1857.5	1862.5	1867.5	1897.5	1902.5	1907.5	1912.5

B25 NR Multiple-Carriers for Band Edge and Spurious Emissions:

Bandwidth, MHz	Transmit / DL, MHz							
	B1	NR-ARFCN	B2	NR-ARFCN	T2	NR-ARFCN	T1	NR-ARFCN
10	1935.0	387000	1945.0	389000	1980.0	396000	1990.0	398000

Bandwidth, MHz	Receive / UL, MHz							
	B1	NR-ARFCN	B2	NR-ARFCN	T2	NR-ARFCN	T1	NR-ARFCN
10	1855.0	371000	1865.0	1855.0	1900.0	380000	1910.0	382000

EUT test details, continued

B25 NR Multiple-Carriers for Band Edge and Spurious Emissions:

Bandwidth, MHz	Transmit / DL, MHz											
	B1	NR-ARFCN	B2	NR-ARFCN	B3	NR-ARFCN	T3	NR-ARFCN	T2	NR-ARFCN	T1	NR-ARFCN
10	1935.0	387000	1945.0	389000	1955.0	391000	1970.0	394000	1980.0	396000	1990.0	398000

Bandwidth, MHz	Receive / UL, MHz											
	B1	NR-ARFCN	B2	NR-ARFCN	B3	NR-ARFCN	T3	NR-ARFCN	T2	NR-ARFCN	T1	NR-ARFCN
10	1855.0	371000	1865.0	373000	1875.0	375000	1890.0	378000	1900.0	380000	1910.0	382000

B25 NR Multiple-Carriers for Band Edge and Spurious Emissions:

Bandwidth, MHz	Transmit / DL, MHz									
	B1	B2	B3	B4	T4	T3	T2	T1		
5	1932.5	1937.5	1942.5	1947.5	1977.5	1982.5	1987.5	1992.5		

Bandwidth, MHz	Receive / UL, MHz									
	B1	B2	B3	B4	T4	T3	T2	T1		
5	1852.5	1857.5	1862.5	1867.5	1897.5	1902.5	1907.5	1912.5		

B66 LTE Multiple-Carriers for Band Edge and Spurious Emissions:

Bandwidth, MHz	Transmit / DL, MHz									
	B1	EARFCN	B2	EARFCN	T2	EARFCN	T1	EARFCN		
10	2115.0	66486	2125.0	66586	2185.0	67186	2195.0	67286		

Bandwidth, MHz	Receive / UL, MHz									
	B1	EARFCN	B2	EARFCN	T2	EARFCN	T1	EARFCN		
10	1715.0	132022	1725.0	132122	n/a	n/a	n/a	n/a		

B66 LTE Multiple-Carriers for Band Edge and Spurious Emissions:

Bandwidth, MHz	Transmit / DL, MHz											
	B1	EARFCN	B2	EARFCN	B3	EARFCN	T3	EARFCN	T2	EARFCN	T1	EARFCN
10	2115.0	66486	2125.0	66586	2135.0	66686	2175.0	67086	2185.0	67186	2195.0	67286

Bandwidth, MHz	Receive / UL, MHz											
	B1	EARFCN	B2	EARFCN	B3	EARFCN	T3	EARFCN	T2	EARFCN	T1	EARFCN
10	1715.0	132022	1725.0	132122	1735.0	132122	1775.0	132622	n/a	n/a	n/a	n/a

B66 LTE Multiple-Carriers for Band Edge and Spurious Emissions:

Bandwidth, MHz	Transmit / DL, MHz									
	B1	B2	B3	B4	T4	T3	T2	T1		
5	2112.5	2117.5	2122.5	2127.5	2182.5	2187.5	2192.5	2197.5		

Bandwidth, MHz	Receive / UL, MHz									
	B1	B2	B3	B4	T4	T3	T2	T1		
5	1712.5	1717.5	1722.5	1727.5	n/a	n/a	n/a	n/a		

EUT test details, continued

B66 NR Multiple-Carriers for Band Edge and Spurious Emissions:

Bandwidth, MHz	Transmit / DL, MHz								
	B1	NR-ARFCN	B2	NR-ARFCN		T2	NR-ARFCN	T1	NR-ARFCN
10	2115.0	423000	2125.0	425000		2185.0	437000	2195.0	439000

Bandwidth, MHz	Receive / UL, MHz								
	B1	NR-ARFCN	B2	NR-ARFCN		T2	NR-ARFCN	T1	NR-ARFCN
10	1715.0	343000	1725.0	345000		n/a	n/a	n/a	n/a

B66 NR Multiple-Carriers for Band Edge and Spurious Emissions:

Bandwidth, MHz	Transmit / DL, MHz												
	B1	EARFCN	B2	EARFCN	B3	EARFCN		T3	EARFCN	T2	EARFCN	T1	EARFCN
10	2115.0	423000	2125.0	425000	2135.0	427000		2175.0	435000	2185.0	437000	2195.0	439000

Bandwidth, MHz	Receive / UL, MHz												
	B1	EARFCN	B2	EARFCN	B3	EARFCN		T3	EARFCN	T2	EARFCN	T1	EARFCN
10	1715.0	343000	1725.0	345000	1735.0	347000		1775.0	355000	n/a	n/a	n/a	n/a

B66 NR Multiple-Carriers for Band Edge and Spurious Emissions:

Bandwidth, MHz	Transmit / DL, MHz								
	B1	B2	B3	B4		T4	T3	T2	T1
5	2112.5	2117.5	2122.5	2127.5		2182.5	2187.5	2192.5	2197.5

Bandwidth, MHz	Receive / UL, MHz								
	B1	B2	B3	B4		T4	T3	T2	T1
5	1712.5	1717.5	1722.5	1727.5		n/a	n/a	n/a	n/a

B25 LTE Multiple-Carriers for spurious emissions (IBW=65MHz):

Bandwidth (MHz)	Transmit / DL (MHz)			
	C1	EARFCN	C2	EARFCN
10	1935.0	8090	1990.0	8640
15	1937.5	8115	1987.5	8615
20	1940.0	8140	1985.0	8590
10	1957.5	8315	1967.5	8415

Bandwidth (MHz)	Receive / UL (MHz)			
	C1	EARFCN	C2	EARFCN
10	1855.0	26090	1910.0	26640
15	1857.5	26115	1907.5	26615
20	1860.0	26140	1905.0	26590
10	1877.5	26315	1887.5	26415

EUT test details, continued

B25 LTE Multiple-Carriers for spurious emissions (IBW=65MHz):

Bandwidth (MHz)	Transmit / DL (MHz)					
	C1	EARFCN	C2	EARFCN	C3	EARFCN
10	1935.0	8090	1945.0	8190	1990.0	8640
15	1937.5	8115	1952.5	8265	1987.5	8615
20	1940.0	8140	1960.0	8340	1985.0	8590
10	1952.5	8265	1962.5	8365	1972.5	8465

Bandwidth (MHz)	Receive / UL (MHz)					
	C1	EARFCN	C2	EARFCN	C3	EARFCN
10	1855.0	26090	1865.0	26190	1910.0	26640
15	1857.5	26115	1872.5	26265	1907.5	26615
20	1860.0	26140	1880.0	26340	1905.0	26590
10	1872.5	26265	1882.5	26365	1892.5	26465

B25 LTE Multiple-Carriers for spurious emissions (IBW=65MHz):

Bandwidth (MHz)	Transmit / DL (MHz)							
	C1	EARFCN	C2	EARFCN	C3	EARFCN	C4	EARFCN
5	1932.5	8065	1937.5	8115	1962.5	8365	1992.5	8665
5	1955.0	8290	1960.0	8340	1965.0	8390	1970.0	8440

Bandwidth (MHz)	Receive / UL (MHz)							
	C1	EARFCN	C2	EARFCN	C3	EARFCN	C4	EARFCN
5	1852.5	26065	1857.5	26115	1882.5	26365	1912.5	26665
5	1875.0	26290	1880.0	26340	1885.0	26390	1890.0	26440

B25 NR Multiple-Carriers for spurious emissions (IBW=65MHz):

Bandwidth (MHz)	Transmit / DL (MHz)			
	C1	NR-ARFCN	C2	NR-ARFCN
10	1935.0	387000	1990.0	398000
15	1937.5	387500	1987.5	397500
20	1940.0	388000	1985.0	397000
10	1957.5	391500	1967.5	393500

Bandwidth (MHz)	Receive / UL (MHz)			
	C1	NR-ARFCN	C2	NR-ARFCN
10	1855.0	371000	1910.0	382000
15	1857.5	371500	1907.5	381500
20	1860.0	372000	1905.0	381000
10	1877.5	375500	1887.5	377500

B25 NR Multiple-Carriers for spurious emissions (IBW=65MHz):

Bandwidth (MHz)	Transmit / DL (MHz)					
	C1	NR-ARFCN	C2	NR-ARFCN	C3	NR-ARFCN
10	1935.0	387000	1945.0	389000	1990.0	398000
15	1937.5	387500	1952.5	390500	1987.5	397500
20	1940.0	388000	1960.0	392000	1985.0	397000
10	1952.5	390500	1962.5	392500	1972.5	394500

Bandwidth (MHz)	Receive / UL (MHz)					
	C1	NR-ARFCN	C2	NR-ARFCN	C3	NR-ARFCN
10	1855.0	371000	1865.0	373000	1910.0	382000
15	1857.5	371500	1872.5	374500	1907.5	381500
20	1860.0	372000	1880.0	376000	1905.0	381000
10	1872.5	374500	1882.5	376500	1892.5	378500

EUT test details, continued

B25 NR Multiple-Carriers for spurious emissions (IBW=65MHz):

Bandwidth (MHz)	Transmit / DL (MHz)							
	C1	NR-ARFCN	C2	NR-ARFCN	C3	NR-ARFCN	C4	NR-ARFCN
5	1932.5	386500	1937.5	387500	1962.5	392500	1992.5	398500
5	1955	391000	1960	392000	1965	393000	1970	394000

Bandwidth (MHz)	Receive / UL (MHz)							
	C1	NR-ARFCN	C2	NR-ARFCN	C3	NR-ARFCN	C4	NR-ARFCN
5	1852.5	370500	1857.5	371500	1882.5	376500	1912.5	382500
5	1875.0	375000	1880.0	376000	1885.0	377000	1890.0	378000

B66 LTE Multiple-Carriers for spurious emissions (IBW=90MHz)

Bandwidth (MHz)	Transmit / DL (MHz)			
	C1	EARFCN	C2	EARFCN
10	2115.0	66486	2175.0	67086
15	2117.5	66511	2172.5	67061
20	2120.0	66536	2170.0	67036
10	2150.0	66836	2160.0	66936

Bandwidth (MHz)	Receive / UL (MHz)			
	C1	EARFCN	C2	EARFCN
5	1712.5	131997	n/a	n/a
10	1715.0	132022	n/a	n/a
15	1717.5	132047	n/a	n/a
20	1720.0	132072	n/a	n/a
10	1750.0	132372	1760.0	132472

B66 LTE Multiple-Carriers for spurious emissions (IBW=90MHz):

Bandwidth (MHz)	Transmit / DL (MHz)					
	C1	EARFCN	C2	EARFCN	C3	EARFCN
10	2115.0	66486	2125.0	66586	2195.0	67286
15	2117.5	66511	2132.5	66661	2192.5	67261
20	2120.0	66536	2140.0	66736	2190.0	67236
10	2145.0	66786	2155.0	66886	2165.0	66986

Bandwidth (MHz)	Receive / UL (MHz)					
	C1	EARFCN	C2	EARFCN	C3	EARFCN
10	1715.0	132022	1725.0	132122	n/a	n/a
15	1717.5	132047	1732.5	132197	n/a	n/a
20	1720.0	132072	1740.0	132272	n/a	n/a
10	1745.0	132322	1755.0	132422	1765.0	132522

EUT test details, continued

B66 LTE Multiple-Carriers for spurious emissions (IBW=90MHz):

Bandwidth (MHz)	Transmit / DL (MHz)							
	C1	EARFCN	C2	EARFCN	C3	EARFCN	C4	EARFCN
5	2112.5	66461	2117.5	66511	2155.0	66886	2197.5	67311
5	2147.5	66811	2152.5	66861	2157.5	66911	2162.5	66961

Bandwidth (MHz)	Receive / UL (MHz)							
	C1	EARFCN	C2	EARFCN	C3	EARFCN	C4	EARFCN
5	1712.5	131997	1717.5	132047	1755.0	132422	n/a	n/a
5	1747.5	132347	1752.5	132397	1757.5	132447	1762.5	132497

B66 NR Multiple-Carriers for spurious emissions (IBW=90MHz):

Bandwidth (MHz)	Transmit / DL (MHz)			
	C1	NR-ARFCN	C2	NR-ARFCN
10	2115.0	423000	2195.0	439000
15	2117.5	423500	2192.5	438500
20	2120.0	424000	2190.0	438000
10	2150.0	430000	2160.0	432000

Bandwidth (MHz)	Receive / UL (MHz)			
	C1	NR-ARFCN	C2	NR-ARFCN
10	1715.0	343000	n/a	n/a
15	1717.5	343500	n/a	n/a
20	1720.0	344000	n/a	n/a
10	1750.0	350000	1760.0	352000

B66 NR Multiple-Carriers for spurious emissions (IBW=90MHz):

Bandwidth (MHz)	Transmit / DL (MHz)					
	C1	NR-ARFCN	C2	NR-ARFCN	C3	NR-ARFCN
10	2115.0	423000	2125.0	425000	2195.0	439000
15	2117.5	423500	2132.5	426500	2192.5	438500
20	2120.0	424000	2140.0	428000	2190.0	438000
10	2145.0	429000	2155.0	431000	2165.0	433000

Bandwidth (MHz)	Receive / UL (MHz)					
	C1	NR-ARFCN	C2	NR-ARFCN	C3	NR-ARFCN
10	1715.0	343000	1725.0	345000	n/a	n/a
15	1717.5	343500	1732.5	346500	n/a	n/a
20	1720.0	344000	1740.0	348000	n/a	n/a
10	1745.0	349000	1755.0	351000	1765.0	353000

B66 NR Multiple-Carriers for spurious emissions (IBW=90MHz):

Bandwidth (MHz)	Transmit / DL (MHz)							
	C1	NR-ARFCN	C2	NR-ARFCN	C3	NR-ARFCN	C4	NR-ARFCN
5	2112.5	422500	2117.5	423500	2155.0	431000	2197.5	439500
5	2147.5	429500	2152.5	430500	2157.5	431500	2162.5	432500

Bandwidth (MHz)	Receive / UL (MHz)							
	C1	NR-ARFCN	C2	NR-ARFCN	C3	NR-ARFCN	C4	NR-ARFCN
5	1712.5	342500	1717.5	343500	1755.0	351000	n/a	n/a
5	1747.5	349500	1752.5	350500	1757.5	351500	1762.5	352500

EUT test details, continued

B25 Carrier Configurations for PWR/PSD, BE, CSE, OBW:

B25 - Single Carrier NR

Carrier configurations	Transmit / DL, MHz
25MHz, Bottom	1942.5
25MHz, Middle	1962.5
25MHz, Top	1982.5
30MHz, Bottom	1945
30MHz, Middle	1962.5
30MHz, Top	1980
40MHz, Bottom	1950
40MHz, Middle	1962.5
40MHz, Top	1975

B25 - Multiple-Carriers NR, LTE+NR

Carrier configurations	Transmit / DL, MHz
2C, NR + NR 25MHz, Bottom	1942.5 + 1967.5
2C, NR + NR 25MHz, Middle	1950 + 1975
2C, NR + NR 25MHz, Top	1982.5 + 1957.5
2C, NR + NR 30MHz, Bottom	1945 + 1975
2C, NR + NR 30MHz, Top	1980 + 1950
2C, NR + NR 30MHz, Bottom	1945 + 1980
2C, NR + NR 30MHz, Top	1980 + 1945
2C, NR + NR 1x40MHz, 1x25MHz, Bottom	1950 + 1982.5
2C, NR + NR 1x40MHz, 1x25MHz, Top	1975 + 1942.5
2C, NR 25MHz + LTE 5MHz, Bottom	1942.5 + 1957.5
2C, NR 25MHz + LTE 5MHz, Top	1982.5 + 1967.5
2C, B25 NR 25MHz, Top; B66 NR 25MHz, Bottom	1982.5 + 2122.5
3C, NR 2x25MHz + NR 5MHz, Bottom	1942.5 + 1967.5 + 1992.5
3C, NR 2x25MHz + NR 5MHz, Top	1982.5 + 1957.5 + 1932.5
2C, LTE 5MHz + NR 25MHz, Bottom	1932.5 + 1947.5
2C, LTE 5MHz + NR 25MHz, Top	1992.5 + 1977.5
2C, LTE 15MHz + NR 25MHz, Bottom	1937.5 + 1957.5
2C, LTE 15MHz + NR 25MHz, Top	1987.5 + 1967.5
3C, NR 25 MHz + LTE 5MHz + NR25 MHz, Bottom	1942.5 + 1962.5 + 1982.5
3C, NR 25 MHz + LTE 5MHz + NR25 MHz, Top	1982.5 + 1962.5 + 1942.5

EUT test details, continued

B66 Carrier Configurations for PWR/PSD, BE, CSE, OBW:**B66 - Single Carrier LTE, NR**

Carrier configurations	Transmit / DL, MHz
25MHz, Bottom	2122.5
25MHz, Middle	2155
25MHz, Top	2187.5
30MHz, Bottom	2125
30MHz, Middle	2155
30MHz, Top	2185
40MHz, Bottom	2130
40MHz, Middle	2155
40MHz, Top	2180

B66 - Multiple-Carriers NR, LTE+NR

Carrier configurations	Transmit / DL, MHz	Carrier configurations	Transmit / DL, MHz
2C, NR + NR 25MHz, Bottom	2122.5 + 2147.5	3C, LTE 20MHz + NR 2x25MHz, Bottom	2122.5 + 2145 + 2167.5
2C, NR + NR 25MHz, Middle	2142.5 + 2167.5	3C, LTE 20MHz + NR 2x25MHz, Top	2187.5 + 2165 + 2142.5
2C, NR + NR 25MHz, Top	2187.5 + 2162.5	4C, NR 3x25MHz, Bottom, 15MHz Top	2122.5 + 2147.5 + 2172.5 + 2192.5
2C, LTE 5MHz + NR 25MHz, Bottom	2112.5 + 2127.5	3C, NR + NR 2x40MHz, 1x5MHz Top	2180 + 2140 + 2117.5
2C, LTE 5MHz + NR 25MHz, Top	2197.5 + 2182.5		
2C, NR + NR 30MHz, Bottom	2125 + 2155		
2C, NR + NR 30MHz, Middle	2140 + 2170		
2C, NR + NR 30MHz, Top	2185 + 2155		
2C, NR + NR 40MHz, Bottom	2130 + 2170		
2C, NR + NR 40MHz, Middle	2135 + 2175		
2C, NR + NR 40MHz, Top	2180 + 2140		
2C, NR + NR 25MHz, Bottom, Top	2122.5 + 2187.5		
2C, B25 NR 25MHz, Top; B66 NR 25MHz, Bottom	1982.5 + 2122.5		
3C, NR + NR 25MHz, Bottom, Middle, Top	2122.5 + 2155 + 2187.5		
3C, NR + NR 25MHz, Bottom	2122.5 + 2147.5 + 2172.5		
3C, NR + NR 25MHz, Middle	2130 + 2155 + 2180		
3C, NR + NR 25MHz, Top	2187.5 + 2162.5 + 2137.5		
3C, NR + NR 2x25MHz, Bottom; 1x25MHz Top	2122.5 + 2147.5 + 2187.5		
3C, NR + NR 2x25MHz, Top; 1x25MHz Bottom	2187.5 + 2162.5 + 2122.5		
3C, NR + NR 30MHz, Bottom	2125 + 2155 + 2185		
3C, NR + NR 30MHz, Middle	2125 + 2155 + 2185		
3C, NR + NR 30MHz, Top	2125 + 2155 + 2185		
3C, NR + NR 2x40MHz, 1x5MHz, Bottom	2130 + 2170 + 2192.5		

3.4 EUT setup diagram

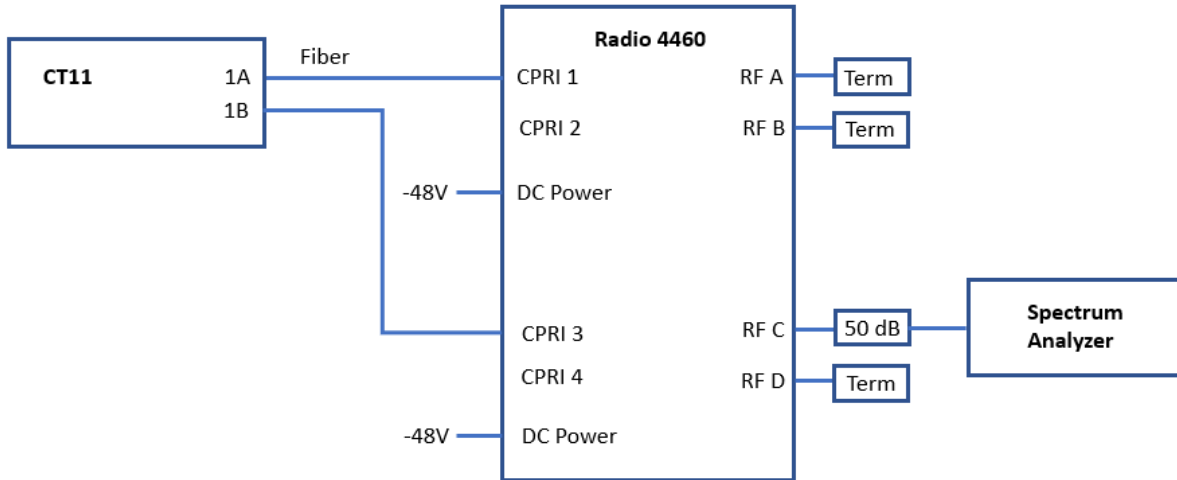

Figure 3.4-1: Setup diagram – Radio Compliance

3.5 Setup photographs

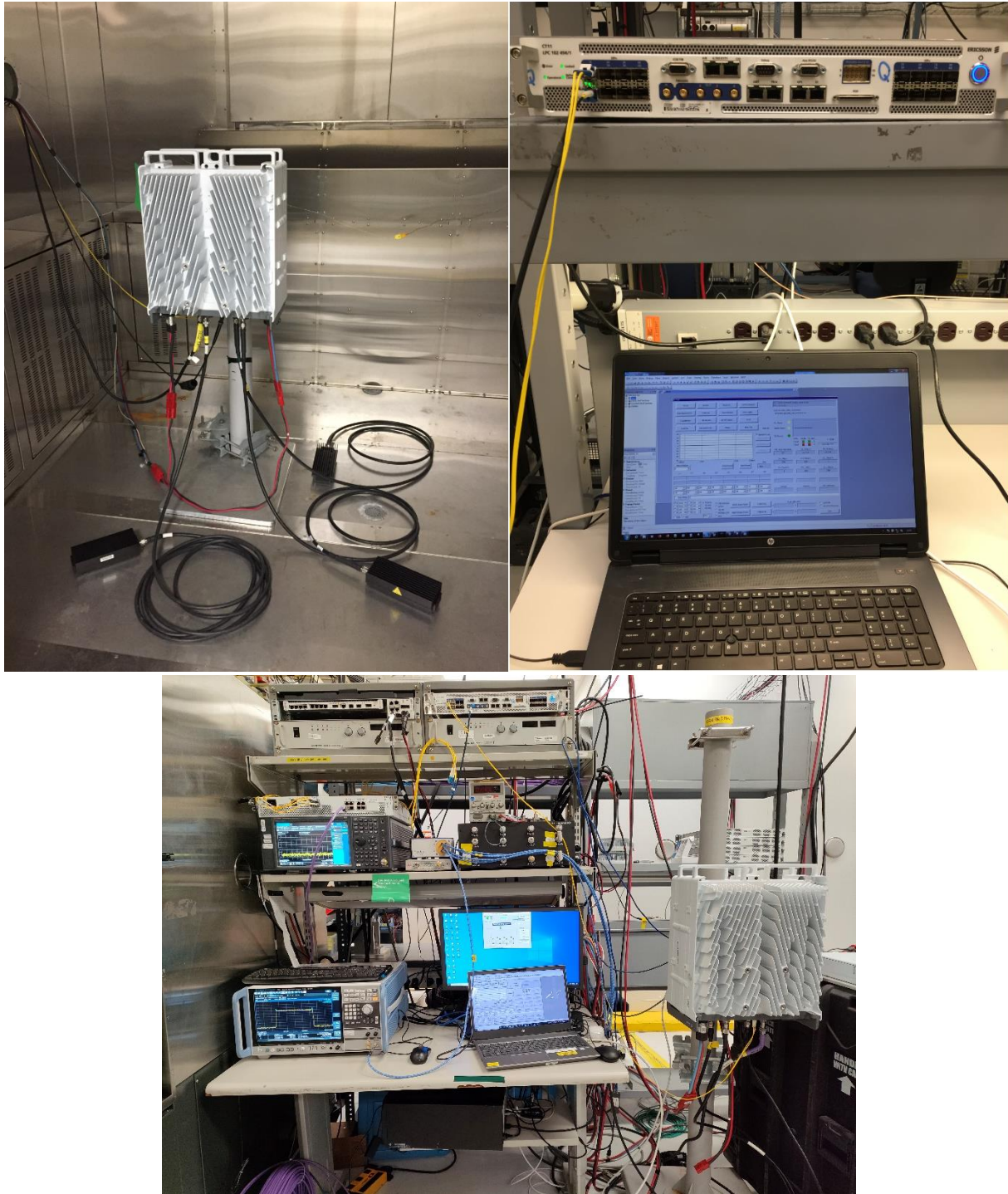

Figure 3.5-1: Set up photo for Radio Compliance Testing

3.6 Setup photographs, continued

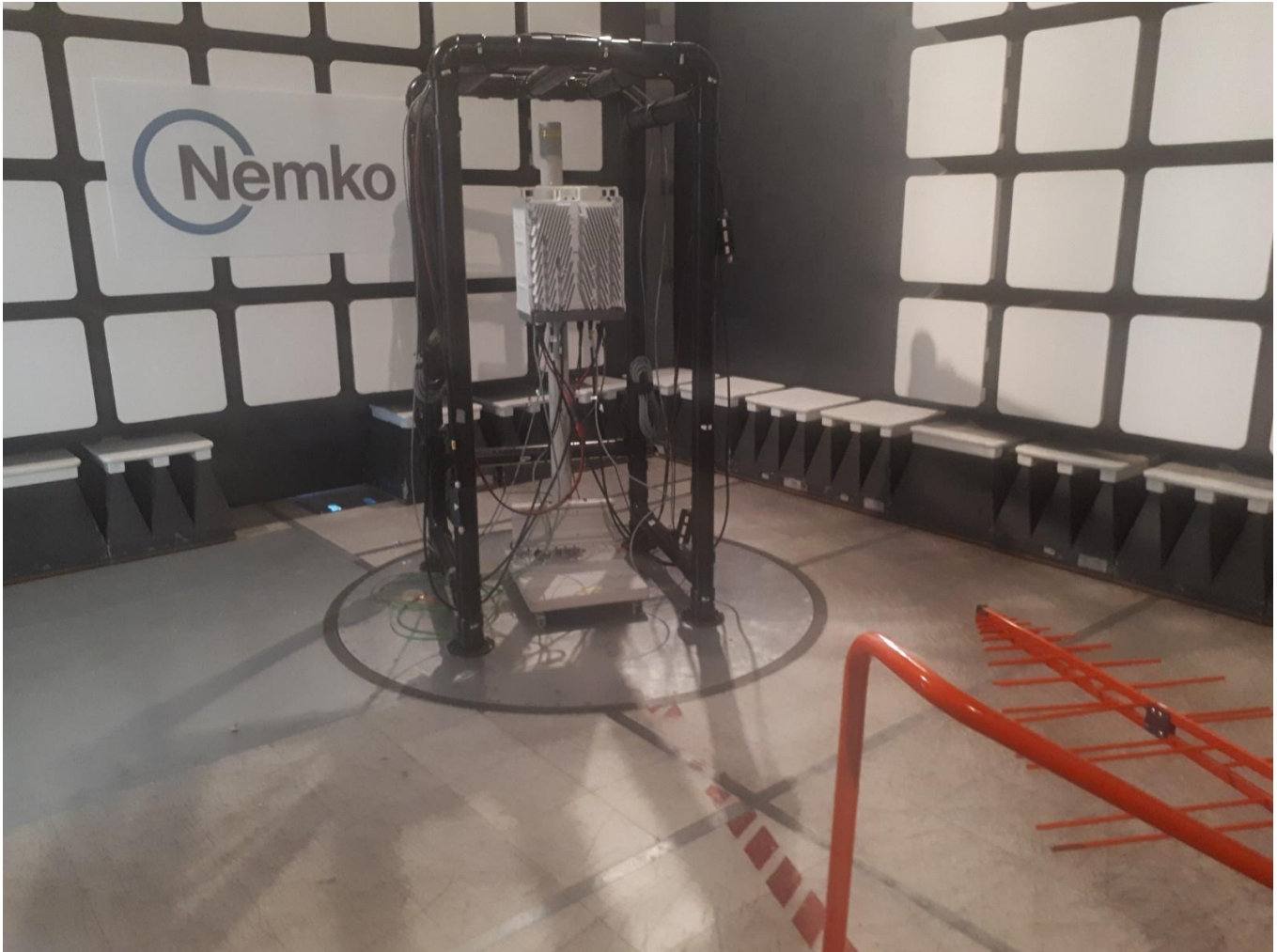

Figure 3.6-1: EUT Set-up photo for Radiated Compliance Testing

Section 4. Engineering considerations

4.1 Modifications incorporated in the EUT

There were no modifications performed to the EUT during this assessment.

4.2 Technical judgment

None

4.3 Deviations from laboratory tests procedures

No deviations were made from laboratory procedures.

Section 5. Test conditions

5.1 Atmospheric conditions

Temperature	15–30 °C
Relative humidity	20–75 %
Air pressure	860–1060 mbar

When it is impracticable to carry out tests under these conditions, a note to this effect stating the ambient temperature and relative humidity during the tests shall be recorded and stated.

5.2 Power supply range

The normal test voltage for equipment to be connected to the mains shall be the nominal mains voltage. For the purpose of the present document, the nominal voltage shall be the declared voltage, or any of the declared voltages $\pm 5\%$, for which the equipment was designed.

Section 6. Measurement uncertainty

6.1 Uncertainty of measurement

Measurement uncertainty budgets for the tests are detailed below. Measurement uncertainty calculations assume a coverage factor of $K = 2$ with 95% certainty.

Test name	Measurement uncertainty, dB
All antenna port measurements	0.55
Conducted spurious emissions	1.13
Radiated spurious emissions	3.78

Section 7. Test equipment

7.1 Test equipment list

Table 7.1-1: Equipment list

Equipment	Manufacturer	Model no.	Asset no.	Cal cycle	Next cal.
3 m EMI test chamber	TDK	SAC-3	FA002047	1 year	20-Jan-23
Flush mount turntable	Sunol	FM2022	FA002082	—	NCR
Controller	Sunol	SC104V	FA002060	—	NCR
Antenna mast	Sunol	TLT2	FA002061	—	NCR
Receiver/spectrum analyzer	Rohde & Schwarz	ESU 26	FA002043	1 year	25-Nov-22
Horn (1–18 GHz)	ETS Lindgren	3117	FA002840	1 year	10-Feb-23
Preamp (1–18 GHz)	ETS Lindgren	124334	FA002873	1 year	22-Sep-22
50 Ω coax cable	C.C.A.	None	FA002556	1 year	24-Apr-22
Horn antenna (18–40 GHz)	EMCO	3116	FA001847	1 year	11-May-22
Pre-amplifier (18–26 GHz)	Narda	BBS-1826N612	FA001550	—	VOU
High pass filter (3-18 GHz)	Thilithic Inc.	6HC3000/18000-1.3-KK	FA002231	1 year	15-Jun-22
Power sensor	Rohde & Schwarz	NRP-Z91	FA002488	1 year	27-May-22
Signal and Spectrum Analyzer	Rhode&Schwarz	FSW50	FA003267	1 year	29-Nov-22
Testing Equipment*	Ericsson	CT11	T01G495060	—	NCR

Notes: NCR - no calibration required, VOU - verify on use.

* Testing equipment (CT11) is the test equipment that drives the radios traffic.

Section 8. Testing data

8.1 Maximum output power at RF antenna connector (Band 66)

8.1.1 Definitions and limits

FCC §27.50(d) Operation within the bands: 2110–2155 MHz and 2155–2180 MHz.

(1) The power of each fixed or base station transmitting in the 1995–2000 MHz, 2110–2155 MHz, 2155–2180 MHz or 2180–2200 MHz band and located in any county with population density of 100 or fewer persons per square mile, based upon the most recently available population statistics from the Bureau of the Census, is limited to:

- (i) An equivalent isotropically radiated power (EIRP) of 3280 watts when transmitting with an emission bandwidth of 1 MHz or less;
- (ii) An EIRP of 3280 watts/MHz when transmitting with an emission bandwidth greater than 1 MHz.

(2) The power of each fixed or base station transmitting in the 1995–2000 MHz, the 2110–2155 MHz 2155–2180 MHz band, or 2180–2200 MHz band and situated in any geographic location other than that described in paragraph (d)(1) of this section is limited to:

- (i) An equivalent isotropically radiated power (EIRP) of 1640 watts when transmitting with an emission bandwidth of 1 MHz or less;
- (ii) An EIRP of 1640 watts/MHz when transmitting with an emission bandwidth greater than 1 MHz.

(3) A licensee operating a base or fixed station in the 2110–2155 MHz band utilizing a power greater than 1640 watts EIRP and greater than 1640 watts/MHz EIRP must coordinate such operations in advance with all Government and non-Government satellite entities in the 2025–2110 MHz band. A licensee operating a base or fixed station in the 2110–2180 MHz band utilizing power greater than 1640 watts EIRP and greater than 1640 watts/MHz EIRP must be coordinated in advance with the following licensees authorized to operate within 120 kilometers (75 miles) of the base or fixed station operating in this band: All Broadband Radio Service (BRS) licensees authorized under this part in the 2155–2160 MHz band and all advanced wireless services (AWS) licensees authorized to operate on adjacent frequency blocks in the 2110–2180 MHz band.

(5) Equipment employed must be authorized in accordance with the provisions of §24.51. Power measurements for transmissions by stations authorized under this section may be made either in accordance with a Commission-approved average power technique or in compliance with paragraph (d)(6) of this section. In measuring transmissions in this band using an average power technique, the peak-to-average ratio (PAR) of the transmission may not exceed 13 dB.

(6) Peak transmit power must be measured over any interval of continuous transmission using instrumentation calibrated in terms of an rms-equivalent voltage. The measurement results shall be properly adjusted for any instrument limitations, such as detector response times, limited resolution bandwidth capability when compared to the emission bandwidth, sensitivity, etc., so as to obtain a true peak measurement for the emission in question over the full bandwidth of the channel.

8.1.1 Definitions and limits, continued

RSS-139, Section 4.1

The transmitter power shall be measured in terms of a root-mean-square (RMS) average value.

RSS-139, Section 6.5

Consult SRSP-513 for e.i.r.p. limits on fixed and base stations operating in the band 2110–2180 MHz.

In addition, the peak to average power ratio (PAPR) of the equipment shall not exceed 13 dB for more than 0.1% of the time, using a signal that corresponds to the highest PAPR during periods of continuous transmission.

RSS-170, Section 5.3.1

Consult SRSP-519 for e.i.r.p. limits on ATC base stations operating in the bands 2000–2020 MHz and 2180–2200 MHz.

SRSP-513, Section 5.1

5.1.1 Fixed and base stations

5.1.1.1 For fixed and base stations operating within the frequency range 2110–2180 MHz with a channel bandwidth equal to or less than 1 MHz, the maximum permissible equivalent isotropically radiated power (e.i.r.p.) is 1640 watts with an antenna height above average terrain (HAAT) up to 300 metres.

5.1.1.2 For fixed and base stations operating within the frequency range 2110–2180 MHz with a channel bandwidth greater than 1 MHz, the maximum permissible e.i.r.p. is 1640 watts/MHz e.i.r.p. (i.e. no more than 1640 watts e.i.r.p. in any 1 MHz band segment) with an antenna height above average terrain (HAAT) up to 300 metres.

5.1.1.3 Fixed and base stations located in geographic areas at a distance greater than 26 km from large or medium population centres, and transmitting within the frequency range 2110–2180 MHz, may increase their e.i.r.p. up to a maximum of 3280 watts/MHz (i.e. no more than 3280 watts e.i.r.p. in any 1 MHz band segment), with an antenna HAAT up to 300 metres.

Within 26 km of any large or medium population centre, fixed and base stations may operate at increased e.i.r.p. if more than 50% of the population within a particular sector's coverage is located outside these large and medium population centres.

Fixed and base stations with increased e.i.r.p. must not be used to provide coverage to large and medium population centres. However, some incidental coverage of these large and medium population centres by stations with increased e.i.r.p. is permitted.

This provision also applies for fixed and base stations with a channel bandwidth equal to or less than 1 MHz (i.e. the e.i.r.p. may be increased up to a maximum of 3280 watts).

5.1.1.4 Fixed and base station antenna heights above average terrain may exceed 300 metres with a reduction in e.i.r.p. The maximum permissible e.i.r.p. for installations with antenna HAAT in excess of 300 metres is given in the following table:

Table 8.1-1: Reduction to Maximum Allowable E.I.R.P. for HAAT > 300 m

HAAT (m)	Maximum EIRP, W/MHz
HAAT ≤ 300	1640 (or 3280 ¹)
300 < HAAT ≤ 500	1070
500 < HAAT ≤ 1000	490
1000 < HAAT ≤ 1500	270
1500 < HAAT ≤ 2000	160

Note: ¹for fixed and base stations with a channel bandwidth equal to or less than 1 MHz

8.1.1 Definitions and limits, continued

SRSP-519, Section 5.1

The equivalent isotropically radiated power (e.i.r.p.) of base stations shall not exceed 1640 W when transmitting with an emission bandwidth of 1 MHz or less, and 1640 W/MHz when transmitting with an emission bandwidth greater than 1 MHz.

Base stations located outside of large or medium population may increase their e.i.r.p. to a maximum of 3280 W when transmitting with an emission bandwidth of 1 MHz or less, and to 3280 W/MHz when transmitting with an emission bandwidth greater than 1 MHz.

A licensee operating a base station utilizing an e.i.r.p greater than 1640 W/MHz must coordinate in advance with all AWS-4 licensees authorized to operate on adjacent frequency blocks within the same band.

Base station antenna heights above average terrain may exceed 300 m with a corresponding reduction in e.i.r.p. in accordance with Table above

8.1.2 Test summary

Test date	March 30, 2022
Test engineer	Moustapha Salah Toubeh

8.1.3 Observations, settings, and special notes

Output power was measured with RMS power meter per ANSI C63.26 Paragraph 5.2.4.2 method. PSD was measured using method described in paragraph 5.2.4.4.

- Randomly selected sample plots provided for information and settings only
- Total MIMO PSD was calculated as follows: PSD from one antenna port + $10 \times \text{Log}_{10}(4)$
- RBS (Radio Base Station) EIRP Limits are deployment dependent. To ensure compliance with legal limits detailed in section 8.1.1, RBS set up and carrier configurations are addressed during site commissioning.
- Report results are compiled for the maximum output rated power for worst case emission assessment. EIRP, based on possible beam configuration, indicate the maximum power / worst case beam configuration based on ideal antenna parameters. Customer carrier configuration and power will be limited to comply with legal limits of 1640 W/MHz or 3280 W/MHz during RBS site set up and commissioning. Non-compliant configurations will be restricted to lower carrier power to ensure compliance.
- **To ensure compliance under worst case conditions with maximum output power based on a MIMO configuration, the maximum antenna gain for an RBS (Radio Base Station) system with Radio 4460 44B2/25 44B66 C for band 66 is 18 dBi with 1 dB path loss.**

Spectrum analyzer settings for PSD:

Detector mode	RMS
Resolution bandwidth	1 MHz
Video bandwidth	>RBW
Measurement mode	Power over emission bandwidth
Trace mode	Averaging
Measurement time	Auto

8.1.4 Test data

Table 8.1-2: EIRP calculation based on the worst-case PSD measurement

Frequency, MHz	RF power density, dBm/MHz	Total MIMO PSD, dBm/MHz	Cable loss, dB	Antenna gain, dBi	EIRP PSD, dBm/MHz	EIRP limit, dBm/MHz	Margin, dB
2122.5	36.10	42.12	-1.00	18.00	59.12	62.15	3.03

Table 8.1-3: RF power density measurement results of a single-carrier operation for NR on 25 MHz channel

Frequency, MHz	RF power density, dBm/MHz	Total MIMO PSD, dBm/MHz	EIRP limit, dBm/MHz	Margin, dB
2122.5	36.10	42.12	62.15	20.03
2155.0	35.98	42.00	62.15	20.15
2187.5	35.77	41.79	62.15	20.36

Table 8.1-4: RF power density measurement results of a single-carrier operation for NR on 30 MHz channel

Frequency, MHz	RF power density, dBm/MHz	Total MIMO PSD, dBm/MHz	EIRP limit, dBm/MHz	Margin, dB
2125.0	34.96	40.98	62.15	21.17
2155.0	35.07	41.09	62.15	21.06
2185.0	34.99	41.01	62.15	21.14

Table 8.1-5: RF power density measurement results of a single-carrier operation for NR on 40 MHz channel

Frequency, MHz	RF power density, dBm/MHz	Total MIMO PSD, dBm/MHz	EIRP limit, dBm/MHz	Margin, dB
2130.0	33.91	39.93	62.15	22.22
2155.0	33.85	39.87	62.15	22.28
2180.0	33.95	39.97	62.15	22.18

Table 8.1-6: RF power density measurement results of a two-carrier operation for NR on 25 MHz channel

Notes	dBm/MHz	dBm/MHz	EIRP limit, dBm/MHz	Margin, dB
Bottom	32.73	38.75	62.15	23.40
Top	32.73	38.75	62.15	23.40

Table 8.1-7: RF power density measurement results of a three-carrier operation for NR on 25 MHz channel

Notes	dBm/MHz	dBm/MHz	EIRP limit, dBm/MHz	Margin, dB
Middle	30.99	37.01	62.15	25.14

Table 8.1-8: RF power density measurement results of a four-carrier operation for NR (3 × 25 MHz + 1 × 15 MHz) channel

Frequency, MHz	dBm/MHz	dBm/MHz	EIRP limit, dBm/MHz	Margin, dB
Middle	31.54	37.56	62.15	24.59

Test data, continued

Table 8.1-9: RF total channel power measurement results for NR in Band 66 single carrier operation

Remarks	25 MHz channel		30 MHz channel		40 MHz channel	
	dBm	W	dBm	W	dBm	W
Bottom channel	48.58	72.111	48.74	74.817	48.79	75.683
Mid channel	48.74	74.817	48.82	76.208	48.80	75.858
Top channel	48.48	70.469	48.66	73.451	48.69	73.961

Table 8.1-10: RF total channel power measurement results for NR in Band 66 – multi carrier operation (worst case)

Remarks	25 MHz channel	
	dBm	W
2 carriers - middle	48.50	70.795
3 carriers - middle	48.42	69.502
4 carriers - middle	48.34	68.234

Test data, continued

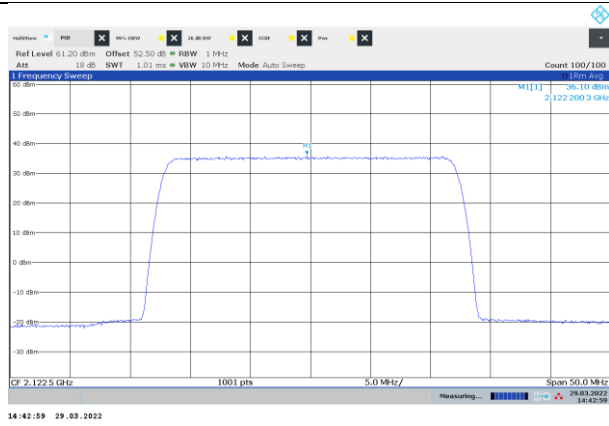

Figure 8.1-1: PSD of NR 25 MHz channel bandwidth, single carrier operation, sample plot, bottom channel

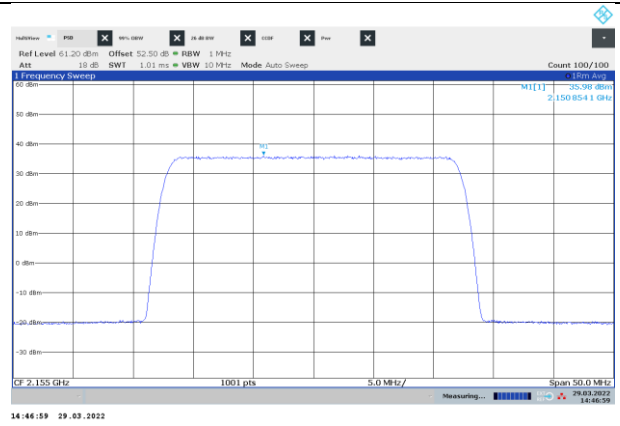

Figure 8.1-2: PSD of NR 25 MHz channel bandwidth, single carrier operation, sample plot, mid channel

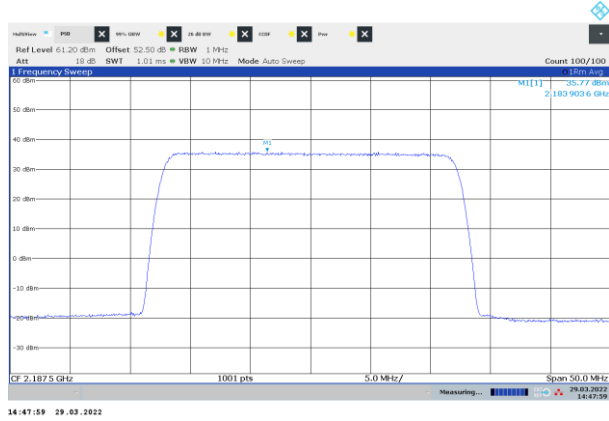

Figure 8.1-3: PSD of NR 25 MHz channel bandwidth, single carrier operation, sample plot, top channel

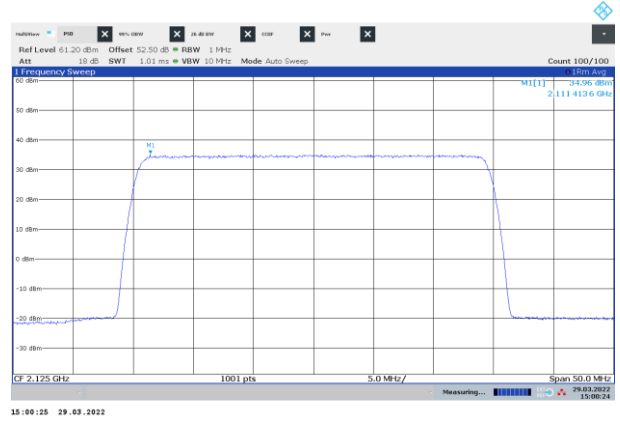

Figure 8.1-4: PSD of NR 30 MHz channel bandwidth, single carrier operation, sample plot, bottom channel

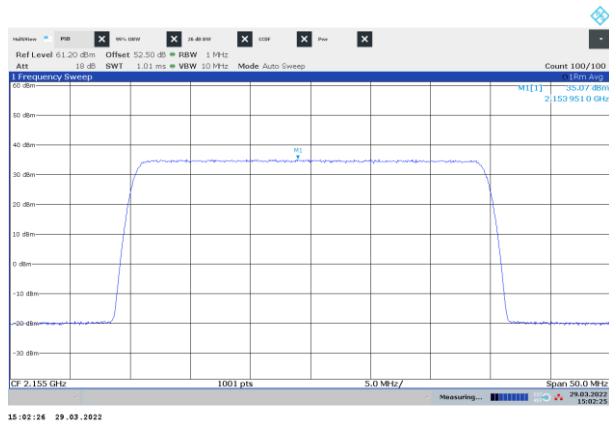

Figure 8.1-5: PSD of NR 30 MHz channel bandwidth, single carrier operation, sample plot, mid channel

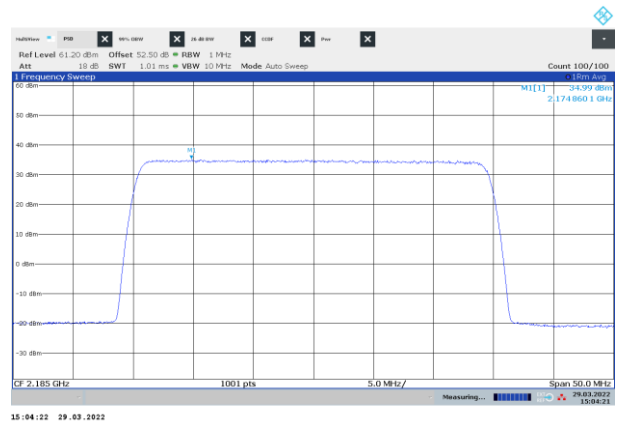

Figure 8.1-6: PSD of NR 30 MHz channel bandwidth, single carrier operation, sample plot, top channel

Test data, continued

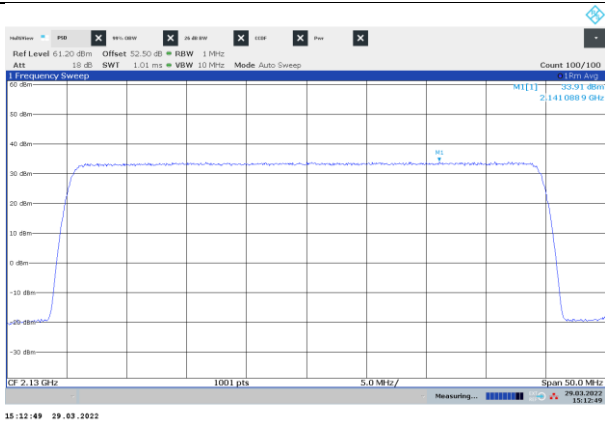

Figure 8.1-7: PSD of NR 40 MHz channel bandwidth, single carrier operation, sample plot, bottom channel

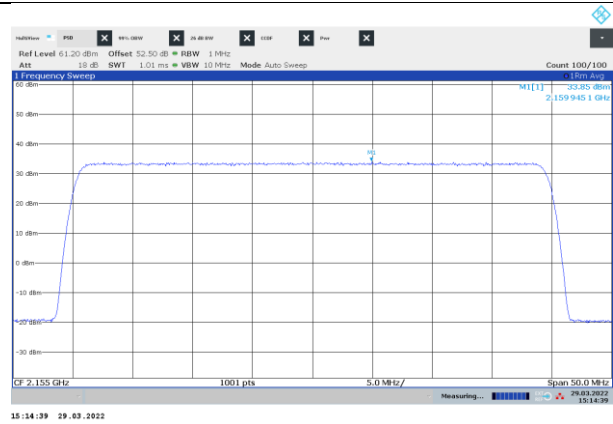

Figure 8.1-8: PSD of NR 40 MHz channel bandwidth, single carrier operation, sample plot, mid channel

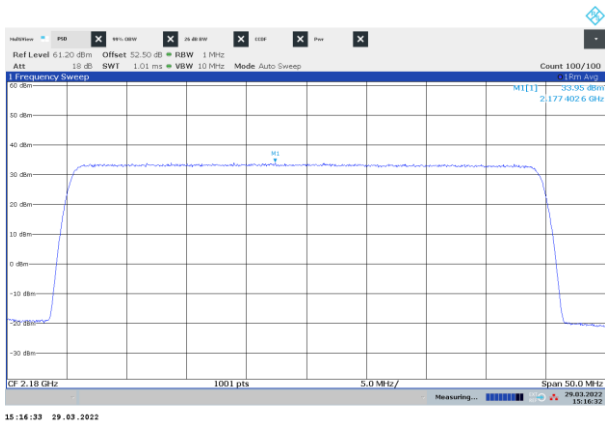

Figure 8.1-9: PSD of NR 40 MHz channel bandwidth, single carrier operation, sample plot, top channel

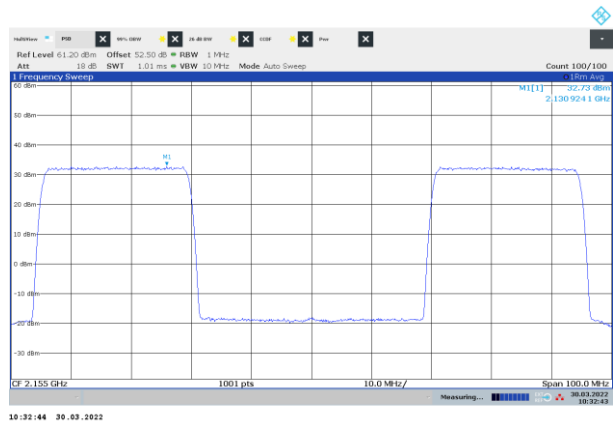

Figure 8.1-10: PSD of NR 25 MHz channel bandwidth, two-carrier operation, sample plot, bottom and top channels

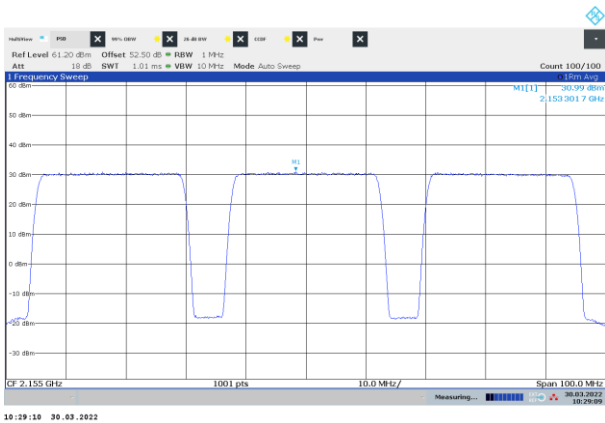

Figure 8.1-11: PSD of NR 25 MHz channel bandwidth, three-carrier operation, sample plot, mid channel



Figure 8.1-12: PSD of NR 25 MHz and 15 MHz channel bandwidth, four-carrier operation (3x 25 MHz + 1x15 MHz), sample plot, mid channel

Test data, continued



Figure 8.1-13: Power of NR 25 MHz channel bandwidth, single carrier operation, sample plot, bottom channel

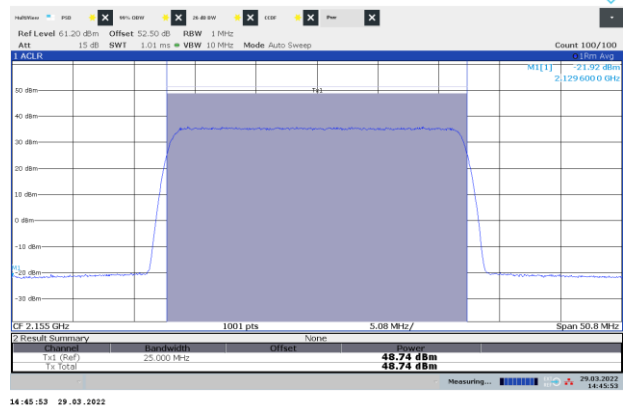

Figure 8.1-14: Power of NR 25 MHz channel bandwidth, single carrier operation, sample plot, mid channel

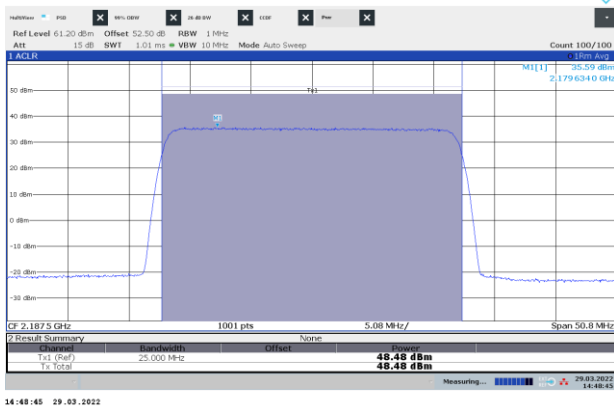

Figure 8.1-15: Power of NR 25 MHz channel bandwidth, single carrier operation, sample plot, top channel

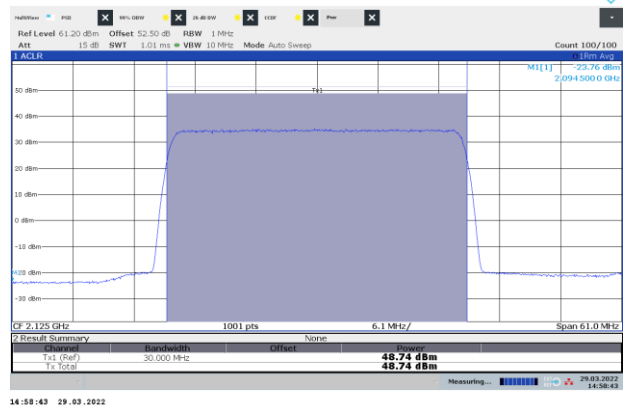

Figure 8.1-16: Power of NR 30 MHz channel bandwidth, single carrier operation, sample plot, bottom channel

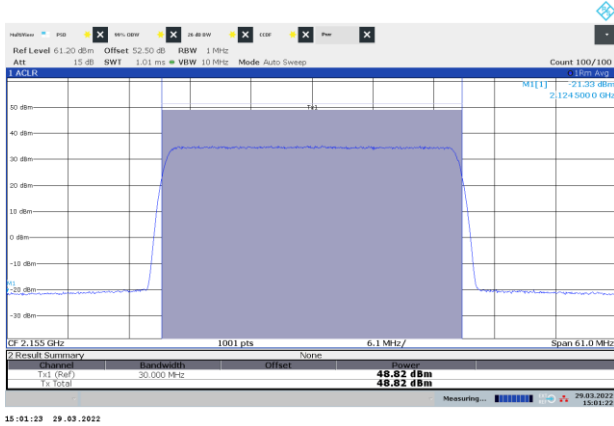

Figure 8.1-17: Power of NR 30 MHz channel bandwidth, single carrier operation, sample plot, mid channel

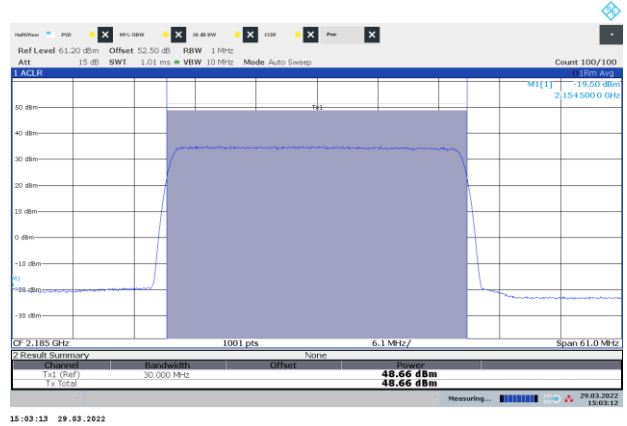

Figure 8.1-18: Power of NR 30 MHz channel bandwidth, single carrier operation, sample plot, top channel

Test data, continued

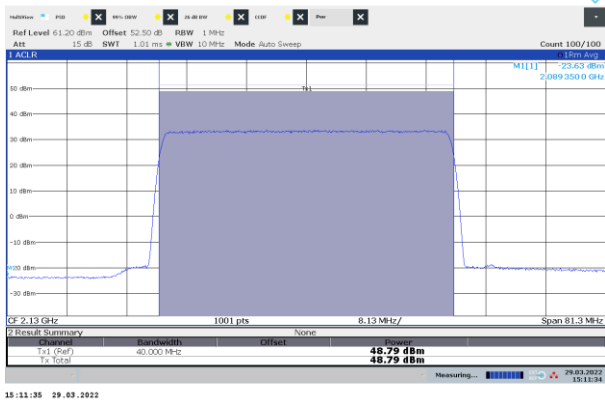

Figure 8.1-19: Power of NR 40 MHz channel bandwidth, single carrier operation, sample plot, bottom channel

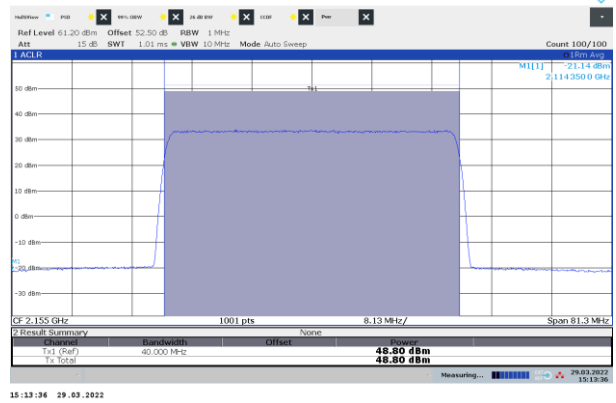

Figure 8.1-20: Power of NR 40 MHz channel bandwidth, single carrier operation, sample plot, mid channel

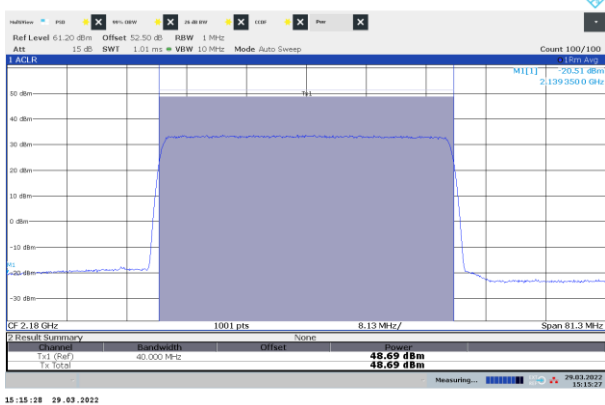

Figure 8.1-21: Power of NR 40 MHz channel bandwidth, single carrier operation, sample plot, top channel

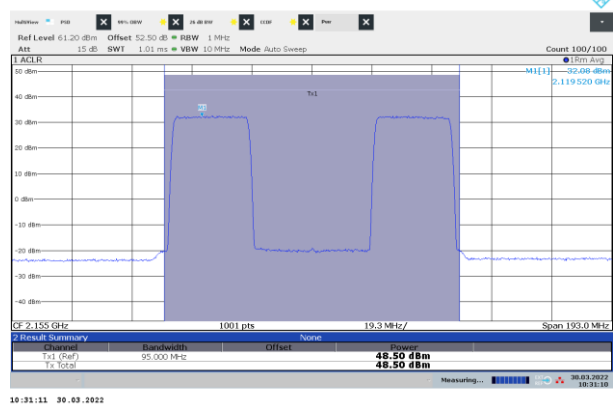

Figure 8.1-22: Power of NR 25 MHz channel bandwidth, two-carrier operation, sample plot, bottom and top channels

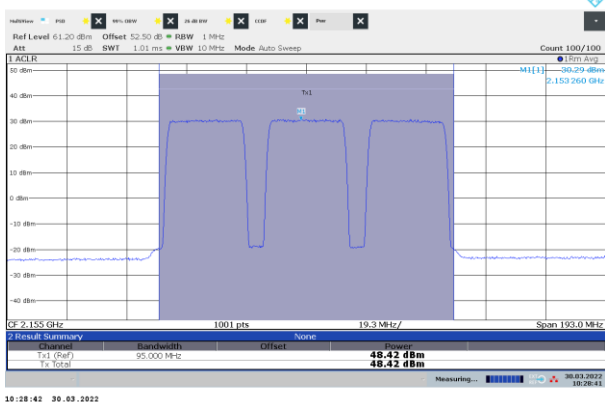

Figure 8.1-23: Power of NR 25 MHz channel bandwidth, three-carrier operation, sample plot, mid channel

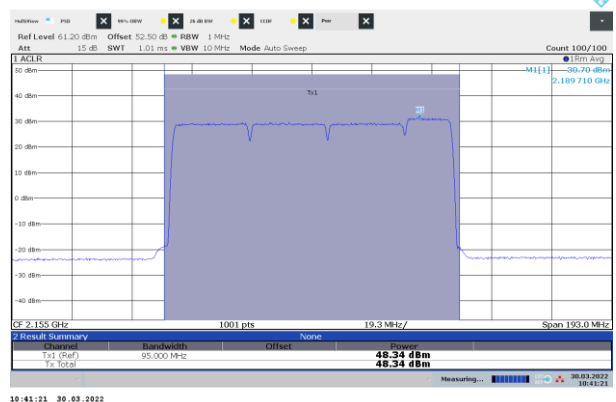

Figure 8.1-24: Power of NR 25 MHz and 15 MHz channel bandwidth, four-carrier operation (3 × 25 MHz + 1 × 15 MHz), sample plot, mid channel

Test data, continued

Table 8.1-11: Complementary Cumulative Distribution Function (CCDF) of the PAPR reduction measurement results for single carrier operation for NR 25 MHz

Remarks	Frequency, MHz	0.1% CCDF, dB	PAPR reduction limit, dB	Margin, dB
25 MHz, Bottom channel	2112.5	8.12	13.00	4.88
25 MHz, Mid channel	2155.0	8.16	13.00	4.84
25 MHz, Top channel	2187.5	8.10	13.00	4.90

Table 8.1-12: Complementary Cumulative Distribution Function (CCDF) of the PAPR reduction measurement results for single carrier operation for NR 30 MHz

Remarks	Frequency, MHz	0.1% CCDF, dB	PAPR reduction limit, dB	Margin, dB
30 MHz, Bottom channel	2125.0	8.14	13.00	4.86
30 MHz, Mid channel	2155.0	8.14	13.00	4.86
30 MHz, Top channel	2185.0	8.10	13.00	4.90

Table 8.1-13: Complementary Cumulative Distribution Function (CCDF) of the PAPR reduction measurement results for single carrier operation for NR 40 MHz

Remarks	Frequency, MHz	0.1% CCDF, dB	PAPR reduction limit, dB	Margin, dB
40 MHz, Bottom channel	2130.0	8.26	13.00	4.74
40 MHz, Mid channel	2155.0	8.26	13.00	4.74
40 MHz, Top channel	2180.0	8.28	13.00	4.72

Test data, continued

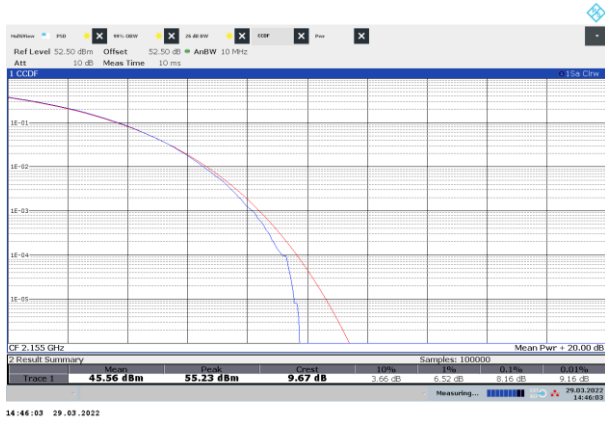

Figure 8.1-25: CCDF sample plot, NR 25 MHz channel bandwidth

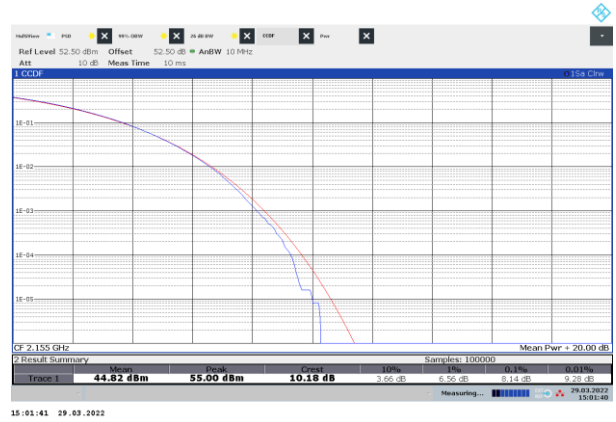

Figure 8.1-26: CCDF sample plot, NR 30 MHz channel bandwidth

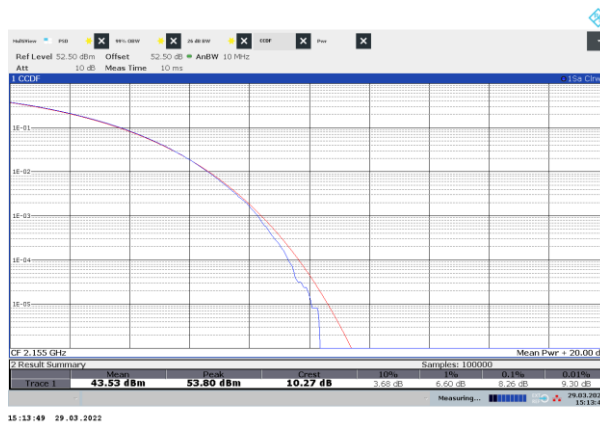

Figure 8.1-27: CCDF sample plot, NR 40 MHz channel bandwidth

8.2 Transmitter output power (EIRP) and antenna height (Band 25)

8.2.1 Definitions and limits

FCC §24.232(a)(2):

Base stations with an emission bandwidth greater than 1 MHz are limited to 1640 watts/MHz equivalent isotropically radiated power (EIRP) with an antenna height up to 300 meters HAAT, except as described in paragraph (b) below.

(2) Base station antenna heights may exceed 300 meters HAAT with a corresponding reduction in power; see table below.

(b)(1) Base stations that are located in counties with population densities of 100 persons or fewer per square mile, based upon the most recently available population statistics from the Bureau of the Census, with an emission bandwidth of 1 MHz or less are limited to 3280 watts equivalent isotropically radiated power (EIRP) with an antenna height up to 300 meters HAAT.

(d) Power measurements for transmissions by stations authorized under this section may be made either in accordance with a Commission-approved average power technique or in compliance with paragraph (e) of this section. In both instances, equipment employed must be authorized in accordance with the provisions of §24.51. In measuring transmissions in this band using an average power technique, the peak-to-average ratio (PAR) of the transmission may not exceed 13 dB.

RSS-133, Section 6.4

The equivalent isotropically radiated power (e.i.r.p.) for transmitters shall not exceed the limits given in SRSP-510.

In addition, the transmitter's peak-to-average power ratio (PAPR) shall not exceed 13 dB for more than 0.1% of the time using a signal corresponding to the highest PAPR during periods of continuous transmission.

SRSP-510, Section 5.1

5.1.1 Base stations

For base stations with a channel bandwidth greater than 1 MHz, the maximum e.i.r.p. is limited to 3280 watts/MHz e.i.r.p. (i.e., no more than 3280 watts e.i.r.p. in any 1 MHz band segment) with an antenna height above average terrain (HAAT) up to 300 metres. Fixed or base stations operating in urban areas are limited to a maximum allowable e.i.r.p. of 1640 watts/MHz e.i.r.p. Base station antenna heights above average terrain may exceed 300 metres with a corresponding reduction in e.i.r.p. according to the following table.

Table 8.2-1: Reduction to Maximum Allowable E.I.R.P. for HAAT > 300 m

HAAT (m)	Maximum EIRP, W/MHz
HAAT ≤ 300	1640
300 < HAAT ≤ 500	1070
500 < HAAT ≤ 1000	490
1000 < HAAT ≤ 1500	270
1500 < HAAT ≤ 2000	160

8.2.2 Test summary

Test date	March 29, 2022
Test engineer	Moustapha Salah Toubeh

8.2.3 Observations, settings, and special notes

Output power was measured with RMS power meter per ANSI C63.26 Paragraph 5.2.4.2 method. PSD was measured using method described in paragraph 5.2.4.4.

- Randomly selected sample plots provided for information and settings only
- Total MIMO PSD was calculated as follows: PSD from one antenna port + $10 \times \text{Log}_{10}(4)$
- There is no MIMO operation with GSM and CDMA
- RBS (Radio Base Station) EIRP Limits are deployment dependent. To ensure compliance with legal limits detailed in section 8.1.2, RBS set up and carrier configurations are addressed during site commissioning.
- Report results are compiled for the maximum output rated power for worst case emission assessment. EIRP, based on possible beam configuration, indicate the maximum power / worst case beam configuration based on ideal antenna parameters. Customer carrier configuration and power will be limited to comply with legal limits of 1640 W/MHz or 3280 W/MHz during RBS site set up and commissioning. Non-compliant configurations will be restricted to lower carrier power to ensure compliance.
- **To ensure compliance under worst case conditions with maximum output power based on a MIMO configuration, the maximum antenna gain for an RBS (Radio Base Station) system with Radio 4460 44B2/25 44B66 C for band 2/25 is 17.5 dBi with 1 dB path loss.**

Spectrum analyzer settings for PSD:

Detector mode	RMS
Resolution bandwidth	1 MHz
Video bandwidth	>RBW
Measurement mode	Power over emission bandwidth
Trace mode	Averaging

8.2.1 Test data

Table 8.2-2: EIRP calculation based on the worst-case PSD measurement

Frequency, MHz	RF power density, dBm/MHz	Total MIMO PSD, dBm/MHz	Cable loss, dB	Antenna gain, dBi	EIRP PSD, dBm/MHz	EIRP limit, dBm/MHz	Margin, dB
1962.5	36.11	42.13	-1.00	17.50	58.63	62.15	3.52

Table 8.2-3: RF power density measurement results of a single-carrier operation for NR on 25 MHz channel

Frequency, MHz	RF power density, dBm/MHz	Total MIMO PSD, dBm/MHz	EIRP limit, dBm/MHz	Margin, dB
1942.5	36.07	42.09	62.15	20.06
1962.5	36.11	42.13	62.15	20.02
1982.5	36.06	42.08	62.15	20.07

Table 8.2-4: RF power density measurement results of a single-carrier operation for NR on 30 MHz channel

Frequency, MHz	RF power density, dBm/MHz	Total MIMO PSD, dBm/MHz	EIRP limit, dBm/MHz	Margin, dB
1945.0	35.37	41.39	62.15	20.76
1962.5	35.31	41.33	62.15	20.82
1980.0	35.23	41.25	62.15	20.90

Table 8.2-5: RF power density measurement results of a single-carrier operation for NR on 40 MHz channel

Frequency, MHz	RF power density, dBm/MHz	Total MIMO PSD, dBm/MHz	EIRP limit, dBm/MHz	Margin, dB
1950.0	34.14	40.16	62.15	21.99
1962.5	34.23	40.25	62.15	21.90
1975.0	34.05	40.07	62.15	22.08

Table 8.2-6: RF power density measurement results of a two-carrier operation for NR on 25 MHz channel

Notes	dBm/MHz	Total MIMO PSD, dBm/MHz	EIRP limit, dBm/MHz	Margin, dB
Middle	32.87	38.89	62.15	23.26

Table 8.2-7: RF power density measurement results of a three-carrier operation for NR on (2*25 MHz+ 1* 15 MHz) channel

Notes	dBm/MHz	dBm/MHz	EIRP limit, dBm/MHz	Margin, dB
Middle	32.23	38.25	62.15	23.90

Table 8.2-8: RF power density measurement results of a two-carrier operation for NR on (1*25 MHz top channel of Band 25+ 1*25 MHz bottom channel of Band 66)

Notes	dBm/MHz	dBm/MHz	EIRP limit, dBm/MHz	Margin, dB
Top channel band 25 + Bottom channel band 66	35.31	41.33	62.15	20.82



Test data, continued

Table 8.2-9: RF total channel power measurement results for NR in Band 25 – single carrier operation

Remarks	25 MHz channel		30 MHz channel		40 MHz channel	
	dBm	W	dBm	W	dBm	W
Bottom channel	48.76	75.162	48.80	75.858	48.90	77.625
Mid channel	48.87	77.090	48.97	78.886	48.98	79.068
Top channel	48.85	76.736	48.88	77.268	48.97	78.886

Table 8.2-10: RF total channel power measurement results for NR in Band 25 – multi-carrier operation (worst case)

Remarks	25 MHz channel	
	dBm	W
2 carriers - middle	48.77	75.336
3 carriers - middle	48.70	74.131

Table 8.2-11: RF total channel power measurement results for NR in Band 25 and 66 – multi-carrier operation (worst case)

Remarks	25 MHz channel	
	dBm	W
2 carriers - top channel band 25 + bottom channel band 66	51.38	137.404

Test data, continued

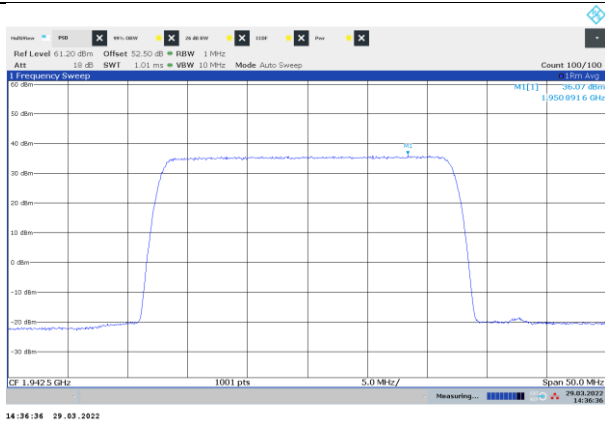

Figure 8.2-1: PSD of NR 25 MHz channel bandwidth, single carrier operation, sample plot, bottom channel

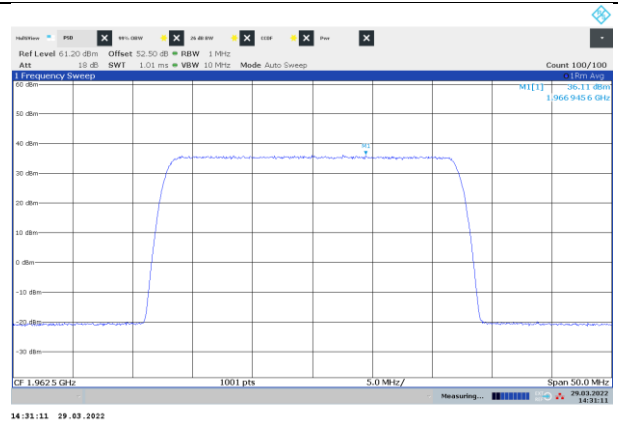

Figure 8.2-2: PSD of NR 25 MHz channel bandwidth, single carrier operation, sample plot, mid channel



Figure 8.2-3: PSD of NR 25 MHz channel bandwidth, single carrier operation, sample plot, top channel

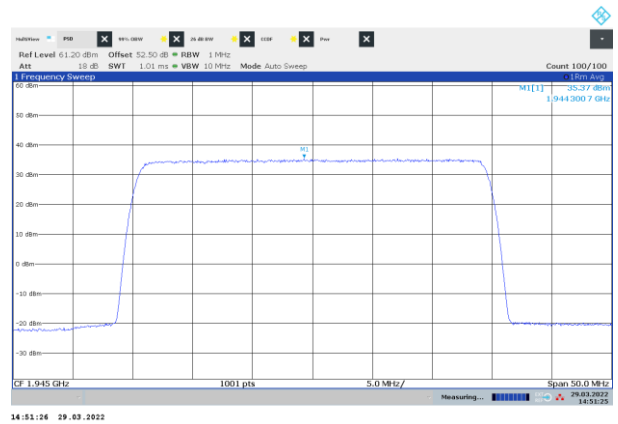

Figure 8.2-4: PSD of NR 30 MHz channel bandwidth, single carrier operation, sample plot, bottom channel

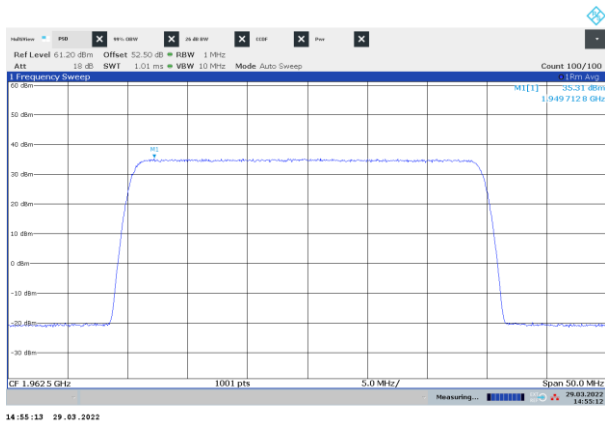

Figure 8.2-5: PSD of NR 30 MHz channel bandwidth, single carrier operation, sample plot, mid channel

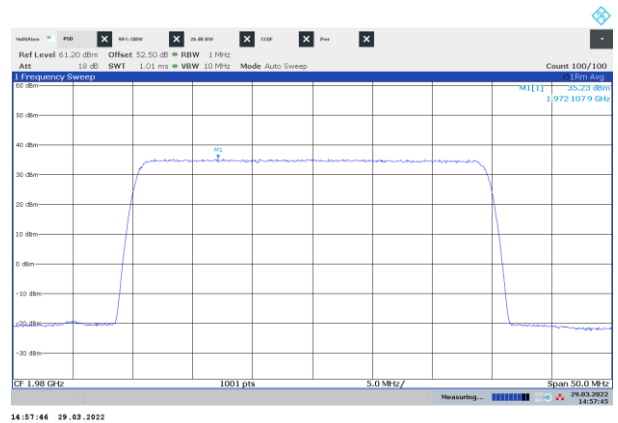

Figure 8.2-6: PSD of NR 30 MHz channel bandwidth, single carrier operation, sample plot, top channel

Test data, continued

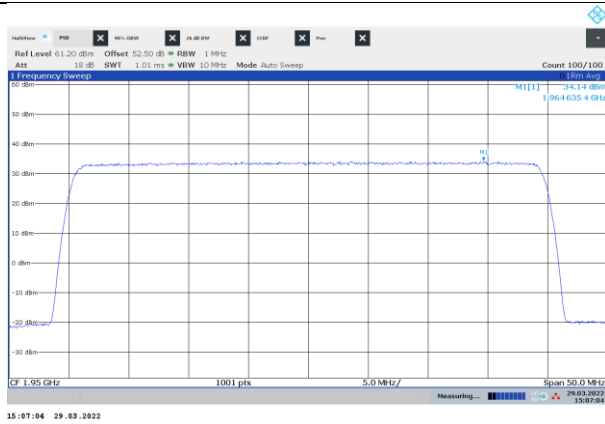

Figure 8.2-7: PSD of NR 40 MHz channel bandwidth, single carrier operation, sample plot, bottom channel

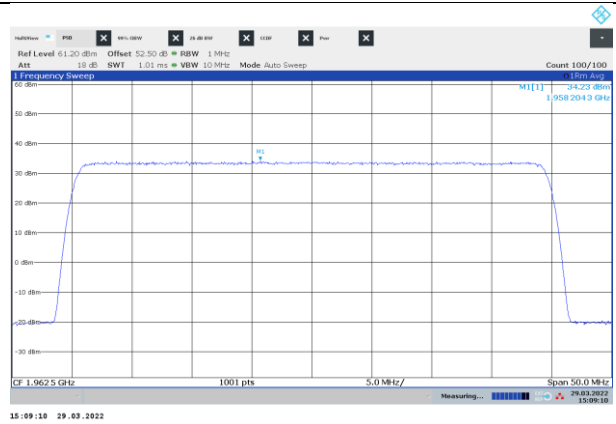

Figure 8.2-8: PSD of NR 40 MHz channel bandwidth, single carrier operation, sample plot, mid channel

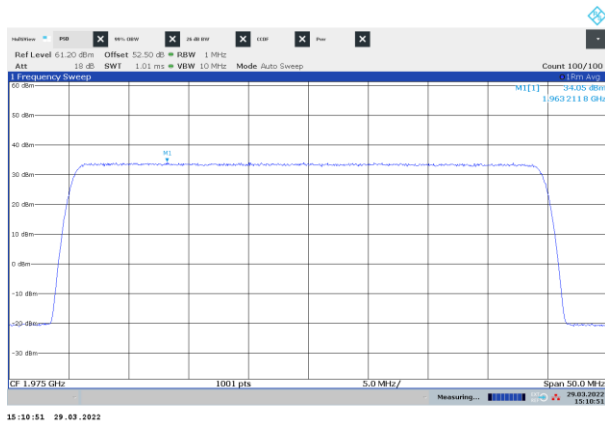

Figure 8.2-9: PSD of NR 40 MHz channel bandwidth, single carrier operation, sample plot, top channel

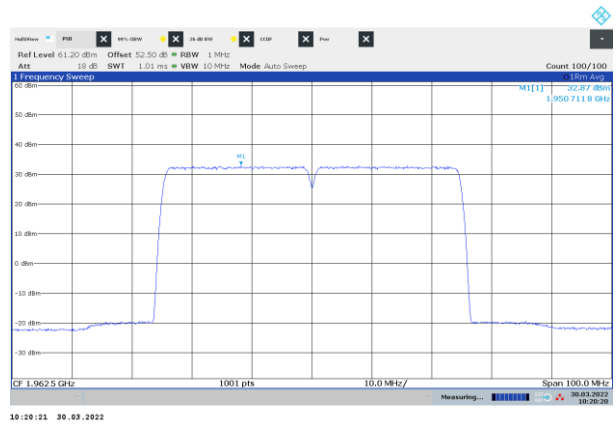

Figure 8.2-10: PSD of NR 25 MHz channel bandwidth, two-carrier operation, sample plot, middle channels

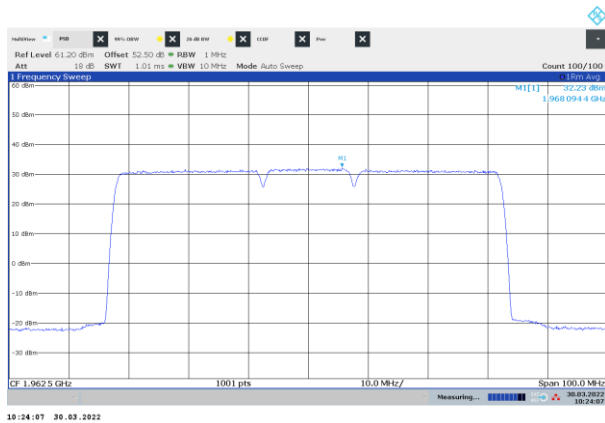

Figure 8.2-11: PSD of NR 25 MHz and 15 MHz channel bandwidth, three-carrier operation (2x 25 MHz + 1x15 MHz), sample plot, mid channel

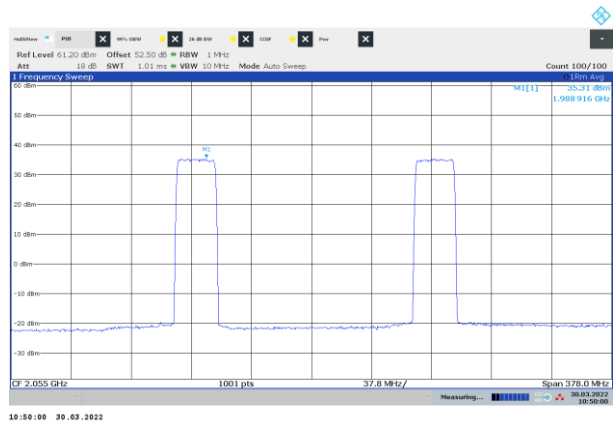

Figure 8.2-12: PSD of NR 25 MHz channel bandwidth, two-carrier operation (1x 25 MHz band 25 + 1x 25 MHz band 66), sample plot, top channel band 25 and bottom channel band 66

Test data, continued

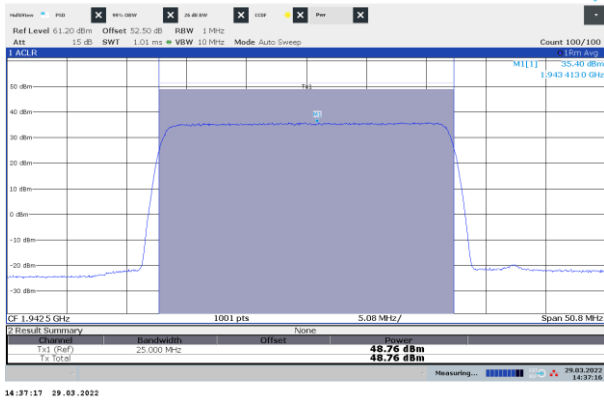

Figure 8.2-13: Power of NR 25 MHz channel bandwidth, single carrier operation, sample plot, bottom channel

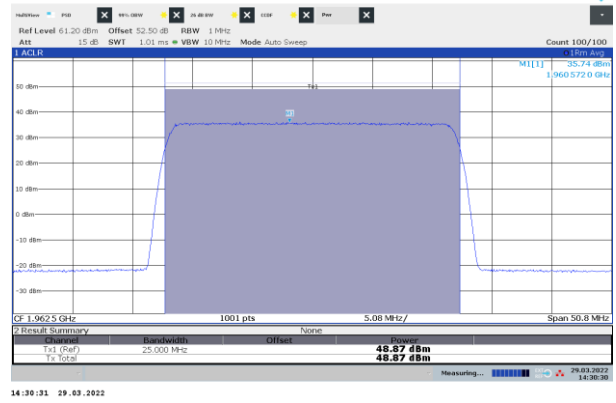

Figure 8.2-14: Power of NR 25 MHz channel bandwidth, single carrier operation, sample plot, mid channel

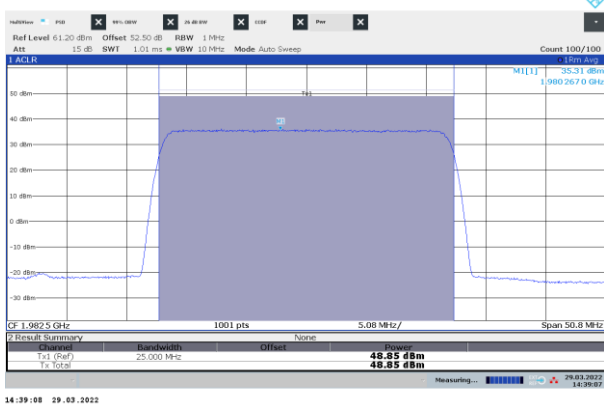

Figure 8.2-15: Power of NR 25 MHz channel bandwidth, single carrier operation, sample plot, top channel

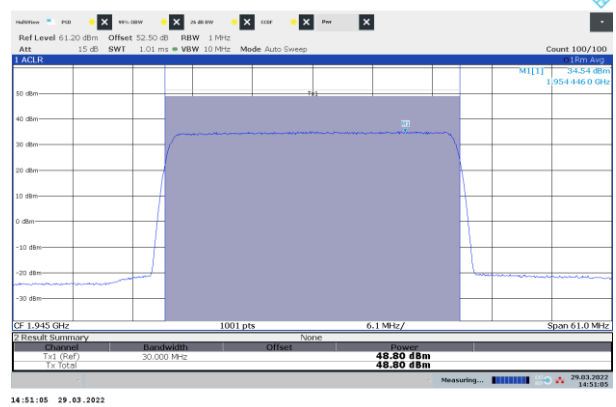

Figure 8.2-16: Power of NR 30 MHz channel bandwidth, single carrier operation, sample plot, bottom channel

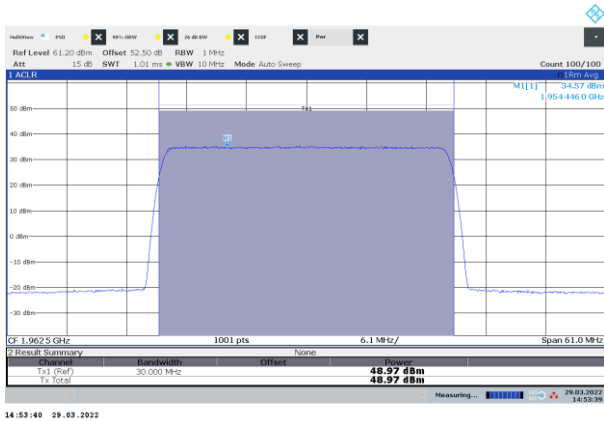

Figure 8.2-17: Power of NR 30 MHz channel bandwidth, single carrier operation, sample plot, mid channel



Figure 8.2-18: Power of NR 30 MHz channel bandwidth, single carrier operation, sample plot, top channel

Test data, continued

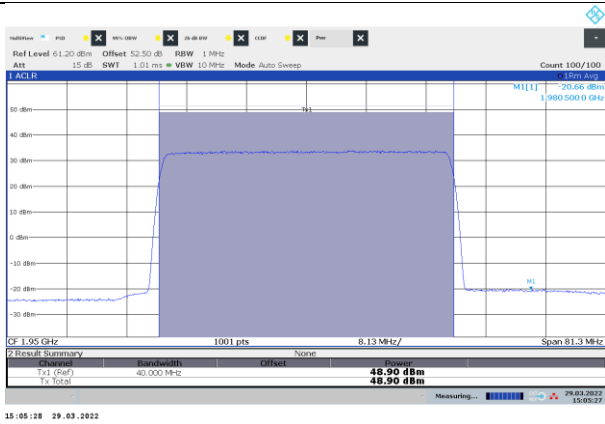

Figure 8.2-19: Power of NR 40 MHz channel bandwidth, single carrier operation, sample plot, bottom channel

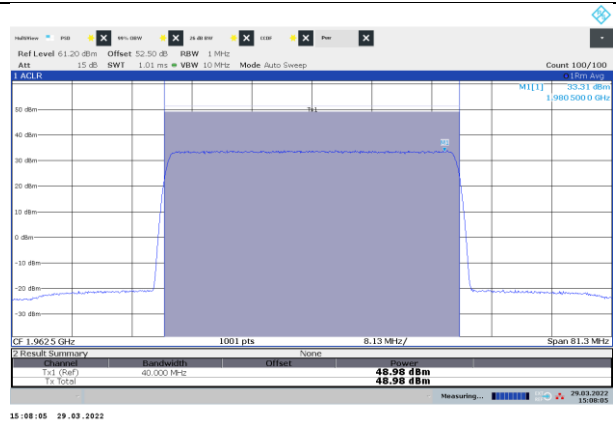

Figure 8.2-20: Power of NR 40 MHz channel bandwidth, single carrier operation, sample plot, mid channel

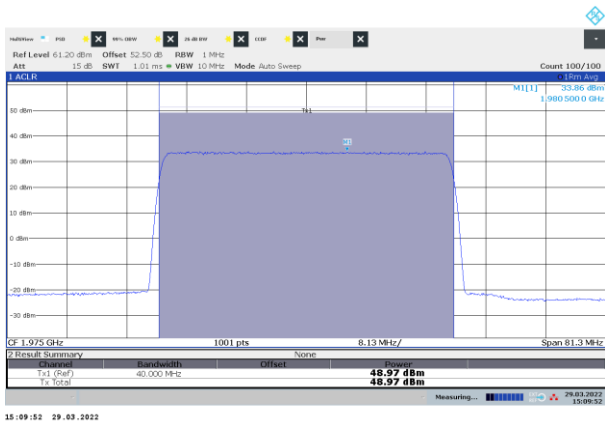

Figure 8.2-21: Power of NR 40 MHz channel bandwidth, single carrier operation, sample plot, top channel



Figure 8.2-22: Power of NR 25 MHz channel bandwidth, two-carrier operation, sample plot, middle channels

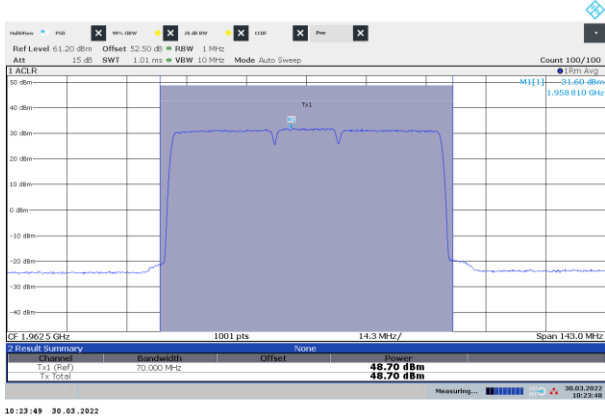

Figure 8.2-23: Power of NR 25 MHz and 15 MHz channel bandwidth, three-carrier operation (2x 25 MHz + 1x15 MHz), sample plot, mid channel

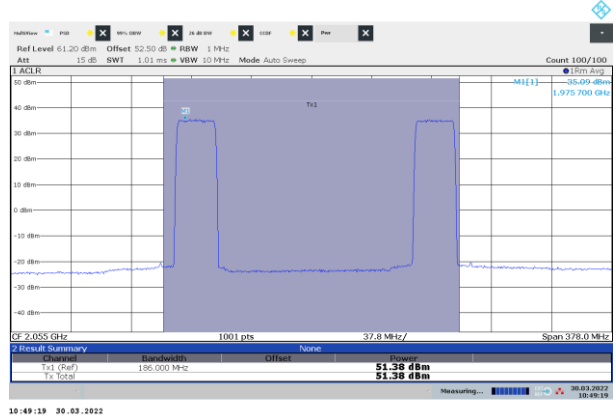

Figure 8.2-24: Power of NR 25 MHz channel bandwidth, two-carrier operation (1x 25 MHz band 25 + 1x 25 MHz band 66), sample plot, top channel band 25 and bottom channel band 66

Test data, continued

Table 8.2-12: Complementary Cumulative Distribution Function (CCDF) of the PAPR reduction measurement results for single carrier operation for NR 25 MHz

Remarks	Frequency, MHz	0.1% CCDF, dB	PAPR reduction limit, dB	Margin, dB
25 MHz, Bottom channel	1942.5	8.16	13.00	4.84
25 MHz, Mid channel	1962.5	8.12	13.00	4.88
25 MHz, Top channel	1982.5	8.18	13.00	4.82

Table 8.2-13: Complementary Cumulative Distribution Function (CCDF) of the PAPR reduction measurement results for single carrier operation for NR 30 MHz

Remarks	Frequency, MHz	0.1% CCDF, dB	PAPR reduction limit, dB	Margin, dB
30 MHz, Bottom channel	1945.0	8.10	13.00	4.90
30 MHz, Mid channel	1962.5	8.16	13.00	4.84
30 MHz, Top channel	1980.0	8.12	13.00	4.88

Table 8.2-14: Complementary Cumulative Distribution Function (CCDF) of the PAPR reduction measurement results for single carrier operation for NR 40 MHz

Remarks	Frequency, MHz	0.1% CCDF, dB	PAPR reduction limit, dB	Margin, dB
40 MHz, Bottom channel	1950.0	8.28	13.00	4.72
40 MHz, Mid channel	1962.5	8.30	13.00	4.70
40 MHz, Top channel	1975.0	8.28	13.00	4.72

Test data, continued

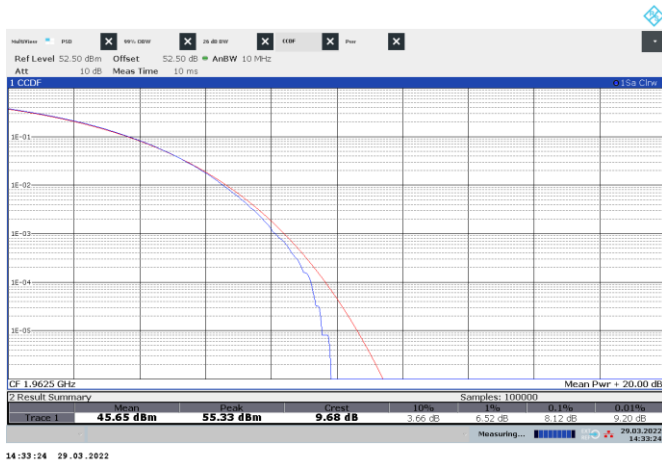

Figure 8.2-25: CCDF sample plot, NR 25 MHz channel bandwidth



Figure 8.2-26: CCDF sample plot, NR 30 MHz channel bandwidth



Figure 8.2-27: CCDF sample plot, NR 40 MHz channel bandwidth

8.3 Spurious emissions at RF antenna connector (Band 66)

8.3.1 Definitions and limits

FCC §27.53:

(h) AWS emission limits

(1) General protection levels. Except as otherwise specified below, for operations in the 1695–1710 MHz, 1710–1755 MHz, 1755–1780 MHz, 1915–1920 MHz, 1995–2000 MHz, 2000–2020 MHz, 2110–2155 MHz, 2155–2180 MHz, and 2180–2200 bands, the power of any emission outside a licensee's frequency block shall be attenuated below the transmitter power (P) in watts by at least $43 + 10 \log_{10}(P)$ dB.

(3) Measurement procedure.

(i) Compliance with this provision is based on the use of measurement instrumentation employing a resolution bandwidth of 1 megahertz or greater. However, in the 1-megahertz bands immediately outside and adjacent to the licensee's frequency block, a resolution bandwidth of at least one percent of the emission bandwidth of the fundamental emission of the transmitter may be employed. The emission bandwidth is defined as the width of the signal between two points, one below the carrier center frequency and one above the carrier center frequency, outside of which all emissions are attenuated at least 26 dB below the transmitter power.

(ii) When measuring the emission limits, the nominal carrier frequency shall be adjusted as close to the licensee's frequency block edges, both upper and lower, as the design permits.

(iii) The measurements of emission power can be expressed in peak or average values, provided they are expressed in the same parameters as the transmitter power.

RSS-139, Section 6.6:

i. In the first 1.0 MHz bands immediately outside and adjacent to the equipment's smallest operating frequency block, which can contain the equipment's occupied bandwidth, the emission power per any 1% of the emission bandwidth shall be attenuated below the transmitter output power P (in dBW) by at least $43 + 10 \log_{10} p$ (watts) dB.

ii. After the first 1.0 MHz outside the equipment's smallest operating frequency block, which can contain the equipment's occupied bandwidth, the emission power in any 1 MHz bandwidth shall be attenuated below the transmitter output power P (in dBW) by at least $43 + 10 \log_{10} p$ (watts) dB.

RSS-170, Section 5.4:

The transmitter unwanted emissions shall be measured for all channel bandwidths with the carrier frequency set at both the highest and lowest channels in which the equipment is designed to operate.

The e.i.r.p. density of unwanted and carrier-off state emissions outlined in this section (Section 5.4) shall be averaged over any 2-ms active transmission using an RMS detector with a resolution bandwidth of 1 MHz for broadband emissions and a resolution bandwidth of 1 kHz for discrete emissions, unless stated otherwise.

For ATC equipment operating in the bands 2000–2020 MHz and 2180–2200 MHz, the unwanted emission limits shall be determined using a measurement bandwidth of 1 MHz or greater. However, in the 1 MHz band immediately outside and adjacent to the equipment's operating frequency block, a resolution bandwidth of at least 1% of the occupied bandwidth may be employed.

5.4.1.2 ATC Base Station Equipment operating in bands 2000–2020 MHz and 2180–2200 MHz

The unwanted emissions of ATC base station equipment transmitting in the bands 2000–2020 MHz and 2180–2200 MHz shall comply with the following:

(1) The power of any unwanted emissions at frequencies outside the equipment's operating frequency block shall be attenuated below the transmitter power P (dBW), by $43 + 10 \log p$ (watts), dB.

(2) *For equipment operating in the band 2180–2200 MHz, in addition to (1), the power of any emissions on all frequencies between 2200 MHz and 2290 MHz shall not exceed an e.i.r.p. of -100.6 dBW/4 kHz (-70.6 dBm/4 kHz).

*** This requirement is for implementation and is enforced at the time of licensing. Therefore, results are not included in this report.**

Requirement number 2 above is amended as detailed in the following ISED document...

<https://www.ic.gc.ca/eic/site/smt-gst.nsf/eng/sf11536.html>

8.3.2 Test summary

Test date	March 29, 2022
Test engineer	Moustapha Salah Toubeh

8.3.3 Observations, settings and special notes

- The spectrum was searched from 30 MHz to the 10th harmonic.
- All measurements were performed using an average (RMS) detector per ANSI C63.26 Paragraph 5.7.2 method.
- Limit line (43 + 10 log₁₀ (P) or -13 dBm) was adjusted for MIMO operation by 6 dB*: -13 dBm - 6 dB = -19 dBm
- *MIMO correction factor for 4 antenna ports: 10 × Log₁₀(4) = 6 dB
- RBW 1 MHz, VBW was wider than RBW

8.3.4 Test data



Figure 8.3-1: Conducted spurious emissions of NR 25 MHz bottom channel, single carrier operation

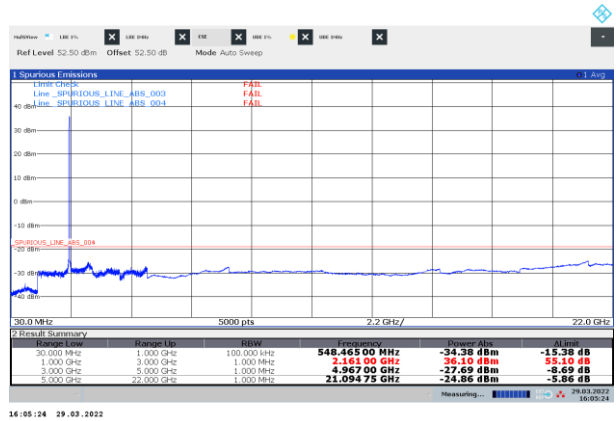

Figure 8.3-2: Conducted spurious emissions of NR 25 MHz mid channel, single carrier operation

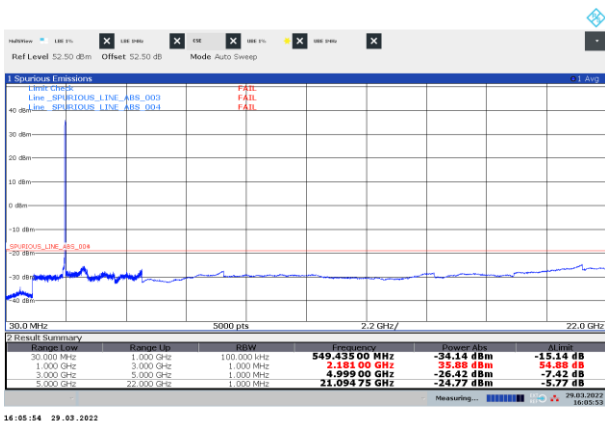

Figure 8.3-3: Conducted spurious emissions of NR 25 MHz top channel, single carrier operation

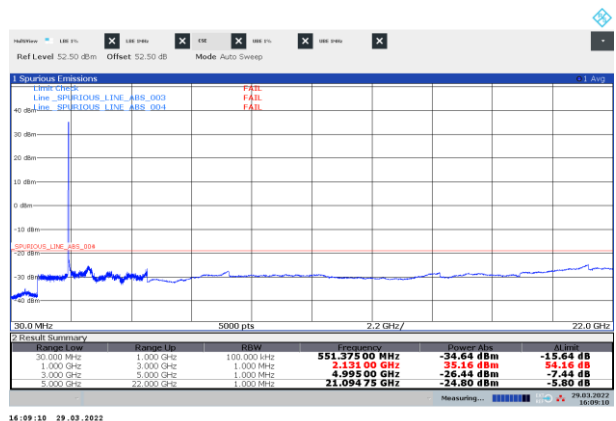

Figure 8.3-4: Conducted spurious emissions of NR 30 MHz bottom channel, single carrier operation

Test data, continued

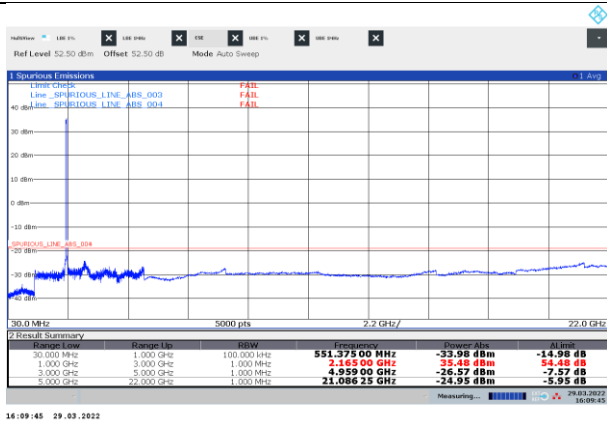

Figure 8.3-5: Conducted spurious emissions of NR 30 MHz mid channel, single carrier operation

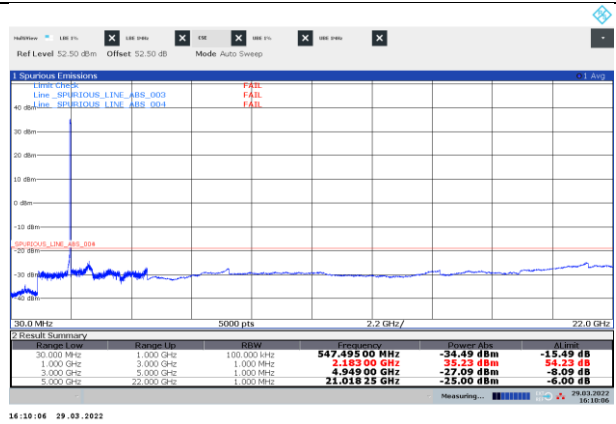

Figure 8.3-6: Conducted spurious emissions of NR 30 MHz top channel, single carrier operation

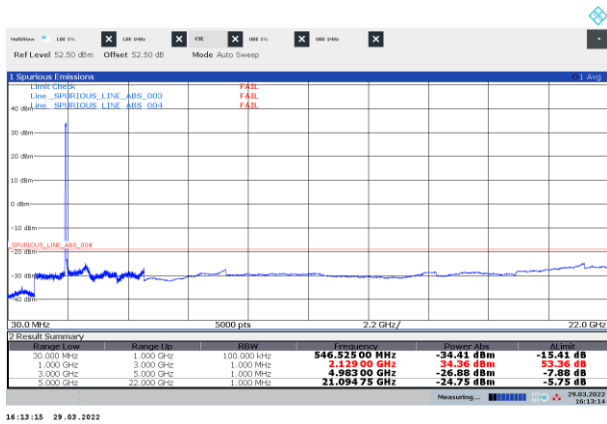

Figure 8.3-7: Conducted spurious emissions of NR 40 MHz bottom channel, single carrier operation

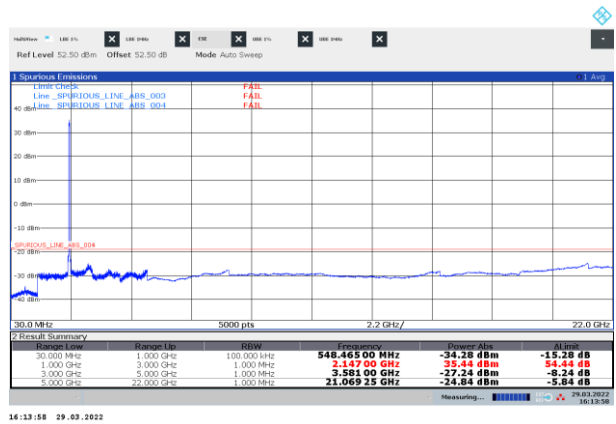

Figure 8.3-8: Conducted spurious emissions of NR 40 MHz mid channel, single carrier operation

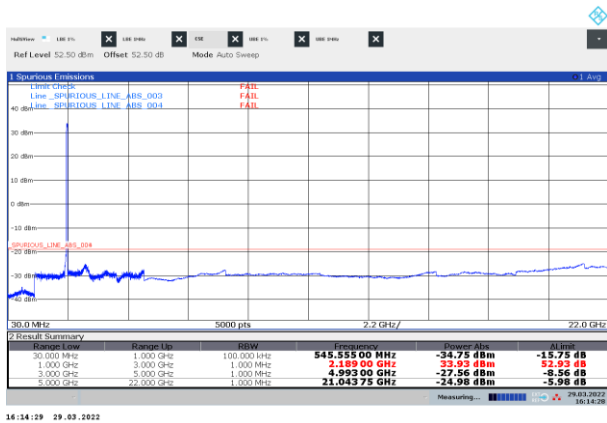

Figure 8.3-9: Conducted spurious emissions of NR 40 MHz top channel, single carrier operation

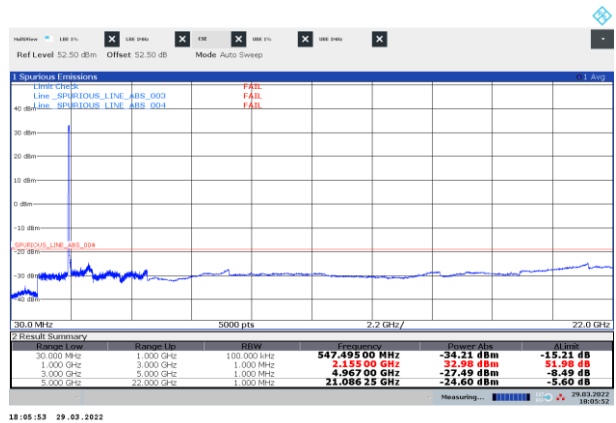

Figure 8.3-10: Conducted spurious emissions of NR 25 MHz two-carrier operation, bottom

Test data, continued

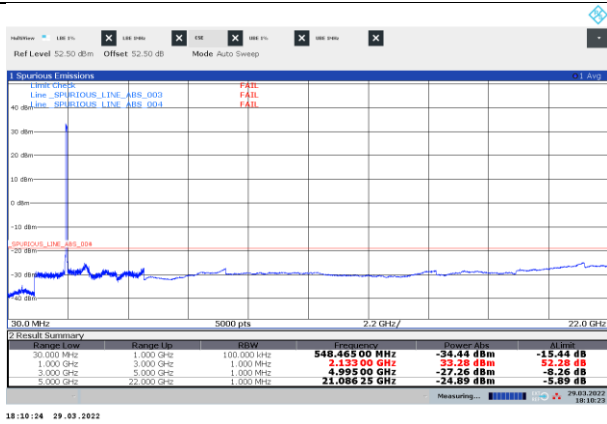

Figure 8.3-11: Conducted spurious emissions of NR 25 MHz two-carrier operation, middle



Figure 8.3-12: Conducted spurious emissions of NR 25 MHz two-carrier operation, top

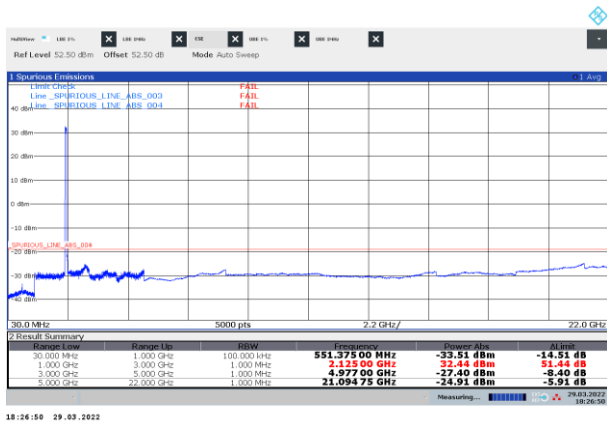

Figure 8.3-13: Conducted spurious emissions of NR 30 MHz two-carrier operation, bottom

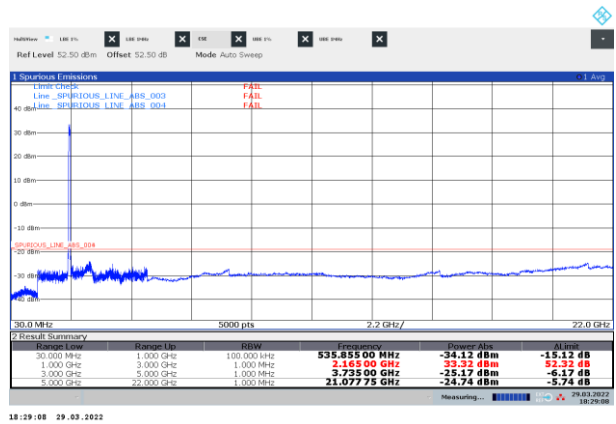

Figure 8.3-14: Conducted spurious emissions of NR 30 MHz two-carrier operation, top

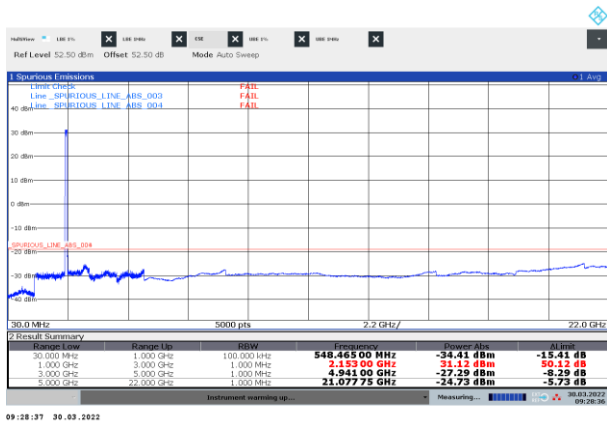

Figure 8.3-15: Conducted spurious emissions of NR 40 MHz two-carrier operation, bottom

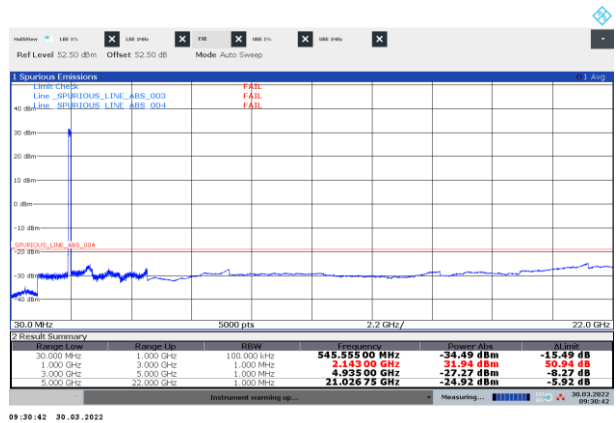

Figure 8.3-16: Conducted spurious emissions of NR 40 MHz two-carrier operation, top

Test data, continued

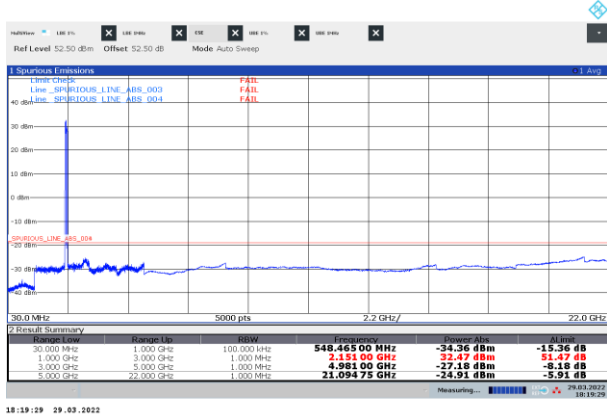

Figure 8.3-17: Conducted spurious emissions of NR 25 MHz three-carrier operation, bottom

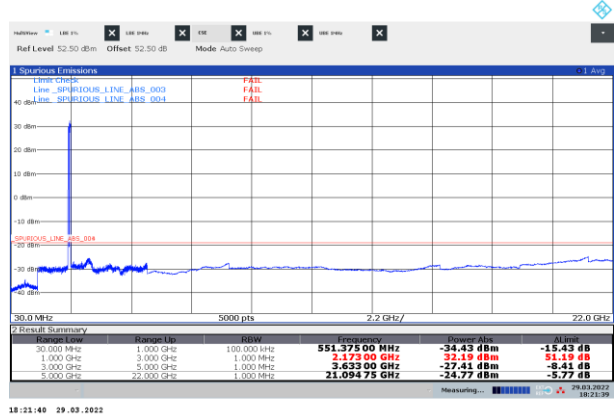

Figure 8.3-18: Conducted spurious emissions of NR 25 MHz three-carrier operation, top

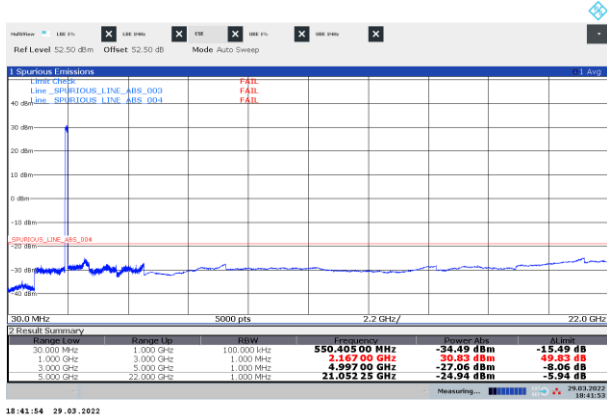

Figure 8.3-19: Conducted spurious emissions of NR 30 MHz three-carrier operation, bottom

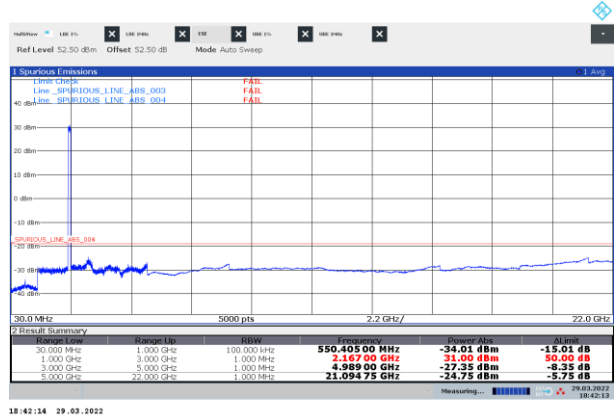

Figure 8.3-20: Conducted spurious emissions of NR 30 MHz three-carrier operation, top

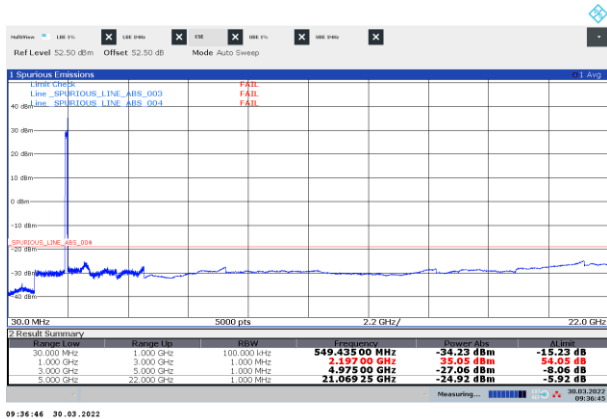

Figure 8.3-21: Conducted spurious emissions of NR 40 MHz three-carrier operation 2 x NR 40 MHz+ 1 x NR 5 MHz, bottom

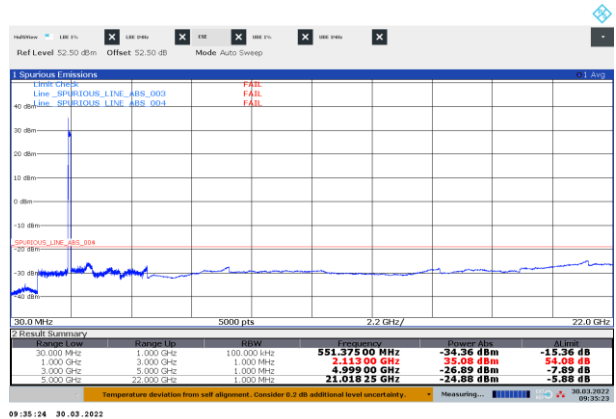

Figure 8.3-22: Conducted spurious emissions of NR 40 MHz three-carrier operation 2 x NR 40 MHz+ 1 x NR 5 MHz, top

Test data, continued

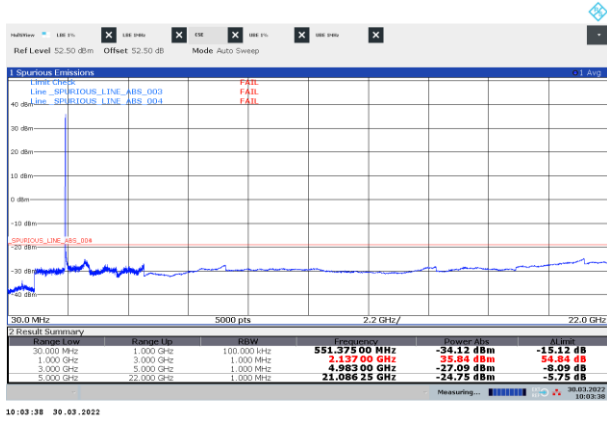

Figure 8.3-23: Conducted spurious emissions of multi-RAT operation, LTE 5 MHz + NR 25 MHz, bottom

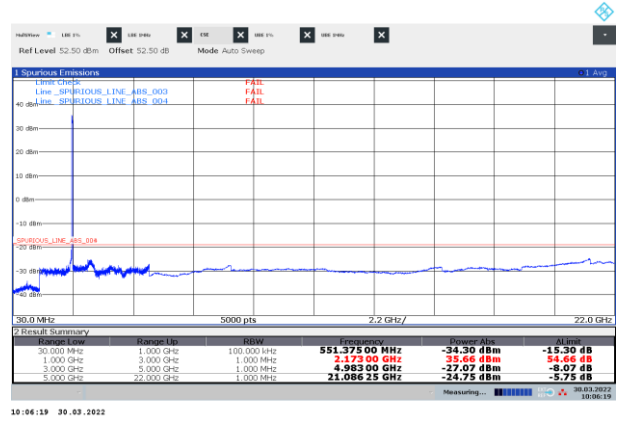

Figure 8.3-24: Conducted spurious emissions of multi-RAT operation, LTE 5 MHz + NR 25 MHz, top



Figure 8.3-25: Conducted spurious emissions of multi-RAT operation, LTE 20 MHz + 2 * NR 25 MHz, bottom



Figure 8.3-26: Conducted spurious emissions of multi-RAT operation, LTE 20 MHz + 2 * NR 25 MHz, top

Test data, continued

On the plots below the measured value in the “Total Channel Power” column must be **-19 dBm** and lower.

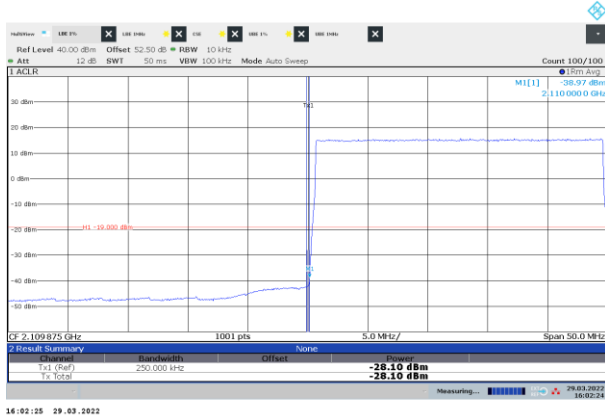

Figure 8.3-27: Conducted emission at the lower band edge

Frequency: 2110 MHz Mode: Single-carrier operation
 Meas. BW: 1% of EBW Tech.: NR 25 MHz
 Limit: -19 dBm/250 kHz Notes: None

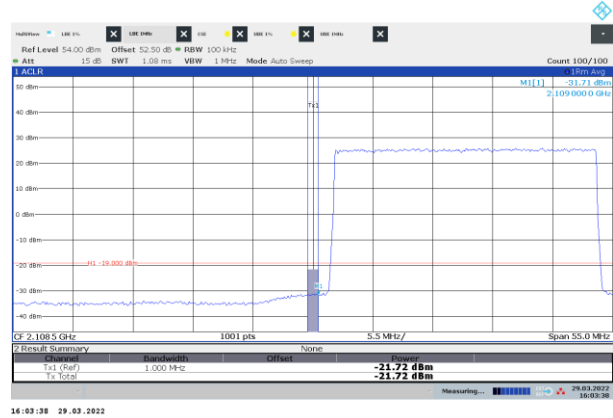

Figure 8.3-28: Conducted emission 1 MHz away from the lower band edge

Frequency: 2109 MHz Mode: Single-carrier operation
 Meas. BW: 1 MHz Tech.: NR 25 MHz
 Limit: -19 dBm/MHz Notes: None

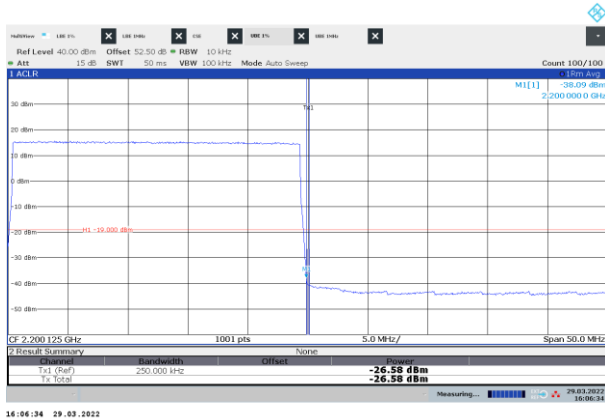

Figure 8.3-29: Conducted emission at the upper band edge

Frequency: 2200 MHz Mode: Single-carrier operation
 Meas. BW: 1% of EBW Tech.: NR 25 MHz
 Limit: -19 dBm/250 kHz Notes: None

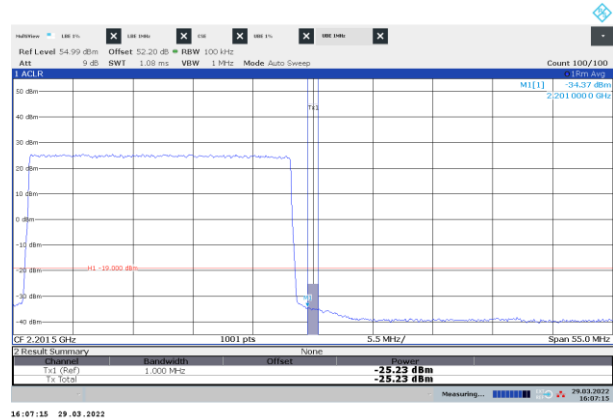

Figure 8.3-30: Conducted emission 1 MHz away from the upper band edge

Frequency: 2201 MHz Mode: Single-carrier operation
 Meas. BW: 1 MHz Tech.: NR 25 MHz
 Limit: -19 dBm/MHz Notes: None

Test data, continued

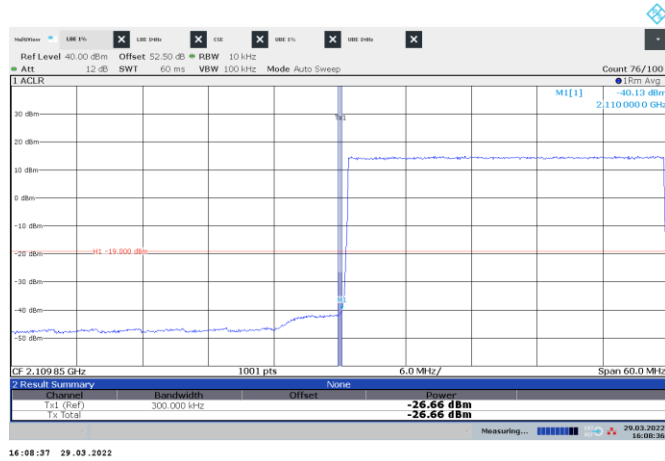

Figure 8.3-31: Conducted emission at the lower band edge

Frequency: 2110 MHz Mode: Single-carrier operation
 Meas. BW: 1% of EBW Tech.: NR 30 MHz
 Limit: -19 dBm/300 kHz Notes: None

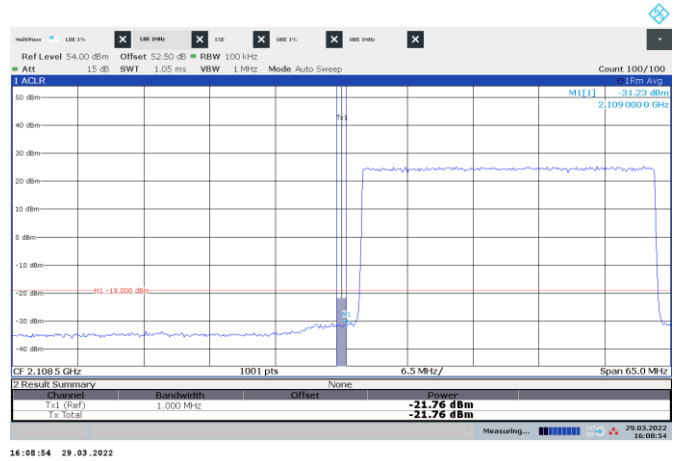

Figure 8.3-32: Conducted emission 1 MHz away from the lower band edge

Frequency: 2109 MHz Mode: Single-carrier operation
 Meas. BW: 1 MHz Tech.: NR 30 MHz
 Limit: -19 dBm/MHz Notes: None

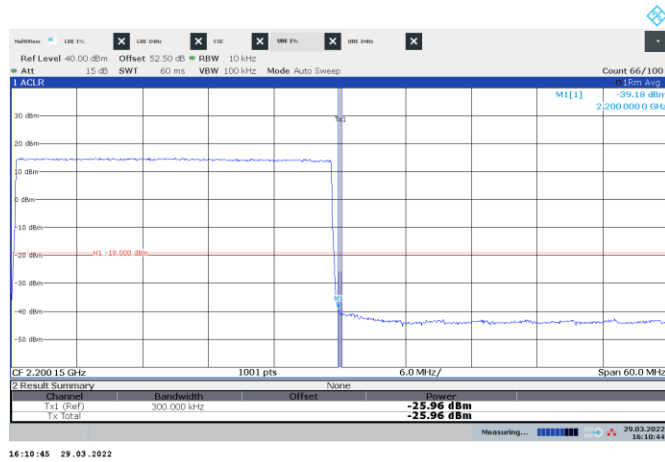

Figure 8.3-33: Conducted emission at the upper band edge

Frequency: 2200 MHz Mode: Single-carrier operation
 Meas. BW: 1% of EBW Tech.: NR 30 MHz
 Limit: -19 dBm/300 kHz Notes: None

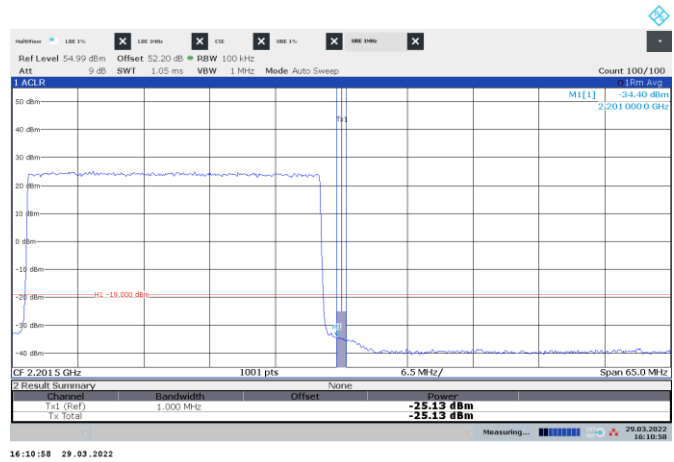

Figure 8.3-34: Conducted emission 1 MHz away from the upper band edge

Frequency: 2201 MHz Mode: Single-carrier operation
 Meas. BW: 1 MHz Tech.: NR 30 MHz
 Limit: -19 dBm/MHz Notes: None

Test data, continued

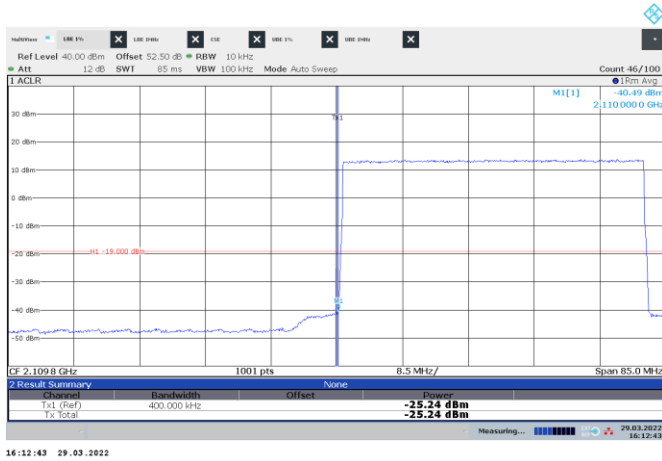

Figure 8.3-35: Conducted emission at the lower band edge

Frequency: 2110 MHz Mode: Single-carrier operation
 Meas. BW: 1% of EBW Tech.: NR 40 MHz
 Limit: -19 dBm/400 kHz Notes: None

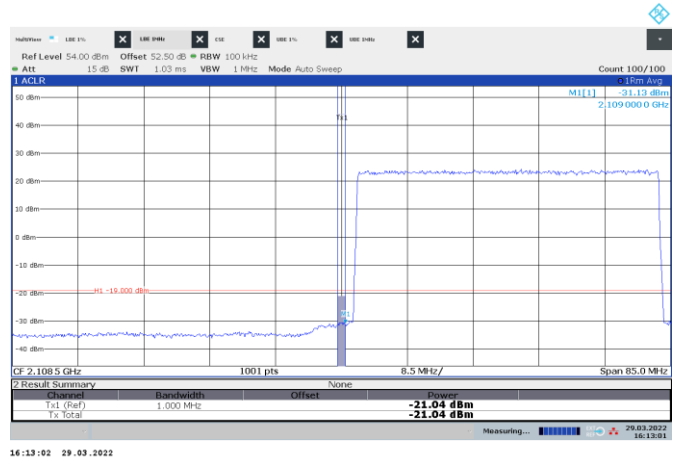

Figure 8.3-36: Conducted emission 1 MHz away from the lower band edge

Frequency: 2109 MHz Mode: Single-carrier operation
 Meas. BW: 1 MHz Tech.: NR 40 MHz
 Limit: -19 dBm/MHz Notes: None

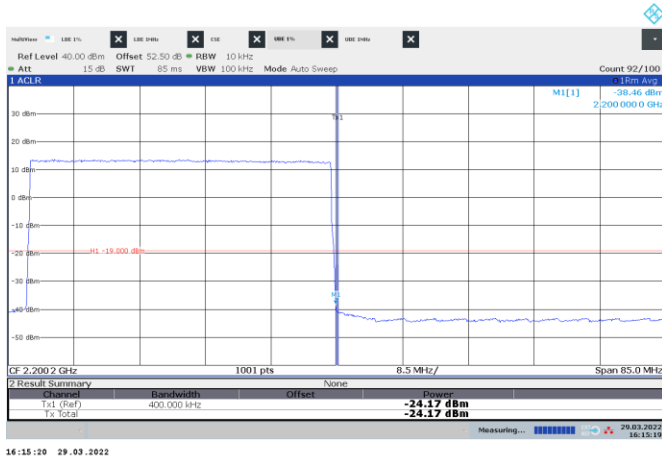

Figure 8.3-37: Conducted emission at the upper band edge

Frequency: 2200 MHz Mode: Single-carrier operation
 Meas. BW: 1% of EBW Tech.: NR 40 MHz
 Limit: -19 dBm/400 kHz Notes: None

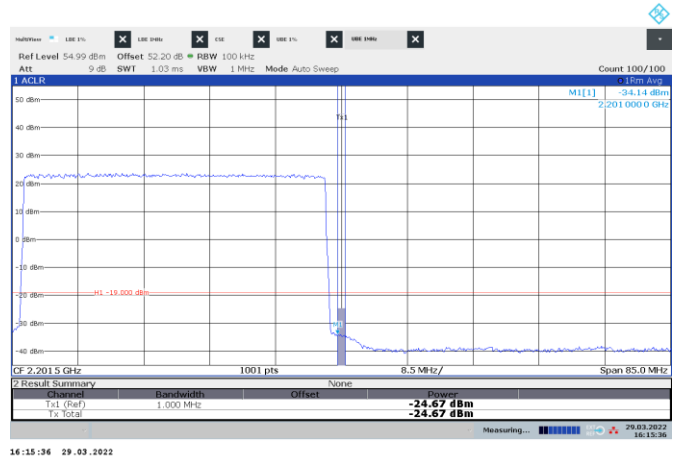

Figure 8.3-38: Conducted emission 1 MHz away from the upper band edge

Frequency: 2201 MHz Mode: Single-carrier operation
 Meas. BW: 1 MHz Tech.: NR 40 MHz
 Limit: -19 dBm/MHz Notes: None

Test data, continued

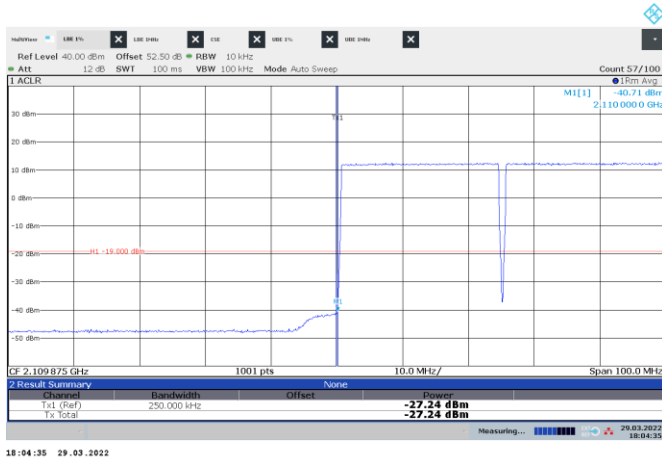

Figure 8.3-39: Conducted emission at the lower band edge

Frequency: 2110 MHz Mode: Multi-carrier operation
 Meas. BW: 1% of EBW Tech.: 2 x NR 25 MHz
 Limit: -19 dBm/250 kHz Notes: None

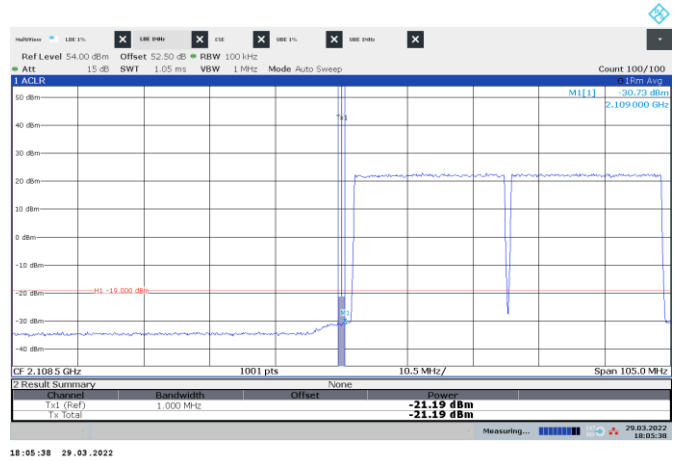

Figure 8.3-40: Conducted emission 1 MHz away from the lower band edge

Frequency: 2109 MHz Mode: Multi-carrier operation
 Meas. BW: 1 MHz Tech.: 2 x NR 25 MHz
 Limit: -19 dBm/MHz Notes: None

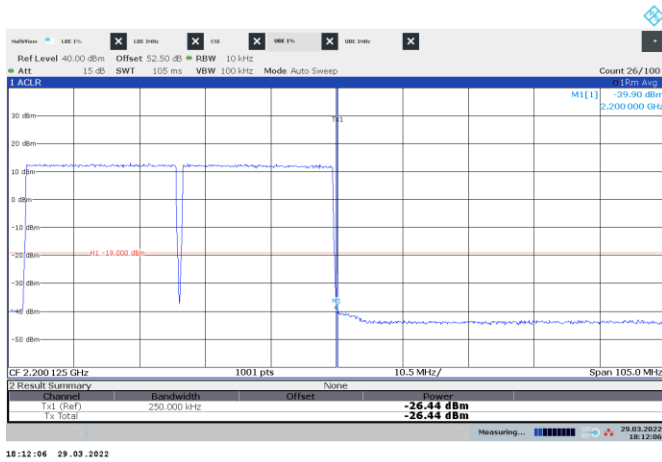

Figure 8.3-41: Conducted emission at the upper band edge

Frequency: 2200 MHz Mode: Multi-carrier operation
 Meas. BW: 1% of EBW Tech.: 2 x NR 25 MHz
 Limit: -19 dBm/250 kHz Notes: None

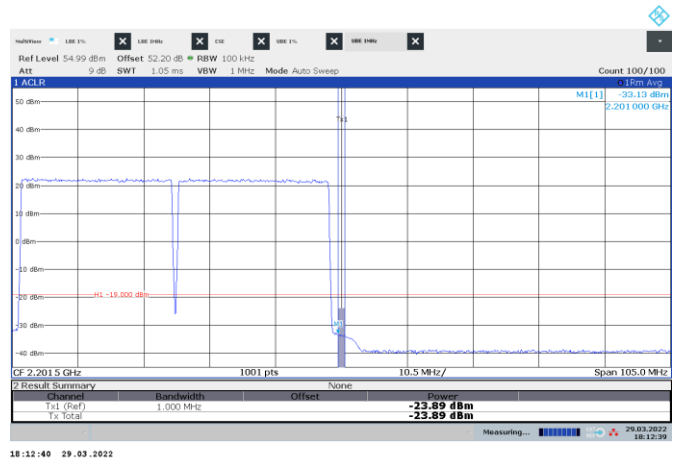

Figure 8.3-42: Conducted emission 1 MHz away from the upper band edge

Frequency: 2201 MHz Mode: Multi-carrier operation
 Meas. BW: 1 MHz Tech.: 2 x NR 25 MHz
 Limit: -19 dBm/MHz Notes: None

Test data, continued

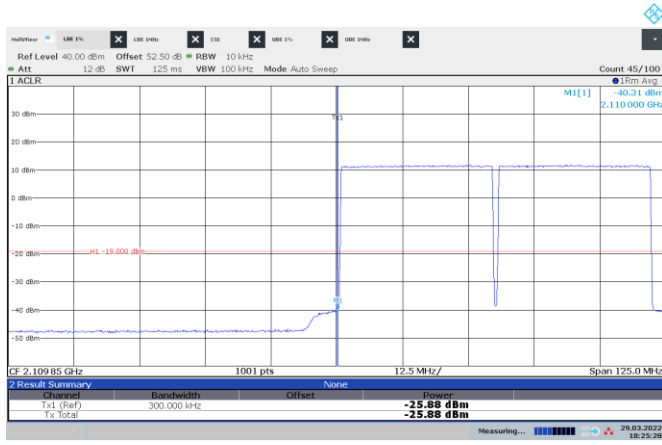

Figure 8.3-43: Conducted emission at the lower band edge

Frequency: 2110 MHz Mode: Multi-carrier operation
 Meas. BW: 1% of EBW Tech.: 2 x NR 30 MHz
 Limit: -19 dBm/300 kHz Notes: None

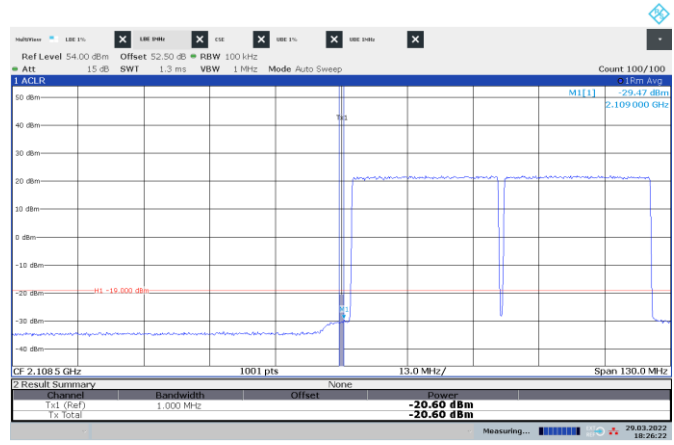

Figure 8.3-44: Conducted emission 1 MHz away from the lower band edge

Frequency: 2109 MHz Mode: Multi-carrier operation
 Meas. BW: 1 MHz Tech.: 2 x NR 30 MHz
 Limit: -19 dBm/MHz Notes: None

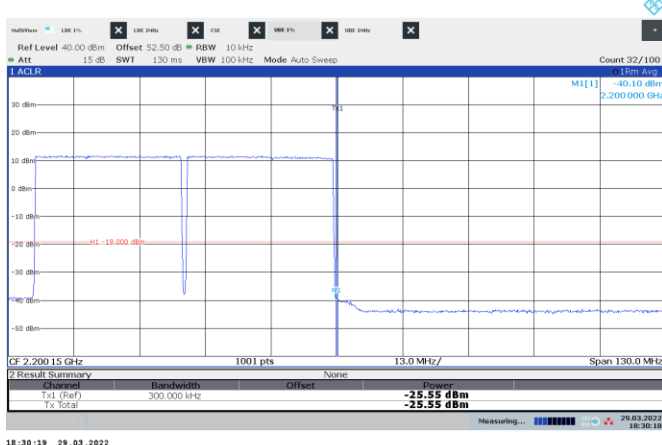

Figure 8.3-45: Conducted emission at the upper band edge

Frequency: 2200 MHz Mode: Multi-carrier operation
 Meas. BW: 1% of EBW Tech.: 2 x NR 30 MHz
 Limit: -19 dBm/300 kHz Notes: None

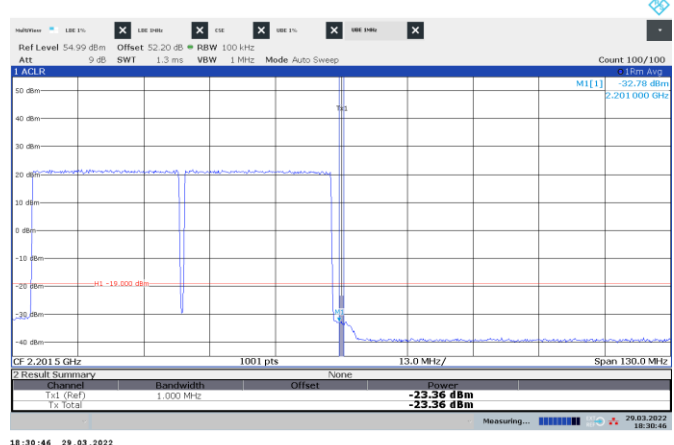

Figure 8.3-46: Conducted emission 1 MHz away from the upper band edge

Frequency: 2201 MHz Mode: Multi-carrier operation
 Meas. BW: 1 MHz Tech.: 2 x NR 30 MHz
 Limit: -19 dBm/MHz Notes: None