



Add value.  
Inspire trust.



# Report On

FCC and ISED Testing of the  
Ericsson Radio 4460 44B2/B25 44B66 C, KRC 161 912/3, NR (1900  
MHz) Base Station in accordance with FCC CFR 47 Part 2, FCC CFR  
47 Part 24, ISED RSS-GEN and Industry Canada RSS-133

COMMERCIAL-IN-CONFIDENCE

FCC: TA8AKRC161912-3  
IC: 287AB-AS1619123

PREPARED BY

Maggie Whiting  
Key Account Manager

APPROVED BY

Steve Scarfe  
Authorised Signatory

DATED

22 February 2022

**Document 75953954 Report 06 Issue 1**

**February 2022**



## CONTENTS

Section	Page No
<b>1</b>	<b>REPORT INFORMATION ..... 2</b>
1.1	Report Details ..... 3
1.2	Brief Summary of Results ..... 4
1.3	Test Rationale..... 5
1.4	Configuration Description ..... 6
1.5	Declaration of Build Status ..... 7
1.6	Product Information ..... 10
1.7	Test Setup ..... 11
1.8	Test Conditions..... 13
1.9	Deviation From The Standard ..... 13
1.10	Modification Record ..... 13
1.11	Additional Information ..... 13
<b>2</b>	<b>TEST DETAILS ..... 14</b>
2.1	Maximum Peak Output Power and Peak to Average Ratio - Conducted..... 15
2.2	Occupied Bandwidth..... 27
2.3	Band Edge ..... 37
2.4	Transmitter Spurious Emissions..... 43
2.5	Radiated Emissions ..... 82
<b>3</b>	<b>TEST EQUIPMENT USED ..... 90</b>
3.1	Test Equipment Used ..... 91
3.2	Measurement Uncertainty ..... 93
3.3	Measurement Software Used ..... 94
<b>4</b>	<b>ACCREDITATION, DISCLAIMERS AND COPYRIGHT..... 95</b>
4.1	Accreditation, Disclaimers and Copyright..... 96
<b>ANNEX A</b>	<b>Module Lists.....A.2</b>



## **SECTION 1**

### **REPORT INFORMATION**



## 1.1 REPORT DETAILS

Manufacturer	Ericsson
Address	Torshamnsgatan 23 Kista SE-16480 Stockholm Sweden
Product Name & Product Number	Radio 4460 44B2/B25 44B66 C - KRC 161 912/3
IC Model Name	AS1619123
Serial Number(s)	E23D043442, E23D043115, E23D043478
Software Version	CXP9013268/15 Revision R89AJ
Hardware Version	R2B
Test Specification/Issue/Date	FCC CFR 47 Part 2: 2020 FCC CFR 47 Part 24: 2020 ISED RSS-GEN: Issue 5: March 2019 Amendment 1, 2021 Amendment 2 Industry Canada RSS-133: Issue 6: January 2018 Amendment 1
Test Plan	Q1 2022 FCC_IC test plan for MR7602-1 NR-IoT V 1.2
Start of Test	10-December-2021
Finish of Test	01-February-2022
Name of Engineer(s)	Neil Rousell, Graeme Lawler
Related Document(s)	KDB 971168 D01 v02r02 KDB 662911 D01 v02r01 ICES-003:Issue 7 (2020-10) ANSI C63.26-2015

---

### ENGINEERING STATEMENT

The measurements shown in this report were made in accordance with the procedures described on test pages. All reported testing was carried out on a sample equipment to demonstrate compliance with and FCC CFR 47 Part 2: 2020, FCC CFR 47 Part 24: 2020, ISED RSS-GEN: Issue 5: March 2019 Amendment 1, 2021 Amendment 2 Industry Canada RSS-133: Issue 6: January 2018 Amendment 1 The sample tested was found to comply with the requirements defined in the applied rules.

Test Engineer(s);

---

Neil Rousell, Graeme Lawler



## 1.2 BRIEF SUMMARY OF RESULTS

A brief summary of results for each configuration, in accordance with FCC CFR 47 Part 2, FCC CFR 47 Part 24, ISED RSS-GEN and Industry Canada RSS-133 is shown below.

Section	Specification Clause				Test Description	Result
	FCC CFR 47 Part 2	FCC CFR 47 Part 24	RSS-GEN	RSS-133		
2.1	2.1046	24.232	-	6.4	Maximum Peak Output Power and Peak to Average Ratio - Conducted	Pass
2.2	2.1049	24.238 (b)	6.7		Occupied Bandwidth	Pass
2.3	2.1051	24.238 (b)	-	6.5	Band Edge	Pass
2.4	2.1051	24.238 (a)	6.13	6.5	Transmitter Spurious Emissions	Pass
2.5	2.1053	-	6.13	6.5	Radiated Emissions	Pass

Testing in this Report covers only B2/B25 (1900 MHz)

For additional configurations and test cases not contained within this test report, refer to the following reports:

Document 75953954 Report 07 – Radio 4415 B2//B25 B66 ( B66) (2100 MHz)



### **1.3 TEST RATIONALE**

The tests that have been selected are detailed in the customer Test Plan as defined in section 1.1 of this report. The Test Plan is based on the TÜV SÜD FCC Test Plan Rationale, available on request.



### 1.4 CONFIGURATION DESCRIPTION

Configuration Number	Band	RATs	Carriers	Pout (W)	NR Main carrier			
					Position	BW	Freq	NR-ARFCN
1	B25	NR in NR/ESS Setup (NB IoT IB) 15 kHz SCS, QPSK	1	40	B	10	1935	387000
	B25			40	M	10	1962.5	392500
	B25			40	T	10	1990	398000
	B25			60	B	15	1937.5	387500
	B25			60	M	15	1962.5	392500
	B25			60	T	15	1987.5	397500
	B25			80	B	20	1940	388000
	B25			80	M	20	1962.5	392500
	B25			80	T	20	1985	397000
	2			B2	NR in NR/ESS Setup (NB IoT IB) 15 kHz SCS, QPSK	1	40	M
B2		40	T	10			1985	397000
B2		60	M	15			1960	392000
B2		60	T	15			1982.5	396500
B2		80	M	20			1960	392000
B2		80	T	20			1980	396000



### 1.5 DECLARATION OF BUILD STATUS

Equipment Description			
Technical Description: (Please provide a brief description of the intended use of the equipment including the technologies the product supports)		Multi-standard remote radio unit Radio 4460 44B2/B25 44B66 C, 4Tx and 4Rx	
Manufacturer:		Ericsson AB	
Model:		Radio 4460 44B2/B25 44B66 C	
Part Number:		KRC 161 912/3	
Hardware Version:		R2B	
Software Version:		CXP9013268/15 Revision R89AJ	
FCC ID of the product under test		TA8AKRC161912-3	
IC ID of the product under test		287AB-AS1619123	
Intentional Radiators			
Frequency Range (MHz to MHz) B2	TX (DL): 1930 - 1990 MHz RX (UL): 1850 - 1910 MHz	BW: 60MHz BW: 60MHz	
Frequency Range (MHz to MHz) B25	TX (DL): 1930 - 1995 MHz RX (UL): 1850 - 1915 MHz	BW: 65MHz BW: 65MHz	
Frequency Range (MHz to MHz) B66	TX (DL): 2110 - 2200 MHz RX (UL): 1710 - 1780 MHz	BW: 90MHz BW: 70MHz	
Conducted Declared Output Power (dBm)	49.0 Max output power per port 80W. Carriers are limited to 4W/MHz		
RAT SC carrier Power (Max) :NR	BW	PWR/Carrier(Max)	
	10MHz	40 W	
	15MHz	60W	
	20MHz	80W	
Radio Configuration:	4 RX / 4TX		
Duplex mode:	FDD		
RAT(s):	LTE: SC, MC, MIMO, CA, ESS, (LTE + NB-IoT (IB, GB)) NR: SC, MC, MIMO, CA, ESS, (NR + NB-IoT (IB))		
Supported Bandwidth(s) (MHz): B2/B25, B66	NR: 5MHz, 10MHz, 15MHz, 20MHz LTE: 5MHz, 10MHz, 15MHz, 20MHz		
Antenna Gain (dBi)	17.5 (B2/B25) 18.0 (B66)		
Antenna Impedance(Ω)	50		
Supported modulation scheme, LTE:	QPSK, 16QAM, 64QAM, 256QAM		
Supported modulation scheme, NR:	QPSK, 16QAM, 64QAM, 256QAM		
ITU type of Emission Designator, Band 2/Band 25	NR	LTE	LTE +NB-IoT(IB,GB)
	5 MHz : 5M00W7D	5 MHz : 5M00W7D	5 MHz : 5M00W7D
	10 MHz: 10M0W7D	10 MHz: 10M0W7D	10 MHz: 10M0W7D
	15 MHz: 15M0W7D	15 MHz: 15M0W7D	15 MHz: 15M0W7D
	20 MHz: 20M0W7D	20 MHz: 20M0W7D	20 MHz: 20M0W7D





	NR	LTE	LTE +NB-IoT(IB,GB)
ITU type of Emission Designator, Band 66	5 MHz : 5M00W7D	5 MHz : 5M00W7D	5 MHz : 5M00W7D
	10 MHz: 10M0W7D	10 MHz: 10M0W7D	10 MHz: 10M0W7D
	15 MHz: 15M0W7D	15 MHz: 15M0W7D	15 MHz: 15M0W7D
	20 MHz: 20M0W7D	20 MHz: 20M0W7D	20 MHz: 20M0W7D
ITU Emission Designator( NR+NB IoT IB ) Band 2 Test Report No. 75953954 Report 06 Issue 01	NR+NB IoT IB 10 MHz: 9M45W7D 15 MHz: 14M4W7D 20 MHz: 19M2W7D		
ITU Emission Designator( NR+NB IoT IB ) Band 25 Test Report No. 75953954 Report 06 Issue 01	NR+NB IoT IB 10 MHz: 9M44W7D 15 MHz: 14M4W7D 20 MHz: 19M2W7D		
ITU Emission Designator( NR+NB IoT IB ) Band 66 Test Report No. 75953954 Report 07 Issue 01	NR+NB IoT IB 10 MHz: 9M44W7D 15 MHz: 14M4W7D 20 MHz: 19M2W7D		
Radio Total Power (max.):	Output RF Power:140W (51.46dBm) per Port (max) configured as follows:		
	Configurations /Port:	B2/25	B66
	1	80W	60W
	2	60W	80W
	3	70W	70W
Carrier Configuration:	B2/25	B66	
	SRO: LTE, NR	SRO: LTE, NR	
	MRO: L+NR,	MRO: L+NR	
Nominal output power per Antenna Port / Band	SRO / MRO: Single / Multi Carrier: 80W (49.03 dBm)		
Supported Carrier Configurations /RAT:	5MHz (1-6), 10MHz (1-6) 15MHz (1-4), 20MHz (1-3) 6 Carriers / Band / Port (max)		
Unintentional Radiators			
Highest frequency generated or used in the device or on which the device operates or tunes			Up to 10.1 Gbit/s
Lowest frequency generated or used in the device or on which the device operates or tunes if <30MHz			.-
Class A Digital Device (Use in commercial, industrial or business environment)			.-
Class B Digital Device (Use in residential environment)			Class B
DC Power Supply (Delete if Not Applicable)			
Nominal voltage:	-48V		
Extreme upper voltage:	-36V		
Extreme lower voltage:	-58.5V		
Max current:	29A		
Temperature			
Minimum temperature:	-40°C		
Maximum temperature:	55°C		



Ancillaries			
Manufacturer:	X	Part Number:	X
Model:	X	Model:	X
I hereby declare that I am entitled to sign on behalf of the manufacturer and that the information supplied is correct and complete.			
Name:	Afrah Ali sadiq		
Position held:	Regulatory Approval Engineer		
Email address:	<a href="mailto:Afrah.ali.sadiq@ericsson.com">Afrah.ali.sadiq@ericsson.com</a>		
Telephone number:	.+46724650796		
Date:	19/02/2022		

No responsibility will be accepted by TÜV SÜD UK Limited as to the accuracy of the information declared in this document by the manufacturer.

## 1.6 PRODUCT INFORMATION

### 1.6.1 Technical Description

The Equipment Under Test (EUT) Radio 4460 44B2/B25 44B66 C - KRC 161 912/3 is an Ericsson AB Radio Unit working in the public mobile service Band 2, Band 25, Band 66 band which provides communication connections to Band 2, Band 25, Band 66 network. The EUT operates from a -48V DC supply.

The Equipment Under Test (EUT) is shown in the photograph below. A full technical description can be found in the Manufacturer's documentation.

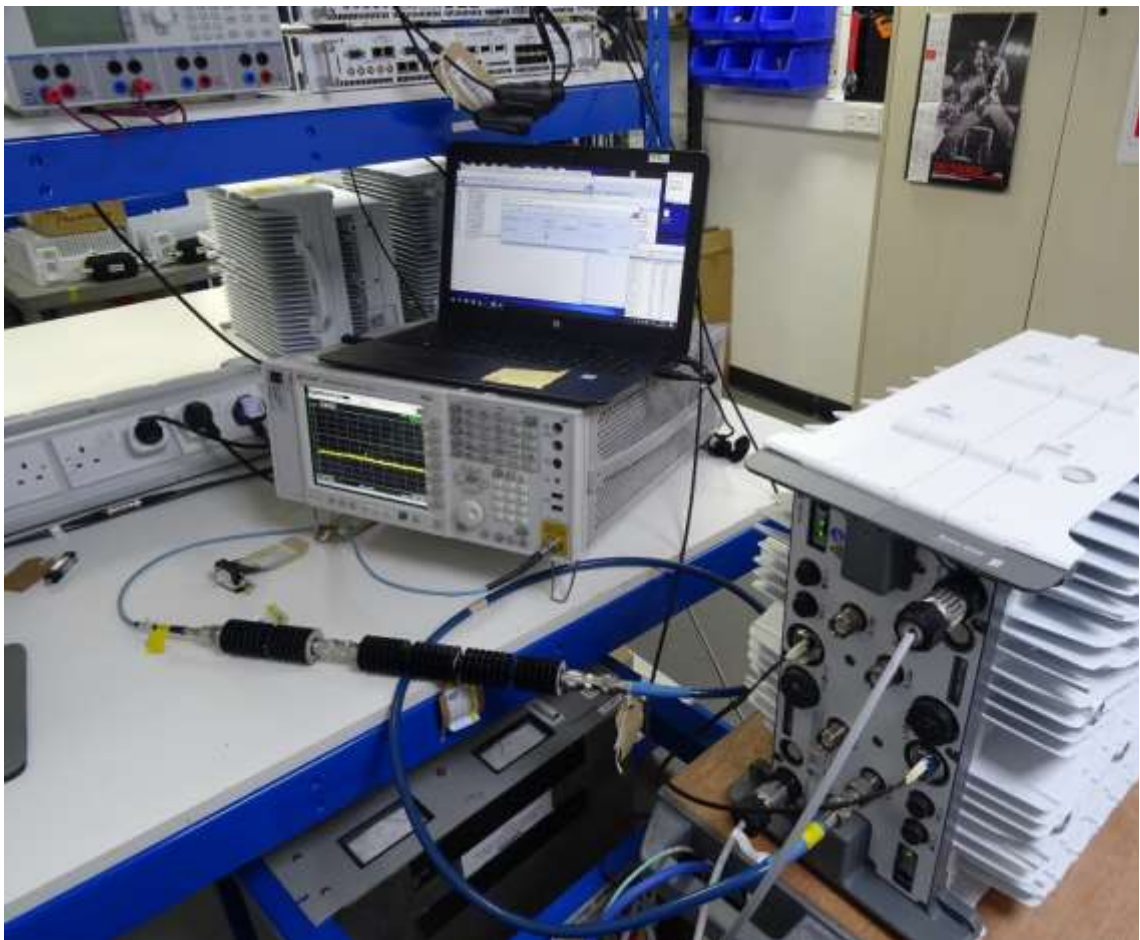

Equipment Under Test



## 1.7 TEST SETUP

### Conducted Test Set Up

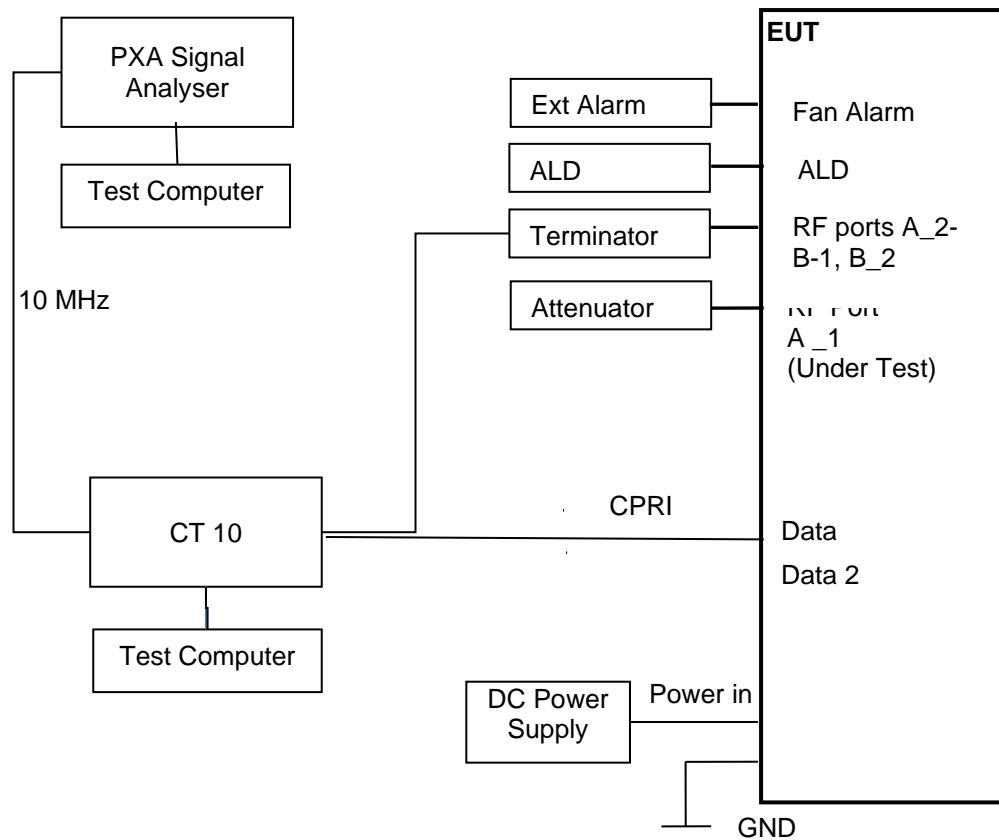



Radiated Test Set Up – Dashed line indicates equipment inside the Chamber for Radiated testing.

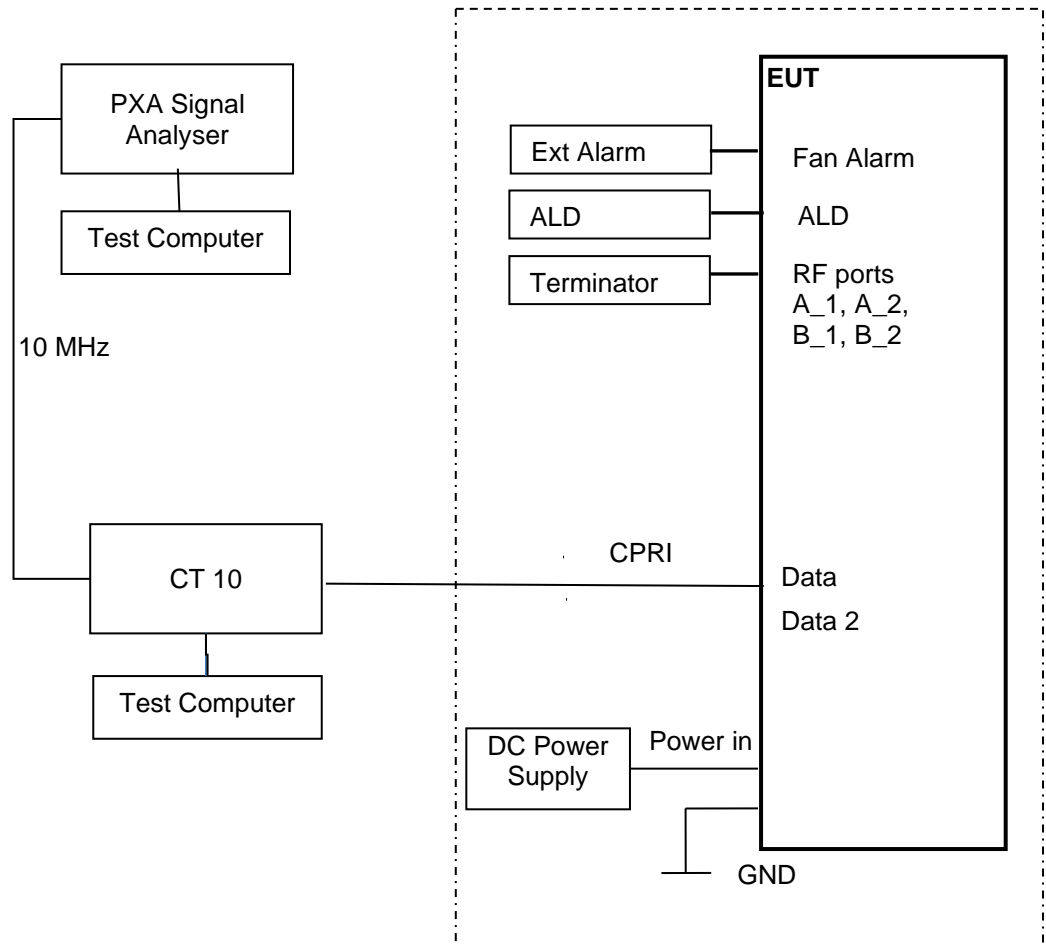



## 1.8 TEST CONDITIONS

For all tests the EUT was set up in accordance with the relevant test standard and to represent typical operating conditions. Tests were applied with the EUT situated as described in the Test Method for each Test.

The EUT was powered from a -48V DC supply.

FCC Measurement Facility Registration Number  
90987 Octagon House, Fareham Test Laboratory  
Postal Address: Octagon House, Concorde Way, Fareham, Hampshire, UK, PO15 5RL

Under our UKAS Accreditation, TÜV SÜD conducted the following tests Octagon House, Fareham Laboratory.

Test Name	Name of Engineer(s)
Maximum Peak Output Power and Peak to Average Ratio - Conducted	Neil Rousell
Occupied Bandwidth	Neil Rousell,
Band Edge	Neil Rousell
Transmitter Spurious Emissions	Neil Rousell
Radiated Emissions	Graeme Lawler

## 1.9 DEVIATION FROM THE STANDARD

No deviations from the applicable test standards or test plan were made during testing.

## 1.10 MODIFICATION RECORD

No modifications were made to the EUT during testing.

## 1.11 ADDITIONAL INFORMATION

This EUT uses the same port for Tx and Rx and therefore RX Spurious Emissions has not been performed. Rx Spurious Emissions have been covered by testing to FCC Part 15B, which are covered by a separate test report.

Frequency Stability was verified at the time of the original certification and is covered by a separate report



## **SECTION 2**

### **TEST DETAILS**



**2.1 MAXIMUM PEAK OUTPUT POWER AND PEAK TO AVERAGE RATIO - CONDUCTED**

**2.1.1 Specification Reference**

FCC CFR 47 Part 24, Clause 24.232  
 Industry Canada RSS-133, Clause 6.4  
 FCC CFR 47 Part 2, Clause 2.1046

**2.1.2 Date of Test and Modification State**

10-December-2021 - Modification State 0

**2.1.3 Test Equipment Used**

The major items of test equipment used for the above tests are identified in Section 3.1.

**2.1.4 Environmental Conditions**

Ambient Temperature 21.2°C  
 Relative Humidity 35.0%

**2.1.5 Test Method**

All measurements were made in accordance with FCC KDB 971168 D01, clause 5.2.1 and summed in accordance with FCC KDB 662911 D01.

**2.1.6 Test Results**

Configuration 1

Maximum Output Power 47.78 dBm

Antenna	NR Modulation	NR Carrier Bandwidth	Peak to Average Ratio (PAR) / Output Power / PSD				
			Channel Position B				
			PAR (dB)	Average Power/PSD		Total Power Port A + B + C + D	Total Power Port A + B + C + D
dBm	dBm/MHz	dBm		dBm/MHz			
A	QPSK	10.0 MHz 15 kHz SCS	8.35	45.55	36.73	51.57	42.75
A	QPSK	15.0 MHz 15 kHz SCS	8.18	47.26	38.12	53.28	44.14
A	QPSK	20.0 MHz 15 kHz SCS	7.68	48.36	39.22	54.38	45.24

Remarks

Calculations: Total Power = Measured Output Power (port A, worst case) + 10log (NANT)  
 Where NANT refers to the number of Ports. In this product = 4.





Antenna A - NR Modulation QPSK - NR Carrier Bandwidth 10.0 MHz 15 kHz SCS - Channel Position B

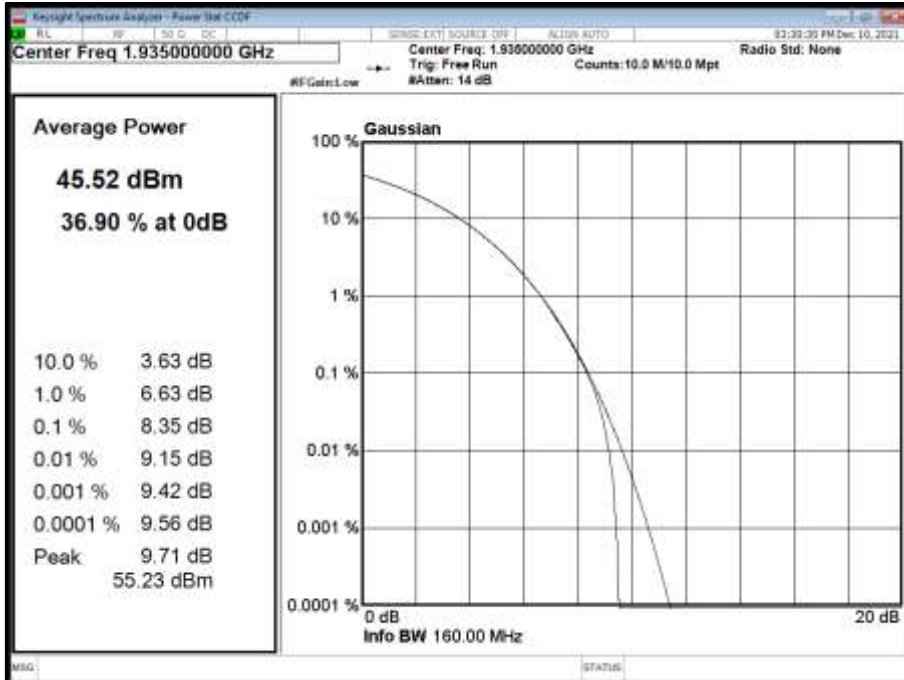

Antenna A - NR Modulation QPSK - NR Carrier Bandwidth 15.0 MHz 15 kHz SCS - Channel Position B

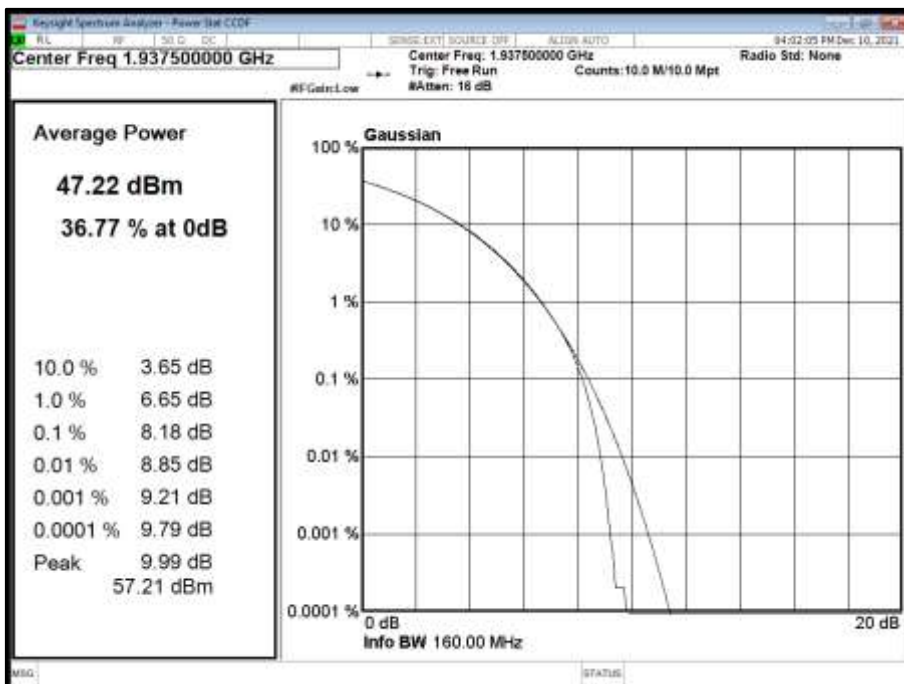



Antenna A - NR Modulation QPSK - NR Carrier Bandwidth 20.0 MHz 15 kHz SCS - Channel Position B

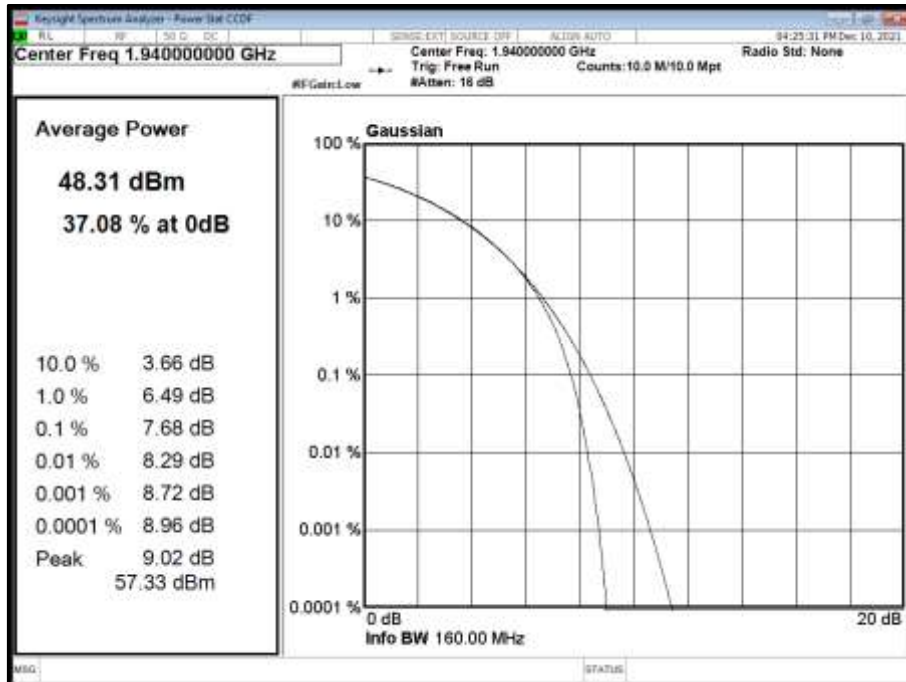



Configuration 1

Maximum Output Power 47.78 dBm

Antenna	NR Modulation	NR Carrier Bandwidth	Peak to Average Ratio (PAR) / Output Power / PSD				
			Channel Position M				
			PAR (dB)	Average Power/PSD		Total Power Port A + B + C + D	Total Power Port A + B + C + D
dBm	dBm/MHz	dBm		dBm/MHz			
A	QPSK	10.0 MHz 15 kHz SCS	8.35	45.76	36.85	51.78	42.87
A	QPSK	15.0 MHz 15 kHz SCS	8.25	47.37	38.05	53.39	44.07
A	QPSK	20.0 MHz 15 kHz SCS	7.38	48.57	39.20	54.59	45.22

Remarks

Calculations: Total Power = Measured Output Power (port A, worst case) + 10log (NANT)  
 Where NANT refers to the number of Ports. In this product = 4.

Antenna A - NR Modulation QPSK - NR Carrier Bandwidth 10.0 MHz 15 kHz SCS - Channel Position M

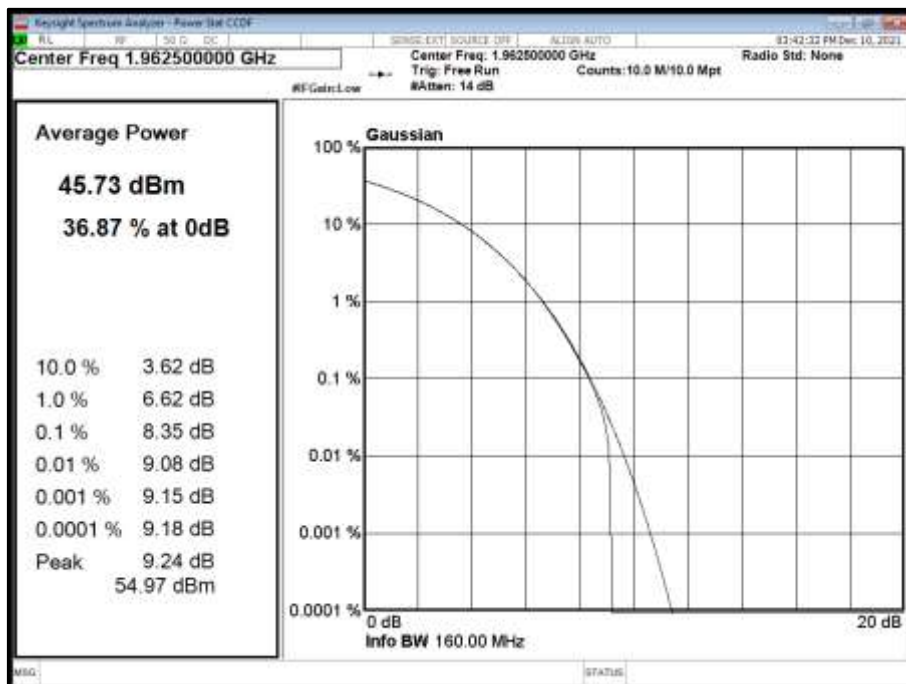



Antenna A - NR Modulation QPSK - NR Carrier Bandwidth 15.0 MHz 15 kHz SCS - Channel Position M

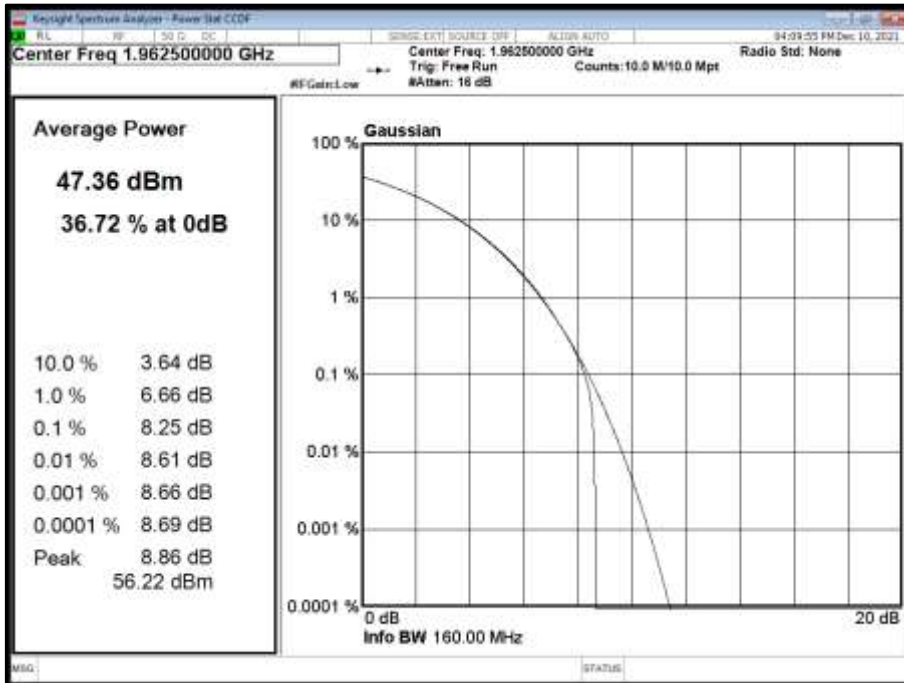

Antenna A - NR Modulation QPSK - NR Carrier Bandwidth 20.0 MHz 15 kHz SCS - Channel Position M

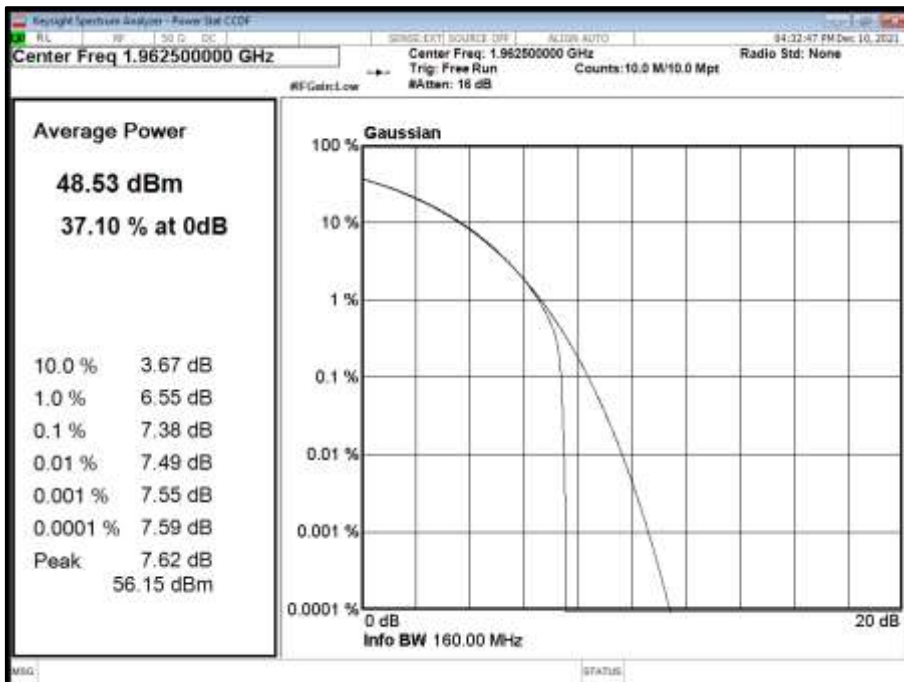



Configuration 1

Maximum Output Power 47.78 dBm

Antenna	NR Modulation	NR Carrier Bandwidth	Peak to Average Ratio (PAR) / Output Power / PSD				
			Channel Position T				
			PAR (dB)	Average Power/PSD		Total Power Port A + B + C + D	Total Power Port A + B + C + D
dBm	dBm/MHz	dBm		dBm/MHz			
A	QPSK	10.0 MHz 15 kHz SCS	8.34	45.66	36.84	51.68	42.86
A	QPSK	15.0 MHz 15 kHz SCS	8.19	47.32	38.12	53.34	44.14
A	QPSK	20.0 MHz 15 kHz SCS	7.47	48.44	39.13	54.46	45.15

Remarks

Calculations: Total Power = Measured Output Power (port A, worst case) + 10log (NANT)  
 Where NANT refers to the number of Ports. In this product = 4.

Antenna A - NR Modulation QPSK - NR Carrier Bandwidth 10.0 MHz 15 kHz SCS - Channel Position T

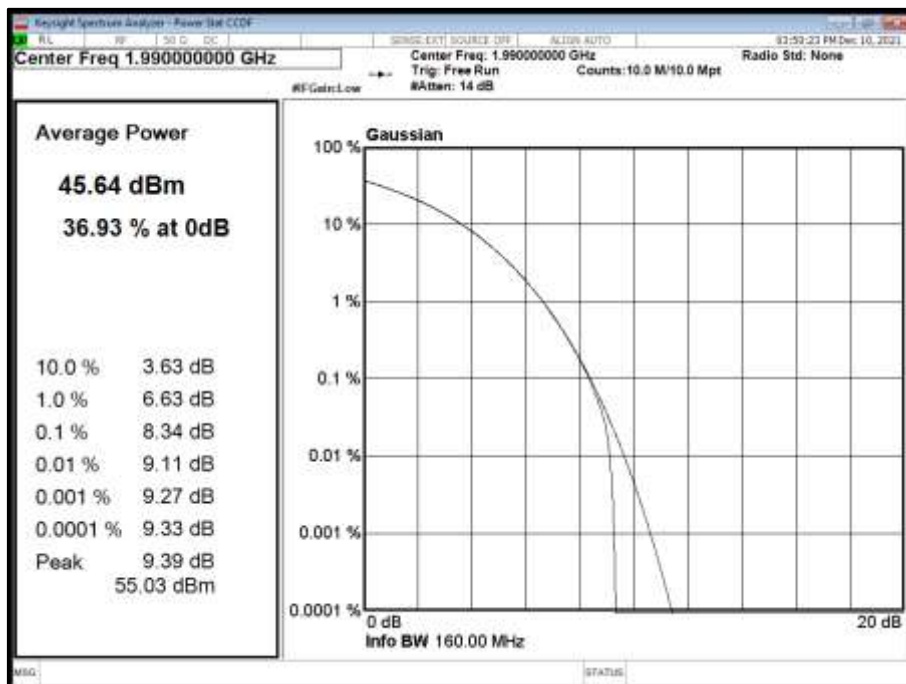



Antenna A - NR Modulation QPSK - NR Carrier Bandwidth 15.0 MHz 15 kHz SCS - Channel Position T

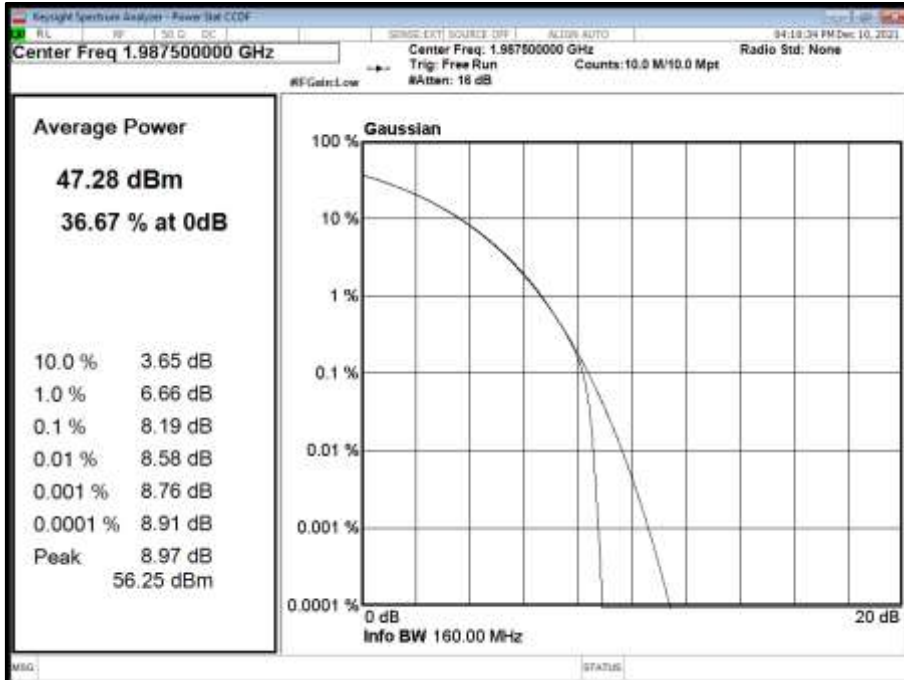

Antenna A - NR Modulation QPSK - NR Carrier Bandwidth 20.0 MHz 15 kHz SCS - Channel Position T

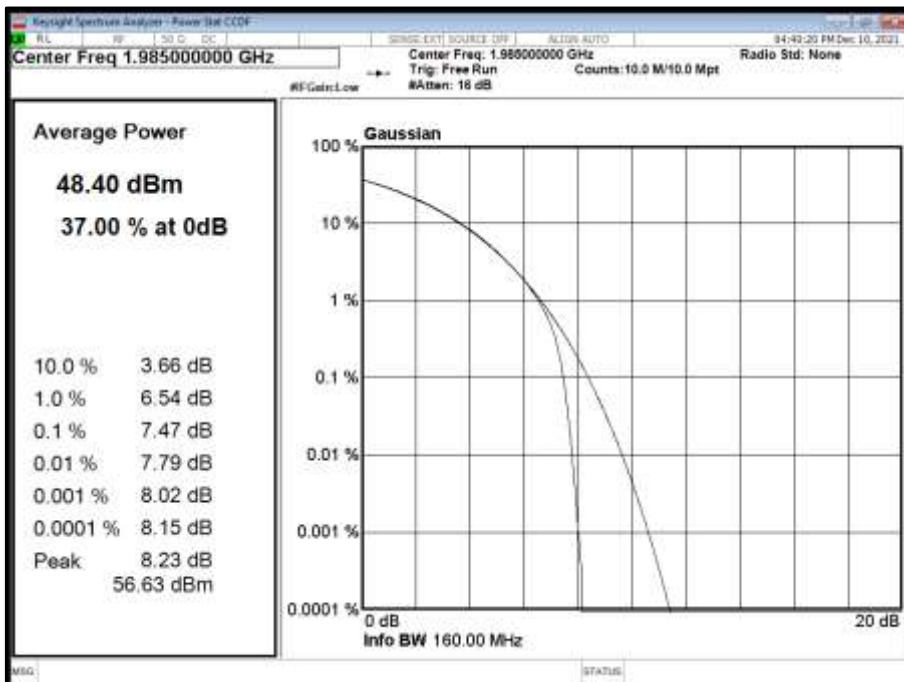



Configuration 2

Maximum Output Power 47.78 dBm

Antenna	NR Modulation	NR Carrier Bandwidth	Peak to Average Ratio (PAR) / Output Power / PSD				
			Channel Position M				Total Power Port A + B + C + D
			PAR (dB)	Average Power/PSD		Total Power Port A + B + C + D	
			dBm	dBm/MHz	dBm	dBm/MHz	
A	QPSK	10.0 MHz 15 kHz SCS	8.36	45.61	36.65	51.63	42.67
A	QPSK	15.0 MHz 15 kHz SCS	8.25	47.34	37.90	53.36	43.92
A	QPSK	20.0 MHz 15 kHz SCS	7.39	48.36	38.93	54.38	44.95

Remarks

Calculations: Total Power = Measured Output Power (port A, worst case) + 10log (NANT)  
 Where NANT refers to the number of Ports. In this product = 4.

Antenna A - NR Modulation QPSK - NR Carrier Bandwidth 10.0 MHz 15 kHz SCS - Channel Position M

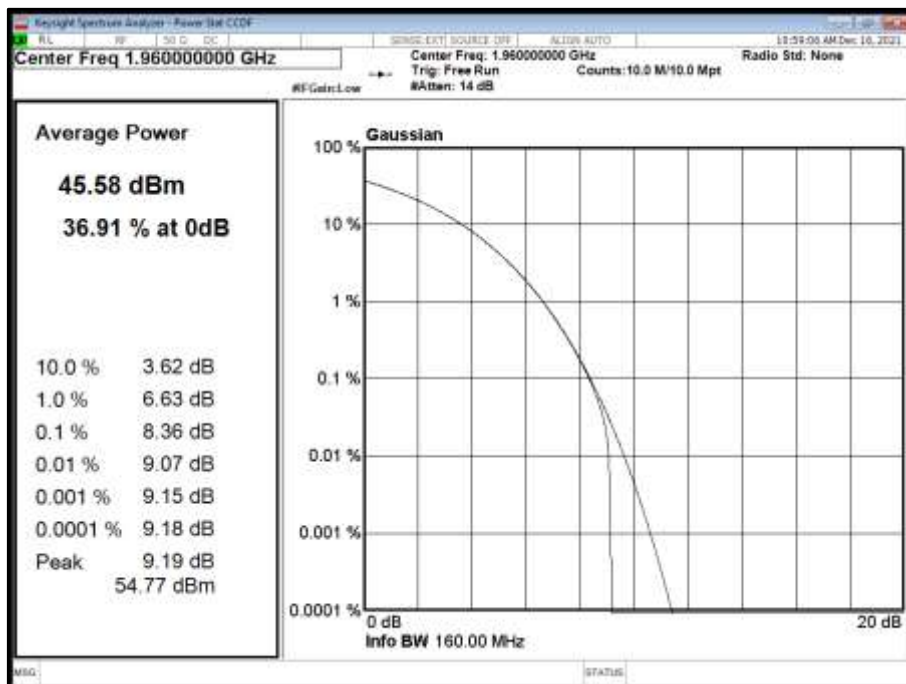



Antenna A - NR Modulation QPSK - NR Carrier Bandwidth 15.0 MHz 15 kHz SCS - Channel Position M

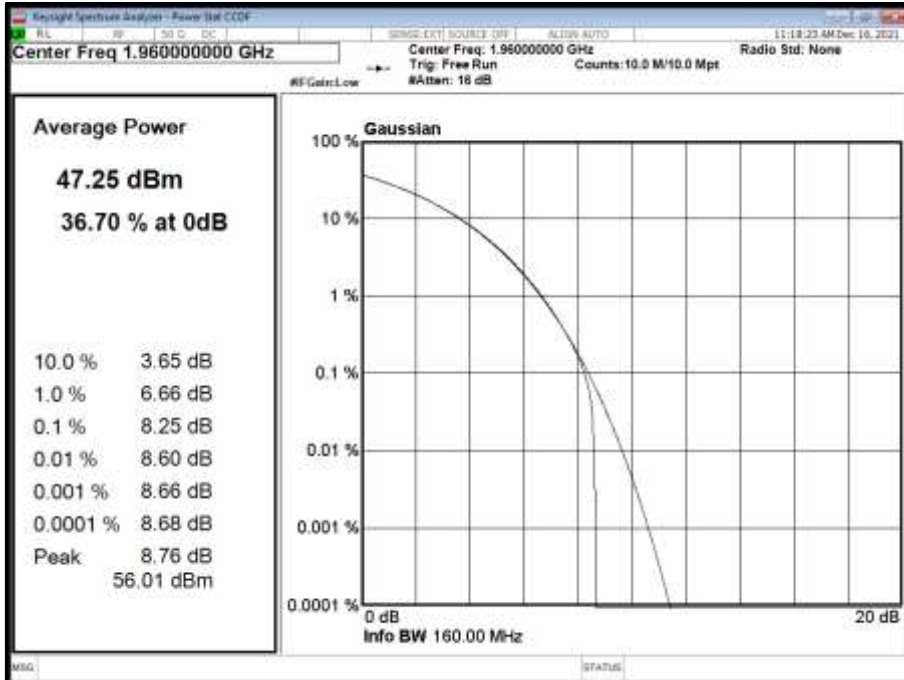

Antenna A - NR Modulation QPSK - NR Carrier Bandwidth 20.0 MHz 15 kHz SCS - Channel Position M

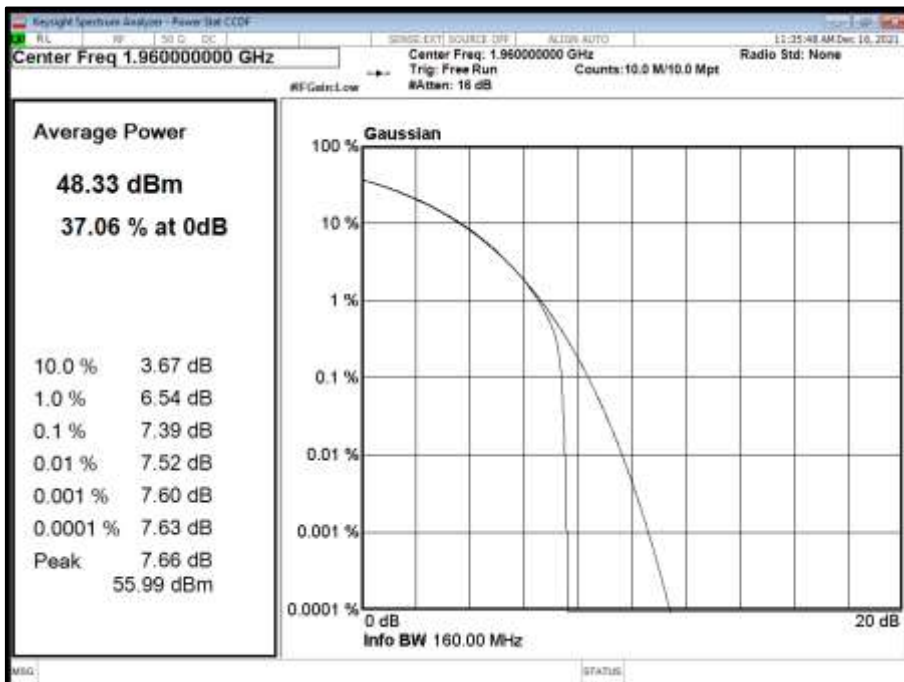





Configuartion 2

Maximum Output Power 47.78 dBm

Antenna	NR Modulation	NR Carrier Bandwidth	Peak to Average Ratio (PAR) / Output Power / PSD				
			Channel Position T				
			PAR (dB)	Average Power/PSD		Total Power Port A + B + C + D	Total Power Port A + B + C + D
dBm	dBm/MHz	dBm		dBm/MHz			
A	QPSK	10.0 MHz 15 kHz SCS	8.33	45.57	36.70	51.59	42.72
A	QPSK	15.0 MHz 15 kHz SCS	8.22	47.22	37.92	53.24	43.94
A	QPSK	20.0 MHz 15 kHz SCS	7.43	48.29	38.97	54.31	44.99

Remarks

Calculations: Total Power = Measured Output Power (port A, worst case) + 10log (NANT)  
 Where NANT refers to the number of Ports. In this product = 4.

Antenna A - NR Modulation QPSK - NR Carrier Bandwidth 10.0 MHz 15 kHz SCS - Channel Position T

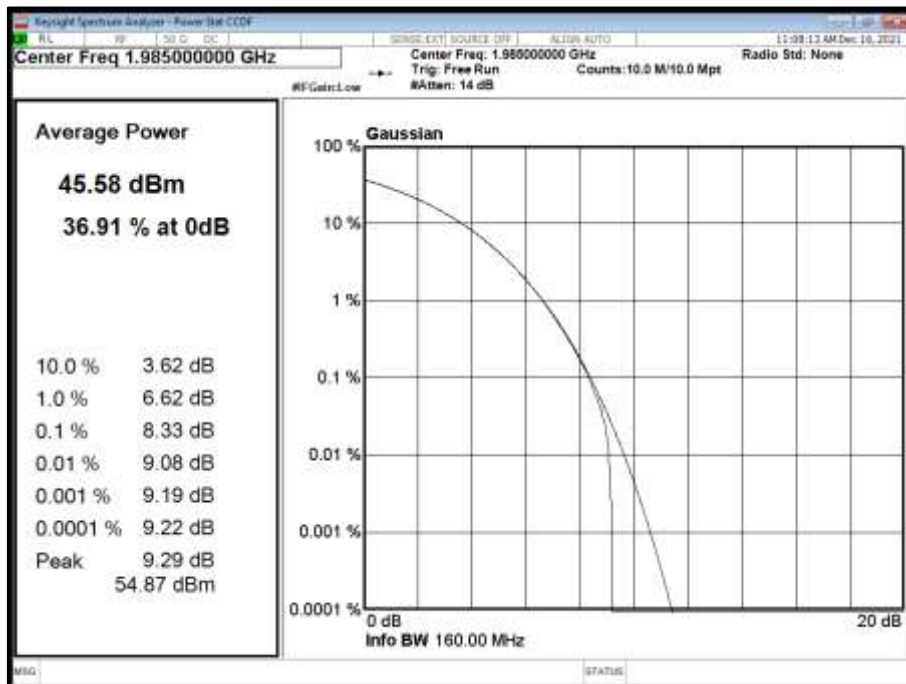



Antenna A - NR Modulation QPSK - NR Carrier Bandwidth 15.0 MHz 15 kHz SCS - Channel Position T

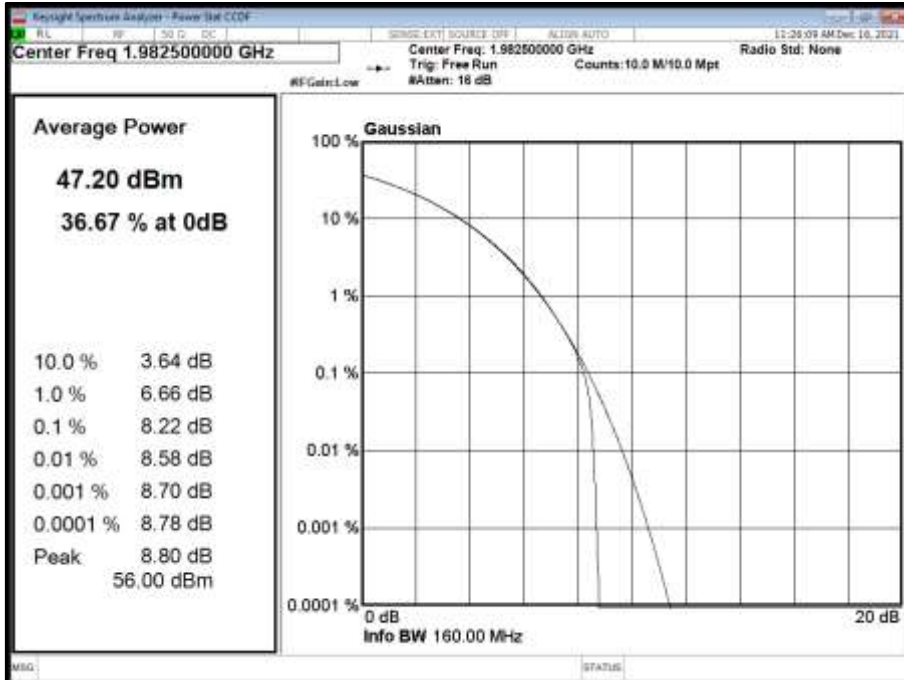

Antenna A - NR Modulation QPSK - NR Carrier Bandwidth 20.0 MHz 15 kHz SCS - Channel Position T

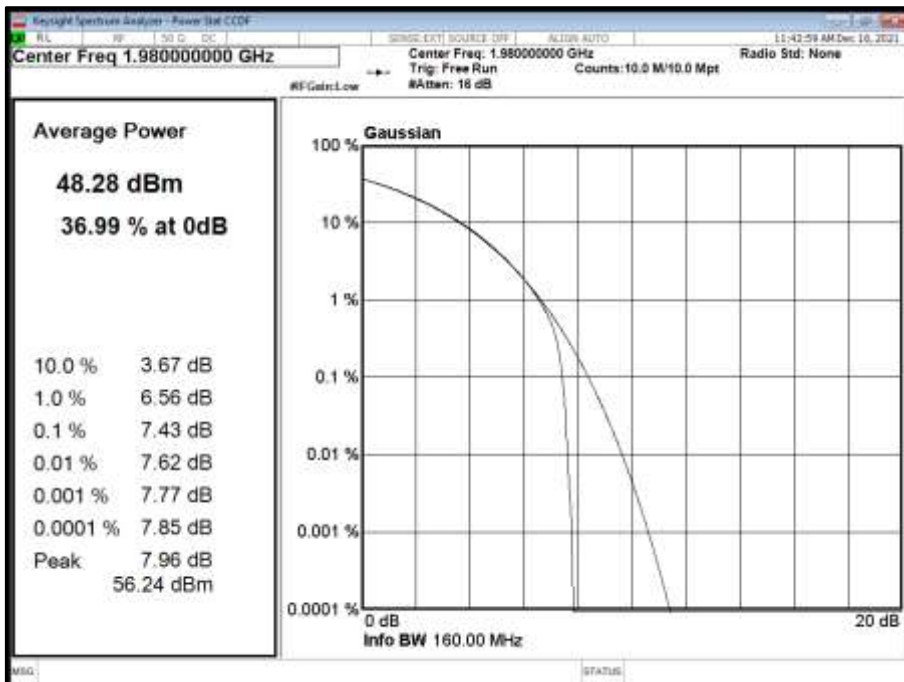

FCC Part 24.232 Clauses (a) & (b)



Limit	
Maximum ERP (Urban)	$\leq 1640 \text{ W}$ or $\leq +62.15 \text{ dBm}$ (antenna height $\leq 300\text{m}$ ) $\leq 1070 \text{ W}$ or $\leq +60.30 \text{ dBm}$ (antenna height $\leq 500\text{m}$ ) $\leq 490 \text{ W}$ or $\leq +56.90 \text{ dBm}$ (antenna height $\leq 1000\text{m}$ ) $\leq 270 \text{ W}$ or $\leq +54.31 \text{ dBm}$ (antenna height $\leq 1500\text{m}$ ) $\leq 160 \text{ W}$ or $\leq +52.04 \text{ dBm}$ (antenna height $\leq 2000\text{m}$ )
Maximum ERP (Non-Urban)	$\leq 3280 \text{ W}$ or $\leq +65.15 \text{ dBm}$ (antenna height $\leq 300\text{m}$ ) $\leq 2140 \text{ W}$ or $\leq +63.30 \text{ dBm}$ (antenna height $\leq 500\text{m}$ ) $\leq 980 \text{ W}$ or $\leq +59.91 \text{ dBm}$ (antenna height $\leq 1000\text{m}$ ) $\leq 540 \text{ W}$ or $\leq +57.32 \text{ dBm}$ (antenna height $\leq 1500\text{m}$ ) $\leq 320 \text{ W}$ or $\leq +55.05 \text{ dBm}$ (antenna height $\leq 2000\text{m}$ )

RSS-133 Clause 6.4

Limit	
Peak to Average Ratio	13 dB

SRSP-510 Power and Antenna Height Limitations Clause 5.1.1 & 5.1.2

Limit	
Maximum EIRP (Non-Urban)	$\leq 3280 \text{ W/MHz}$ or $\leq +65.15 \text{ dBm}$
Maximum EIRP (Urban)	$\leq 1640 \text{ W/MHz}$ or $\leq +62.15 \text{ dBm}$ (antenna height $\leq 300\text{m}$ ) $\leq 1070 \text{ W/MHz}$ or $\leq +60.30 \text{ dBm}$ (antenna height $\leq 500\text{m}$ ) $\leq 490 \text{ W/MHz}$ or $\leq +56.90 \text{ dBm}$ (antenna height $\leq 1000\text{m}$ ) $\leq 270 \text{ W/MHz}$ or $\leq +54.31 \text{ dBm}$ (antenna height $\leq 1500\text{m}$ ) $\leq 160 \text{ W/MHz}$ or $\leq +52.04 \text{ dBm}$ (antenna height $\leq 2000\text{m}$ )



## **2.2 OCCUPIED BANDWIDTH**

### **2.2.1 Specification Reference**

FCC CFR 47 Part 24, Clause 24.238 (b)  
ISED RSS-GEN, Clause 6.7  
FCC CFR 47 Part 2, Clause 2.1049

### **2.2.2 Date of Test and Modification State**

10-December-2021 - Modification State 0

### **2.2.3 Test Equipment Used**

The major items of test equipment used for the above tests are identified in Section 3.1.

### **2.2.4 Environmental Conditions**

Ambient Temperature	21.2°C
Relative Humidity	35.0%

### **2.2.5 Test Method**

All measurements were made in accordance with FCC KDB 971168 D01, Clause 4.2 and 4.3. The Spectrum Analyser RBW was configured to be at least 1% of the channel bandwidth of the carrier to be measured.

For 26 dB Bandwidth, in accordance with KDB 971168 D01, a peak detector and a trace setting of Max Hold were used. The trace was allowed to stabilise. Using the Spectrum Analyser function, the 26dB measurement result was obtained.

#### **4.2 Occupied bandwidth – relative measurement procedure**

The reference value is the highest level of the spectral envelope of the modulated signal, unless otherwise specified in an applicable rule section.

Subclause 5.4.3 of ANSI C63.26-2015 is applicable.

#### **4.3 Occupied bandwidth – power bandwidth (99 %) measurement procedure**

Subclause 5.4.4 of ANSI C63.26-2015 is applicable (wherein the recommendation is to use the 99 % power bandwidth function of a spectrum analyzer).

### **2.2.6 Test Results**



Configuration 1

Maximum Output Power 47.78 dBm

Antenna	NR Modulation	NR Carrier Bandwidth	Result (kHz)					
			Channel Position B		Channel Position M		Channel Position T	
			Occupied Bandwidth	-26 dB Bandwidth	Occupied Bandwidth	-26 dB Bandwidth	Occupied Bandwidth	-26 dB Bandwidth
A	QPSK	10.0 MHz 15 kHz SCS	9441.75	9795.36	9445.33	9801.61	9446.52	9802.76
A	QPSK	15.0 MHz 15 kHz SCS	14357.18	14795.96	14359.15	14802.20	14364.84	14803.32
A	QPSK	20.0 MHz 15 kHz SCS	19181.28	19745.03	19188.65	19743.39	19184.58	19753.48

Antenna A - NR Modulation QPSK - NR Carrier Bandwidth 10.0 MHz 15 kHz SCS - Channel Position B

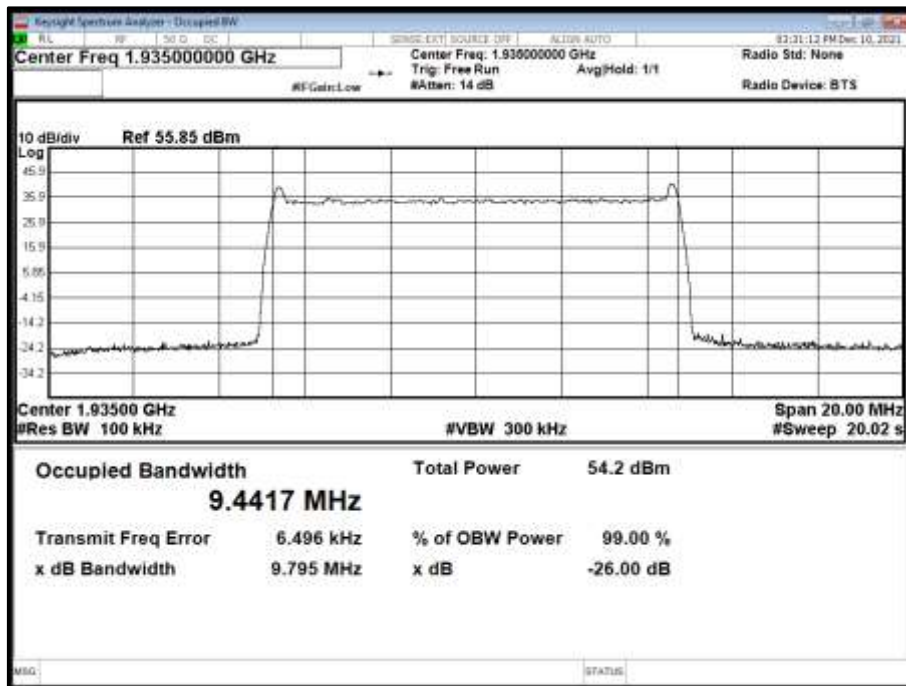



Antenna A - NR Modulation QPSK - NR Carrier Bandwidth 10.0 MHz 15 kHz SCS - Channel Position M

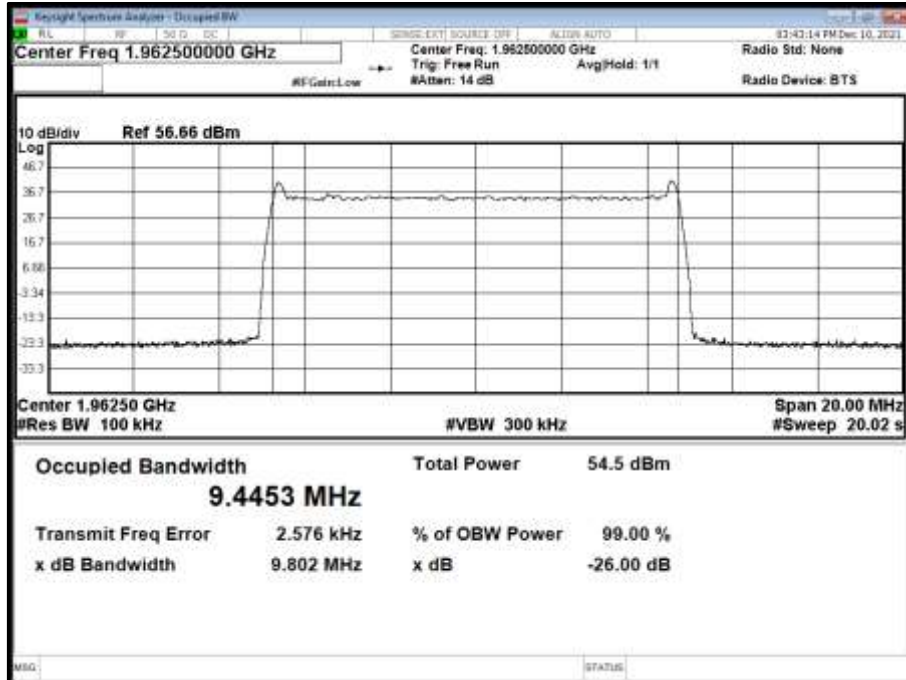

Antenna A - NR Modulation QPSK - NR Carrier Bandwidth 10.0 MHz 15 kHz SCS - Channel Position T

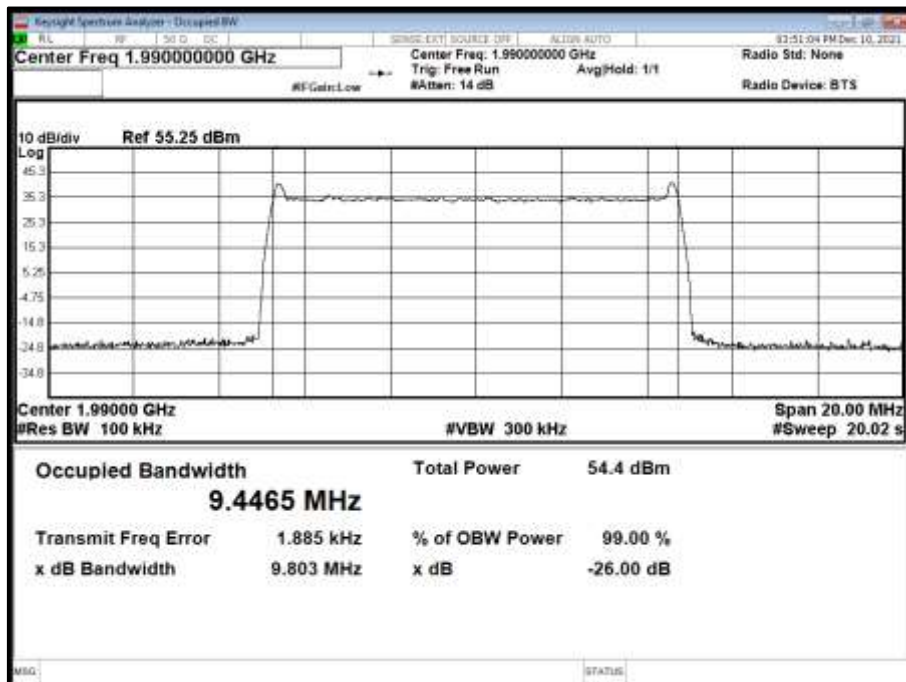



Antenna A - NR Modulation QPSK - NR Carrier Bandwidth 15.0 MHz 15 kHz SCS - Channel  
Position B

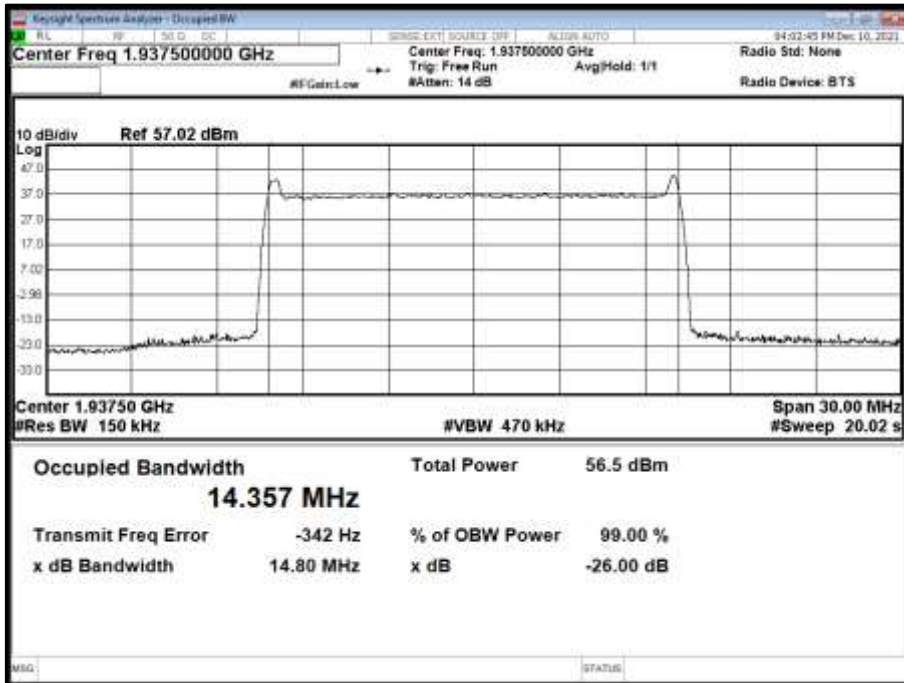

Antenna A - NR Modulation QPSK - NR Carrier Bandwidth 15.0 MHz 15 kHz SCS - Channel  
Position M

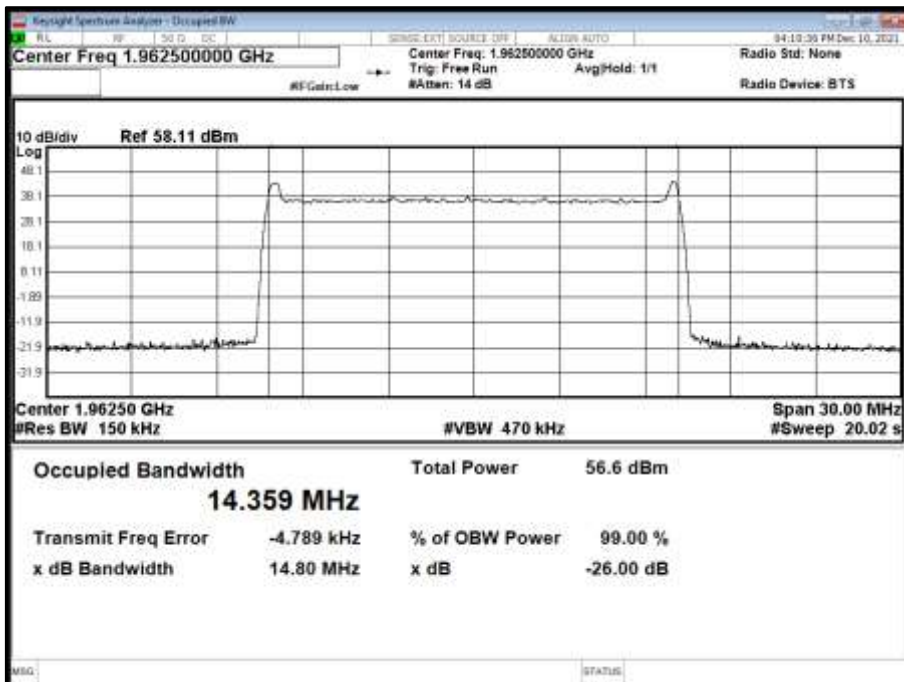



Antenna A - NR Modulation QPSK - NR Carrier Bandwidth 15.0 MHz 15 kHz SCS - Channel Position T

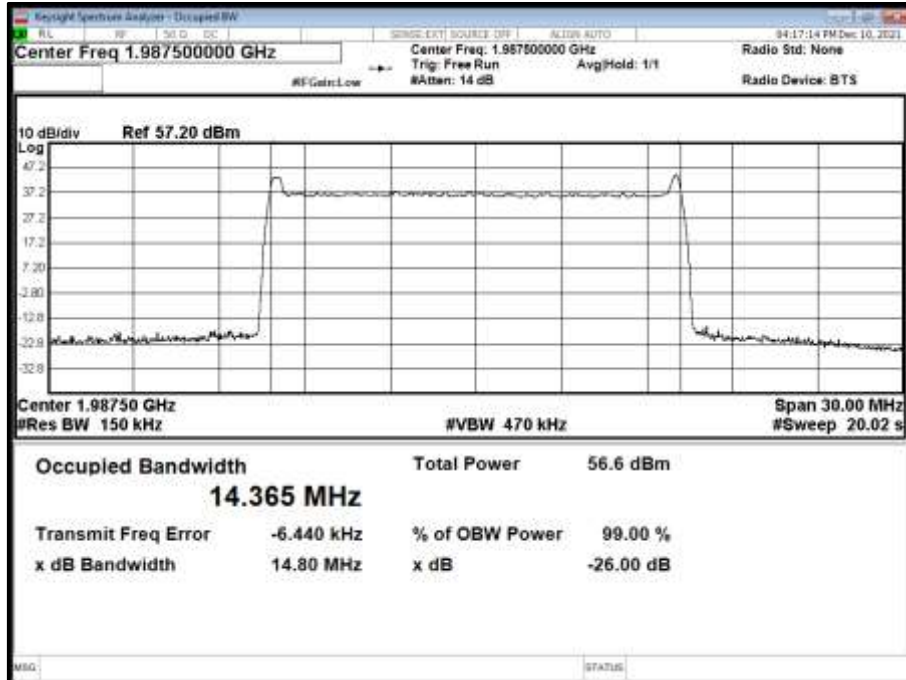

Antenna A - NR Modulation QPSK - NR Carrier Bandwidth 20.0 MHz 15 kHz SCS - Channel Position B

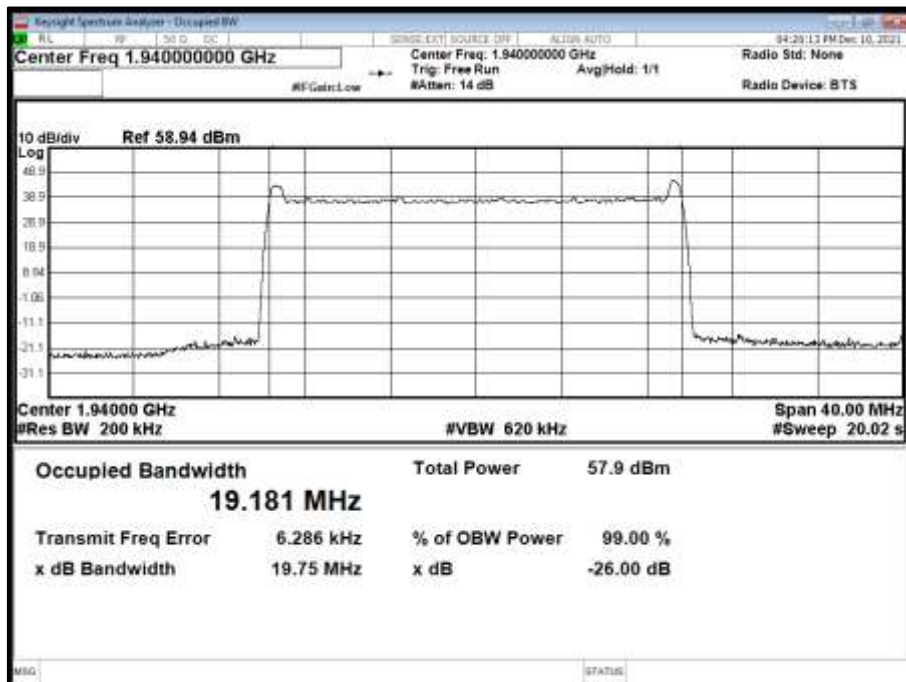





Antenna A - NR Modulation QPSK - NR Carrier Bandwidth 20.0 MHz 15 kHz SCS - Channel Position M

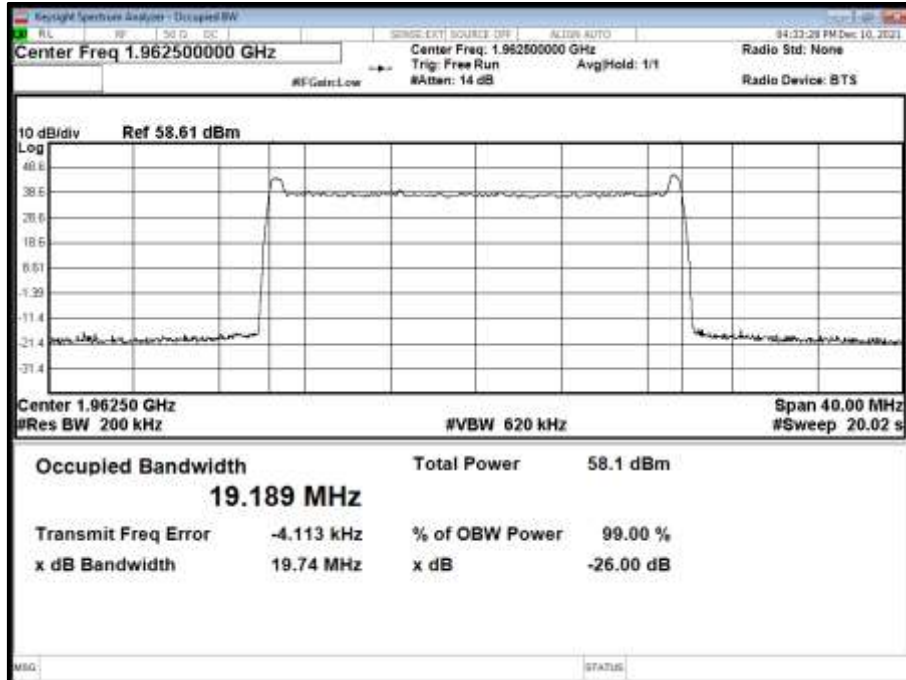

Antenna A - NR Modulation QPSK - NR Carrier Bandwidth 20.0 MHz 15 kHz SCS - Channel Position T

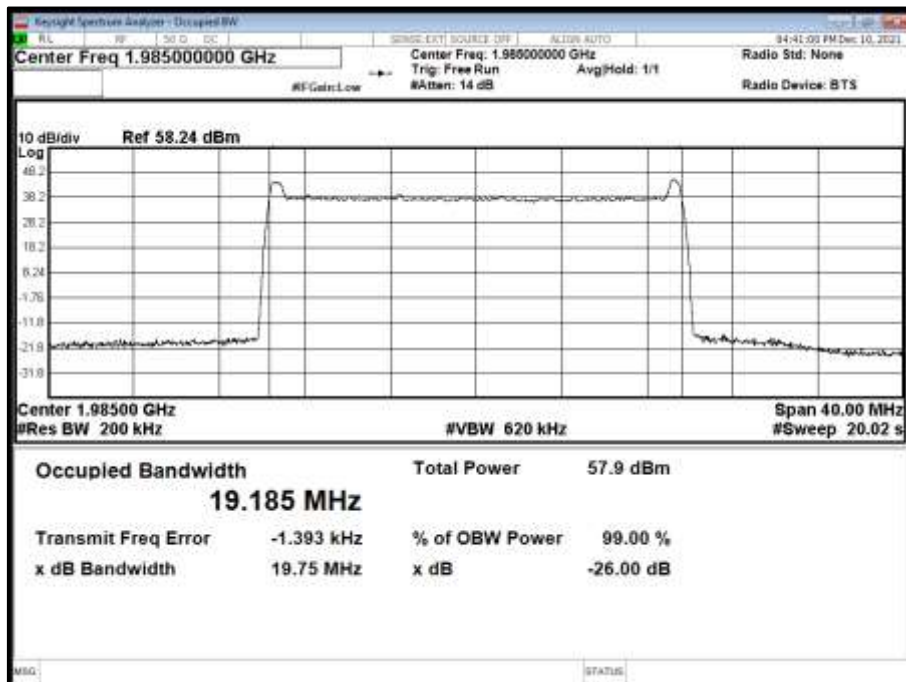



Configuration 2

Maximum Output Power 47.78 dBm

Antenna	NR Modulation	NR Carrier Bandwidth	Result (kHz)					
			Channel Position B		Channel Position M		Channel Position T	
			Occupied Bandwidth	-26 dB Bandwidth	Occupied Bandwidth	-26 dB Bandwidth	Occupied Bandwidth	-26 dB Bandwidth
A	QPSK	10.0 MHz 15 kHz SCS	-	-	9444.47	9799.99	9436.87	9807.37
A	QPSK	15.0 MHz 15 kHz SCS	-	-	14364.75	14801.93	14365.42	14805.59
A	QPSK	20.0 MHz 15 kHz SCS	-	-	19188.45	19743.60	19184.91	19752.71

Antenna A - NR Modulation QPSK - NR Carrier Bandwidth 10.0 MHz 15 kHz SCS - Channel Position M

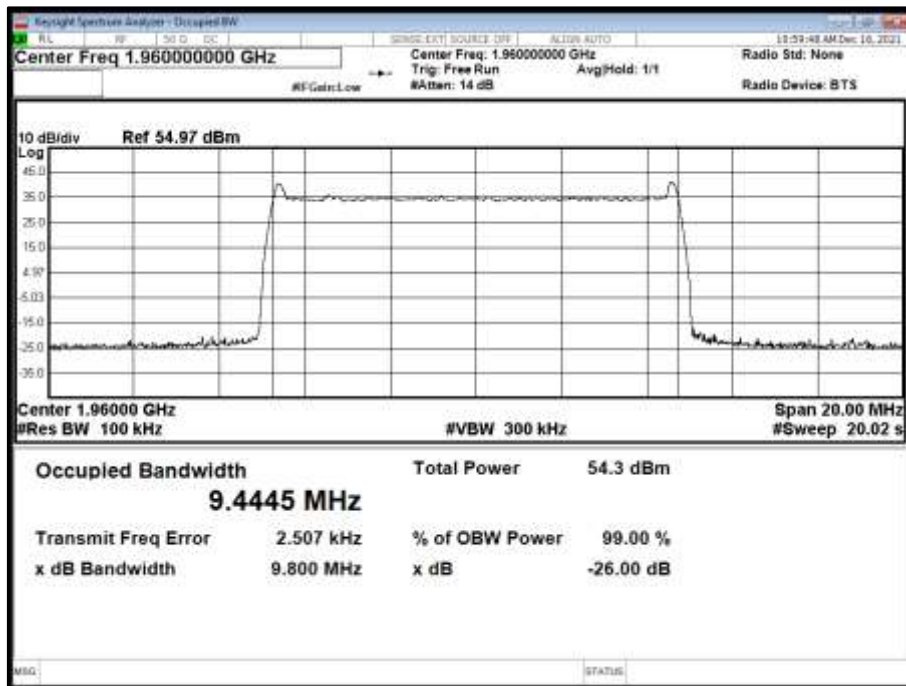



Antenna A - NR Modulation QPSK - NR Carrier Bandwidth 10.0 MHz 15 kHz SCS - Channel Position T

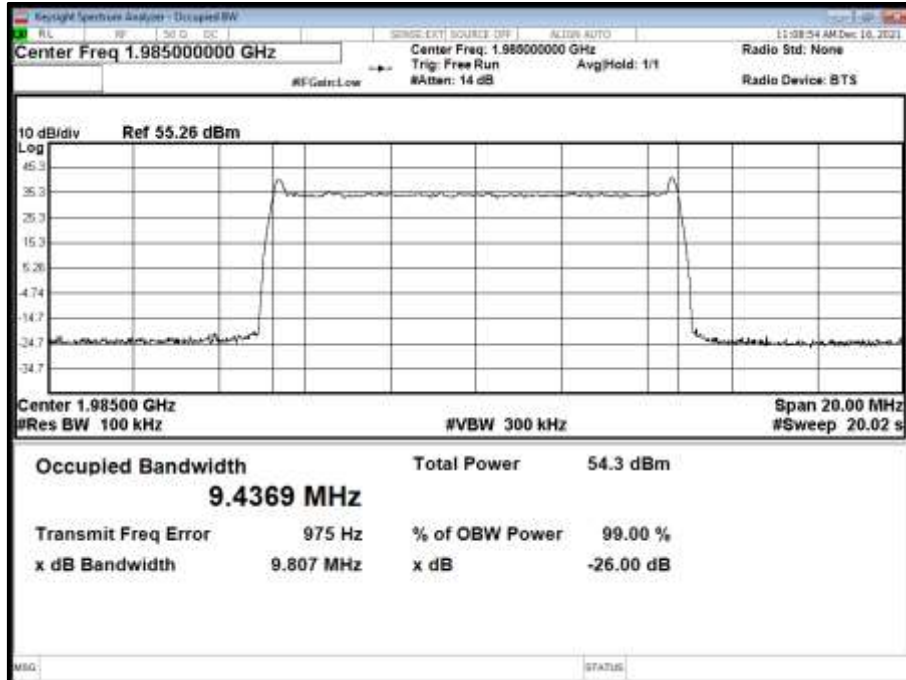

Antenna A - NR Modulation QPSK - NR Carrier Bandwidth 15.0 MHz 15 kHz SCS - Channel Position M

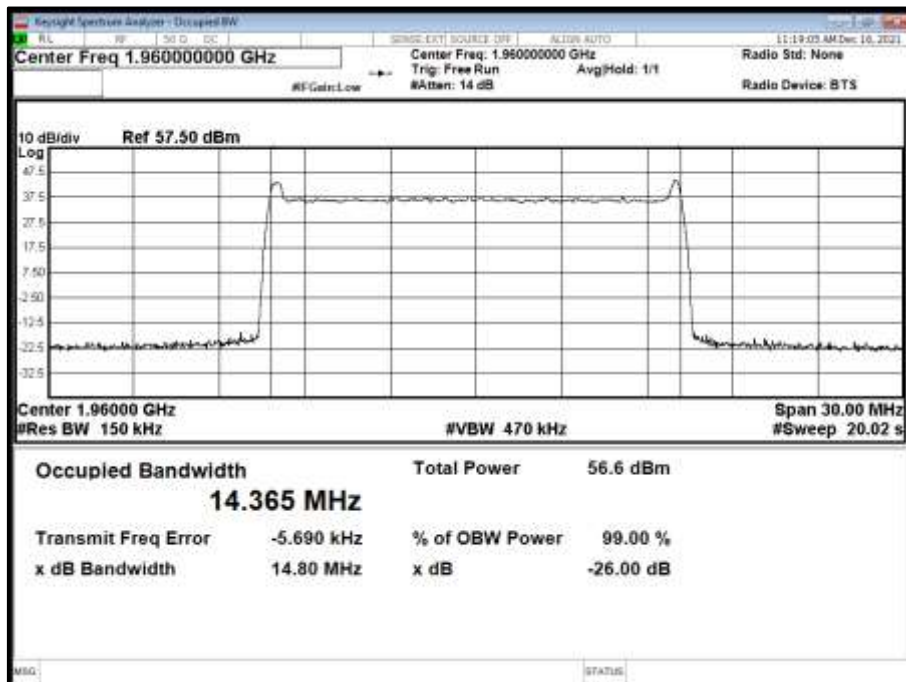



Antenna A - NR Modulation QPSK - NR Carrier Bandwidth 15.0 MHz 15 kHz SCS - Channel Position T

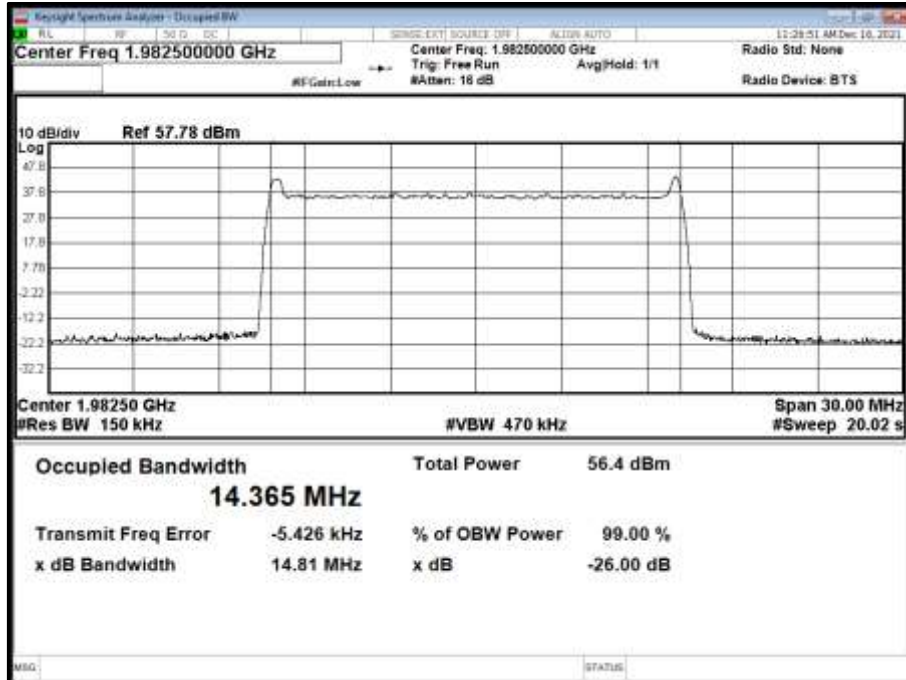

Antenna A - NR Modulation QPSK - NR Carrier Bandwidth 20.0 MHz 15 kHz SCS - Channel Position M

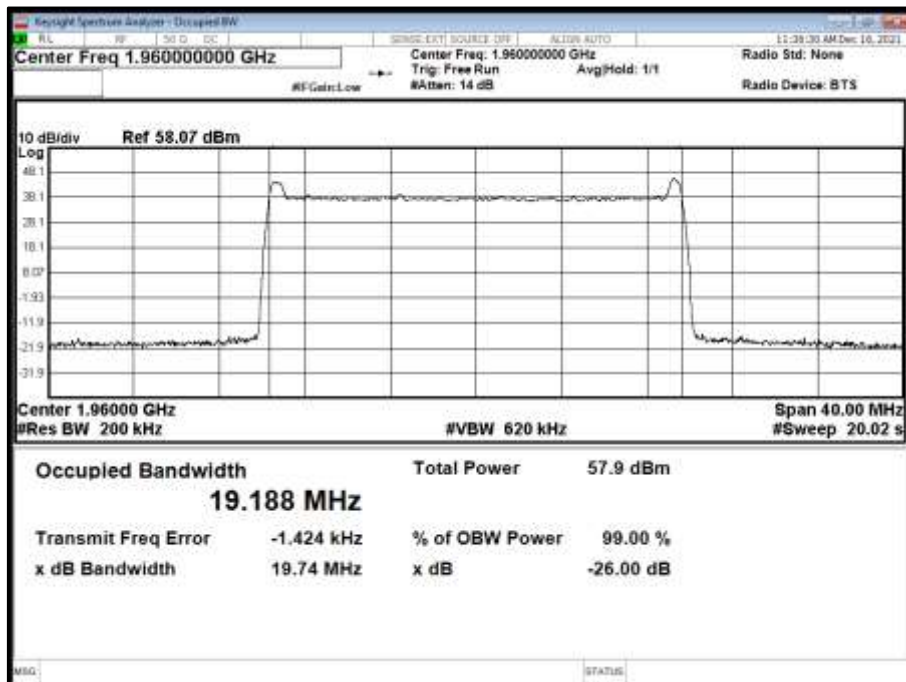



Antenna A - NR Modulation QPSK - NR Carrier Bandwidth 20.0 MHz 15 kHz SCS - Channel Position T

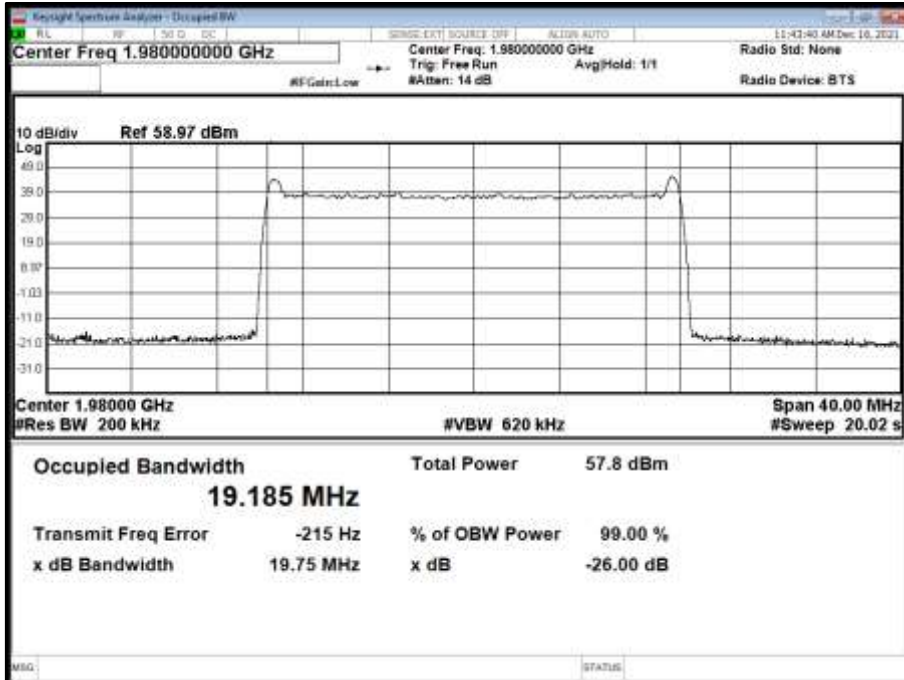



## 2.3 BAND EDGE

### 2.3.1 Specification Reference

FCC CFR 47 Part 24, Clause 24.238 (b)  
Industry Canada RSS-133, Clause 6.5  
FCC CFR 47 Part 2, Clause 2.1051

### 2.3.2 Date of Test and Modification State

10-December-2021 - Modification State 0

### 2.3.3 Test Equipment Used

The major items of test equipment used for the above tests are identified in Section 3.1.

### 2.3.4 Environmental Conditions

Ambient Temperature 21.2°C  
Relative Humidity 35.0%

### 2.3.5 Test Method

All measurements were made in accordance with FCC KDB 971168 D01, Clause 6.0.

Band Edge measurements were used an Integration Bandwidth of at least 1% of the measured 26dB Bandwidth.

Each antenna port has been declared as being equivalent, therefore measurements were made on one antenna port only. To account for this, the limit was tightened by  $10 * \text{Log}(N)$ , where N is equal to the number of MIMO antenna ports.

For single port, the limit was calculated as being  $-13 \text{ dBm} - 10 * \text{Log}(4) = -19 \text{ dBm}$ .

### 2.3.6 Test Results

Configuration 1

Maximum Output Power 47.78 dBm

Antenna	NR Modulation	NR Carrier Bandwidth	Band Edge (MHz)	
			Channel Position B	Channel Position T
A	QPSK	10.0 MHz 15 kHz SCS	1,935.0	1,990.0
A	QPSK	15.0 MHz 15 kHz SCS	1,937.5	1,987.5
A	QPSK	20.0 MHz 15 kHz SCS	1,940.0	1,985.0



Antenna A - NR Modulation QPSK - NR Carrier Bandwidth 10.0 MHz 15 kHz SCS - Channel Position B

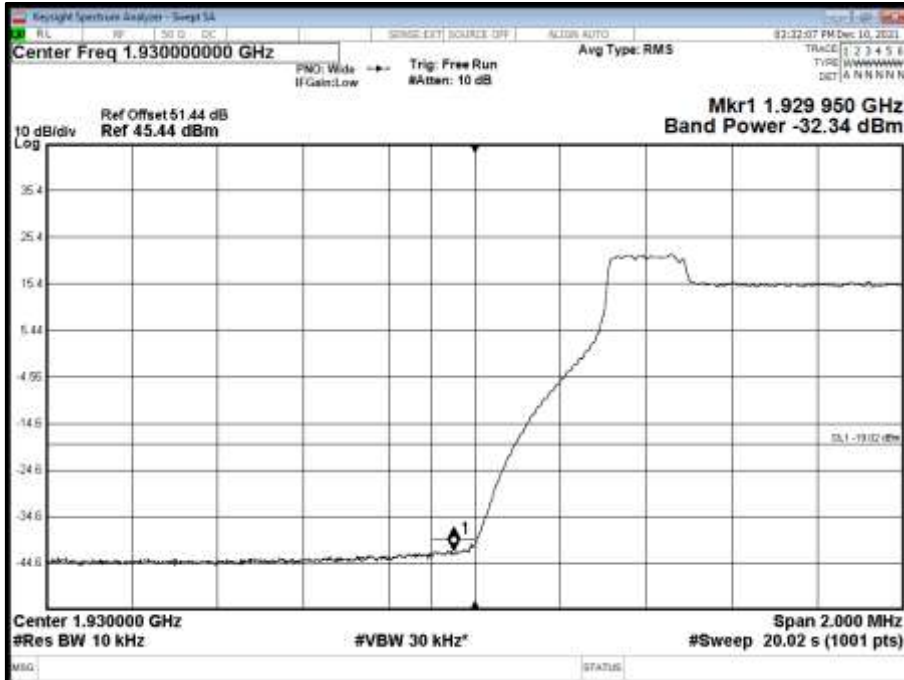

Antenna A - NR Modulation QPSK - NR Carrier Bandwidth 10.0 MHz 15 kHz SCS - Channel Position T

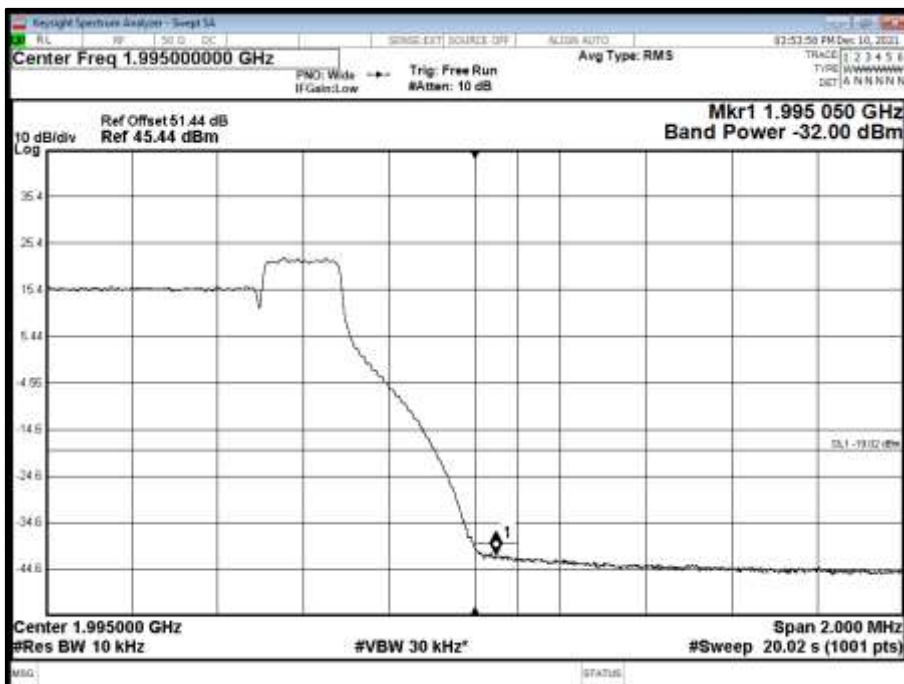



Antenna A - NR Modulation QPSK - NR Carrier Bandwidth 15.0 MHz 15 kHz SCS - Channel Position B

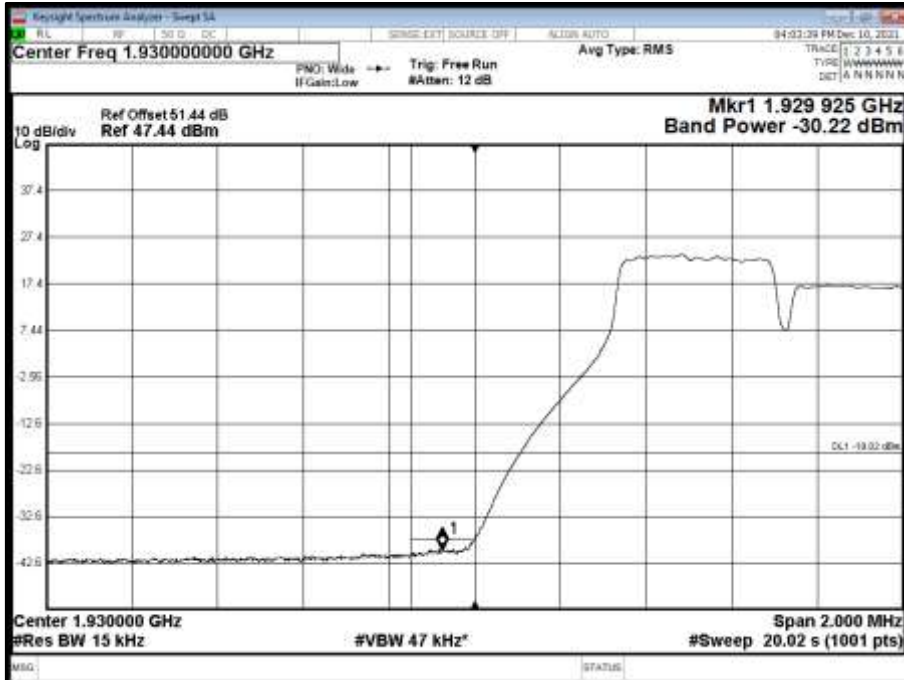

Antenna A - NR Modulation QPSK - NR Carrier Bandwidth 15.0 MHz 15 kHz SCS - Channel Position T

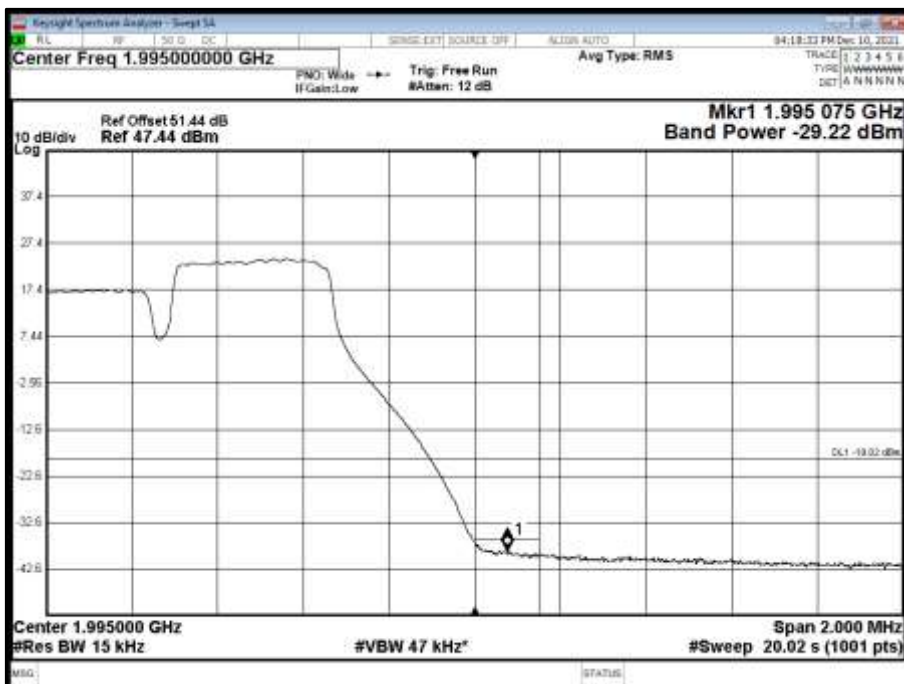





Antenna A - NR Modulation QPSK - NR Carrier Bandwidth 20.0 MHz 15 kHz SCS - Channel Position B

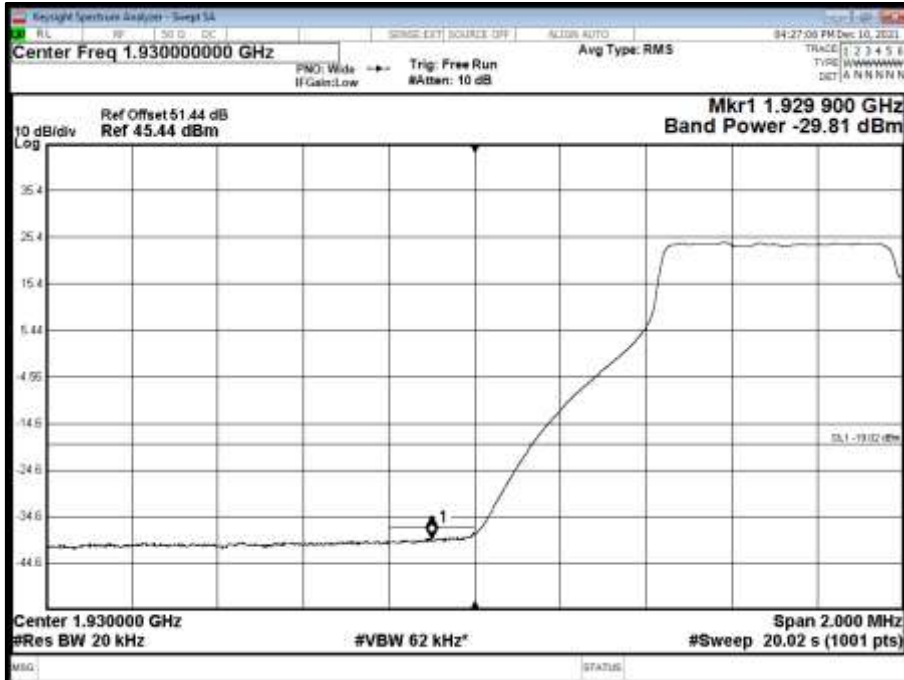

Antenna A - NR Modulation QPSK - NR Carrier Bandwidth 20.0 MHz 15 kHz SCS - Channel Position T

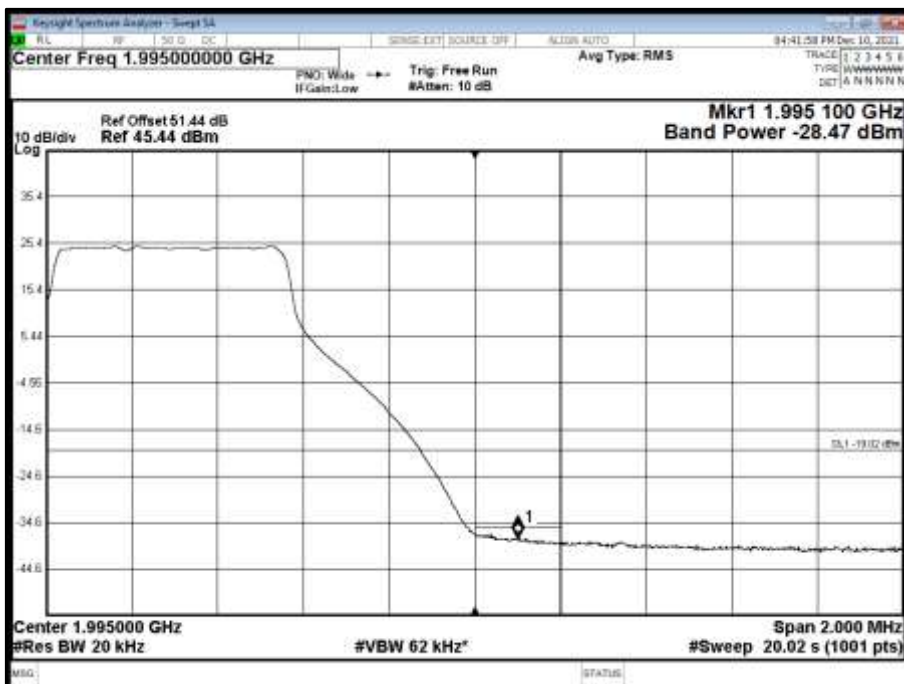



Configuration 2

Maximum Output Power 47.78 dBm

Antenna	NR Modulation	NR Carrier Bandwidth	Band Edge (MHz)	
			Channel Position B	Channel Position T
A	QPSK	10.0 MHz 15 kHz SCS	-	1,985.0
A	QPSK	15.0 MHz 15 kHz SCS	-	1,982.5
A	QPSK	20.0 MHz 15 kHz SCS	-	1,980.0

Antenna A - NR Modulation QPSK - NR Carrier Bandwidth 10.0 MHz 15 kHz SCS - Channel Position T

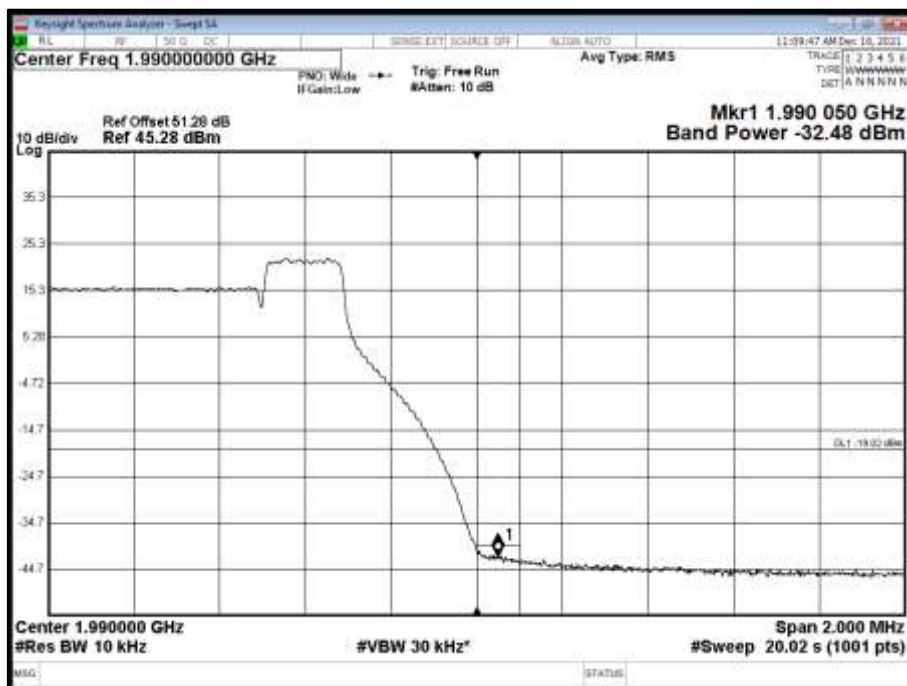



Antenna A - NR Modulation QPSK - NR Carrier Bandwidth 15.0 MHz 15 kHz SCS - Channel Position T

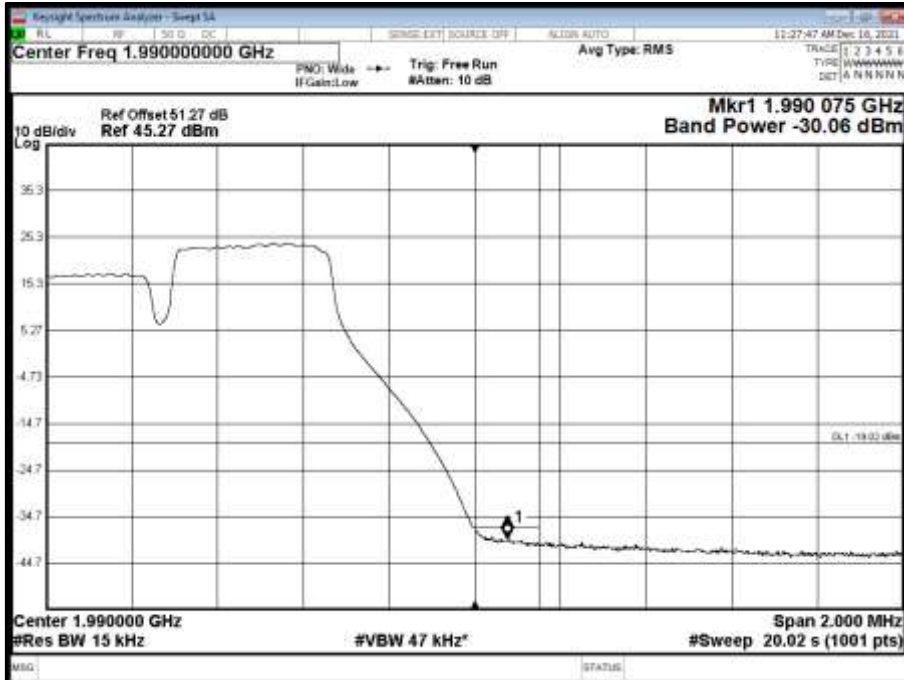

Antenna A - NR Modulation QPSK - NR Carrier Bandwidth 20.0 MHz 15 kHz SCS - Channel Position T

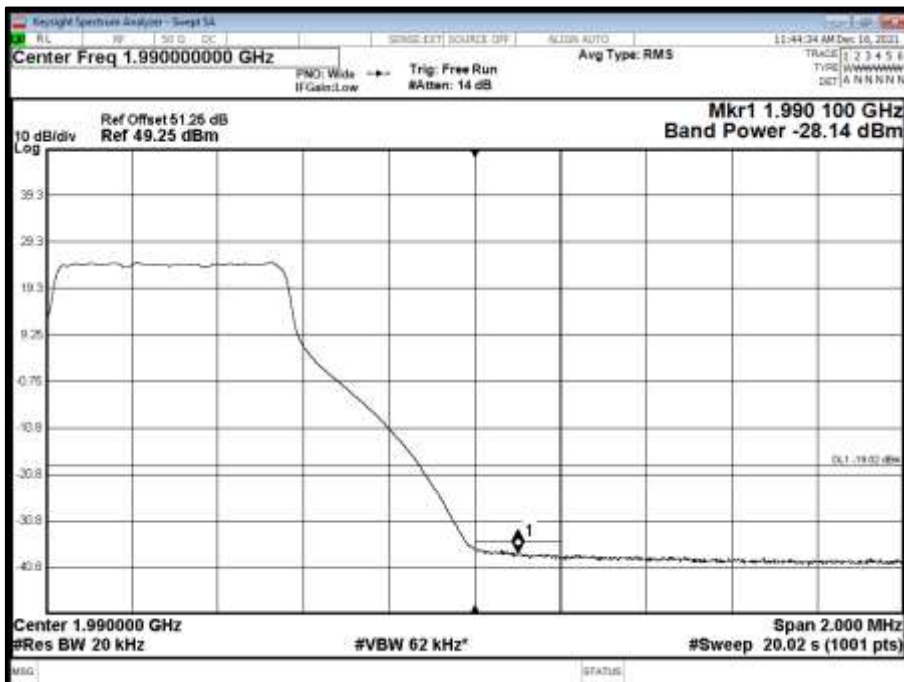

Limit	-19 dBm
-------	---------



## **2.4 TRANSMITTER SPURIOUS EMISSIONS**

### **2.4.1 Specification Reference**

FCC CFR 47 Part 24, Clause 24.238 (a)  
ISED RSS-GEN, Clause 6.13  
Industry Canada RSS-133, Clause 6.5  
FCC CFR 47 Part 2, Clause 2.1051

### **2.4.2 Date of Test and Modification State**

10-December-2021 - Modification State 0

### **2.4.3 Test Equipment Used**

The major items of test equipment used for the above tests are identified in Section 3.1.

### **2.4.4 Environmental Conditions**

Ambient Temperature	21.2°C
Relative Humidity	35.0%

### **2.4.5 Test Method**

All measurements were made in accordance with FCC KDB 971168 D01, Clause 6.1.

Each antenna port has been declared as being equivalent, therefore measurements were made on one antenna port only. To account for this, the limit was tightened by  $10 * \text{Log}(N)$ , where N is equal to the number of MIMO antenna ports.

For single port, the limit was calculated as being  $-13 \text{ dBm} - 10 * \text{Log}(4) = -19 \text{ dBm}$ .

### **2.4.6 Test Results**

Configuration 1

Maximum Output Power 47.78 dBm



Antenna A - NR Modulation QPSK - NR Carrier Bandwidth 10.0 MHz 15 kHz SCS - Channel Position B - Band 1 - Range 0.009 to 3500 MHz

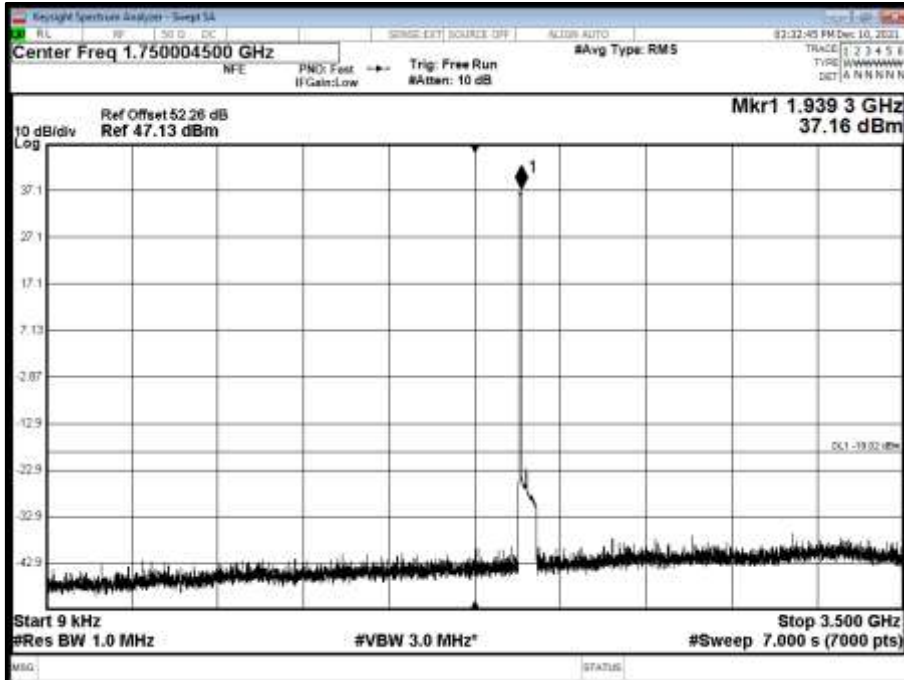

Antenna A - NR Modulation QPSK - NR Carrier Bandwidth 10.0 MHz 15 kHz SCS - Channel Position B - Band 2 - Range 3500 to 8000 MHz

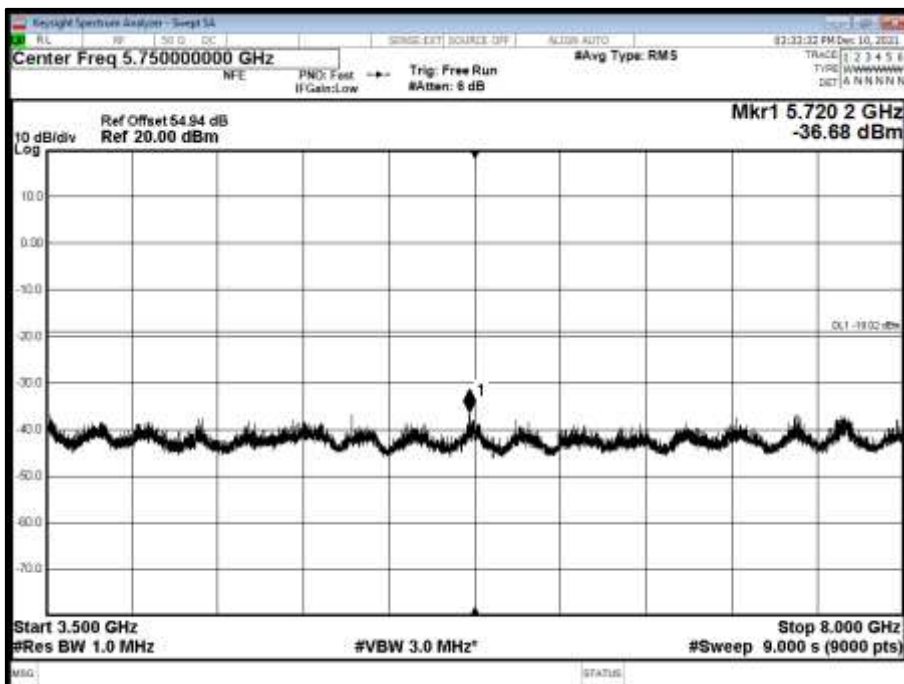



Antenna A - NR Modulation QPSK - NR Carrier Bandwidth 10.0 MHz 15 kHz SCS - Channel Position B - Band 3 - Range 8000 to 12000 MHz

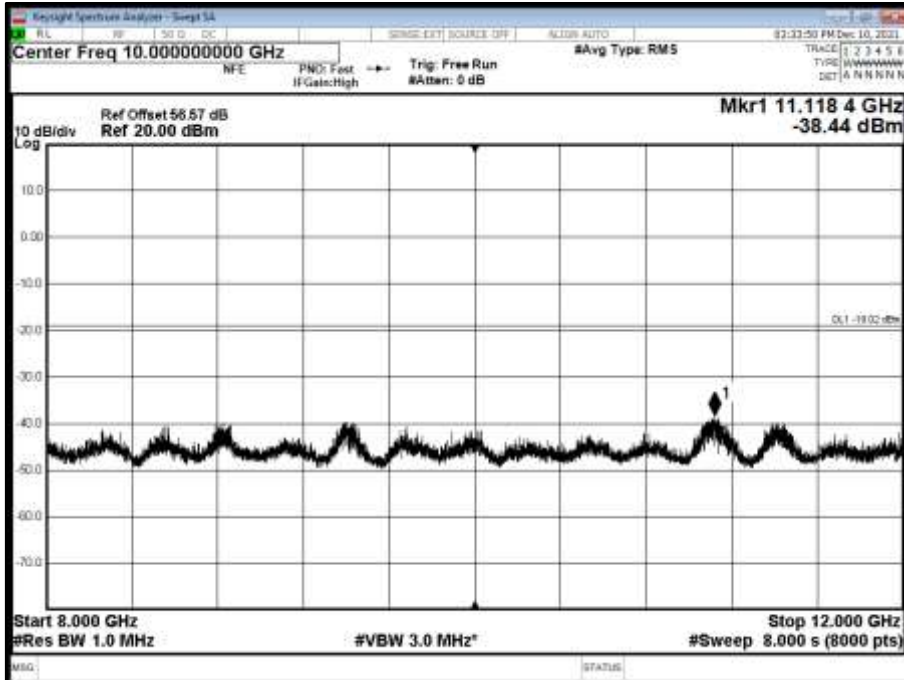

Antenna A - NR Modulation QPSK - NR Carrier Bandwidth 10.0 MHz 15 kHz SCS - Channel Position B - Band 4 - Range 12000 to 18000 MHz

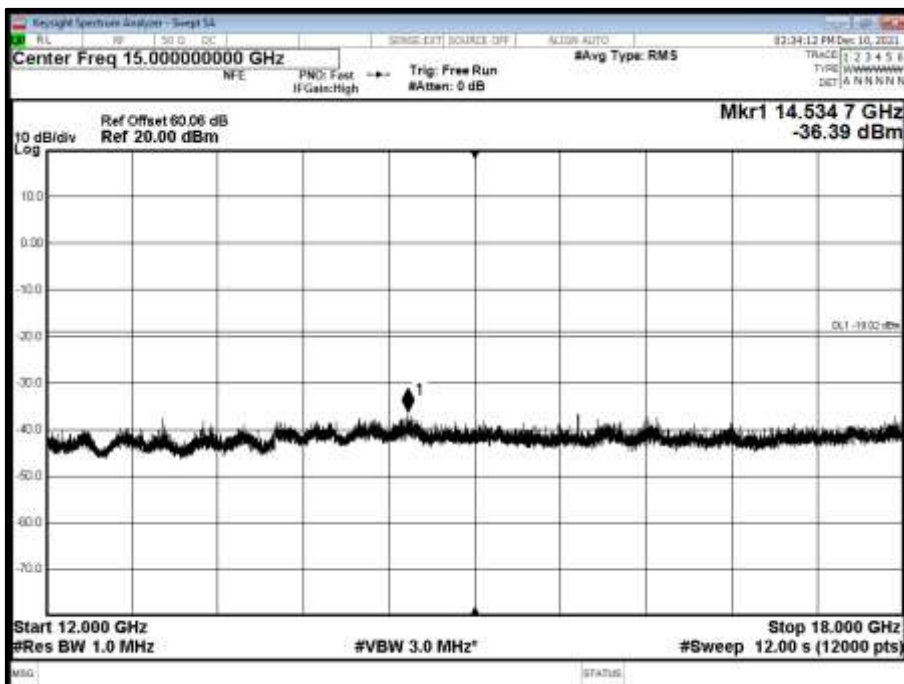



Antenna A - NR Modulation QPSK - NR Carrier Bandwidth 10.0 MHz 15 kHz SCS - Channel Position B - Band 5 - Range 18000 to 20000 MHz

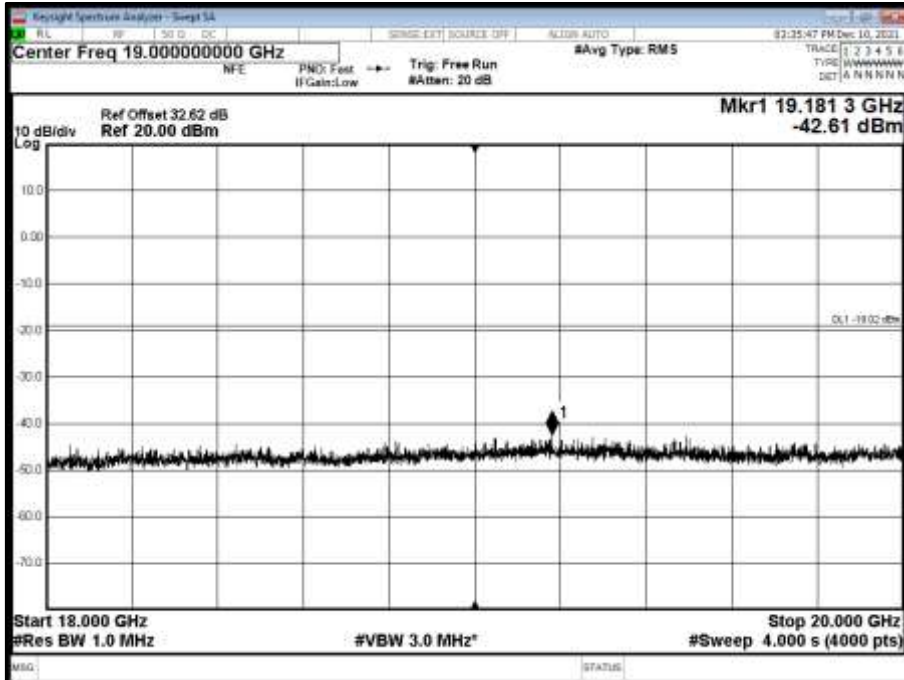

Antenna A - NR Modulation QPSK - NR Carrier Bandwidth 10.0 MHz 15 kHz SCS - Channel Position M - Band 1 - Range 0.009 to 3500 MHz

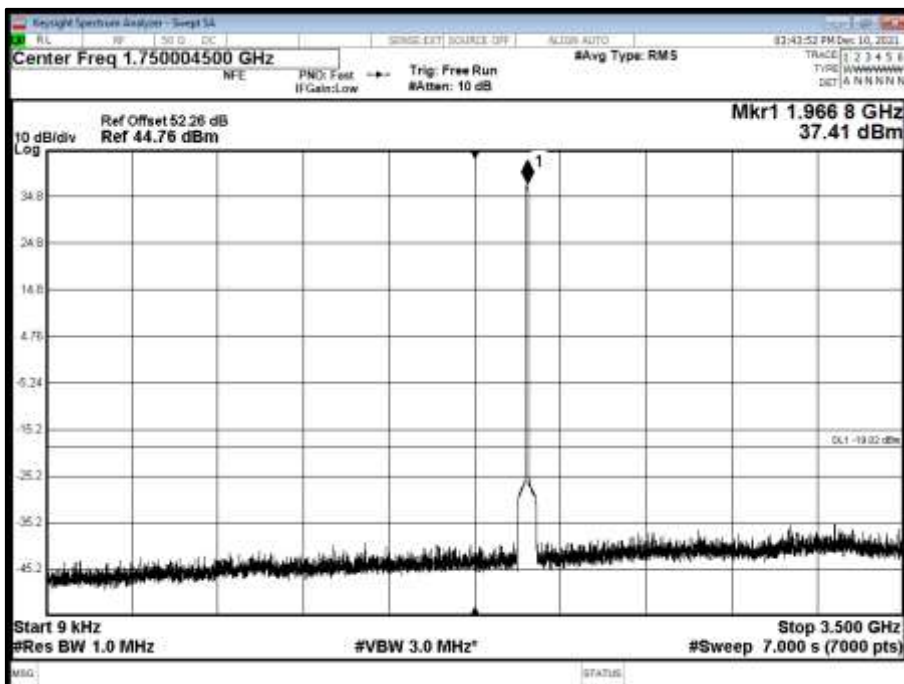



Antenna A - NR Modulation QPSK - NR Carrier Bandwidth 10.0 MHz 15 kHz SCS - Channel Position M - Band 2 - Range 3500 to 8000 MHz

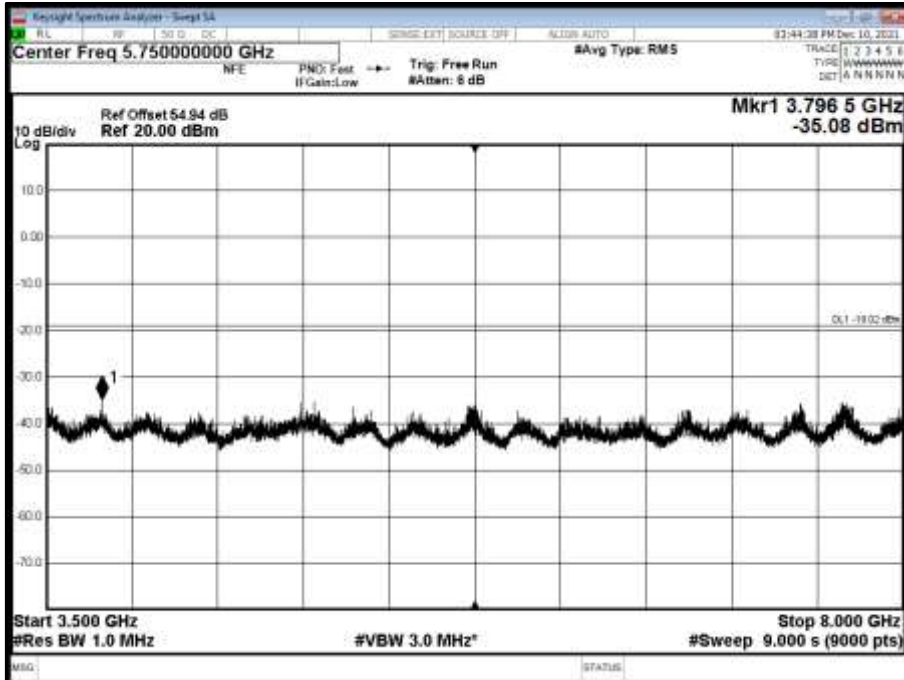

Antenna A - NR Modulation QPSK - NR Carrier Bandwidth 10.0 MHz 15 kHz SCS - Channel Position M - Band 3 - Range 8000 to 12000 MHz

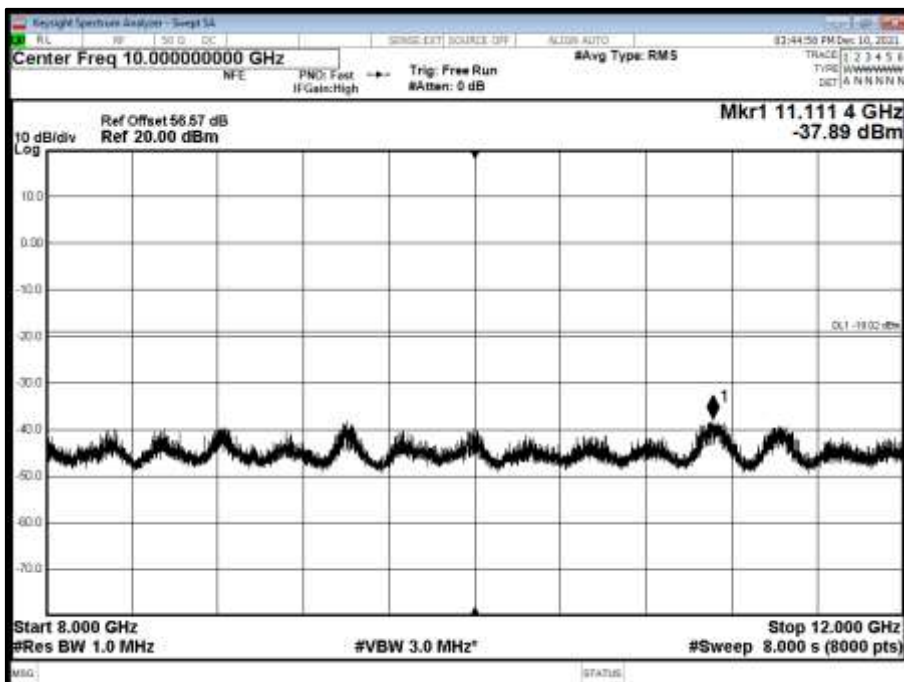





Antenna A - NR Modulation QPSK - NR Carrier Bandwidth 10.0 MHz 15 kHz SCS - Channel Position M - Band 4 - Range 12000 to 18000 MHz

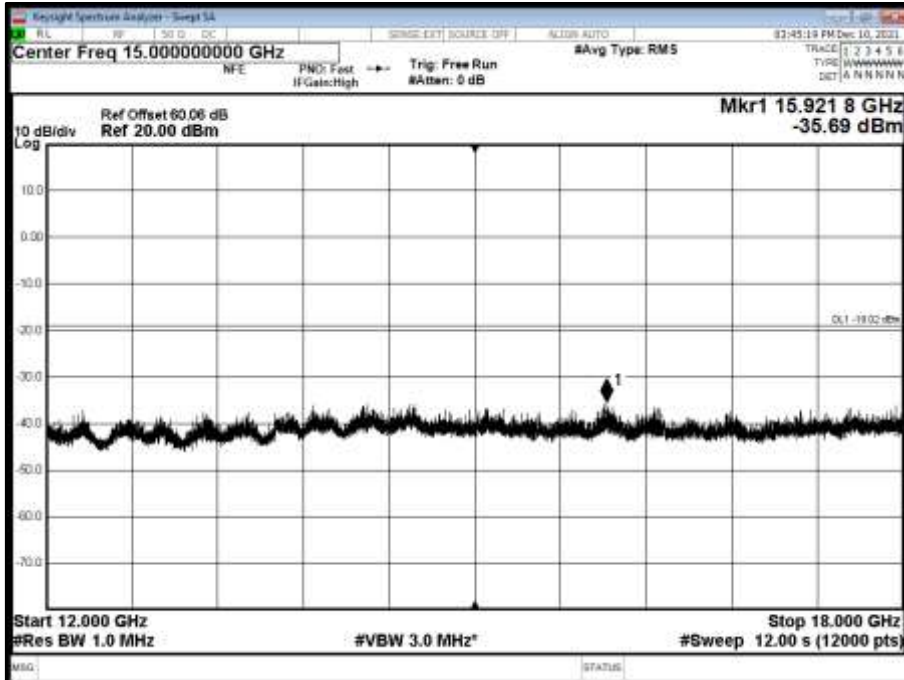

Antenna A - NR Modulation QPSK - NR Carrier Bandwidth 10.0 MHz 15 kHz SCS - Channel Position M - Band 5 - Range 18000 to 20000 MHz

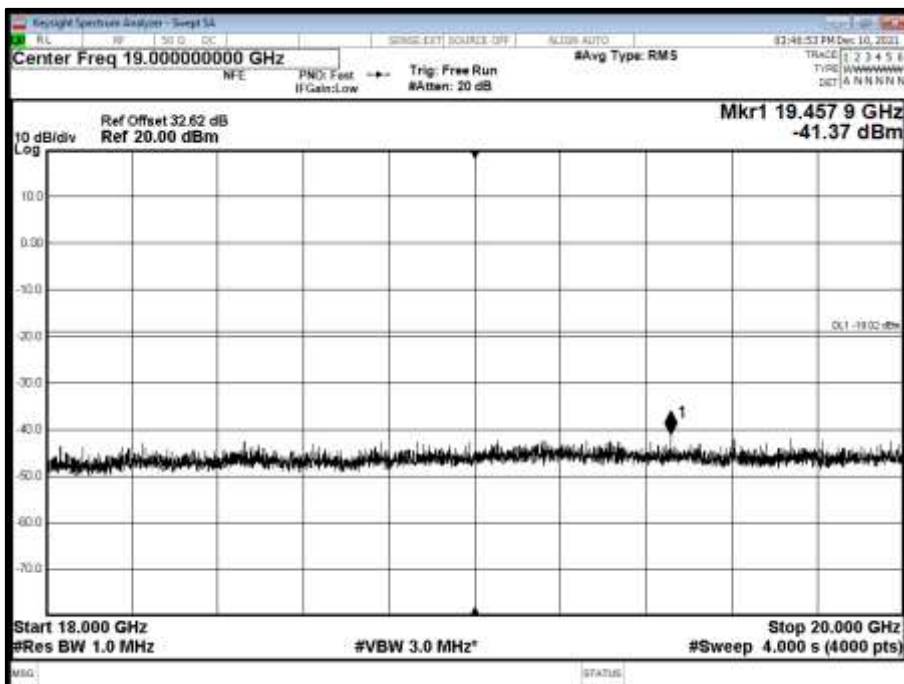



Antenna A - NR Modulation QPSK - NR Carrier Bandwidth 10.0 MHz 15 kHz SCS - Channel Position T - Band 1 - Range 0.009 to 3500 MHz

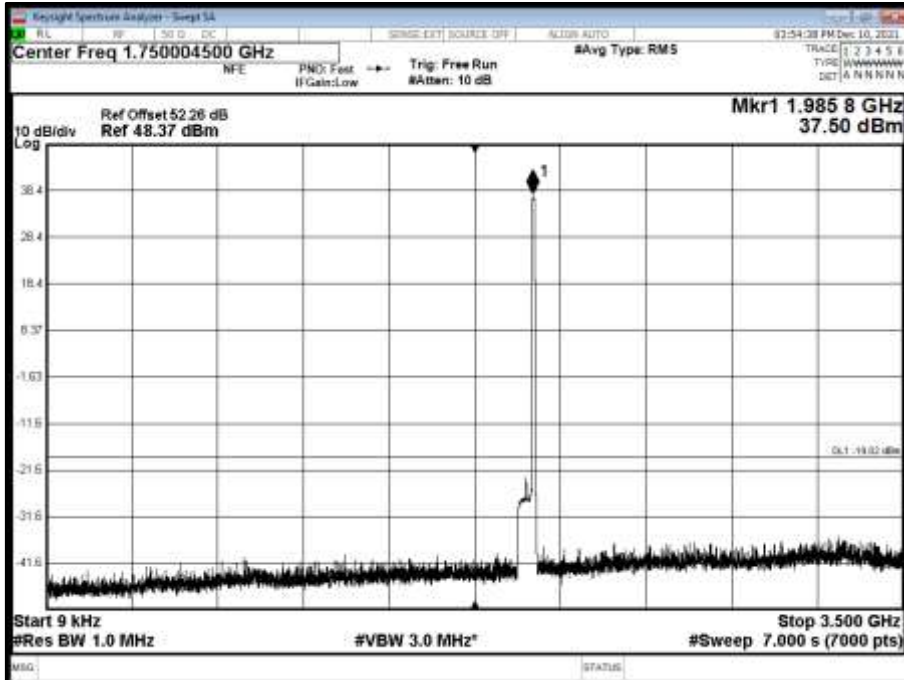

Antenna A - NR Modulation QPSK - NR Carrier Bandwidth 10.0 MHz 15 kHz SCS - Channel Position T - Band 2 - Range 3500 to 8000 MHz

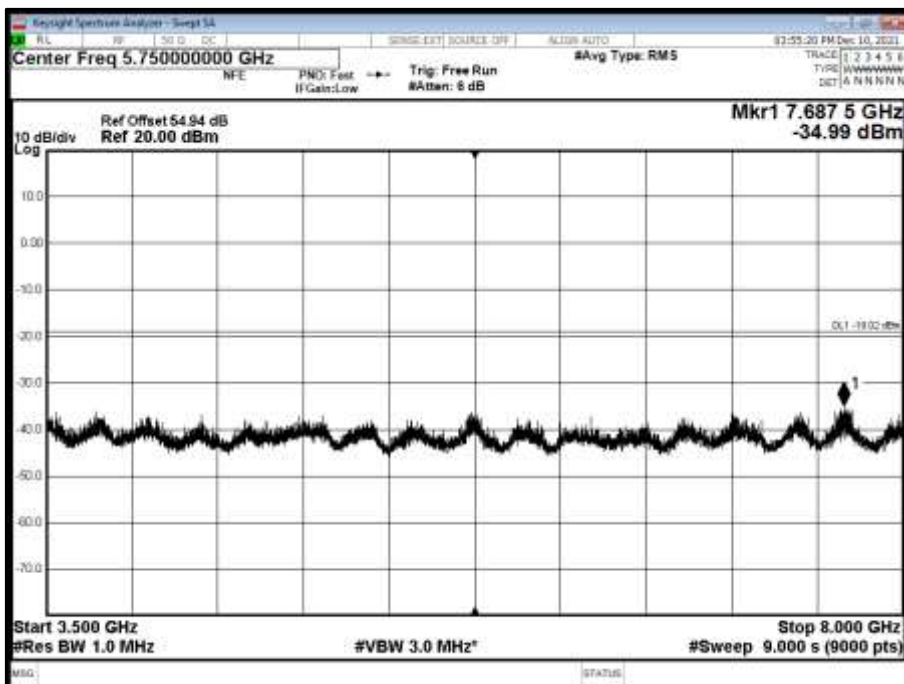



Antenna A - NR Modulation QPSK - NR Carrier Bandwidth 10.0 MHz 15 kHz SCS - Channel Position T - Band 3 - Range 8000 to 12000 MHz

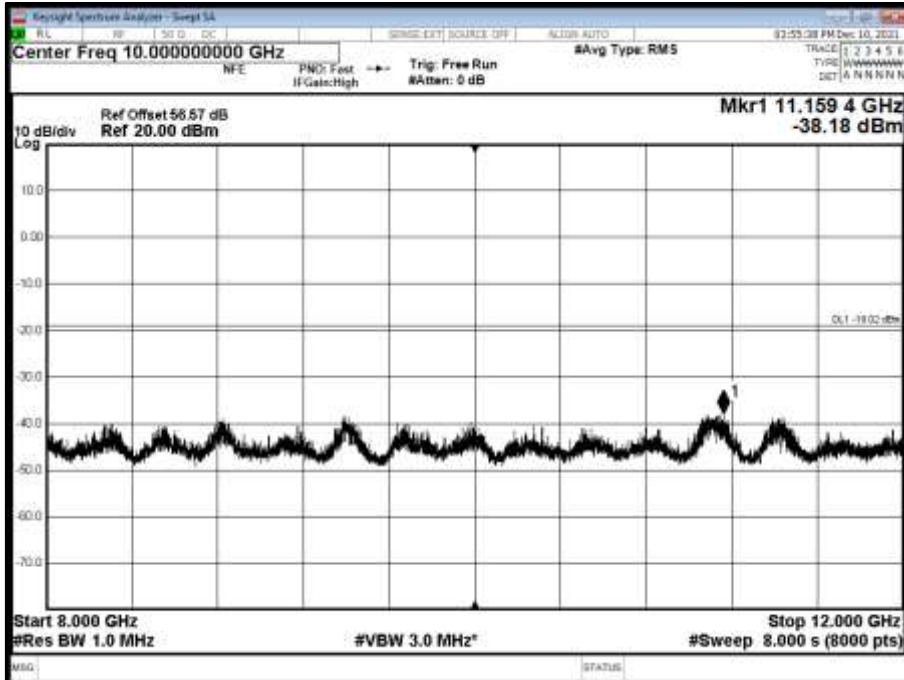

Antenna A - NR Modulation QPSK - NR Carrier Bandwidth 10.0 MHz 15 kHz SCS - Channel Position T - Band 4 - Range 12000 to 18000 MHz

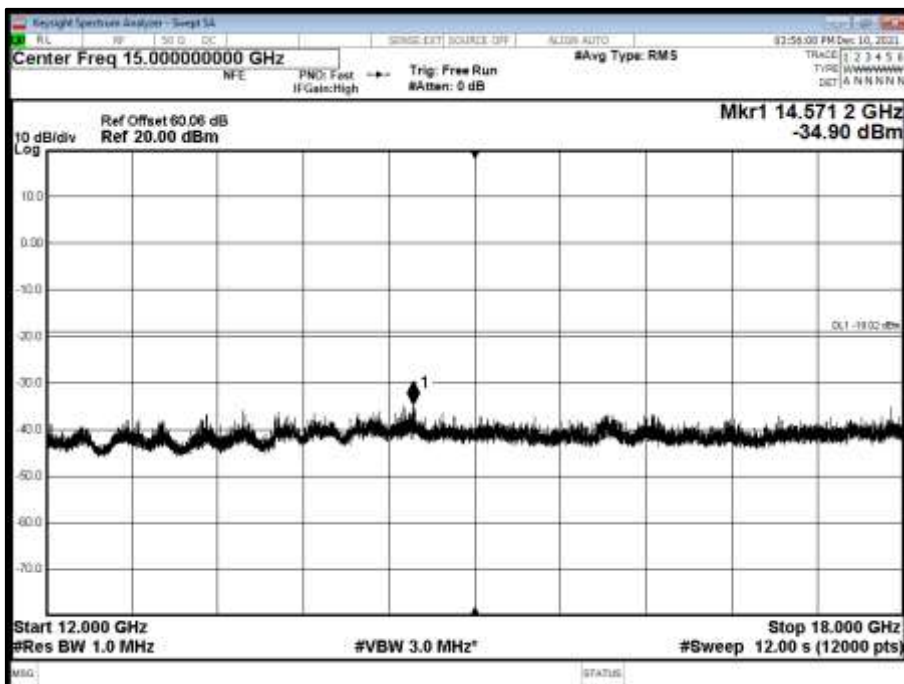



Antenna A - NR Modulation QPSK - NR Carrier Bandwidth 10.0 MHz 15 kHz SCS - Channel Position T - Band 5 - Range 18000 to 20000 MHz

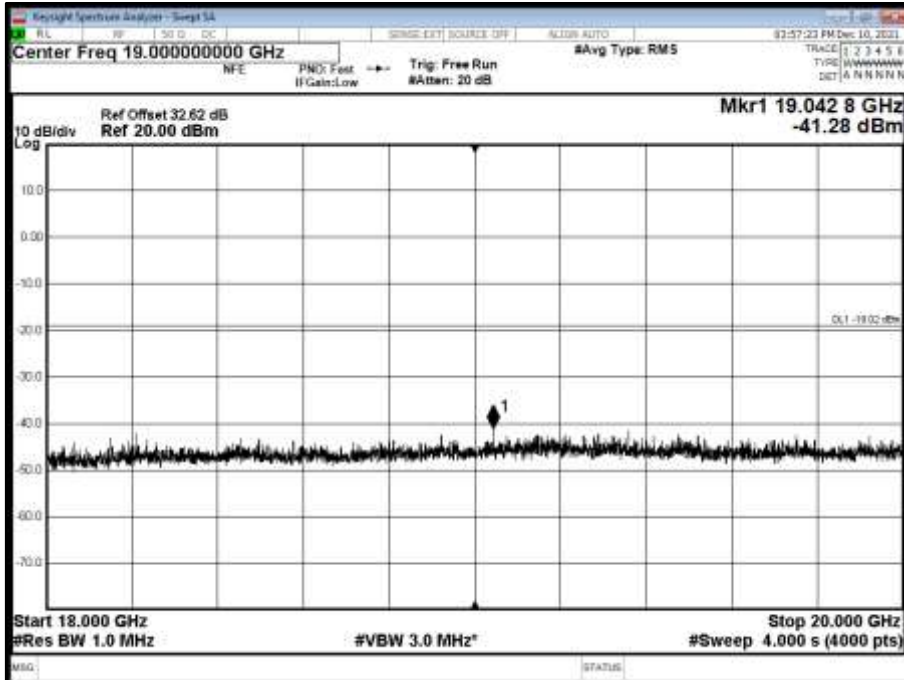

Antenna A - NR Modulation QPSK - NR Carrier Bandwidth 15.0 MHz 15 kHz SCS - Channel Position B - Band 1 - Range 0.009 to 3500 MHz

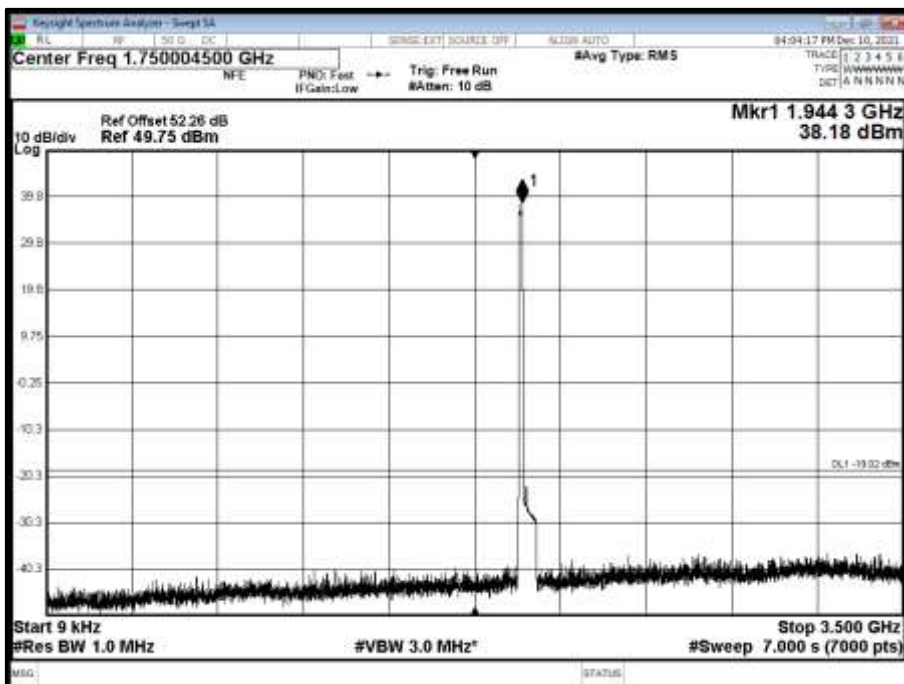



Antenna A - NR Modulation QPSK - NR Carrier Bandwidth 15.0 MHz 15 kHz SCS - Channel Position B - Band 2 - Range 3500 to 8000 MHz

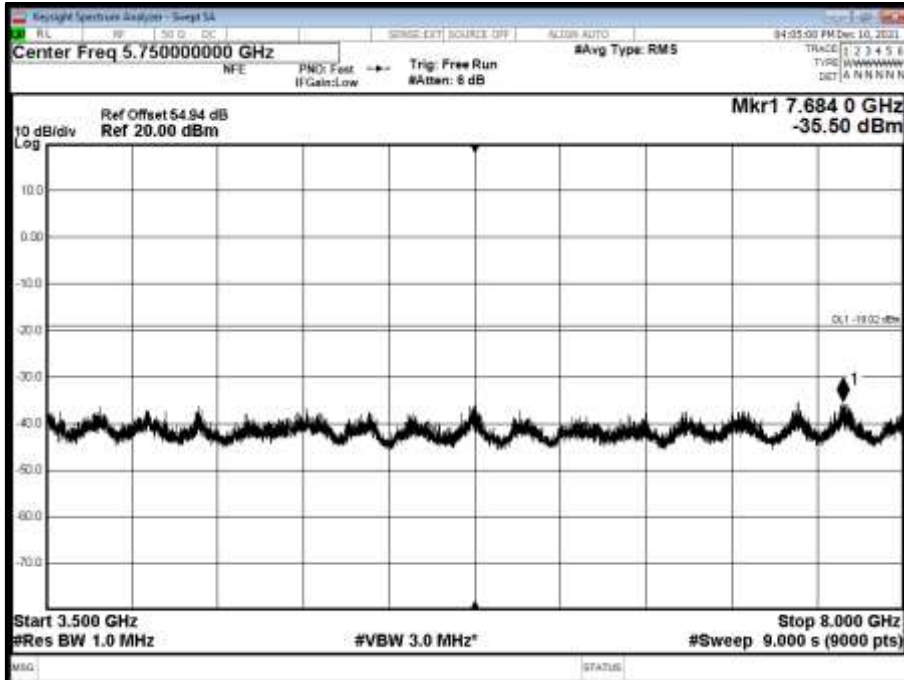

Antenna A - NR Modulation QPSK - NR Carrier Bandwidth 15.0 MHz 15 kHz SCS - Channel Position B - Band 3 - Range 8000 to 12000 MHz

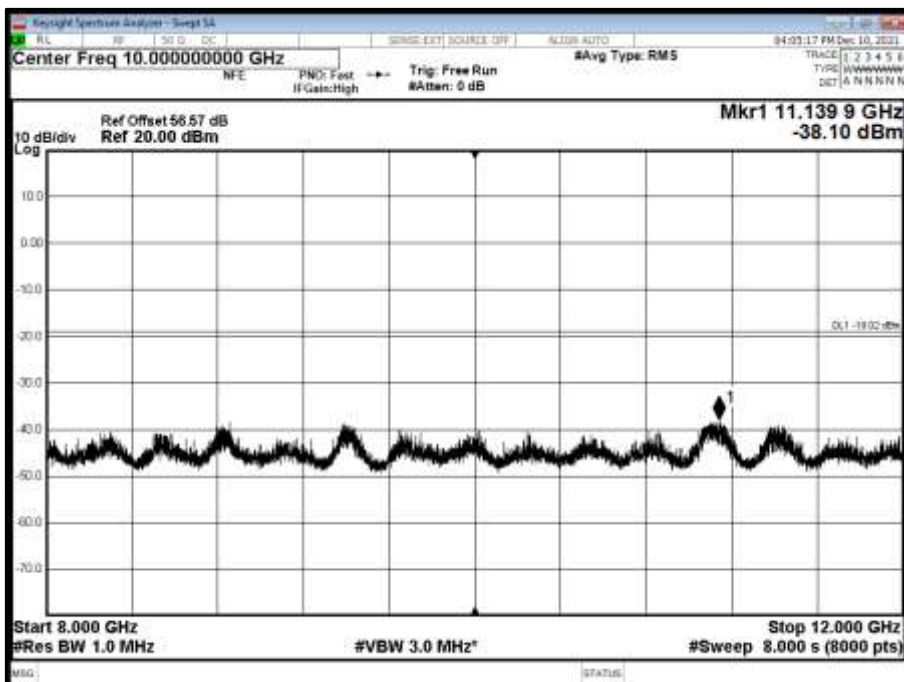



Antenna A - NR Modulation QPSK - NR Carrier Bandwidth 15.0 MHz 15 kHz SCS - Channel Position B - Band 4 - Range 12000 to 18000 MHz

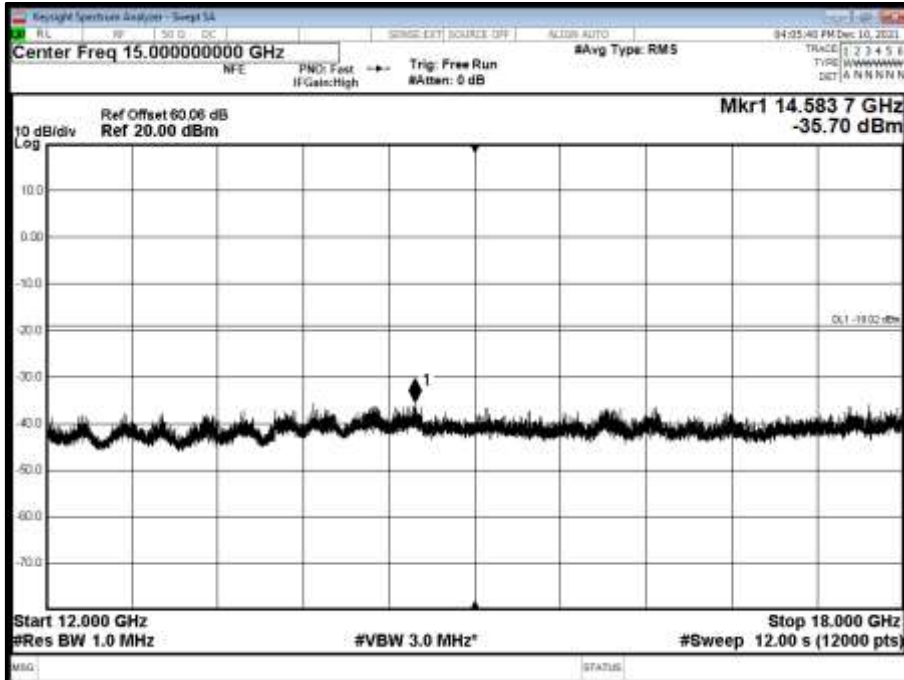

Antenna A - NR Modulation QPSK - NR Carrier Bandwidth 15.0 MHz 15 kHz SCS - Channel Position B - Band 5 - Range 18000 to 20000 MHz

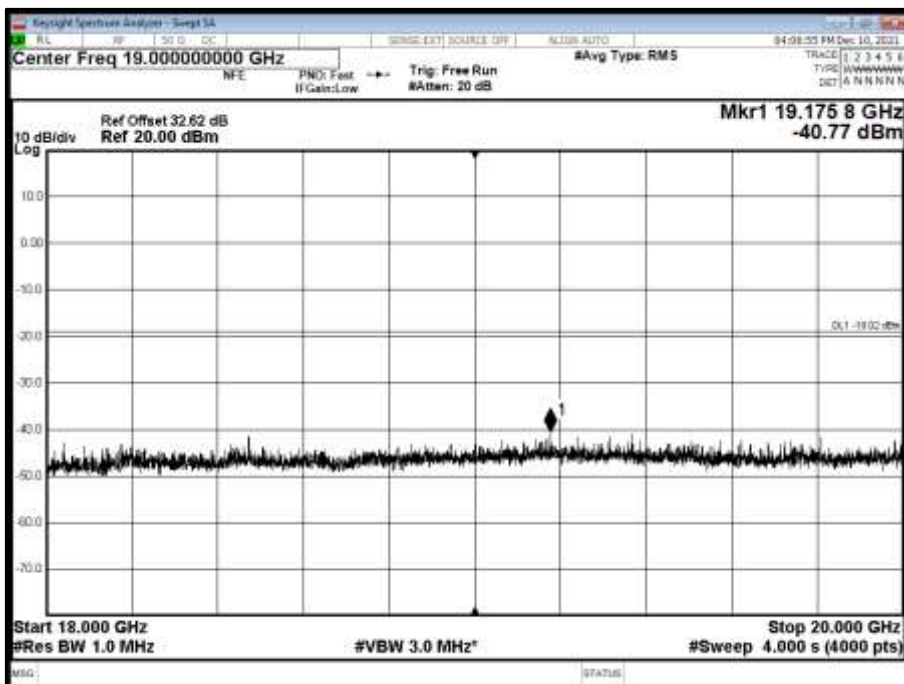



Antenna A - NR Modulation QPSK - NR Carrier Bandwidth 15.0 MHz 15 kHz SCS - Channel Position M - Band 1 - Range 0.009 to 3500 MHz

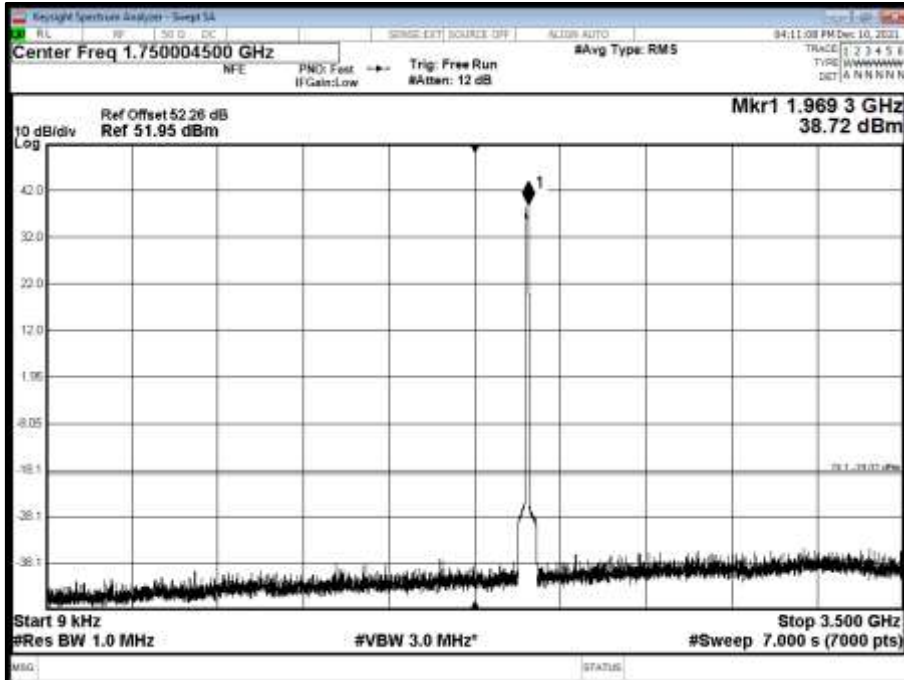

Antenna A - NR Modulation QPSK - NR Carrier Bandwidth 15.0 MHz 15 kHz SCS - Channel Position M - Band 2 - Range 3500 to 8000 MHz

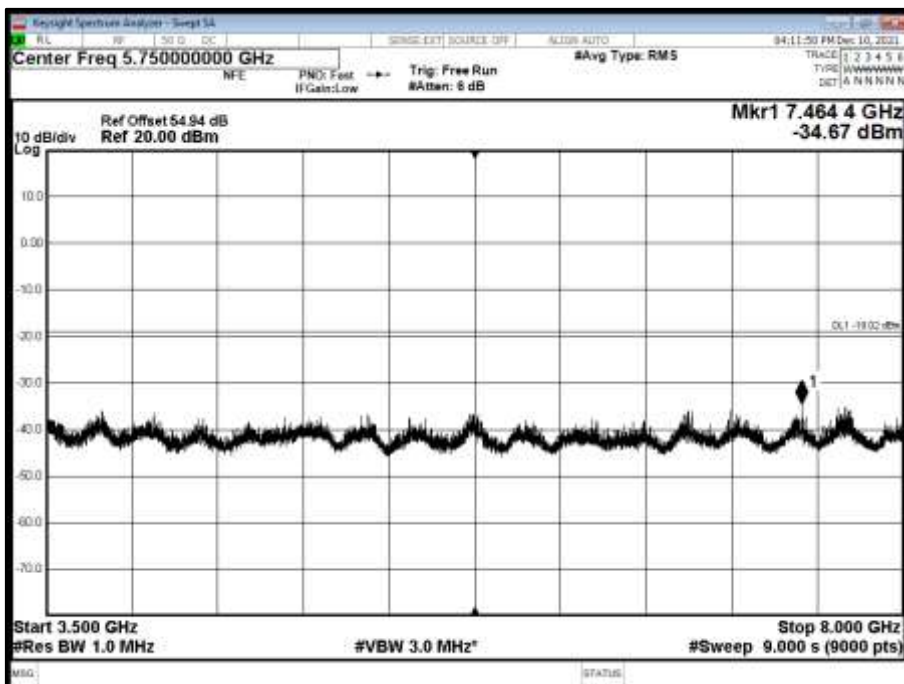



Antenna A - NR Modulation QPSK - NR Carrier Bandwidth 15.0 MHz 15 kHz SCS - Channel Position M - Band 3 - Range 8000 to 12000 MHz

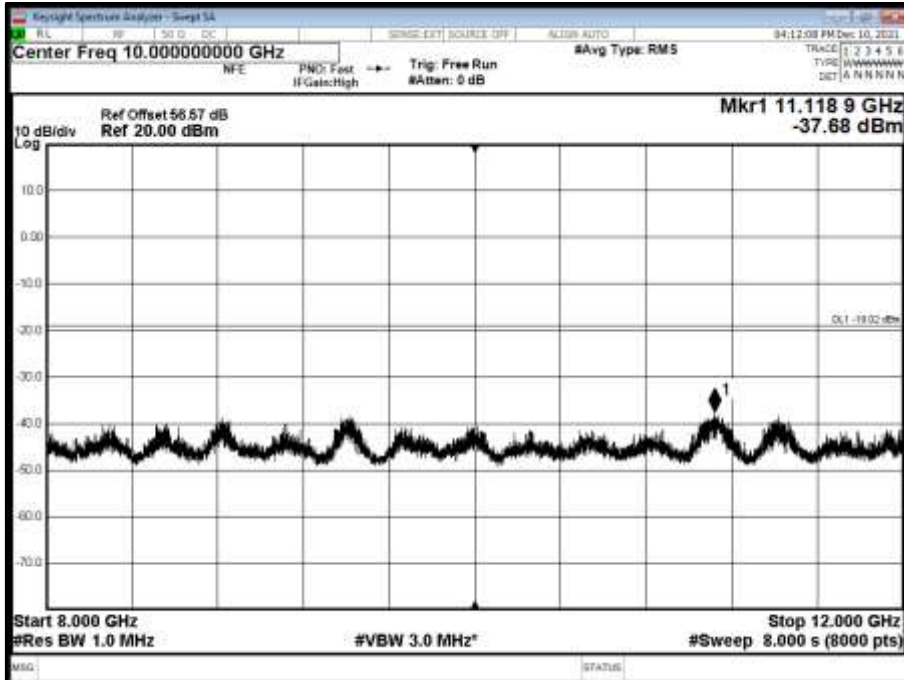

Antenna A - NR Modulation QPSK - NR Carrier Bandwidth 15.0 MHz 15 kHz SCS - Channel Position M - Band 4 - Range 12000 to 18000 MHz

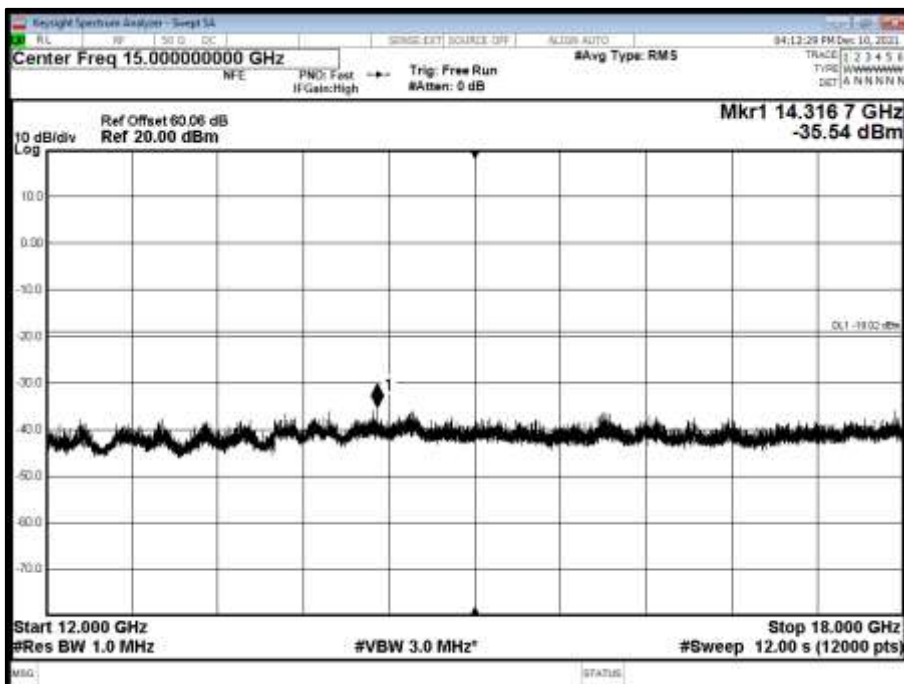





Antenna A - NR Modulation QPSK - NR Carrier Bandwidth 15.0 MHz 15 kHz SCS - Channel Position M - Band 5 - Range 18000 to 20000 MHz

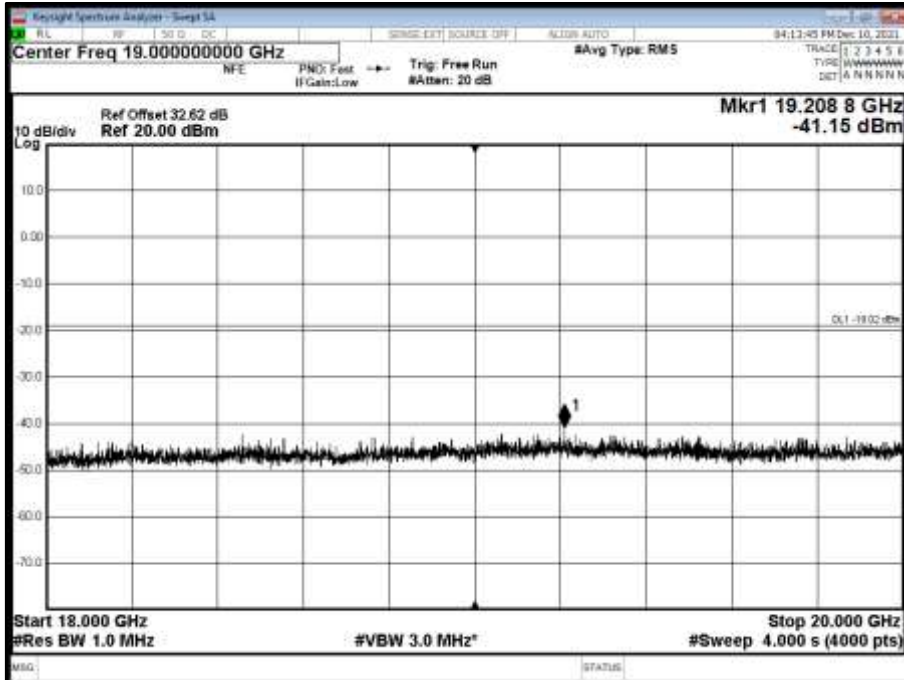

Antenna A - NR Modulation QPSK - NR Carrier Bandwidth 15.0 MHz 15 kHz SCS - Channel Position T - Band 1 - Range 0.009 to 3500 MHz

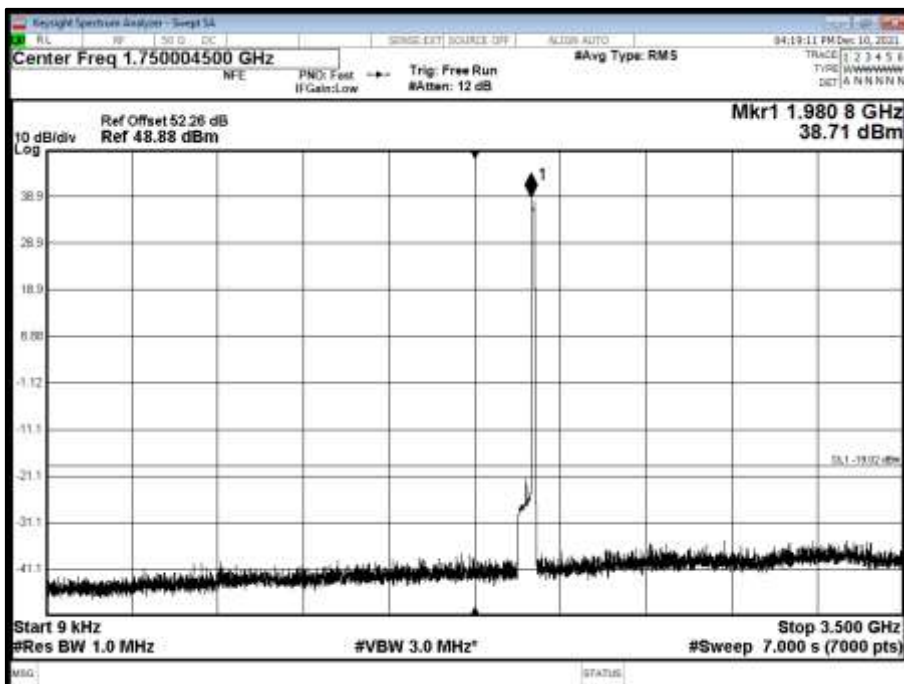



Antenna A - NR Modulation QPSK - NR Carrier Bandwidth 15.0 MHz 15 kHz SCS - Channel Position T - Band 2 - Range 3500 to 8000 MHz

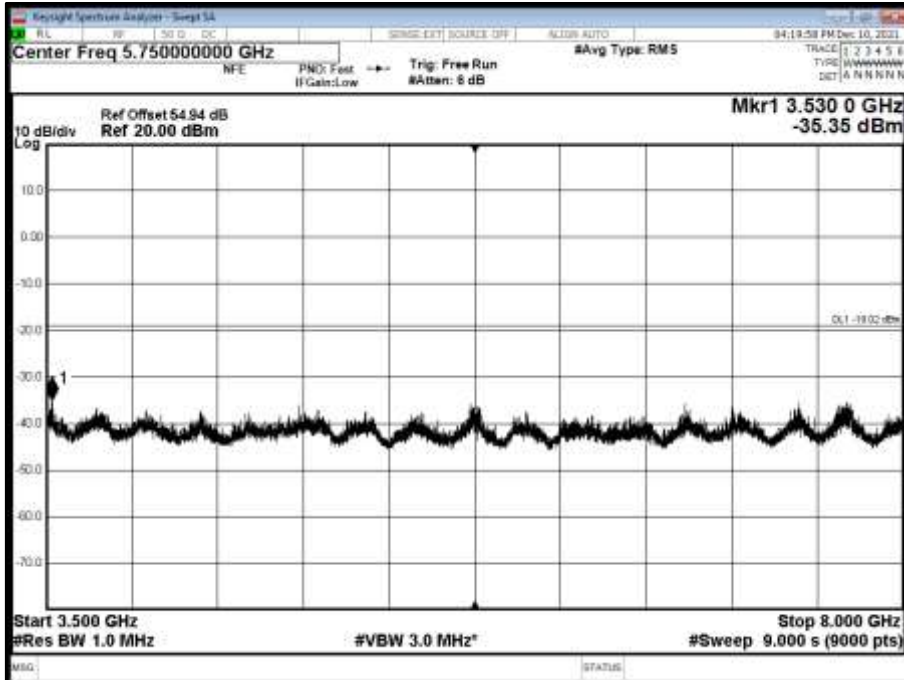

Antenna A - NR Modulation QPSK - NR Carrier Bandwidth 15.0 MHz 15 kHz SCS - Channel Position T - Band 3 - Range 8000 to 12000 MHz

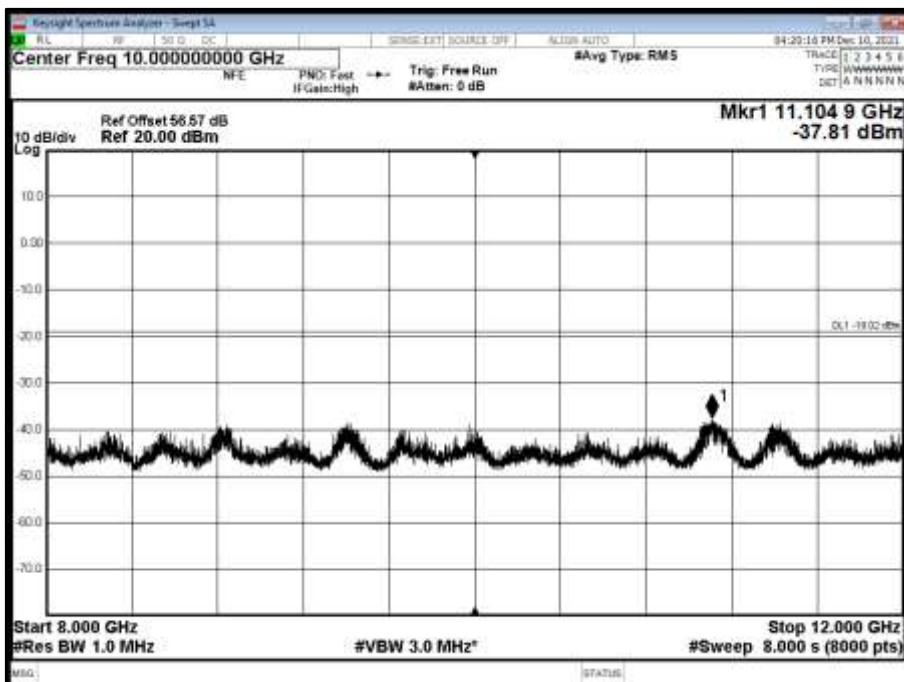



Antenna A - NR Modulation QPSK - NR Carrier Bandwidth 15.0 MHz 15 kHz SCS - Channel Position T - Band 4 - Range 12000 to 18000 MHz

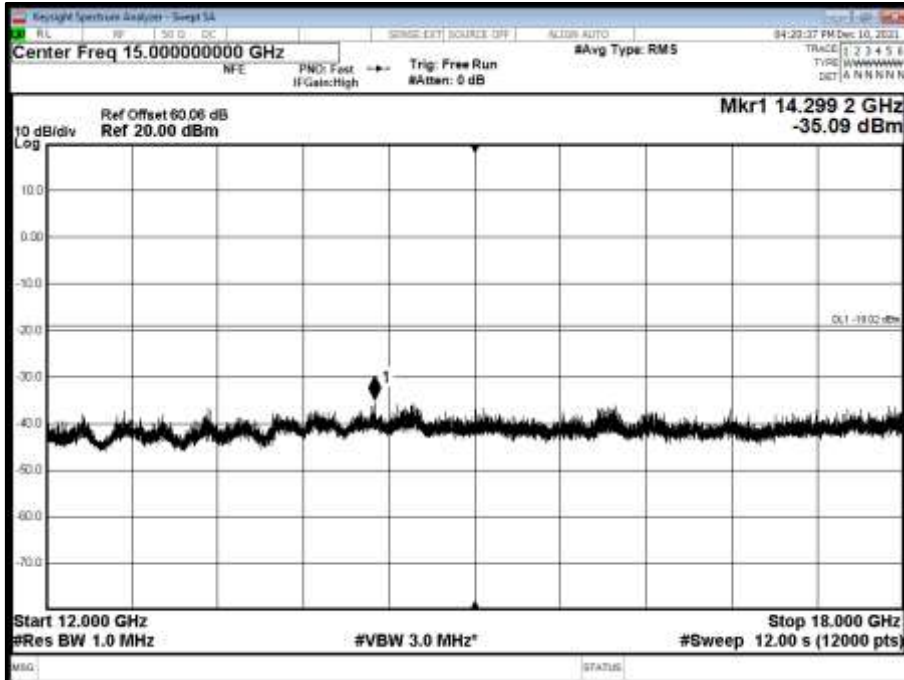

Antenna A - NR Modulation QPSK - NR Carrier Bandwidth 15.0 MHz 15 kHz SCS - Channel Position T - Band 5 - Range 18000 to 20000 MHz

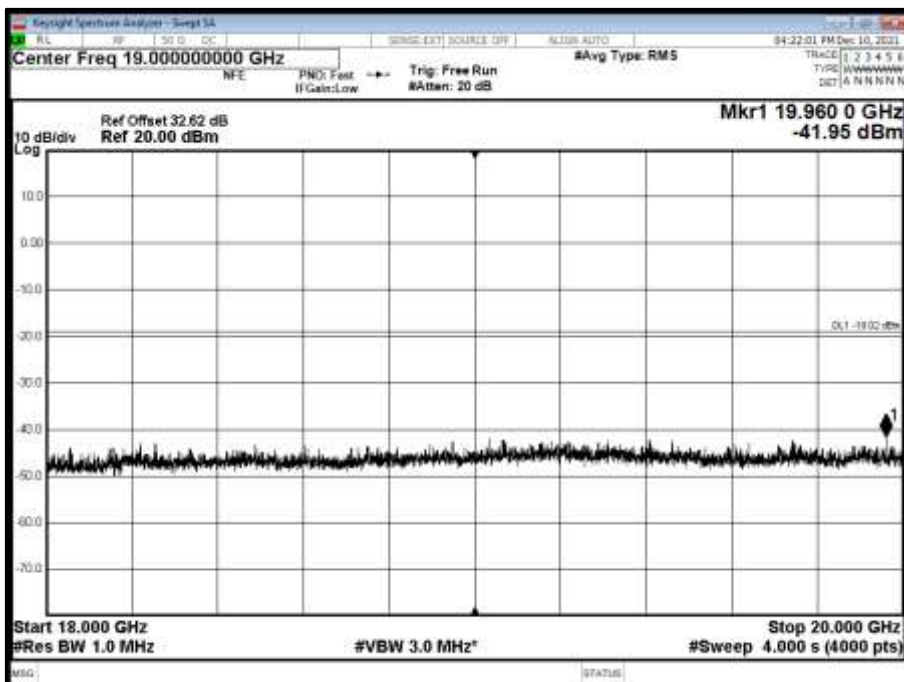



Antenna A - NR Modulation QPSK - NR Carrier Bandwidth 20.0 MHz 15 kHz SCS - Channel Position B - Band 1 - Range 0.009 to 3500 MHz

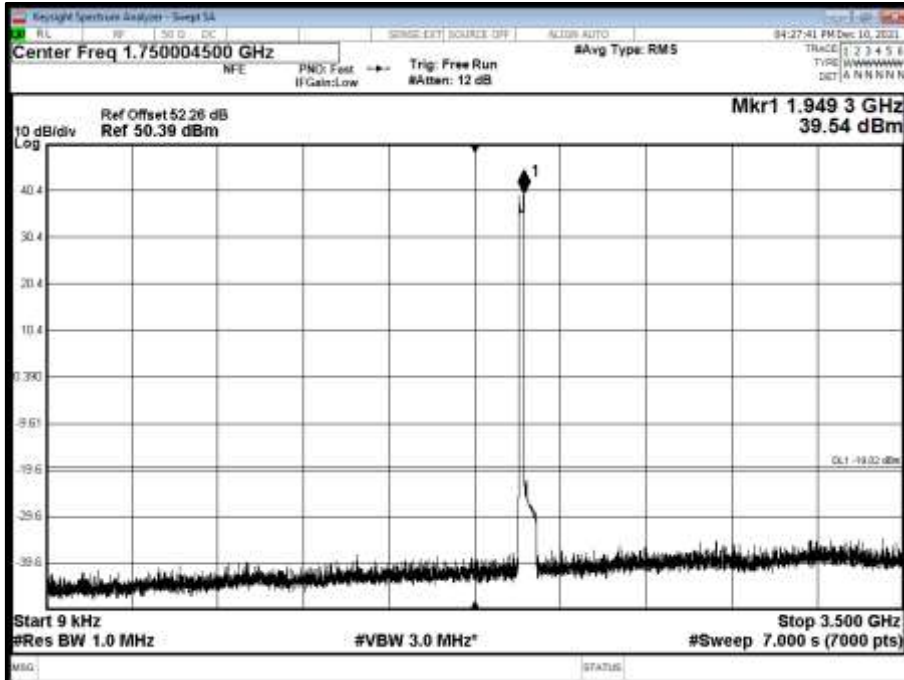

Antenna A - NR Modulation QPSK - NR Carrier Bandwidth 20.0 MHz 15 kHz SCS - Channel Position B - Band 2 - Range 3500 to 8000 MHz

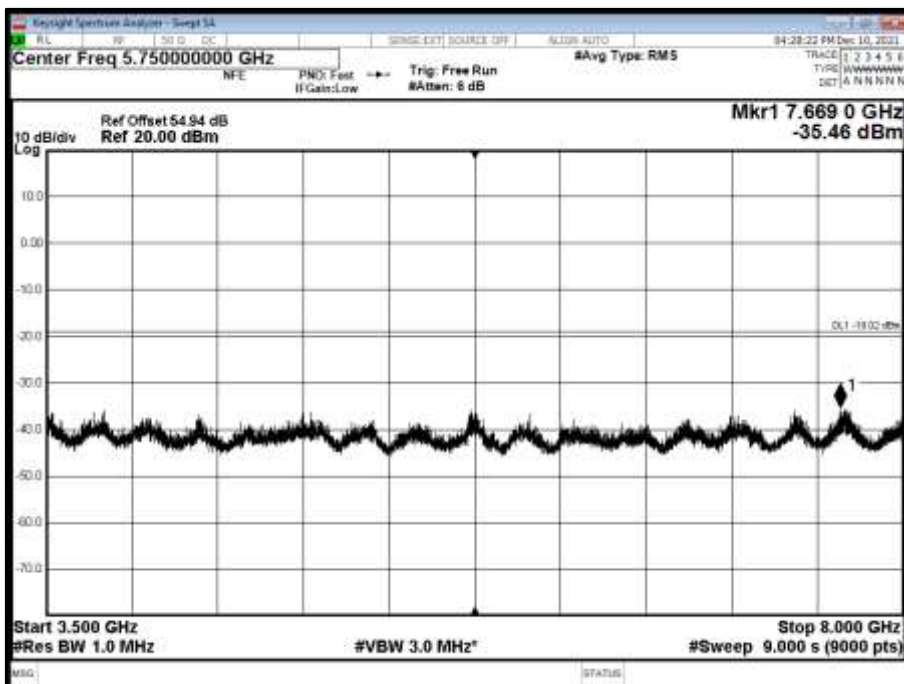



Antenna A - NR Modulation QPSK - NR Carrier Bandwidth 20.0 MHz 15 kHz SCS - Channel Position B - Band 3 - Range 8000 to 12000 MHz

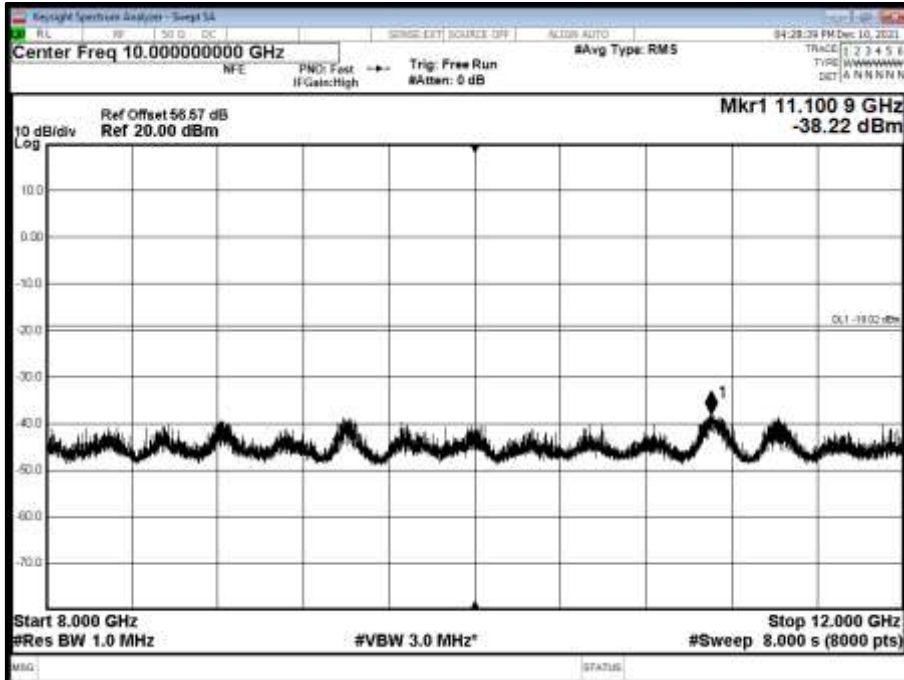

Antenna A - NR Modulation QPSK - NR Carrier Bandwidth 20.0 MHz 15 kHz SCS - Channel Position B - Band 4 - Range 12000 to 18000 MHz

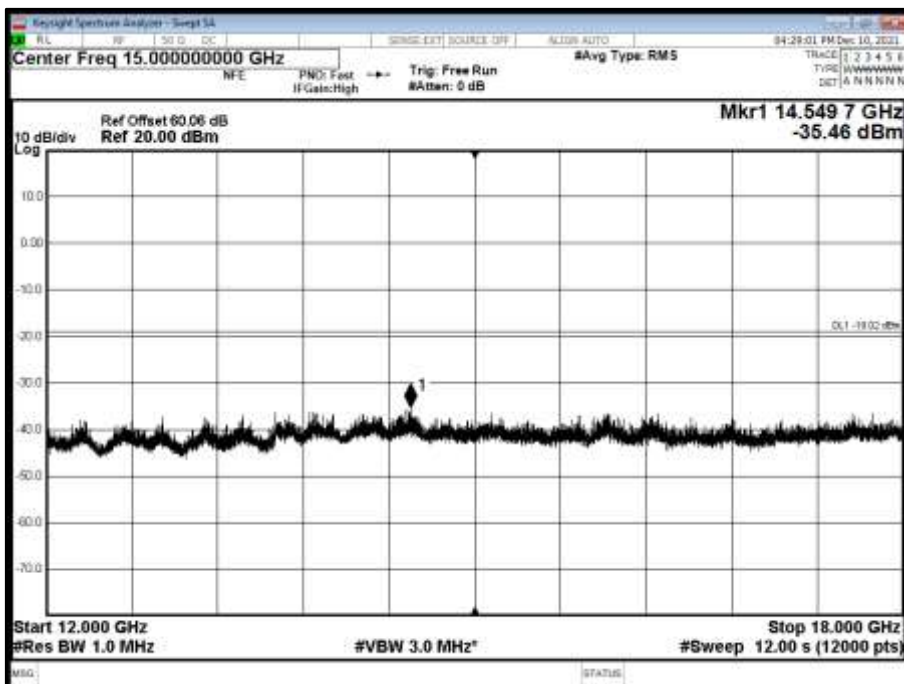



Antenna A - NR Modulation QPSK - NR Carrier Bandwidth 20.0 MHz 15 kHz SCS - Channel Position B - Band 5 - Range 18000 to 20000 MHz

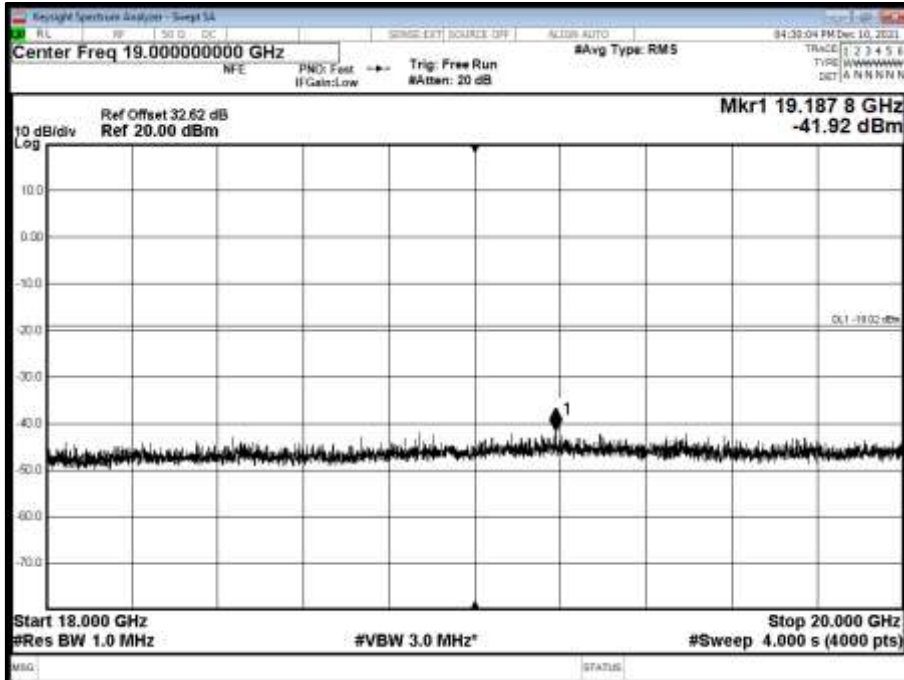

Antenna A - NR Modulation QPSK - NR Carrier Bandwidth 20.0 MHz 15 kHz SCS - Channel Position M - Band 1 - Range 0.009 to 3500 MHz

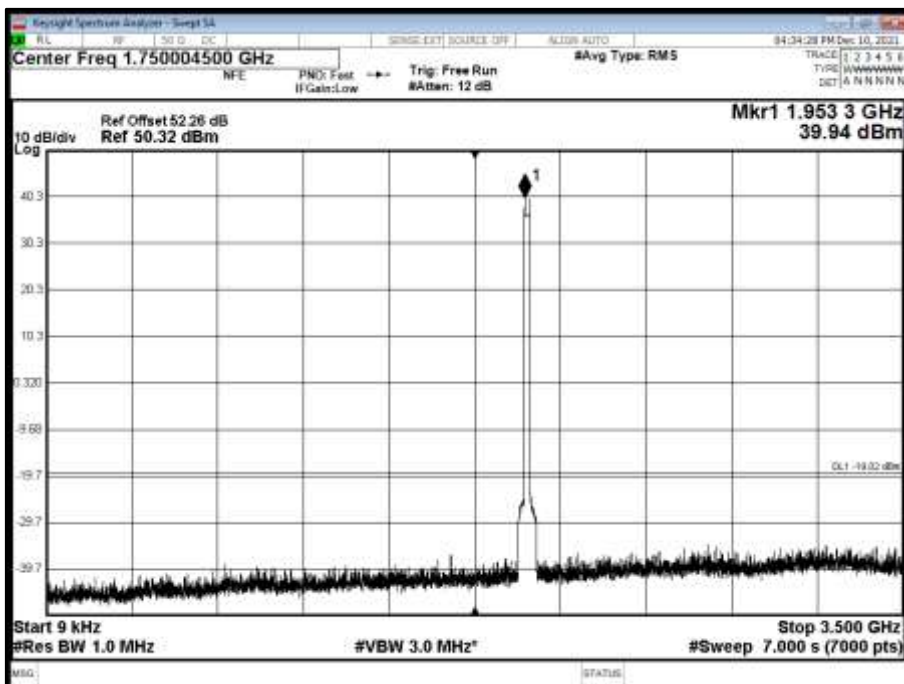



Antenna A - NR Modulation QPSK - NR Carrier Bandwidth 20.0 MHz 15 kHz SCS - Channel Position M - Band 2 - Range 3500 to 8000 MHz

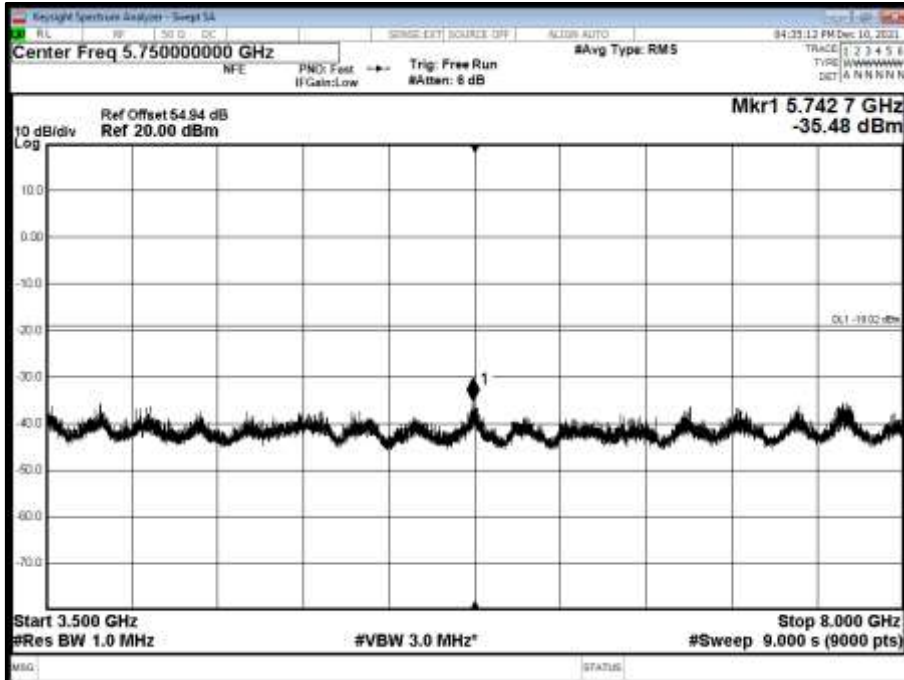

Antenna A - NR Modulation QPSK - NR Carrier Bandwidth 20.0 MHz 15 kHz SCS - Channel Position M - Band 3 - Range 8000 to 12000 MHz

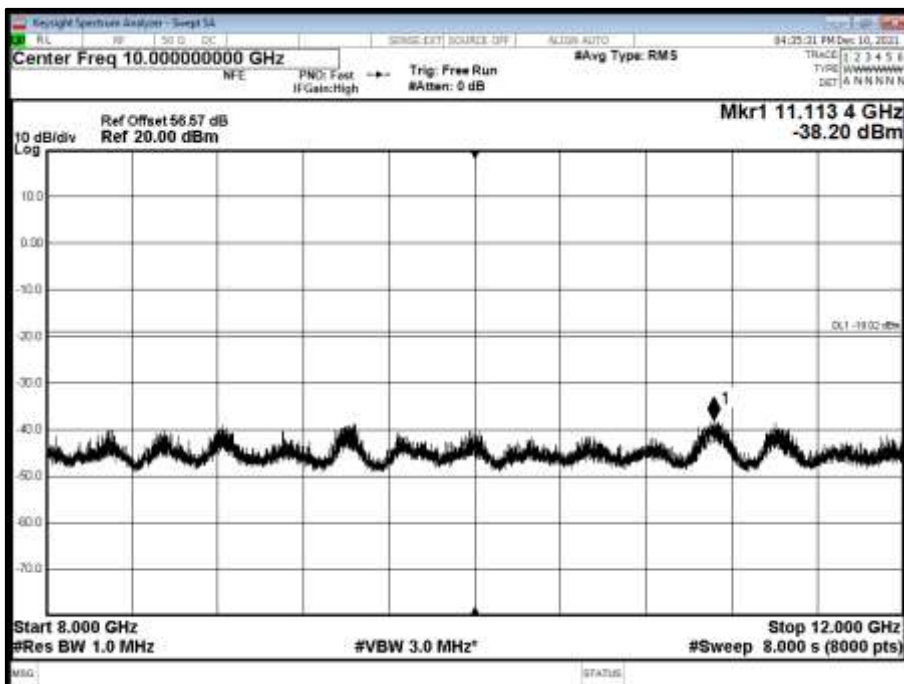



Antenna A - NR Modulation QPSK - NR Carrier Bandwidth 20.0 MHz 15 kHz SCS - Channel Position M - Band 4 - Range 12000 to 18000 MHz

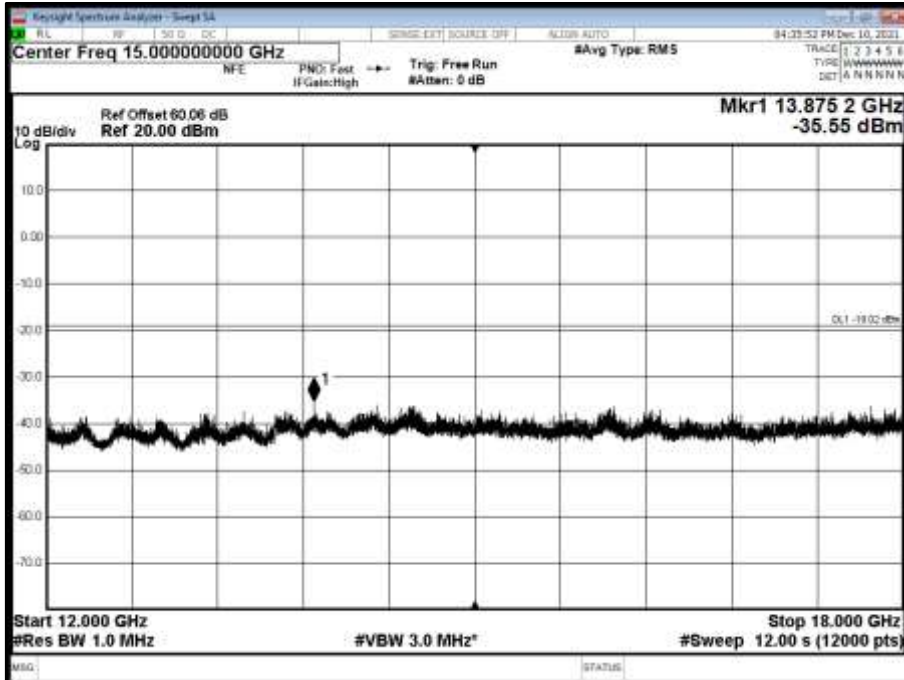

Antenna A - NR Modulation QPSK - NR Carrier Bandwidth 20.0 MHz 15 kHz SCS - Channel Position M - Band 5 - Range 18000 to 20000 MHz

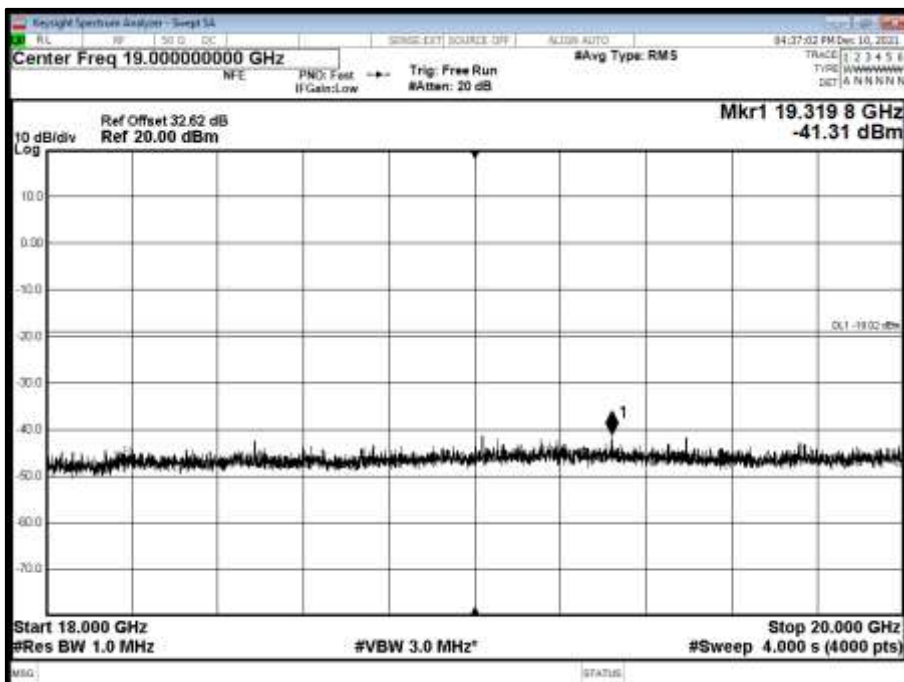





Antenna A - NR Modulation QPSK - NR Carrier Bandwidth 20.0 MHz 15 kHz SCS - Channel Position T - Band 1 - Range 0.009 to 3500 MHz

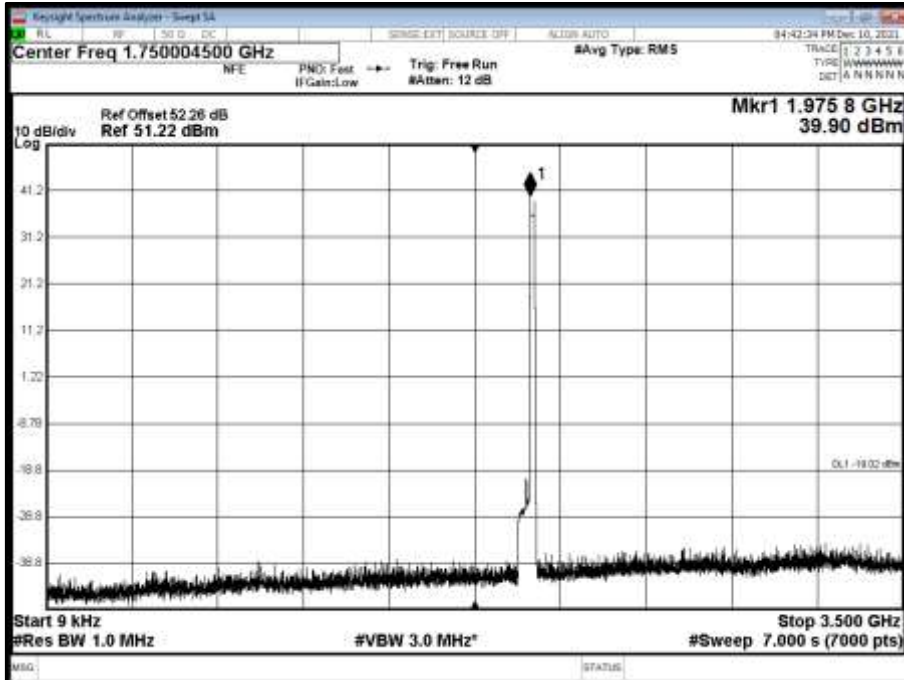

Antenna A - NR Modulation QPSK - NR Carrier Bandwidth 20.0 MHz 15 kHz SCS - Channel Position T - Band 2 - Range 3500 to 8000 MHz

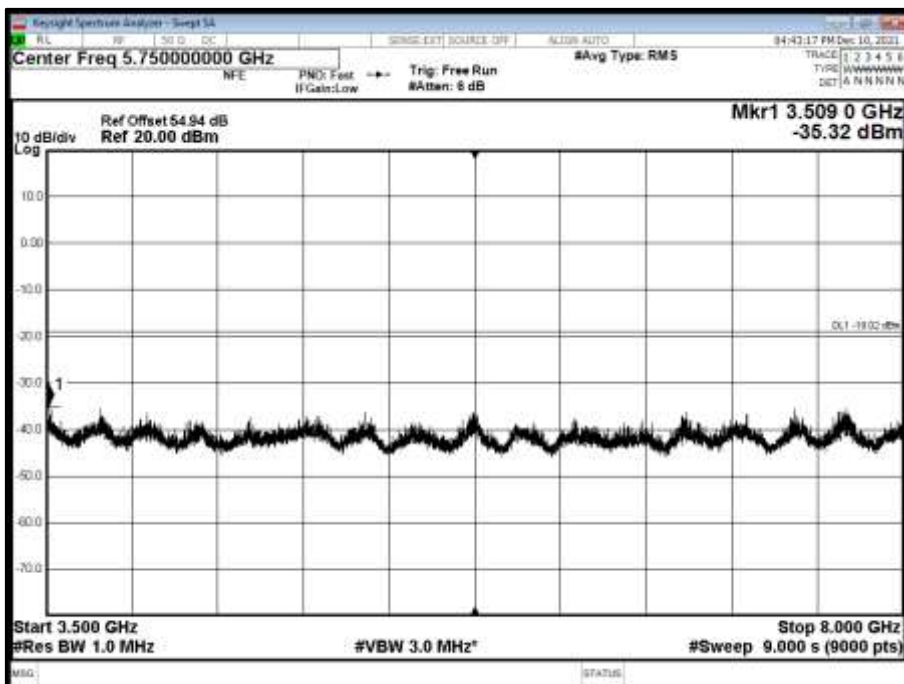



Antenna A - NR Modulation QPSK - NR Carrier Bandwidth 20.0 MHz 15 kHz SCS - Channel Position T - Band 3 - Range 8000 to 12000 MHz

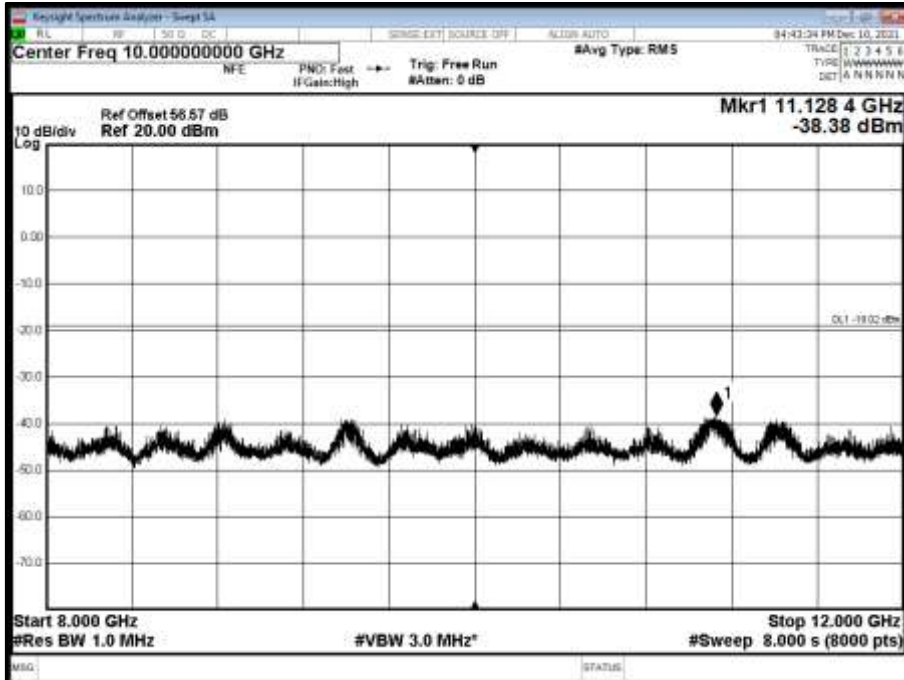

Antenna A - NR Modulation QPSK - NR Carrier Bandwidth 20.0 MHz 15 kHz SCS - Channel Position T - Band 4 - Range 12000 to 18000 MHz

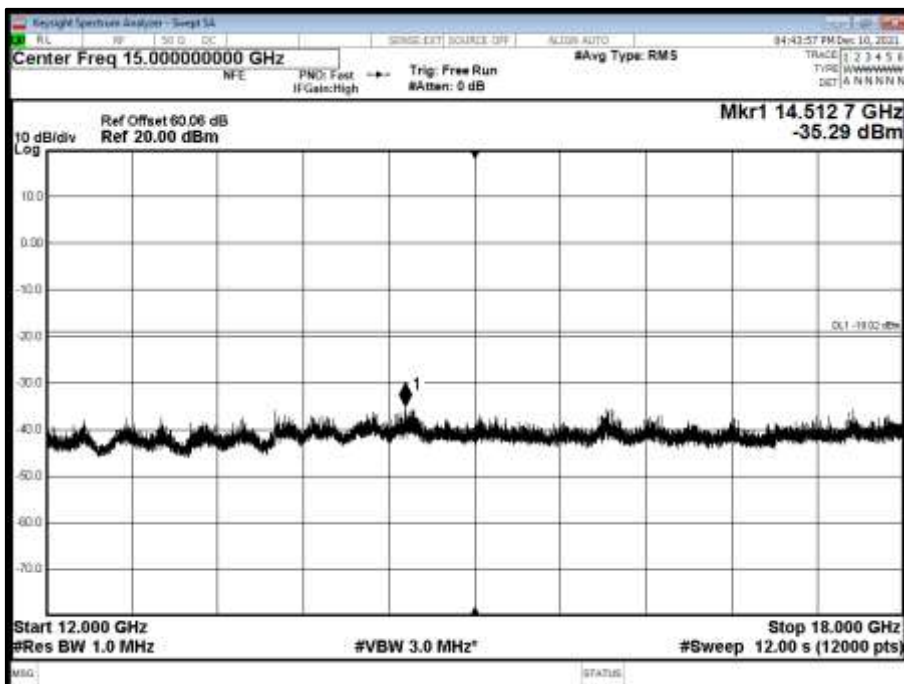



Antenna A - NR Modulation QPSK - NR Carrier Bandwidth 20.0 MHz 15 kHz SCS - Channel Position T - Band 5 - Range 18000 to 20000 MHz

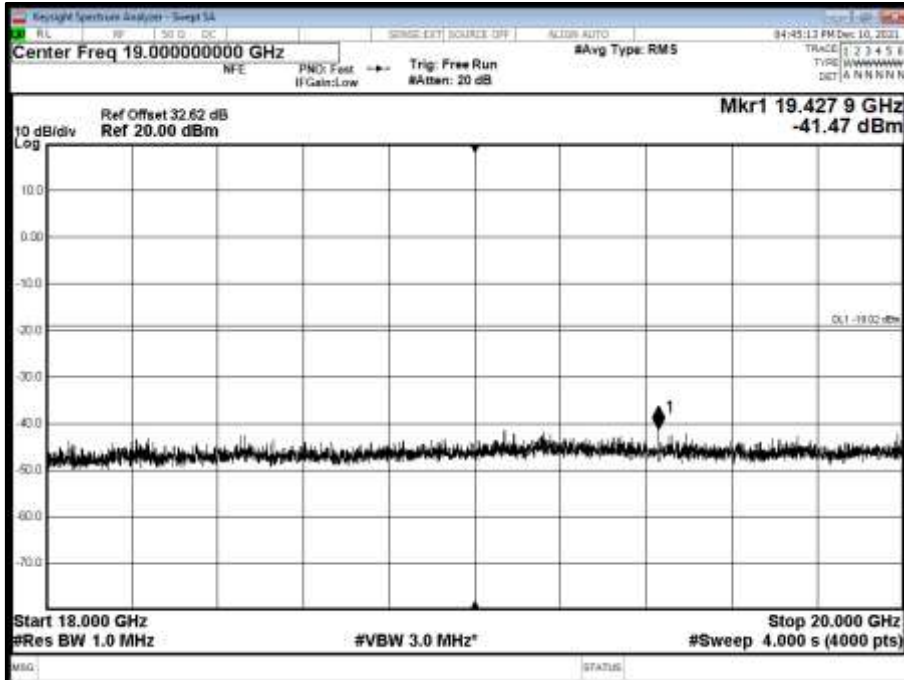

Configuration 2

Maximum Output Power 47.78 dBm

Antenna A - NR Modulation QPSK - NR Carrier Bandwidth 10.0 MHz 15 kHz SCS - Channel Position M - Band 1 - Range 0.009 to 3500 MHz

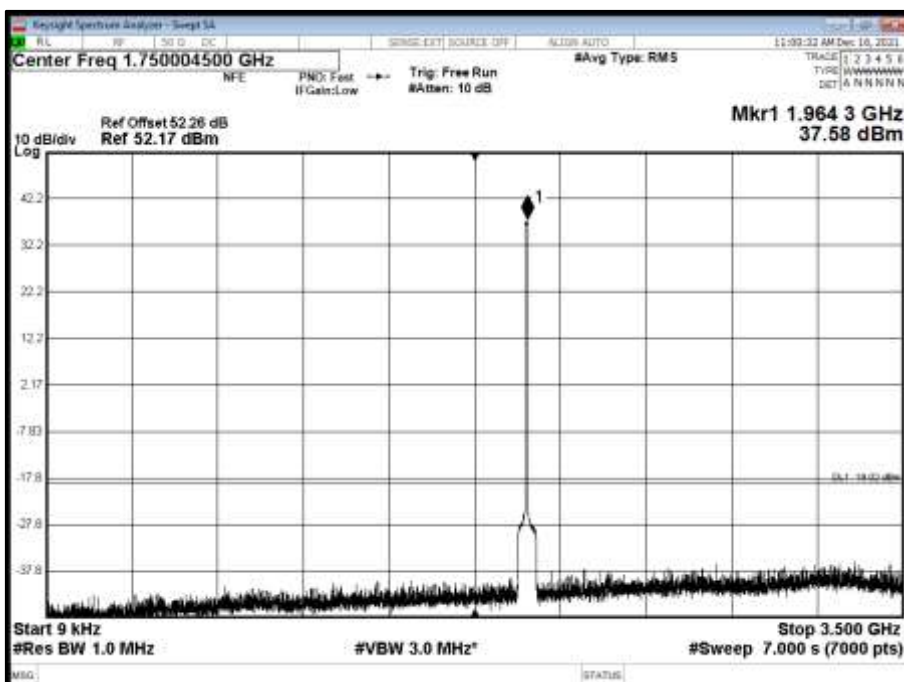



Antenna A - NR Modulation QPSK - NR Carrier Bandwidth 10.0 MHz 15 kHz SCS - Channel Position M - Band 2 - Range 3500 to 8000 MHz

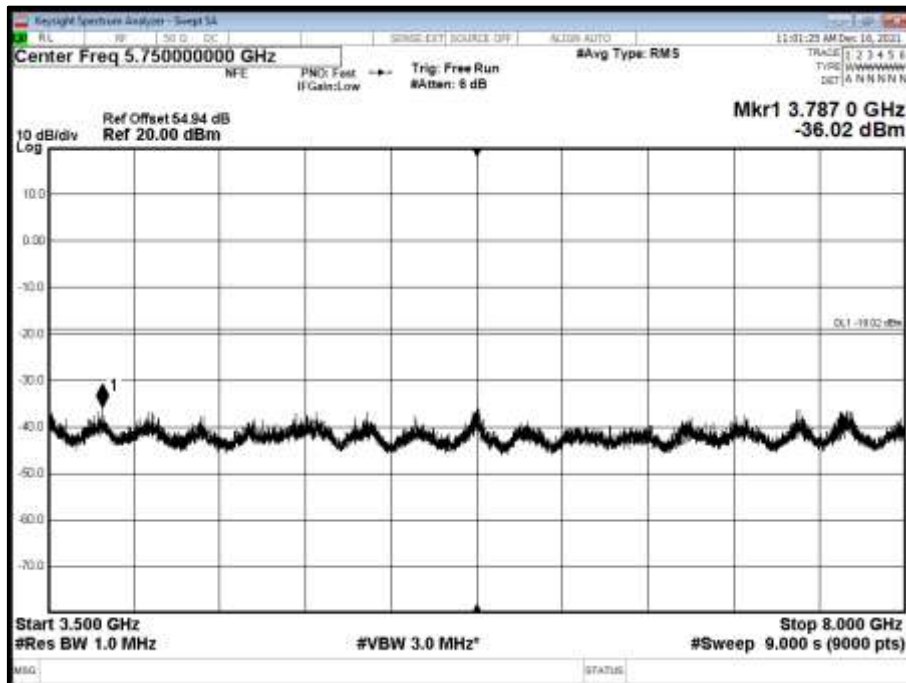

Antenna A - NR Modulation QPSK - NR Carrier Bandwidth 10.0 MHz 15 kHz SCS - Channel Position M - Band 3 - Range 8000 to 12000 MHz

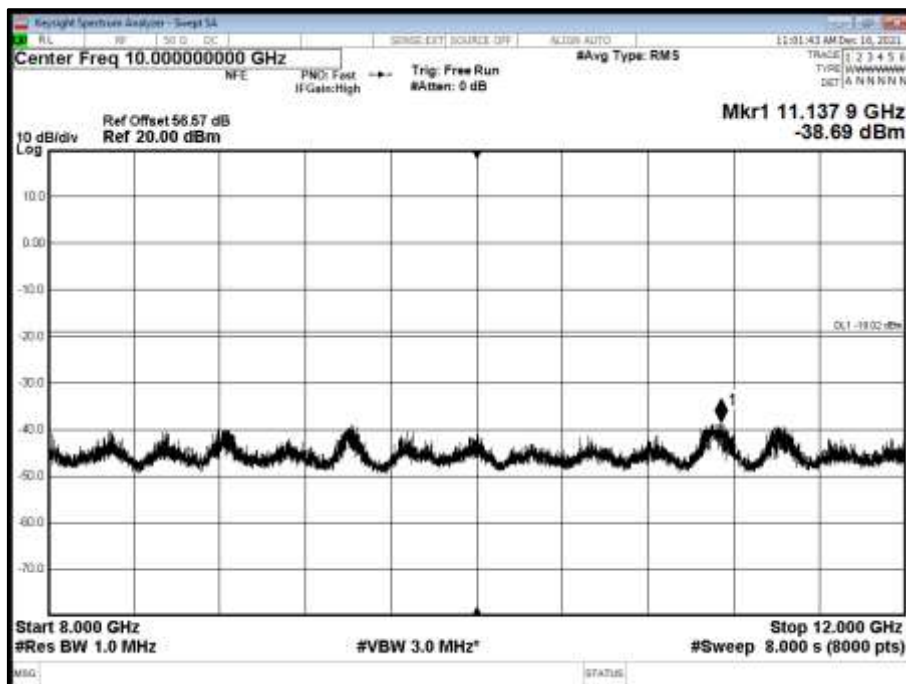



Antenna A - NR Modulation QPSK - NR Carrier Bandwidth 10.0 MHz 15 kHz SCS - Channel Position M - Band 4 - Range 12000 to 18000 MHz

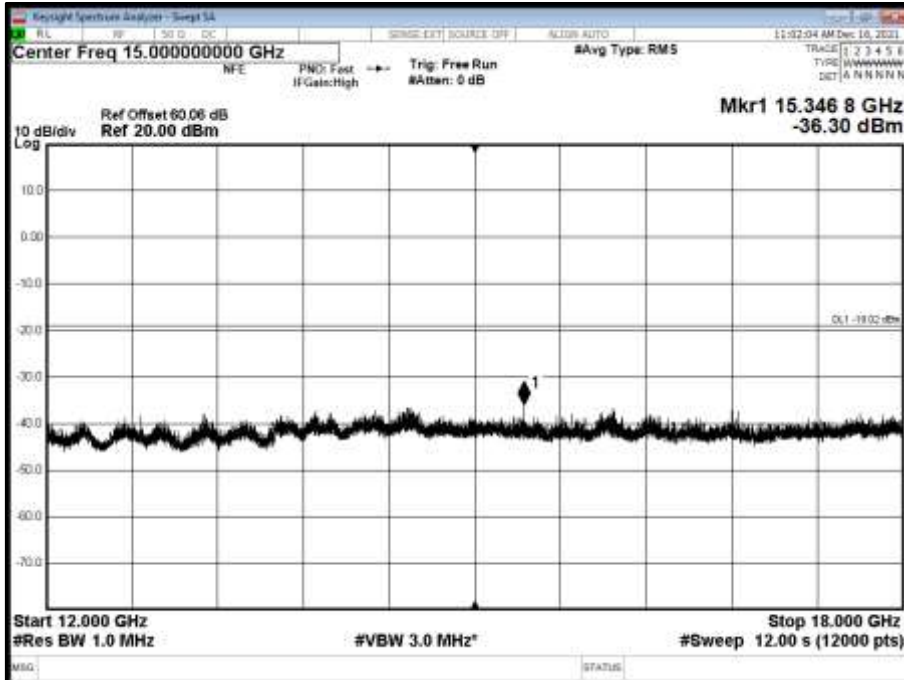

Antenna A - NR Modulation QPSK - NR Carrier Bandwidth 10.0 MHz 15 kHz SCS - Channel Position M - Band 5 - Range 18000 to 20000 MHz

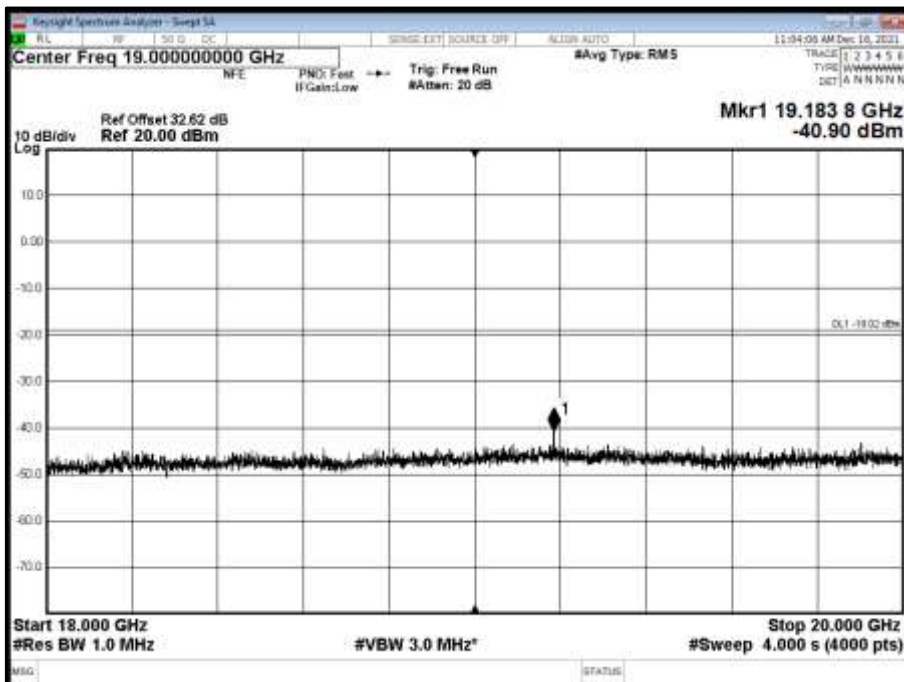



Antenna A - NR Modulation QPSK - NR Carrier Bandwidth 10.0 MHz 15 kHz SCS - Channel Position T - Band 1 - Range 0.009 to 3500 MHz

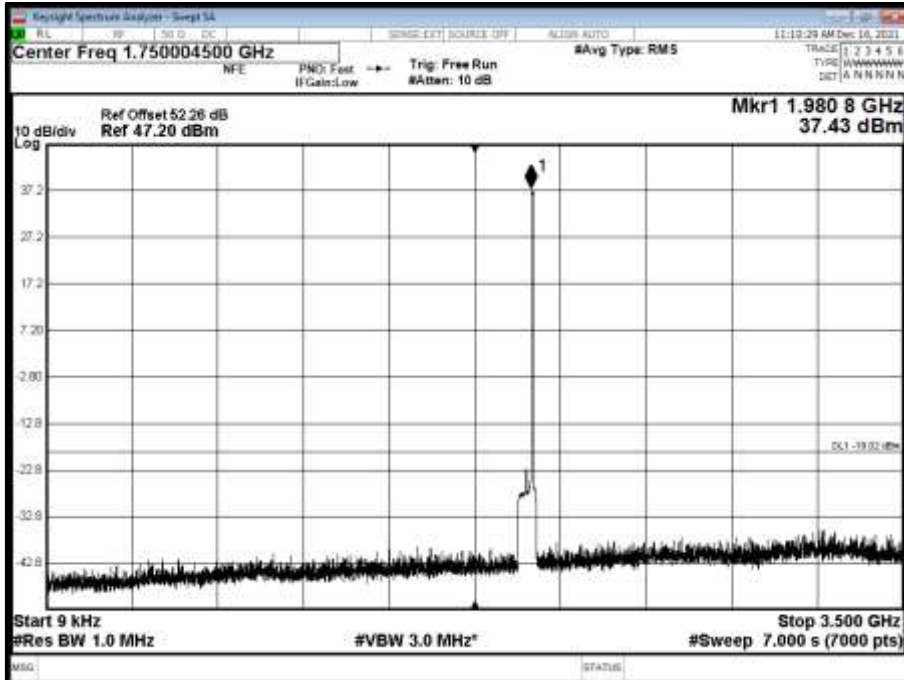

Antenna A - NR Modulation QPSK - NR Carrier Bandwidth 10.0 MHz 15 kHz SCS - Channel Position T - Band 2 - Range 3500 to 8000 MHz

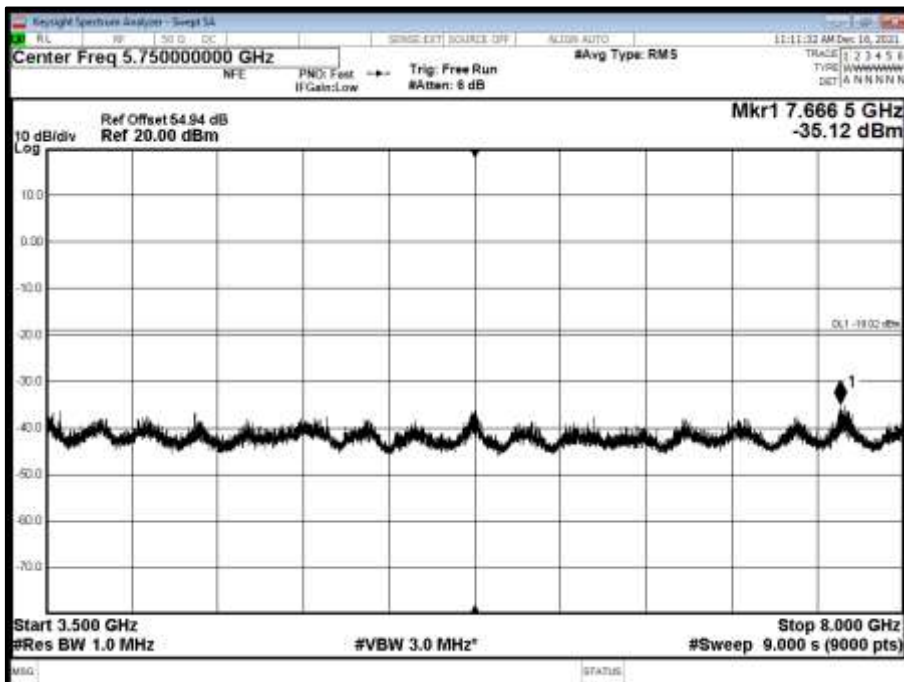



Antenna A - NR Modulation QPSK - NR Carrier Bandwidth 10.0 MHz 15 kHz SCS - Channel Position T - Band 3 - Range 8000 to 12000 MHz

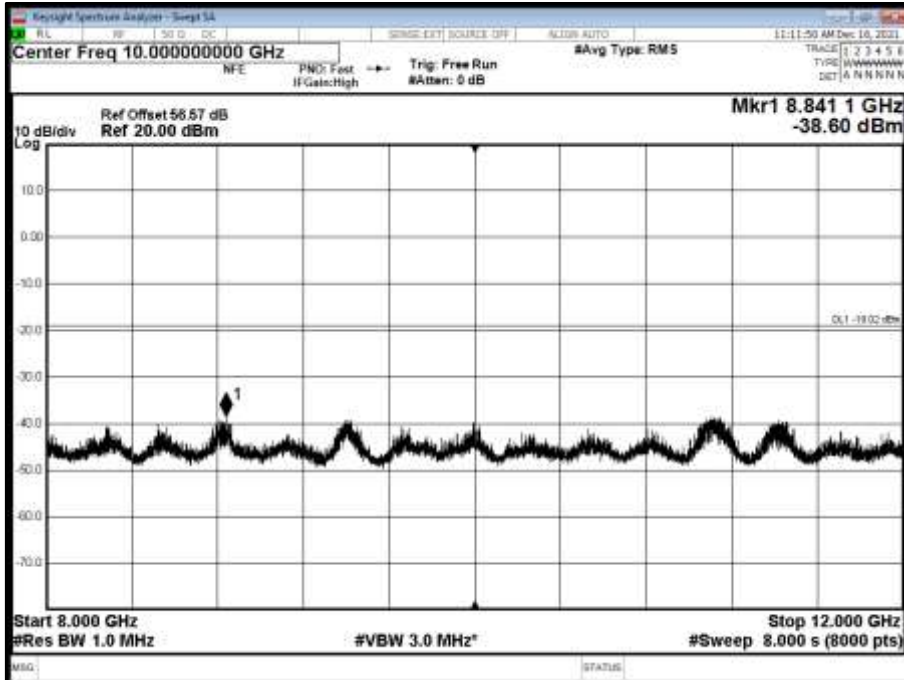

Antenna A - NR Modulation QPSK - NR Carrier Bandwidth 10.0 MHz 15 kHz SCS - Channel Position T - Band 4 - Range 12000 to 18000 MHz

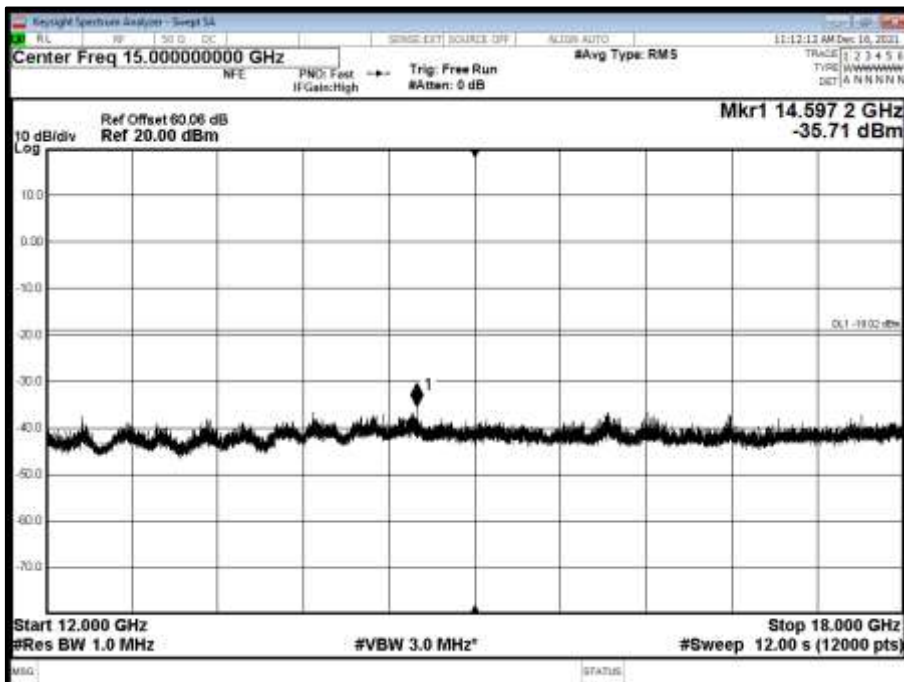



Antenna A - NR Modulation QPSK - NR Carrier Bandwidth 10.0 MHz 15 kHz SCS - Channel Position T - Band 5 - Range 18000 to 20000 MHz

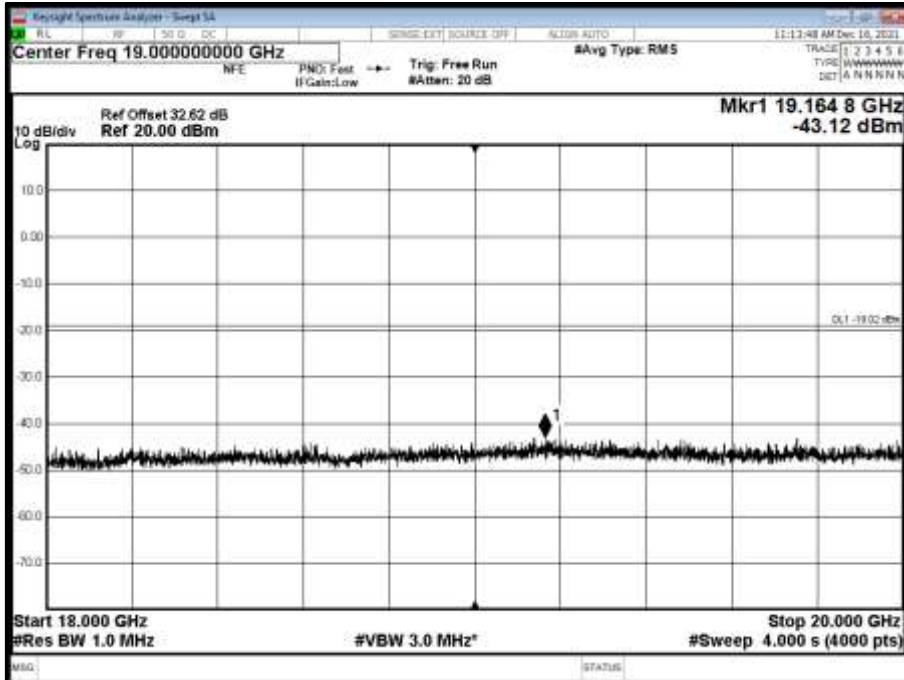

Antenna A - NR Modulation QPSK - NR Carrier Bandwidth 15.0 MHz 15 kHz SCS - Channel Position M - Band 1 - Range 0.009 to 3500 MHz

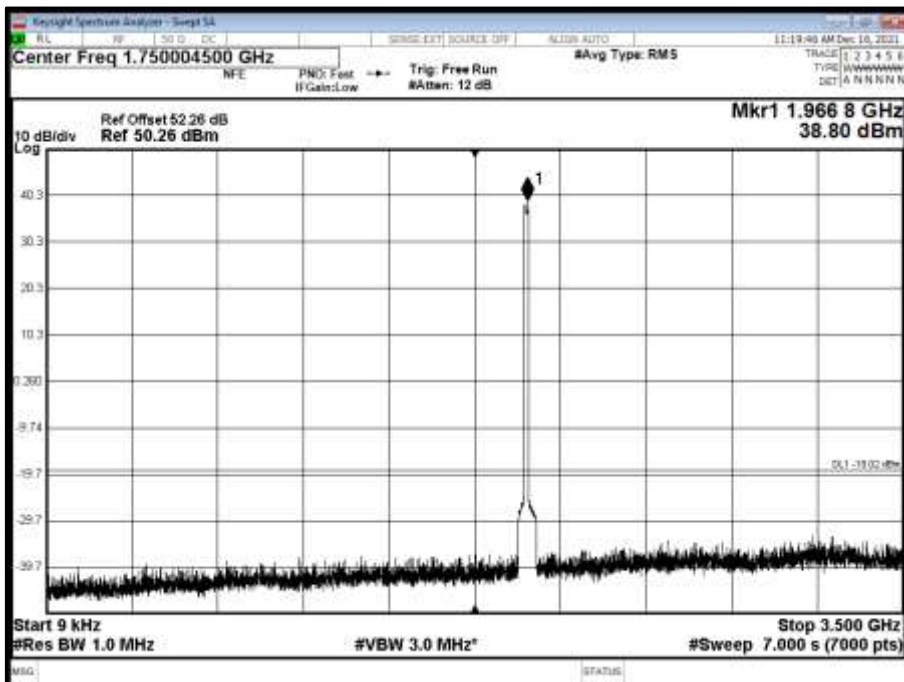





Antenna A - NR Modulation QPSK - NR Carrier Bandwidth 15.0 MHz 15 kHz SCS - Channel Position M - Band 2 - Range 3500 to 8000 MHz

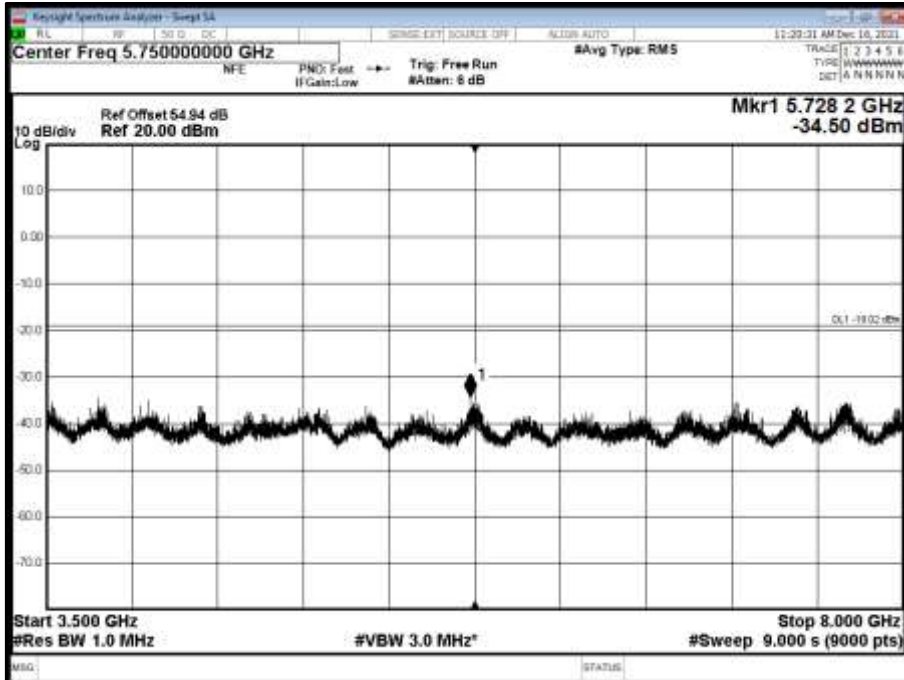

Antenna A - NR Modulation QPSK - NR Carrier Bandwidth 15.0 MHz 15 kHz SCS - Channel Position M - Band 3 - Range 8000 to 12000 MHz

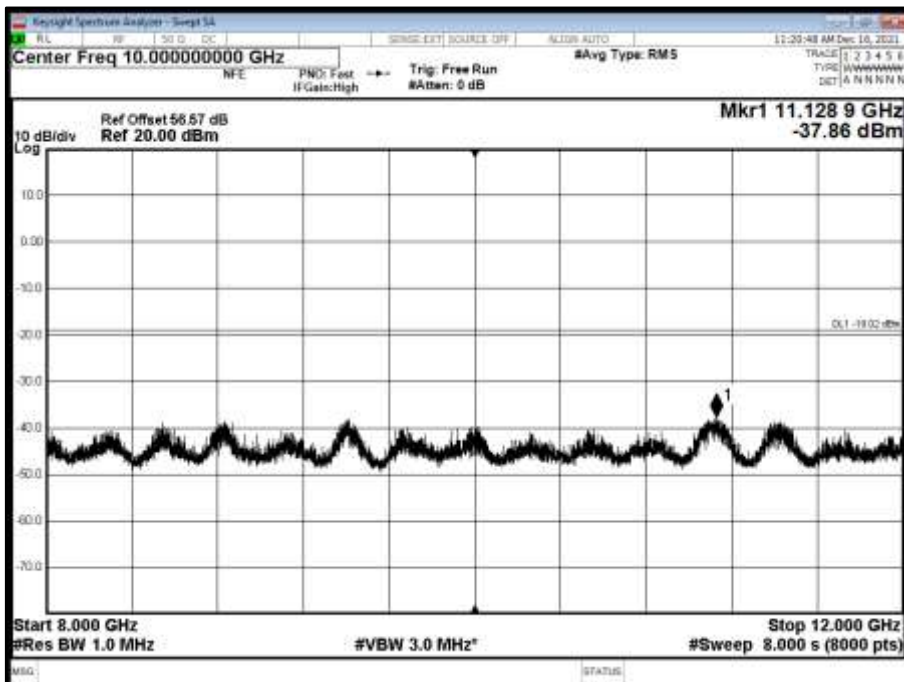



Antenna A - NR Modulation QPSK - NR Carrier Bandwidth 15.0 MHz 15 kHz SCS - Channel Position M - Band 4 - Range 12000 to 18000 MHz

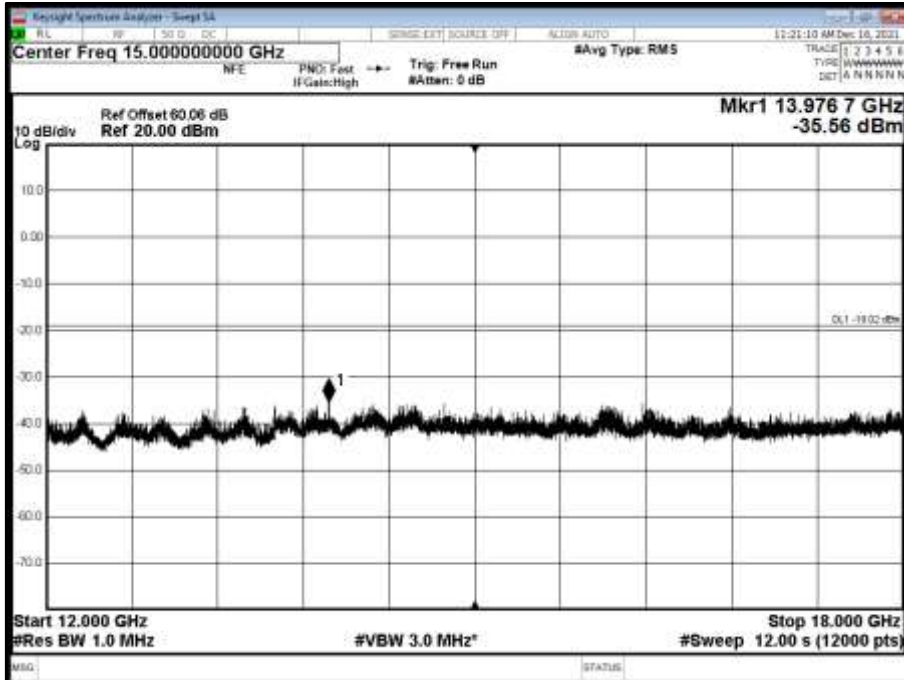

Antenna A - NR Modulation QPSK - NR Carrier Bandwidth 15.0 MHz 15 kHz SCS - Channel Position M - Band 5 - Range 18000 to 20000 MHz

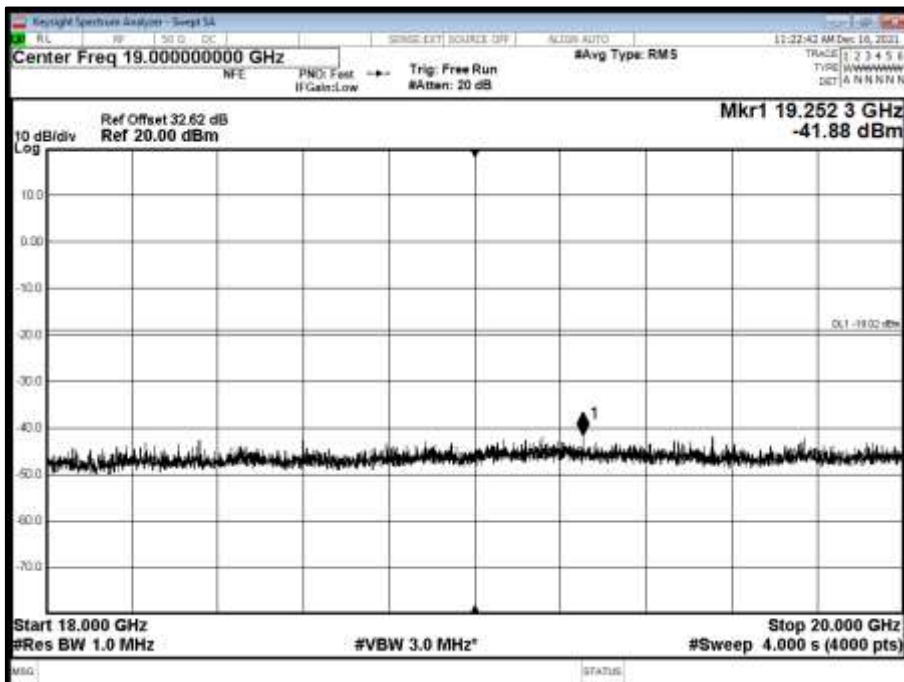



Antenna A - NR Modulation QPSK - NR Carrier Bandwidth 15.0 MHz 15 kHz SCS - Channel Position T - Band 1 - Range 0.009 to 3500 MHz

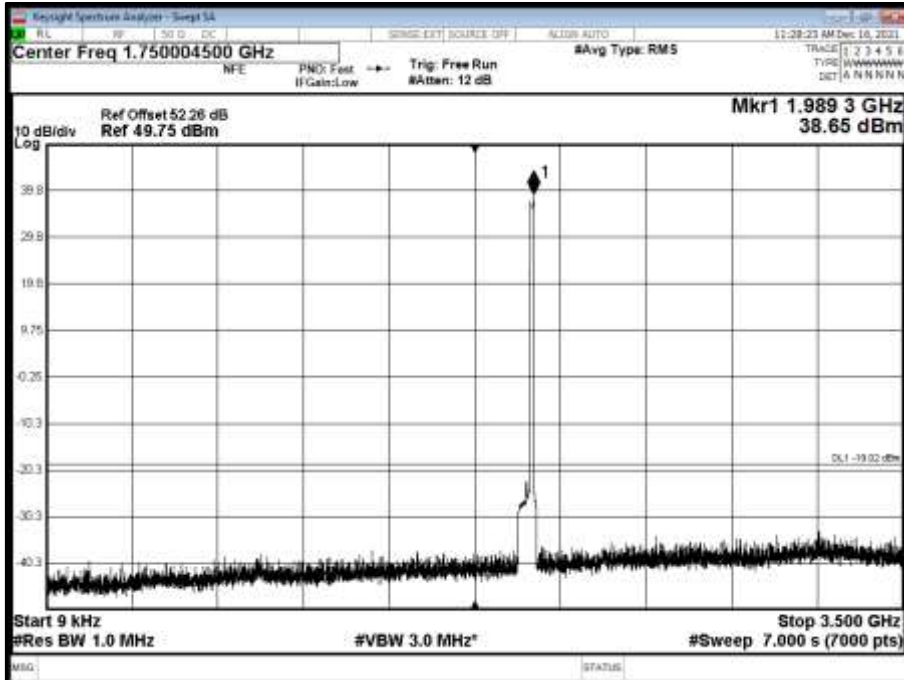

Antenna A - NR Modulation QPSK - NR Carrier Bandwidth 15.0 MHz 15 kHz SCS - Channel Position T - Band 2 - Range 3500 to 8000 MHz

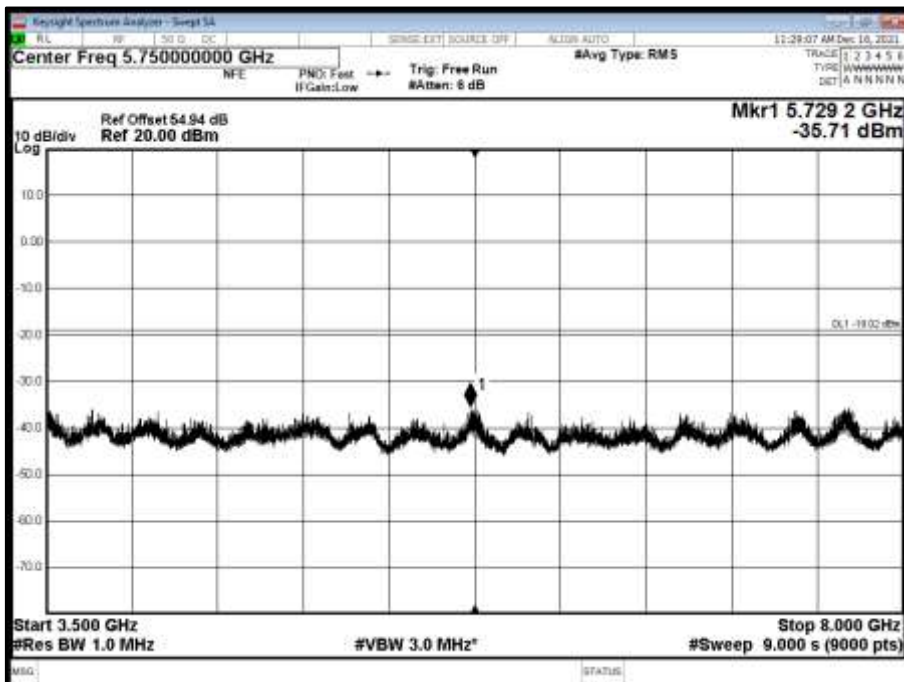



Antenna A - NR Modulation QPSK - NR Carrier Bandwidth 15.0 MHz 15 kHz SCS - Channel Position T - Band 3 - Range 8000 to 12000 MHz

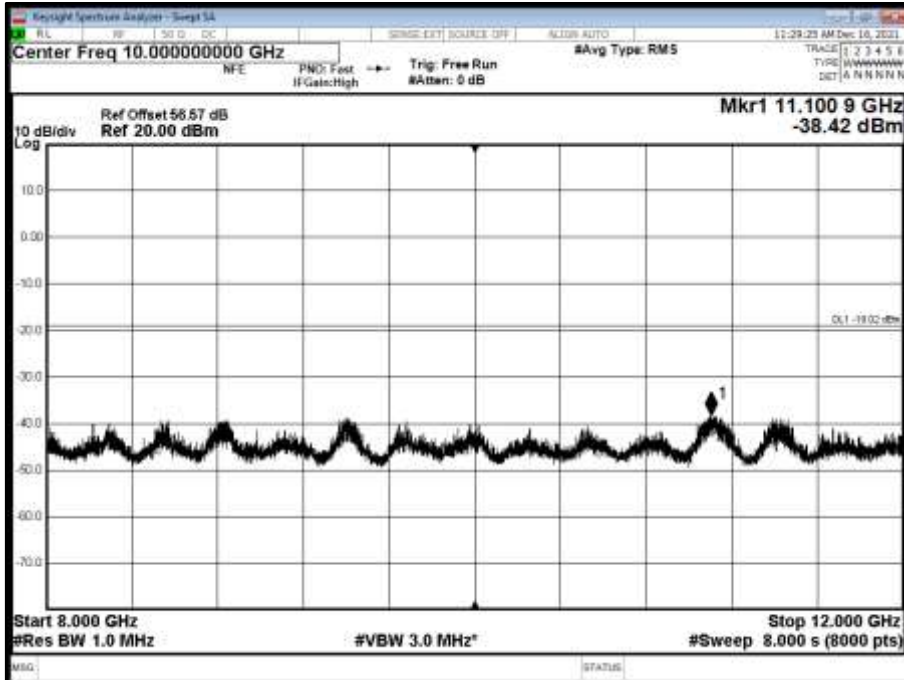

Antenna A - NR Modulation QPSK - NR Carrier Bandwidth 15.0 MHz 15 kHz SCS - Channel Position T - Band 4 - Range 12000 to 18000 MHz

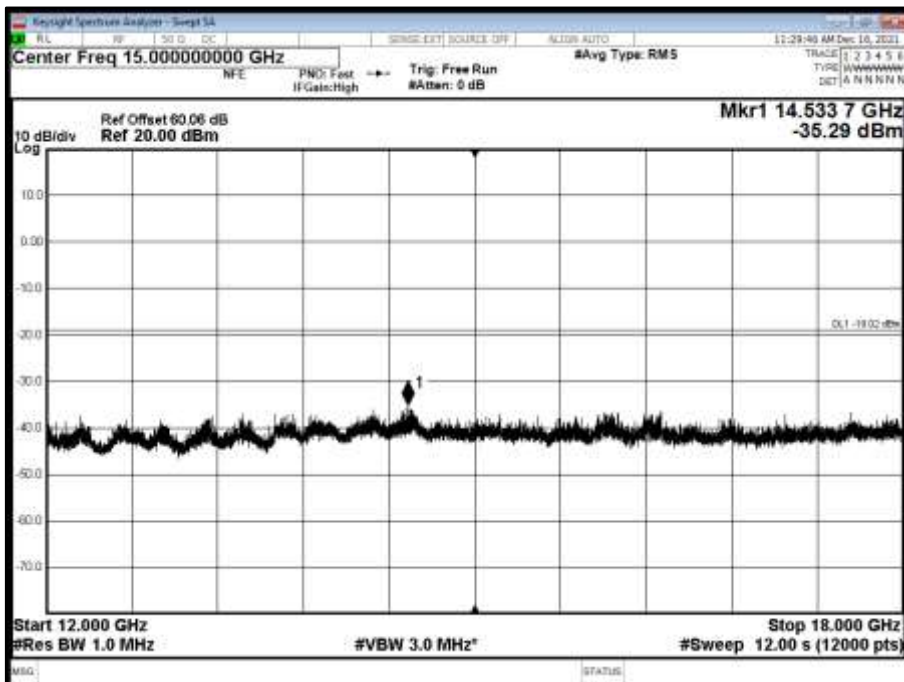



Antenna A - NR Modulation QPSK - NR Carrier Bandwidth 15.0 MHz 15 kHz SCS - Channel Position T - Band 5 - Range 18000 to 20000 MHz

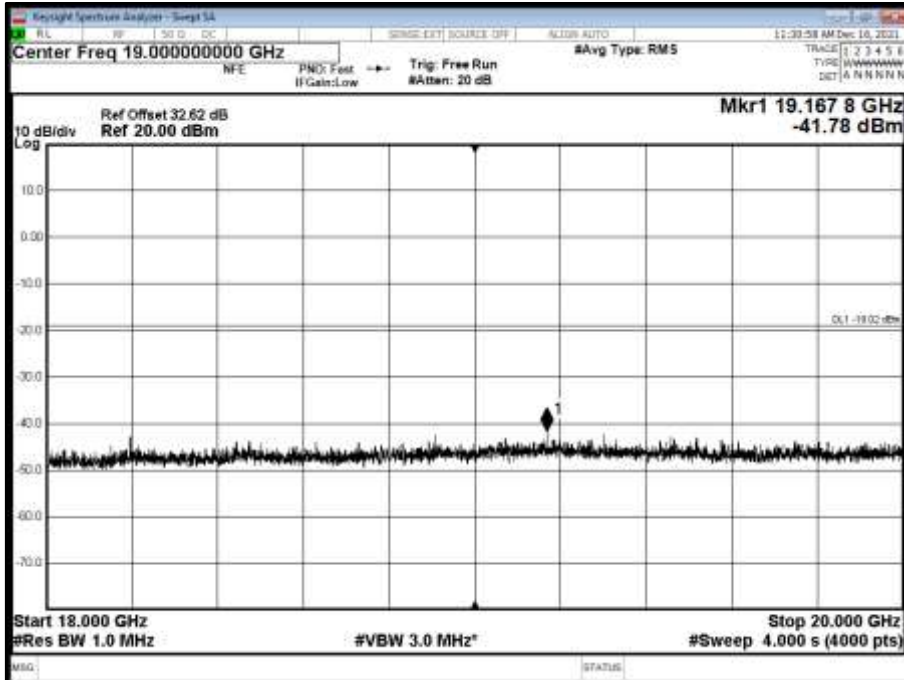

Antenna A - NR Modulation QPSK - NR Carrier Bandwidth 20.0 MHz 15 kHz SCS - Channel Position M - Band 1 - Range 0.009 to 3500 MHz

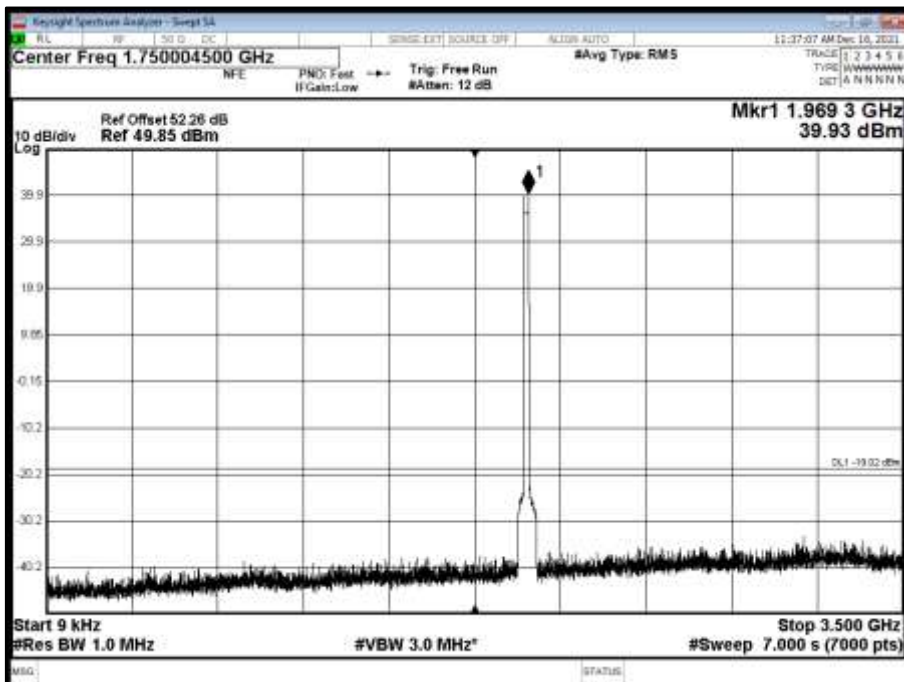



Antenna A - NR Modulation QPSK - NR Carrier Bandwidth 20.0 MHz 15 kHz SCS - Channel Position M - Band 2 - Range 3500 to 8000 MHz

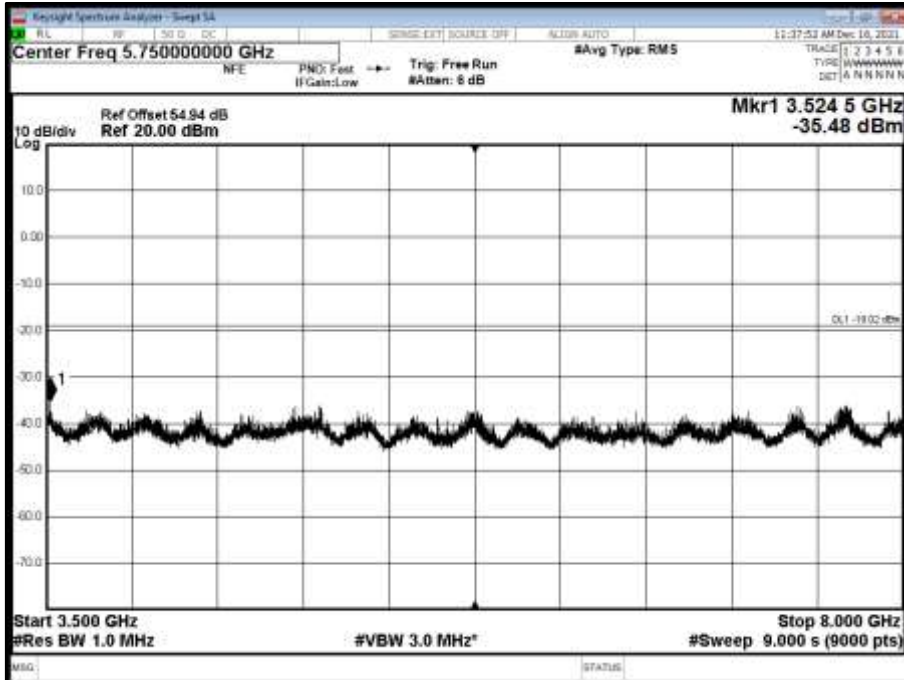

Antenna A - NR Modulation QPSK - NR Carrier Bandwidth 20.0 MHz 15 kHz SCS - Channel Position M - Band 3 - Range 8000 to 12000 MHz

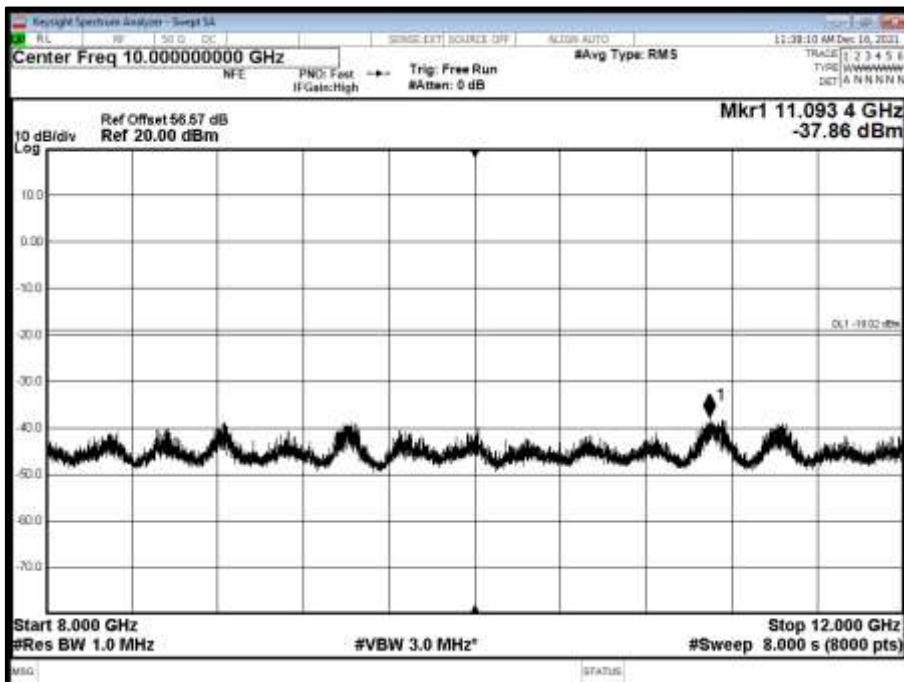



Antenna A - NR Modulation QPSK - NR Carrier Bandwidth 20.0 MHz 15 kHz SCS - Channel Position M - Band 4 - Range 12000 to 18000 MHz

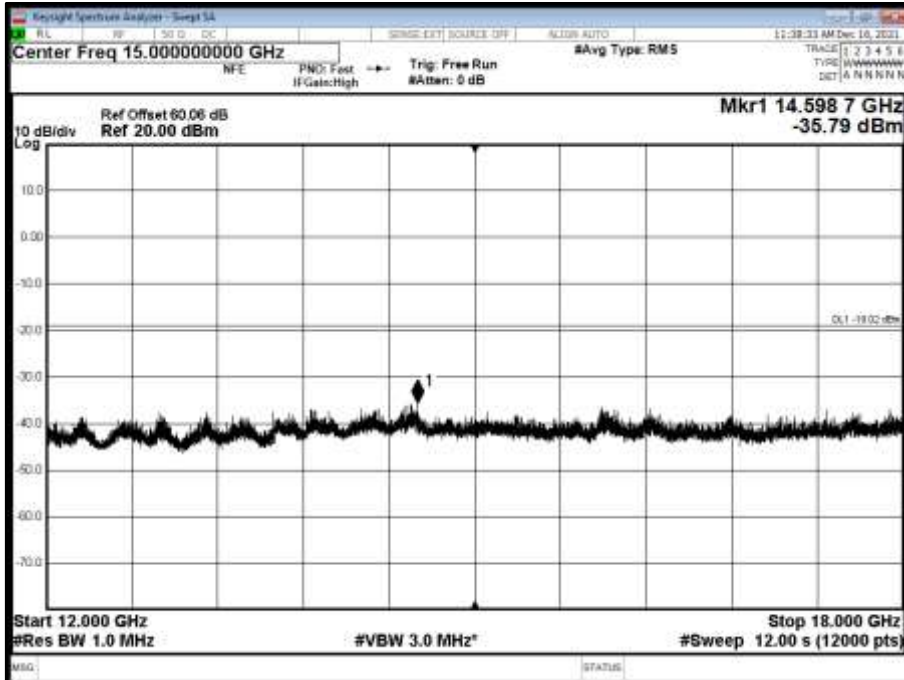

Antenna A - NR Modulation QPSK - NR Carrier Bandwidth 20.0 MHz 15 kHz SCS - Channel Position M - Band 5 - Range 18000 to 20000 MHz

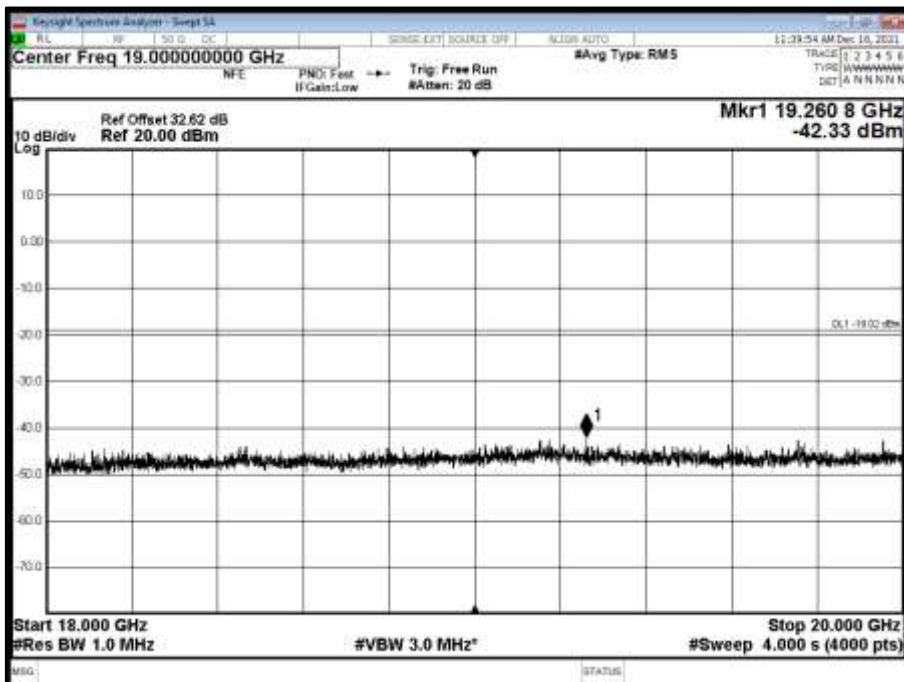



Antenna A - NR Modulation QPSK - NR Carrier Bandwidth 20.0 MHz 15 kHz SCS - Channel Position T - Band 1 - Range 0.009 to 3500 MHz

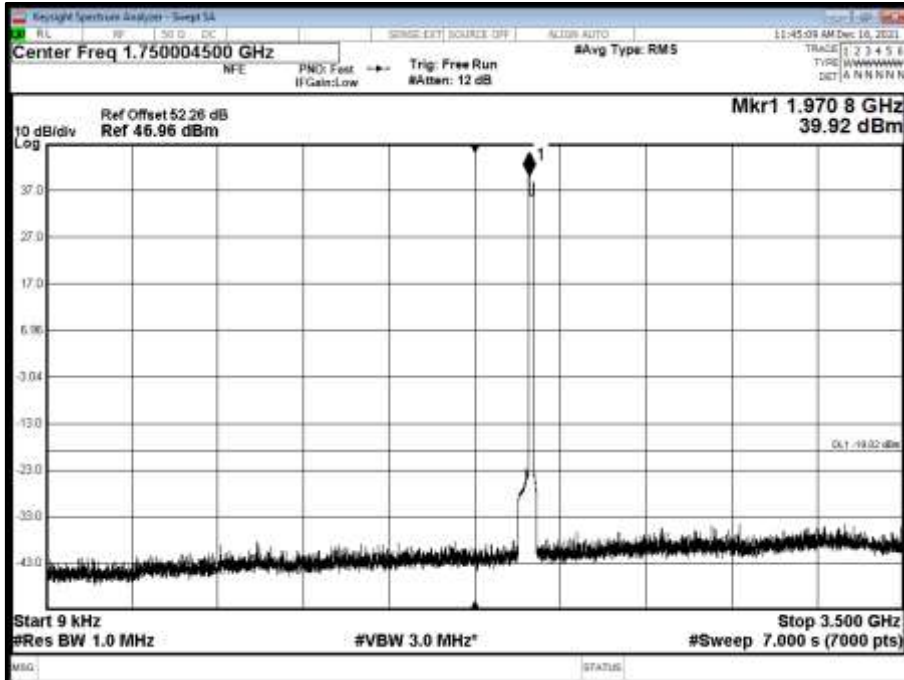

Antenna A - NR Modulation QPSK - NR Carrier Bandwidth 20.0 MHz 15 kHz SCS - Channel Position T - Band 2 - Range 3500 to 8000 MHz

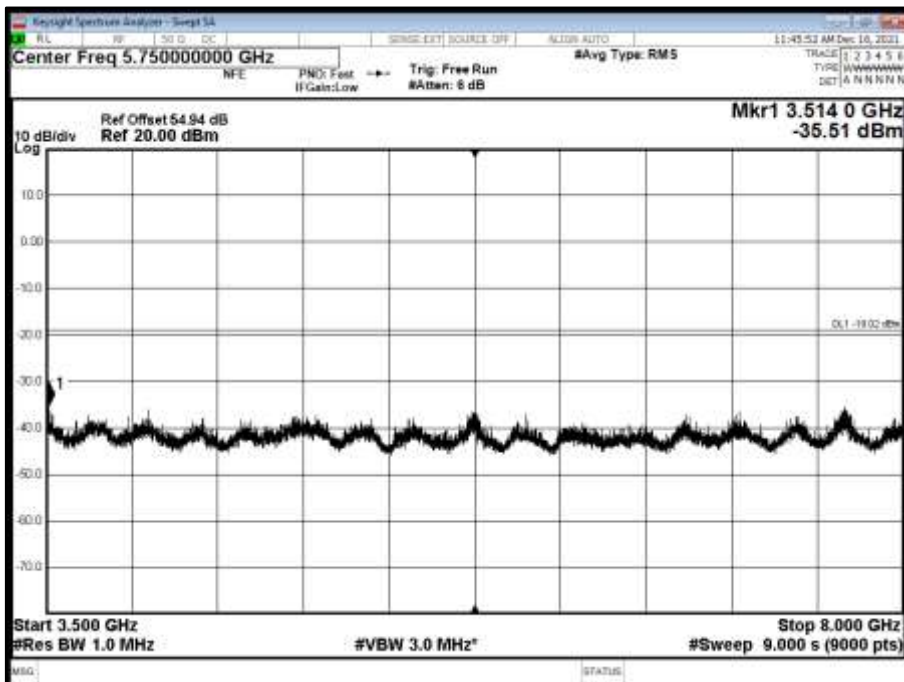





Antenna A - NR Modulation QPSK - NR Carrier Bandwidth 20.0 MHz 15 kHz SCS - Channel Position T - Band 3 - Range 8000 to 12000 MHz

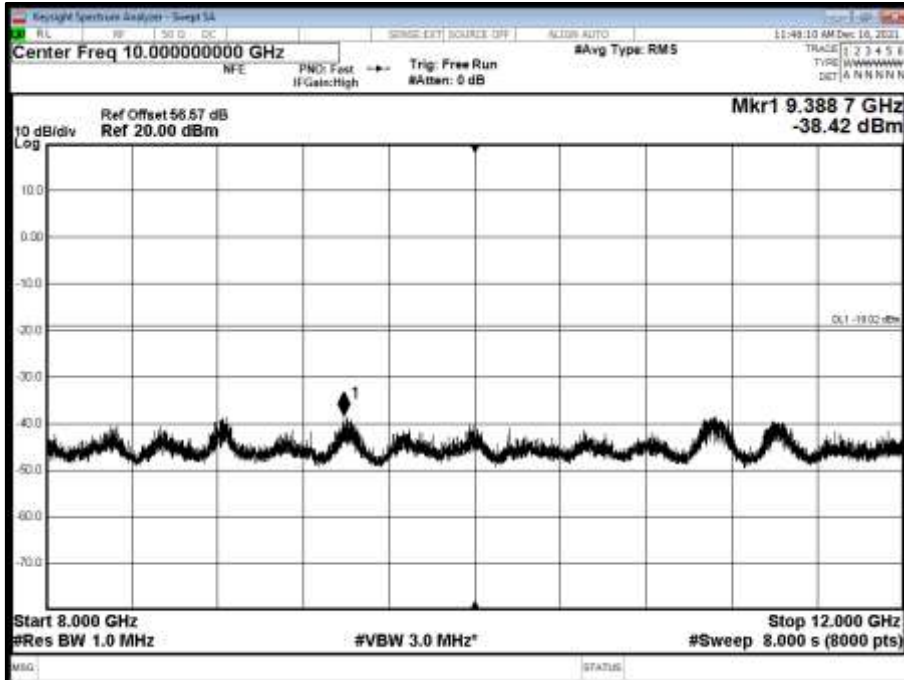

Antenna A - NR Modulation QPSK - NR Carrier Bandwidth 20.0 MHz 15 kHz SCS - Channel Position T - Band 4 - Range 12000 to 18000 MHz

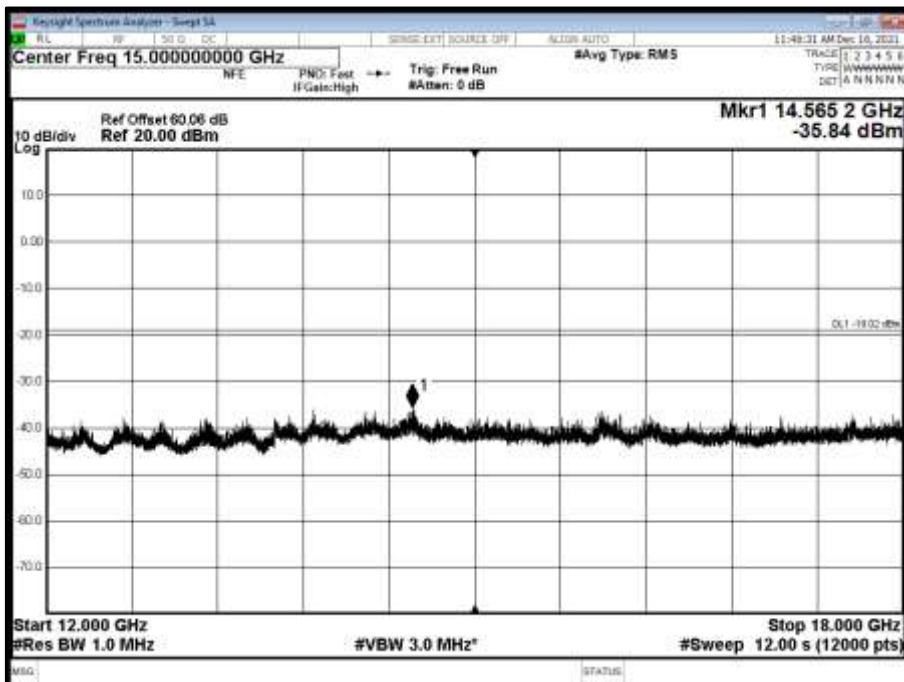



Antenna A - NR Modulation QPSK - NR Carrier Bandwidth 20.0 MHz 15 kHz SCS - Channel Position T - Band 5 - Range 18000 to 20000 MHz

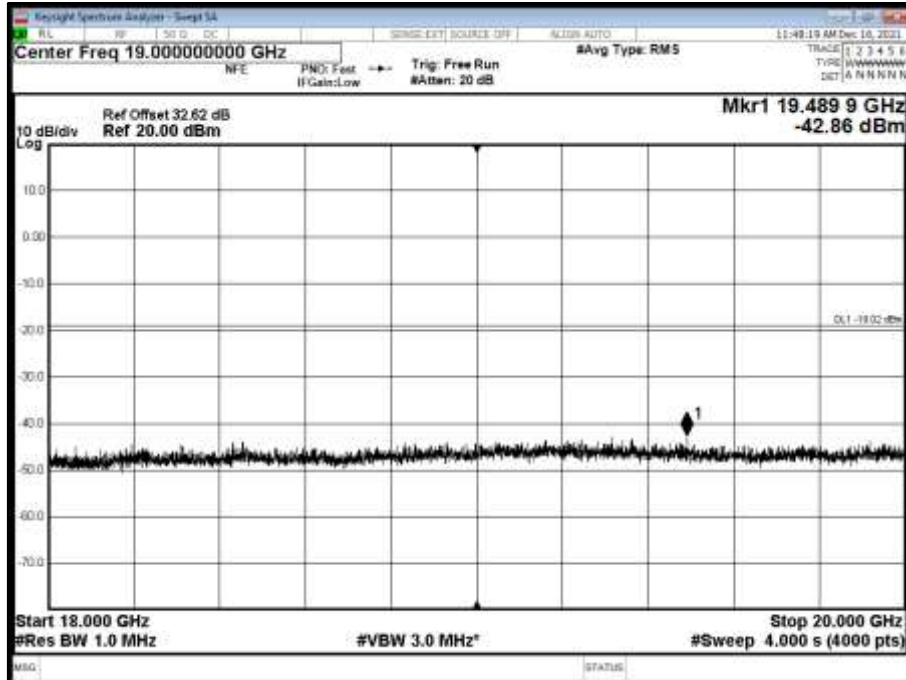

Limit	-19dBm
-------	--------



## **2.5 RADIATED EMISSIONS**

### **2.5.1 Specification Reference**

ISED RSS-GEN, Clause 6.13  
Industry Canada RSS-133, Clause 6.5  
FCC CFR 47 Part 2, Clause 2.1053

### **2.5.2 Date of Test and Modification State**

01-February-2022 - Modification State 0

### **2.5.3 Test Equipment Used**

The major items of test equipment used for the above tests are identified in Section 3.1.

### **2.5.4 Environmental Conditions**

Ambient Temperature	20.7°C
Relative Humidity	40.7%

### **2.5.5 Test Method**

The test was performed in accordance with ANSI C63.26 Clause 5. The EUT was configured as defined in ANSI C63.26, clause 5.5.2.3.2.

As a result of the conducted measurements that were performed on the EUT, it was established that NR 20 MHz was the bandwidth configuration which gave the highest output power and therefore deemed to be worst case operating mode. Testing was performed on the Top, Middle and Bottom channels for single carrier. Testing was performed on Middle channel only for multicarrier, as described in the Test Plan, the result was within 10dB of the single carrier result and therefore Middle and Top channel testing was not performed.

The EUT was set up on a support replicating typical installation conditions at a height of 0.8 m above the reference ground plane for measurements below 1GHz, (see setup photos) within a semi-anechoic chamber on a remotely controlled turntable. Above 1 GHz, the height was increased to 1.5 m above the reference ground plane.

Pre-scan and final measurements were made using a Field Strength method in accordance with ANSI C63.26 Clause 5.5.4. The readings were maximized by adjusting the antenna height, polarization and turntable azimuth, in accordance with the specification. Final results were then converted to eirp and are displayed in the plots below. The correction for field strength measurements to eirp at 3 m was 95.2 dB. An RBW of 1 MHz and VBW of 3 MHz was used for all measurements with a Peak detector and trace set to Max Hold. In all cases below where the limit line is exceeded – this is the intentional transmit frequency.

### **2.5.6 Test Results**

Configuration 1

Maximum Output Power 47.78 dBm



Frequency (MHz)	Level (dBm)	Limit (dBm)	Margin (dB)	Detector	Angle (°)	Height (cm)	Polarisation
*							

**Bot - NR&NB-IoT - B2, 1940MHz, 30 MHz to 22.5 GHz**

\*No emissions found within 6 dB of the limit.

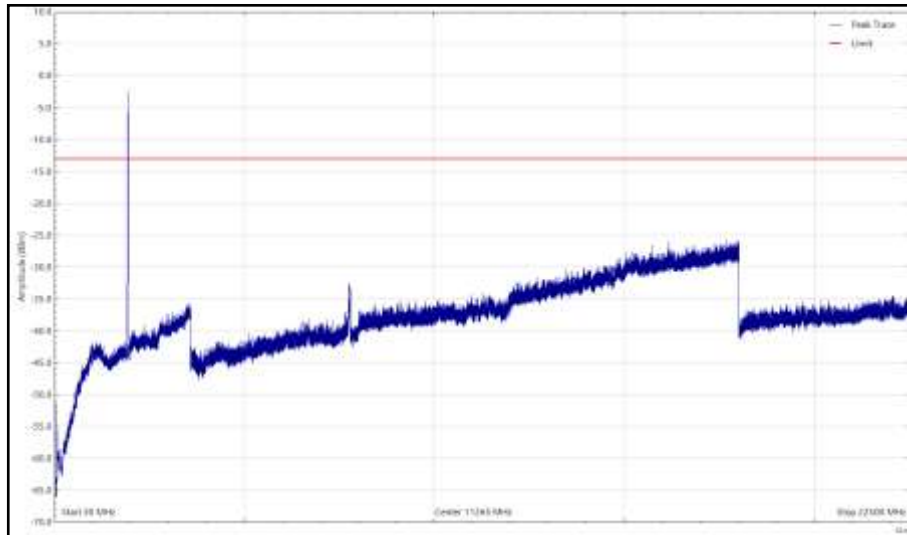

**Bot - NR&NB-IoT - B2, 1940MHz, 30 MHz to 22.5 GHz, Horizontal (Peak)**

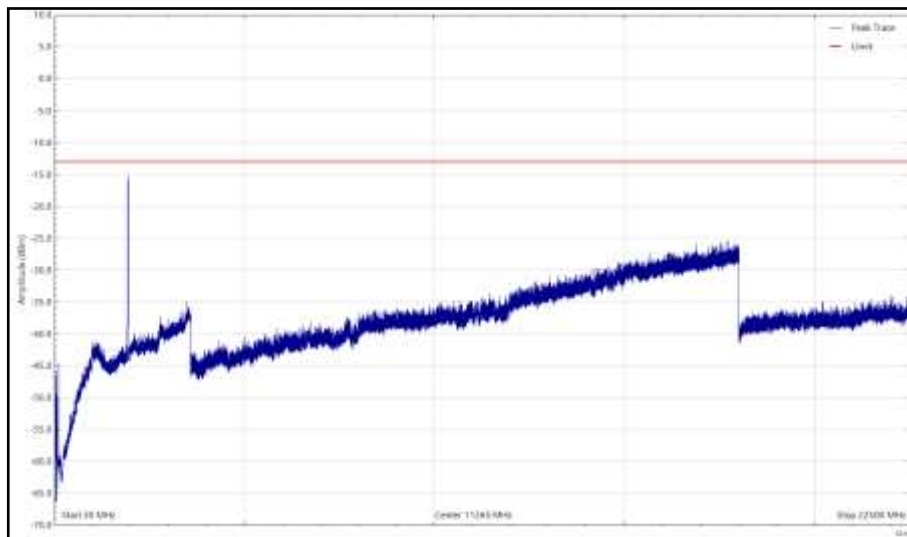

**Bot - NR&NB-IoT - B2, 1940MHz, 30 MHz to 22.5 GHz, Vertical (Peak)**



Frequency (MHz)	Level (dBm)	Limit (dBm)	Margin (dB)	Detector	Angle (°)	Height (cm)	Polarisation
*							

**Bot - NR&NB-IoT - B25, 1940MHz, 30 MHz to 22.5 GHz**

\*No emissions found within 6 dB of the limit.

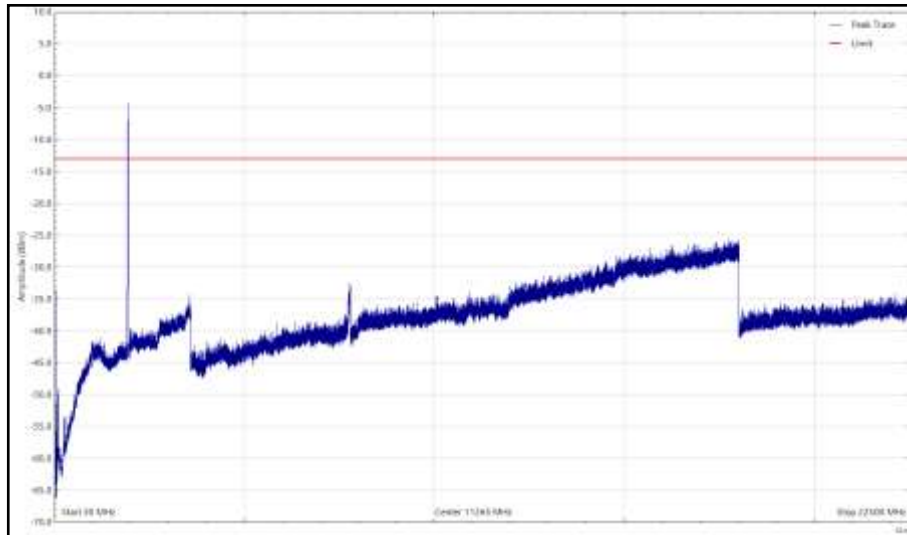

**Bot - NR&NB-IoT - B25, 1940MHz, 30 MHz to 22.5 GHz, Horizontal (Peak)**

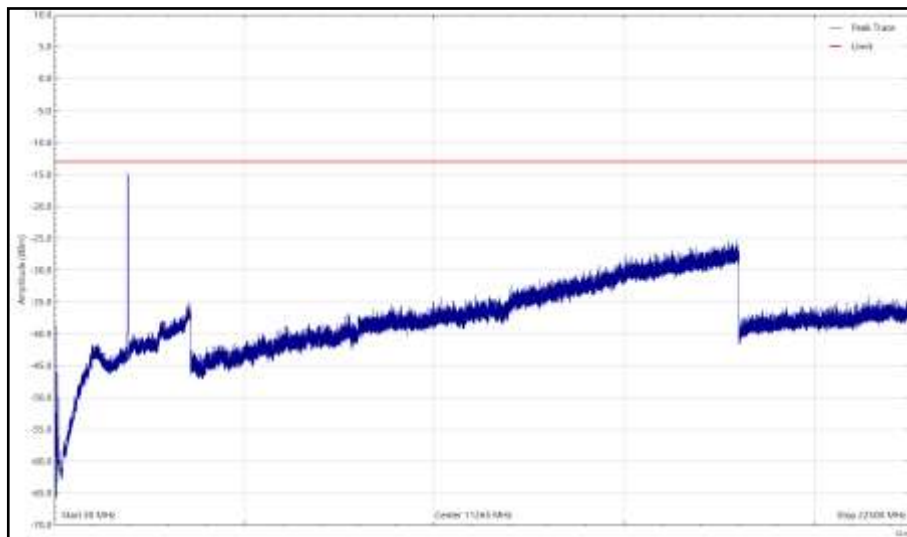

**Bot - NR&NB-IoT - B25, 1940MHz, 30 MHz to 22.5 GHz, Vertical (Peak)**



Frequency (MHz)	Level (dBm)	Limit (dBm)	Margin (dB)	Detector	Angle (°)	Height (cm)	Polarisation
*							

**Mid - NR&NB-IoT - B2, 1960MHz, 30 MHz to 22.5 GHz**

\*No emissions found within 6 dB of the limit.

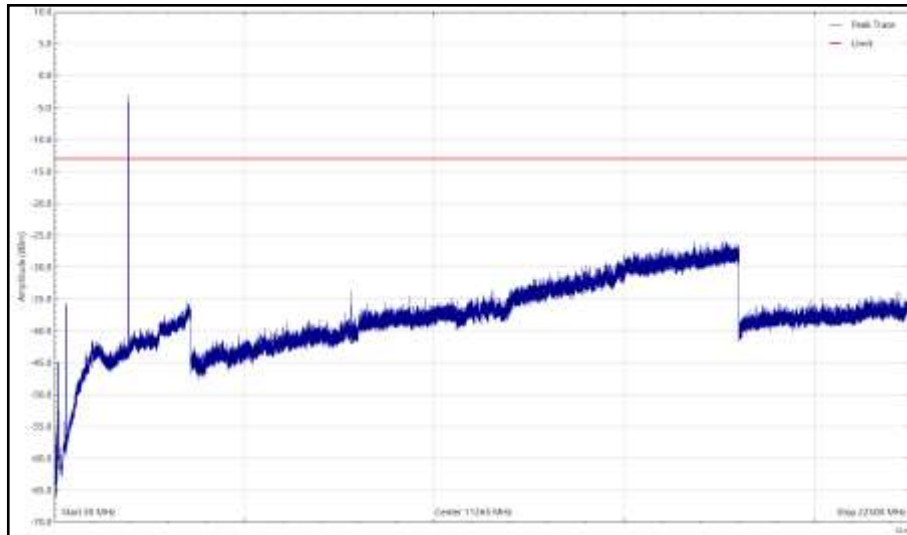

**Mid - NR&NB-IoT - B2, 1960MHz, 30 MHz to 22.5 GHz, Horizontal (Peak)**

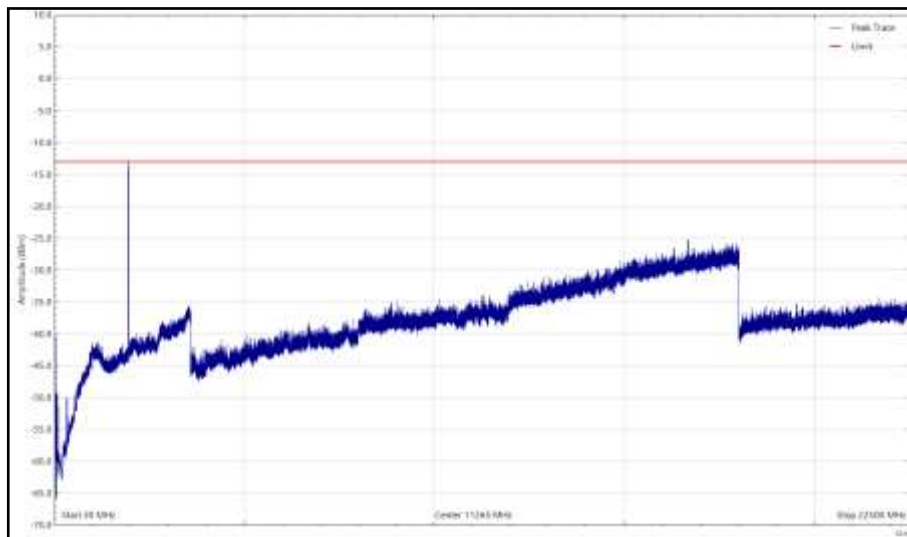

**Mid - NR&NB-IoT - B2, 1960MHz, 30 MHz to 22.5 GHz, Vertical (Peak)**



Frequency (MHz)	Level (dBm)	Limit (dBm)	Margin (dB)	Detector	Angle (°)	Height (cm)	Polarisation
*							

**Mid - NR&NB-IoT - B25, 1962.5MHz, 30 MHz to 22.5 GHz**

\*No emissions found within 6 dB of the limit.

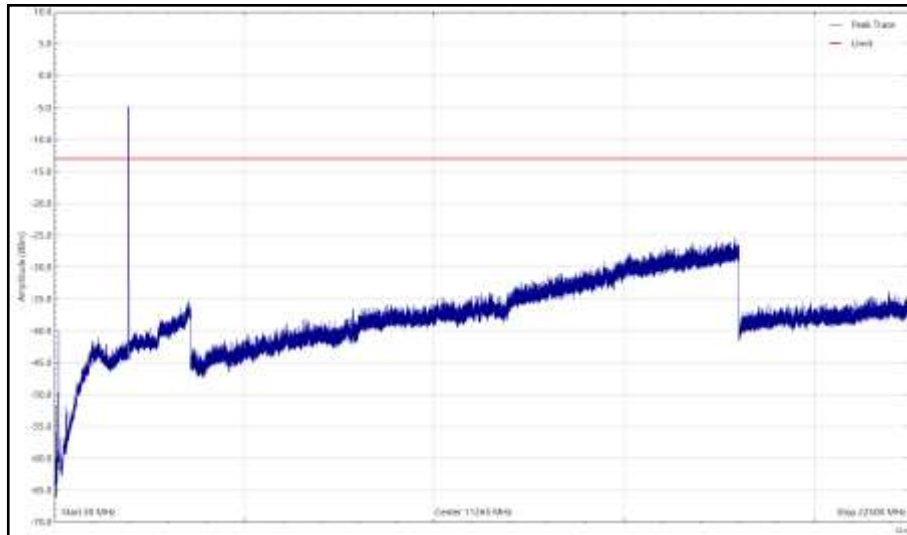

**Mid - NR&NB-IoT - B25, 1962.5MHz, 30 MHz to 22.5 GHz, Horizontal (Peak)**

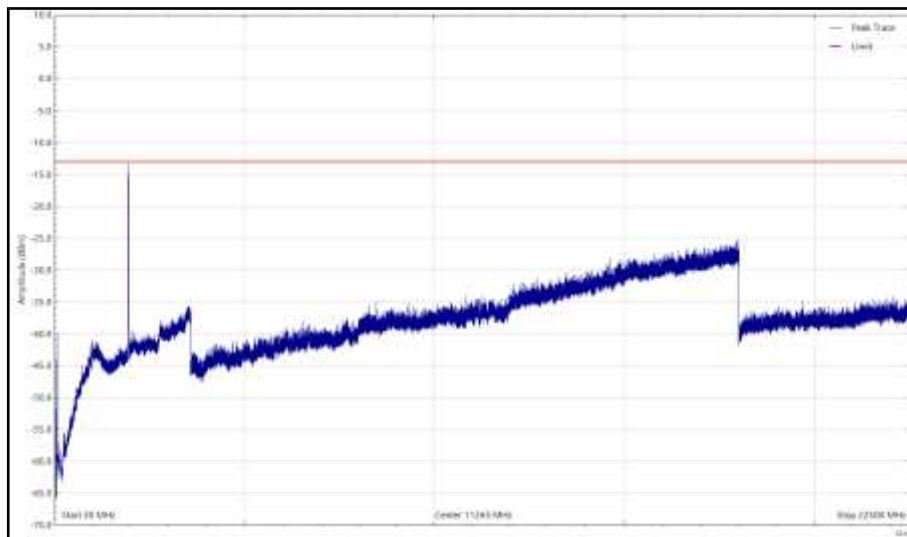

**Mid - NR&NB-IoT - B25, 1962.5MHz, 30 MHz to 22.5 GHz, Vertical (Peak)**



Frequency (MHz)	Level (dBm)	Limit (dBm)	Margin (dB)	Detector	Angle (°)	Height (cm)	Polarisation
*							

**Top - NR&NB-IoT - B2, 1980MHz, 30 MHz to 22.5 GHz**

\*No emissions found within 6 dB of the limit.

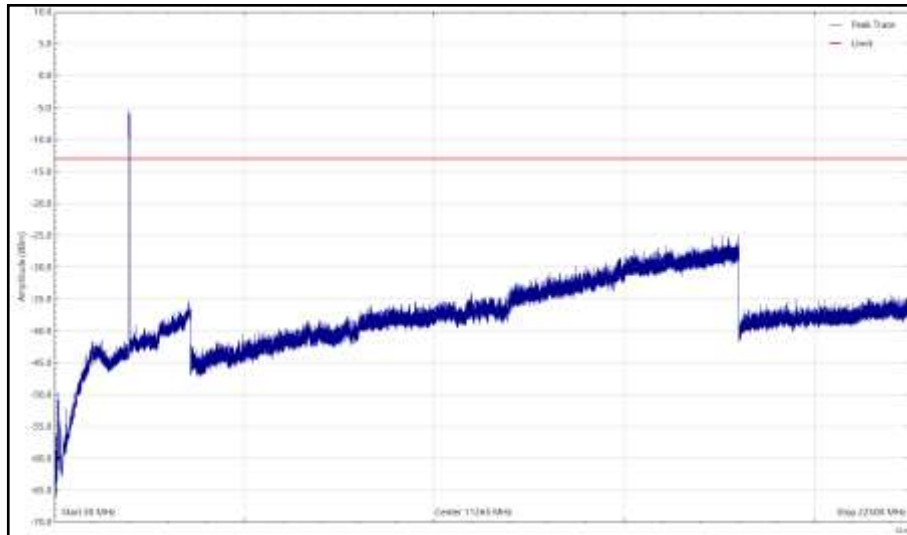

**Top - NR&NB-IoT - B2, 1980MHz, 30 MHz to 22.5 GHz, Horizontal (Peak)**

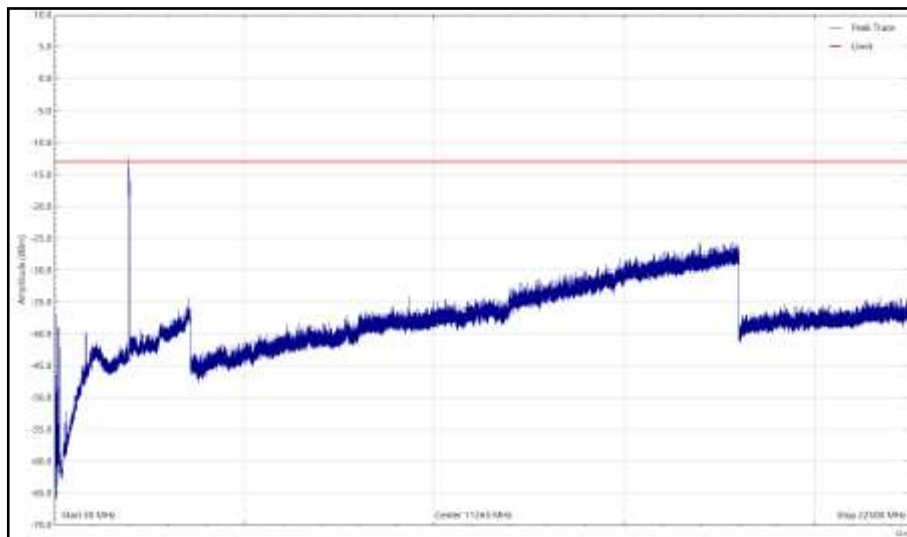

**Top - NR&NB-IoT - B2, 1980MHz, 30 MHz to 22.5 GHz, Vertical (Peak)**





Frequency (MHz)	Level (dBm)	Limit (dBm)	Margin (dB)	Detector	Angle (°)	Height (cm)	Polarisation
*							

**Top - NR&NB-IoT - B25, 1985MHz, 30 MHz to 22.5 GHz**

\*No emissions found within 6 dB of the limit.

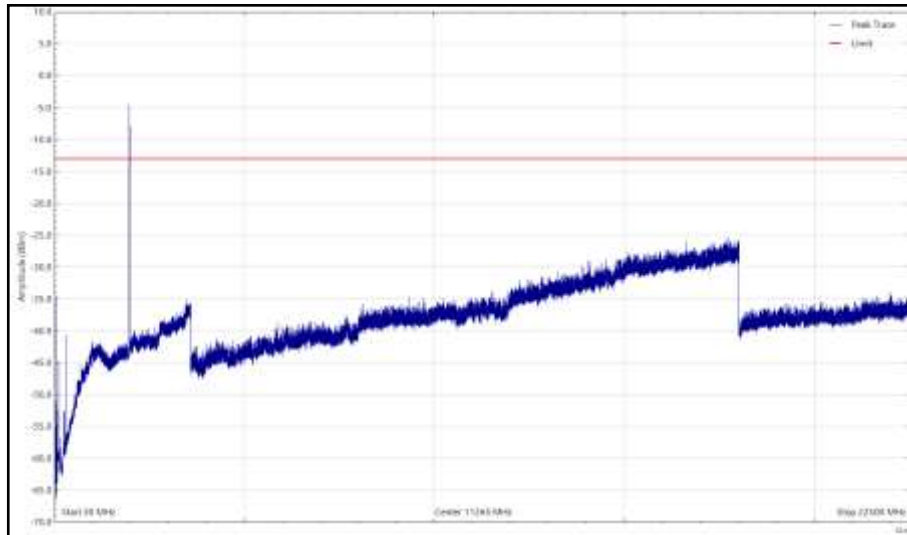

**Top - NR&NB-IoT - B25, 1985MHz, 30 MHz to 22.5 GHz, Horizontal (Peak)**

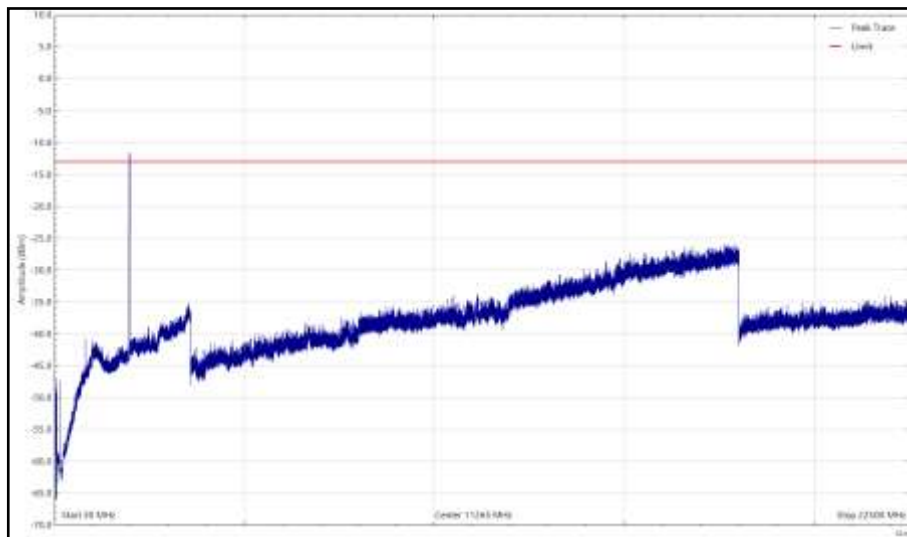

**Top - NR&NB-IoT - B25, 1985MHz, 30 MHz to 22.5 GHz, Vertical (Peak)**





### **SECTION 3**

#### **TEST EQUIPMENT USED**



### 3.1 TEST EQUIPMENT USED

List of absolute measuring and other principal items of test equipment.

Instrument	Manufacturer	Type No.	TE No.	Calibration Period (months)	Calibration Due
<b>Maximum Peak Output Power and Peak to Average Ratio - Conducted</b>					
Hygrometer	PCE Instruments	PCE-THB-40	5475	12	06-Apr-2022
Frequency Standard	Spectracom	SecureSync 1200-0408-0601	4393	6	03-Jan-2022
Analyser	Keysight	N9030A	4654	12	24-Nov-2022
Power Supply	Farnell	H60-25	1092	-	OP-MON
Multimeter	Fluke	79 Series II	3057	12	23-Aug-2022
Attenuator	Weinschel	48-40-43-LIM	5134	12	03-Jan-2022
Attenuator	Aeroflex / Weinschel	47-10-34	3166	12	13-Sep-2022
Network Analyser	Rohde & Schwarz	ZVA 40	3548	12	29-Jan-2022
Calibration Unit	Rohde & Schwarz	ZV-Z54	4368	12	30-Dec-2021
<b>Occupied Bandwidth</b>					
Hygrometer	PCE Instruments	PCE-THB-40	5475	12	06-Apr-2022
Frequency Standard	Spectracom	SecureSync 1200-0408-0601	4393	6	03-Jan-2022
Analyser	Keysight	N9030A	4654	12	24-Nov-2022
Power Supply	Farnell	H60-25	1092	-	OP-MON
Multimeter	Fluke	79 Series II	3057	12	23-Aug-2022
Attenuator	Weinschel	48-40-43-LIM	5134	12	03-Jan-2022
Attenuator	Aeroflex / Weinschel	47-10-34	3166	12	13-Sep-2022
Network Analyser	Rohde & Schwarz	ZVA 40	3548	12	29-Jan-2022
Calibration Unit	Rohde & Schwarz	ZV-Z54	4368	12	30-Dec-2021
<b>Band Edge</b>					
Hygrometer	PCE Instruments	PCE-THB-40	5475	12	06-Apr-2022
Frequency Standard	Spectracom	SecureSync 1200-0408-0601	4393	6	03-Jan-2022
Analyser	Keysight	N9030A	4654	12	24-Nov-2022
Power Supply	Farnell	H60-25	1092	-	OP-MON
Multimeter	Fluke	79 Series II	3057	12	23-Aug-2022
Attenuator	Weinschel	48-40-43-LIM	5134	12	03-Jan-2022
Attenuator	Aeroflex / Weinschel	47-10-34	3166	12	13-Sep-2022
Network Analyser	Rohde & Schwarz	ZVA 40	3548	12	29-Jan-2022
Calibration Unit	Rohde & Schwarz	ZV-Z54	4368	12	30-Dec-2021
<b>Transmitter Spurious Emissions</b>					
Hygrometer	PCE Instruments	PCE-THB-40	5475	12	06-Apr-2022
Frequency Standard	Spectracom	SecureSync 1200-0408-0601	4393	6	03-Jan-2022
Analyser	Keysight	N9030A	4654	12	24-Nov-2022



Instrument	Manufacturer	Type No.	TE No.	Calibration Period (months)	Calibration Due
Power Supply	Farnell	H60-25	1092	-	OP-MON
Multimeter	Fluke	79 Series II	3057	12	23-Aug-2022
Attenuator	Weinschel	48-40-43-LIM	5134	12	03-Jan-2022
Attenuator	Aeroflex / Weinschel	47-10-34	3166	12	13-Sep-2022
Network Analyser	Rohde & Schwarz	ZVA 40	3548	12	29-Jan-2022
Calibration Unit	Rohde & Schwarz	ZV-Z54	4368	12	30-Dec-2021
HPF	Advance Power Components	11SH10-3000/X18000-O/O	4411	12	02-Jul-2022
Cable	Junkosha	MWX241-01000KMS	5414	12	23-Jun-2022
Cable	Rosenberger	LU1-001-2000	5020	12	07-Jan-2022
Waveguide filter	Quasar	QWS20SB-UBR-UBR-50	5789	12	04-May-2022
WG20 Coaxial Adapter	Quasar	QWC20SB-UBR-K-F	5785	-	OP-MON
WG20 Coaxial Adapter	Quasar	QWC20SB-UBR-K-F	5786	-	OP-MON
Cable attenuator	Aralab	CSF6767C-C2S6500	5175	-	OP-MON
Radiated Emissions					
EMC Chamber 12	MVG	EMC-3	5621	36	11-Aug-2023
Pre-Amplifier (18 GHz to 40 GHz)	Phase One	PSO4-0087	1534	12	02-Aug-2022
Emissions Software	TUV SUD	EmX V2.1.11 V.2.1.11	5125	-	Software
Antenna (DRG, 18 GHz to 40 GHz)	Link Microtek Ltd	AM180HA-K-TU2	230	24	27-Jul-2022
Antenna with attenuator (Bilog, 30 MHz to 3 GHz)	Schaffner	CBL6143	287	24	14-Oct-2022
Cable (K-Type to K-Type, 2 m)	Scott Cables	KPS-1501-2000-KPS	4526	6	06-Mar-2022
Cable (N-Type to N-Type, 8 m)	Teledyne	PR90-088-8MTR	5450	6	08-Mar-2022
1m K-Type Cable	Junkosha	MWX241-01000KMSKMS/A	5512	12	09-Apr-2022
2m K Type Cable	Junkosha	MWX241-02000KMSKMS/A	5524	12	24-Mar-2022
Antenna (DRG, 7.5 GHz to 18 GHz)	Schwarzbeck	HWRD750	5610	12	15-Oct-2022
Antenna (DRG, 1 GHz to 10 GHz)	Schwarzbeck	BBHA 9120 B	5611	12	15-Oct-2022
Mast & Turntable Controller EMC Chamber 12	Maturo GmbH	1.5 SI-2t	5614	-	TU
Antenna (Bi-Log, 30 MHz to 1 GHz)	Teseq	CBL6111D	5615	24	16-Mar-2022

N/A – Not Applicable

O/P Mon – Output Monitored with Calibrated Equipment



### 3.2 MEASUREMENT UNCERTAINTY

For a 95% confidence level, the measurement uncertainties for defined systems are:-

Test Discipline	Frequency / Parameter	MU
Conducted Maximum Peak Output Power	9 kHz to 40 GHz Amplitude	± 1.0 dB
Conducted Emissions	9 kHz to 40 GHz Amplitude	± 3.5 dB
Occupied Bandwidth	10 MHz Bandwidth	± 16.7 kHz
	15 MHz Bandwidth	
	20 MHz Bandwidth	
Band Edge	< 3.6 GHz Amplitude	± 0.6 dB
Radiated Spurious Emissions	30 MHz to 1 GHz	± 5.2 dB
	1 GHz to 40 GHz	± 6.3 dB

#### Measurement Uncertainty Decision Rule

Determination of conformity with the specification limits is based on the decision rule according to IEC Guide 115:2007, Clause 4.4.3 and 4.5.1. (Procedure 2). The measurement results are directly compared with the test limit to determine conformance with the requirements of the standard.

Risk: The uncertainty of measurement about the measured result is negligible with regard to the final pass/fail decision. The measurement result can be directly compared with the test limit to determine conformance with the requirement (compare IEC Guide 115). The level of risk to falsely accept and falsely reject items is further described in ILAC-G8



### 3.3 MEASUREMENT SOFTWARE USED

List of measurement software versions used for testing.

Instrument	Manufacturer	Type No.	TE No.	Software Version
PXA Signal Analyser	Keysight	N9030B	4654	A22.08
HP-VEE Software	TUV SUD	HP_VEE	N/A	V3.28



## **SECTION 5**

### **ACCREDITATION, DISCLAIMERS AND COPYRIGHT**





#### 4.1 ACCREDITATION, DISCLAIMERS AND COPYRIGHT



This report relates only to the actual item/items tested.

Our UKAS Accreditation does not cover opinions and interpretations and any expressed are outside the scope of our UKAS Accreditation.

Results of tests not covered by our UKAS Accreditation Schedule are marked NUA (Not UKAS Accredited).

© 2022 TÜV SÜD  
TÜV SÜD

Postal Address :Octagon House, Concorde Way, Fareham, Hampshire, UK, PO15 5RL

**ANNEX A**

**MODULE LIST**

Configurations 1 & 2			
Product	Product No	R-State	Serial No
Radio 4460 44B2/B25 44B66 C	KRC 161 912/3	R2B	E23D043442
			E23D043115
			E23D043478
Software Version:	CXP9013268/15	Revision:	R89AJ