



EMC Test Report for LPRU 4420 B25B66 (With LTE and NR signals)

Tested to: **FCC Part 15 Subpart B / ICES 003**
FCC Part 24 (Section 24.238(a))
FCC Part 27 (Section - 27.53(h))
RSS-Gen (Section 7.0)
RSS-133 (Section 6.5)
RSS-139 (Section 6.6)
RSS-170 (Section 5.4)

Test Result summary

FCC/ ICES/ RSS Section	Description	Specification/Method	Pass or Fail	Results in section
15.109 / 6.2	Radiated Emissions (RE)	FCC Part 15 / ICES 003 / ANSI C63.4	Pass	3.2
7.0	Receiver Emissions Limits	RSS-Gen / ANSI C63.4	Pass	3.2 , 3.3
15.107 / 6.1	Conducted Emissions (CE) for AC Power	FCC Part 15 / ICES 003 / ANSI C63.4	Pass	3.3
27.53(h)	Transmitter Spurious Emissions (RE)	FCC Part 27 / ANSI C63.26	Pass	3.2
24.238(a)	Out of band Emissions (RE)	FCC Part 24 / ANSI C63.26	Pass	3.2
RSS-133 / 6.5	Transmitter unwanted Emissions	RSS-133 / ANSI C63.26	Pass	3.2
RSS-139 / 6.6	Transmitter unwanted Emissions	RSS-139 / ANSI C63.26	Pass	3.2
RSS-170 / 5.4	Transmitter unwanted Emissions	RSS-170 / ANSI C63.26	Pass	3.2

Document number: 7169008570-TR-EMC-01-01-F15

Release date: 30 October, 2020

Prepared for: Ericsson Canada



About this document

This document is written and distributed by TÜV SÜD Canada Inc. Whenever TÜV SÜD is mentioned in this document it shall be taken as referring to TÜV SÜD Canada Inc.

This test report does not imply product endorsement by any government, accreditation agency, or TÜV SÜD Canada Inc. Opinions or interpretations expressed in this report, if any, are outside the scope of the accreditations of TÜV SÜD Canada Inc. Any opinions expressed do not necessarily reflect the opinions of TÜV SÜD Canada Inc, unless otherwise stated.

Throughout this document:

- text in **blue** font is a clickable link
- text in *italics* is provided as-is from the customer

The release control record, document approvals, and laboratory Accreditations are as follows.

Release control record

This document is based on document template KG000347-TR-EMC-08-03.

Issue	Reason for change	Date released
01	initial release	30 October, 2020

Approvals

Function	Name	Job title	Signature
Technical Reviewer	Scott Drysdale	Canada Wireless Manager	
Author	Kasi Sivaratnam	EMC Test Engineer	

Accreditations

The test facilities of TÜV SÜD Canada Inc are accredited by the American Association for Laboratory Accreditation (A2LA) to ISO/IEC 17025:2017 in accordance with the scope of accreditation outlined at the website portal.a2la.org/scopepdf/2955-19.pdf.

 A2LA Cert. No. 2955.19	DISCLAIMER AND COPYRIGHT This non-binding report has been prepared by TÜV SÜD Canada with all reasonable skill and care. The document is confidential to the potential Client and TÜV SÜD Canada. No part of this document may be reproduced without the prior written approval of TÜV SÜD Canada. © TÜV SÜD.
	ACCREDITATION Our A2LA Accreditation does not cover opinions and interpretations and any expressed are outside the scope of our A2LA Accreditation.

The Canadian lab registration number associated with the TÜV SÜD test facilities is 24015.

Test lab information

Lab name	TÜV SÜD Canada Inc
Company name	TÜV SÜD Canada Inc
Mailing or shipping address	1280 Teron Road, Ottawa, Ontario, K2K 2C1, Canada
Primary technical contact	Stephen Tippet
Title	Lab Manager
Phone	613-668-5149

Customer information

Company name	Ericsson Canada
Mailing address	349 Terry Fox Drive, Ottawa, On, K2K 2V6, Canada
Primary contact	Denis Lalonde
Title	Team Leader RA Verification
Phone	613-790-2901
E-mail	Denis.lalonde@ericsson.com



Table of contents

About this document	2
1. Executive summary	9
1.1 Compliance summary	10
2. Details of the equipment under test	12
2.1 Assessed hardware	12
2.2 Product overview	12
2.3 Product port definition and EUT cable information	14
2.4 Configurations of the EUT.....	15
2.4.1 Radiated Emissions Single RAT / Single Carrier Configurations	16
2.4.2 Radiated Emissions Single RAT / Multi Carrier Configurations	17
2.4.3 Radiated Emissions Multi RAT/Multi Carrier Configuration – NR+LTE	17
2.4.4 Conducted Emissions Carrier Configuration	17
2.5 Modifications of the EUT during testing	18
2.6 Inventory of the EUT and support equipments.....	21
3. Detailed test results of Emissions	22
3.1 Measurement instrumentation.....	22
3.2 Radiated Emissions, E-field.....	23
3.2.1 Test specification and limits	23
3.2.2 Test procedure.....	24
3.2.3 Calculation of the compliance margin	25
3.2.4 Measurement uncertainties	26
3.2.5 Test results of Radiated Emissions (Single RAT/Single carrier, LTE 5M, Mid channel)....	27
3.2.6 Test results of Radiated Emissions (Single RAT/Single carrier, NR 10M, Bot channel)	33
3.2.7 Test results of Radiated Emissions (Single RAT/single carrier, NR 10M, Mid channel)	39
3.2.8 Test results of Radiated Emissions (Single RAT/single carrier, NR 10M, Top channel)	45
3.2.9 Test results of Radiated Emissions (Single RAT/Multi carrier, 2 NR 10M, Mid channel)..	52
3.2.10 Test results of Radiated Emissions (Multi RAT/Carrier, L5+2NR10, Mid channel).....	59
3.2.11 Radiated Emissions test setup pictures	65
3.2.12 Test equipment.....	68
3.2.13 Test conclusion	68
3.3 Conducted Emissions on AC power leads	69
3.3.1 Test specification and limits	69
3.3.2 Test procedure.....	69
3.3.3 Calculation of the compliance margin	70
3.3.4 Measurement uncertainties	71
3.3.5 Test results of CE on AC power ports	71
3.3.6 Test equipment.....	74
3.3.7 Test conclusion	74



4. References 75
4.1 Appendix A: Abbreviations 76

List of figures

Figure 1: The EUT, LPRU 4420 B25B66 12
Figure 2: Test configuration for Emission tests 15
Figure 3: Tested carrier detail – Single RAT / Single carrier (LTE) 16
Figure 4: Tested carrier detail – Single RAT / Single carrier (NR) 16
Figure 5: Tested carrier detail – Single RAT / Multicarrier (NR) 17
Figure 6: Tested carrier detail – MultiCarrier / Multi RAT Configuration (NR) 17
Figure 7: CE tested carrier detail 17
Figure 8: Setup of Radiated Emissions 25
Figure 9: Plot of RE at 3 m – 30 to1000 MHz (LTE 5M – Middle channel) 28
Figure 10: Plot of RE at 3m from 1 to 3 GHz (LTE 5M – Middle channel) 29
Figure 11: Plot of RE at 3m from 3 to 10 GHz (LTE 5M – Middle channel) 30
Figure 12: Plot of RE at 3m from 10 to 18 GHz (LTE 5M – Middle channel) 31
Figure 13: Plot of RE at 1m from 18 to 26.5 GHz (LTE 5M – Middle channel) 32
Figure 14: Plot of RE at 3 m – 30 to1000 MHz (NR 10M – Bot channel) 34
Figure 15: Plot of RE at 3m from 1 to 3 GHz (NR 10M – Bot channel) 35
Figure 16: Plot of RE at 3m from 3 to 10 GHz (NR 10M – Bot channel) 36
Figure 17: Plot of RE at 3m from 10 to 18 GHz (NR 10M – Bot channel) 37
Figure 18: Plot of RE at 1m from 18 to 26.5 GHz (NR 10M – Bot channel) 38
Figure 19: Plot of RE at 3 m – 30 to1000 MHz (NR 10M – Mid channel) 40
Figure 20: Plot of RE at 3m from 1 to 3 GHz (NR 10M – Mid channel) 41
Figure 21: Plot of RE at 3m from 3 to 10 GHz (NR 10M – Mid channel) 42
Figure 22: Plot of RE at 3m from 10 to 18 GHz (NR 10M – Mid channel) 43
Figure 23: Plot of RE at 1m from 18 to 26.5 GHz (NR 10M – Mid channel) 44
Figure 24: Plot of RE at 3 m – 30 to1000 MHz (NR 10M – Top channel) 46
Figure 25: Plot of RE at 3m from 1 to 3 GHz (NR 10M – Top channel) 47
Figure 26: Plot of RE at 3m from 3 to 10 GHz (NR 10M – Top channel) 48
Figure 27: Plot of RE at 3m from 3 to 10 GHz (NR 10M – Top Tx channel) 49
Figure 28: Plot of RE at 3m from 10 to 18 GHz (NR 10M – Top channel) 50
Figure 29: Plot of RE at 1m from 18 to 26.5 GHz (NR 10M – Top channel) 51
Figure 30: Plot of RE at 3 m – 30 to1000 MHz (2 * NR 10M – Mid channel) 53
Figure 31: Plot of RE at 3m from 1 to 3 GHz (2 * NR 10M – Mid channel) 54
Figure 32: Plot of RE at 3m from 3 to 10 GHz (2 * NR 10M – Mid channel) 55



Figure 33: Plot of RE at 3m from 10 to 18 GHz (2 * NR 10M – Mid channel).....	56
Figure 34: Plot of RE at 1m from 18 to 26.5 GHz (2 * NR 10M – Mid channel).....	57
Figure 35: Plot of RE at 1m from 26.5 to 40 GHz (2 * NR 10M – Mid channel).....	58
Figure 36: Plot of RE at 3 m – 30 to 1000 MHz (L5+2NR10 – Mid channel).....	60
Figure 37: Plot of RE at 3m from 1 to 3 GHz (L5+2NR10 – Mid channel).....	61
Figure 38: Plot of RE at 3m from 3 to 10 GHz (L5+2NR10, Mid channel).....	62
Figure 39: Plot of RE at 3m from 10 to 18 GHz (L5+2NR10, Mid channel).....	63
Figure 40: Plot of RE at 1m from 18 to 26.5 GHz (L5+2NR10, Mid channel).....	64
Figure 41: EUT Setup for RE tests (Closeup)	65
Figure 42: EUT Setup for RE tests at 30 MHz to 1 GHz	66
Figure 43: EUT Setup for RE tests for above 1 GHz	67
Figure 44: CE test method on AC leads for regulatory test cases	70
Figure 45: Plot of CE on AC port, line L1 for FCC Part 15 class B.....	72
Figure 46: Plot of CE on AC port, line L2 for FCC Part 15 class B.....	73
Figure 47: Setup for CE tests on AC power cables	74

List of tables

Table 1: Summary of test results for the USA; FCC Part 15 subpart B	10
Table 2: Summary of test results for the USA; FCC Part 24, Section 24.238 (a)	10
Table 3: Summary of test results for the USA; FCC Part 27 subpart C	10
Table 4: Summary of test results for Canada; ICES-003.....	10
Table 5: Summary of test results for RSS-Gen, Section 7.0.....	10
Table 6: Summary of test results for Canada, RSS-133	11
Table 7: Summary of test results for Canada, RSS-139	11
Table 8: Summary of test results for Canada, RSS-170	11
Table 9: Assessed hardware.....	12
Table 10: Product Info - LPRU 4420.....	12
Table 11: System port definition.....	14
Table 12: Inventory of the EUT (RE & CE tests).....	21
Table 13: RE test requirements.....	23
Table 14: RE limits at 10 m for Class B of FCC Part 15, ICES 003 & RSS-Gen.....	23
Table 15: Emission limits for FCC Part 24, Part 27, RSS-133, RSS-139	23
Table 16: Emission limits for RSS-170	24
Table 17: RE test results from 30 to 1000 MHz for FCC Part 15 (LTE 5M – Middle channel).....	28
Table 18: RE test results from 30 to 1000 MHz for FCC Part 24/27 (LTE 5M – Middle channel).....	28
Table 19: RE test results from 1 to 3 GHz for FCC Part 15 (LTE 5M – Middle channel).....	29



Table 20: RE test results from 1 to 3 GHz for Part 24/27 (LTE 5M – Middle channel)	29
Table 21: RE test results from 3 to 10 GHz for FCC Part 15 (LTE 5M – Middle channel).....	30
Table 22: RE test results from 3 to 10 GHz for Part 24/27 (LTE 5M – Middle channel)	30
Table 23: RE test results from 10 to 18 GHz for FCC Part 15 (LTE 5M – Middle channel).....	31
Table 24: RE test results from 10 to 18 GHz for Part 24/27 (LTE 5M – Middle channel)	31
Table 25: RE test results from 30 to 1000 MHz for FCC Part 15 (NR 10M – Bot channel)	34
Table 26: RE test results from 30 to 1000 MHz for FCC Part 24/27 (NR 10M – Bot channel)	34
Table 27: RE test results from 1 to 3 GHz for FCC Part 15 (NR 10M – Bot channel)	35
Table 28: RE test results from 1 to 3 GHz for Part 24/27 (NR 10M – Bot channel).....	35
Table 29: RE test results from 3 to 10 GHz for FCC Part 15 (NR 10M – Bot channel)	36
Table 30: RE test results from 3 to 10 GHz for Part 24/27 (NR 10M – Bot channel).....	36
Table 31: RE test results from 10 to 18 GHz for FCC Part 15 (NR 10M – Bot channel)	37
Table 32: RE test results from 10 to 18 GHz for Part 24/27 (NR 10M – Bot channel).....	37
Table 33: RE test results from 30 to 1000 MHz for FCC Part 15 (NR 10M – Mid channel).....	40
Table 34: RE test results from 30 to 1000 MHz for FCC Part 24/27 (NR 10M – Mid channel)	40
Table 35: RE test results from 1 to 3 GHz for FCC Part 15 (NR 10M – Mid channel)	41
Table 36: RE test results from 1 to 3 GHz for Part 24/27 (NR 10M – Mid channel).....	41
Table 37: RE test results from 3 to 10 GHz for FCC Part 15 (NR 10M – Mid channel)	42
Table 38: RE test results from 3 to 10 GHz for Part 24/27 (NR 10M – Mid channel).....	42
Table 39: RE test results from 10 to 18 GHz for FCC Part 15 (NR 10M – Mid channel)	43
Table 40: RE test results from 10 to 18 GHz for Part 24/27 (NR 10M – Mid channel).....	43
Table 41: RE test results from 30 to 1000 MHz for FCC Part 15 (NR 10M – Top channel).....	46
Table 42: RE test results from 30 to 1000 MHz for FCC Part 24/27 (NR 10M – Top channel).....	46
Table 43: RE test results from 1 to 3 GHz for FCC Part 15 (NR 10M – Top channel)	47
Table 44: RE test results from 1 to 3 GHz for Part 24/27 (NR 10M – Top channel).....	47
Table 45: RE test results from 3 to 10 GHz for FCC Part 15 (NR 10M – Top channel)	48
Table 46: RE test results from 3 to 10 GHz for Part 24/27 (NR 10M – Top channel).....	48
Table 47: RE test results from 3 to 10 GHz for FCC Part 15 (NR 10M – Top Tx channel)	49
Table 48: RE test results from 3 to 10 GHz for Part 24/27 (NR 10M – Top Tx channel)	49
Table 49: RE test results from 10 to 18 GHz for FCC Part 15 (NR 10M – Top channel)	50
Table 50: RE test results from 10 to 18 GHz for Part 24/27 (NR 10M – Top channel).....	50
Table 51: RE test results from 30 to 1000 MHz for FCC Part 15 (2 * NR 10M – Mid channel).....	53
Table 52: RE test results from 30 to 1000 MHz for FCC Part 24/27 (2 * NR 10M – Mid channel)	53
Table 53: RE test results from 1 to 3 GHz for FCC Part 15 (2 * NR 10M – Mid channel)	54
Table 54: RE test results from 1 to 3 GHz for Part 24/27 (2 * NR 10M – Mid channel).....	54
Table 55: RE test results from 3 to 10 GHz for FCC Part 15 (2 * NR 10M – Mid channel)	55
Table 56: RE test results from 3 to 10 GHz for Part 24/27 (2 * NR 10M – Mid channel).....	55



Table 57: RE test results from 10 to 18 GHz for FCC Part 15 (2 * NR 10M – Mid channel)	56
Table 58: RE test results from 10 to 18 GHz for Part 24/27 (2 * NR 10M – Mid channel).....	56
Table 59: RE test results from 30 to 1000 MHz for FCC Part 15 (L5+2NR10, Mid channel)	60
Table 60: RE test results from 30 to 1000 MHz for FCC Part 24/27 (L5+2NR10, Mid channel)	60
Table 61: RE test results from 1 to 3 GHz for FCC Part 15 (L5+2NR10, Mid channel)	61
Table 62: RE test results from 1 to 3 GHz for Part 24/27 (L5+2NR10, Mid channel).....	61
Table 63: RE test results from 3 to 10 GHz for FCC Part 15 (L5+2NR10, Mid channel)	62
Table 64: RE test results from 3 to 10 GHz for Part 24/27 (L5+2NR10, Mid channel).....	62
Table 65: RE test results from 10 to 18 GHz for FCC Part 15 (L5+2NR10, Mid channel)	63
Table 66: RE test results from 10 to 18 GHz for Part 24/27 (L5+2NR10, Mid channel).....	63
Table 67: Test equipment used for RE	68
Table 68: CE test requirements on AC power leads	69
Table 69: CE test limits on AC power leads for Class B.....	69
Table 70: CE test results on AC port, line L1 for FCC Part 15 class B.....	72
Table 71: CE test results on AC port, line L2 for FCC Part 15 class B.....	73
Table 72: Test equipment used for CE on AC power leads.....	74

1. Executive summary

This document reports the Electromagnetic Compatibility (EMC) testing performed on the product called LPRU 4420 B25B66 for Ericsson Canada per project number 7169008570. The objective of the test activities is to evaluate compliance of the product to following EMC regulatory standards.

The LPRU 4420 B25B66 is verified to comply with the Class B Emissions requirements of these standards:

- FCC Part 15 Subpart B [5] (Class B)
- FCC Part 24 [7] (Emissions Limitations for broadband PCS equipment, Section 24.238(a))
- FCC Part 27 [8] (Digital Base Stations, Section - 27.53(h))
- ICES 003 [9] (Class B)
- RSS-Gen [13] (Receiver emissions Limits, Section 7.0)
- RSS-133 [10] (Transmitter unwanted Emissions, Section 6.5)
- RSS-139 [11] (Transmitter unwanted Emissions, Section 6.6)
- RSS-170 [12] (Transmitter unwanted Emissions, Section 5.4)

Information about the test result summary and, the equipment under test (EUT) is in the sections:

- [Compliance summary](#)
- [Details of the equipment under test](#)
- [Detailed test results of Emissions](#)

1.1 Compliance summary

The test results in this report apply only to the tested components that are identified in the section [Assessed hardware](#).

The following table summarizes the EMC test results for the test cases performed on the LPRU 4420 B25B66

Table 1: Summary of test results for the USA; FCC Part 15 subpart B

FCC Section	Description	Specification/Method	Pass or Fail	Results in section
15.109	Radiated Emissions (RE)	FCC Part 15/ANSI C63.4	Pass	3.2
15.107	Conducted Emissions (CE) for AC Power	FCC Part 15/ANSI C63.4	Pass	3.3

Table 2: Summary of test results for the USA; FCC Part 24, Section 24.238 (a)

FCC Section	Description	Specification/Method	Pass or Fail	Results in section
24.238 (a)	Emissions Limitations for Broadband PCS equipment – Out of band emissions	FCC Part 24/ ANSI C63.26	Pass	3.2

Table 3: Summary of test results for the USA; FCC Part 27 subpart C

FCC Section	Description	Specification/Method	Pass or Fail	Results in section
27.53(h)	AWS emission limits	FCC Part 27/ ANSI C63.26	Pass	3.2

Table 4: Summary of test results for Canada; ICES-003

ICES Section	Description	Specification/Method	Pass or Fail	Results in section
6.2	Radiated Emissions (RE)	ICES 003/ANSI C63.4	Pass	3.2
6.1	Conducted Emissions (CE) for AC Power	ICES 003/ANSI C63.4	Pass	3.3

Table 5: Summary of test results for RSS-Gen, Section 7.0

RSS-Gen Section	Description	Specification/Method	Pass or Fail	Results in section
7.3	Receiver Radiated Emissions	RSS-Gen / ANSI C63.4	Pass	3.2
7.2	Conducted Emissions (CE) for AC Power	RSS-Gen / ANSI C63.4	Pass	3.3
7.4	Receiver Conducted Emissions	See antenna port conducted emissions in applicable test report		



Table 6: Summary of test results for Canada, RSS-133

RSS-133 Section	Description	Specification/Method	Pass or Fail	Results in section
6.5	Transmitter unwanted Emissions	RSS-133 / ANSI C63.26	Pass	3.2

Table 7: Summary of test results for Canada, RSS-139

RSS-139 Section	Description	Specification/Method	Pass or Fail	Results in section
6.6	Transmitter unwanted Emissions	RSS-139 / ANSI C63.26	Pass	3.2

Table 8: Summary of test results for Canada, RSS-170

RSS-170 Section	Description	Specification/Method	Pass or Fail	Results in section
5.4	Transmitter unwanted Emissions	RSS-170 / ANSI C63.26	Pass	3.2

2. Details of the equipment under test

This section describes the equipment under test (EUT).

2.1 Assessed hardware

The following table indicates the hardware components that were assessed during this test program.

Table 9: Assessed hardware

Hardware component	Part number
Low Power Radio Unit 4420 B25B66 (LPRU 4420, B25B66)	KRC 161 906/1

2.2 Product overview

The product trade name is LPRU 4420 B25B66. The LPRU 4420 product is an indoor wireless telecommunication product. It is a radio unit that provides cellular service. It can operate from AC power (100-250VAC) and DC power (-48VDC).

Figure 1: The EUT, LPRU 4420 B25B66

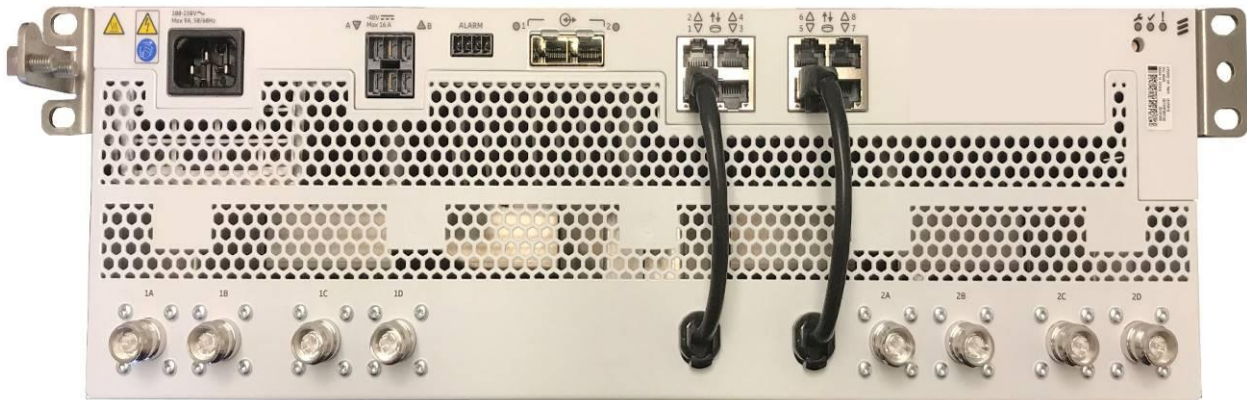

Table 10: Product Info - LPRU 4420

Product data:	
Product Name	LPRU 4420 B25B66
Revision:	R1A
P/N:	KRC 161 906/1
Nominal Voltage:	110VAC or -48VDC
Operating Temperature:	0°C to +55°C
Dimensions: (H x W x D)	443 x 132 x 370mm (WxHxD)
Weight;	13.6 kg



Product data:	
Band25: (BC1)	DL: 1930 – 1995 MHz; UL: 1850 - 1915MHz
Capability sets (SC):	CS16 L+NR
Markets:	FCC
No of RF ports:	4 (1A,1B,1C,1D)
Output power per port:	Single Carrier: 1 x 158.5mW (22dBm)
Limitation outp power:	~22dBm
IBW:	65MHz
IBW limitation:	Contiguous operations only
RAT supported	NR + LTE + NB IoT IB/GB SC, MC
supported LTE/NR BW:	5, 10, 15, 20MHz
Max No of carriers per port in MR:	3
Max no of LTE/NR per port	3
Max no of GSM per port	na
Modulations, LTE	QPSK, 16QAM, 64QAM, 256QAM
Modulations, GSM	na
NB IoT IB per LTE host	1
NB IoT GB per LTE host (min 10MHz)	1
NB IoT SA per port	na
NR FDD FR1	yes
CIPR	
Band66: (BC1)	DL: 2110 - 2200MHz; UL: 1710 – 1780MHz
Capability sets (SC):	CS16 L+NR
Markets:	FCC
No of RF ports:	4 (2A,2B,2C,2D)
Output power per port:	Single Carrier: 1 x 158.5mW (22dBm)
Limitation outp power:	~22dBm
IBW:	70MHz
IBW limitation:	Contiguous operations only
RAT supported	NR + LTE + NB IoT IB/GB SC, MC
supported LTE BW:	5, 10, 15, 20MHz
Max No of carriers per port in MR:	3
Max no of LTE/NR per port	3
Max no of GSM per port	na
Modulations, LTE	QPSK, 16QAM, 64QAM, 256QAM
Modulations, GSM	na
NB IoT IB per LTE host	1
NB IoT GB per LTE host (min 10MHz)	1
NB IoT SA per port	na

Product data:	
NR FDD FR1	yes
CIPR	

The Configurations of the LPRU 4420 B25B66 that were tested is shown in the section [Configurations of the EUT](#). The EUT was tested in a tabletop setting.

2.3 Product port definition and EUT cable information

[Table 11](#) identifies all the cables and ports on the EUT. The Environment of the cables is indoor.

Table 11: System port definition

Port Name	Port Description	Port Type	Interface Detail	Plug-Cable Type	Port Test setup
AC-IN	100-250VAC, 50/60 Hz	AC Power	AC, single phase	C14, AC cable	6' cable, C14,
DC-IN-A/B	-48VDC, 3 Wire, A and B feed inputs	DC Power	3-wire or 2-wire	3-wire, AWG-10, 6mm2	1 branch is enough, test both 2w & 3w,
Alarm	External Alarm Input 1 and 2	Signal	2x2pin, single ended	AWG-?, unshielded,	1 branch is enough,
Data-1/2	CPRI -1 and -2	Telecom	CPRI, 2.5/5/9.8/10.1 Gbs	Optical SFP+ fiber (1km), No support for eCPRI	none
dRDI 1-8	IRU/DOT Interface, partly Internal	Internal	5G/10GBase-T, Ethernet	RJ-45, Cat6A, fixed internal termination	none
1A / 1B / 1C / 1D	RF I/O ports - Band 25	Antenna	to active DAS ports (Dot side-1)	2.2-5 connector,	SMA adaptor used on all ports,
2A / 2B / 2C / 2D	RF I/O ports - Band 66	Antenna	to active DAS ports (Dot side-2)	2.2-5 connector,	SMA adaptor used on all ports,
MMI	LPRU Status LEDs	n/a	n/a	n/a	none
Ground	Ground Lug (EUT front)	Ground	AWG-6, wire	Dual Hole Flag Lug, AWG-6 (RPM777567)	6' Gnd cable attached

2.4 Configurations of the EUT

Figure 2 shows the configuration of the EUT for Emissions test.

Figure 2: Test configuration for Emission tests

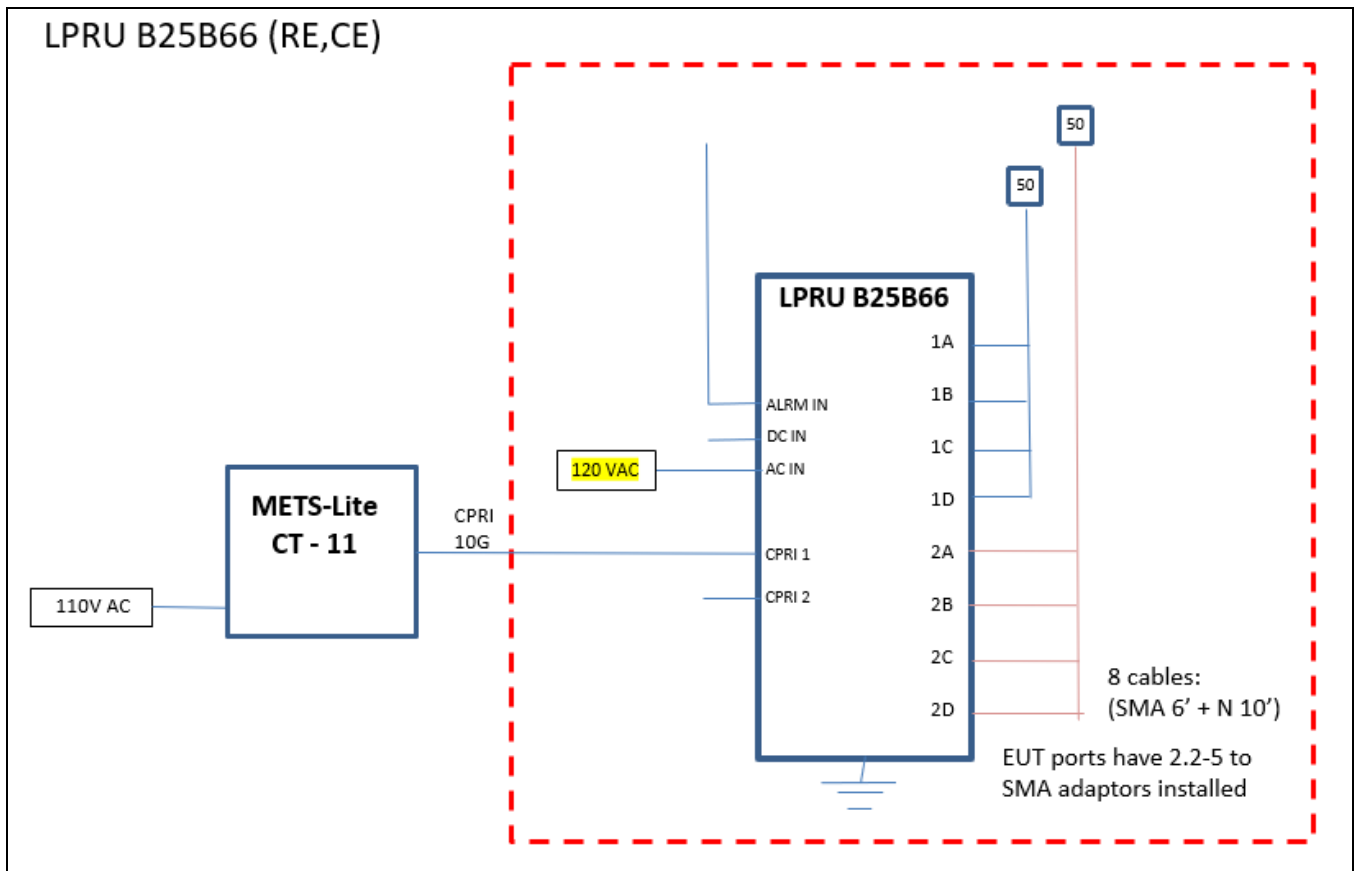

2.4.1 Radiated Emissions Single RAT / Single Carrier Configurations

Figure 3: Tested carrier detail – Single RAT / Single carrier (LTE)

Single RAT and Single Carrier		
	Band 25	Band 66
Middle	L5, 1962.5MHz	L5, 2155MHz
Middle	L10/GB, 1962.5MHz	L10/GB, 2155MHz
Middle	L15/GB, 1962.5MHz	L15/GB, 2155MHz
Middle	L20/GB, 1962.5MHz	L20/GB, 2155MHz

Note: Radiated Emissions measurements were compared between L5, L10/GB, L15/GB and L20/GB. L5 was found to have higher emissions than L10/GB, L15/GB and L20/GB. All plots with single LTE carrier in this report are therefore measured using LTE 5 Middle channel carrier configurations.

Figure 4: Tested carrier detail – Single RAT / Single carrier (NR)

Single RAT and Single Carrier		
	Band 25	Band 66
Middle	NR5, 1962.5MHz	NR5, 2155MHz
Middle	NR10, 1962.5MHz	NR10, 2155MHz
Middle	NR15, 1962.5MHz	NR15, 2155MHz
Middle	NR20, 1962.5MHz	NR20, 2155MHz
Bottom	NR10, 1935MHz	NR10, 2115MHz
Top	NR10, 1990MHz	NR10, 2175MHz
Top Tx	NR10, 1990MHz	NR10, 2195MHz

Note: Radiated Emissions measurements were compared between NR5, NR10, NR15 and NR20. NR 10 was found to have higher emissions than NR 5, NR15 and NR 20. All plots with single NR carrier in this report are therefore measured using NR 10 carrier configurations.

2.4.2 Radiated Emissions Single RAT / Multi Carrier Configurations

Figure 5: Tested carrier detail – Single RAT / Multicarrier (NR)

Single RAT and Multi Carrier		
	Band 25	Band 66
MC 1	2NR10, 1957.5,1967.5MHz	2NR10, 2150,2160MHz
MC 2	3NR10, 1952.5,1962.5,1972.5MHz	3NR10, 2145,2155,2165MHz

Note: Radiated Emissions measurements were compared between MC 1 and MC 2. MC 1 was found to have higher emissions. All plots with Single RAT/Multi carrier in this report are therefore measured using MC 1 carrier configuration.

2.4.3 Radiated Emissions Multi RAT/Multi Carrier Configuration – NR+LTE

Figure 6: Tested carrier detail – MultiCarrier / Multi RAT Configuration (NR)

Multi RAT & Multi Carrier		
	Band 25	Band 66
MR 1	L5+NR10, 1957.5,1965MHz	L5+NR10, 2150,2157.5MHz
MR 2	2L5+NR10, 1955,1960,1967.5MHz	2L5+NR10, 2147.5,2152.5,2160MHz
MR 3	L5+2NR10, 1952.5,1960,1970MHz	L5+2NR10, 2145,2152.5,2162.5MHz

Note: Radiated Emissions measurements were compared between MR 1, MR 2 and MR 3. MR 3 was found to have higher emissions than MR 1 & MR 2. All plots with Multi RAT/Multi carrier in this report are therefore measured using MR 3 Middle channel carrier configuration.

2.4.4 Conducted Emissions Carrier Configuration

Figure 7: CE tested carrier detail

Multi RAT & Multi Carrier		
	Band 25	Band 66
MR 3	L5+2NR10, 1952.5,1960,1970MHz	L5+2NR10, 2145,2152.5,2162.5MHz

2.5 Modifications of the EUT during testing

The EUT was modified prior to testing. Following tables list the modifications made to tested EUT release R1A; as per customer.

“Each of the 2 transceivers (KRH 901 185/1) have the following modifications.

Removed Parts		
R1A7	REP 621 103/22	220ohm 1% 0201 0.05W/RESISTOR
R27A7	REP 621 103/22	220ohm 1% 0201 0.05W/RESISTOR
R3A7	REP 621 103/22	220ohm 1% 0201 0.05W/RESISTOR
R52A7	REP 621 103/22	220ohm 1% 0201 0.05W/RESISTOR
R54A7	REP 621 103/22	220ohm 1% 0201 0.05W/RESISTOR
R7A7	REP 621 103/22	220ohm 1% 0201 0.05W/RESISTOR
R82A7	REP 621 103/22	220ohm 1% 0201 0.05W/RESISTOR
R84A7	REP 621 103/22	220ohm 1% 0201 0.05W/RESISTOR

New Parts		
C111A7	RJC 545 1011/16C	1.6pF +/-0.1pF 0201 25V HQ C0G/CAPACITOR
C141A7	REP 621 103/15	150ohm 1% 0201 0.05W/RESISTOR
C249A7	REP 621 103/15	150ohm 1% 0201 0.05W/RESISTOR
C251A7	REP 621 103/15	150ohm 1% 0201 0.05W/RESISTOR
C27A7	REP 621 103/15	150ohm 1% 0201 0.05W/RESISTOR
C83A7	RJC 545 1011/16C	1.6pF +/-0.1pF 0201 25V HQ C0G/CAPACITOR
L20A7	REG 724 5182/1PH	10nH 3% 0201/INDUCTOR
R103A7	REP 621 103/15	150ohm 1% 0201 0.05W/RESISTOR
R104A7	REP 621 103/15	150ohm 1% 0201 0.05W/RESISTOR
R106A7	REP 621 103/15	150ohm 1% 0201 0.05W/RESISTOR
R107A7	REP 621 103/15	150ohm 1% 0201 0.05W/RESISTOR
R94A7	REG 724 5181/39PB	3.9nH +/-0.1nH 0201/INDUCTOR
R67A7	REG 724 5181/39PB	3.9nH +/-0.1nH 0201/INDUCTOR



Replaced Parts (Red is the original part, green is the new part)		
C100A7	REG 724 5181/2PB	2.0nH +/-0.1nH 0201/INDUCTOR
C100A7	RJC 545 1011/39C	3.9pF +/-0.1pF 0201 25V HQ C0G/CAPACITOR
C72A7	REG 724 5181/2PB	2.0nH +/-0.1nH 0201/INDUCTOR
C72A7	RJC 545 1011/39C	3.9pF +/-0.1pF 0201 25V HQ C0G/CAPACITOR
L24A7	REP 621 001/0	0 ohm 0201 0.05W 0.5A/RESISTOR
L24A7	REG 724 5181/29PB	2.9nH +/-0.1nH 0201/INDUCTOR
L32A7	REP 621 001/0	0 ohm 0201 0.05W 0.5A/RESISTOR
L32A7	REG 724 5181/29PB	2.9nH +/-0.1nH 0201/INDUCTOR
L33A7	REP 621 001/0	0 ohm 0201 0.05W 0.5A/RESISTOR
L33A7	REP 621 102/499	49.9ohm 1% 0201 0.05W/RESISTOR
L34A7	REP 621 001/0	0 ohm 0201 0.05W 0.5A/RESISTOR
L34A7	REP 621 102/499	49.9ohm 1% 0201 0.05W/RESISTOR
L66A7	REP 621 001/0	0 ohm 0201 0.05W 0.5A/RESISTOR
L66A7	REP 621 102/499	49.9ohm 1% 0201 0.05W/RESISTOR
L67A7	REP 621 001/0	0 ohm 0201 0.05W 0.5A/RESISTOR
L67A7	REP 621 102/499	49.9ohm 1% 0201 0.05W/RESISTOR
R10A7	REP 621 102/27	27ohm 1% 0201 0.05W/RESISTOR
R10A7	REP 621 001/0	0 ohm 0201 0.05W 0.5A/RESISTOR
R11TX3A9	REG 724 6341/29B	2.9nH ±0.1nH 0402 0.75A/INDUCTOR
R11TX3A9	REG 724 5181/29PB	2.9nH +/-0.1nH 0201/INDUCTOR
R11TX4A9	REG 724 6341/29B	2.9nH ±0.1nH 0402 0.75A/INDUCTOR
R11TX4A9	REG 724 5181/29PB	2.9nH +/-0.1nH 0201/INDUCTOR
R13TX3A9	REP 622 001/0	0ohm +50mohm 0402 1A/RESISTOR
R13TX3A9	REP 621 001/0	0 ohm 0201 0.05W 0.5A/RESISTOR
R13TX4A9	REP 622 001/0	0ohm +50mohm 0402 1A/RESISTOR
R13TX4A9	REP 621 001/0	0 ohm 0201 0.05W 0.5A/RESISTOR
R2A7	REP 621 102/27	27ohm 1% 0201 0.05W/RESISTOR
R2A7	REP 621 001/0	0 ohm 0201 0.05W 0.5A/RESISTOR
R25TX3A9	REP 622 001/0	0ohm +50mohm 0402 1A/RESISTOR
R25TX3A9	REP 621 001/0	0 ohm 0201 0.05W 0.5A/RESISTOR
R25TX4A9	REP 622 001/0	0ohm +50mohm 0402 1A/RESISTOR
R25TX4A9	REP 621 001/0	0 ohm 0201 0.05W 0.5A/RESISTOR
R27TX3A9	REP 622 001/0	0ohm +50mohm 0402 1A/RESISTOR
R27TX3A9	REP 621 001/0	0 ohm 0201 0.05W 0.5A/RESISTOR
R27TX4A9	REP 622 001/0	0ohm +50mohm 0402 1A/RESISTOR



Replaced Parts (Red is the original part, green is the new part)		
R27TX4A9	REP 621 001/0	0 ohm 0201 0.05W 0.5A/RESISTOR
R28TX3A9	REG 724 6341/58B	5.8nH ±0.1nH 0402 0.7A/INDUCTOR
R28TX3A9	REG 724 5181/56PH	5.6nH 3% 0201/INDUCTOR
R28TX4A9	REG 724 6341/58B	5.8nH ±0.1nH 0402 0.7A/INDUCTOR
R28TX4A9	REG 724 5181/56PH	5.6nH 3% 0201/INDUCTOR
R29TX3A9	REG 724 6342/1G	10nH 2% 0402 0.5A/INDUCTOR
R29TX3A9	REG 724 5182/1PH	10nH 3% 0201/INDUCTOR
R29TX4A9	REG 724 6342/1G	10nH 2% 0402 0.5A/INDUCTOR
R29TX4A9	REG 724 5182/1PH	10nH 3% 0201/INDUCTOR
R30TX3A9	REP 622 001/0	0ohm +50mohm 0402 1A/RESISTOR
R30TX3A9	REP 621 001/0	0 ohm 0201 0.05W 0.5A/RESISTOR
R30TX4A9	REP 622 001/0	0ohm +50mohm 0402 1A/RESISTOR
R30TX4A9	REP 621 001/0	0 ohm 0201 0.05W 0.5A/RESISTOR
R34TX1A9	REP 622 001/0	0ohm +50mohm 0402 1A/RESISTOR
R34TX1A9	REP 621 001/0	0 ohm 0201 0.05W 0.5A/RESISTOR
R34TX2A9	REP 622 001/0	0ohm +50mohm 0402 1A/RESISTOR
R34TX2A9	REP 621 001/0	0 ohm 0201 0.05W 0.5A/RESISTOR
R53A7	REP 621 102/27	27ohm 1% 0201 0.05W/RESISTOR
R53A7	REP 621 001/0	0 ohm 0201 0.05W 0.5A/RESISTOR
R66A7	RJC 545 4012/22C	22pF +/-5% 0201 6.3V HQ C0G/CAPACITOR
R66A7	RJC 545 1011/51C	5.1pF +/-0.1pF 0201 25V HQ C0G/CAPACITOR
R74A7	REP 621 105/91	91Kohm 1% 0201 0.05W/RESISTOR
R74A7	REG 724 5181/62PH	6.2nH 3% 0201/INDUCTOR
R83A7	REP 621 102/27	27ohm 1% 0201 0.05W/RESISTOR
R83A7	REP 621 001/0	0 ohm 0201 0.05W 0.5A/RESISTOR
R93A7	RJC 545 4012/22C	22pF +/-5% 0201 6.3V HQ C0G/CAPACITOR
R93A7	REG 724 5181/3PB	3.0nH +/-0.1nH 0201/INDUCTOR
R96A7	REP 621 105/91	91Kohm 1% 0201 0.05W/RESISTOR
R96A7	RJC 545 1010/8C	0.8pF +/-0.1pF 0201 25V HQ C0G/CAPACITOR

“



2.6 Inventory of the EUT and support equipments

The following tables identifies the inventory of the EUT.

Table 12: Inventory of the EUT (RE & CE tests)

Equipment Role	Product Name	Product Number	Release	Product Serial#
EUT	LPRU 4420 B25B66	KRC 161 906/1	R1A ¹	TD3F999994
AC power cable	Generic, 14AWG, C14 plug, 2m	-	-	-
Optical Fiber	LC, SM, 20m	-	-	-
RF Adaptor	2.2-5 to SMA Adaptor	-	-	-
RF Cable	N-type, 10m	-	-	-
RF Cable	SMA, 2m	-	-	-
Ext Alarm Cable	Custom, 4w, 5m	-	-	-
TEST SET	CT-10, DU-SIM	-	-	-
Software info				
IRU load: CXP9013268%25_R84EF				
Table Notes				
1. EUT (release R1A) was modified prior to testing. See customer provided modification detail in section 2.5 .				



3. Detailed test results of Emissions

Emissions from systems manifest themselves in two forms: conducted emissions on cables and radiated emissions from the entire system (i.e. electronic modules, hardware, and cables). Regulatory standards restrict these different forms of emissions generated by the system.

The temperature and humidity in the test facilities are controlled. The temperature is maintained between 20 °C and 25 °C, with a relative humidity between 30 % and 60 %. Levels are recorded and any exceptions are included in the detailed test results sections of this report.

3.1 Measurement instrumentation

The measurement instrumentation conforms to the relevant standards in this report: ANSI C63.2, CISPR 16, CISPR 22, and CISPR 32. Calibration of the measurement instrumentation is maintained in accordance with the supplier's recommendations, or as necessary to ensure its accuracy.

3.2 Radiated Emissions, E-field

This test verifies that the EUT does not produce excess amounts of E-field Radiated Emissions (RE) that could interfere with licensed radiators.

3.2.1 Test specification and limits

The testing requirements are as follows.

Table 13: RE test requirements

Requirement	Method	Country of application
FCC Part 15, Subpart B	FCC Part 15 / ANSI C63.4	USA
FCC Part 24 (Section 24.238(a))	ANSI C63.26	USA
FCC Part 27 (Section 27.53(h))	ANSI C63.26	USA
ICES 003	FCC Part 15 / ICES 003 / ANSI C63.4	Canada
RSS-Gen (Section 7.3)	FCC Part 15 / ICES 003 / ANSI C63.4	Canada
RSS-133 (Section 6.5)	ANSI C63.26	Canada
RSS- 139 (Section 6.6)	ANSI C63.26	Canada
RSS- 170 (Section 5.4 - 1 & 2)	ANSI C63.26	Canada

The limits of the RE tests are as follows.

Table 14: RE limits at 10 m for Class B of FCC Part 15, ICES 003 & RSS-Gen

Frequency range (MHz)	FCC Part 15 & ICES 003 (dB μ V/m)	Detector
30 to 88	29.5	Quasi-Peak
88 to 216	33.0	Quasi-Peak
216 to 960	35.5	Quasi-Peak
960 to 1000	43.5	Quasi-Peak
1000 to 40000	43.5 ¹	Average

Table 15: Emission limits for FCC Part 24, Part 27, RSS-133, RSS-139

Frequency range (MHz)	EIRP Limit (dBm)	Calculated EIRP Limit in dB μ V/m
30 - 40000	-13	82.2

Table 16: Emission limits for RSS-170

Frequency range (MHz)	EIRP Limit (dBm)	Calculated EIRP Limit in dB μ V/m
30 - 40000	-13	82.2
2200 – 2290	-100.6 dBW/4 kHz	48.6

3.2.2 Test procedure

Verifications of the test equipment and AFC were performed before the installation of the EUT in accordance with the quality assurance procedures documented in the EMC test procedures document. The test was performed according to the relevant procedures listed in [Table 13](#).

- The EUT was placed on the turntable inside the AFC (configured for normal operation). The system and its cables were separated from the ground plane by an insulating support 10 mm in height.
- For tests between 30 MHz and 1 GHz the receive antenna (BiLog®) was placed 3 m away from the EUT. An initial scan was performed to find emissions/frequencies requiring detailed measurement. The pre-scan was performed by rotating the system 360 degrees while recording all emissions (frequency and amplitude). This procedure was repeated for antenna heights of 1 to 4 m, as well as both polarizations of the receiving antenna.
- For tests above 1 GHz the receive antenna (horn) was placed 3 m away from the EUT. Absorbing cones were placed on the floor between the antenna and the EUT. An initial scan was performed to find emissions/frequencies requiring detailed measurement. The pre-scan was performed by rotating the system 360 degrees while recording all emissions (frequency and amplitude). This procedure was repeated for antenna heights of 1 to 4 m, as well as both polarizations of the receiving antenna.
- For tests between 18 and 40 GHz the receive horn antenna was placed at a 1 m distance from the EUT with the absorbing cones placed on the floor. An initial scan was performed to find emissions/frequencies requiring detail measurement. The pre-scan was performed on all sides of the EUT, using both polarization of the receive antenna to find any system emissions.
- For all above frequency ranges, the pre-scan peak data was compared to the limits. Peaks with less than 6 dB of margin were maximized using the proper detector: the EUT was rotated in azimuth over 360 degrees to identify the direction of maximum emission, antenna height was then varied from 1 to 4 m to obtain maximum emission level.

Figure 8: Setup of Radiated Emissions

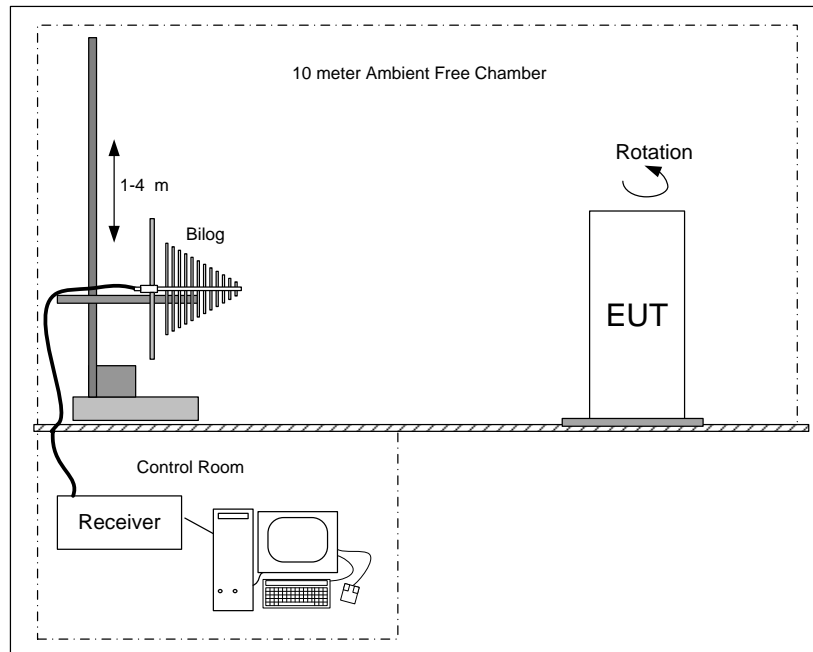

3.2.3 Calculation of the compliance margin

The following example shows the way in which the compliance margin is calculated in the “RE Test Results” tables.

The rows in these tables are defined as follows.

Meter Reading (dB μ V) = Voltage measured using the spectrum analyzer with the proper detector

Correction (dB) = Cumulative gain or loss of pre-amplifier and cables used in the measurement path (dB) + Antenna Factor (dB)

Level (dB μ V/m) = Corrected value or field strength, that is, the parameter of interest that is compared to the limit

Margin (dB) = Level with respect to the appropriate limit (a negative Margin indicates that the Level is below the limit and that the measurement is a Pass)

The values in the Level row are calculated as follows: Level = Meter Reading + Correction (dB)

The values in the Margin row are calculated as follows: Margin = Level - Limit

3.2.4 Measurement uncertainties

The expanded measurement instrumentation uncertainty with a 95 % level of confidence, calculated according to the method described in CISPR 16 is:

- ± 3.8 dB between 30 MHz and 1 GHz
- ± 4.7 dB between 1 GHz and 10 GHz
- ± 4.8 dB between 10 GHz and 18 GHz
- ± 4.6 dB between 18 GHz and 26.5 GHz
- ± 4.8 dB between 26.5 GHz and 40 GHz



3.2.5 Test results of Radiated Emissions (Single RAT/Single carrier, LTE 5M, Mid channel)

Test location: 10-meter Ambient Free Chamber (AFC)

Date tested: 7 October, 2020

Tested by: Krupal Patel

Test configurations are identified in the section [Configurations of the EUT](#).

For the following test results that have supporting data tables, negative margin values indicate a pass.

Figure 9: Plot of RE at 3 m – 30 to 1000 MHz (LTE 5M – Middle channel)

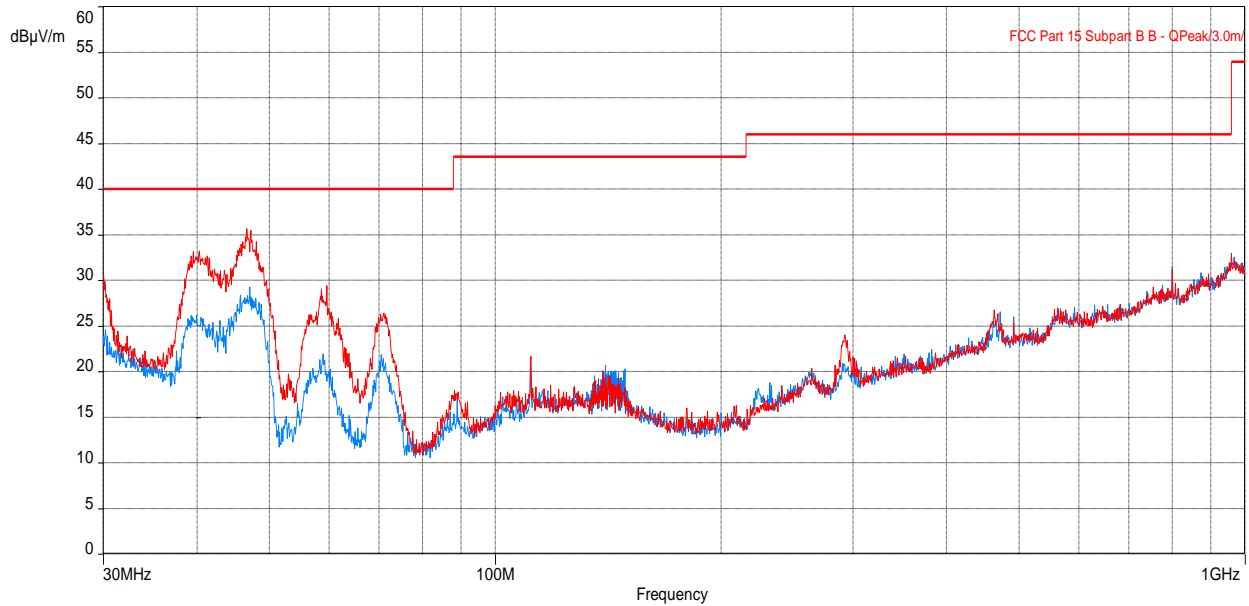

Table 17: RE test results from 30 to 1000 MHz for FCC Part 15 (LTE 5M – Middle channel)

Frequency (MHz)	Level Quasi Peak (dBµV/m)	Limit Quasi-peak (dBµV/m)	Margin to FCC part 15 Class B (dB)	Height (m)	Azimuth (deg)	Polarization	Correction (dB)
40.28408333	30.74	40.00	-9.26	1.00	278.25	Vertical	-7.65
46.62750608	33.04	40.00	-6.96	1.17	283.00	Vertical	-11.05
47.09347436	26.38	40.00	-13.62	1.98	163.25	Horizontal	-11.32
799.9944518	32.88	46.02	-13.14	1.66	304.50	Horizontal	4.29

Table 18: RE test results from 30 to 1000 MHz for FCC Part 24/27 (LTE 5M – Middle channel)

Frequency (MHz)	Level (dBµV/m)	EIRP Limit (dBµV/m)	Margin to (dB)	Height (m)	Azimuth (deg)	Polarization	Correction (dB)
40.28408333	30.74	82.2	-51.46	1.00	278.25	Vertical	-7.65
46.62750608	33.04	82.2	-49.16	1.17	283.00	Vertical	-11.05
47.09347436	26.38	82.2	-55.82	1.98	163.25	Horizontal	-11.32
799.9944518	32.88	82.2	-49.32	1.66	304.50	Horizontal	4.29

Note: In the table/Plot above, no emissions exceed the Part 24/Part 27 radiated spurious emissions limit when converted to dBuV/m. For final spurious emissions measurements to FCC Part 24/Part 27, see antenna port conducted emissions in applicable test report.

Figure 10: Plot of RE at 3m from 1 to 3 GHz (LTE 5M – Middle channel)

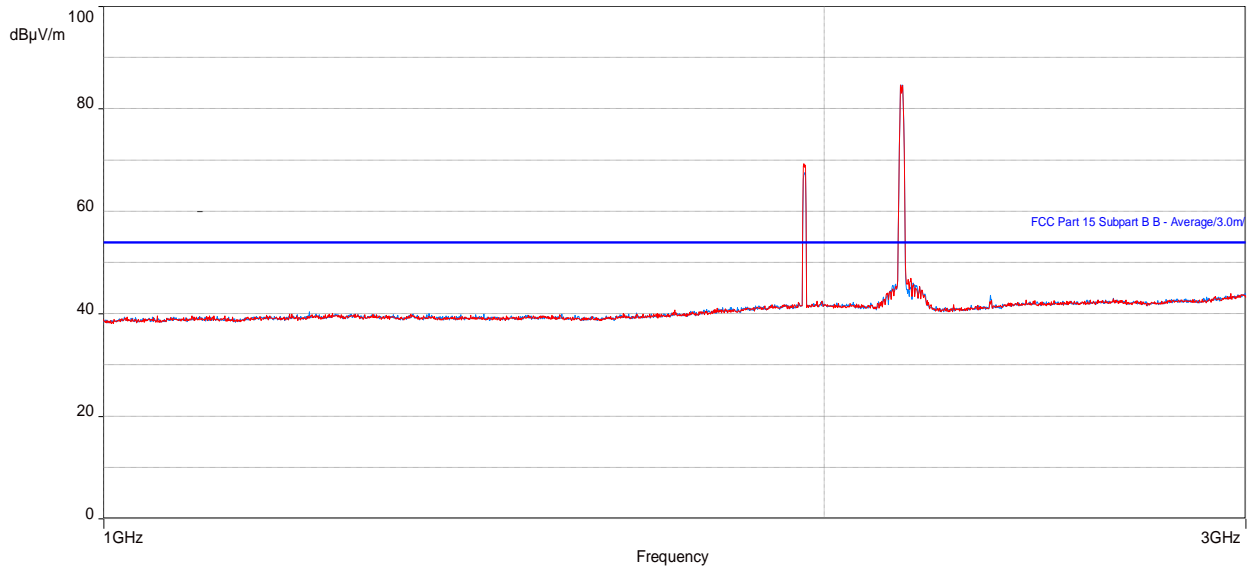

Note: Peaks above the limit are leakage of the EUT’s fundamentals from the 50-ohm terminations.

Table 19: RE test results from 1 to 3 GHz for FCC Part 15 (LTE 5M – Middle channel)

Frequency (MHz)	Level Average (dBµV/m)	Limit Average (dBµV/m)	Margin to FCC part 15 Class B (dB)	Height (m)	Azimuth (degrees)	Polarization	Correction (dB)
2179.142308	39.19	53.96	-14.77	1.00	4.00	Horizontal	4.30
2179.1417	39.16	53.96	-14.80	4.00	0.00	Vertical	4.30
2346.538815	40.35	53.96	-13.61	4.00	75.75	Horizontal	4.38

Table 20: RE test results from 1 to 3 GHz for Part 24/27 (LTE 5M – Middle channel)

Frequency (MHz)	Level (dBµV/m)	EIRP Limit (dBµV/m)	Margin to (dB)	Height (m)	Azimuth (degrees)	Polarization	Correction (dB)
2179.142308	39.19	82.2	-43.01	1.00	4.00	Horizontal	4.30
2179.1417	39.16	82.2	-43.04	4.00	0.00	Vertical	4.30
2346.538815	40.35	82.2	-41.85	4.00	75.75	Horizontal	4.38

Note: In the table/Plot above, no emissions exceed the Part 24/Part 27 radiated spurious emissions limit when converted to dBuV/m, except for the fundamentals. For final spurious emissions measurements to FCC Part 24/Part 27, see antenna port conducted emissions in applicable test report.

Figure 11: Plot of RE at 3m from 3 to 10 GHz (LTE 5M – Middle channel)

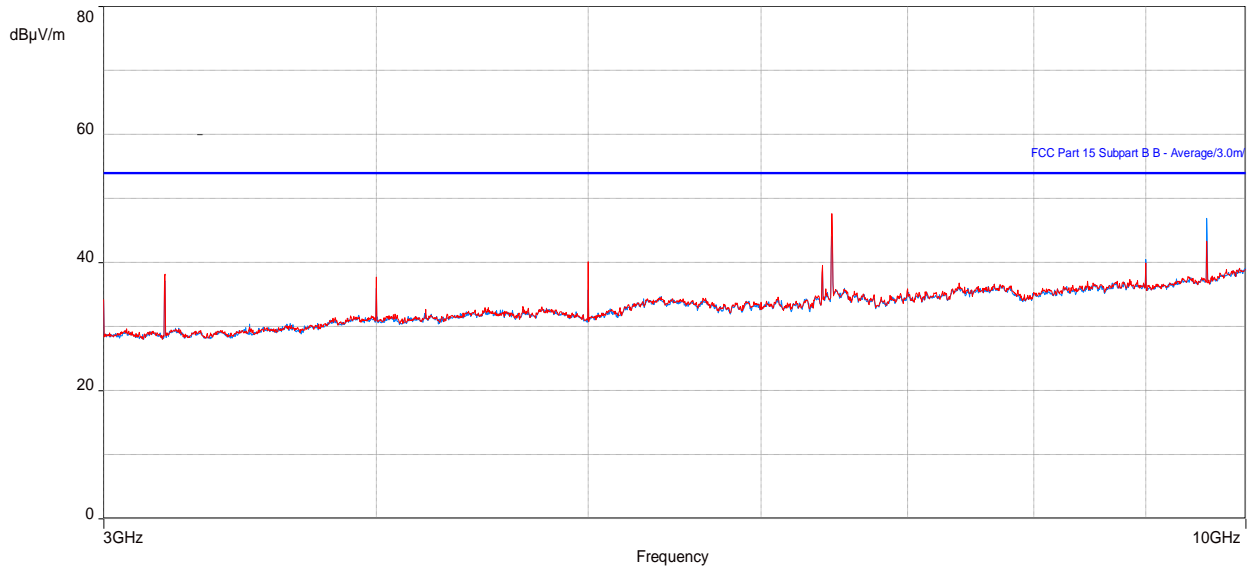

Table 21: RE test results from 3 to 10 GHz for FCC Part 15 (LTE 5M – Middle channel)

Frequency (MHz)	Level Average (dBµV/m)	Limit Average (dBµV/m)	Margin to FCC part 15 Class B (dB)	Height (m)	Azimuth (degrees)	Polarization	Correction (dB)
6465.004808	30.98	53.96	-22.98	4.00	362.00	Vertical	0.33
9599.93529	43.11	53.96	-10.85	4.00	333.50	Vertical	5.81
6466.5708	31.20	53.96	-22.76	2.56	68.75	Horizontal	0.37
9599.93529	48.30	53.96	-5.66	3.96	18.00	Horizontal	5.81

Table 22: RE test results from 3 to 10 GHz for Part 24/27 (LTE 5M – Middle channel)

Frequency (MHz)	Level (dBµV/m)	EIRP Limit (dBµV/m)	Margin to (dB)	Height (m)	Azimuth (degrees)	Polarization	Correction (dB)
6465.004808	30.98	82.2	-51.22	4.00	362.00	Vertical	0.33
9599.93529	43.11	82.2	-39.09	4.00	333.50	Vertical	5.81
6466.5708	31.20	82.2	-51.0	2.56	68.75	Horizontal	0.37
9599.93529	48.30	82.2	-33.9	3.96	18.00	Horizontal	5.81

Note: In the table/Plot above, no emissions exceed the Part 24/Part 27 radiated spurious emissions limit when converted to dBuV/m. For final spurious emissions measurements to FCC Part 24/Part 27, see antenna port conducted emissions in applicable test report.

Figure 12: Plot of RE at 3m from 10 to 18 GHz (LTE 5M – Middle channel)

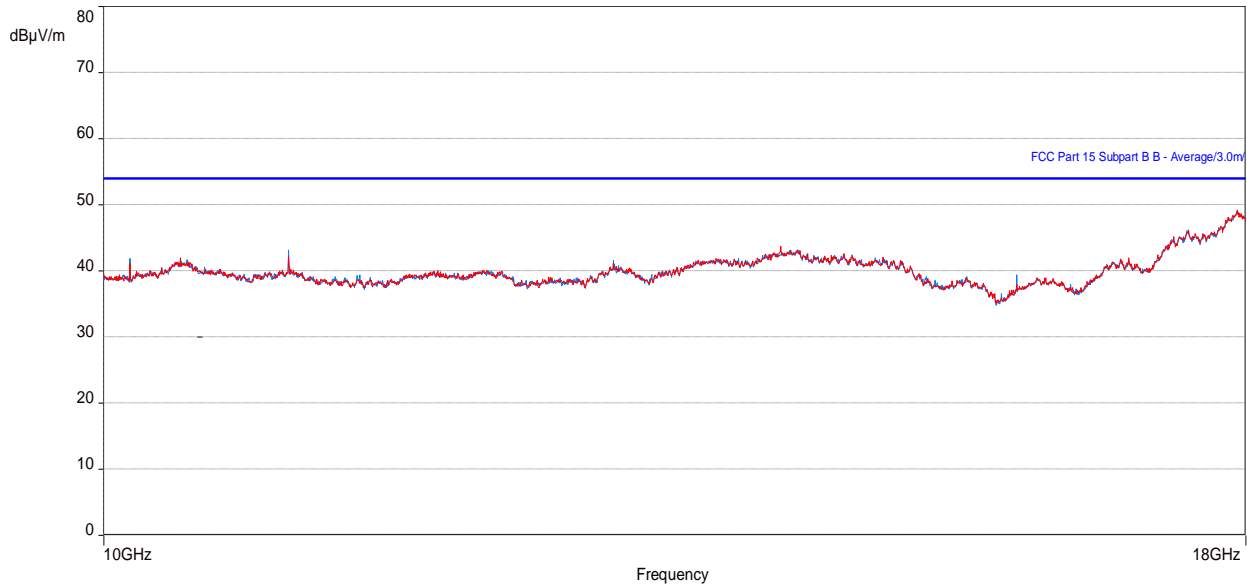

Table 23: RE test results from 10 to 18 GHz for FCC Part 15 (LTE 5M – Middle channel)

Frequency (MHz)	Level Average (dBµV/m)	Limit Average (dBµV/m)	Margin to FCC part 15 Class B (dB)	Height (m)	Azimuth (degrees)	Polarization	Correction (dB)
10999.92531	40.95	53.96	-13.01	1.00	33.50	Horizontal	8.52
10999.92628	41.66	53.96	-12.30	2.97	326.50	Vertical	8.52
14168.76474	39.63	53.96	-14.33	1.00	-2.00	Vertical	12.80
14289.96476	39.71	53.96	-14.25	1.00	75.75	Horizontal	13.10

Table 24: RE test results from 10 to 18 GHz for Part 24/27 (LTE 5M – Middle channel)

Frequency (MHz)	Level (dBµV/m)	EIRP Limit (dBµV/m)	Margin to (dB)	Height (m)	Azimuth (degrees)	Polarization	Correction (dB)
10999.92531	40.95	82.2	-41.25	1.00	33.50	Horizontal	8.52
10999.92628	41.66	82.2	-40.54	2.97	326.50	Vertical	8.52
14168.76474	39.63	82.2	-42.57	1.00	-2.00	Vertical	12.80
14289.96476	39.71	82.2	-42.49	1.00	75.75	Horizontal	13.10

Note: In the table/Plot above, no emissions exceed the Part 24/Part 27 radiated spurious emissions limit when converted to dBuV/m. For final spurious emissions measurements to FCC Part 24/Part 27, see antenna port conducted emissions in applicable test report.

Figure 13: Plot of RE at 1m from 18 to 26.5 GHz (LTE 5M – Middle channel)

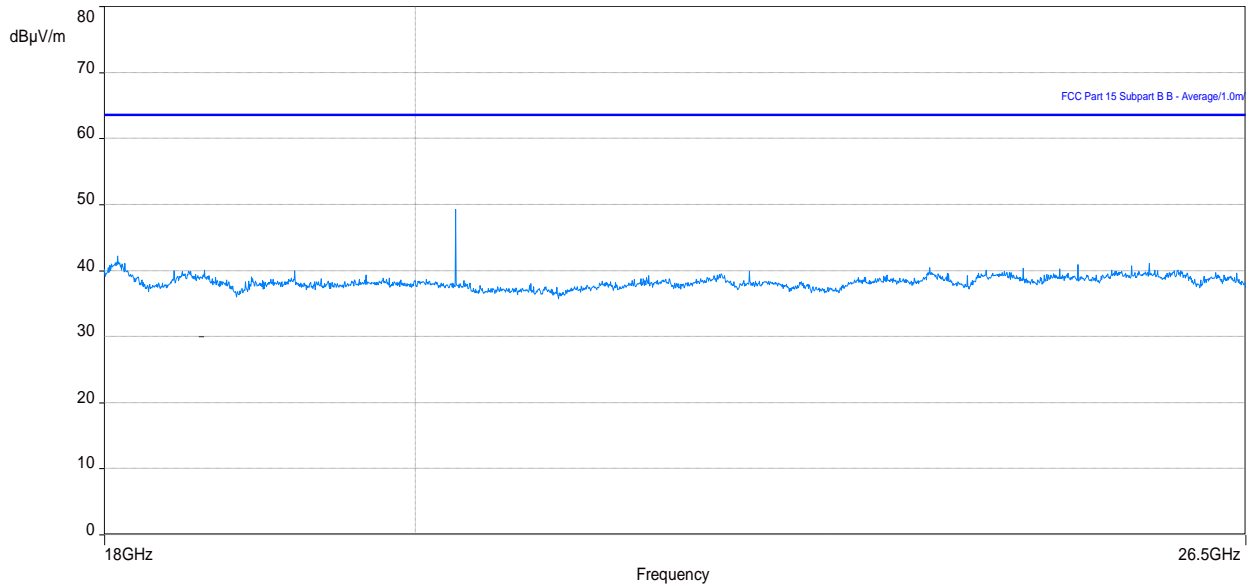

Note 1: In the plot above No Emissions exceeds the FCC Part 15/ICES 003 limit.

Note 2: In the plot above, no emissions exceed the Part 24/27 radiated spurious emissions limit when converted to dBuV/m. For final spurious emissions measurements to FCC Part 24/27, see antenna port conducted emissions in applicable test report.



3.2.6 Test results of Radiated Emissions (Single RAT/Single carrier, NR 10M, Bot channel)

Test location: 10-meter Ambient Free Chamber (AFC)

Date tested: 8 October, 2020

Tested by: Krupal Patel

Test configurations are identified in the section [Configurations of the EUT](#).

For the following test results that have supporting data tables, negative margin values indicate a pass.

Figure 14: Plot of RE at 3 m – 30 to 1000 MHz (NR 10M – Bot channel)

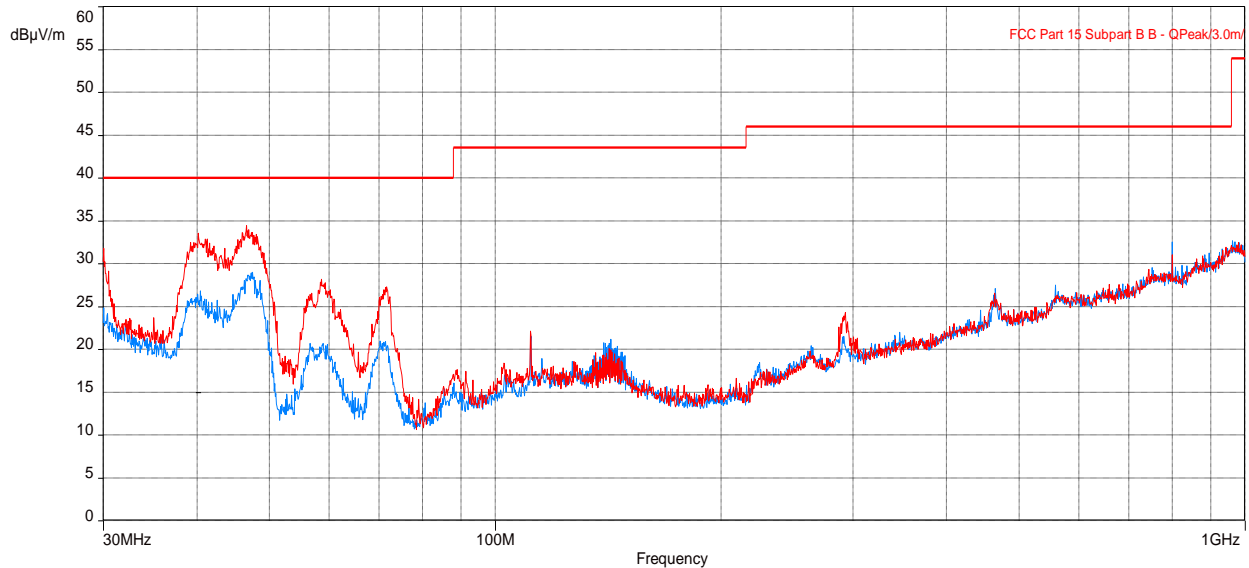

Table 25: RE test results from 30 to 1000 MHz for FCC Part 15 (NR 10M – Bot channel)

Frequency (MHz)	Level Quasi Peak (dBµV/m)	Limit Quasi-peak (dBµV/m)	Margin to FCC part 15 Class B (dB)	Height (m)	Azimuth (deg)	Polarization	Correction (dB)
40.25559649	30.83	40.00	-9.17	1.00	284.00	Vertical	-7.64
46.53623751	33.04	40.00	-6.96	1.20	284.00	Vertical	-11.00
58.69761572	26.23	40.00	-13.77	2.05	4.75	Vertical	-15.31
799.9944518	32.97	46.02	-13.05	1.83	305.75	Horizontal	4.29

Table 26: RE test results from 30 to 1000 MHz for FCC Part 24/27 (NR 10M – Bot channel)

Frequency (MHz)	Level (dBµV/m)	EIRP Limit (dBµV/m)	Margin to (dB)	Height (m)	Azimuth (deg)	Polarization	Correction (dB)
40.25559649	30.83	82.2	-51.37	1.00	284.00	Vertical	-7.64
46.53623751	33.04	82.2	-49.16	1.20	284.00	Vertical	-11.00
58.69761572	26.23	82.2	-55.97	2.05	4.75	Vertical	-15.31
799.9944518	32.97	82.2	-49.23	1.83	305.75	Horizontal	4.29

Note: In the table/Plot above, no emissions exceed the Part 24/Part 27 radiated spurious emissions limit when converted to dBuV/m. For final spurious emissions measurements to FCC Part 24/Part 27, see antenna port conducted emissions in applicable test report.

Figure 15: Plot of RE at 3m from 1 to 3 GHz (NR 10M – Bot channel)

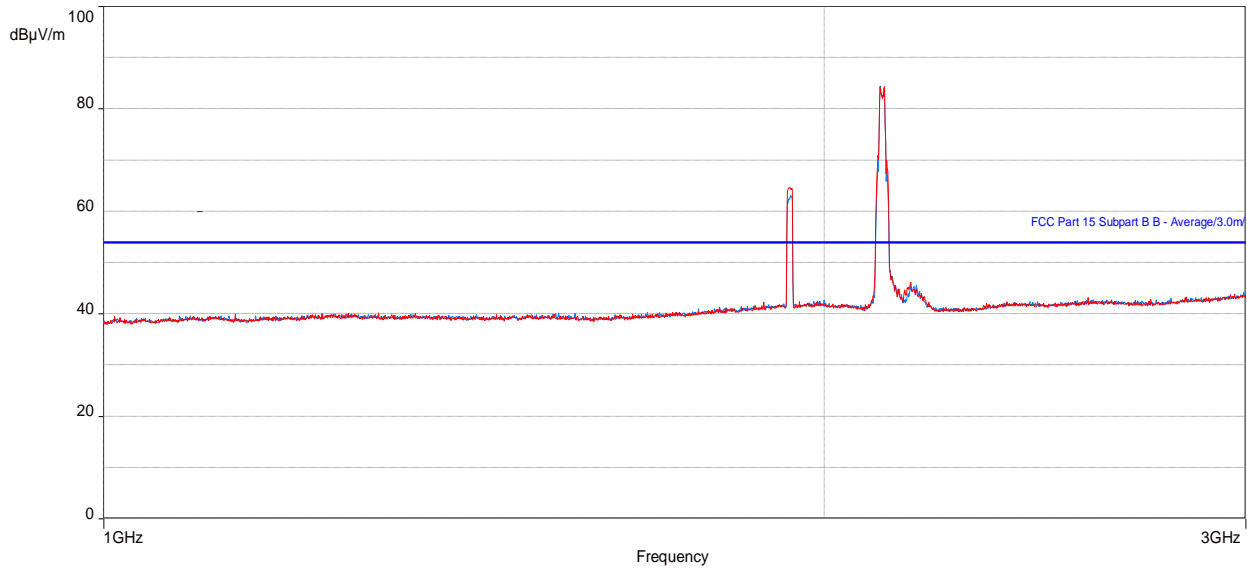

Note: Peaks above the limit are leakage of the EUT’s fundamentals from the 50-ohm terminations.

Table 27: RE test results from 1 to 3 GHz for FCC Part 15 (NR 10M – Bot channel)

Frequency (MHz)	Level Average (dBµV/m)	Limit Average (dBµV/m)	Margin to FCC part 15 Class B (dB)	Height (m)	Azimuth (degrees)	Polarization	Correction (dB)
2174.082018	43.70	53.96	-10.26	4.00	61.50	Vertical	4.31
2180.81471	43.17	53.96	-10.79	4.00	75.75	Horizontal	4.30
2975.470833	39.86	53.96	-14.10	1.00	117.50	Horizontal	6.44

Table 28: RE test results from 1 to 3 GHz for Part 24/27 (NR 10M – Bot channel)

Frequency (MHz)	Level (dBµV/m)	EIRP Limit (dBµV/m)	Margin to (dB)	Height (m)	Azimuth (degrees)	Polarization	Correction (dB)
2174.082018	43.70	82.2	-38.5	4.00	61.50	Vertical	4.31
2180.81471	43.17	82.2	-39.03	4.00	75.75	Horizontal	4.30
2975.470833	39.86	82.2	-42.34	1.00	117.50	Horizontal	6.44

Note: In the table/Plot above, no emissions exceed the Part 24/Part 27 radiated spurious emissions limit when converted to dBuV/m, except for the fundamentals. For final spurious emissions measurements to FCC Part 24/Part 27, see antenna port conducted emissions in applicable test report.

Figure 16: Plot of RE at 3m from 3 to 10 GHz (NR 10M – Bot channel)

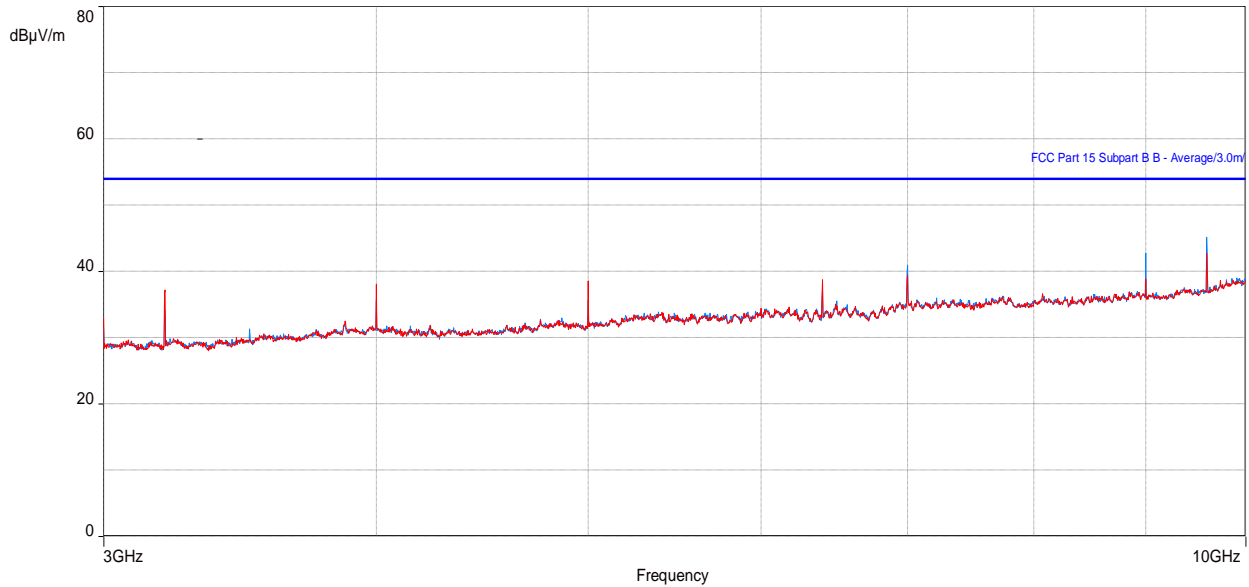

Table 29: RE test results from 3 to 10 GHz for FCC Part 15 (NR 10M – Bot channel)

Frequency (MHz)	Level Average (dBµV/m)	Limit Average (dBµV/m)	Margin to FCC part 15 Class B (dB)	Height (m)	Azimuth (degrees)	Polarization	Correction (dB)
4999.965705	36.61	53.96	-17.35	1.80	-2.00	Vertical	-2.30
8999.93971	41.41	53.96	-12.55	2.28	342.00	Horizontal	4.29
9599.93529	45.36	53.96	-8.60	3.95	18.25	Horizontal	5.81
9599.93529	40.92	53.96	-13.04	1.00	335.00	Vertical	5.81

Table 30: RE test results from 3 to 10 GHz for Part 24/27 (NR 10M – Bot channel)

Frequency (MHz)	Level (dBµV/m)	EIRP Limit (dBµV/m)	Margin to (dB)	Height (m)	Azimuth (degrees)	Polarization	Correction (dB)
4999.965705	36.61	53.96	-17.35	1.80	-2.00	Vertical	-2.30
8999.93971	41.41	53.96	-12.55	2.28	342.00	Horizontal	4.29
9599.93529	45.36	53.96	-8.60	3.95	18.25	Horizontal	5.81
9599.93529	40.92	53.96	-13.04	1.00	335.00	Vertical	5.81

Note: In the table/Plot above, no emissions exceed the Part 24/Part 27 radiated spurious emissions limit when converted to dBuV/m. For final spurious emissions measurements to FCC Part 24/Part 27, see antenna port conducted emissions in applicable test report.

Figure 17: Plot of RE at 3m from 10 to 18 GHz (NR 10M – Bot channel)

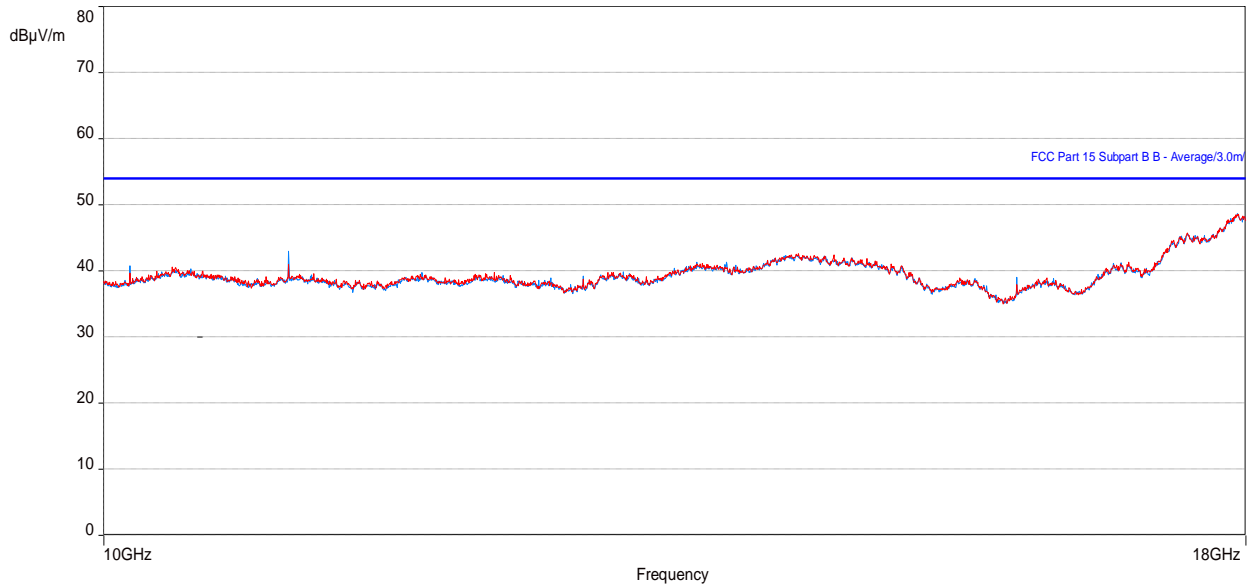

Table 31: RE test results from 10 to 18 GHz for FCC Part 15 (NR 10M – Bot channel)

Frequency (MHz)	Level Average (dBµV/m)	Limit Average (dBµV/m)	Margin to FCC part 15 Class B (dB)	Height (m)	Azimuth (degrees)	Polarization	Correction (dB)
10999.92531	40.49	53.96	-13.47	1.87	40.75	Horizontal	8.52
10999.92531	39.03	53.96	-14.93	1.00	10.00	Vertical	8.52
14293.45322	39.02	53.96	-14.94	4.00	2.50	Horizontal	13.09
14300.75896	39.12	53.96	-14.84	4.00	357.50	Vertical	13.06

Table 32: RE test results from 10 to 18 GHz for Part 24/27 (NR 10M – Bot channel)

Frequency (MHz)	Level (dBµV/m)	EIRP Limit (dBµV/m)	Margin to (dB)	Height (m)	Azimuth (degrees)	Polarization	Correction (dB)
10999.92531	40.49	82.2	-41.71	1.87	40.75	Horizontal	8.52
10999.92531	39.03	82.2	-43.17	1.00	10.00	Vertical	8.52
14293.45322	39.02	82.2	-43.18	4.00	2.50	Horizontal	13.09
14300.75896	39.12	82.2	-43.08	4.00	357.50	Vertical	13.06

Note: In the table/Plot above, no emissions exceed the Part 24/Part 27 radiated spurious emissions limit when converted to dBuV/m. For final spurious emissions measurements to FCC Part 24/Part 27, see antenna port conducted emissions in applicable test report.

Figure 18: Plot of RE at 1m from 18 to 26.5 GHz (NR 10M – Bot channel)

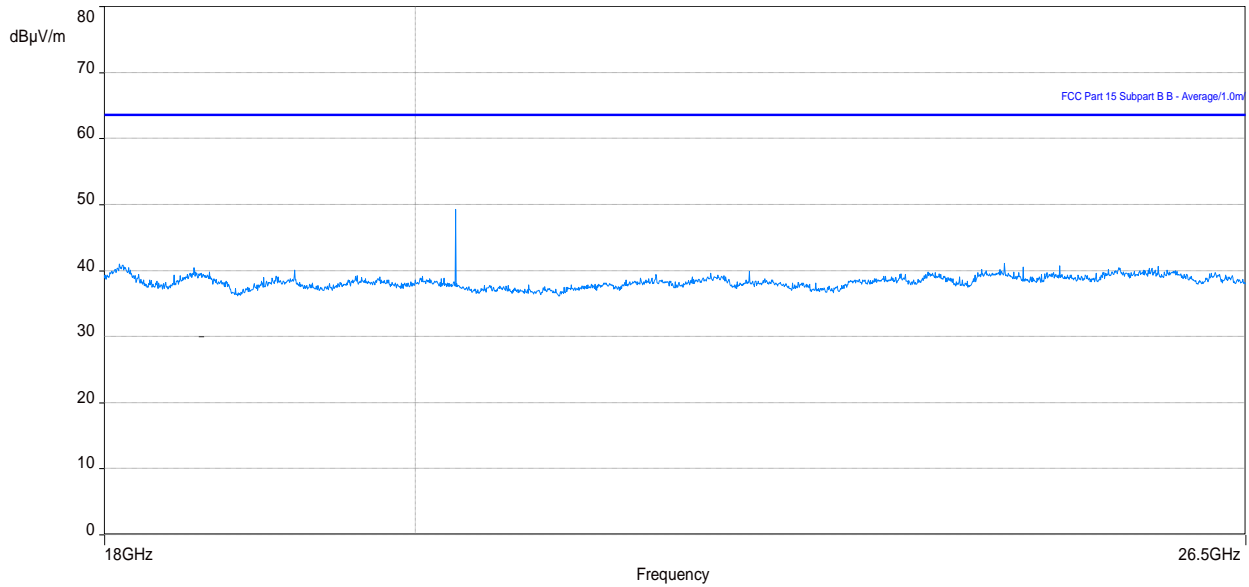

Note 1: In the plot above No Emissions exceeds the FCC Part 15/ICES 003 limit.

Note 2: In the plot above, no emissions exceed the Part 24/27 radiated spurious emissions limit when converted to dBuV/m. For final spurious emissions measurements to FCC Part 24/27, see antenna port conducted emissions in applicable test report.



3.2.7 Test results of Radiated Emissions (Single RAT/single carrier, NR 10M, Mid channel)

Test location: 10-meter Ambient Free Chamber (AFC)

Date tested: 8 October, 2020

Tested by: Krupal Patel

Test configurations are identified in the section [Configurations of the EUT](#).

For the following test results that have supporting data tables, negative margin values indicate a pass.

Figure 19: Plot of RE at 3 m – 30 to 1000 MHz (NR 10M – Mid channel)

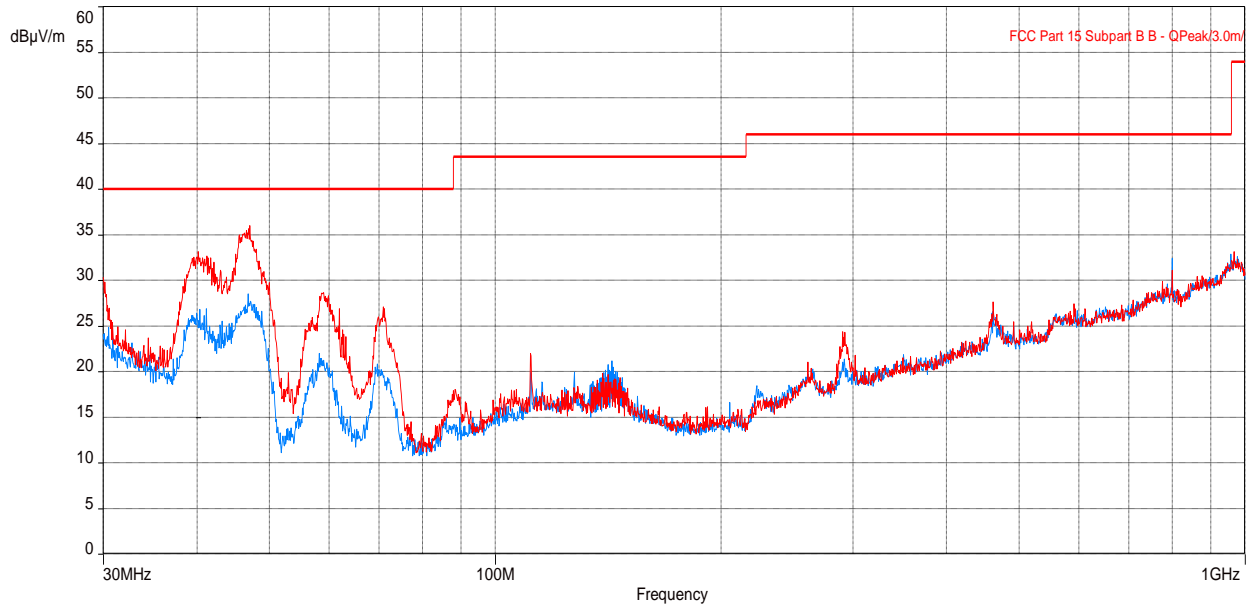

Table 33: RE test results from 30 to 1000 MHz for FCC Part 15 (NR 10M – Mid channel)

Frequency (MHz)	Level Quasi Peak (dBµV/m)	Limit Quasi-peak (dBµV/m)	Margin to FCC part 15 Class B (dB)	Height (m)	Azimuth (deg)	Polarization	Correction (dB)
40.17253879	30.81	40.00	-9.19	1.00	283.00	Vertical	-7.59
47.06258367	32.67	40.00	-7.33	1.23	283.00	Vertical	-11.30
59.05873044	26.27	40.00	-13.73	2.10	24.00	Vertical	-15.34
799.9946121	33.02	46.02	-13.00	1.67	304.75	Horizontal	4.29

Table 34: RE test results from 30 to 1000 MHz for FCC Part 24/27 (NR 10M – Mid channel)

Frequency (MHz)	Level (dBµV/m)	EIRP Limit (dBµV/m)	Margin to (dB)	Height (m)	Azimuth (deg)	Polarization	Correction (dB)
40.17253879	30.81	82.2	-51.39	1.00	283.00	Vertical	-7.59
47.06258367	32.67	82.2	-49.53	1.23	283.00	Vertical	-11.30
59.05873044	26.27	82.2	-55.93	2.10	24.00	Vertical	-15.34
799.9946121	33.02	82.2	-49.18	1.67	304.75	Horizontal	4.29

Note: In the table/Plot above, no emissions exceed the Part 24/Part 27 radiated spurious emissions limit when converted to dBuV/m. For final spurious emissions measurements to FCC Part 24/Part 27, see antenna port conducted emissions in applicable test report.

Figure 20: Plot of RE at 3m from 1 to 3 GHz (NR 10M – Mid channel)

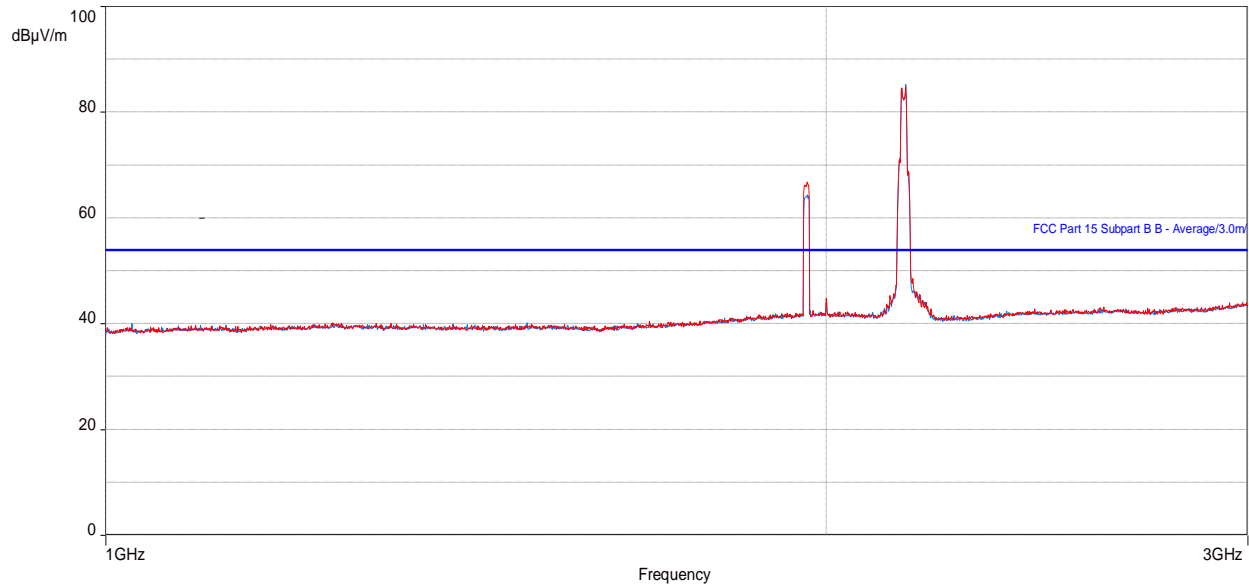

Note: Peaks above the limit are leakage of the EUT’s fundamentals from the 50-ohm terminations.

Table 35: RE test results from 1 to 3 GHz for FCC Part 15 (NR 10M – Mid channel)

Frequency (MHz)	Level Average (dBµV/m)	Limit Average (dBµV/m)	Margin to FCC part 15 Class B (dB)	Height (m)	Azimuth (degrees)	Polarization	Correction (dB)
2000.463495	41.07	53.96	-12.89	4.00	61.50	Vertical	4.55
2948.94391	39.25	53.96	-14.71	1.00	359.75	Vertical	6.11
963.254454	39.75	53.96	-14.21	3.82	359.75	Horizontal	6.29

Table 36: RE test results from 1 to 3 GHz for Part 24/27 (NR 10M – Mid channel)

Frequency (MHz)	Level (dBµV/m)	EIRP Limit (dBµV/m)	Margin to (dB)	Height (m)	Azimuth (degrees)	Polarization	Correction (dB)
2000.463495	41.07	53.96	-12.89	4.00	61.50	Vertical	4.55
2948.94391	39.25	53.96	-14.71	1.00	359.75	Vertical	6.11
2963.254454	39.75	53.96	-14.21	3.82	359.75	Horizontal	6.29

Note: In the table/Plot above, no emissions exceed the Part 24/Part 27 radiated spurious emissions limit when converted to dBuV/m, except for the fundamentals. For final spurious emissions measurements to FCC Part 24/Part 27, see antenna port conducted emissions in applicable test report.

Figure 21: Plot of RE at 3m from 3 to 10 GHz (NR 10M – Mid channel)

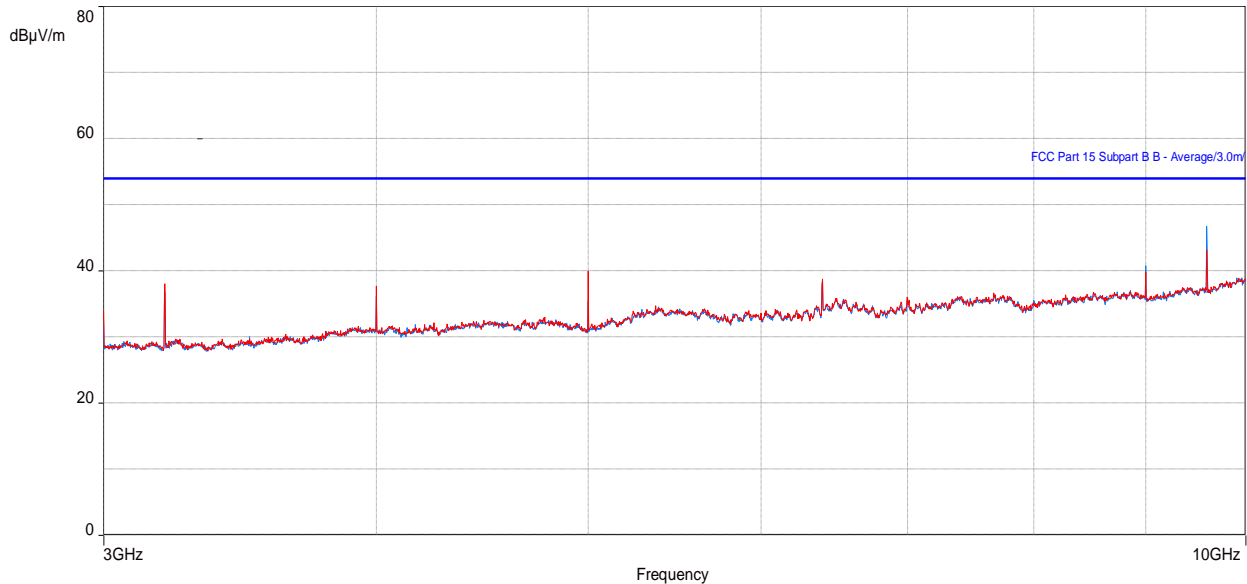

Table 37: RE test results from 3 to 10 GHz for FCC Part 15 (NR 10M – Mid channel)

Frequency (MHz)	Level Average (dBµV/m)	Limit Average (dBµV/m)	Margin to FCC part 15 Class B (dB)	Height (m)	Azimuth (degrees)	Polarization	Correction (dB)
4999.965705	40.48	53.96	-13.48	2.01	333.50	Vertical	-2.30
8999.93971	40.11	53.96	-13.85	1.94	4.25	Horizontal	4.29
9599.93529	48.27	53.96	-5.69	3.11	11.00	Horizontal	5.81
9599.93529	42.91	53.96	-11.05	4.00	334.75	Vertical	5.81

Table 38: RE test results from 3 to 10 GHz for Part 24/27 (NR 10M – Mid channel)

Frequency (MHz)	Level (dBµV/m)	EIRP Limit (dBµV/m)	Margin to (dB)	Height (m)	Azimuth (degrees)	Polarization	Correction (dB)
4999.965705	40.48	82.2	-41.72	2.01	333.50	Vertical	-2.30
8999.93971	40.11	82.2	-42.09	1.94	4.25	Horizontal	4.29
9599.93529	48.27	82.2	-33.93	3.11	11.00	Horizontal	5.81
9599.93529	42.91	82.2	-39.29	4.00	334.75	Vertical	5.81

Note: In the table/Plot above, no emissions exceed the Part 24/Part 27 radiated spurious emissions limit when converted to dBuV/m. For final spurious emissions measurements to FCC Part 24/Part 27, see antenna port conducted emissions in applicable test report.

Figure 22: Plot of RE at 3m from 10 to 18 GHz (NR 10M – Mid channel)

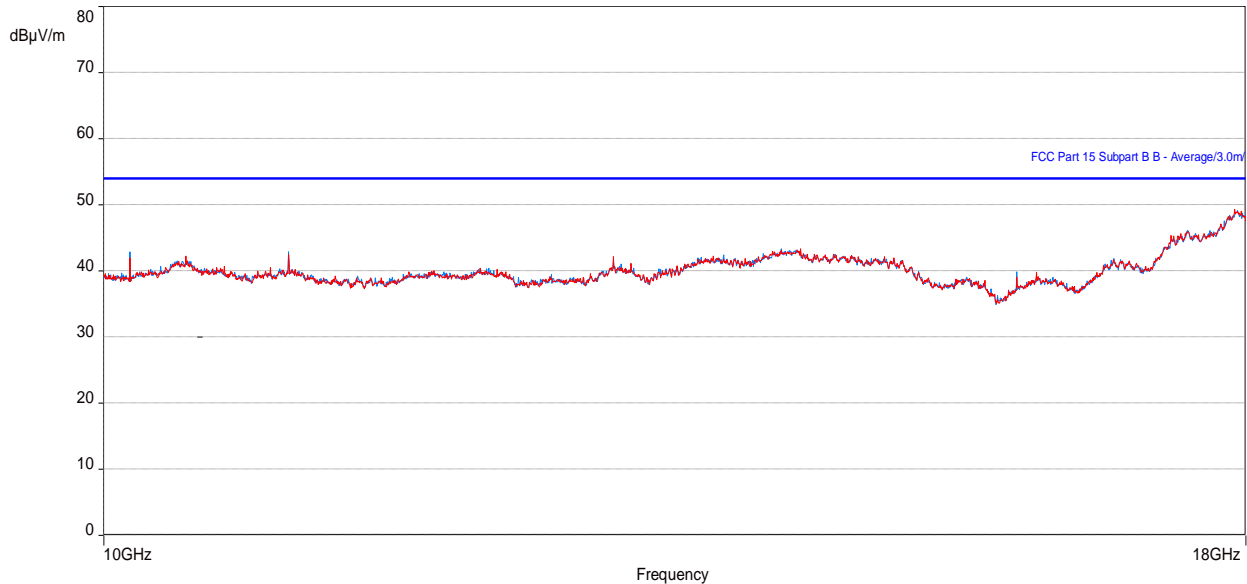

Table 39: RE test results from 10 to 18 GHz for FCC Part 15 (NR 10M – Mid channel)

Frequency (MHz)	Level Average (dBµV/m)	Limit Average (dBµV/m)	Margin to FCC part 15 Class B (dB)	Height (m)	Azimuth (degrees)	Polarization	Correction (dB)
10137.53172	40.92	53.96	-13.04	1.00	26.25	Horizontal	8.52
10999.92628	42.53	53.96	-11.43	1.87	41.00	Horizontal	8.52
10999.92691	41.36	53.96	-12.60	2.21	342.50	Vertical	8.52
14172.30704	39.88	53.96	-14.08	1.00	17.75	Horizontal	12.74

Table 40: RE test results from 10 to 18 GHz for Part 24/27 (NR 10M – Mid channel)

Frequency (MHz)	Level (dBµV/m)	EIRP Limit (dBµV/m)	Margin to (dB)	Height (m)	Azimuth (degrees)	Polarization	Correction (dB)
10137.53172	40.92	82.2	-41.28	1.00	26.25	Horizontal	8.52
10999.92628	42.53	82.2	-39.67	1.87	41.00	Horizontal	8.52
0999.92691	41.36	82.2	-40.84	2.21	342.50	Vertical	8.52
14172.30704	39.88	82.2	-42.32	1.00	17.75	Horizontal	12.74

Note: In the table/Plot above, no emissions exceed the Part 24/Part 27 radiated spurious emissions limit when converted to dBuV/m. For final spurious emissions measurements to FCC Part 24/Part 27, see antenna port conducted emissions in applicable test report.

Figure 23: Plot of RE at 1m from 18 to 26.5 GHz (NR 10M – Mid channel)

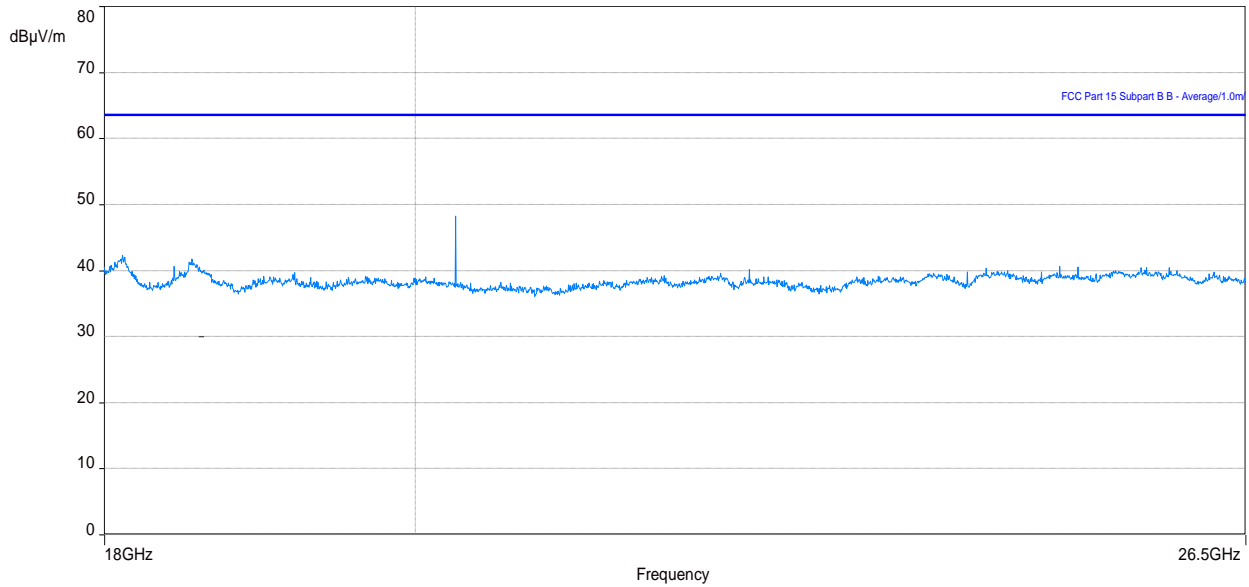

Note 1: In the plot above No Emissions exceeds the FCC Part 15/ICES 003 limit.

Note 2: In the plot above, no emissions exceed the Part 24/27 radiated spurious emissions limit when converted to dBuV/m. For final spurious emissions measurements to FCC Part 24/27, see antenna port conducted emissions in applicable test report.



3.2.8 Test results of Radiated Emissions (Single RAT/single carrier, NR 10M, Top channel)

Test location: 10-meter Ambient Free Chamber (AFC)

Date tested: 8 October, 2020

Tested by: Krupal Patel

Test configurations are identified in the section [Configurations of the EUT](#).

For the following test results that have supporting data tables, negative margin values indicate a pass.

Figure 24: Plot of RE at 3 m – 30 to1000 MHz (NR 10M – Top channel)

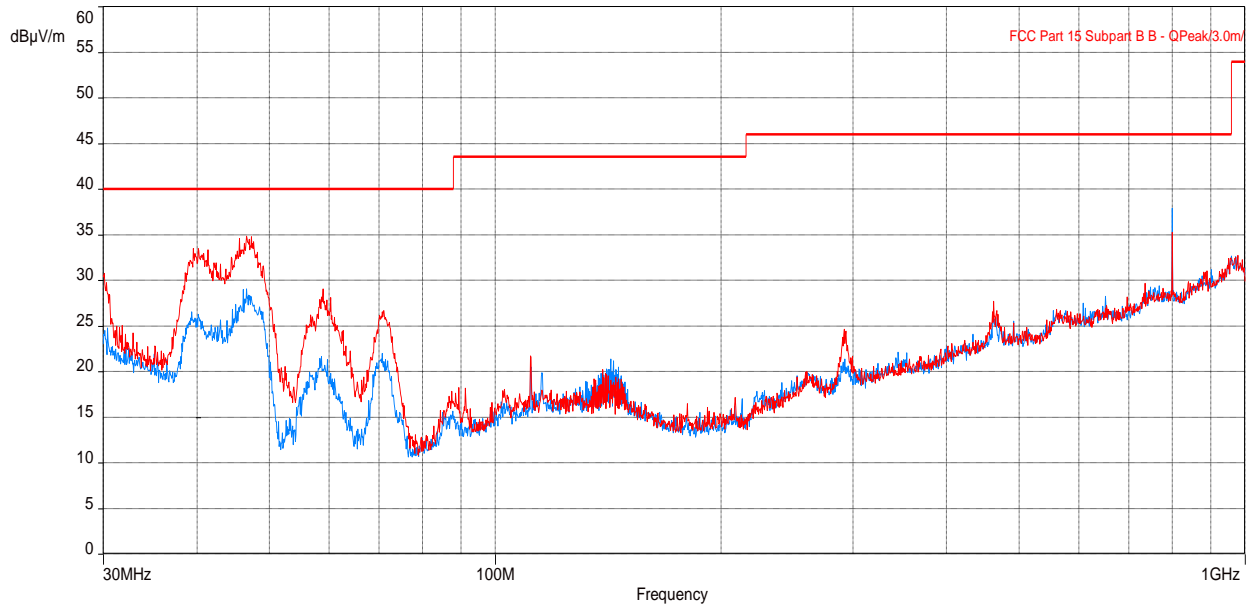

Table 41: RE test results from 30 to 1000 MHz for FCC Part 15 (NR 10M – Top channel)

Frequency (MHz)	Level Quasi Peak (dBµV/m)	Limit Quasi-peak (dBµV/m)	Margin to FCC part 15 Class B (dB)	Height (m)	Azimuth (deg)	Polarization	Correction (dB)
40.14946187	30.87	40.00	-9.13	1.00	283.00	Vertical	-7.57
46.63503813	33.12	40.00	-6.88	1.00	283.25	Vertical	-11.05
799.9946121	37.84	46.02	-8.18	1.93	305.75	Horizontal	4.29
799.9946121	35.72	46.02	-10.30	1.80	357.50	Vertical	4.29

Table 42: RE test results from 30 to 1000 MHz for FCC Part 24/27 (NR 10M – Top channel)

Frequency (MHz)	Level (dBµV/m)	EIRP Limit (dBµV/m)	Margin to (dB)	Height (m)	Azimuth (deg)	Polarization	Correction (dB)
40.14946187	30.87	82.2	-51.33	1.00	283.00	Vertical	-7.57
46.63503813	33.12	82.2	-49.08	1.00	283.25	Vertical	-11.05
799.9946121	37.84	82.2	-44.36	1.93	305.75	Horizontal	4.29
799.9946121	35.72	82.2	-46.48	1.80	357.50	Vertical	4.29

Note: In the table/Plot above, no emissions exceed the Part 24/Part 27 radiated spurious emissions limit when converted to dBuV/m. For final spurious emissions measurements to FCC Part 24/Part 27, see antenna port conducted emissions in applicable test report.

Figure 25: Plot of RE at 3m from 1 to 3 GHz (NR 10M – Top channel)

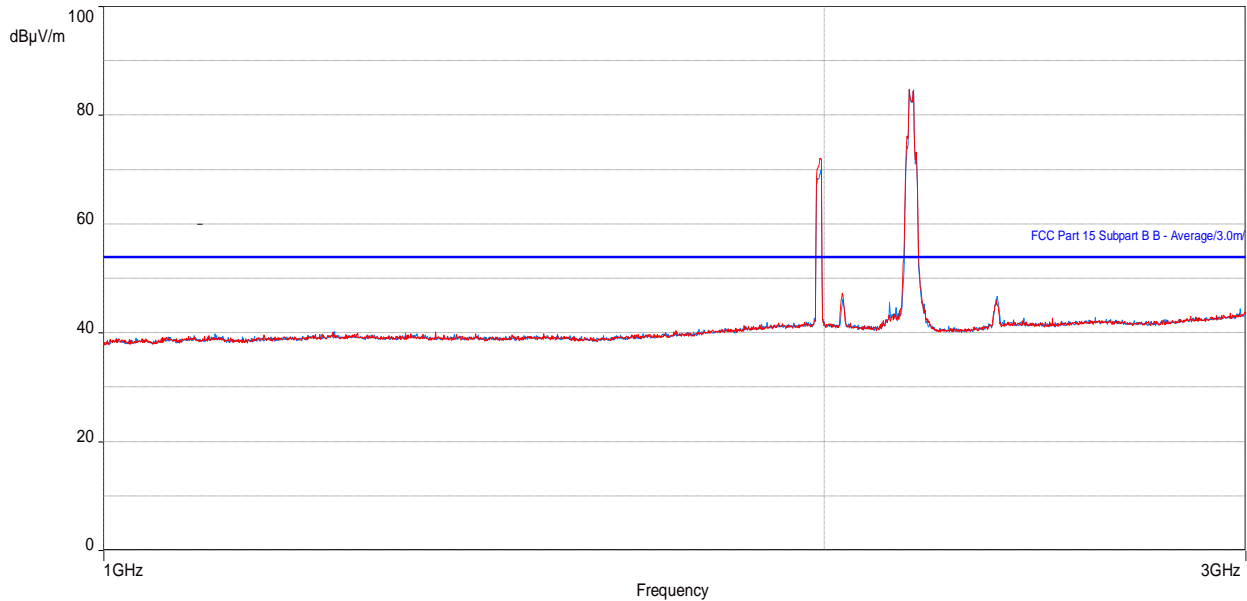

Note: Peaks above the limit are leakage of the EUT's fundamentals from the 50-ohm terminations.

Table 43: RE test results from 1 to 3 GHz for FCC Part 15 (NR 10M – Top channel)

Frequency (MHz)	Level Average (dBµV/m)	Limit Average (dBµV/m)	Margin to FCC part 15 Class B (dB)	Height (m)	Azimuth (degrees)	Polarization	Correction (dB)
2034.858687	45.01	53.96	-8.95	4.00	62.25	Vertical	4.53
2036.108654	42.88	53.96	-11.08	4.00	76.75	Horizontal	4.53
2361.94811	43.32	53.96	-10.64	4.00	76.50	Horizontal	4.50

Table 44: RE test results from 1 to 3 GHz for Part 24/27 (NR 10M – Top channel)

Frequency (MHz)	Level (dBµV/m)	EIRP Limit (dBµV/m)	Margin to (dB)	Height (m)	Azimuth (degrees)	Polarization	Correction (dB)
2034.858687	45.01	82.2	-37.19	4.00	62.25	Vertical	4.53
2036.108654	42.88	82.2	-39.32	4.00	76.75	Horizontal	4.53
2361.94811	43.32	82.2	-38.88	4.00	76.50	Horizontal	4.50

Note: In the table/Plot above, no emissions exceed the Part 24/Part 27 radiated spurious emissions limit when converted to dBuV/m, except for the fundamentals. For final spurious emissions measurements to FCC Part 24/Part 27, see antenna port conducted emissions in applicable test report.

Figure 26: Plot of RE at 3m from 3 to 10 GHz (NR 10M – Top channel)

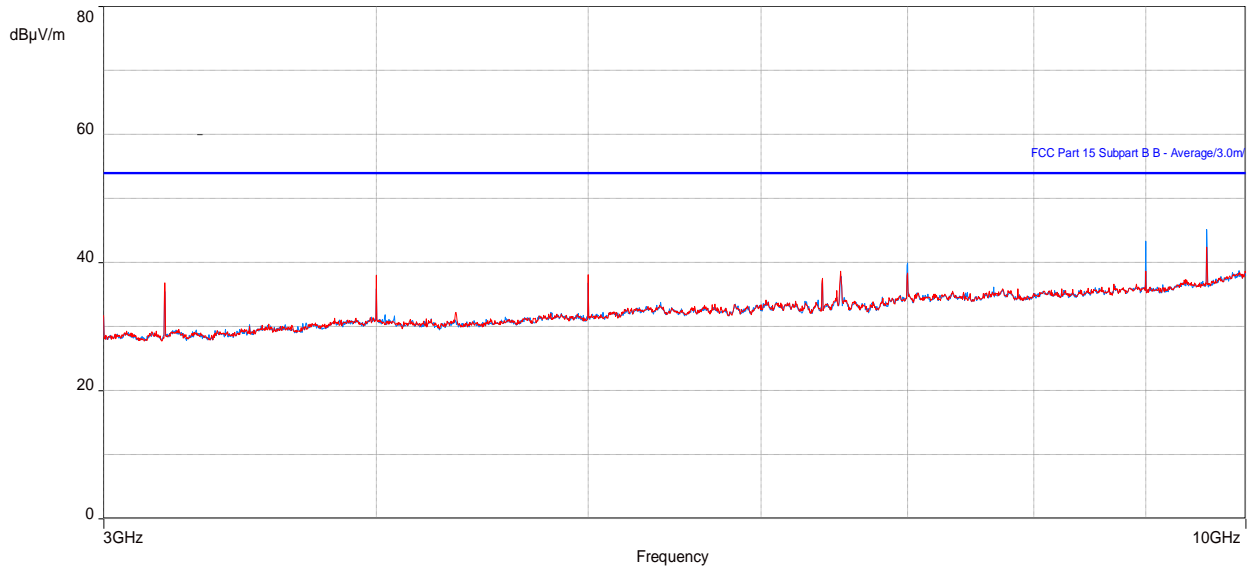

Table 45: RE test results from 3 to 10 GHz for FCC Part 15 (NR 10M – Top channel)

Frequency (MHz)	Level Average (dBµV/m)	Limit Average (dBµV/m)	Margin to FCC part 15 Class B (dB)	Height (m)	Azimuth (degrees)	Polarization	Correction (dB)
4999.966633	33.42	53.96	-20.54	1.01	12.25	Horizontal	-2.30
6526.355482	30.75	53.96	-23.21	1.00	321.50	Vertical	0.55
8999.93971	42.13	53.96	-11.83	2.28	343.00	Horizontal	4.29
9599.93529	45.61	53.96	-8.35	3.95	19.00	Horizontal	5.81

Table 46: RE test results from 3 to 10 GHz for Part 24/27 (NR 10M – Top channel)

Frequency (MHz)	Level (dBµV/m)	EIRP Limit (dBµV/m)	Margin to (dB)	Height (m)	Azimuth (degrees)	Polarization	Correction (dB)
4999.966633	33.42	82.2	-48.78	1.01	12.25	Horizontal	-2.30
6526.355482	30.75	82.2	-51.45	1.00	321.50	Vertical	0.55
8999.93971	42.13	82.2	-40.07	2.28	343.00	Horizontal	4.29
9599.93529	45.61	82.2	-36.59	3.95	19.00	Horizontal	5.81

Note: In the table/Plot above, no emissions exceed the Part 24/Part 27 radiated spurious emissions limit when converted to dBuV/m. For final spurious emissions measurements to FCC Part 24/Part 27, see antenna port conducted emissions in applicable test report.

Figure 27: Plot of RE at 3m from 3 to 10 GHz (NR 10M – Top Tx channel)

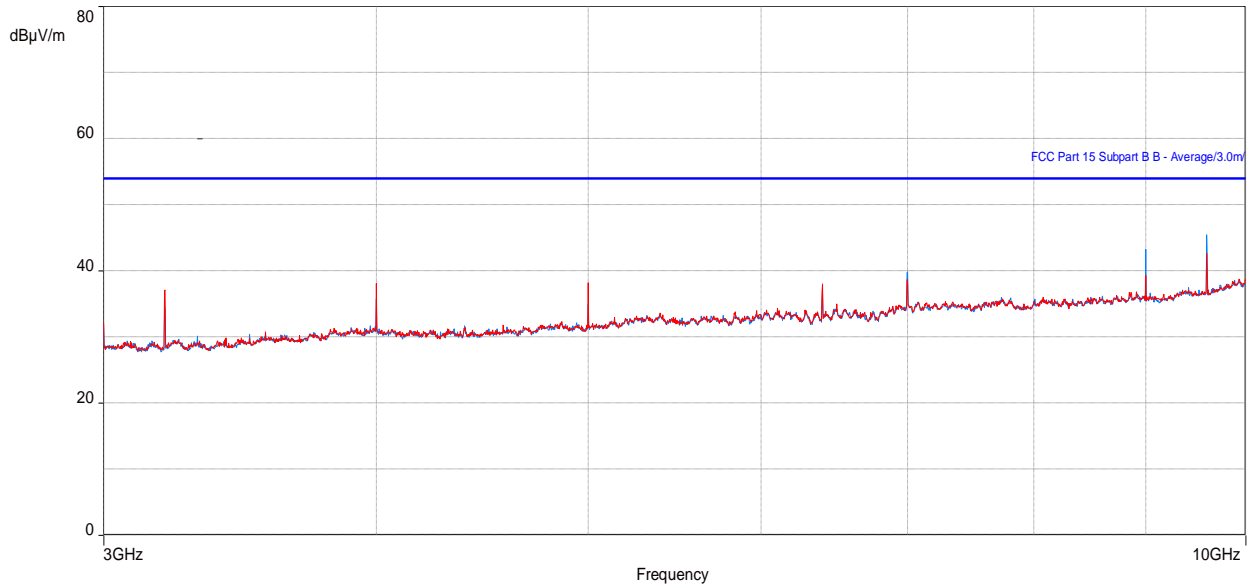

Table 47: RE test results from 3 to 10 GHz for FCC Part 15 (NR 10M – Top Tx channel)

Frequency (MHz)	Level Average (dBµV/m)	Limit Average (dBµV/m)	Margin to FCC part 15 Class B (dB)	Height (m)	Azimuth (degrees)	Polarization	Correction (dB)
3999.972723	35.01	53.96	-18.95	2.01	328.75	Horizontal	-3.74
4999.965705	36.65	53.96	-17.31	1.59	-2.00	Vertical	-2.30
8999.93971	41.56	53.96	-12.40	2.28	342.00	Horizontal	4.29
9599.93529	45.27	53.96	-8.69	3.95	18.00	Horizontal	5.81

Table 48: RE test results from 3 to 10 GHz for Part 24/27 (NR 10M – Top Tx channel)

Frequency (MHz)	Level (dBµV/m)	EIRP Limit (dBµV/m)	Margin to (dB)	Height (m)	Azimuth (degrees)	Polarization	Correction (dB)
3999.972723	35.01	82.2	-47.19	2.01	328.75	Horizontal	-3.74
4999.965705	36.65	82.2	-45.55	1.59	-2.00	Vertical	-2.30
8999.93971	41.56	82.2	-40.64	2.28	342.00	Horizontal	4.29
9599.93529	45.27	82.2	-36.93	3.95	18.00	Horizontal	5.81

Note: In the table/Plot above, no emissions exceed the Part 24/Part 27 radiated spurious emissions limit when converted to dBuV/m. For final spurious emissions measurements to FCC Part 24/Part 27, see antenna port conducted emissions in applicable test report.

Figure 28: Plot of RE at 3m from 10 to 18 GHz (NR 10M – Top channel)

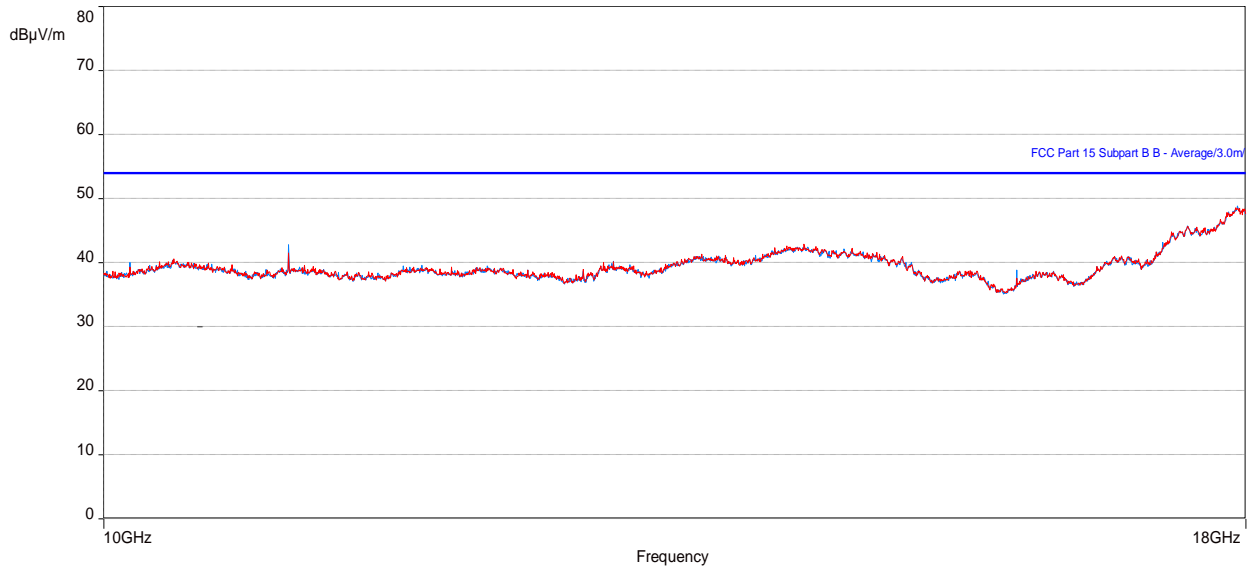

Table 49: RE test results from 10 to 18 GHz for FCC Part 15 (NR 10M – Top channel)

Frequency (MHz)	Level Average (dBµV/m)	Limit Average (dBµV/m)	Margin to FCC part 15 Class B (dB)	Height (m)	Azimuth (degrees)	Polarization	Correction (dB)
10999.92468	40.61	53.96	-13.35	1.87	40.75	Horizontal	8.52
10999.92468	39.70	53.96	-14.26	1.00	9.50	Vertical	8.52
14290.23814	39.10	53.96	-14.86	4.00	357.00	Horizontal	13.10
14338.90418	39.10	53.96	-14.86	4.00	360.00	Vertical	13.61

Table 50: RE test results from 10 to 18 GHz for Part 24/27 (NR 10M – Top channel)

Frequency (MHz)	Level (dBµV/m)	EIRP Limit (dBµV/m)	Margin to (dB)	Height (m)	Azimuth (degrees)	Polarization	Correction (dB)
10999.92468	40.61	82.2	-41.59	1.87	40.75	Horizontal	8.52
10999.92468	39.70	82.2	-42.50	1.00	9.50	Vertical	8.52
4290.23814	39.10	82.2	-43.10	4.00	357.00	Horizontal	13.10
14338.90418	39.10	82.2	-43.10	4.00	360.00	Vertical	13.61

Note: In the table/Plot above, no emissions exceed the Part 24/Part 27 radiated spurious emissions limit when converted to dBuV/m. For final spurious emissions measurements to FCC Part 24/Part 27, see antenna port conducted emissions in applicable test report.

Figure 29: Plot of RE at 1m from 18 to 26.5 GHz (NR 10M – Top channel)

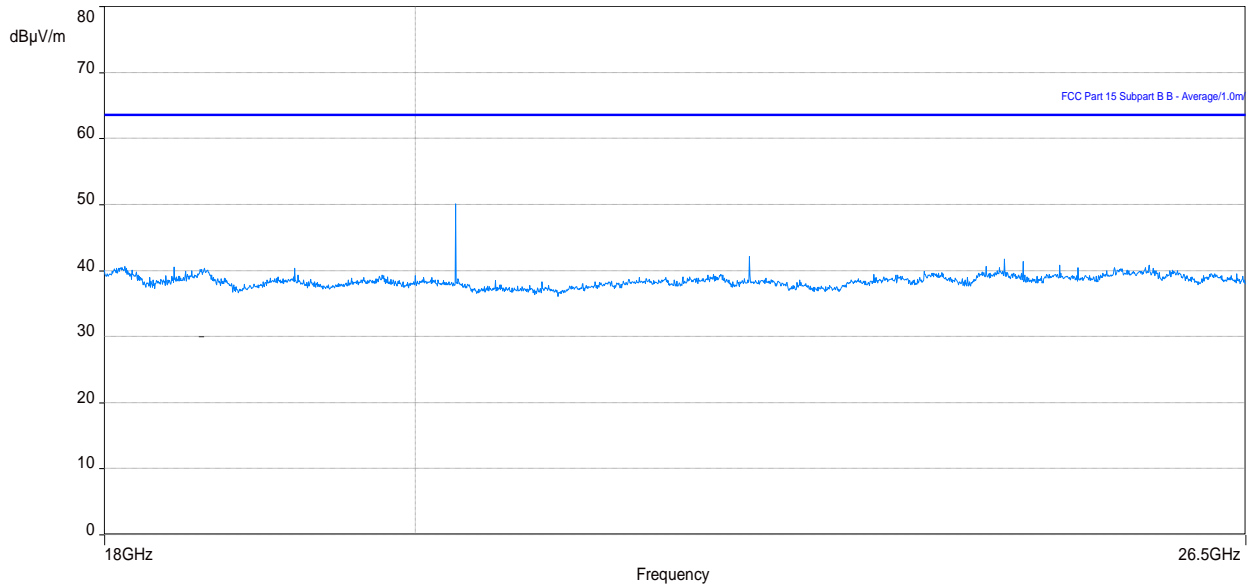

Note 1: In the plot above No Emissions exceeds the FCC Part 15/ICES 003 limit.

Note 2: In the plot above, no emissions exceed the Part 24/27 radiated spurious emissions limit when converted to dBuV/m. For final spurious emissions measurements to FCC Part 24/27, see antenna port conducted emissions in applicable test report.



3.2.9 Test results of Radiated Emissions (Single RAT/Multi carrier, 2 NR 10M, Mid channel)

Test location: 10-meter Ambient Free Chamber (AFC)

Date tested: 13 October, 2020

Tested by: Krupal Patel

Test configurations are identified in the section [Configurations of the EUT](#).

For the following test results that have supporting data tables, negative margin values indicate a pass.

Figure 30: Plot of RE at 3 m – 30 to 1000 MHz (2 * NR 10M – Mid channel)

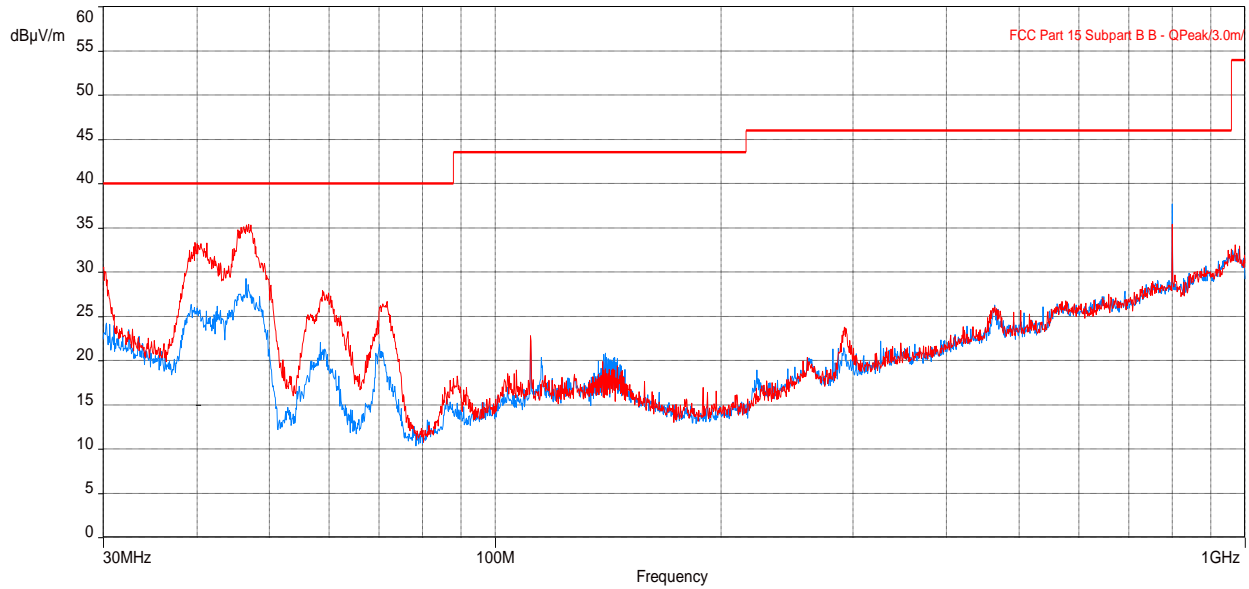

Table 51: RE test results from 30 to 1000 MHz for FCC Part 15 (2 * NR 10M – Mid channel)

Frequency (MHz)	Level Quasi Peak (dBµV/m)	Limit Quasi-peak (dBµV/m)	Margin to FCC part 15 Class B (dB)	Height (m)	Azimuth (deg)	Polarization	Correction (dB)
39.72560223	30.85	40.00	-9.15	1.00	268.50	Vertical	-7.32
46.95741059	32.88	40.00	-7.12	1.30	283.00	Vertical	-11.25
58.80339103	26.25	40.00	-13.75	2.10	0.00	Vertical	-15.32
799.9946538	38.14	46.02	-7.88	1.87	304.50	Horizontal	4.29

Table 52: RE test results from 30 to 1000 MHz for FCC Part 24/27 (2 * NR 10M – Mid channel)

Frequency (MHz)	Level (dBµV/m)	EIRP Limit (dBµV/m)	Margin to (dB)	Height (m)	Azimuth (deg)	Polarization	Correction (dB)
39.72560223	30.85	82.2	-51.35	1.00	268.50	Vertical	-7.32
46.95741059	32.88	82.2	-49.32	1.30	283.00	Vertical	-11.25
58.80339103	26.25	82.2	-55.95	2.10	0.00	Vertical	-15.32
799.9946538	38.14	82.2	-44.06	1.87	304.50	Horizontal	4.29

Note: In the table/Plot above, no emissions exceed the Part 24/Part 27 radiated spurious emissions limit when converted to dBuV/m. For final spurious emissions measurements to FCC Part 24/Part 27, see antenna port conducted emissions in applicable test report.

Figure 31: Plot of RE at 3m from 1 to 3 GHz (2 * NR 10M – Mid channel)

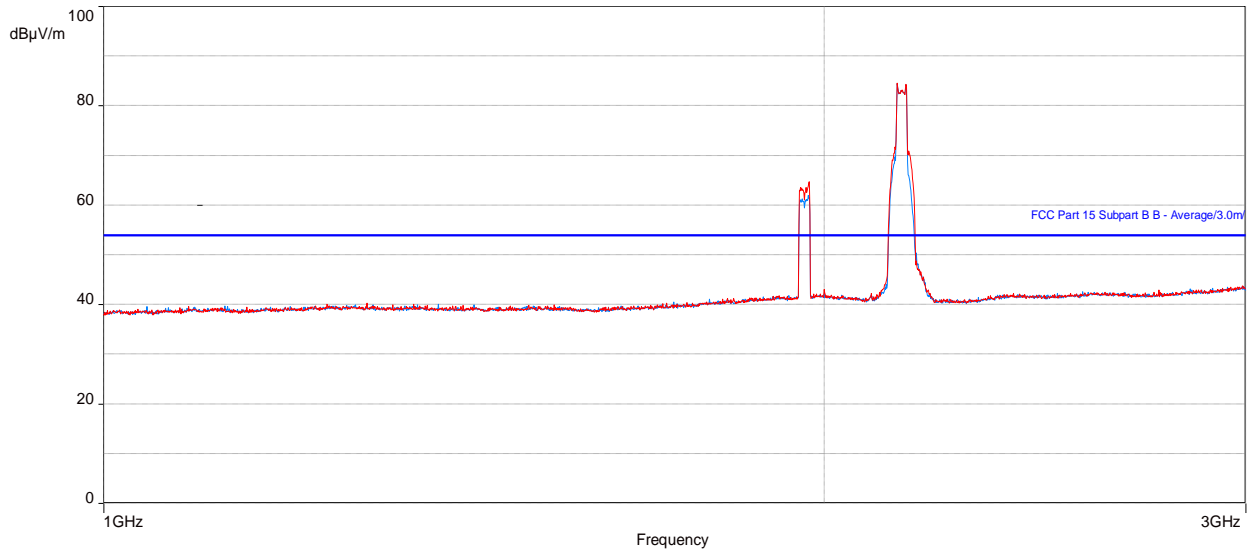

Note: Peaks above the limit are leakage of the EUT’s fundamentals from the 50-ohm terminations.

Table 53: RE test results from 1 to 3 GHz for FCC Part 15 (2 * NR 10M – Mid channel)

Frequency (MHz)	Level Average (dBµV/m)	Limit Average (dBµV/m)	Margin to FCC part 15 Class B (dB)	Height (m)	Azimuth (degrees)	Polarization	Correction (dB)
1999.987179	40.24	53.96	-13.72	3.41	55.00	Horizontal	4.55
1999.986251	38.75	53.96	-15.21	4.00	76.50	Vertical	4.55
2948.068623	39.62	53.96	-14.34	1.00	110.25	Horizontal	6.10
2957.187787	39.13	53.96	-14.83	1.00	328.75	Vertical	6.22

Table 54: RE test results from 1 to 3 GHz for Part 24/27 (2 * NR 10M – Mid channel)

Frequency (MHz)	Level (dBµV/m)	EIRP Limit (dBµV/m)	Margin to (dB)	Height (m)	Azimuth (degrees)	Polarization	Correction (dB)
1999.987179	40.24	82.2	-41.96	3.41	55.00	Horizontal	4.55
1999.986251	38.75	82.2	-43.45	4.00	76.50	Vertical	4.55
2948.068623	39.62	82.2	-42.58	1.00	110.25	Horizontal	6.10
2957.187787	39.13	82.2	-43.07	1.00	328.75	Vertical	6.22

Note: In the table/Plot above, no emissions exceed the Part 24/Part 27 radiated spurious emissions limit when converted to dBuV/m, except for the fundamentals. For final spurious emissions measurements to FCC Part 24/Part 27, see antenna port conducted emissions in applicable test report.

Figure 32: Plot of RE at 3m from 3 to 10 GHz (2 * NR 10M – Mid channel)

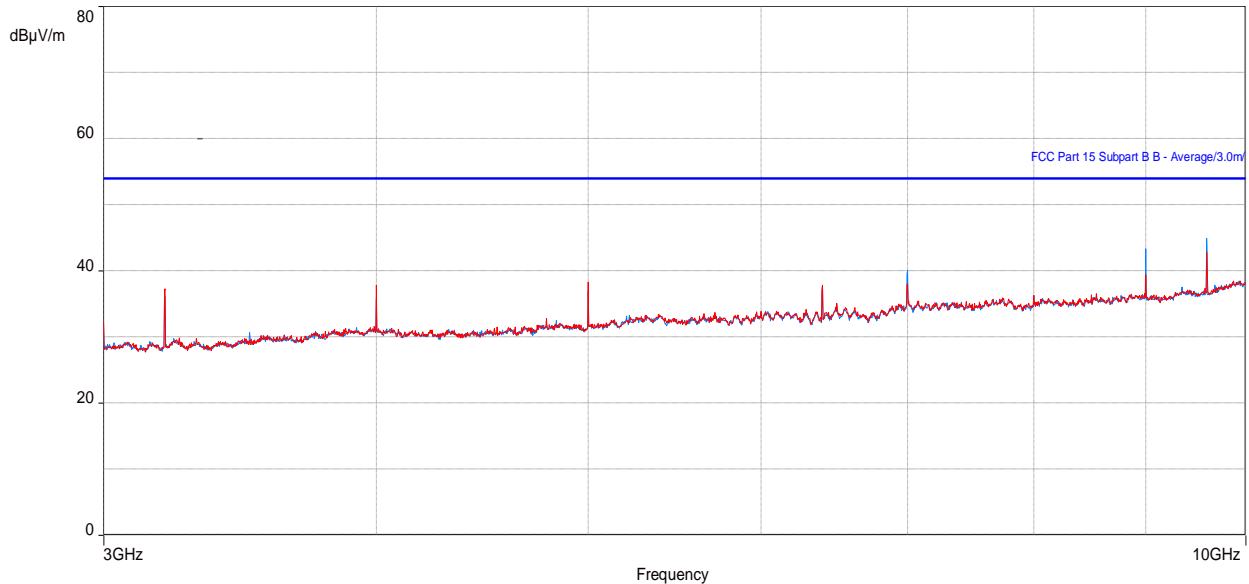

Table 55: RE test results from 3 to 10 GHz for FCC Part 15 (2 * NR 10M – Mid channel)

Frequency (MHz)	Level Average (dBµV/m)	Limit Average (dBµV/m)	Margin to FCC part 15 Class B (dB)	Height (m)	Azimuth (degrees)	Polarization	Correction (dB)
4999.965705	36.78	53.96	-17.18	1.80	-2.00	Vertical	-2.30
8999.939136	41.65	53.96	-12.31	2.07	342.00	Horizontal	4.29
9599.93529	45.35	53.96	-8.61	3.95	18.00	Horizontal	5.81
9599.93529	40.97	53.96	-12.99	1.00	334.75	Vertical	5.81

Table 56: RE test results from 3 to 10 GHz for Part 24/27 (2 * NR 10M – Mid channel)

Frequency (MHz)	Level (dBµV/m)	EIRP Limit (dBµV/m)	Margin to (dB)	Height (m)	Azimuth (degrees)	Polarization	Correction (dB)
4999.965705	36.78	82.2	-45.42	1.80	-2.00	Vertical	-2.30
8999.939136	41.65	82.2	-40.55	2.07	342.00	Horizontal	4.29
9599.93529	45.35	82.2	-36.85	3.95	18.00	Horizontal	5.81
9599.93529	40.97	82.2	-41.23	1.00	334.75	Vertical	5.81

Note: In the table/Plot above, no emissions exceed the Part 24/Part 27 radiated spurious emissions limit when converted to dBuV/m. For final spurious emissions measurements to FCC Part 24/Part 27, see antenna port conducted emissions in applicable test report.

Figure 33: Plot of RE at 3m from 10 to 18 GHz (2 * NR 10M – Mid channel)

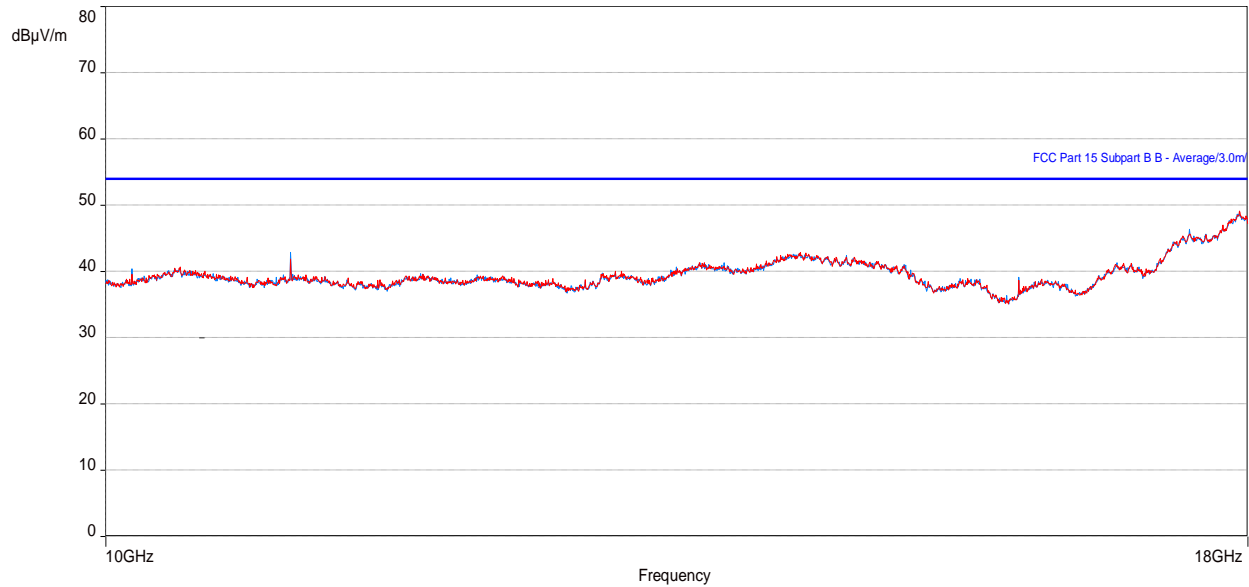

Table 57: RE test results from 10 to 18 GHz for FCC Part 15 (2 * NR 10M – Mid channel)

Frequency (MHz)	Level Average (dBµV/m)	Limit Average (dBµV/m)	Margin to FCC part 15 Class B (dB)	Height (m)	Azimuth (degrees)	Polarization	Correction (dB)
10999.92468	40.67	53.96	-13.29	1.87	40.75	Horizontal	8.52
10999.92468	39.68	53.96	-14.28	1.00	9.50	Vertical	8.52
14289.86056	39.01	53.96	-14.95	1.00	24.00	Horizontal	13.10
14300.09776	39.22	53.96	-14.74	4.00	342.75	Vertical	13.06

Table 58: RE test results from 10 to 18 GHz for Part 24/27 (2 * NR 10M – Mid channel)

Frequency (MHz)	Level (dBµV/m)	EIRP Limit (dBµV/m)	Margin to (dB)	Height (m)	Azimuth (degrees)	Polarization	Correction (dB)
10999.92468	40.67	82.2	-41.53	1.87	40.75	Horizontal	8.52
10999.92468	39.68	82.2	-42.52	1.00	9.50	Vertical	8.52
14289.86056	39.01	82.2	-43.19	1.00	24.00	Horizontal	13.10
14300.09776	39.22	82.2	-42.98	4.00	342.75	Vertical	13.06

Note: In the table/Plot above, no emissions exceed the Part 24/Part 27 radiated spurious emissions limit when converted to dBuV/m. For final spurious emissions measurements to FCC Part 24/Part 27, see antenna port conducted emissions in applicable test report.

Figure 34: Plot of RE at 1m from 18 to 26.5 GHz (2 * NR 10M – Mid channel)

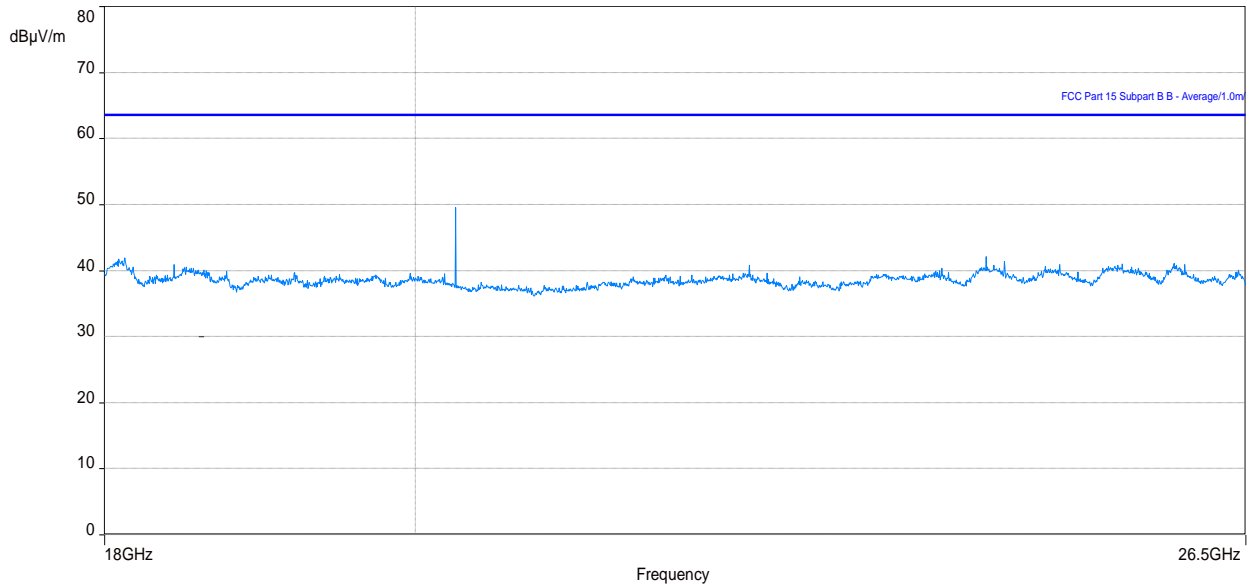

Note 1: In the plot above No Emissions exceeds the FCC Part 15/ICES 003 limit.

Note 2: In the plot above, no emissions exceed the Part 24/27 radiated spurious emissions limit when converted to dBuV/m. For final spurious emissions measurements to FCC Part 24/27, see antenna port conducted emissions in applicable test report.

Figure 35: Plot of RE at 1m from 26.5 to 40 GHz (2 * NR 10M – Mid channel)

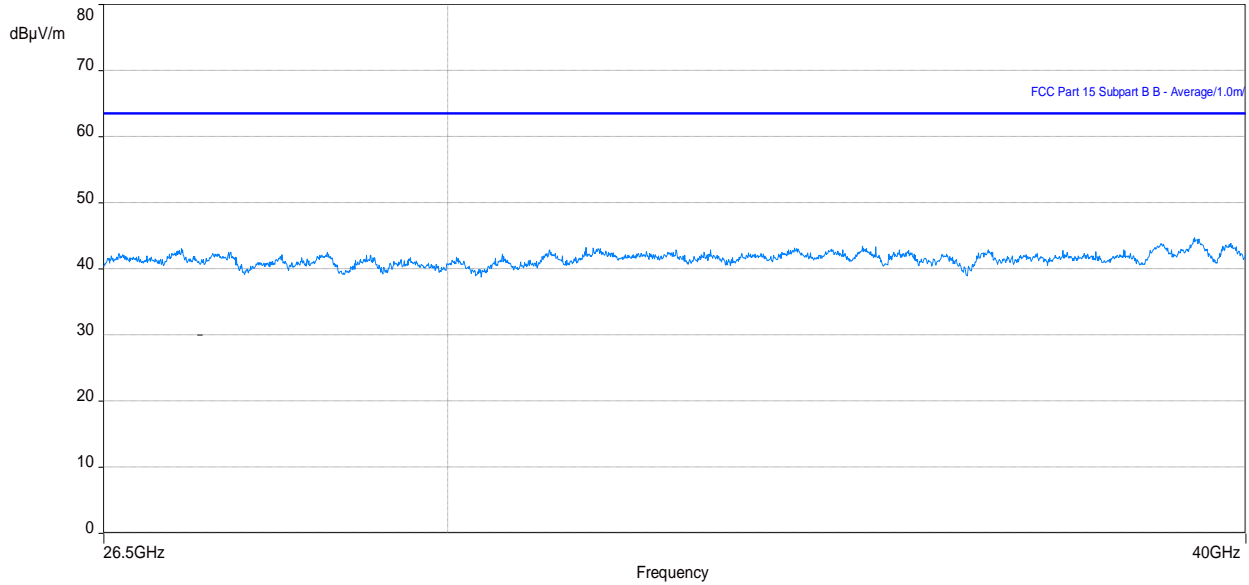

Note 1: In the plot above No Emissions exceeds the FCC Part 15/ICES 003 limit.

Note 2: In the plot above, no emissions exceed the Part 24/27 radiated spurious emissions limit when converted to dBuV/m. For final spurious emissions measurements to FCC Part 24/27, see antenna port conducted emissions in applicable test report.



3.2.10 Test results of Radiated Emissions (Multi RAT/Carrier, L5+2NR10, Mid channel)

Test location: 10-meter Ambient Free Chamber (AFC)

Date tested: 13 October, 2020

Tested by: Krupal Patel

Test configurations are identified in the section [Configurations of the EUT](#).

For the following test results that have supporting data tables, negative margin values indicate a pass.

Figure 36: Plot of RE at 3 m – 30 to 1000 MHz (L5+2NR10 – Mid channel)

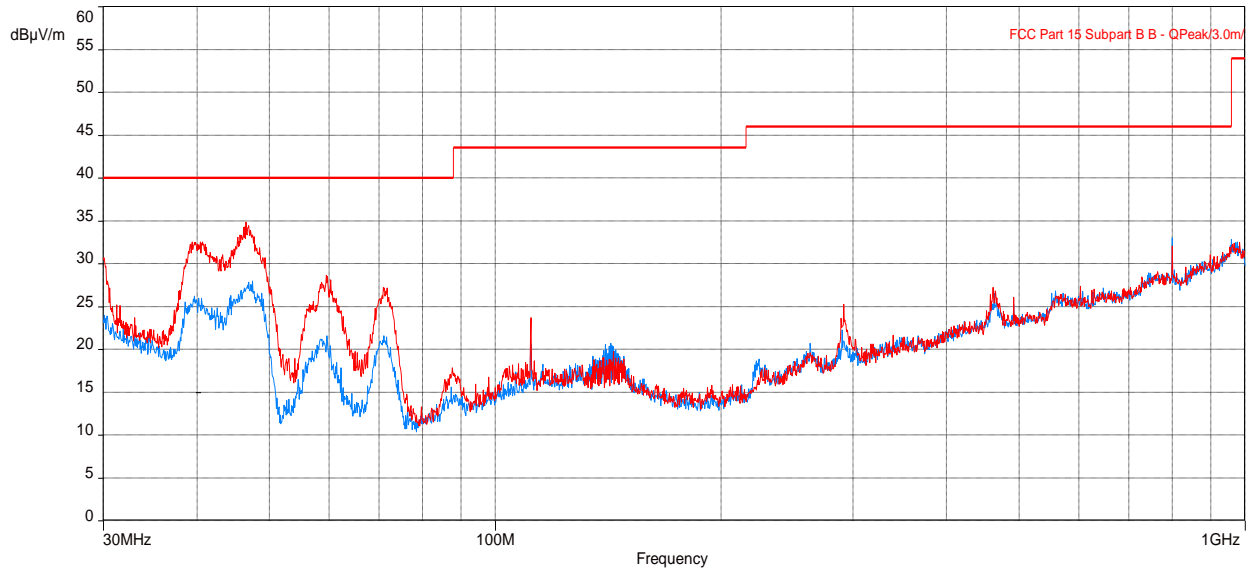

Table 59: RE test results from 30 to 1000 MHz for FCC Part 15 (L5+2NR10, Mid channel)

Frequency (MHz)	Level Quasi Peak (dBµV/m)	Limit Quasi-peak (dBµV/m)	Margin to FCC part 15 Class B (dB)	Height (m)	Azimuth (deg)	Polarization	Correction (dB)
40.68999326	30.14	40.00	-9.86	1.00	278.00	Vertical	-7.89
46.52012821	32.78	40.00	-7.22	1.20	276.75	Vertical	-10.99
47.21703813	26.03	40.00	-13.97	1.93	167.75	Horizontal	-11.37
799.9946538	33.08	46.02	-12.94	1.68	298.25	Horizontal	4.29

Table 60: RE test results from 30 to 1000 MHz for FCC Part 24/27 (L5+2NR10, Mid channel)

Frequency (MHz)	Level (dBµV/m)	EIRP Limit (dBµV/m)	Margin to (dB)	Height (m)	Azimuth (deg)	Polarization	Correction (dB)
40.68999326	30.14	82.2	-52.06	1.00	278.00	Vertical	-7.89
46.52012821	32.78	82.2	-49.42	1.20	276.75	Vertical	-10.99
47.21703813	26.03	82.2	-56.17	1.93	167.75	Horizontal	-11.37
799.9946538	33.08	82.2	-49.12	1.68	298.25	Horizontal	4.29

Note: In the table/Plot above, no emissions exceed the Part 24/Part 27 radiated spurious emissions limit when converted to dBuV/m. For final spurious emissions measurements to FCC Part 24/Part 27, see antenna port conducted emissions in applicable test report.

Figure 37: Plot of RE at 3m from 1 to 3 GHz (L5+2NR10 – Mid channel)

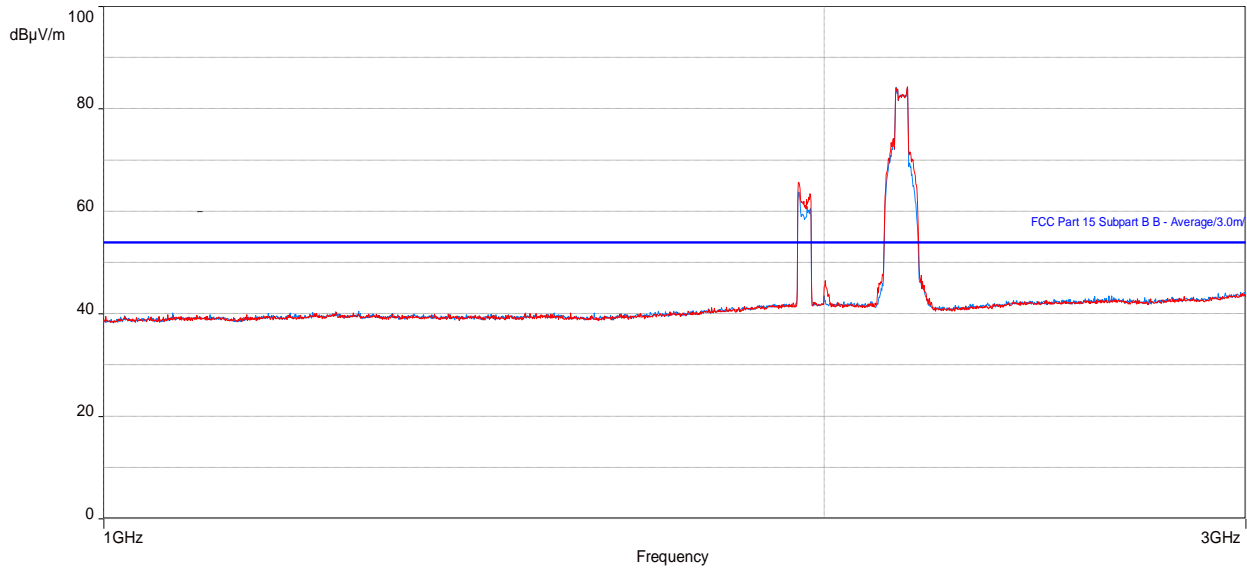

Note: Peaks above the limit are leakage of the EUT’s fundamentals from the 50-ohm terminations.

Table 61: RE test results from 1 to 3 GHz for FCC Part 15 (L5+2NR10, Mid channel)

Frequency (MHz)	Level Average (dBµV/m)	Limit Average (dBµV/m)	Margin to FCC part 15 Class B (dB)	Height (m)	Azimuth (degrees)	Polarization	Correction (dB)
1999.985577	38.61	53.96	-15.35	4.00	328.75	Horizontal	4.55
2002.299967	42.37	53.96	-11.59	4.00	61.50	Vertical	4.54
2942.453559	39.57	53.96	-14.39	1.00	103.25	Horizontal	6.06
2959.200608	39.32	53.96	-14.64	1.00	360.00	Vertical	6.24

Table 62: RE test results from 1 to 3 GHz for Part 24/27 (L5+2NR10, Mid channel)

Frequency (MHz)	Level (dBµV/m)	EIRP Limit (dBµV/m)	Margin to (dB)	Height (m)	Azimuth (degrees)	Polarization	Correction (dB)
1999.985577	38.61	82.2	-43.59	4.00	328.75	Horizontal	4.55
2002.299967	42.37	82.2	-39.83	4.00	61.50	Vertical	4.54
2942.453559	39.57	82.2	-42.63	1.00	103.25	Horizontal	6.06
2959.200608	39.32	82.2	-42.88	1.00	360.00	Vertical	6.24

Note: In the table/Plot above, no emissions exceed the Part 24/Part 27 radiated spurious emissions limit when converted to dBuV/m, except for the fundamentals. For final spurious emissions measurements to FCC Part 24/Part 27, see antenna port conducted emissions in applicable test report.

Figure 38: Plot of RE at 3m from 3 to 10 GHz (L5+2NR10, Mid channel)

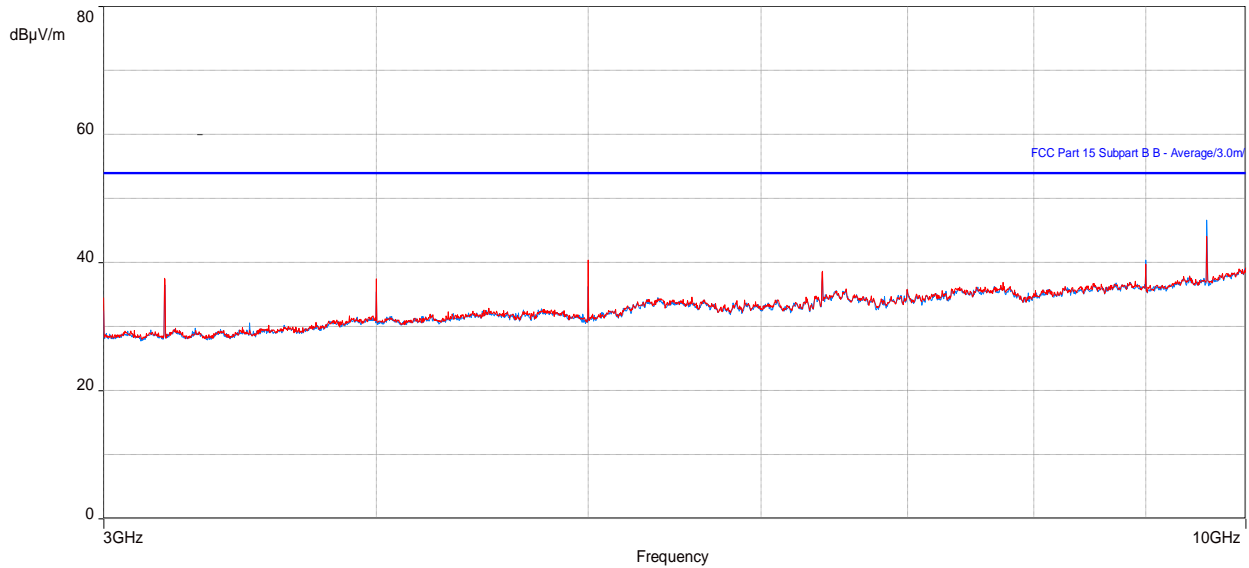

Table 63: RE test results from 3 to 10 GHz for FCC Part 15 (L5+2NR10, Mid channel)

Frequency (MHz)	Level Average (dBµV/m)	Limit Average (dBµV/m)	Margin to FCC part 15 Class B (dB)	Height (m)	Azimuth (degrees)	Polarization	Correction (dB)
3199.977918	35.91	53.96	-18.05	2.10	31.00	Horizontal	-6.27
4999.965705	40.44	53.96	-13.52	2.01	333.75	Vertical	-2.30
8999.93971	39.07	53.96	-14.89	1.00	0.00	Horizontal	4.29
9599.93529	48.09	53.96	-5.87	3.96	12.00	Horizontal	5.81

Table 64: RE test results from 3 to 10 GHz for Part 24/27 (L5+2NR10, Mid channel)

Frequency (MHz)	Level (dBµV/m)	EIRP Limit (dBµV/m)	Margin to (dB)	Height (m)	Azimuth (degrees)	Polarization	Correction (dB)
3199.977918	35.91	82.2	-46.29	2.10	31.00	Horizontal	-6.27
4999.965705	40.44	82.2	-41.76	2.01	333.75	Vertical	-2.30
8999.93971	39.07	82.2	-43.13	1.00	0.00	Horizontal	4.29
9599.93529	48.09	82.2	-34.11	3.96	12.00	Horizontal	5.81

Note: In the table/Plot above, no emissions exceed the Part 24/Part 27 radiated spurious emissions limit when converted to dBuV/m. For final spurious emissions measurements to FCC Part 24/Part 27, see antenna port conducted emissions in applicable test report.

Figure 39: Plot of RE at 3m from 10 to 18 GHz (L5+2NR10, Mid channel)

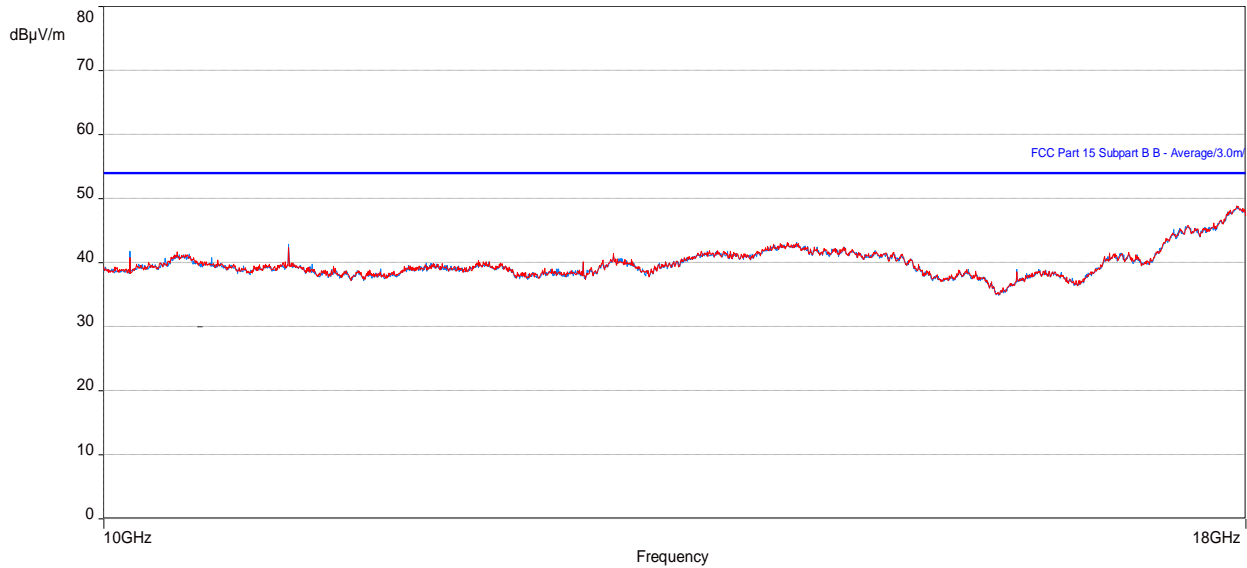

Table 65: RE test results from 10 to 18 GHz for FCC Part 15 (L5+2NR10, Mid channel)

Frequency (MHz)	Level Average (dBµV/m)	Limit Average (dBµV/m)	Margin to FCC part 15 Class B (dB)	Height (m)	Azimuth (degrees)	Polarization	Correction (dB)
10420.71729	37.70	53.96	-16.26	3.82	0.00	Horizontal	10.43
10999.92691	42.07	53.96	-11.89	1.80	41.00	Horizontal	8.52
14216.24774	39.54	53.96	-14.42	1.00	-0.25	Vertical	12.67
14288.41604	39.72	53.96	-14.24	4.00	359.75	Horizontal	13.09

Table 66: RE test results from 10 to 18 GHz for Part 24/27 (L5+2NR10, Mid channel)

Frequency (MHz)	Level (dBµV/m)	EIRP Limit (dBµV/m)	Margin to (dB)	Height (m)	Azimuth (degrees)	Polarization	Correction (dB)
10420.71729	37.70	82.2	-44.5	3.82	0.00	Horizontal	10.43
10999.92691	42.07	82.2	-40.13	1.80	41.00	Horizontal	8.52
14216.24774	39.54	82.2	-42.66	1.00	-0.25	Vertical	12.67
14288.41604	39.72	82.2	-42.48	4.00	359.75	Horizontal	13.09

Note: In the table/Plot above, no emissions exceed the Part 24/Part 27 radiated spurious emissions limit when converted to dBuV/m. For final spurious emissions measurements to FCC Part 24/Part 27, see antenna port conducted emissions in applicable test report.

Figure 40: Plot of RE at 1m from 18 to 26.5 GHz (L5+2NR10, Mid channel)

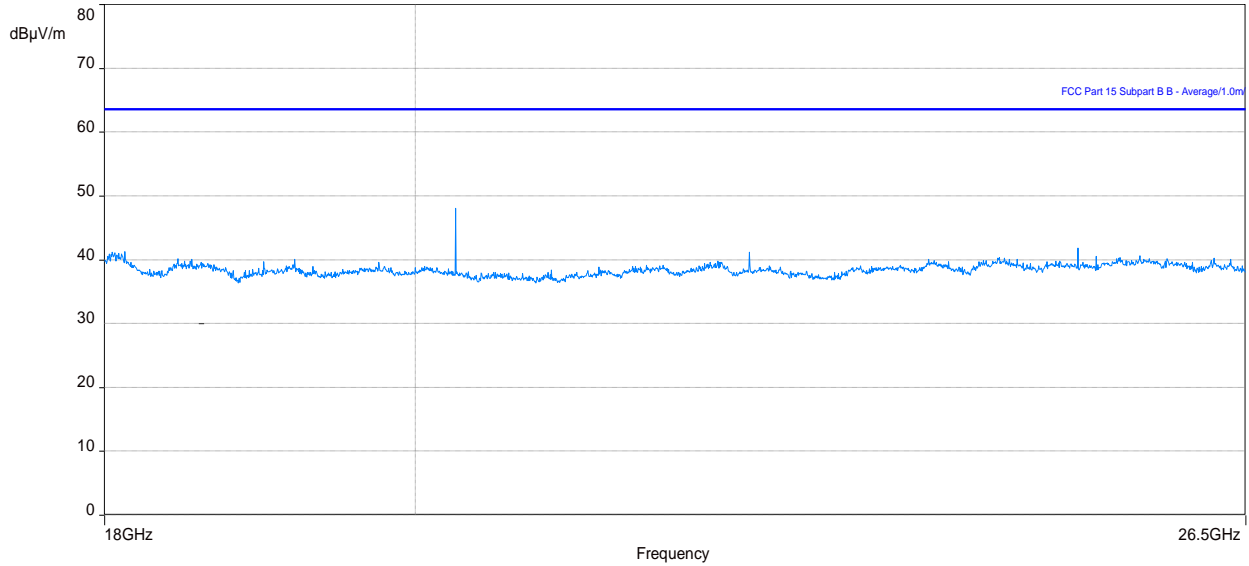

Note 1: In the plot above No Emissions exceeds the FCC Part 15/ICES 003 limit.

Note 2: In the plot above, no emissions exceed the Part 24/27 radiated spurious emissions limit when converted to dBuV/m. For final spurious emissions measurements to FCC Part 24/27, see antenna port conducted emissions in applicable test report.

3.2.11 Radiated Emissions test setup pictures

Figure 41: EUT Setup for RE tests (Closeup)



Figure 42: EUT Setup for RE tests at 30 MHz to 1 GHz

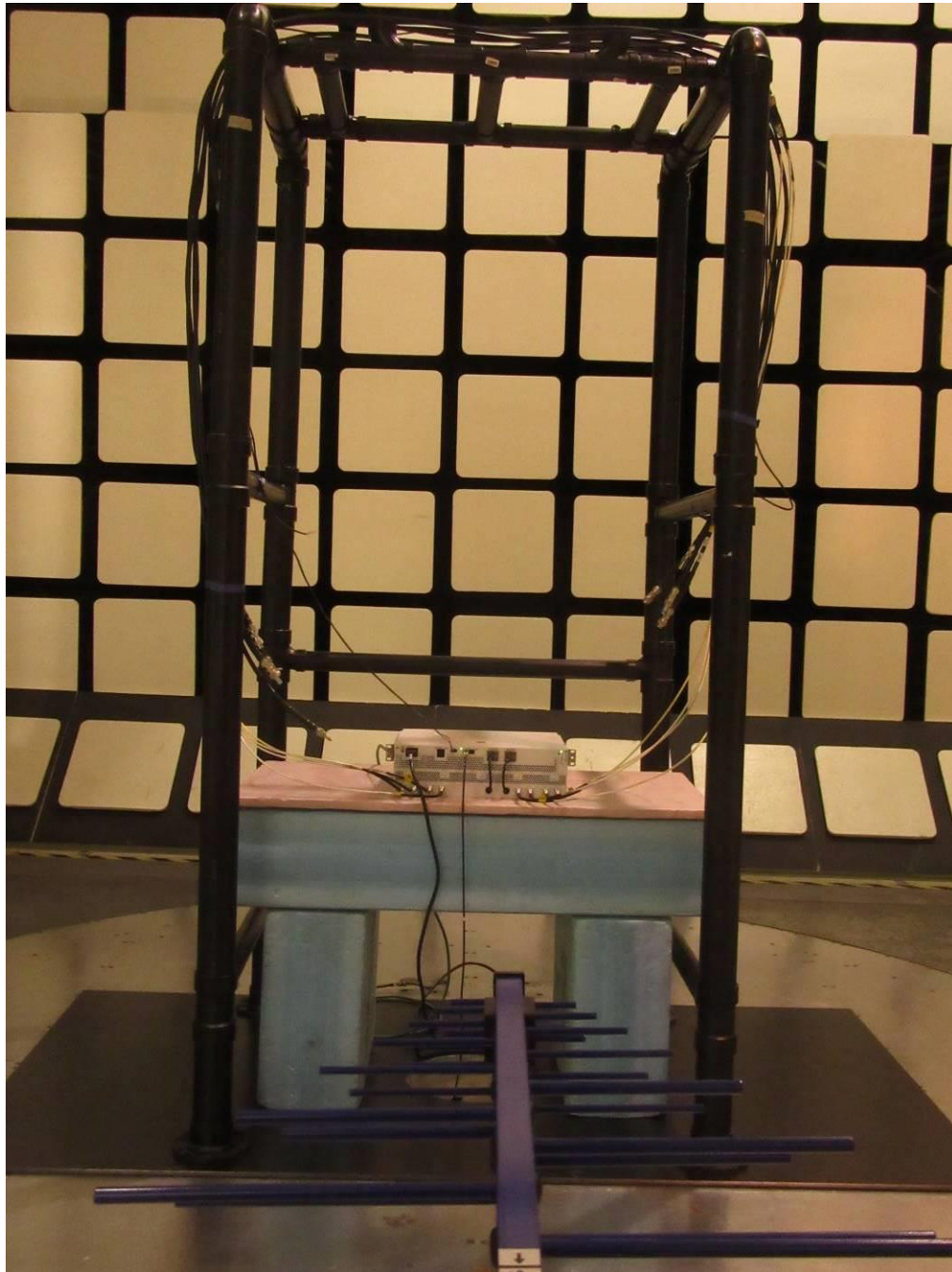
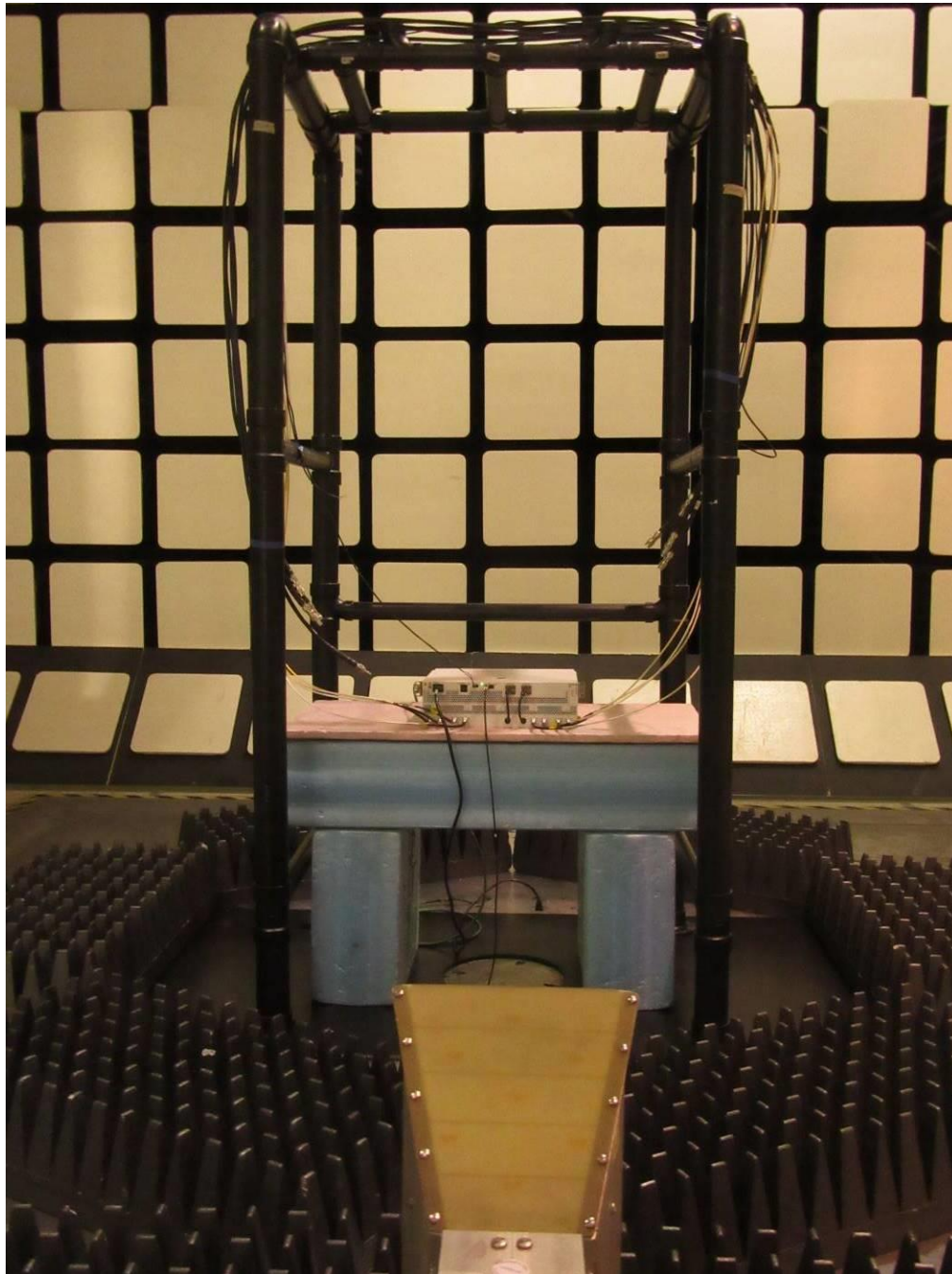

Figure 43: EUT Setup for RE tests for above 1 GHz



3.2.12 Test equipment

The equipment used for E-field RE testing was as follows.

Table 67: Test equipment used for RE

Description	Make	Model number	Asset ID	Calibr. date	Calibr. due
EMC Automation Software	Nexio V3.18	BAT-EMC	F0163649	Not required	
Bilog Antenna	Teseq	6111D	SSG013955	2019-12-03	2020-12-03
Double Ridged Horn Antenna	Emco	3115	SSG012508	2020-05-11	2021-05-11
Horn Antenna (18 - 26.5 GHz)	Emco	3160-09	SSG012292	2019-08-26	2021-08-26
Horn Antenna (26.5 - 40 GHz)	Emco	3160-10	SSG012294	2019-08-26	2021-08-26
EMI Receiver	Rohde & Schwarz	ESU26	SSG013729	2020-03-19	2021-03-19
EMI Receiver	Rohde & Schwarz	ESU40	SSG013672	2019-10-08	2021-01-08
Coaxial Cable	Huber & Suhner	106A	SSG013841	2020-01-06	2021-01-06
Coaxial Cable	Huber & Suhner	106A	SSG012711	2020-01-06	2021-01-06
Coaxial Cable	Huber & Suhner	104PEA	SSG012041	2020-01-06	2021-01-06
Coaxial Cable	Huber & Suhner	ST18/Nm/Nm/36	SSG012785	2020-01-06	2021-01-06
Coaxial Cable	Micro-Coax	UFA 210B-1-1500-504504	SSG012376	2020-01-02	2021-01-02
Coaxial Cable	Huber & Suhner	101 PEA, Sucoflex	SSG012290	2018-11-13	2020-11-13
RF Amplifier	Hewlett Packard	8447D	SSG013045	2020-01-08	2021-01-08
Pre-Amplifier	BNR	LNA	SSG012360	2019-09-26	2020-12-26
Power Supply	Hewlett Packard	6216A	SSG013063	not required	not required
Power Supply	Lambda	LPD-421A-FM	SSG013085	not required	not required
RF Filter: High Pass	Microwave Circuits inc.	H3G02G1	SSG012728	2020-01-06	2021-01-06
Attenuator	Narda	N/A	SSG013687	2020-01-06	2021-01-06
Attenuator	Narda	768-10	SSG012714	2019-01-04	2021-01-05

3.2.13 Test conclusion

The LPRU 4420 B25B66 has passed the E-field Radiated Emission (RE) tests with respect to the standards/sections listed in section [Executive summary](#).

3.3 Conducted Emissions on AC power leads

This test verifies the EUT does not produce excessive Conducted Emissions (CE) on the AC main power leads.

3.3.1 Test specification and limits

The test requirements are as follows.

Table 68: CE test requirements on AC power leads

Requirement	Method	Country of application
FCC Part 15, Subpart B	FCC Part 15 / ANSI C63.4	USA
ICES 003	FCC Part 15 / ANSI C63.4	Canada
RSS-Gen (Section 7.2)	FCC Part 15 / ANSI C63.4	Canada

The limits of the CE tests on AC power leads are as follows.

Table 69: CE test limits on AC power leads for Class B

Frequency range (MHz)	FCC Part 15 Average (dB μ V)	FCC Part 15 Quasi-peak (dB μ V)
0.15 to 0.5	56 to 46	66 to 56
0.5 to 5	46	56
5 to 30	50	60

3.3.2 Test procedure

Verifications of the test equipment were performed before the installation of the EUT in accordance with the quality assurance procedures documented in the EMC test procedures document. The test was performed by the relevant procedures listed in [Table 68](#).

[Figure 44](#) shows the test method for regulatory CE measurements on AC Leads.

Figure 44: CE test method on AC leads for regulatory test cases

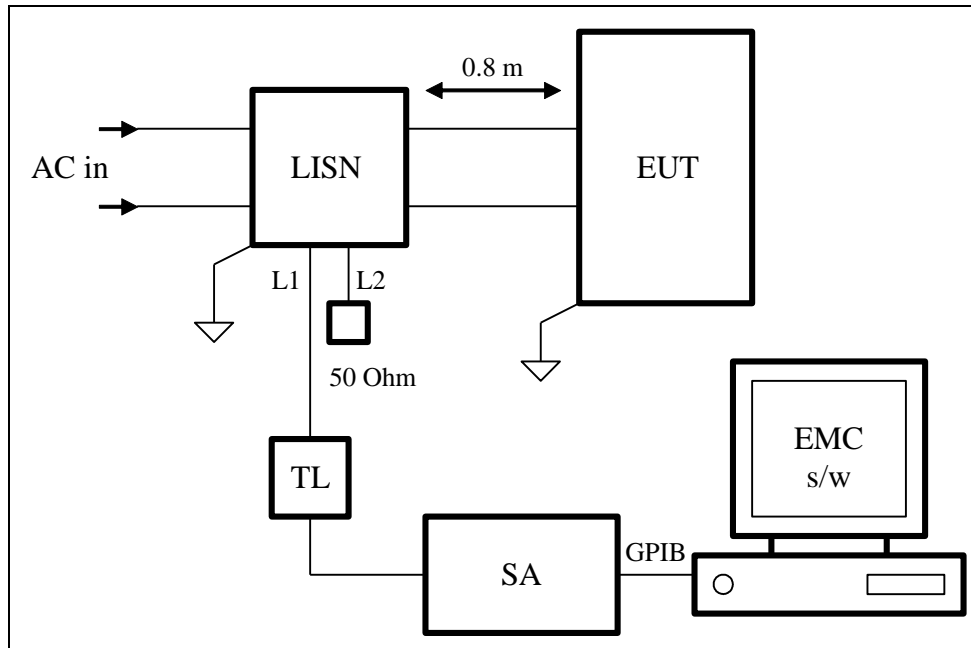

- The EUT was arranged and connected according to its normal mode of operation on a metallic ground plane. The EUT and all cables were insulated from the ground plane which extended by at least 0.5 m beyond the boundaries of the EUT.
- The LISNs were bonded to the ground plane; the distance between the boundary of the EUT and the closest surface of the LISN was 0.8 m. The mains cable between the EUT and the LISNs was 1 m long, or if more than 1 m, the excess cable was folded to form a non-inductive bundle, not exceeding 0.4 m in length. The safety ground connection of the EUT, if present, was connected to the reference ground plane.
- Conducted Emissions were measured by connecting the spectrum analyzer input, through the transient limiter, to the LISN outputs, L1 and L2 (the unused LISN output was terminated with a coaxial 50-Ohm termination).
- For each lead, a pre-scan was taken over the frequency range of the requirement, using peak detection on the spectrum analyzer. The pre-scan data was then compared to the specification limits. Frequencies close to the limit lines were measured using a QP and/or an AVG detector as required.

3.3.3 Calculation of the compliance margin

The compliance margin is computed in a similar way as for RE (see section [Calculation of the compliance margin](#)).

3.3.4 Measurement uncertainties

The expanded measurement instrumentation uncertainty, with a 95 % level of confidence, calculated according to the method described in CISPR 16 is: ± 2.8 dB on CISPR 22 AC power leads conducted emissions.

3.3.5 Test results of CE on AC power ports

Test location: Ground Plane
Date tested: 16 October, 2020
Tested by: Kasi Sivaratnam

Test configurations are identified in the section [Configurations of the EUT](#).

For the following test results that have supporting data tables, negative margin values indicate a pass.

Black/Orange trace = Peak scan, Blue trace = Average scan

Figure 45: Plot of CE on AC port, line L1 for FCC Part 15 class B

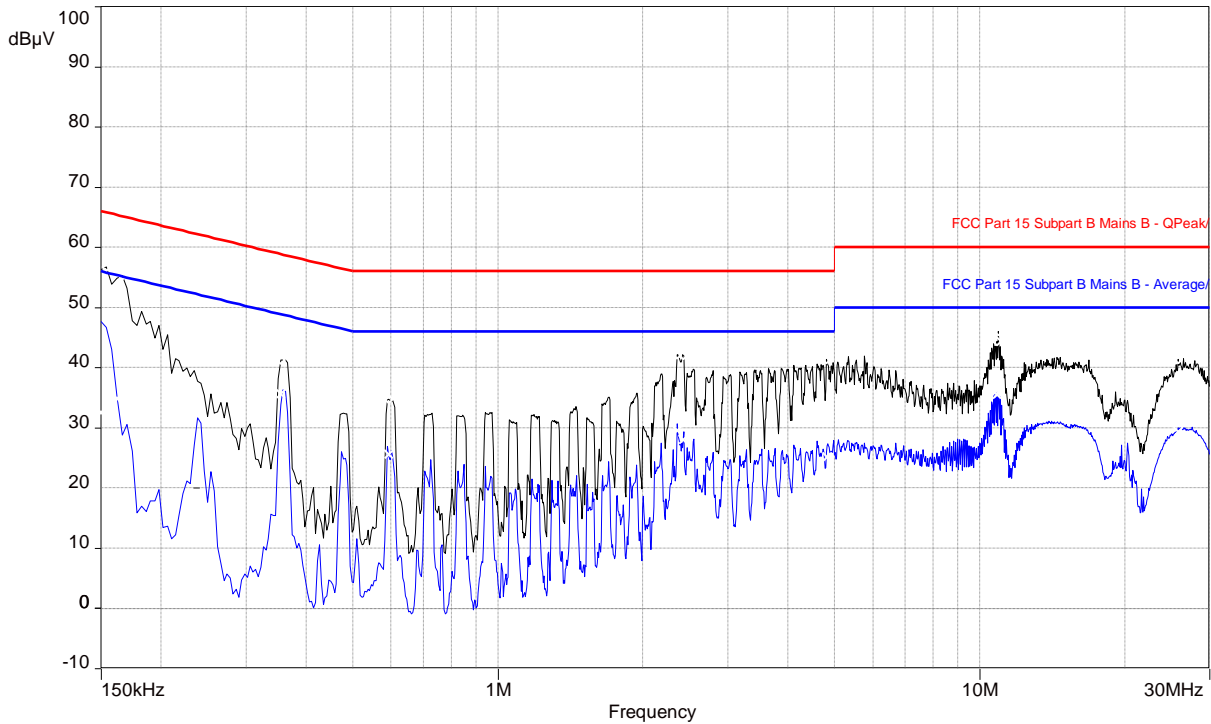

Table 70: CE test results on AC port, line L1 for FCC Part 15 class B

Frequency (MHz)	Level Average (dBµV)	Level Quasi-peak (dBµV)	Margin to Average Class B (dB)	Margin to Quasi-peak Class B (dB)	Limit Average (dBµV)	Limit Quasi-peak (dBµV)	Correction (dB)
0.149644	32.56	35.49	-23.44	-30.51	56.00	66.00	9.91
0.161698	34.81	47.96	-20.55	-17.40	55.36	65.36	9.91
0.354702	35.59	40.44	-13.28	-18.43	48.87	58.87	9.98
0.595764	25.58	33.50	-20.42	-22.50	46.00	56.00	10.01
2.355062	29.58	40.81	-16.42	-15.19	46.00	56.00	10.04
2.422904	27.98	40.09	-18.02	-15.91	46.00	56.00	10.04
4.817276	25.17	36.39	-20.83	-19.61	46.00	56.00	10.11
10.856934	35.56	40.58	-14.44	-19.42	50.00	60.00	10.25
10.949082	35.71	40.54	-14.29	-19.46	50.00	60.00	10.25
25.850378	29.33	34.75	-20.67	-25.25	50.00	60.00	10.54

Figure 46: Plot of CE on AC port, line L2 for FCC Part 15 class B

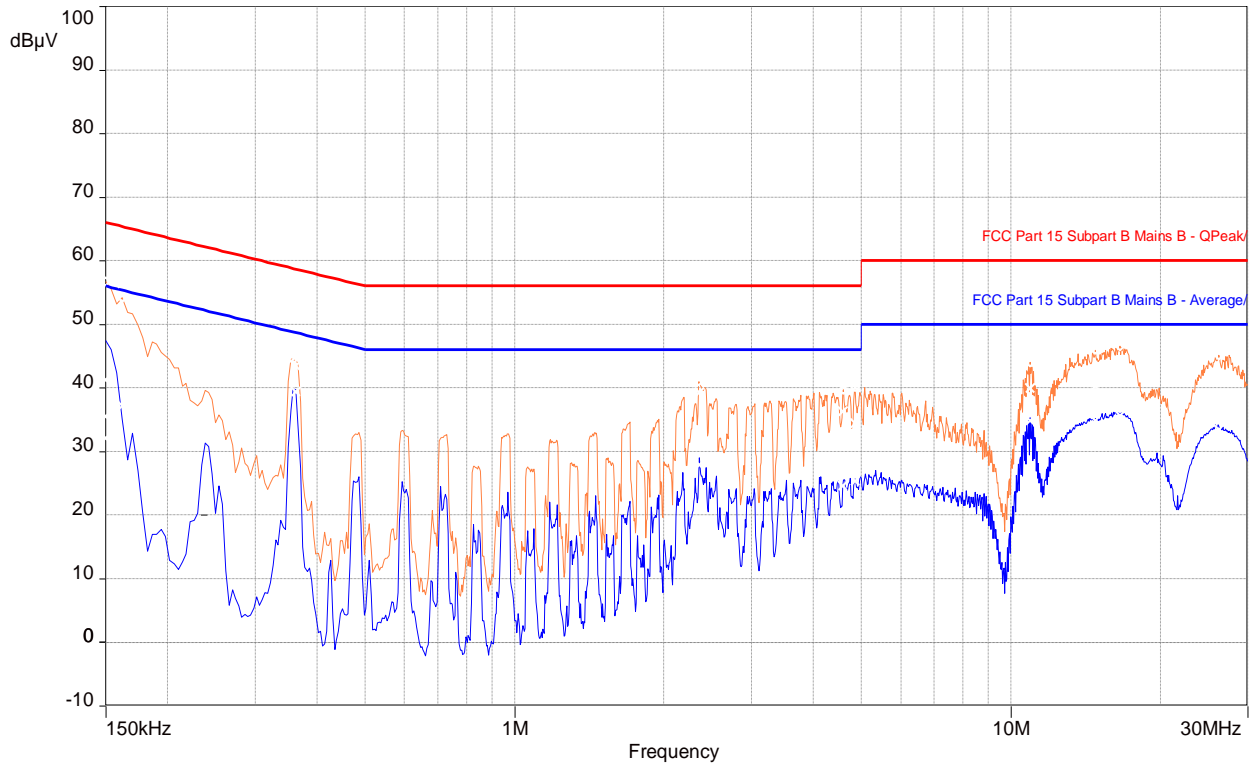

Table 71: CE test results on AC port, line L2 for FCC Part 15 class B

Frequency (MHz)	Level Average (dBµV)	Level Quasi-peak (dBµV)	Margin to Average Class B (dB)	Margin to Quasi-peak Class B (dB)	Limit Average (dBµV)	Limit Quasi-peak (dBµV)	Correction (dB)
0.149478	32.05	35.55	-23.95	-30.45	56.00	66.00	9.99
0.160452	37.19	48.07	-18.17	-17.29	55.36	65.36	9.99
0.360592	39.38	43.49	-9.30	-15.19	48.68	58.68	9.99
2.354158	27.86	39.32	-18.14	-16.68	46.00	56.00	10.04
4.59184	24.55	36.23	-21.45	-19.77	46.00	56.00	10.09
4.854054	25.38	34.45	-20.62	-21.55	46.00	56.00	10.10
10.948394	34.80	39.92	-15.20	-20.08	50.00	60.00	10.24
14.796844	34.86	40.22	-15.14	-19.78	50.00	60.00	10.34
16.575854	35.58	40.95	-14.42	-19.05	50.00	60.00	10.38
26.250342	33.47	39.00	-16.53	-21.00	50.00	60.00	10.52

Figure 47: Setup for CE tests on AC power cables



3.3.6 Test equipment

The equipment used for CE testing was as follows.

Table 72: Test equipment used for CE on AC power leads

Description	Make	Model number	Asset ID	Calibr. date	Calibr. due
EMC Automation Software	Nexio V3.18	BAT-EMC	F0163649	Not required	Not required
EMI Receiver	Rohde & Schwarz	ESCI	SSG013727	2019-09-12	2020-12-12
Coaxial Cable	Huber & Suhner	104PEA	SSG013080	2020-01-06	2021-01-06
Line Impedance Stabilization Network	Teseq	NNB 51	SSG013880	2020-08-11	2021-08-11

3.3.7 Test conclusion

The LPRU 4420 B25B66 has passed the Conducted Emissions (CE) test on AC power leads with respect to class B limit of FCC Part 15 Subpart B, ICES-003 and RSS-Gen.

4. References

The documents, regulations, and standards that are referenced throughout this test report are listed alphabetically as follows.

1. ANSI C63.2-2009, American National Standards Institute for Electromagnetic Noise and Field Strength Instrumentation, 10 Hz to 40 GHz – Specifications.
2. ANSI C63.4-2014, American National Standards Institute for Methods of Measurement of Radio-Noise Emission from Low-Voltage Electrical and Electronic Equipment in the Range of 9 kHz to 40 GHz.
3. CISPR 16 Publications (all parts and sections), Specification for Radio Disturbance and Immunity Measuring Apparatus and Methods - Part 1: Radio Disturbance and Immunity Measuring Apparatus.
4. CISPR 22 (2008, +IS 1, + IS 2, + IS 3: 2012), Information technology equipment - Radio disturbance characteristics - Limits and methods of measurement.
5. FCC Rules for Radio Frequency Devices, Title 47 of the Code of Federal Regulations, Part 2, U.S. Federal Communications Commission.
6. FCC Rules for Radio Frequency Devices, Title 47 of the Code of Federal Regulations, Part 15 Radio Frequency Devices, U.S. Federal Communications Commission.
7. FCC Rules for Radio Frequency Devices, Title 47 of the Code of Federal Regulations, Part 24 – PERSONAL COMMUNICATIONS SERVICES, U.S. Federal Communications Commission.
8. FCC Rules for Radio Frequency Devices, Title 47 of the Code of Federal Regulations, Part 27 Miscellaneous Wireless Communications Services, U.S. Federal Communications Commission.
9. ICES-003 Issue 6 (2016), Spectrum Management and Telecommunications, Interference-Causing Equipment Standard: Information Technology Equipment (ITE) – Limits and methods of measurement.
10. Radio Standards Specification RSS-133, issue 6 (January 2018), 2 GHz Personal Communication Services, Ministry of Industry, Government of Canada.
11. Radio Standards Specification RSS-139, issue 3 (July 2015), Advanced Wireless Services (AWS) Equipment Operating in the Bands 1710 - 1780 MHz and 2110-2180 MHz. Ministry of Industry, Government of Canada.
12. Radio Standards Specification RSS-170, issue 3 (July 2015), Mobile Earth Stations (MESs) and Ancillary Terrestrial Component (ATC) Equipment Operating in the Mobile-Satellite Service (MSS) Bands. Ministry of Industry, Government of Canada.
13. RSS-Gen – General Requirements for Compliance of Radio Apparatus, Issue 5 (March 2019); Ministry of Industry, Government of Canada.

4.1 Appendix A: Abbreviations

The abbreviations of terms used in this document are as follows.

Term	Definition
A	6 dB Coaxial Attenuator (Conducted Immunity)
AAN	Asymmetric Artificial Network (ISN)
AE	Auxiliary equipment
AFC	Ambient Free Chamber
ANSI	American National Standards Institute
AVG	Average detector
BiLog	Biconical Log-Periodic Hybrid antenna (a registered trademark of Schaffner-Chase EMC Limited, 1993)
CDN	Coupling-decoupling Network
CE	Conducted Emissions
CISPR	Comité International Spécial Perturbation Radioélectrique (International Special Committee on Radio Interference)
CSA	Canadian Standards Association
DN/P	Decoupling / Protection Network
EMC	Electromagnetic Compatibility
EMI	Electromagnetic Interference
ETSI	European Telecommunications Standards Institute
EUT	equipment under test
GND	Ground
HCP	Horizontal Coupling Plane
HME	Harmonics Measurement Equipment
HV	High Voltage
HVP	High Voltage Probe
h/w	hardware
IC	Industry Canada
ICES	Canadian Specification: ICES-003, Issue 3, "Spectrum Management: Interference-causing equipment standard (Digital Apparatus)
IEC	International Electro Technical Association
ISN	Impedance Stabilization Network
LISN	Line Impedance Stabilization Network
ms	millisecond, unless otherwise specified
NA, na	not applicable



Term	Definition
PA	Broadband Power Amplifier
PK	Peak Detector
PS	Power Supply
QP	Quasi-peak Detector
QPA	Quasi-peak Adapter (for the Spectrum Analyzer)
R	100-ohm Injection Resistor (Conducted Immunity)
RBW	Resolution Bandwidth
RE	Radiated Emissions
RF	Radio-Frequency
RI	Radiated Immunity
RMS	Root-mean-square
s/w	software
SA	Spectrum Analyzer, the CISPR 16, ANSI C63.2 Compliant EMI meter
STP	Shielded Twisted Pair
T	50-ohm Coaxial Termination (Conducted Emissions / Immunity)
TL	Transient Limiter
UFA	Uniform field Area
VBW	Video Bandwidth



TÜV SÜD Canada Inc

EMC Test Report

End of Document