



Add value.  
Inspire trust.

# Report On

FCC and ISED Testing of the Ericsson LPRU 4420 B25B66, KRC 161 906/1 LTE, NR, LTE + NR (2100 MHz) Base Station in accordance with FCC CFR 47 Part 2, FCC CFR 47 Part 24, FCC CFR 47 Part 27, Industry Canada RSS-GEN, Industry Canada RSS-139, Industry Canada RSS-170.

COMMERCIAL-IN-CONFIDENCE

FCC: TA8AKRC161906-1

ISED: 287AB-AS1619061

PREPARED BY

Handwritten signature of Glen Westwell in black ink.

Glen Westwell

APPROVED BY

Handwritten signature of Scott Drysdale in black ink.

Scott Drysdale  
Authorised Signatory

DATED

Nov 2<sup>nd</sup> 2020

Document 7169008570 Report 01 Issue 1

November 2020



## CONTENTS

Section	Page No
<b>1</b>	<b>REPORT INFORMATION ..... 2</b>
1.1	Report Details ..... 3
1.2	Brief Summary of Results ..... 4
1.3	Configuration Description ..... 5
1.4	Declaration of Build Status ..... 6
1.5	Product Information ..... 7
1.6	Test Setup ..... 8
1.7	Test Conditions ..... 9
1.8	Test Location ..... 9
1.9	Deviation From The Standard ..... 9
1.10	Modification Record ..... 9
1.11	Additional Information ..... 9
<b>2</b>	<b>TEST DETAILS ..... 10</b>
2.1	Maximum Peak Output Power and Peak to Average Ratio - Conducted ..... 11
2.2	Occupied Bandwidth ..... 63
2.3	Band Edge ..... 64
2.4	Transceiver Spurious Emissions ..... 86
2.5	Frequency Stability ..... 97
<b>3</b>	<b>TEST EQUIPMENT USED ..... 98</b>
3.1	Test Equipment Used ..... 99
3.2	Measurement Uncertainty ..... 100
<b>4</b>	<b>ACCREDITATION, DISCLAIMERS AND COPYRIGHT..... 101</b>
4.1	Accreditation, Disclaimers and Copyright..... 102
<b>ANNEX A</b>	<b>Module Lists..... A.2</b>



## SECTION 1

### REPORT INFORMATION



## 1.1 REPORT DETAILS

Manufacturer	Ericsson
Address	Torshamnsgatan 23 Kista SE-16480 Stockholm Sweden
Product Name & Product Number	LPRU 4420 B25B66, KRC 161 906/1
IC Model Name	AS1619061
Serial Number(s)	TD3F082779
Software Version	CXP9013268%17_R84FH
Hardware Version	R1B
Test Specification/Issue/Date	FCC CFR 47 Part 2: 2019 FCC CFR Part 24: 2019 FCC CFR 47 Part 27: 2019 Industry Canada RSS-GEN: Issue 5: March 2019 Amendment 1 Industry Canada RSS-139: Issue 3: 2015 Industry Canada RSS-170: Issue 3: 2015
Test Plan	LPRU 4420 B25B66_RA_testplan_NR_LTE
Start of Test	29 September 2020
Finish of Test	16 October 2020
Name of Engineer(s)	Glen Westwell
Related Document(s)	KDB 971168 D01 v02r02 KDB 662911 D01 v02r01

---

### ENGINEERING STATEMENT

The measurements shown in this report were made in accordance with the procedures described on test pages. All reported testing was carried out on a sample equipment to demonstrate compliance with FCC CFR 47 Part 27. The sample tested was found to comply with the requirements defined in the applied rules.

Test Engineer(s);

---

Glen Westwell



## 1.2 BRIEF SUMMARY OF RESULTS

A brief summary of results for each configuration, in accordance with FCC CFR 47 Part 2, FCC CFR 47 Part 27, Industry Canada RSS-GEN and Industry Canada RSS-139, & RSS-170, is shown below.

Section	Specification Clause					Test Description	Result
	FCC CFR 47 Part 2		RSS-GEN				
-		FCC CFR 47 Part 27		RSS-139	RSS-170	Equivalent Isotropically Radiated Power (EIRP)	N/A <sup>1</sup>
2.1	2.10 46	27.50	-	6.4	5.3	Maximum Peak Output Power and Peak to Average Ratio - Conducted	Pass
2.2	2.10 49	27.53	6.7	-	-	Occupied Bandwidth	Pass
2.3	2.10 51	27.53 (h)	-	6.5	5.4	Band Edge	Pass
2.4	2.10 51	27.53 (h)	7.4	6.5	5.4	Transceiver Spurious Emissions	Pass
2.5	2.10 55	27.54	-	6.3	5.2	Frequency Stability	Pass

N/A<sup>1</sup>– Not Applicable, due to no integral antenna. EIRP assumes a 0dBi gain antenna.  
N/A – Not Applicable

This unit was tested without an antenna. ERP/EIRP compliance is addressed at the time of licensing, as required by the responsible ISED Bureau(s). Licensees are required to take into account the maximum allowed antenna gain used in combination with the power settings to prevent the radiated output power exceeding the limits.

Testing in this Report covers only B66 (2100MHz).

For additional configurations and test cases not contained within this test report, refer to the following reports:

7169008570 Report 02 – LPRU 4420 B25B66 LTE, NR, LTE + NR (B25)

### Measurement Uncertainty Decision Statement

Determination of conformity with the specification limits is based on the results of the compliance measurement and does not take into account measurement instrumentation uncertainty as defined in ANSI C63.26:2015 Clause 1.3.



### 1.3 CONFIGURATION DESCRIPTION

Configuration	RAT	No. Of carriers	Carrier Bandwidth	Carrier Frequency Configuration (MHz)		
				Bottom	Middle	Top
A	LTE	1	5 MHz	2112.5	2155.0	2197.5
			10 MHz	2115.0	2155.0	2195.0
			15 MHz	2117.5	2155.0	2192.5
			20 MHz	2120.0	2155.0	2190.0
	NR (SCS 15kHz)		5 MHz	2112.5	2155.0	2197.5
			10 MHz	2115.0	2155.0	2195.0
			15 MHz	2117.5	2155.0	2192.5
			20 MHz	2120.0	2155.0	2190.0
B	LTE	3	5 MHz	2112.5+2117.5+2122.5	2150.0+2155.0+2160.0	2187.5+2192.5+2197.5
			10 MHz	2115.0+2125.0+2135.0	2145.0+2155.0+2165.0	2175.0+2185.0+2195.0
			15 MHz	2117.5+2132.5+2147.5	2140.0+2155.0+2170.0	2162.5+2177.5+2192.5
			20 MHz	2120.0+2140.0+2160.0	2135.0+2155.0+2175.0	2150.0+21670.0+2190.0
	NR (SCS 15kHz)		5 MHz	2112.5+2117.5+2122.5	2150.0+2155.0+2160.0	2187.5+2192.5+2197.5
			10 MHz	2115.0+2125.0+2135.0	2145.0+2155.0+2165.0	2175.0+2185.0+2195.0
			15 MHz	2117.5+2132.5+2147.5	2140.0+2155.0+2170.0	2162.5+2177.5+2192.5
			20 MHz	2120.0+2140.0+2160.0	2135.0+2155.0+2175.0	2150.0+21670.0+2190.0
	NR + LTE		5 MHz	2112.5+2117.5+2122.5	2150.0+2155.0+2160.0	2187.5+2192.5+2197.5
			10 MHz	2115.0+2125.0+2135.0	2145.0+2155.0+2165.0	2175.0+2185.0+2195.0
			15 MHz	2117.5+2132.5+2147.5	2140.0+2155.0+2170.0	2162.5+2177.5+2192.5
			20 MHz	2120.0+2140.0+2160.0	2135.0+2155.0+2175.0	2150.0+21670.0+2190.0



## 1.4 DECLARATION OF BUILD STATUS

### DECLARATION OF BUILD STATUS

MAIN EUT	
MANUFACTURING DESCRIPTION	LPRU 4420 B25B66
MANUFACTURER	Ericsson
TYPE	Remote Radio Base Station
PART NUMBER	KRC 161 906/1
SERIAL NUMBER	TD3F082779
HARDWARE VERSION	R1B
SOFTWARE VERSION	CXP0013268%17_R84FH
TRANSMITTER OPERATING RANGE	B25: 1930-1995 MHz, B66: 2110-2200MHz
RECEIVER OPERATING RANGE	B25: 1850-1915 MHz, B66: 1710-1780MHz
COUNTRY OF ORIGIN	China
INTERMEDIATE FREQUENCIES	None
EMISSION DESIGNATOR(S): (i.e. G1D, GXW)	B25 and B66 LTE: 5M00W7D, 10M0W7D, 15M00W7D, 20M0W7D B25 and B66 NBloT Guardband: 10M0W7D, 15M00W7D, 20M0W7D  B25 and B66 NR: 5M00F9W, 10M0F9W, 15M0F9W, 20M0F9W
MODULATION TYPES: (i.e. GMSK, QPSK)	LTE: QPSK, 16QAM, 64QAM, 256QAM NR: QPSK, 16QAM, 64QAM, 256QAM
HIGHEST INTERNALLY GENERATED FREQUENCY	2.2 GHz
OUTPUT POWER (W or dBm)	B25: 4 x 0.159W (22dBm) B66: 4 x 0.159W (22dBm)
ANTENNA GAIN	B25: 0 dBi B66: 0dBi The LPRU 4420 B25B66 product will only be installed with its RF output ports connected to Active Distributed Antenna Systems (DAS). Our product will not be directly connected to antennas.
FCC ID	TA8AKRC161906-1
INDUSTRY CANADA ID	287AB-AS1619061
TECHNICAL DESCRIPTION (a brief description of the intended use and operation)	LPRU 4420 B25B66 (KRC 161 906/1) is a Remote Radio Unit forming part of the Ericsson Radio Base Station (RBS) equipment. The LPRU provides radio access for mobile and fixed devices and is intended for the indoor environment. The radio operates over 8 Transmit ports in MRO (LTE, NBloT, and NR); Single, and Multi-Carrier transmission with a maximum rated RF Output of 0.159W per port over an operational temperature of 0°C to +55°C. The unit is designed to be rack mounted.

Signature:

Denis Lalonde

Date: 30 October 2020

Declaration of Build Status Serial Number: TD3F082779

No responsibility will be accepted by TÜV SÜD UK Limited as to the accuracy of the information declared in this document by the manufacturer.



## 1.5 PRODUCT INFORMATION

### 1.5.1 Technical Description

The Equipment Under Test (EUT) LPRU 4420 B25B66 is an Ericsson AB Radio Unit working in the public mobile service 2100MHz band which provides communication connections to 2100 MHz) network. The LPRU 4420 B25B66 operates from a -48V DC supply.

The Equipment Under Test (EUT) is shown in the photograph below. A full technical description can be found in the Manufacturer's documentation.

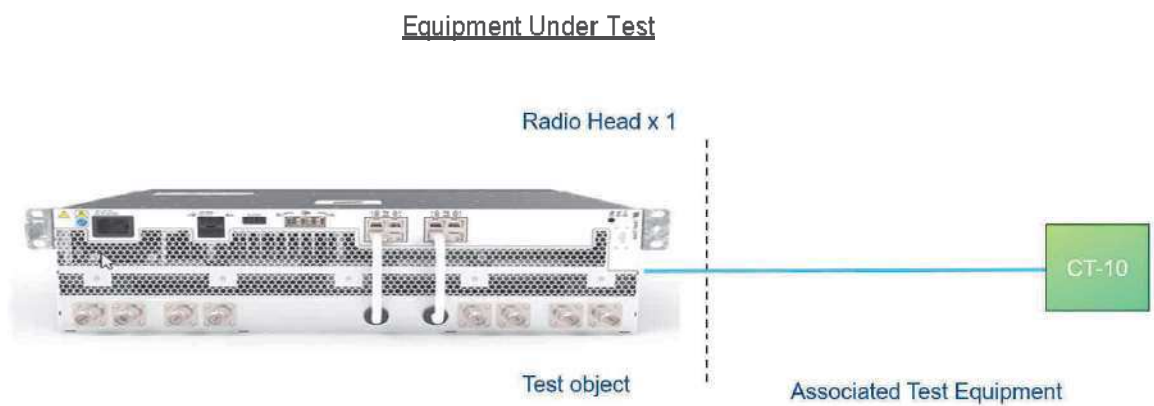





## 1.6 TEST SETUP

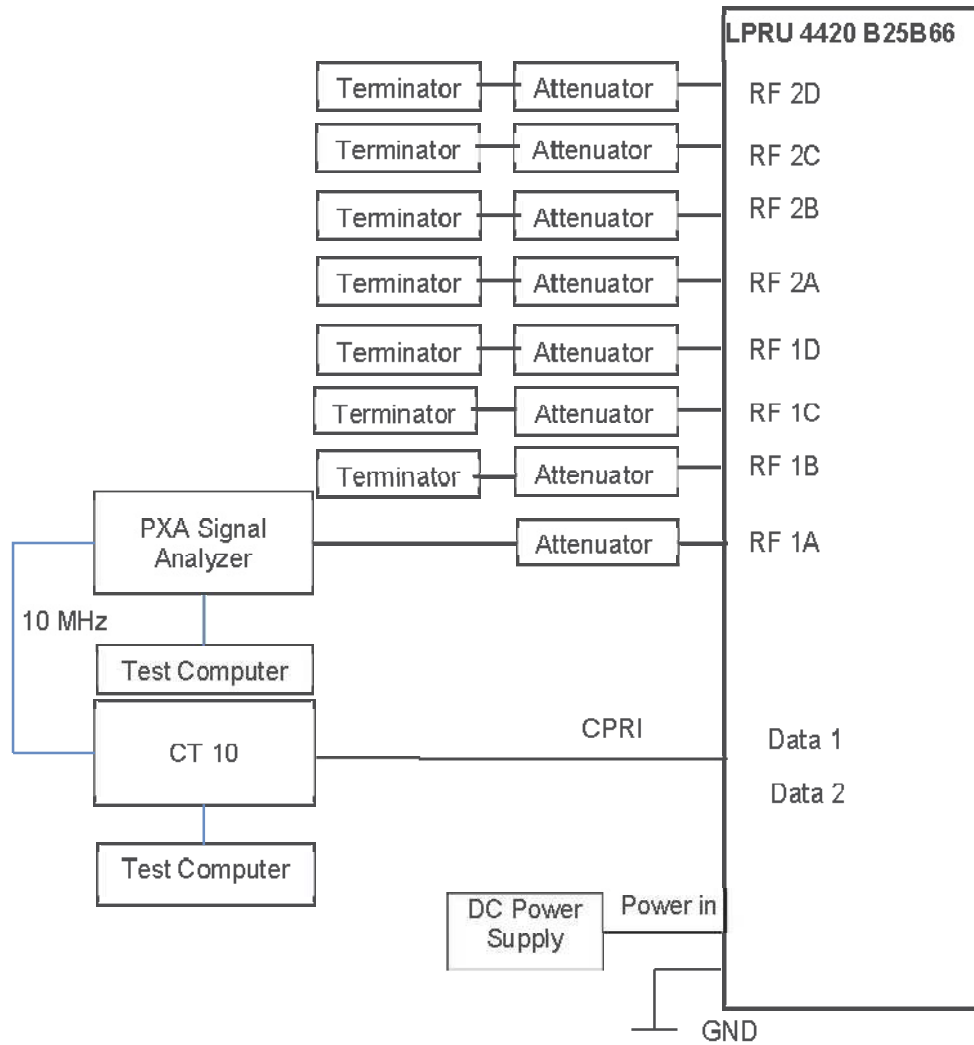



## 1.7 TEST CONDITIONS

For all tests the EUT was set up in accordance with the relevant test standard and to represent typical operating conditions. Tests were applied with the EUT situated as described in the Test Method for each Test.

The EUT was powered from a -48V DC supply.

FCC Measurement Facility Registration Number: CA4810

ISED Accreditation  
ISED#24015, TÜV SÜD, Ottawa, Canada

Under our group A2LA Accreditation, TÜV SÜD conducted the following tests at Ericsson, Ottawa.

Test Name	Name of Engineer(s)
Maximum Peak Output Power and Peak to Average Ratio - Conducted	Glen Westwell
Occupied Bandwidth	Glen Westwell
Band Edge	Glen Westwell
Transceiver Spurious Emissions	Glen Westwell
Frequency Stability	Glen Westwell

## 1.8 TEST LOCATION

Testing was performed at Ericsson Ottawa client facility located at 349 Terry Fox Dr, Kanata On. Canada

## 1.9 DEVIATION FROM THE STANDARD

No deviations from the applicable test standards or test plan were made during testing.

## 1.10 MODIFICATION RECORD

No modifications were made to the EUT during testing.

## 1.11 ADDITIONAL INFORMATION

1. Transmitter performance was measured for top, mid & bottom channels across all 4 antenna ports as presented in the average power measurement tables. Maximum power performance was determined to be, antenna port A, Mid band.

These worst-case results from antenna port A are presented in this report to demonstrate compliance.

2. The 10MHz LTE carrier contains a NB-IoT GB carrier where possible for evaluation as part of this submission.



## SECTION 2

### TEST DETAILS



## **2.1 MAXIMUM PEAK OUTPUT POWER AND PEAK TO AVERAGE RATIO - CONDUCTED**

### **2.1.1 Specification Reference**

FCC CFR 47 Part 2, Clause 2.1046  
FCC CFR 47 Part 27, Clause 27.50  
Industry Canada RSS-139, Clause 6.4  
Industry Canada RSS-170, Clause 5.3

### **2.1.2 Date of Test and Modification State**

13 and 14 October 2020 - Modification State 0

### **2.1.3 Test Equipment Used**

The major items of test equipment used for the above tests are identified in Section 3.1.

### **2.1.4 Environmental Conditions**

Ambient Temperature	22.8 – 23.5°C
Relative Humidity	31.3 - 33.1%

### **2.1.5 Test Method**

All measurements were made in accordance with FCC KDB 971168 D01, clause 5.2.1 and summed in accordance with FCC KDB 662911 D01.

Measurements were performed with a Spectrum Analyser using the Band Power measurement function. The detector was set to RMS with an RBW of at least 1 % of the carrier bandwidth and a VBW of at least 3 times the RBW. The integration bandwidth was configured to be wider than the total bandwidth of the carrier or combinations of carriers, (multi-carrier). Using a sweep time of auto, measurements were performed over 200 samples, with the average measurement recorded.

Due to Average measurements being recorded, an additional Peak to Average measurement was made in all single carrier configurations. This was achieved using the CCDF function of the Spectrum Analyser with the RBW being set to a value wider than the largest signal being measured – in this case – 20 MHz

Using a power meter and attenuator(s), the output power of the EUT was measured at the antenna terminal. The path loss between the EUT and the power sensor was measured and recorded for the test band. The path loss was entered as an offset into the power meter and spectrum analyser.

The EUT was configured to transmit on maximum power on the configurations defined in the tables below. Since the EUT transmits on 4 antennas simultaneously in the same frequency range for MIMO devices, i.e., TX MIMO mode, using the Measure-and-Sum approach, the output power at all antenna ports were tested, and the total output power were then summed mathematically in linear power units as recored in the tables below.

The declared Maximum Antenna Gain to be used with this product, as Declared by the Manufacturer is 0 dBi. The EIRP is calculated as the sum of the measured power plus the antenna gain.



## 2.1.6 Test Results



Configuration A

Maximum Output Power 22 dBm / Port

Antenna	Modulation	Carrier Bandwidth	Peak to Average Ratio (PAR) / Output Power		
			Channel Position B		
			PAR (dB)	Average Power	
			dBm	dBm/MHz	
A	LTE: QPSK	5.0 MHz	9.25	21.01	16.15
B	LTE: QPSK	5.0 MHz	-	21.01	16.15
C	LTE: QPSK	5.0 MHz	-	20.23	16.15
D	LTE: QPSK	5.0 MHz	-	21.09	16.15
Total			-	26.87	22.17
A	LTE: QPSK	10.0 MHz	9.50	20.60	12.39
B	LTE: QPSK	10.0 MHz	-	20.21	12.39
C	LTE: QPSK	10.0 MHz	-	19.65	12.39
D	LTE: QPSK	10.0 MHz	-	20.16	12.39
Total			-	26.19	18.41
A	LTE: QPSK	15.0 MHz	9.49	20.58	10.66
B	LTE: QPSK	15.0 MHz	-	20.24	10.66
C	LTE: QPSK	15.0 MHz	-	19.75	10.66
D	LTE: QPSK	15.0 MHz	-	20.07	10.66
Total			-	26.19	16.68
A	LTE: QPSK	20.0 MHz	9.38	20.45	9.01
B	LTE: QPSK	20.0 MHz	-	20.28	9.01
C	LTE: QPSK	20.0 MHz	-	19.91	9.01
D	LTE: QPSK	20.0 MHz	-	20.15	9.01
Total			-	26.22	15.03
A	NR: QPSK	5.0 MHz	9.23	21.81	15.23
B	NR: QPSK	5.0 MHz	-	20.17	15.23
C	NR: QPSK	5.0 MHz	-	19.48	15.23
D	NR: QPSK	5.0 MHz	-	20.15	15.23
Total			-	26.51	21.25
A	NR: QPSK	10.0 MHz	9.29	20.70	12.20
B	NR: QPSK	10.0 MHz	-	20.30	12.20
C	NR: QPSK	10.0 MHz	-	19.52	12.20
D	NR: QPSK	10.0 MHz	-	20.11	12.20
Total			-	26.20	18.22
A	NR: QPSK	15.0 MHz	9.36	20.62	10.39
B	NR: QPSK	15.0 MHz	-	20.34	10.39
C	NR: QPSK	15.0 MHz	-	19.90	10.39
D	NR: QPSK	15.0 MHz	-	20.19	10.39
Total			-	26.29	16.41
A	NR: QPSK	20.0 MHz	9.83	21.51	10.24
B	NR: QPSK	20.0 MHz	-	21.22	10.24
C	NR: QPSK	20.0 MHz	-	20.76	10.24
D	NR: QPSK	20.0 MHz	-	21.15	10.24
Total			-	27.19	16.26



## Remarks

1. Transmitter performance was measured for top, mid & bottom channels across all 4 antenna ports as represented in the average power measurement tables. Maximum power performance was determined to be antenna port A.
2. The plot results presented represent typical performance for all bands and antenna ports based on transmitter port A performance.
3. Plot data performance are on file and available on request.
4. An NB-IoT GB carrier is included in the 10MHz LTE RAT for evaluation as part of this submission.
5. Antenna gain for this LPRU 4420 is 0 dBi. The EIRP is equal to the total carrier power.

## Antenna Port A Carrier Power - Modulation LTE: QPSK - Carrier Bandwidth 5.0 MHz - Channel Position B

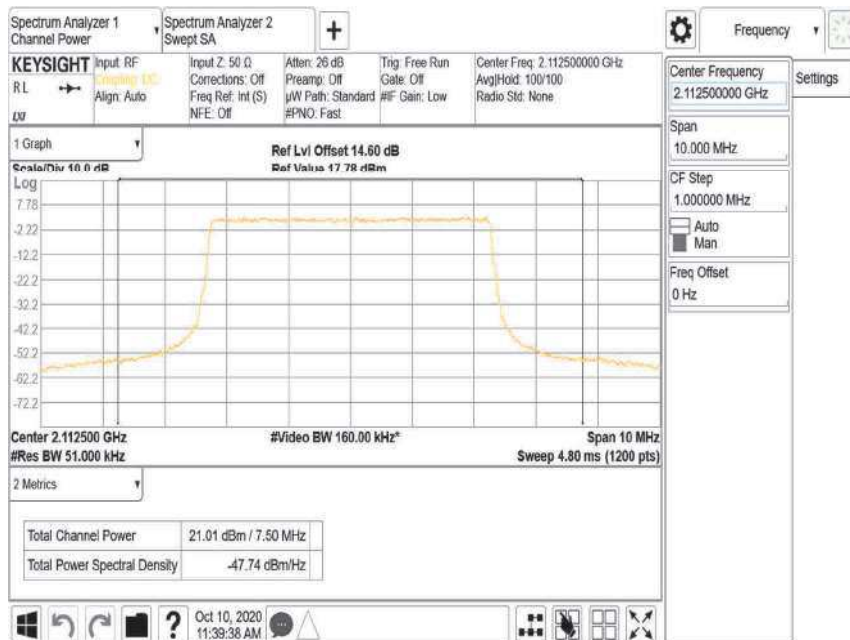



Antenna Port A Pk-Av Ratio - Modulation LTE: QPSK - Carrier Bandwidth 5.0 MHz - Channel Position B



Antenna Port A PSD - Modulation LTE: QPSK - Carrier Bandwidth 5.0 MHz - Channel Position B

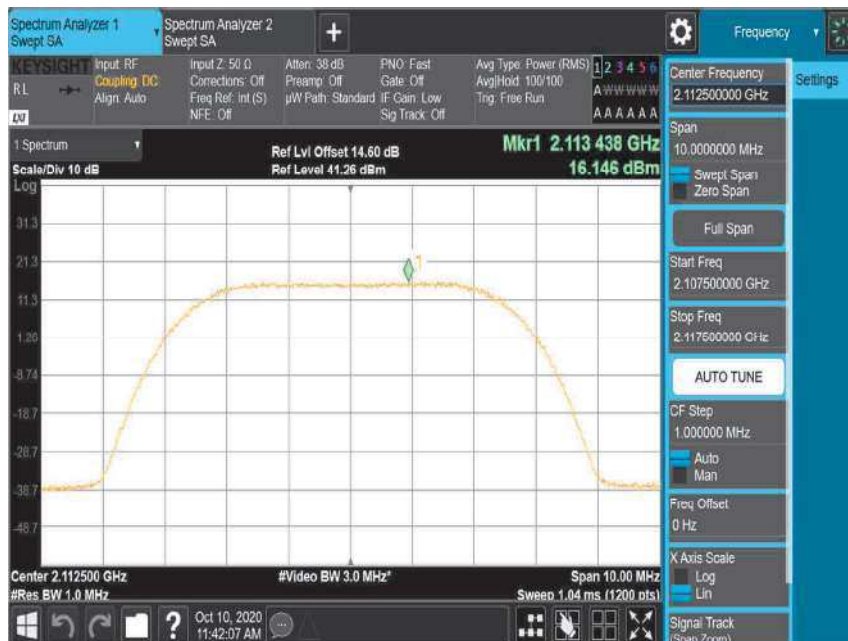





**Antenna Port A Carrier Power - Modulation LTE: QPSK - Carrier Bandwidth 10.0 MHz - Channel Position B**



**Antenna Port A Pk-Av Ratio - Modulation LTE: QPSK - Carrier Bandwidth 10.0 MHz - Channel Position B**

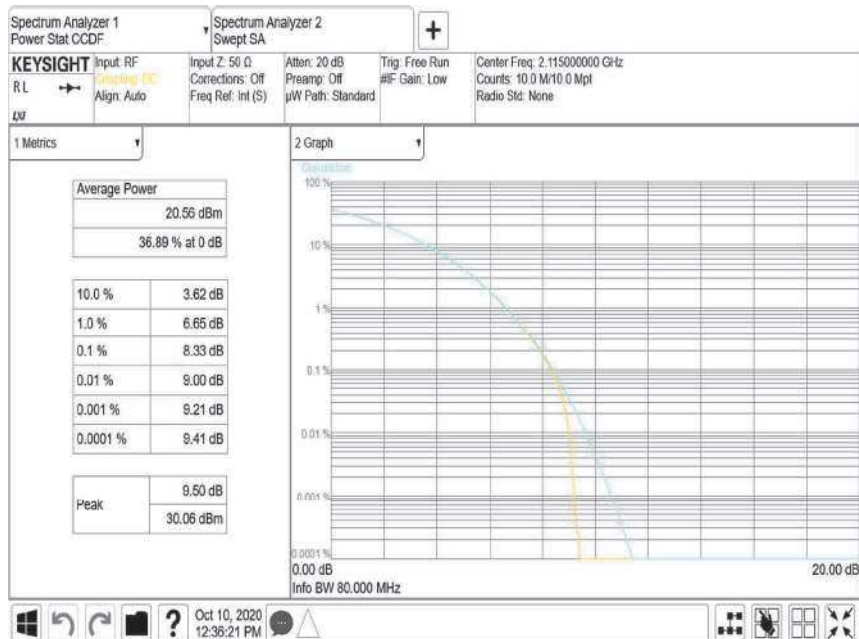



Antenna Port A PSD - Modulation LTE: QPSK - Carrier Bandwidth 10.0 MHz - Channel Position B

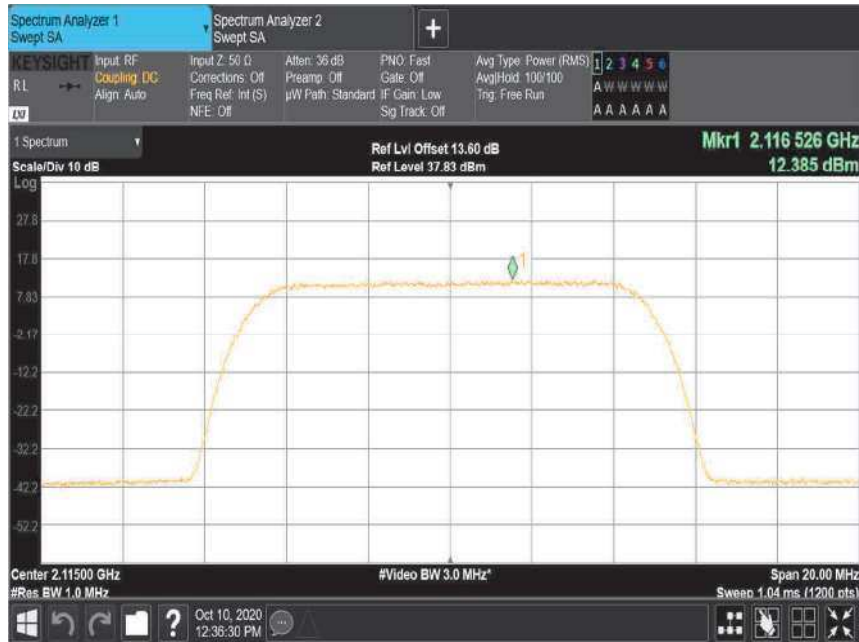

Antenna Port A Carrier Power - Modulation LTE: QPSK - Carrier Bandwidth 15.0 MHz - Channel Position B

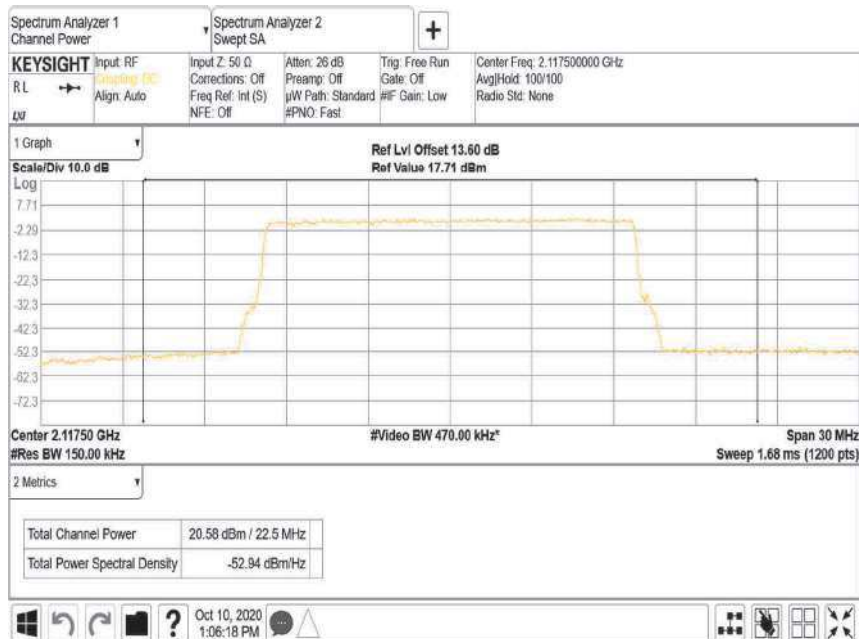



**Antenna Port A Pk-Av Ratio - Modulation LTE: QPSK - Carrier Bandwidth 15.0 MHz - Channel Position B**

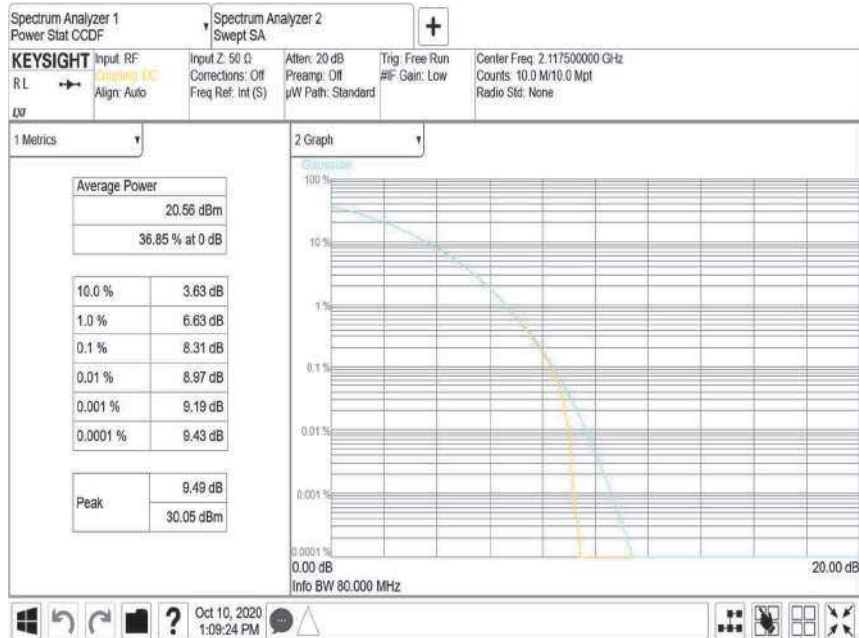

**Antenna Port A PSD - Modulation LTE: QPSK - Carrier Bandwidth 15.0 MHz - Channel Position B**





**Antenna Port A Carrier Power - Modulation LTE: QPSK - Carrier Bandwidth 20.0 MHz - Channel Position B**

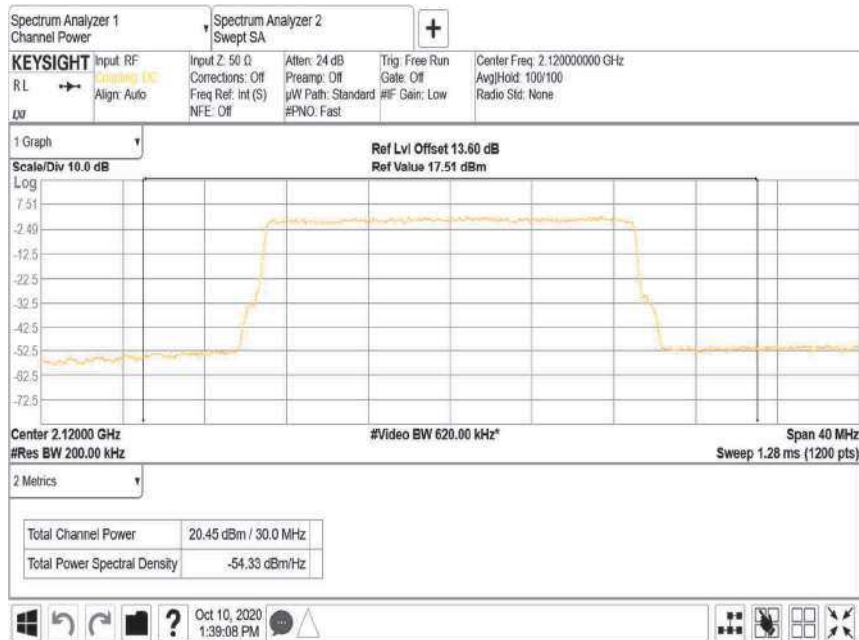

**Antenna Port A Pk-Av Ratio - Modulation LTE: QPSK - Carrier Bandwidth 20.0 MHz - Channel Position B**

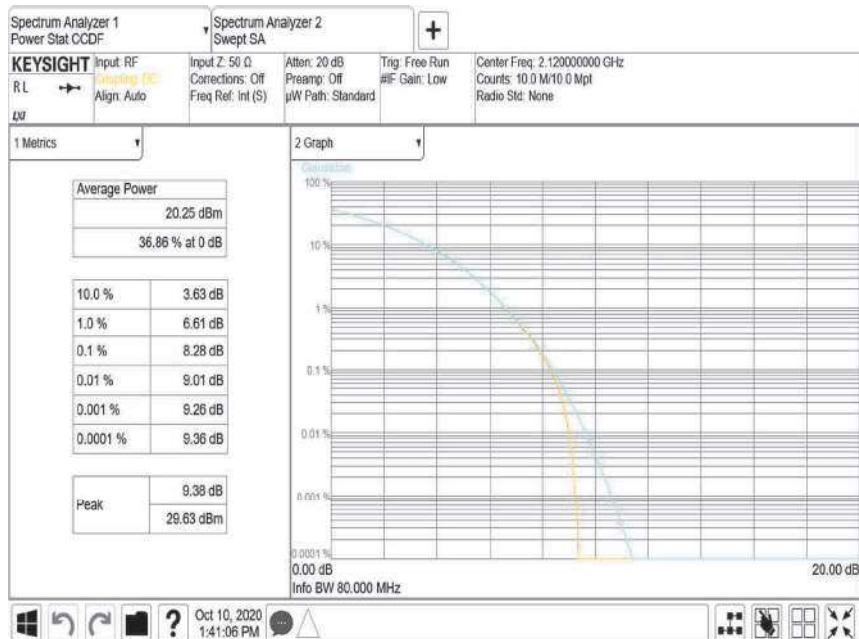



**Antenna Port A PSD - Modulation LTE: QPSK - Carrier Bandwidth 20.0 MHz - Channel Position B**



**Antenna Port A Carrier Power - Modulation NR: QPSK - Carrier Bandwidth 5.0 MHz - Channel Position B**

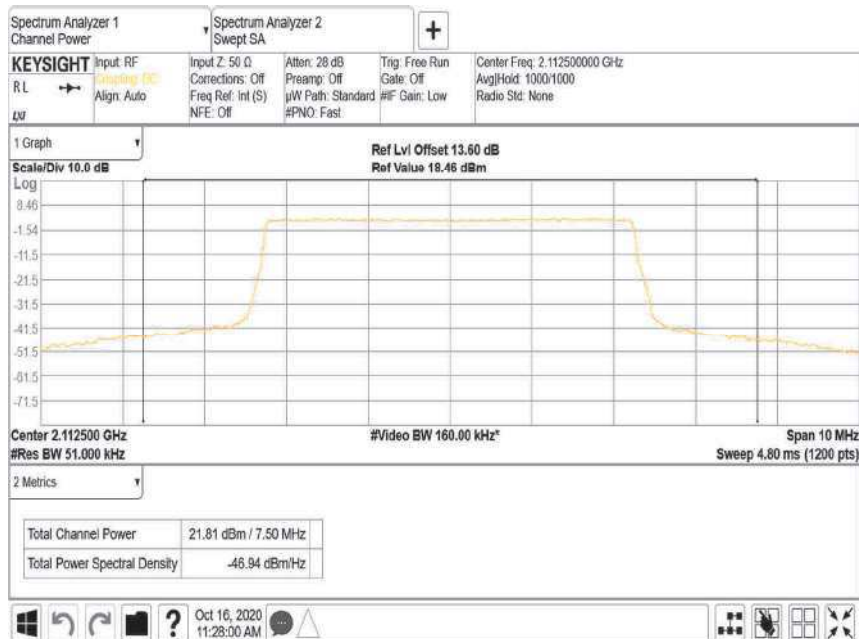



**Antenna Port A Pk-Av Ratio - Modulation NR: QPSK - Carrier Bandwidth 5.0 MHz - Channel Position B**



**Antenna Port A PSD - Modulation NR: QPSK - Carrier Bandwidth 5.0 MHz - Channel Position B**







**Antenna Port A Carrier Power - Modulation NR: QPSK - Carrier Bandwidth 10.0 MHz - Channel Position B**

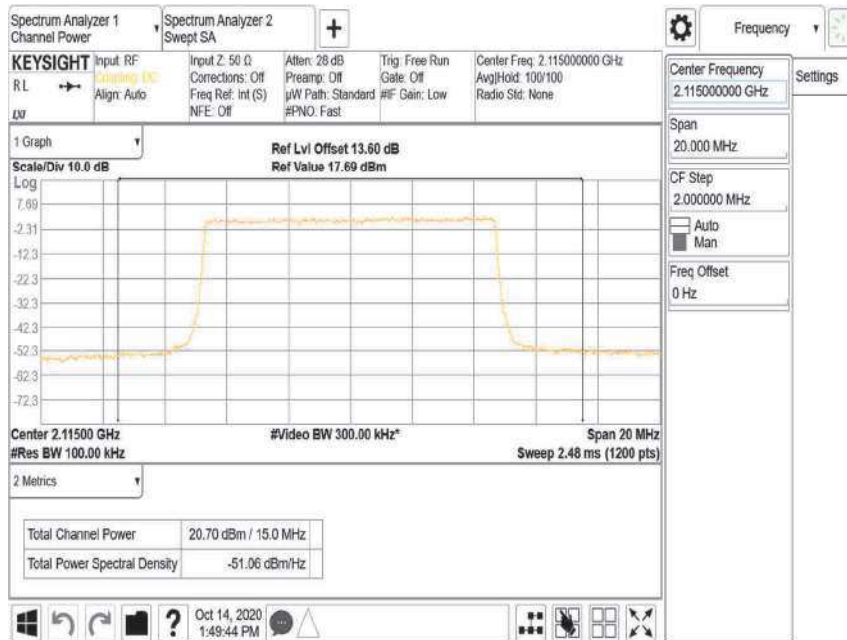

**Antenna Port A Pk-Av Ratio - Modulation NR: QPSK - Carrier Bandwidth 10.0 MHz - Channel Position B**





Antenna Port A PSD - Modulation NR: QPSK - Carrier Bandwidth 10.0 MHz - Channel Position B

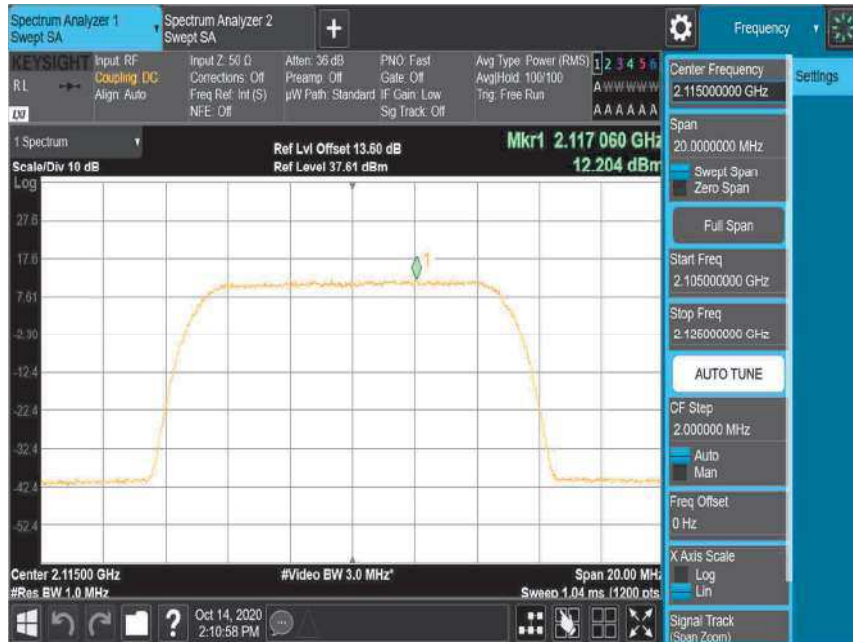

Antenna Port A Carrier Power - Modulation NR: QPSK - Carrier Bandwidth 15.0 MHz - Channel Position B

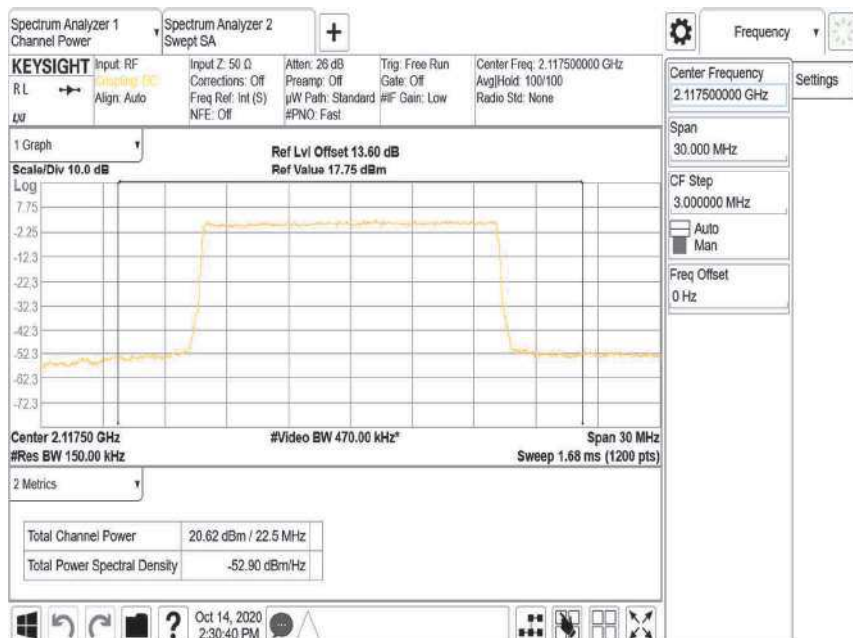





**Antenna Port A Pk-Av Ratio - Modulation NR: QPSK - Carrier Bandwidth 15.0 MHz - Channel Position B**



**Antenna Port A PSD - Modulation NR: QPSK - Carrier Bandwidth 15.0 MHz - Channel Position B**

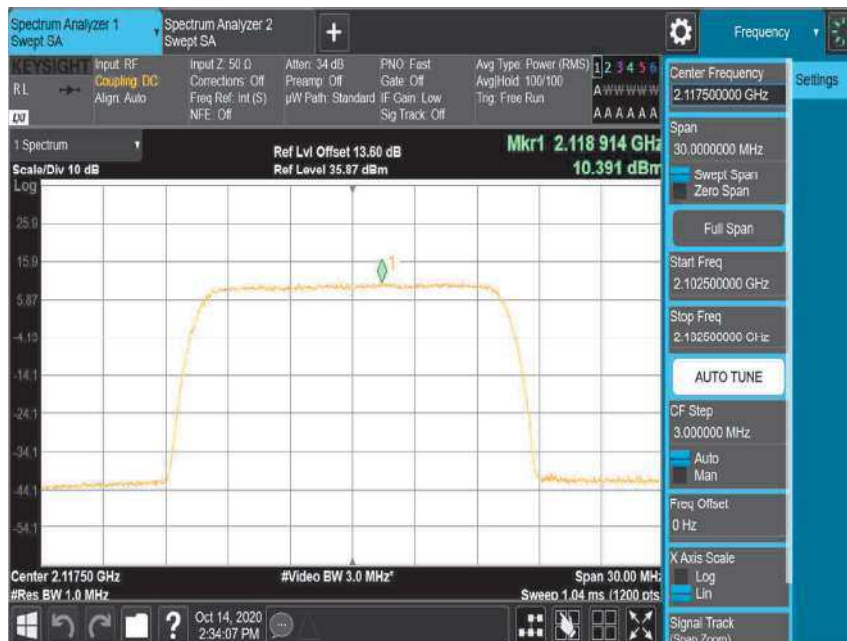



**Antenna Port A Carrier Power - Modulation NR: QPSK - Carrier Bandwidth 20.0 MHz - Channel Position B**

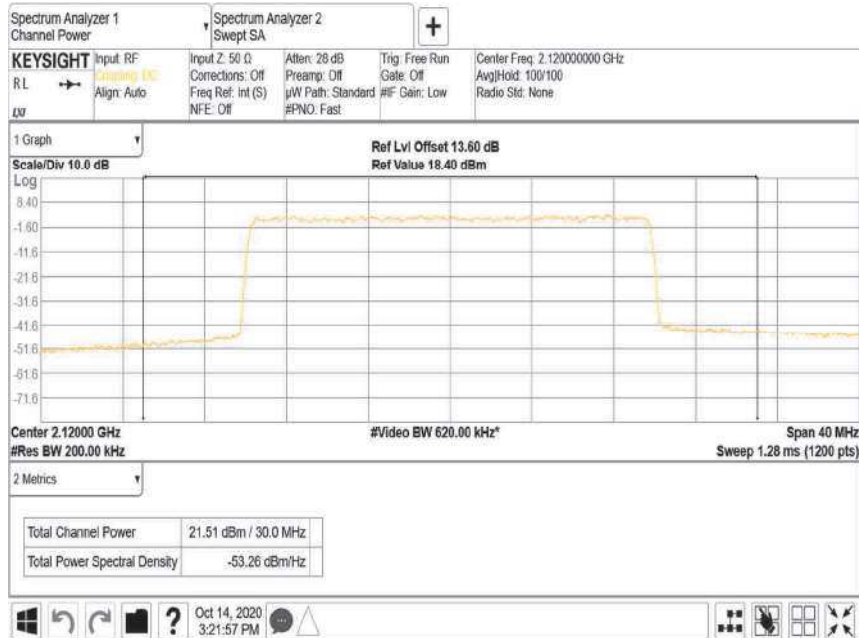

**Antenna Port A Pk-Av Ratio - Modulation NR: QPSK - Carrier Bandwidth 20.0 MHz - Channel Position B**

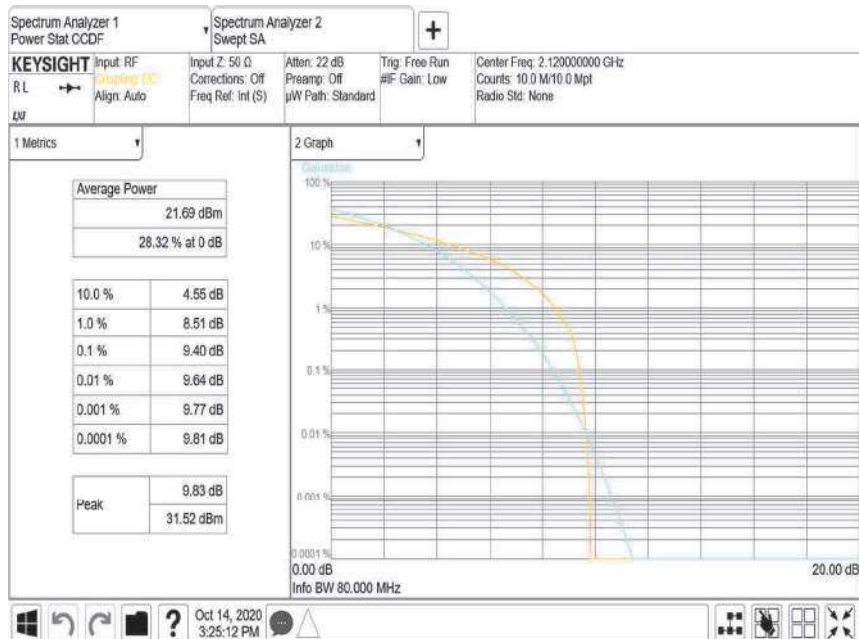



Antenna Port A PSD - Modulation NR: QPSK - Carrier Bandwidth 20.0 MHz - Channel Position B

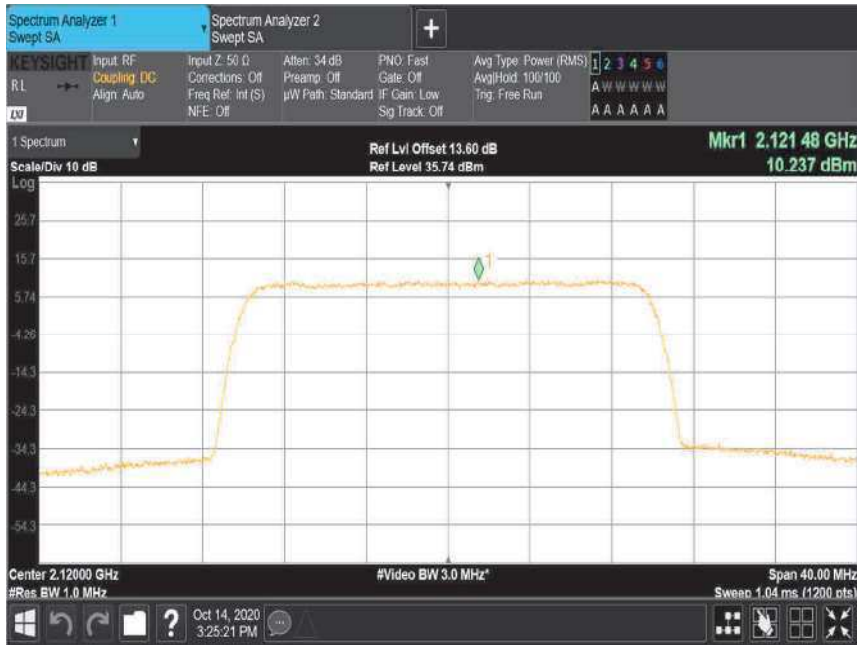



Configuration A

Maximum Output Power 22 dBm / Port

Antenna	Modulation	Carrier Bandwidth	Peak to Average Ratio (PAR) / Output Power		
			Channel Position M		
			PAR (dB)	Average Power	
			dBm	dBm/MHz	
A	LTE: QPSK	5.0 MHz	9.17	22.42	16.88
B	LTE: QPSK	5.0 MHz	-	22.58	16.88
C	LTE: QPSK	5.0 MHz	-	21.23	16.88
D	LTE: QPSK	5.0 MHz	-	22.36	16.88
Total			-	28.20	22.90
A	LTE: QPSK	10.0 MHz	9.34	21.37	12.76
B	LTE: QPSK	10.0 MHz	-	21.44	12.76
C	LTE: QPSK	10.0 MHz	-	19.97	12.76
D	LTE: QPSK	10.0 MHz	-	21.25	12.76
Total			-	27.07	18.78
A	LTE: QPSK	15.0 MHz	9.32	21.12	11.04
B	LTE: QPSK	15.0 MHz	-	21.20	11.04
C	LTE: QPSK	15.0 MHz	-	20.15	11.04
D	LTE: QPSK	15.0 MHz	-	21.12	11.04
Total			-	26.94	17.06
A	LTE: QPSK	20.0 MHz	9.38	21.36	9.85
B	LTE: QPSK	20.0 MHz	-	21.34	9.85
C	LTE: QPSK	20.0 MHz	-	20.28	9.85
D	LTE: QPSK	20.0 MHz	-	21.27	9.85
Total			-	27.11	15.87
A	NR: QPSK	5.0 MHz	9.16	21.69	16.07
B	NR: QPSK	5.0 MHz	-	21.69	16.07
C	NR: QPSK	5.0 MHz	-	19.81	16.07
D	NR: QPSK	5.0 MHz	-	21.44	16.07
Total			-	27.24	22.09
A	NR: QPSK	10.0 MHz	9.14	21.42	12.60
B	NR: QPSK	10.0 MHz	-	21.56	12.60
C	NR: QPSK	10.0 MHz	-	20.27	12.60
D	NR: QPSK	10.0 MHz	-	21.29	12.60
Total			-	27.18	18.62
A	NR: QPSK	15.0 MHz	9.32	22.60	12.23
B	NR: QPSK	15.0 MHz	-	22.68	12.23
C	NR: QPSK	15.0 MHz	-	20.38	12.23
D	NR: QPSK	15.0 MHz	-	22.70	12.23
Total			-	28.21	18.25
A	NR: QPSK	20.0 MHz	9.83	21.72	10.22
B	NR: QPSK	20.0 MHz	-	21.83	10.22
C	NR: QPSK	20.0 MHz	-	20.74	10.22
D	NR: QPSK	20.0 MHz	-	21.84	10.22
Total			-	27.58	16.24



Antenna Port A Carrier Power - Modulation LTE: QPSK - Carrier Bandwidth 5.0 MHz - Channel Position M

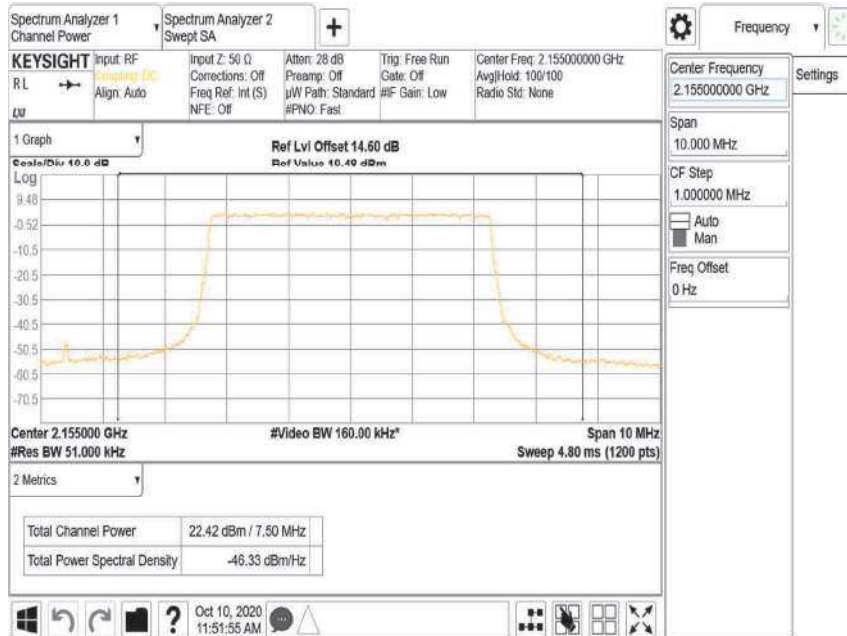



**Antenna Port A Pk-Av Ratio - Modulation LTE: QPSK - Carrier Bandwidth 5.0 MHz - Channel Position M**

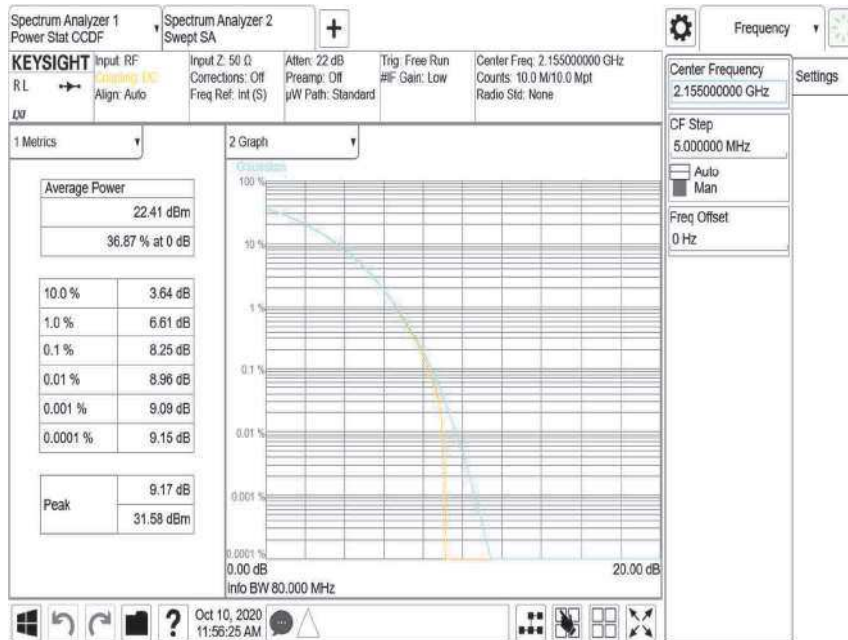

**Antenna Port A PSD - Modulation LTE: QPSK - Carrier Bandwidth 5.0 MHz - Channel Position M**





**Antenna Port A Carrier Power - Modulation LTE: QPSK - Carrier Bandwidth 10.0 MHz - Channel Position M**



**Antenna Port A Pk-Av Ratio - Modulation LTE: QPSK - Carrier Bandwidth 10.0 MHz - Channel Position M**

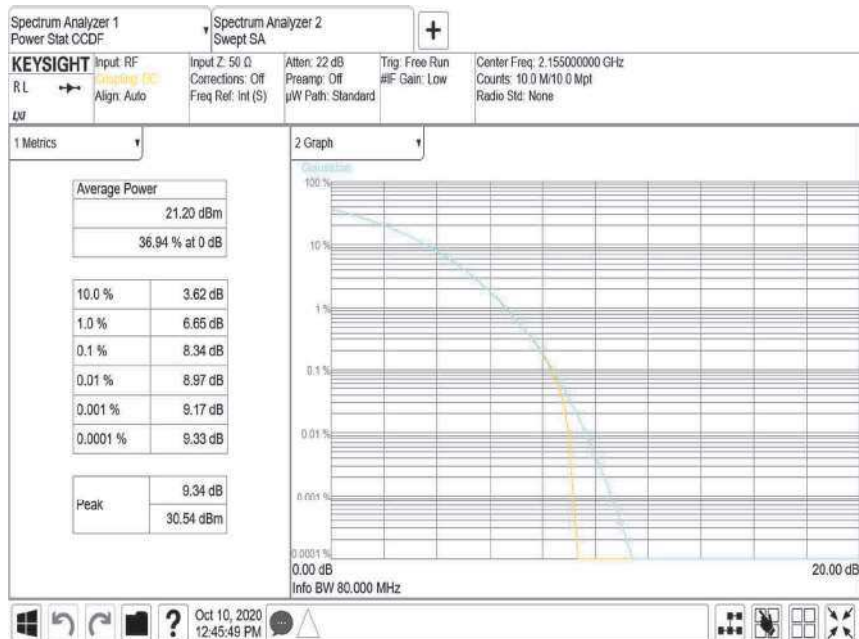





**Antenna Port A PSD - Modulation LTE: QPSK - Carrier Bandwidth 10.0 MHz - Channel Position M**



**Antenna Port A Carrier Power - Modulation LTE: QPSK - Carrier Bandwidth 15.0 MHz - Channel Position M**

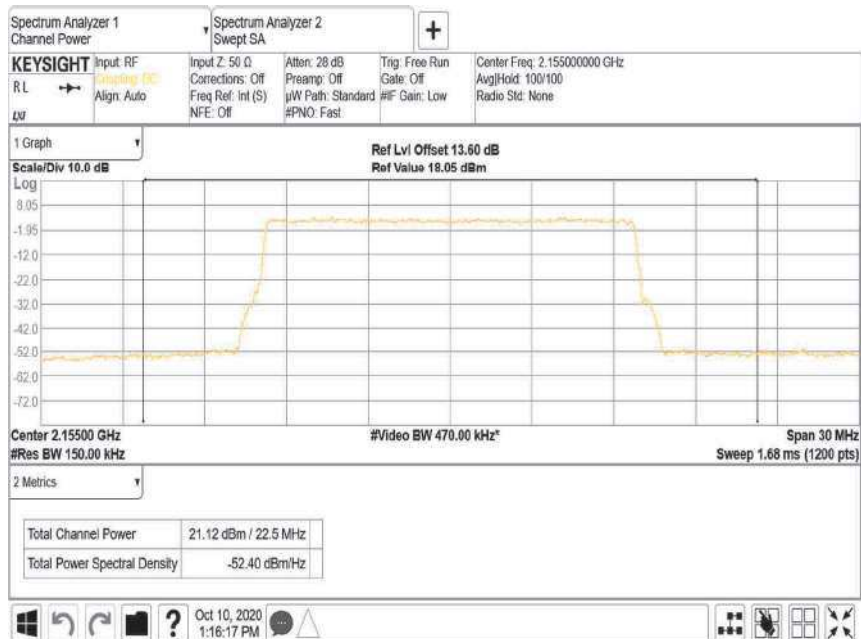





**Antenna Port A Pk-Av Ratio - Modulation LTE: QPSK - Carrier Bandwidth 15.0 MHz - Channel Position M**

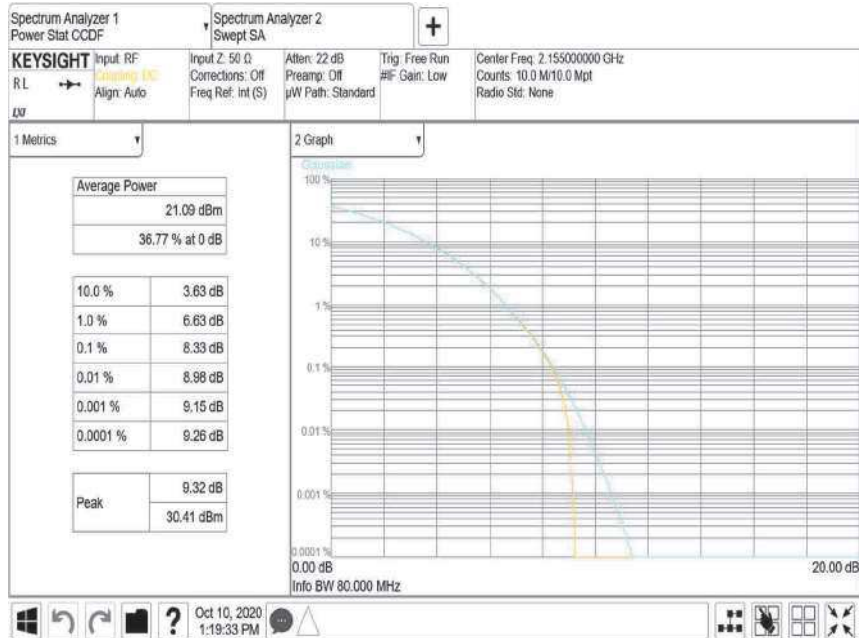

**Antenna Port A PSD - Modulation LTE: QPSK - Carrier Bandwidth 15.0 MHz - Channel Position M**





**Antenna Port A Carrier Power - Modulation LTE: QPSK - Carrier Bandwidth 20.0 MHz - Channel Position M**

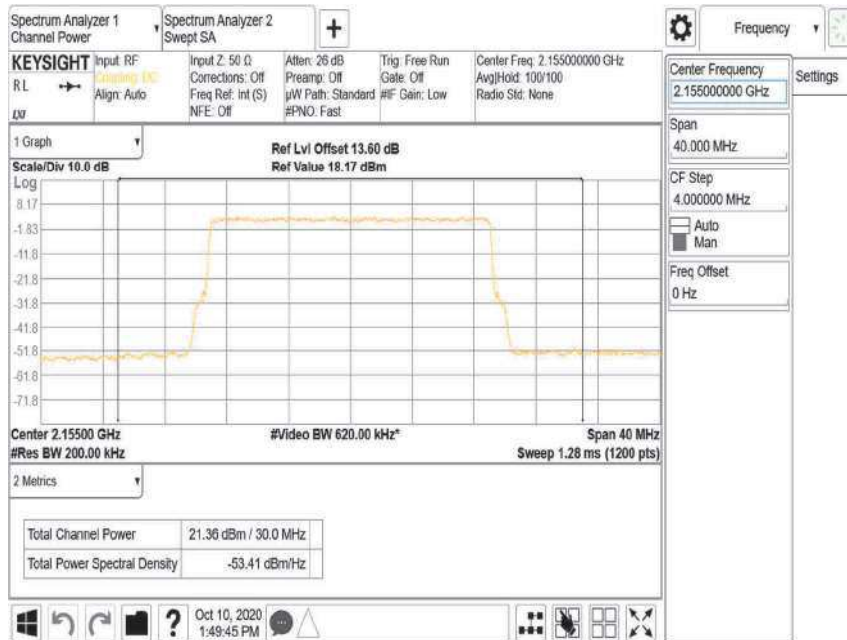

**Antenna Port A Pk-Av Ratio - Modulation LTE: QPSK - Carrier Bandwidth 20.0 MHz - Channel Position M**

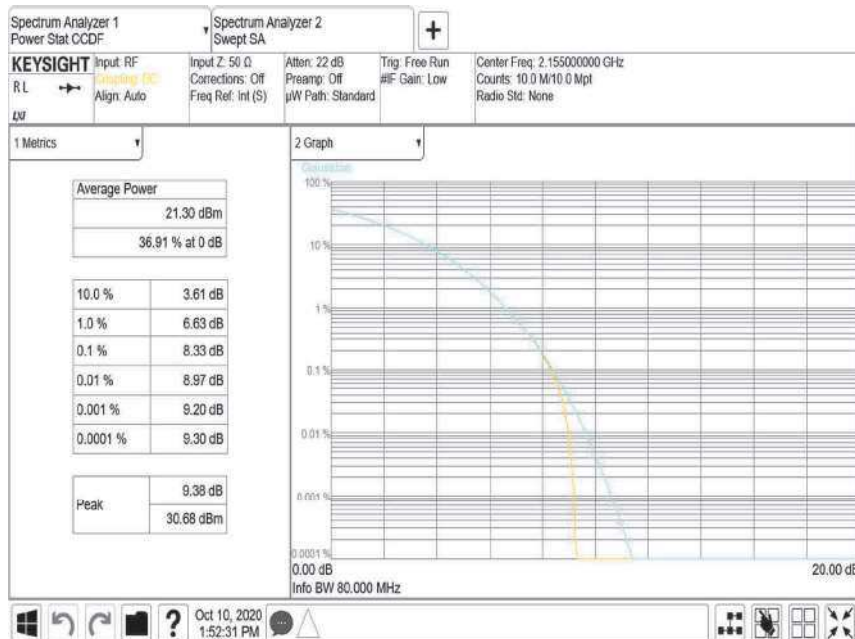



**Antenna Port A PSD - Modulation LTE: QPSK - Carrier Bandwidth 20.0 MHz - Channel Position M**



**Antenna Port A Carrier Power - Modulation NR: QPSK - Carrier Bandwidth 5.0 MHz - Channel Position M**

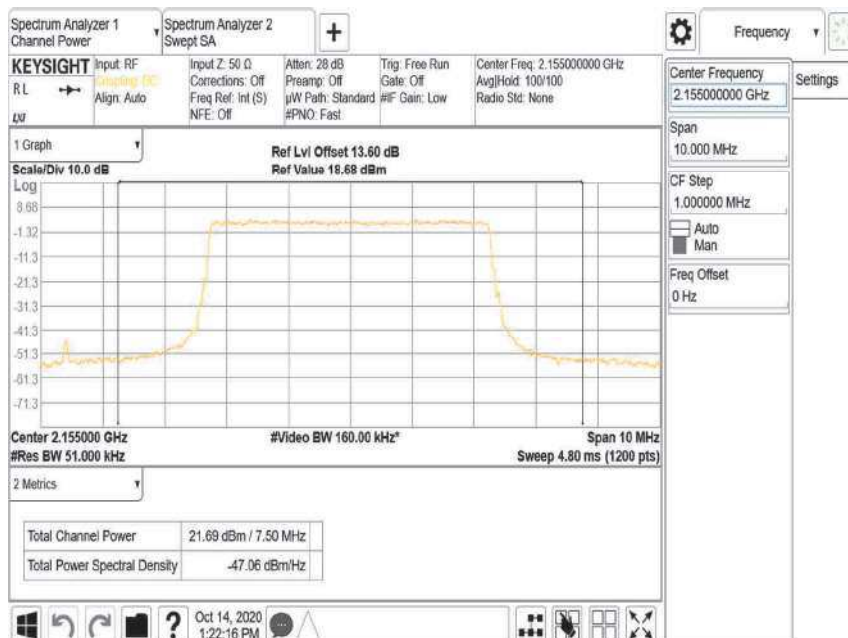



Antenna Port A Pk-Av Ratio - Modulation NR: QPSK - Carrier Bandwidth 5.0 MHz - Channel Position M



Antenna Port A PSD - Modulation NR: QPSK - Carrier Bandwidth 5.0 MHz - Channel Position M

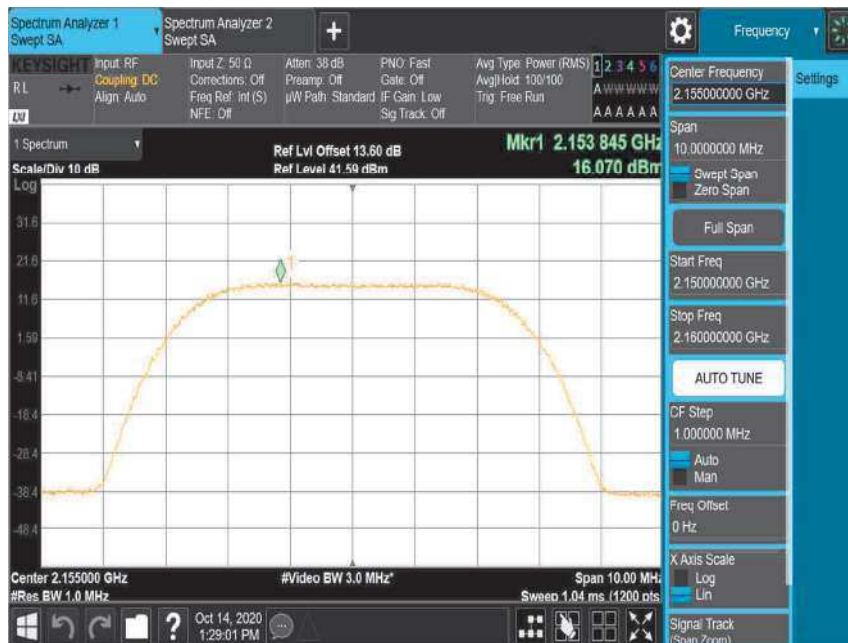



**Antenna Port A Carrier Power - Modulation NR: QPSK - Carrier Bandwidth 10.0 MHz - Channel Position M**

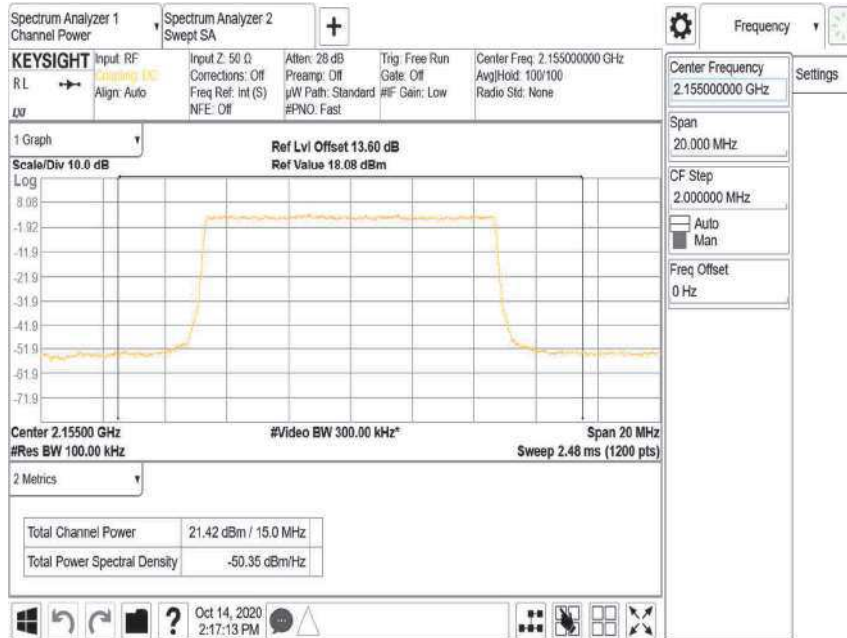

**Antenna Port A Pk-Av Ratio - Modulation NR: QPSK - Carrier Bandwidth 10.0 MHz - Channel Position M**







### Antenna Port A PSD - Modulation NR: QPSK - Carrier Bandwidth 10.0 MHz - Channel Position M



### Antenna Port A Carrier Power - Modulation NR: QPSK - Carrier Bandwidth 15.0 MHz - Channel Position M

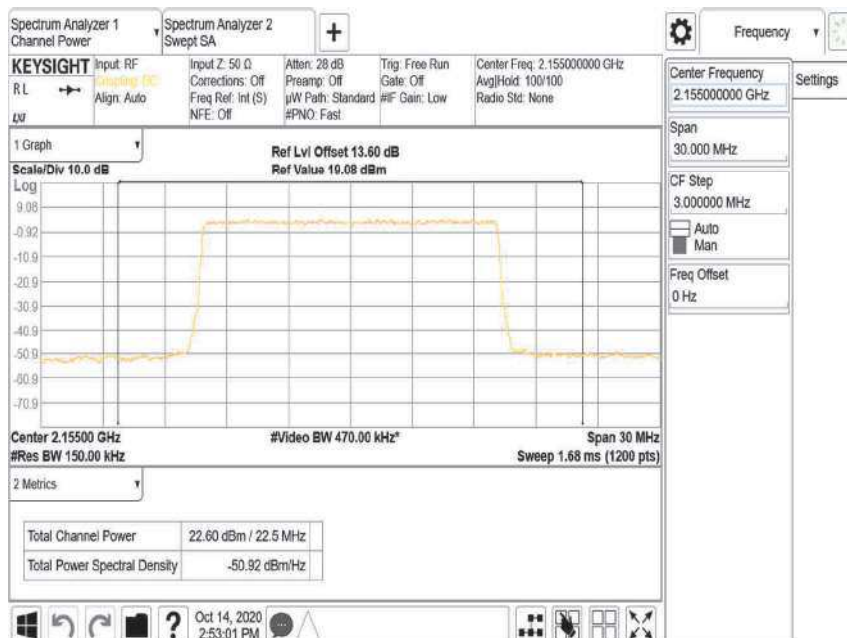



**Antenna Port A Pk-Av Ratio - Modulation NR: QPSK - Carrier Bandwidth 15.0 MHz - Channel Position M**



**Antenna Port A PSD - Modulation NR: QPSK - Carrier Bandwidth 15.0 MHz - Channel Position M**

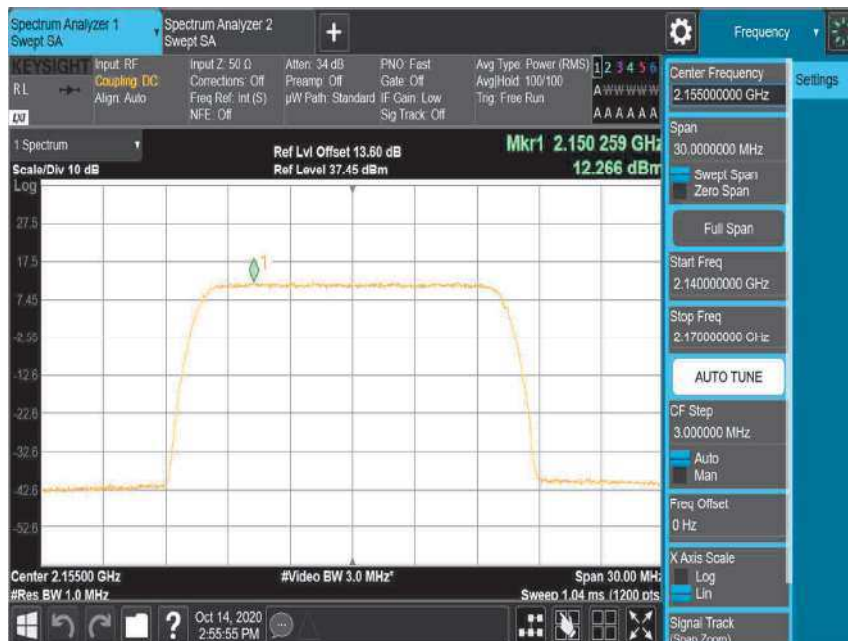



**Antenna Port A Carrier Power - Modulation NR: QPSK - Carrier Bandwidth 20.0 MHz - Channel Position M**

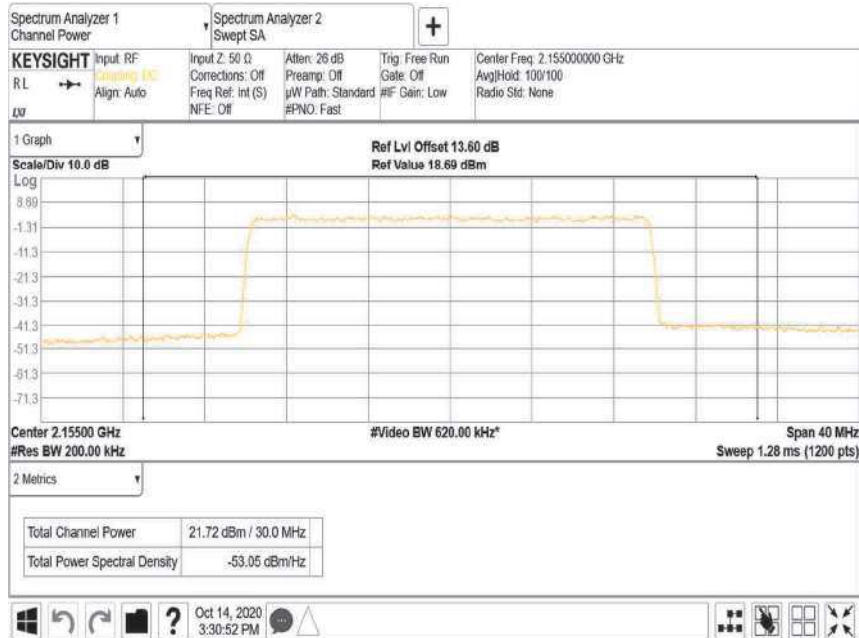

**Antenna Port A Pk-Av Ratio - Modulation NR: QPSK - Carrier Bandwidth 20.0 MHz - Channel Position M**

