



Add value.
Inspire trust.



Report On

FCC and ISED Testing of the Ericsson Radio 4478 B12A, KRC 161 881/3 NR (700 MHz) Base Station in accordance with FCC CFR 47 Part 2, FCC CFR 47 Part 27, ISED RSS-GEN and ISED RSS-130

COMMERCIAL-IN-CONFIDENCE

FCC: TA8AKRC161881-3

IC: 287AB-AS1618813

PREPARED BY

Maggie Whiting
Key Account Manager

APPROVED BY

Steve Scarfe
Authorised Signatory

DATED

16 February 2022

Document 75953954 Report 11 Issue 1

February 2022



CONTENTS

Section	Page No
1	REPORT INFORMATION 2
1.1	Report Details 3
1.2	Brief Summary of Results 4
1.3	Test Rationale..... 5
1.4	Configuration Description 6
1.5	Declaration of Build Status 7
1.6	Product Information 9
1.7	Test Setup 10
1.8	Test Conditions..... 12
1.9	Deviation From The Standard 12
1.10	Modification Record 12
1.11	Additional Information 12
2	TEST DETAILS 13
2.1	Maximum Peak Output Power and Peak to Average Ratio - Conducted..... 14
2.2	Occupied Bandwidth..... 20
2.3	Band Edge 25
2.4	Transmitter Spurious Emissions 28
2.5	Radiated Emissions 38
3	TEST EQUIPMENT USED 42
3.1	Test Equipment Used 43
3.2	Measurement Uncertainty 45
3.3	Measurement Software Used 46
4	ACCREDITATION, DISCLAIMERS AND COPYRIGHT..... 47
4.1	Accreditation, Disclaimers and Copyright..... 48
ANNEX A	Module Lists.....A.2



SECTION 1

REPORT INFORMATION



1.1 REPORT DETAILS

Manufacturer	Ericsson
Address	Torshamnsgatan 23 Kista SE-16480 Stockholm Sweden
Product Name & Product Number	Radio 4478 B12A - KRC 161 881/3
IC Model Name	AS1618813
Serial Number(s)	DY3E001456
Software Version	CXP9013268/15 Revision R89AJ
Hardware Version	R1B
Test Specification/Issue/Date	FCC CFR 47 Part 2: 2020 FCC CFR 47 Part 27: 2020 ISED RSS-GEN: Issue 5: March 2019 Amendment 1, 2021 Amendment 2 ISED RSS-130: Issue 2: 2019
Test Plan	Q1 2022 FCC_IC test plan for MR7602-1 NR-IoT V 1.1
Start of Test	23-December-2021
Finish of Test	11-January-2022
Name of Engineer(s)	Neil Rousell, Paul Dickson, Graeme Lawler
Related Document(s)	KDB 971168 D01 v02r02 KDB 662911 D01 v02r01 ICES-003:Issue 7 (2020-10) ANSI C63.26-2015

ENGINEERING STATEMENT

The measurements shown in this report were made in accordance with the procedures described on test pages. All reported testing was carried out on a sample equipment to demonstrate compliance with and FCC CFR 47 Part 2: 2020, FCC CFR 47 Part 27: 2020, ISED RSS-GEN: Issue 5: March 2019 Amendment 1, 2021 Amendment 2, ISED RSS-130: Issue 2: 2019 The sample tested was found to comply with the requirements defined in the applied rules.

Test Engineer(s);

Neil Rousell, Paul Dickson, Graeme Lawler



1.2 BRIEF SUMMARY OF RESULTS

A brief summary of results for each configuration, in accordance with FCC CFR 47 Part 2, FCC CFR 47 Part 27, ISED RSS-GEN and ISED RSS-130 is shown below.

Section	Specification Clause				Test Description	Result
	FCC CFR 47 Part 2	FCC CFR 47 Part 27	RSS-GEN	ISED RSS-130		
2.1	2.1046	27.50	-	4.6	Maximum Peak Output Power and Peak to Average Ratio - Conducted	Pass
2.2	2.1049	27.53	-	-	Occupied Bandwidth	Pass
2.3	2.1051	27.53	-	-	Band Edge	Pass
2.4	2.1051	27.53	-	4.7	Transmitter Spurious Emissions	Pass
2.5	2.1053	27.53	-	-	Radiated Emissions	Pass



1.3 TEST RATIONALE

The tests that have been selected are detailed in the customer Test Plan as defined in section 1.1 of this report. The Test Plan is based on the TÜV SÜD FCC Test Plan Rationale, available on request.



1.4 CONFIGURATION DESCRIPTION

Configuration Number	Band	RATs	Carriers	Pout (W)	NR Main carrier			
					Position	BW	Freq	NR-ARFCN
1	B12A	NR in NR/ESS Setup (NB IoT IB) 15 kHz SCS, QPSK	1	40	B	10	734	146800
	B12A				M	10	737	147400
	B12A				T	10	740	148000
	B12A				B	15	736.5	147300
	B12A				M	15	737	147400
	B12A				T	15	737.5	147500
	B12A				T	10	740	148000



1.5 DECLARATION OF BUILD STATUS

Equipment Description		
Technical Description: (Please provide a brief description of the intended use of the equipment including the technologies the product supports)	Multi-standard remote radio unit Radio 4478 B12A, 4Tx and 4Rx	
Manufacturer:	Ericsson AB	
Model:	Radio 4478 B12A	
Part Number:	KRC 161 881/3	
Hardware Version:	R1B	
Software Version:	CXP9013268/15 Revision R89AJ	
FCC ID of the product under test	TA8AKRC161881-3	
IC ID of the product under test	287AB-AS1618813	
Intentional Radiators		
Frequency Range (MHz to MHz) B12A :LTE ,NR	TX (DL): 729 - 745 MHz RX (UL): 699 - 715 MHz	BW: 16MHz BW: 16MHz
Conducted Declared Output Power (dBm)	46.0 Max output power per port 40 W	
RAT SC carrier Power (Max) :NR	BW	PWR/Carrier(Max)
	10MHz	40 W
	15MHz	40W
Radio Configuration:	4 RX / 4TX	
Duplex mode:	FDD	
Radio Access Technology, RAT(s):	Single RAT : LTE, NR, NB-IoT (IB, GB, SA) Multi RAT :LTE+ NR; LTE+ NR+NB-IoT; NR+NB-IoT	
Supported Bandwidth(s) (MHz)	NR: 5MHz, 10MHz, 15MHz LTE: 5MHz, 10MHz, 15MHz	
Antenna Gain (dBi)	14,9 (B12A)	
Antenna Impedance(Ω)	50	
Supported modulation scheme, LTE:	QPSK, 16QAM, 64QAM, 256QAM	
Supported modulation scheme, NR:	QPSK, 16QAM, 64QAM, 256QAM	
Supported modulation scheme, NB-IoT :	QPSK	
NR SCS	15kHz	
RF power Tolerance:	.+0.6/-2.0 dB	
Frequency Tolerance:	\pm 0.05 ppm	
Carrier Aggregation, CA	Supported	
Maximum supported number of DL NR carrier per port	3/Band	
Maximum supported number of DL LTE carrier per port	3/Band	
Nominal output power per Antenna Port / Band	SRO / MRO: Single / Multi Carrier: 40W (46 dBm)	
Supported transmission modes:	4X4 MIMO	



Unintentional Radiators			
Highest frequency generated or used in the device or on which the device operates or tunes		Up to 10.1 Gbit/s	
Lowest frequency generated or used in the device or on which the device operates or tunes if <30MHz		.-	
Class A Digital Device (Use in commercial, industrial or business environment)		.-	
Class B Digital Device (Use in residential environment)		Class B	
DC Power Supply (Delete if Not Applicable)			
Nominal voltage:		-48V	
Extreme upper voltage:		-36V	
Extreme lower voltage:		-58.5V	
Max current:		30A	
Temperature			
Minimum temperature:		-40°C	
Maximum temperature:		55°C	
Ancillaries			
Manufacturer:	X	Part Number:	X
Model:	X	Model:	X
I hereby declare that I am entitled to sign on behalf of the manufacturer and that the information supplied is correct and complete.			
Name:	Afrah Ali sadiq		
Position held:	Regulatory Approval Engineer		
Email address:	Afrah.ali.sadiq@ericsson.com		
Telephone number:	.+46724650796		
Date:	16/02/2022		

No responsibility will be accepted by TÜV SÜD UK Limited as to the accuracy of the information declared in this document by the manufacturer.

1.6 PRODUCT INFORMATION

1.6.1 Technical Description

The Equipment Under Test (EUT) Radio 4478 B12A - KRC 161 881/3 is an Ericsson AB Radio Unit working in the public mobile service Band 12A band which provides communication connections to Band 12A network. The EUT operates from a -48V DC supply.

The Equipment Under Test (EUT) is shown in the photograph below. A full technical description can be found in the Manufacturer's documentation.



Equipment Under Test



1.7 TEST SETUP

Conducted Test Set Up

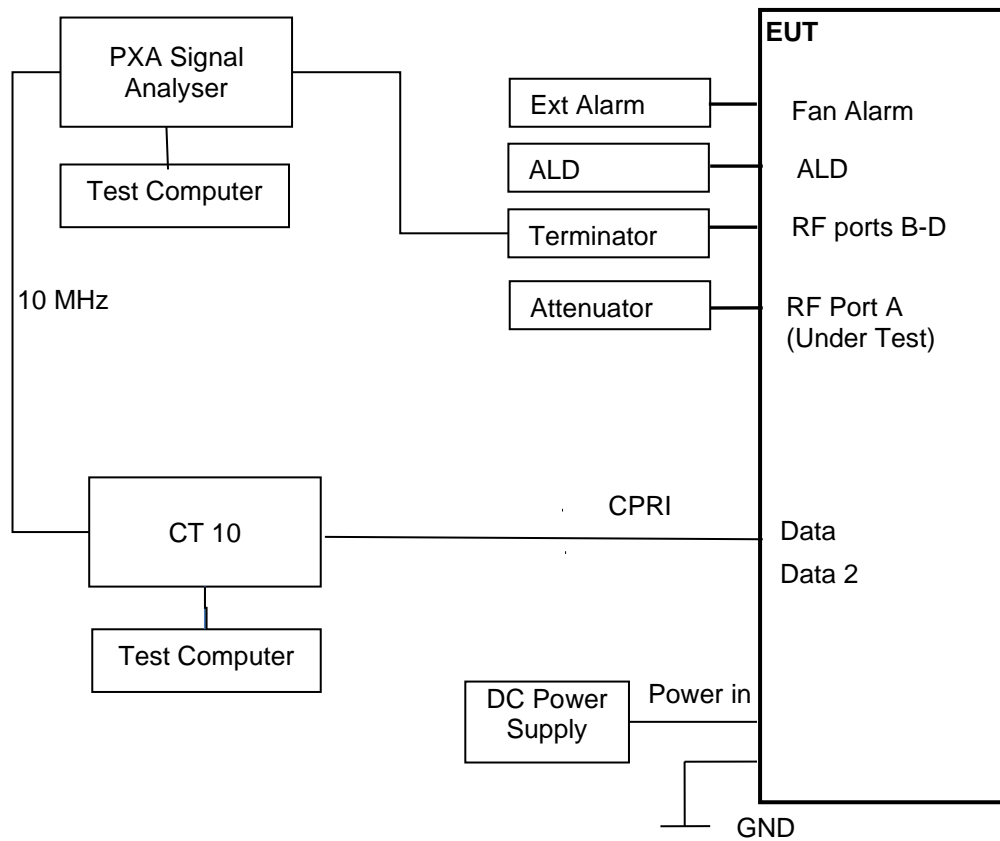



Radiated Test Set Up – Dashed line indicates equipment inside the Chamber for Radiated testing.

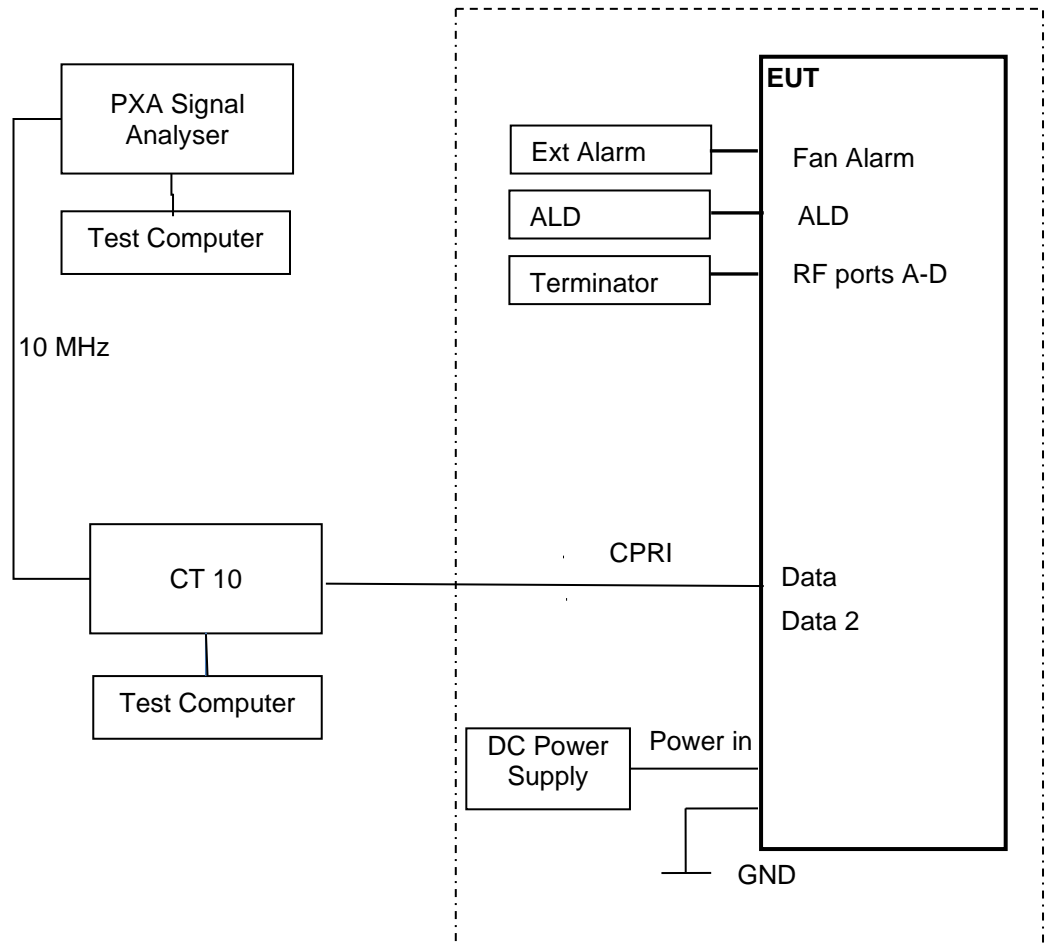



1.8 TEST CONDITIONS

For all tests the EUT was set up in accordance with the relevant test standard and to represent typical operating conditions. Tests were applied with the EUT situated as described in the Test Method for each Test.

The EUT was powered from a -48V DC supply.

FCC Measurement Facility Registration Number
90987 Octagon House, Fareham Test Laboratory
Postal Address: Octagon House, Concorde Way, Fareham, Hampshire, UK, PO15 5RL

Under our UKAS Accreditation, TÜV SÜD conducted the following tests Octagon House, Fareham Laboratory.

Test Name	Name of Engineer(s)
Maximum Peak Output Power and Peak to Average Ratio - Conducted	Neil Rousell
Occupied Bandwidth	Neil Rousell,
Band Edge	Neil Rousell
Transmitter Spurious Emissions	Neil Rousell
Radiated Emissions	Paul Dickinson, Graeme Lawler

1.9 DEVIATION FROM THE STANDARD

No deviations from the applicable test standards or test plan were made during testing.

1.10 MODIFICATION RECORD

No modifications were made to the EUT during testing.

1.11 ADDITIONAL INFORMATION

Ericsson will limit this product through the software from operating across the whole of Band 12, it will be limited to Band 12A.

This EUT uses the same port for Tx and Rx and therefore RX Spurious Emissions has not been performed.

Rx Spurious Emissions have been covered by testing to FCC Part 15B, which are covered by a separate test report.



SECTION 2

TEST DETAILS



2.1 MAXIMUM PEAK OUTPUT POWER AND PEAK TO AVERAGE RATIO - CONDUCTED

2.1.1 Specification Reference

FCC CFR 47 Part 27, Clause 27.50
 ISED RSS-130, Clause 4.6
 FCC CFR 47 Part 2, Clause 2.1046

2.1.2 Date of Test and Modification State

23-December-2021 - Modification State 0

2.1.3 Test Equipment Used

The major items of test equipment used for the above tests are identified in Section 3.1.

2.1.4 Environmental Conditions

Ambient Temperature 20.8°C
 Relative Humidity 40.3%

2.1.5 Test Method

All measurements were made in accordance with FCC KDB 971168 D01, clause 5.2.1 and summed in accordance with FCC KDB 662911 D01.

2.1.6 Test Results

Configuration 1

Maximum Output Power 46.00 dBm

Antenna	NR Modulation	NR Carrier Bandwidth	Peak to Average Ratio (PAR) / Output Power / PSD				
			Channel Position B				
			PAR (dB)	Average Power/PSD		Total Power Port A + B + C + D	Total Power Port A + B + C + D
dBm	dBm/MHz	dBm		dBm/MHz			
A	QPSK	10.0 MHz 15 kHz SCS	7.43	45.71	36.75	51.73	42.77
A	QPSK	15.0 MHz 15 kHz SCS	7.54	45.54	36.20	51.56	42.22

Remarks

Calculations: Total Power = Measured Output Power (port A, worst case) + 10log (NANT)
 Where NANT refers to the number of Ports. In this product = 4.



Antenna A - NR Modulation QPSK - NR Carrier Bandwidth 10.0 MHz 15 kHz SCS - Channel Position B

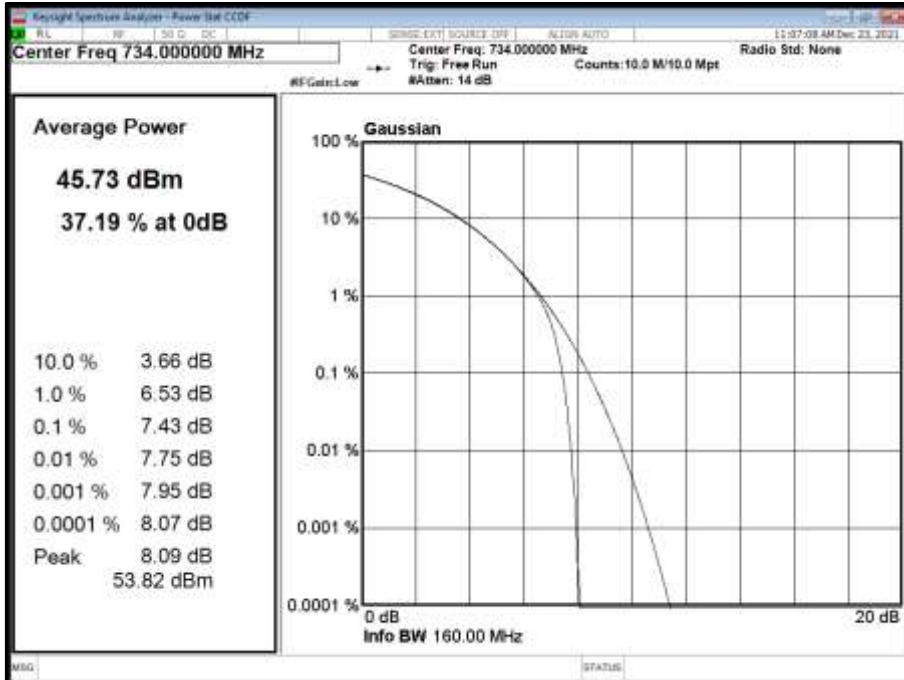

Antenna A - NR Modulation QPSK - NR Carrier Bandwidth 15.0 MHz 15 kHz SCS - Channel Position B

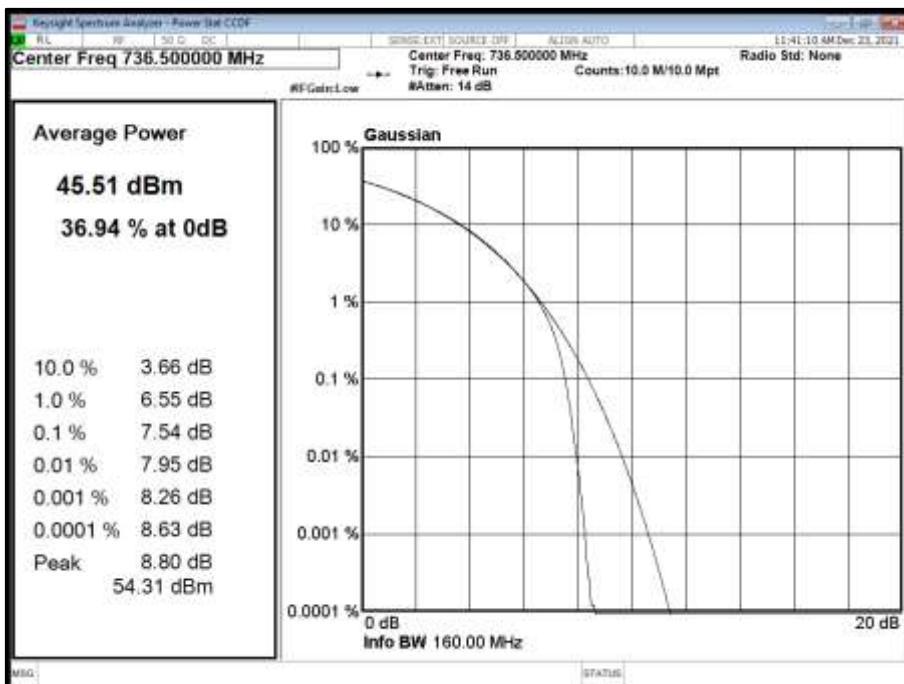



Configuration 1

Maximum Output Power 46.00 dBm

Antenna	NR Modulation	NR Carrier Bandwidth	Peak to Average Ratio (PAR) / Output Power / PSD				
			Channel Position M				
			PAR (dB)	Average Power/PSD		Total Power Port A + B + C + D	Total Power Port A + B + C + D
dBm	dBm/MHz	dBm		dBm/MHz			
A	QPSK	10.0 MHz 15 kHz SCS	7.34	45.69	36.69	51.71	42.71
A	QPSK	15.0 MHz 15 kHz SCS	7.49	45.57	36.16	51.59	42.18

Remarks

Calculations: Total Power = Measured Output Power (port A, worst case) + 10log (NANT)
 Where NANT refers to the number of Ports. In this product = 4.

Antenna A - NR Modulation QPSK - NR Carrier Bandwidth 10.0 MHz 15 kHz SCS - Channel Position M

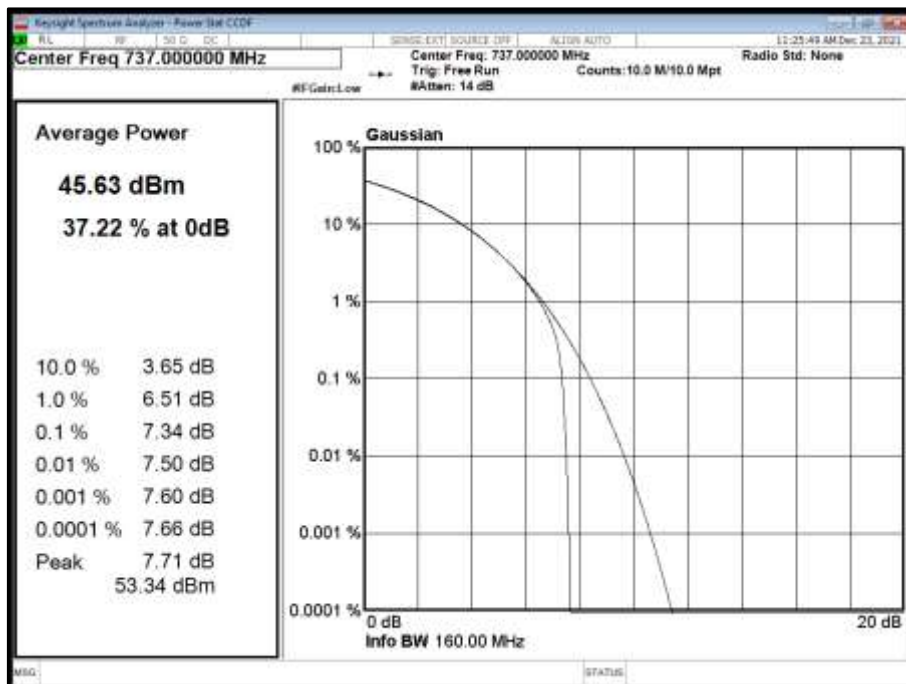



Antenna A - NR Modulation QPSK - NR Carrier Bandwidth 15.0 MHz 15 kHz SCS - Channel Position M

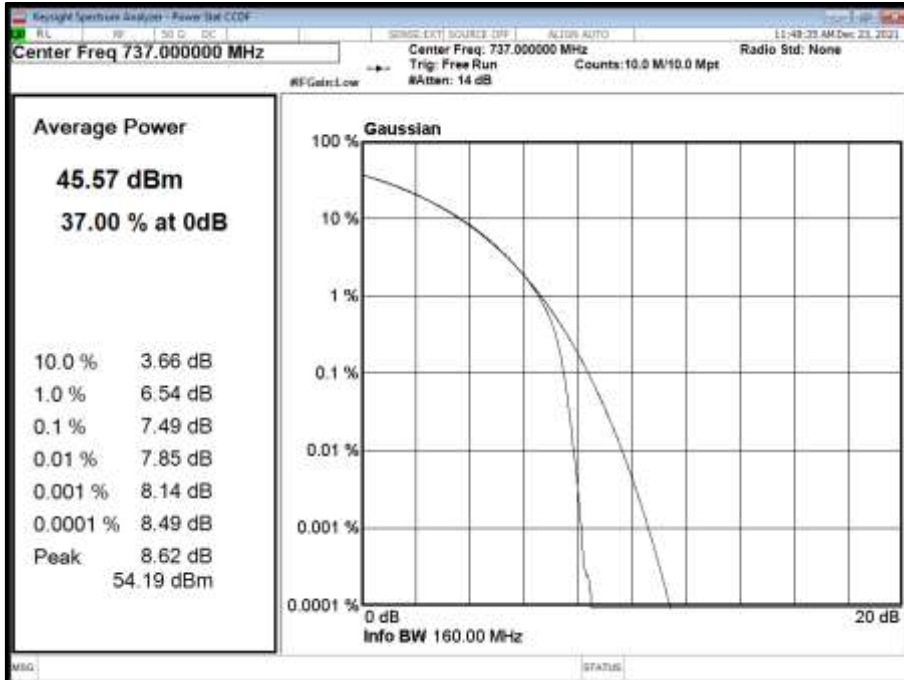

Configuration 1

Maximum Output Power 46.00 dBm

Antenna	NR Modulation	NR Carrier Bandwidth	Peak to Average Ratio (PAR) / Output Power / PSD				
			Channel Position T				
			PAR (dB)	Average Power/PSD		Total Power Port A + B + C + D	Total Power Port A + B + C + D
	dBm	dBm/MHz	dBm	dBm/MHz			
A	QPSK	10.0 MHz 15 kHz SCS	7.36	45.75	36.85	51.77	42.87
A	QPSK	15.0 MHz 15 kHz SCS	7.48	45.60	36.15	51.62	42.17

Remarks

Calculations: Total Power = Measured Output Power (port A, worst case) + 10log (NANT)
Where NANT refers to the number of Ports. In this product = 4.



Antenna A - NR Modulation QPSK - NR Carrier Bandwidth 10.0 MHz 15 kHz SCS - Channel Position T

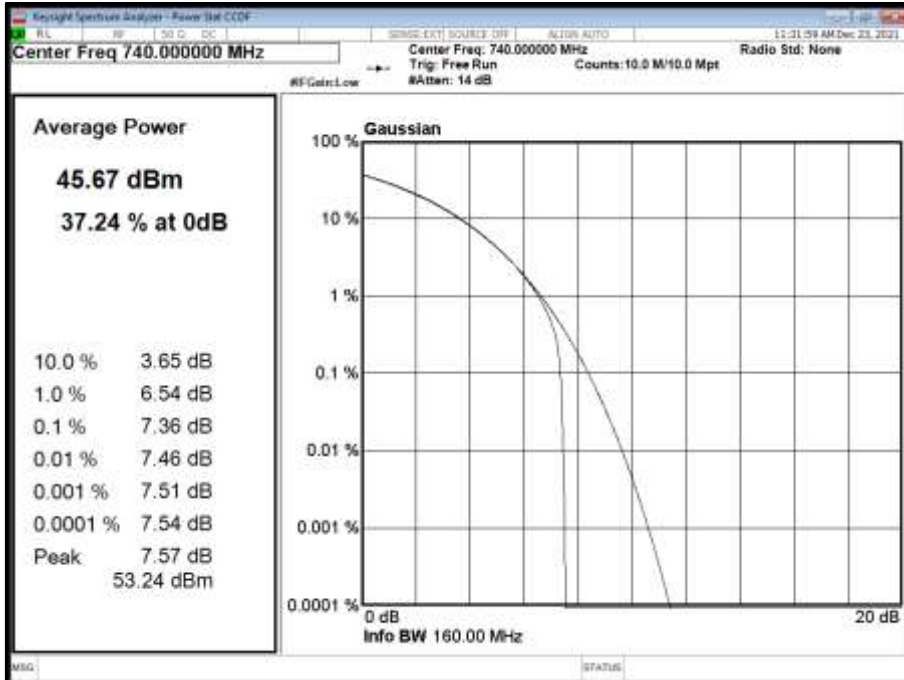

Antenna A - NR Modulation QPSK - NR Carrier Bandwidth 15.0 MHz 15 kHz SCS - Channel Position T

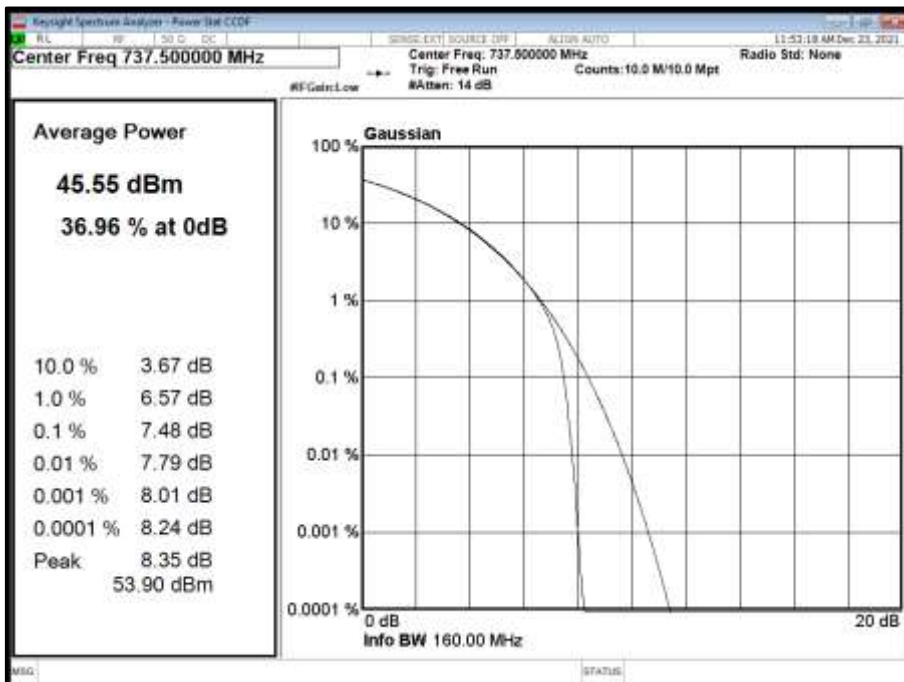



Limit	
Maximum rated output power (Non-Rural)	≤ 1640 W/MHz or $\leq +62.15$ dBm/MHz
Maximum rated output power (Rural)	≤ 3280 W/MHz or $\leq +65.15$ dBm/MHz
Peak to Average Ratio	13 dB

The radio unit was tested with maximum output power and without an antenna. ERP/EIRP compliance is addressed at the time of licensing, as required by the responsible FCC/ISED Bureau(s). Licensees are required to take into account maximum allowed antenna gain used in combination with the applicable power settings to prevent the radiated output power exceeding the limits.



2.2 OCCUPIED BANDWIDTH

2.2.1 Specification Reference

FCC CFR 47 Part 27, Clause 27.53
FCC CFR 47 Part 2, Clause 2.1049

2.2.2 Date of Test and Modification State

23-December-2021 - Modification State 0

2.2.3 Test Equipment Used

The major items of test equipment used for the above tests are identified in Section 3.1.

2.2.4 Environmental Conditions

Ambient Temperature	20.8°C
Relative Humidity	40.3%

2.2.5 Test Method

All measurements were made in accordance with FCC KDB 971168 D01, Clause 4.2 and 4.3. The Spectrum Analyser RBW was configured to be at least 1% of the channel bandwidth of the carrier to be measured.

For 26 dB Bandwidth, in accordance with KDB 971168 D01, a peak detector and a trace setting of Max Hold were used. The trace was allowed to stabilise. Using the Spectrum Analyser function, the 26dB measurement result was obtained.

4.2 Occupied bandwidth – relative measurement procedure

The reference value is the highest level of the spectral envelope of the modulated signal, unless otherwise specified in an applicable rule section.

Subclause 5.4.3 of ANSI C63.26-2015 is applicable.

4.3 Occupied bandwidth – power bandwidth (99 %) measurement procedure

Subclause 5.4.4 of ANSI C63.26-2015 is applicable (wherein the recommendation is to use the 99 % power bandwidth function of a spectrum analyzer).

2.2.6 Test Results



Configuration 1

Maximum Output Power 46.00 dBm

Antenna	NR Modulation	NR Carrier Bandwidth	Result (kHz)					
			Channel Position B		Channel Position M		Channel Position T	
			Occupied Bandwidth	-26 dB Bandwidth	Occupied Bandwidth	-26 dB Bandwidth	Occupied Bandwidth	-26 dB Bandwidth
A	QPSK	10.0 MHz 15 kHz SCS	9434.97	9794.70	9437.76	9807.06	9438.13	9808.29
A	QPSK	15.0 MHz 15 kHz SCS	14362.78	14803.91	14365.16	14811.08	14358.51	14801.82

Antenna A - NR Modulation QPSK - NR Carrier Bandwidth 10.0 MHz 15 kHz SCS - Channel Position B

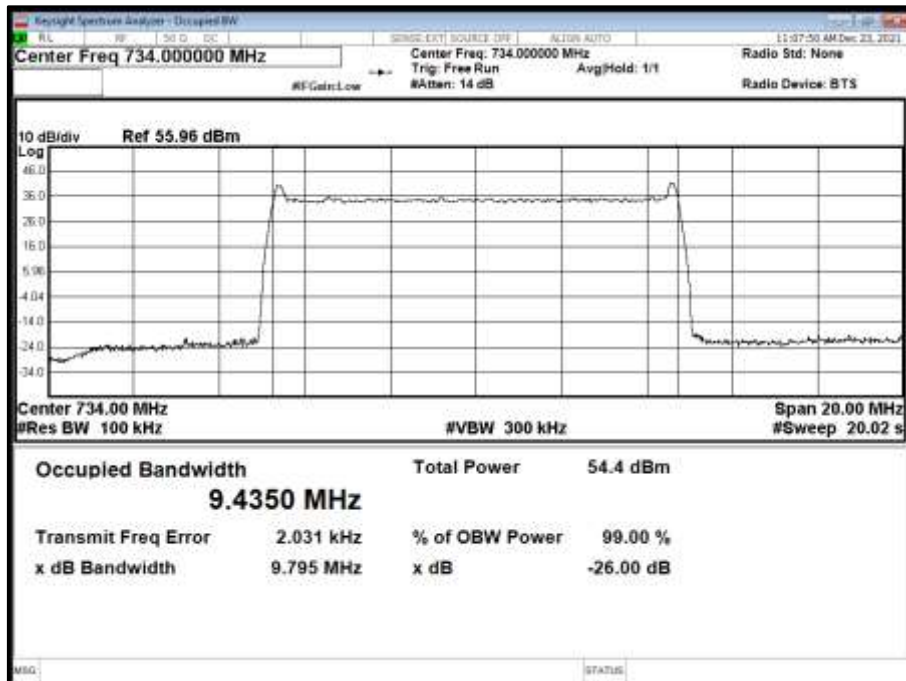



Antenna A - NR Modulation QPSK - NR Carrier Bandwidth 10.0 MHz 15 kHz SCS - Channel Position M

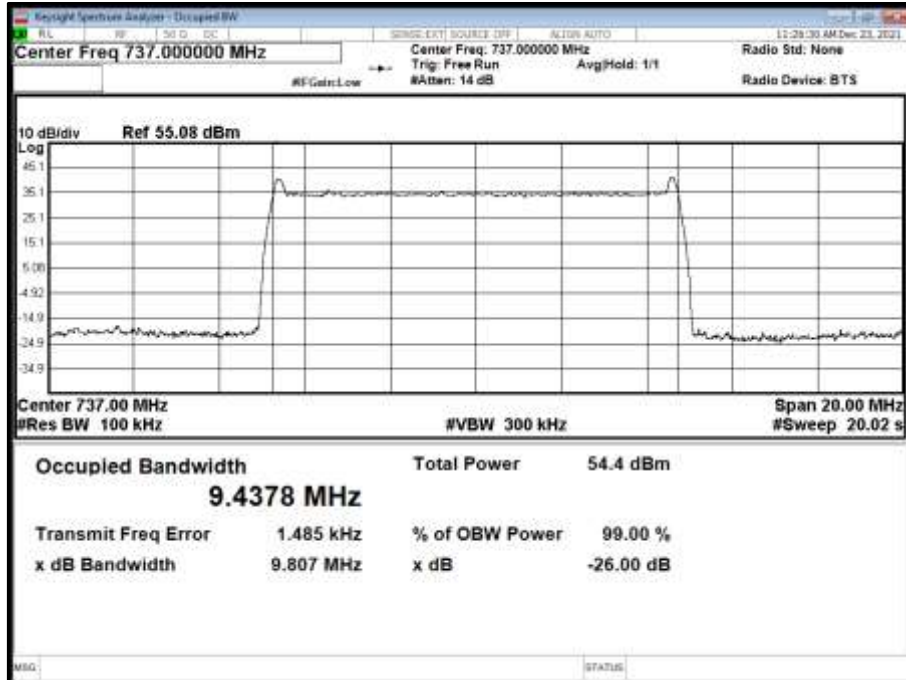

Antenna A - NR Modulation QPSK - NR Carrier Bandwidth 10.0 MHz 15 kHz SCS - Channel Position T

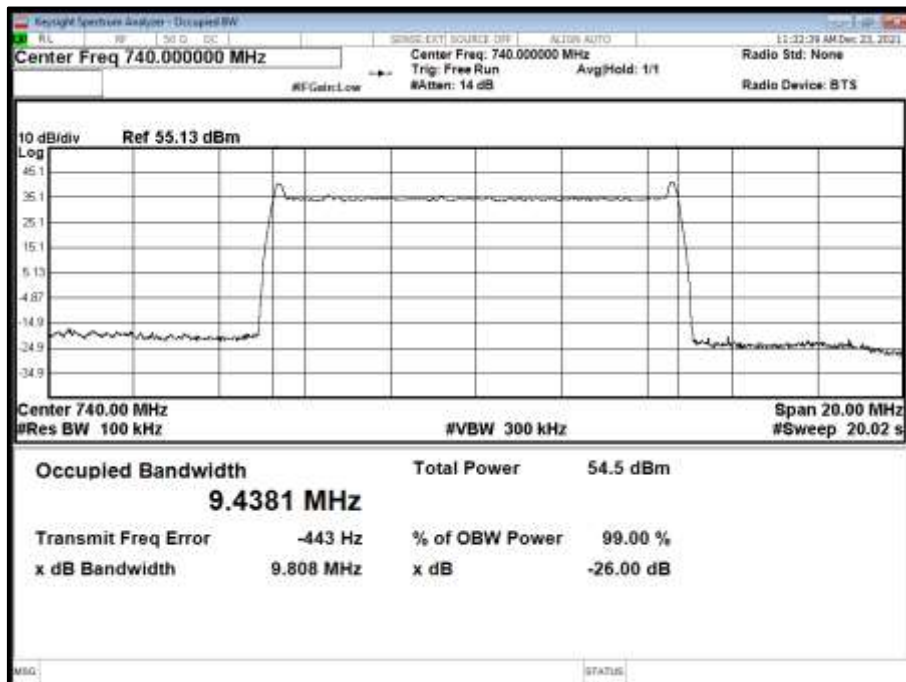



Antenna A - NR Modulation QPSK - NR Carrier Bandwidth 15.0 MHz 15 kHz SCS - Channel Position B

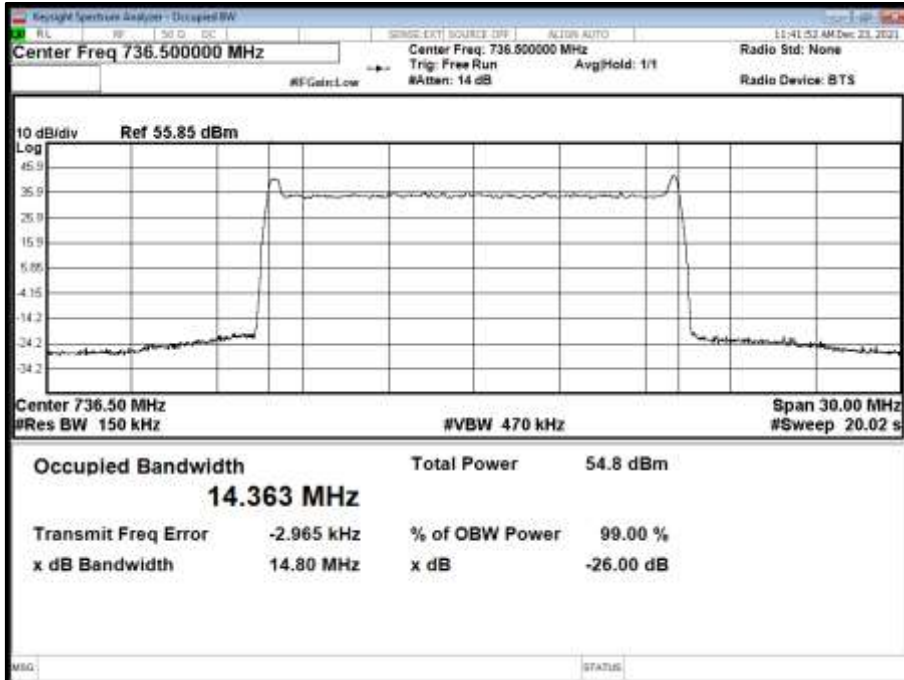

Antenna A - NR Modulation QPSK - NR Carrier Bandwidth 15.0 MHz 15 kHz SCS - Channel Position M

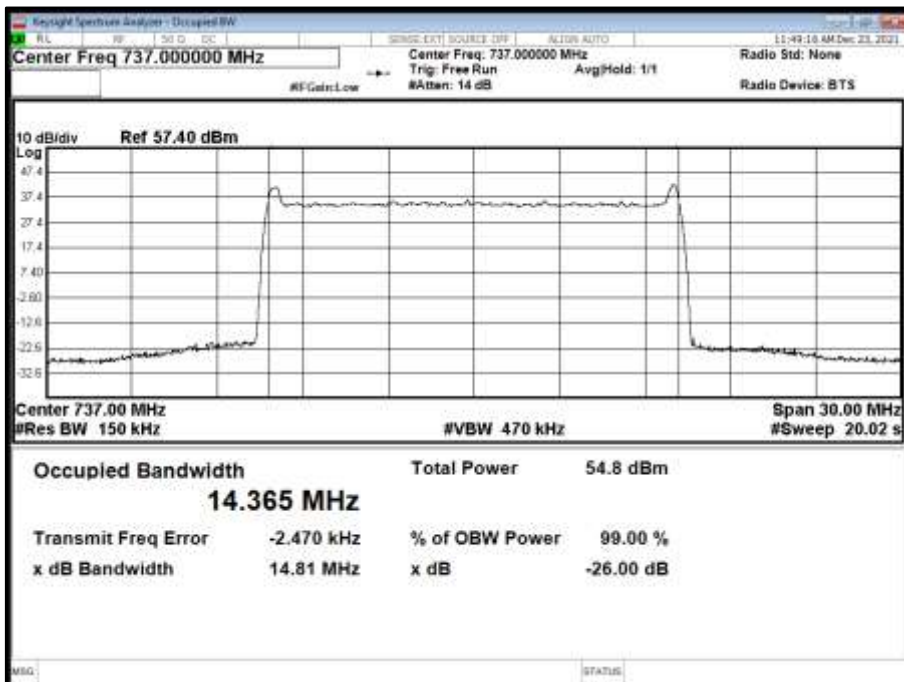



Antenna A - NR Modulation QPSK - NR Carrier Bandwidth 15.0 MHz 15 kHz SCS - Channel Position T

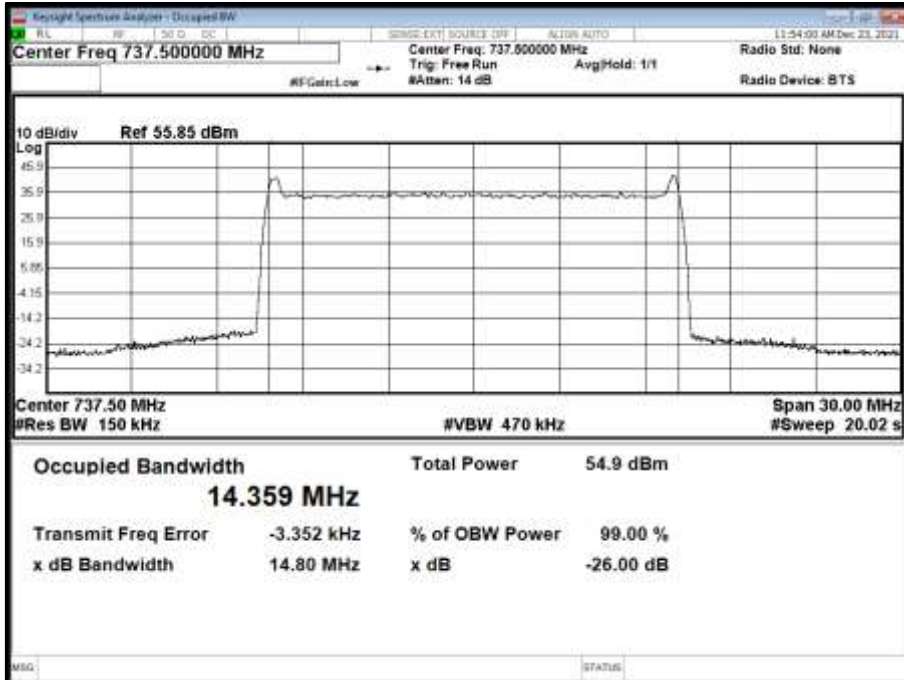



2.3 BAND EDGE

2.3.1 Specification Reference

FCC CFR 47 Part 27, Clause 27.53
FCC CFR 47 Part 2, Clause 2.1051

2.3.2 Date of Test and Modification State

23-December-2021 - Modification State 0

2.3.3 Test Equipment Used

The major items of test equipment used for the above tests are identified in Section 3.1.

2.3.4 Environmental Conditions

Ambient Temperature 20.8°C
Relative Humidity 40.3%

2.3.5 Test Method

All measurements were made in accordance with FCC KDB 971168 D01, Clause 6.0.

Band Edge measurements were used an Integration Bandwidth of at least 1% of the measured 26dB Bandwidth.

Each antenna port has been declared as being equivalent, therefore measurements were made on one antenna port only. To account for this, the limit was tightened by $10 * \text{Log}(N)$, where N is equal to the number of MIMO antenna ports.

For single port, the limit was calculated as being $-13 \text{ dBm} - 10 * \text{Log}(4) = -19 \text{ dBm}$.

2.3.6 Test Results

Configuration 1

Maximum Output Power 46.00 dBm

Antenna	NR Modulation	NR Carrier Bandwidth	Band Edge (MHz)	
			Channel Position B	Channel Position T
A	QPSK	10.0 MHz 15 kHz SCS	734.0	740.0
A	QPSK	15.0 MHz 15 kHz SCS	736.5	737.5



Antenna A - NR Modulation QPSK - NR Carrier Bandwidth 10.0 MHz 15 kHz SCS - Channel Position B

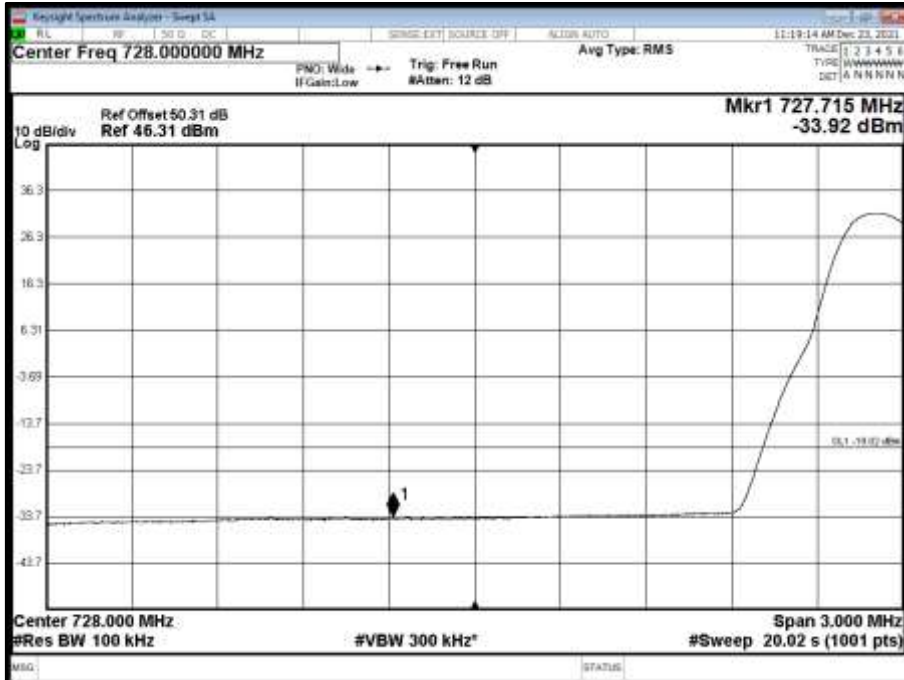

Antenna A - NR Modulation QPSK - NR Carrier Bandwidth 10.0 MHz 15 kHz SCS - Channel Position T

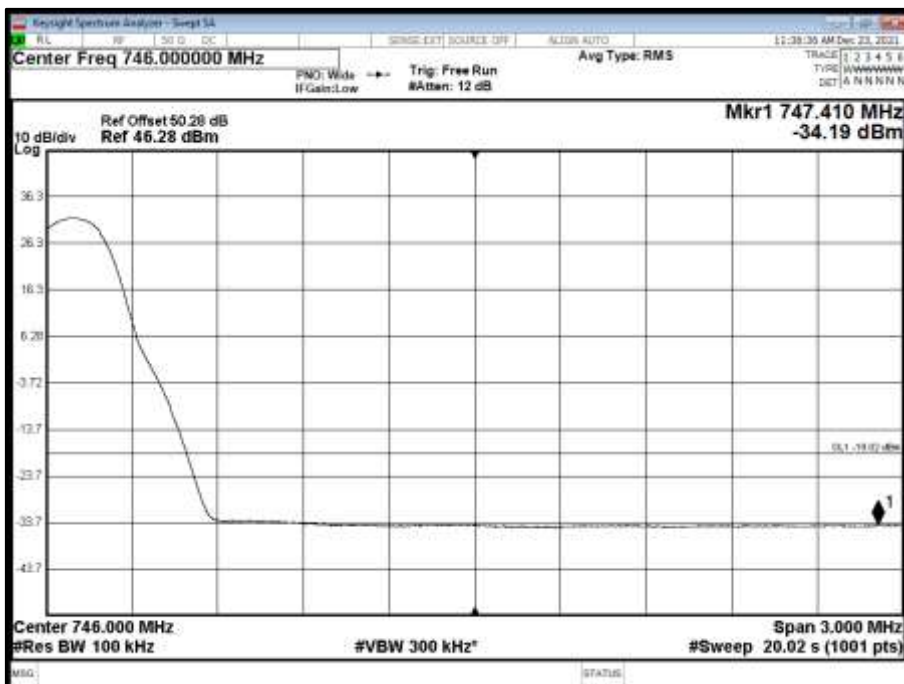



Antenna A - NR Modulation QPSK - NR Carrier Bandwidth 15.0 MHz 15 kHz SCS - Channel Position B

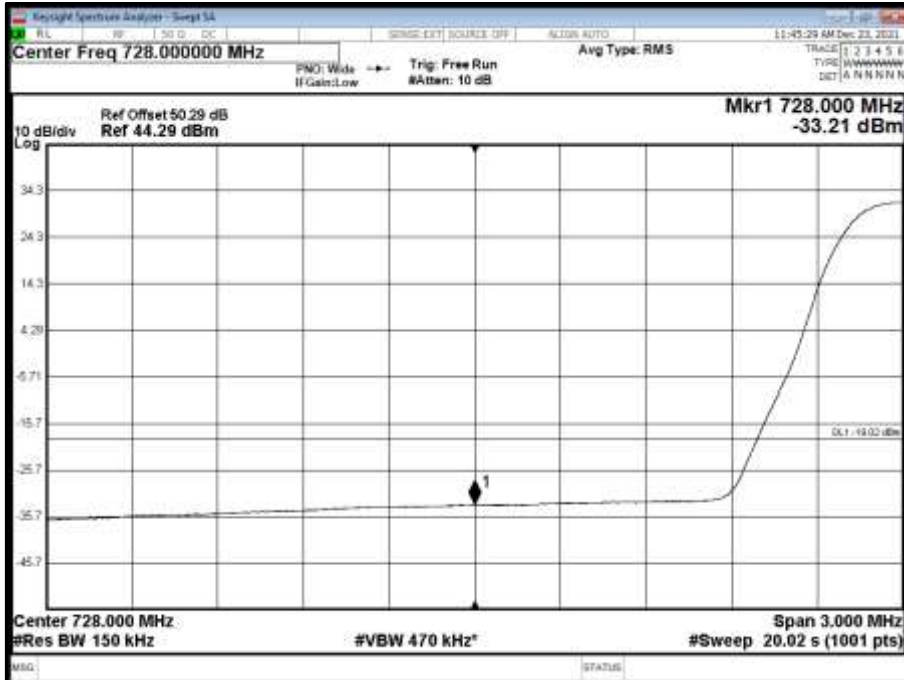

Antenna A - NR Modulation QPSK - NR Carrier Bandwidth 15.0 MHz 15 kHz SCS - Channel Position T

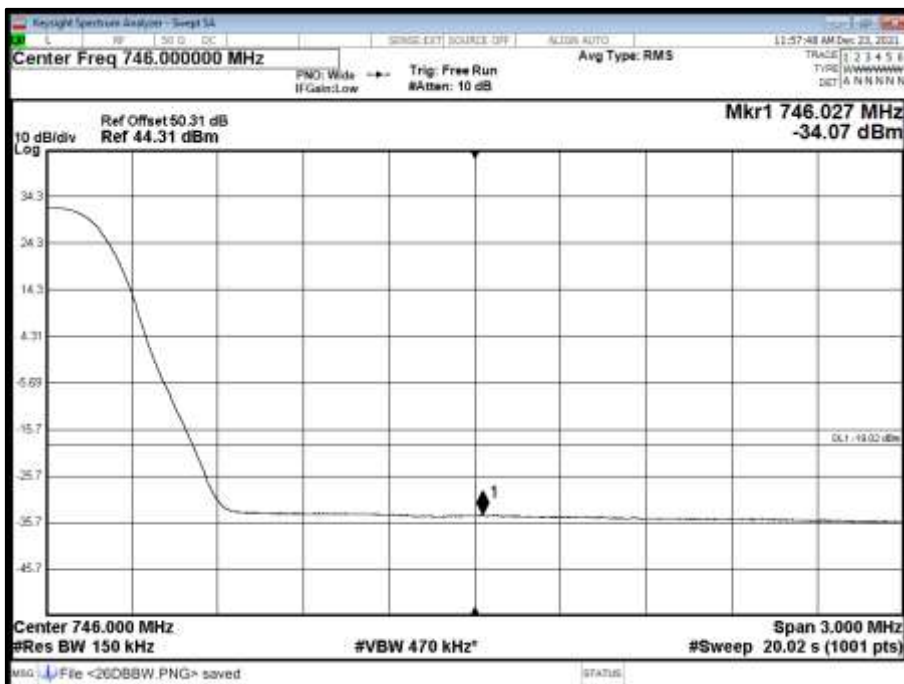



2.4 TRANSMITTER SPURIOUS EMISSIONS

2.4.1 Specification Reference

FCC CFR 47 Part 27, Clause 27.53
ISED RSS-130, Clause 4.7
FCC CFR 47 Part 2, Clause 2.1051

2.4.2 Date of Test and Modification State

23-December-2021 - Modification State 0

2.4.3 Test Equipment Used

The major items of test equipment used for the above tests are identified in Section 3.1.

2.4.4 Environmental Conditions

Ambient Temperature	20.8°C
Relative Humidity	40.3%

2.4.5 Test Method

All measurements were made in accordance with FCC KDB 971168 D01, Clause 6.1.

Each antenna port has been declared as being equivalent, therefore measurements were made on one antenna port only. To account for this, the limit was tightened by $10 * \text{Log}(N)$, where N is equal to the number of MIMO antenna ports.

For single port, the limit was calculated as being $-13 \text{ dBm} - 10 * \text{Log}(4) = -19 \text{ dBm}$.

2.4.6 Test Results

Configuration 1

Maximum Output Power 46.00 dBm



Antenna A - NR Modulation QPSK - NR Carrier Bandwidth 10.0 MHz 15 kHz SCS - Channel Position B - Band 1 - Range 0.009 to 1200 MHz

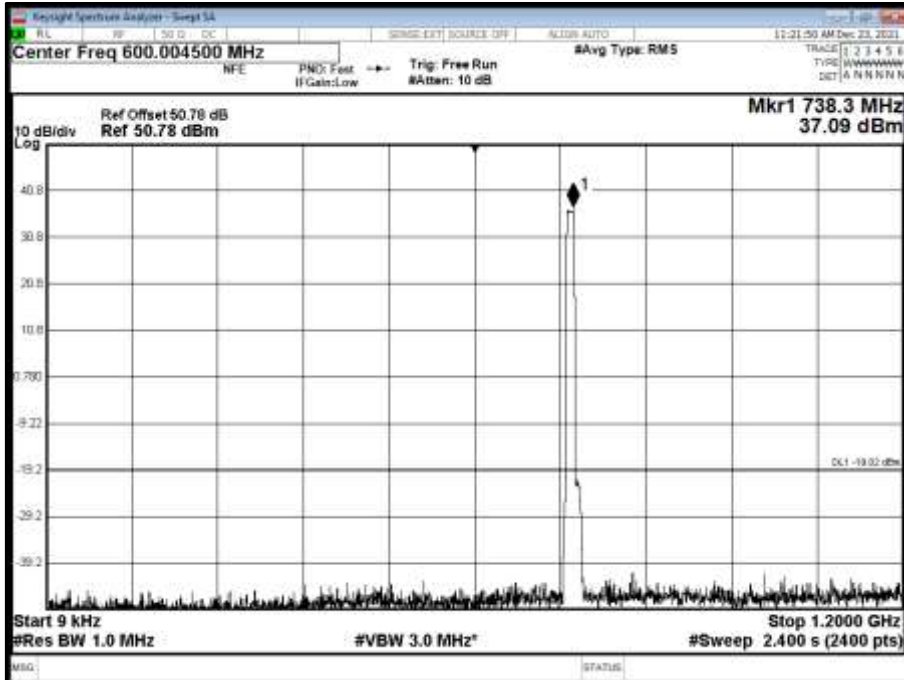

Antenna A - NR Modulation QPSK - NR Carrier Bandwidth 10.0 MHz 15 kHz SCS - Channel Position B - Band 2 - Range 1200 to 4000 MHz

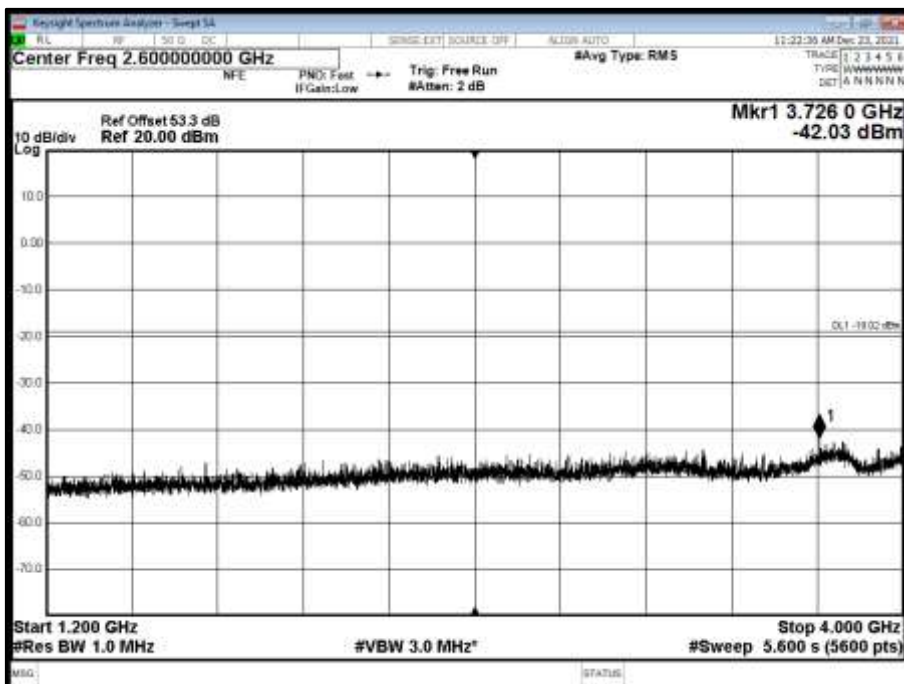



Antenna A - NR Modulation QPSK - NR Carrier Bandwidth 10.0 MHz 15 kHz SCS - Channel Position B - Band 3 - Range 4000 to 8000 MHz

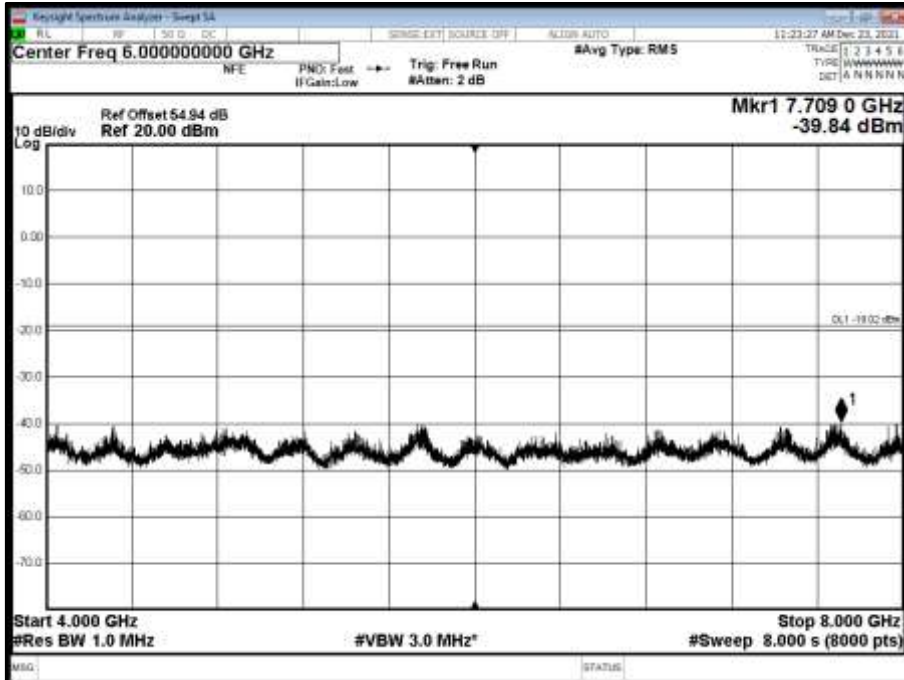

Antenna A - NR Modulation QPSK - NR Carrier Bandwidth 10.0 MHz 15 kHz SCS - Channel Position M - Band 1 - Range 0.009 to 1200 MHz

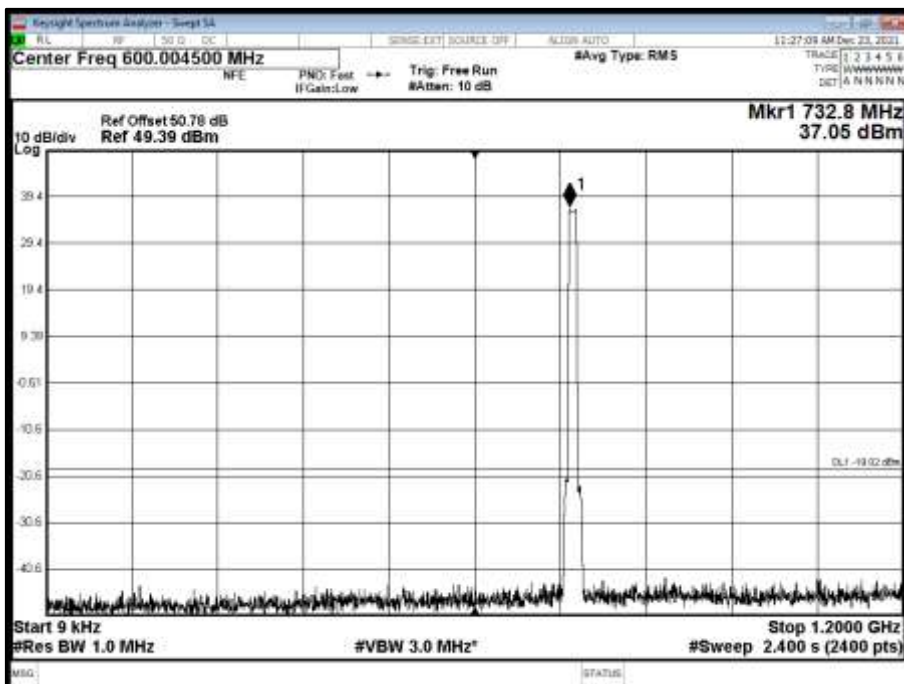



Antenna A - NR Modulation QPSK - NR Carrier Bandwidth 10.0 MHz 15 kHz SCS - Channel Position M - Band 2 - Range 1200 to 4000 MHz

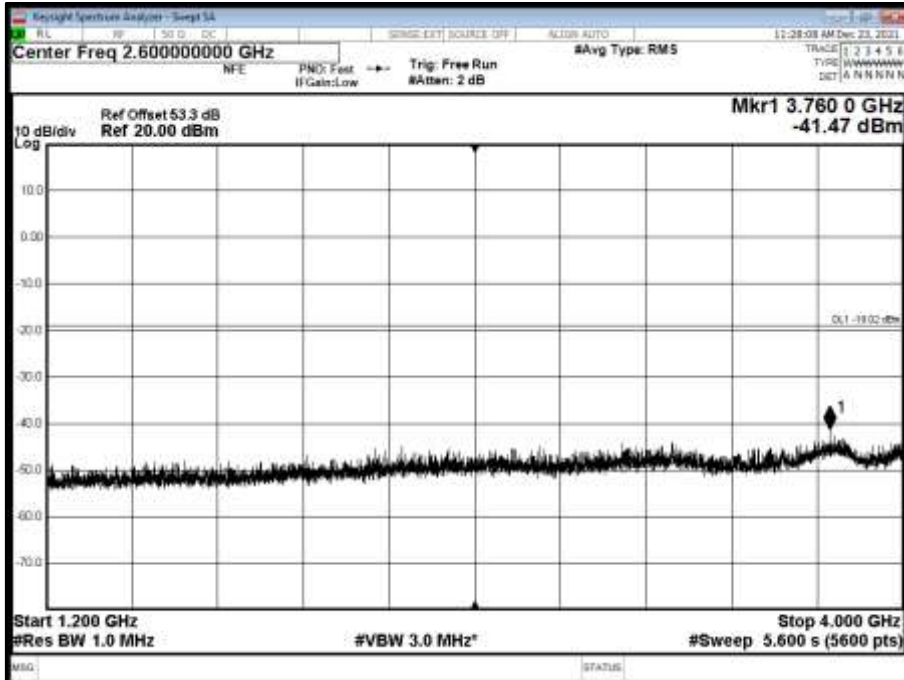

Antenna A - NR Modulation QPSK - NR Carrier Bandwidth 10.0 MHz 15 kHz SCS - Channel Position M - Band 3 - Range 4000 to 8000 MHz

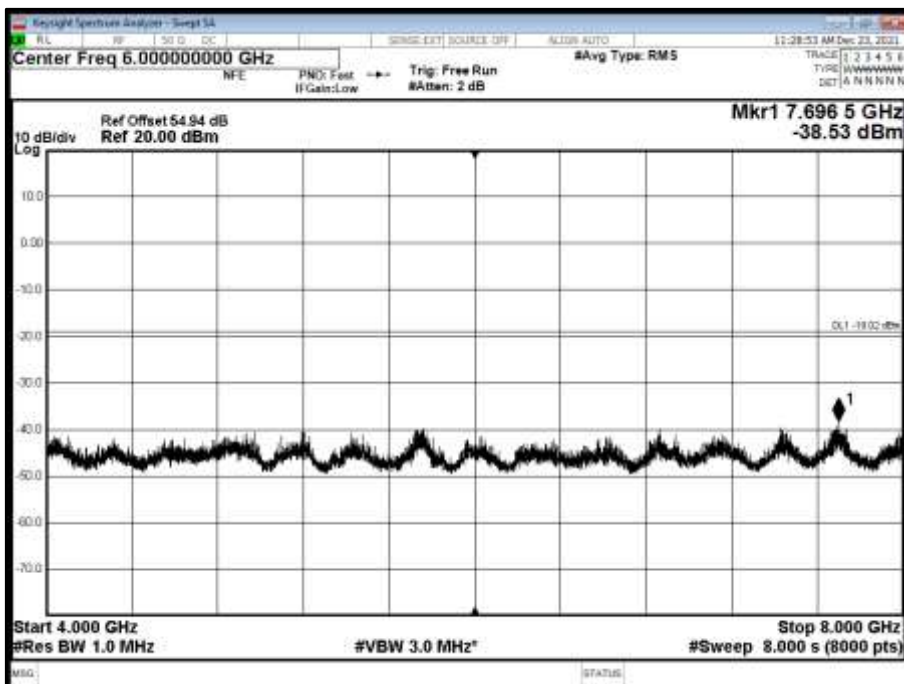



Antenna A - NR Modulation QPSK - NR Carrier Bandwidth 10.0 MHz 15 kHz SCS - Channel Position T - Band 1 - Range 0.009 to 1200 MHz

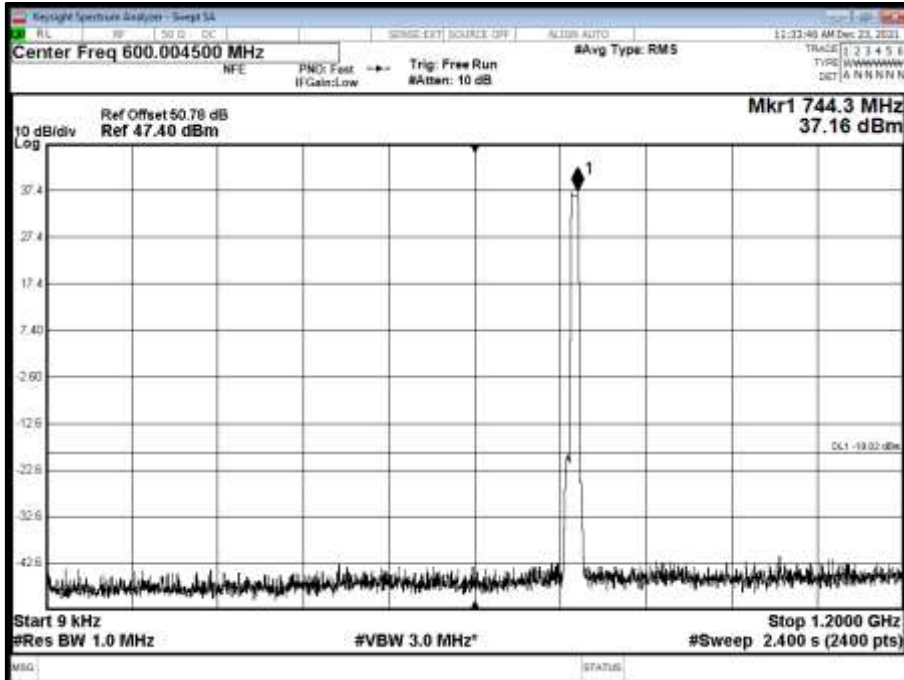

Antenna A - NR Modulation QPSK - NR Carrier Bandwidth 10.0 MHz 15 kHz SCS - Channel Position T - Band 2 - Range 1200 to 4000 MHz

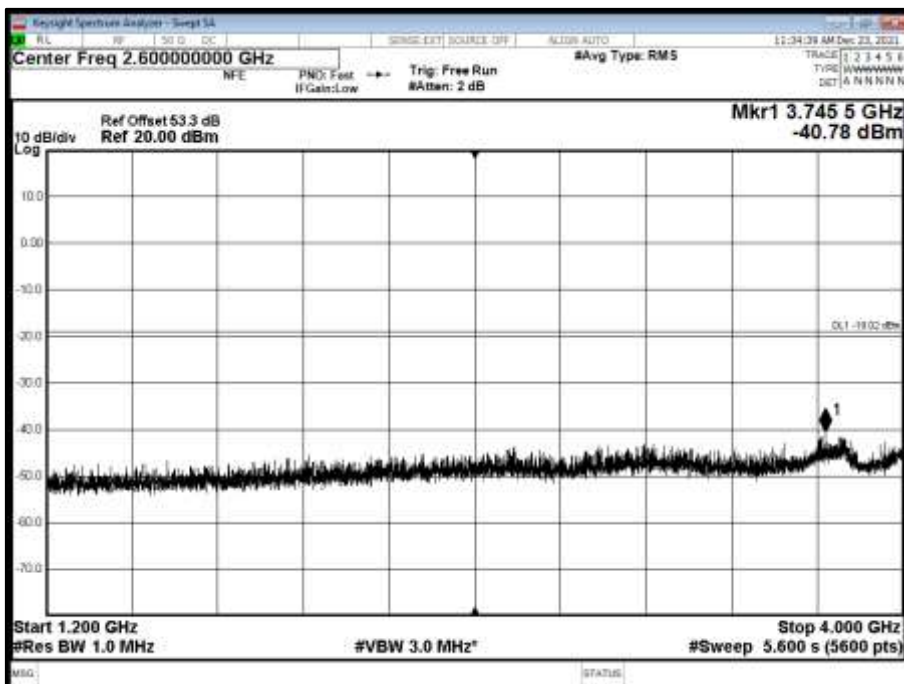



Antenna A - NR Modulation QPSK - NR Carrier Bandwidth 10.0 MHz 15 kHz SCS - Channel Position T - Band 3 - Range 4000 to 8000 MHz

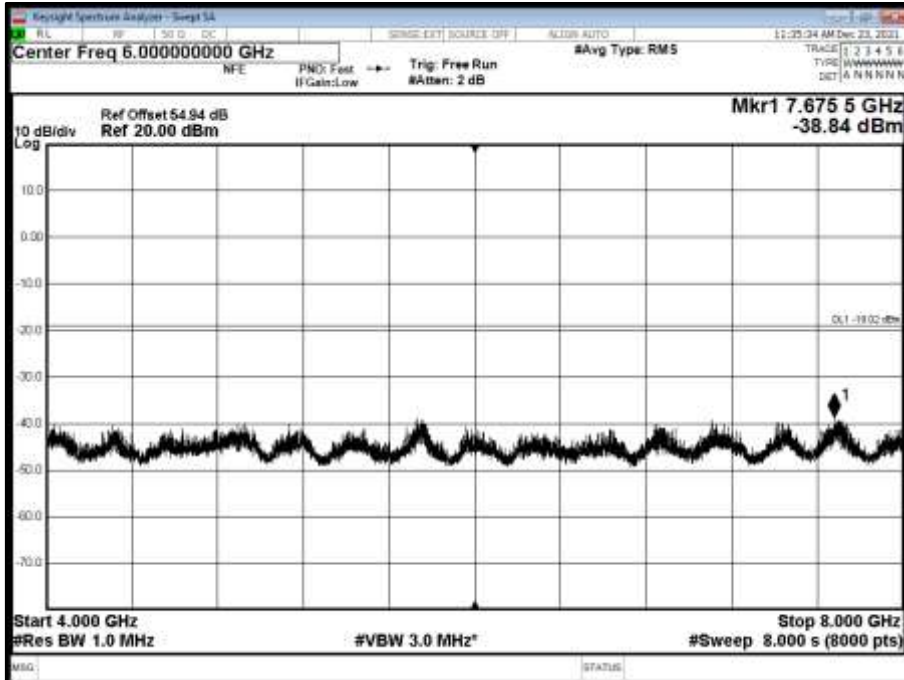

Antenna A - NR Modulation QPSK - NR Carrier Bandwidth 15.0 MHz 15 kHz SCS - Channel Position B - Band 1 - Range 0.009 to 1200 MHz

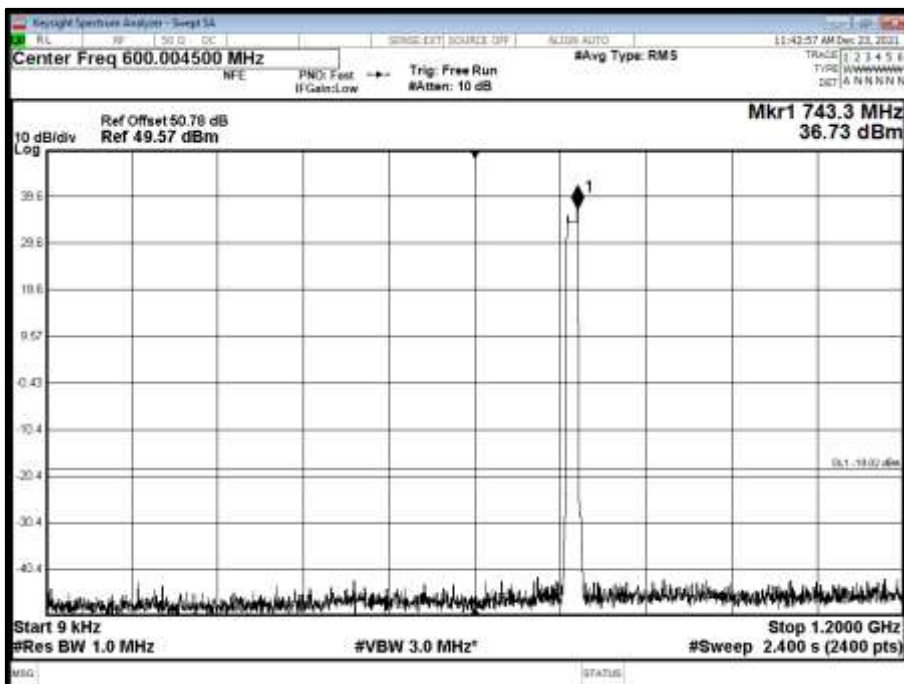



Antenna A - NR Modulation QPSK - NR Carrier Bandwidth 15.0 MHz 15 kHz SCS - Channel Position B - Band 2 - Range 1200 to 4000 MHz

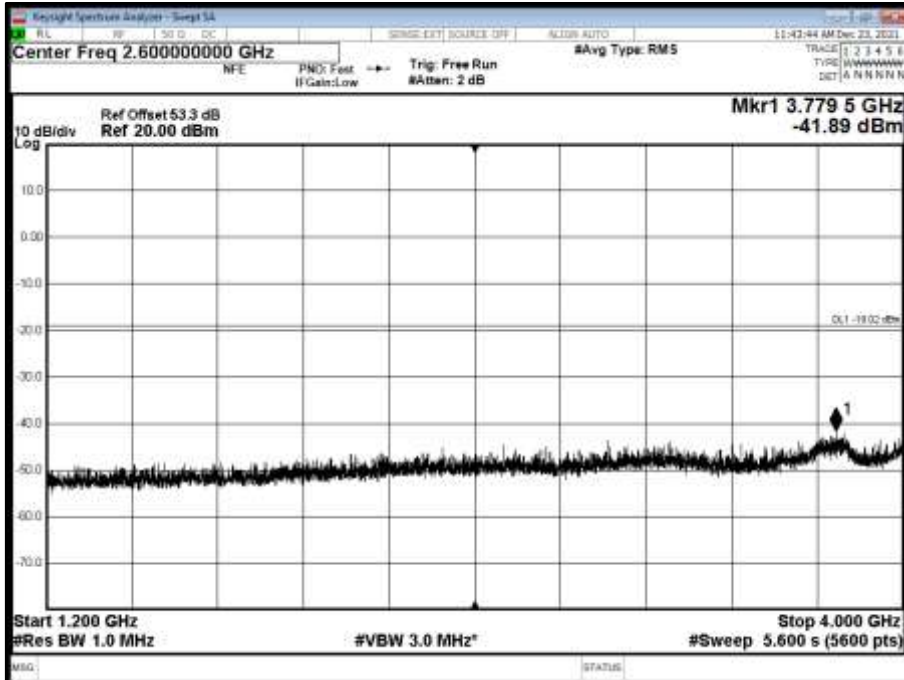

Antenna A - NR Modulation QPSK - NR Carrier Bandwidth 15.0 MHz 15 kHz SCS - Channel Position B - Band 3 - Range 4000 to 8000 MHz

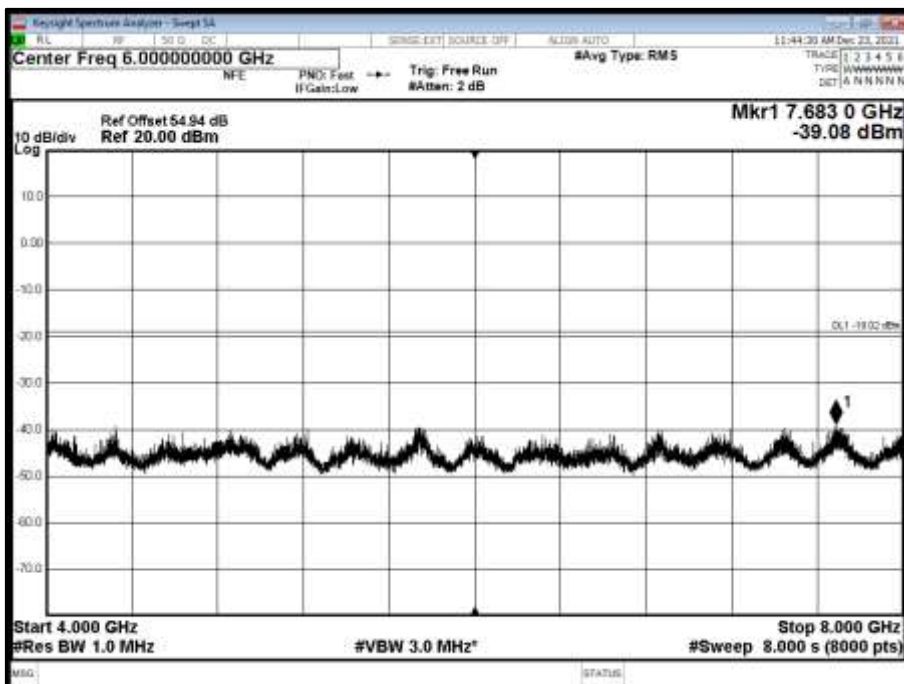



Antenna A - NR Modulation QPSK - NR Carrier Bandwidth 15.0 MHz 15 kHz SCS - Channel Position M - Band 1 - Range 0.009 to 1200 MHz

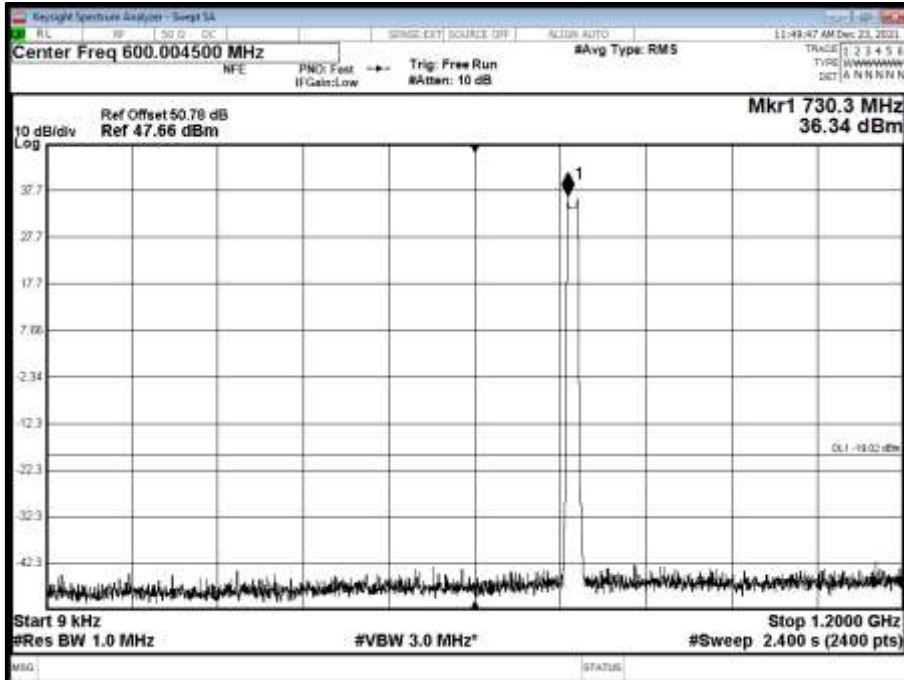

Antenna A - NR Modulation QPSK - NR Carrier Bandwidth 15.0 MHz 15 kHz SCS - Channel Position M - Band 2 - Range 1200 to 4000 MHz

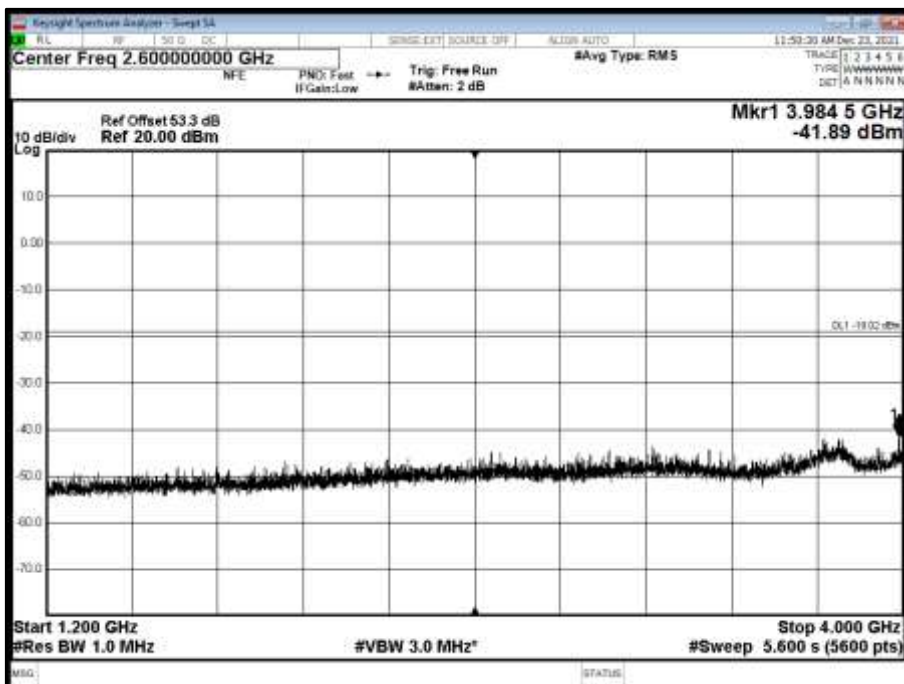



Antenna A - NR Modulation QPSK - NR Carrier Bandwidth 15.0 MHz 15 kHz SCS - Channel Position M - Band 3 - Range 4000 to 8000 MHz

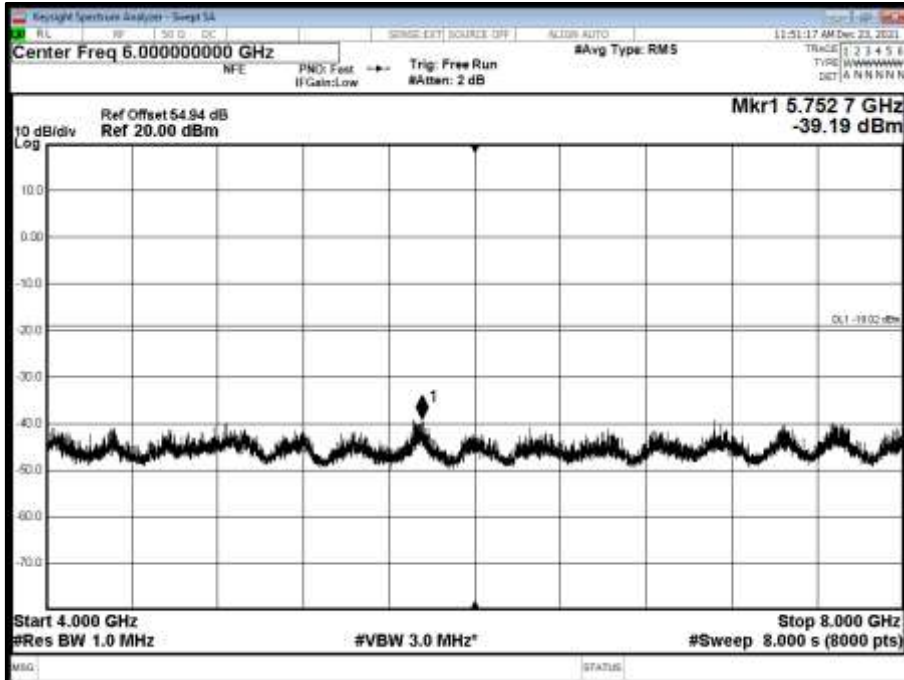

Antenna A - NR Modulation QPSK - NR Carrier Bandwidth 15.0 MHz 15 kHz SCS - Channel Position T - Band 1 - Range 0.009 to 1200 MHz

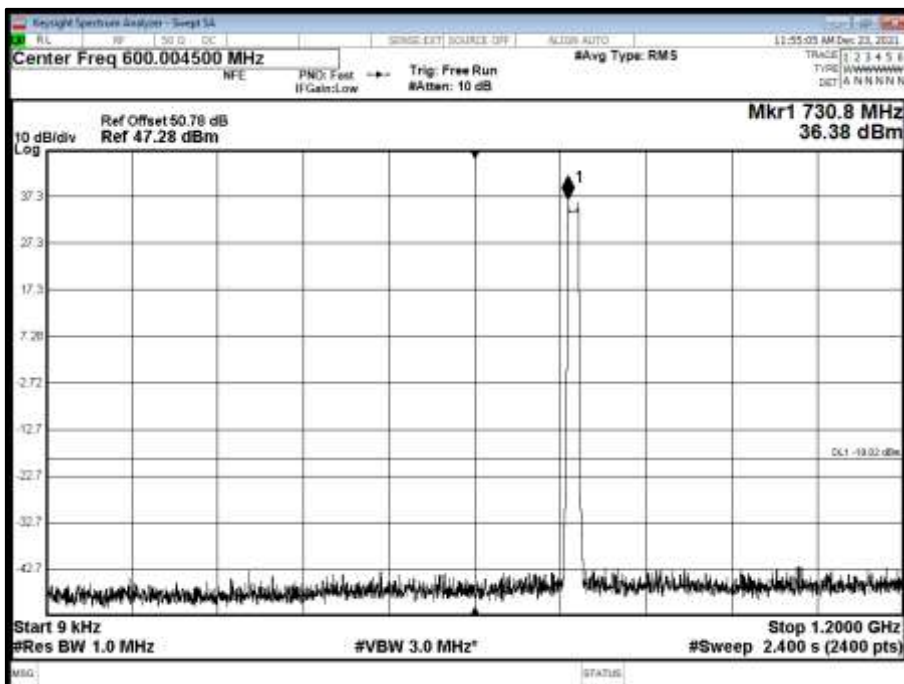



Antenna A - NR Modulation QPSK - NR Carrier Bandwidth 15.0 MHz 15 kHz SCS - Channel Position T - Band 2 - Range 1200 to 4000 MHz

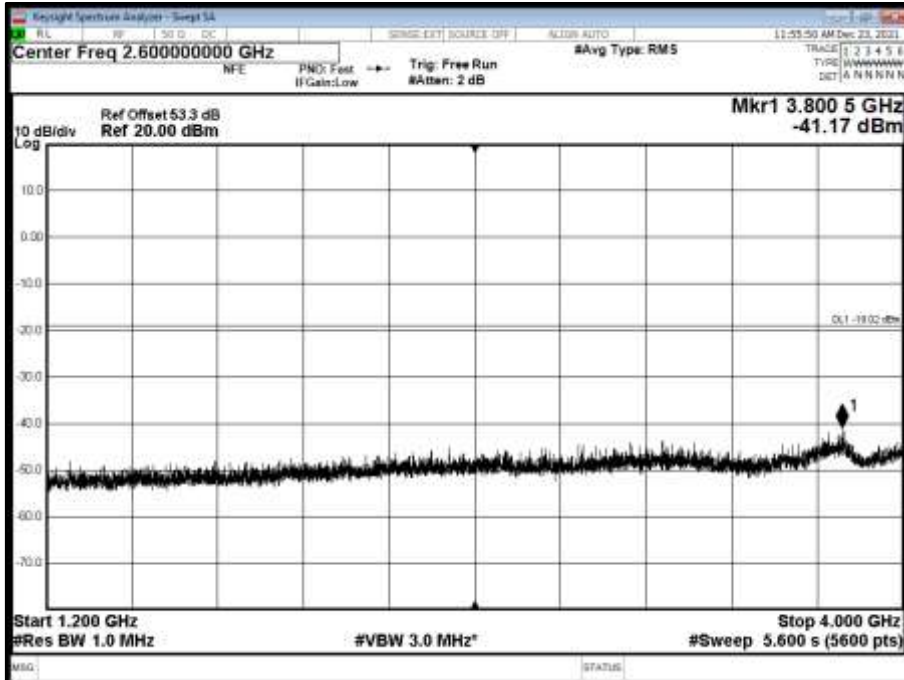

Antenna A - NR Modulation QPSK - NR Carrier Bandwidth 15.0 MHz 15 kHz SCS - Channel Position T - Band 3 - Range 4000 to 8000 MHz

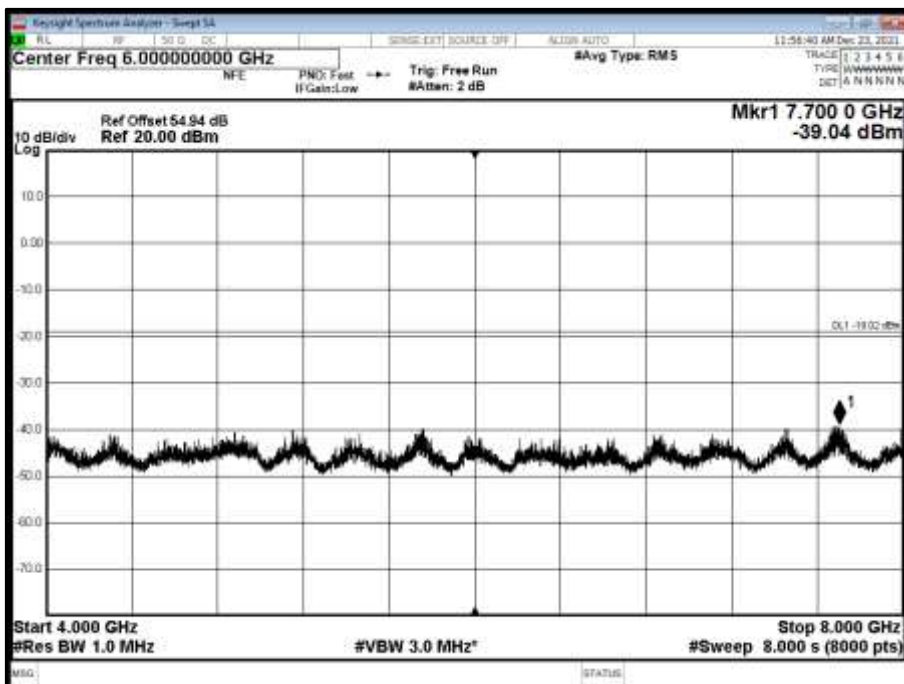

Limit	-19 dBm
-------	---------



2.5 RADIATED EMISSIONS

2.5.1 Specification Reference

FCC CFR 47 Part 27, Clause 27.53
FCC CFR 47 Part 2, Clause 2.1053

2.5.2 Date of Test and Modification State

11-January-2022 - Modification State 0

2.5.3 Test Equipment Used

The major items of test equipment used for the above tests are identified in Section 3.1.

2.5.4 Environmental Conditions

Ambient Temperature	23.9°C
Relative Humidity	39.9%

2.5.5 Test Method

The test was performed in accordance with ANSI C63.26 Clause 5. The EUT was configured as defined in ANSI C63.26, clause 5.5.2.3.2.

As a result of the conducted measurements that were performed on the EUT, it was established that 10 MHz was the bandwidth configuration which gave the highest output power and therefore deemed to be worst case operating modes. Testing was performed on the Top, Middle and Bottom channels for single carrier.

The EUT was set up on a support replicating typical installation conditions at a height of 0.8 m above the reference ground plane for measurements below 1GHz, (see setup photos) within a semi-anechoic chamber on a remotely controlled turntable. Above 1 GHz, the height was increased to 1.5 m above the reference ground plane.

2.5.6 Test Results



Configuration 1

Maximum Output Power 46.00 dBm

Frequency (MHz)	Level (dBm)	Limit (dBm)	Margin (dB)	Detector	Angle (°)	Height (cm)	Polarisation
*							

Bot - NR&NB-IoT - B12A, 734, 30 MHz to 10 GHz

*No emissions found within 6 dB of the limit.

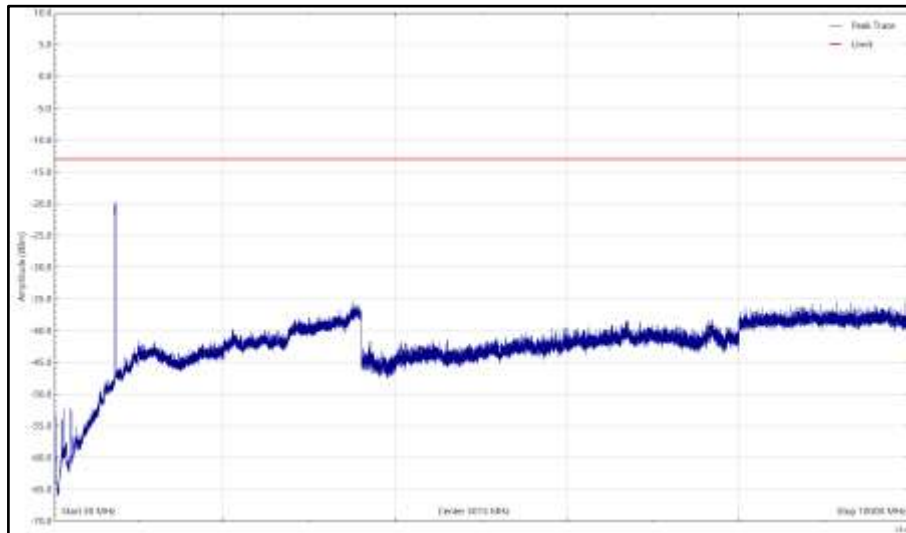

Bot - NR&NB-IoT - B12A, 734, 30 MHz to 10 GHz, Horizontal (Peak)

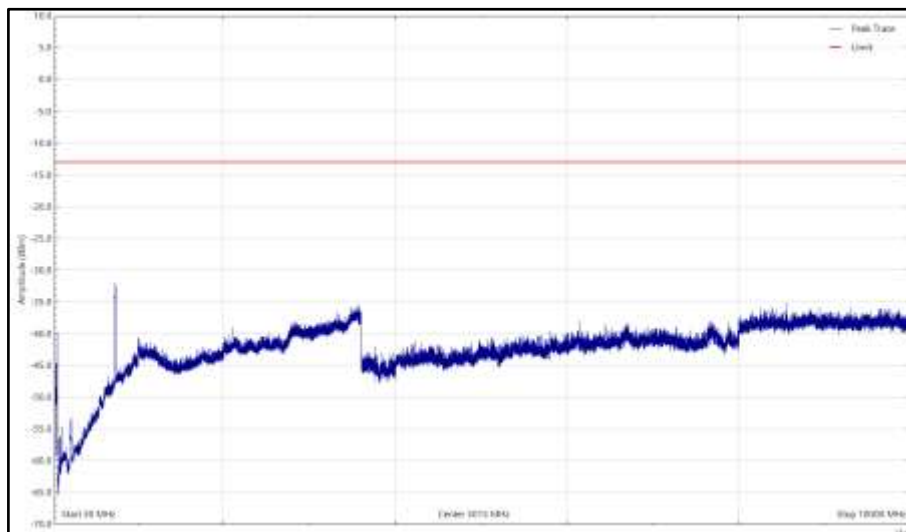

Bot - NR&NB-IoT - B12A, 734, 30 MHz to 10 GHz, Vertical (Peak)



Frequency (MHz)	Level (dBm)	Limit (dBm)	Margin (dB)	Detector	Angle (°)	Height (cm)	Polarisation
*							

Mid - NR&NB-IoT - B12A, 737, 30 MHz to 10 GHz

*No emissions found within 6 dB of the limit.

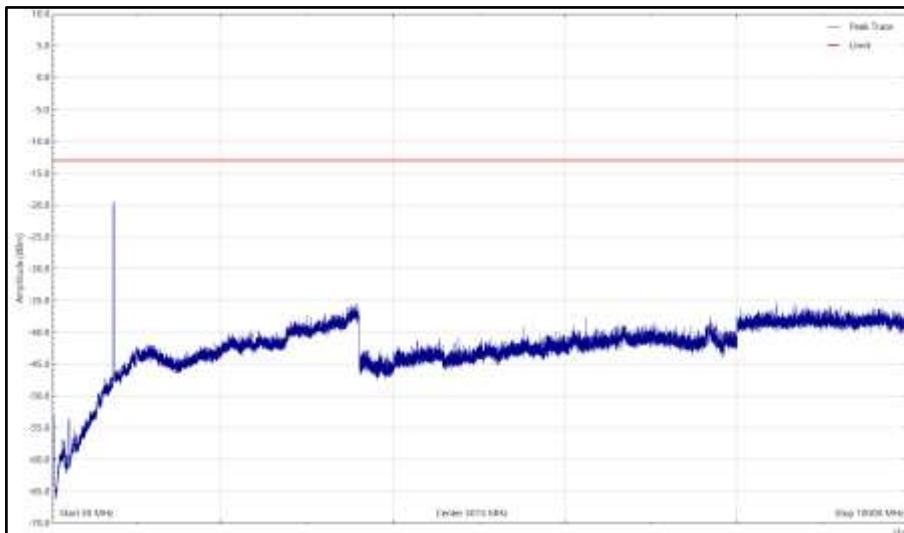

Mid - NR&NB-IoT - B12A, 737, 30 MHz to 10 GHz, Horizontal (Peak)

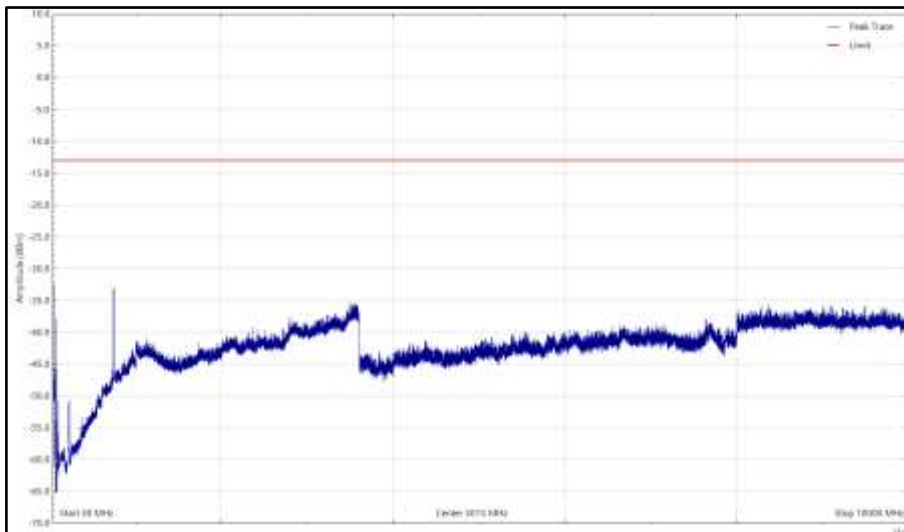

Mid - NR&NB-IoT - B12A, 737, 30 MHz to 10 GHz, Vertical (Peak)



Frequency (MHz)	Level (dBm)	Limit (dBm)	Margin (dB)	Detector	Angle (°)	Height (cm)	Polarisation
*							

Top - NR&NB-IoT - B12A, 740, 30 MHz to 10 GHz

*No emissions found within 6 dB of the limit.

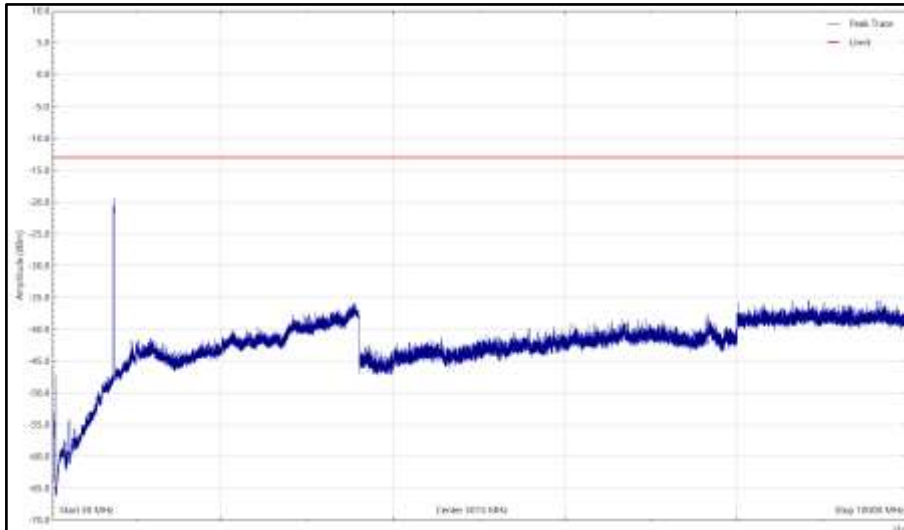

Top - NR&NB-IoT - B12A, 740, 30 MHz to 10 GHz, Horizontal (Peak)

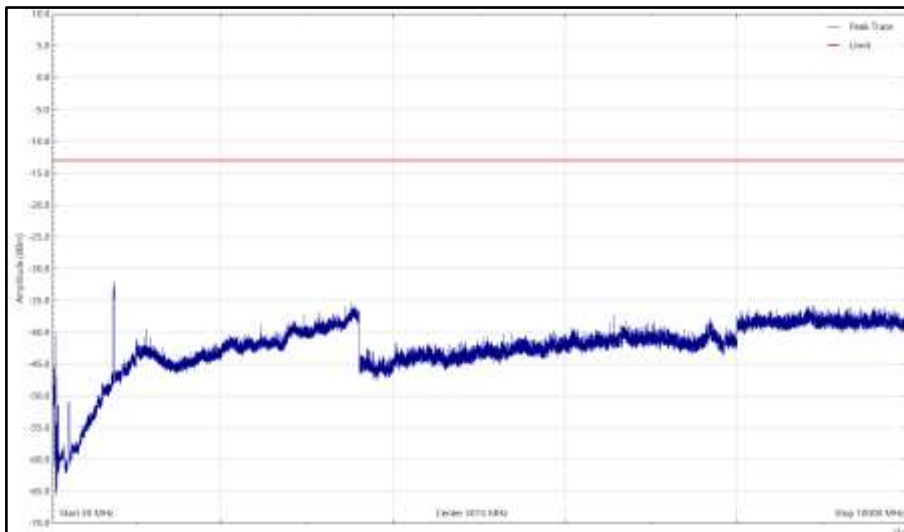

Top - NR&NB-IoT - B12A, 740, 30 MHz to 10 GHz, Vertical (Peak)

Limit

The power of any emission outside of the authorized operating frequency ranges must be attenuated below the transmitting power (P) by a factor of at least $43 + 10 \log(P)$ db.	$46 - (43 + 10 \log 46)$ = -13.6 dBm
--	---



SECTION 3

TEST EQUIPMENT USED



3.1 TEST EQUIPMENT USED

List of absolute measuring and other principal items of test equipment.

Instrument	Manufacturer	Type No.	TE No.	Calibration Period (months)	Calibration Due
Maximum Peak Output Power and Peak to Average Ratio - Conducted					
Hygrometer	PCE Instruments	PCE-THB-40	5475	12	06-Apr-2022
Frequency Standard	Spectracom	SecureSync 1200-0408-0601	4393	6	03-Jan-2022
Analyser	Keysight	N9030A	4654	12	24-Nov-2022
Power Supply	Farnell	H60-25	1092	-	OP-MON
Multimeter	Fluke	79 Series II	3057	12	23-Aug-2022
Attenuator	Weinschel	48-40-43-LIM	5134	12	03-Jan-2022
Attenuator	Aeroflex / Weinschel	47-10-34	3166	12	13-Sep-2022
Network Analyser	Rohde & Schwarz	ZVA 40	3548	12	29-Jan-2022
Calibration Unit	Rohde & Schwarz	ZV-Z54	4368	12	30-Dec-2021
Occupied Bandwidth					
Hygrometer	PCE Instruments	PCE-THB-40	5475	12	06-Apr-2022
Frequency Standard	Spectracom	SecureSync 1200-0408-0601	4393	6	03-Jan-2022
Analyser	Keysight	N9030A	4654	12	24-Nov-2022
Power Supply	Farnell	H60-25	1092	-	OP-MON
Multimeter	Fluke	79 Series II	3057	12	23-Aug-2022
Attenuator	Weinschel	48-40-43-LIM	5134	12	03-Jan-2022
Attenuator	Aeroflex / Weinschel	47-10-34	3166	12	13-Sep-2022
Network Analyser	Rohde & Schwarz	ZVA 40	3548	12	29-Jan-2022
Calibration Unit	Rohde & Schwarz	ZV-Z54	4368	12	30-Dec-2021
Band Edge					
Hygrometer	PCE Instruments	PCE-THB-40	5475	12	06-Apr-2022
Frequency Standard	Spectracom	SecureSync 1200-0408-0601	4393	6	03-Jan-2022
Analyser	Keysight	N9030A	4654	12	24-Nov-2022
Power Supply	Farnell	H60-25	1092	-	OP-MON
Multimeter	Fluke	79 Series II	3057	12	23-Aug-2022
Attenuator	Weinschel	48-40-43-LIM	5134	12	03-Jan-2022
Attenuator	Aeroflex / Weinschel	47-10-34	3166	12	13-Sep-2022
Network Analyser	Rohde & Schwarz	ZVA 40	3548	12	29-Jan-2022
Calibration Unit	Rohde & Schwarz	ZV-Z54	4368	12	30-Dec-2021
Transmitter Spurious Emissions					
Hygrometer	PCE Instruments	PCE-THB-40	5475	12	06-Apr-2022
Frequency Standard	Spectracom	SecureSync 1200-0408-0601	4393	6	03-Jan-2022
Analyser	Keysight	N9030A	4654	12	24-Nov-2022



Instrument	Manufacturer	Type No.	TE No.	Calibration Period (months)	Calibration Due
Power Supply	Farnell	H60-25	1092	-	OP-MON
Multimeter	Fluke	79 Series II	3057	12	23-Aug-2022
Attenuator	Weinschel	48-40-43-LIM	5134	12	03-Jan-2022
Attenuator	Aeroflex / Weinschel	47-10-34	3166	12	13-Sep-2022
Network Analyser	Rohde & Schwarz	ZVA 40	3548	12	29-Jan-2022
Calibration Unit	Rohde & Schwarz	ZV-Z54	4368	12	30-Dec-2021
HPF	Advance Power Components	11SH10-3000/X18000-O/O	4411	12	02-Jul-2022
Cable	Junkosha	MWX241-01000KMS	5414	12	23-Jun-2022
Cable	Rosenberger	LU1-001-2000	5020	12	07-Jan-2022
Waveguide filter	Quasar	QWS20SB-UBR-UBR-50	5789	12	04/05/2022
WG20 Coaxial Adapter	Quasar	QWC20SB-UBR-K-F	5785	-	OP-MON
WG20 Coaxial Adapter	Quasar	QWC20SB-UBR-K-F	5786	-	OP-MON
Cable attenuator	Aralab	CSF6767C-C2S6500	5175	-	OP-MON
Radiated Emissions					
Antenna with attenuator (Bilog, 30 MHz to 3 GHz)	Schaffner	CBL6143	287	24	14-Oct-2022
Pre-Amplifier (8 GHz to 18 GHz)	Phase One	PS04-0086	1533	12	05-Feb-2022
Comb Generator	Schaffner	RSG1000	3034	-	TU
Multimeter	Fluke	79 Series II	3057	12	23-Aug-2022
Test Receiver	Rohde & Schwarz	ESU40	3506	12	18-Mar-2022
Cable 1503 2M 2.92(P)m 2.92(P)m	Rhophase	KPS-1503A-2000-KPS	4293	12	18-Nov-2022
Cable (K-Type to K-Type, 2 m)	Scott Cables	KPS-1501-2000-KPS	4526	6	06-Mar-2022
Cable (N-Type to N-Type, 1 m)	Rosenberger	LU7-036-1000	5031	12	23-Jul-2022
Emissions Software	TUV SUD	EmX V2.1.11 V.2.1.11	5125	-	Software
DRG Horn Antenna (7.5-18GHz)	Schwarzbeck	HWRD750	5216	12	01-Apr-2022
Digital Multimeter	Keysight Technologies	U1282A	5320	12	25-Aug-2022
Cable (sma-sma, 2 m)	Junkosha	MWX221-02000DMS	5428	12	20-Oct-2022
Cable (N-Type to N-Type, 8 m)	Teledyne	PR90-088-8MTR	5450	6	08-Mar-2022
Thermo-Hygro-Barometer	PCE Instruments	PCE-THB-40	5481	12	31-Mar-2022
Cable (K-Type to K-Type, 1 m)	Junkosha	MWX241-01000KMSKMS/A	5511	12	09-Apr-2022
1m K-Type Cable	Junkosha	MWX241-01000KMSKMS/A	5512	12	09-Apr-2022
2m K Type Cable	Junkosha	MWX241-02000KMSKMS/A	5524	12	24-Mar-2022
Antenna (DRG, 7.5 GHz to 18 GHz)	Schwarzbeck	HWRD750	5610	12	15-Oct-2022
Antenna (DRG, 1 GHz to 10 GHz)	Schwarzbeck	BBHA 9120 B	5611	12	15-Oct-2022
Turntable & Mast Controller	Maturo Gmbh	NCD/498/2799.01	5612	-	TU
Tilt Antenna Mast	Maturo Gmbh	TAM 4.0-P	5613	-	TU
Turntable	Maturo Gmbh	Turntable 1.5 SI-2t	5614	-	TU
Antenna (Bi-Log, 30 MHz to 1 GHz)	Teseq	CBL6111D	5615	24	16-Oct-2022
Screened Room (12)	MVG	EMC-3	5621	36	11-Aug-2023

N/A – Not Applicable

O/P Mon – Output Monitored with Calibrated Equipment



3.2 MEASUREMENT UNCERTAINTY

For a 95% confidence level, the measurement uncertainties for defined systems are:-

Test Discipline	Frequency / Parameter	MU
Conducted Maximum Peak Output Power	9 kHz to 40 GHz Amplitude	± 1.0 dB
Conducted Emissions	9 kHz to 40 GHz Amplitude	± 3.5 dB
Occupied Bandwidth	10 MHz Bandwidth	± 16.7 kHz
	15 MHz Bandwidth	
	20 MHz Bandwidth	
Band Edge	< 3.6 GHz Amplitude	± 0.6 dB
Radiated Spurious Emissions	30 MHz to 1 GHz	± 5.2 dB
	1 GHz to 40 GHz	± 6.3 dB

Measurement Uncertainty Decision Rule

Determination of conformity with the specification limits is based on the decision rule according to IEC Guide 115:2007, Clause 4.4.3 and 4.5.1. (Procedure 2). The measurement results are directly compared with the test limit to determine conformance with the requirements of the standard.

Risk: The uncertainty of measurement about the measured result is negligible with regard to the final pass/fail decision. The measurement result can be directly compared with the test limit to determine conformance with the requirement (compare IEC Guide 115). The level of risk to falsely accept and falsely reject items is further described in ILAC-G8



3.3 MEASUREMENT SOFTWARE USED

List of measurement software versions used for testing.

Instrument	Manufacturer	Type No.	TE No.	Software Version
PXA Signal Analyser	Keysight	N9030B	4654	A22.08
HP-VEE Software	TUV SUD	HP_VEE	N/A	V3.28



SECTION 5

ACCREDITATION, DISCLAIMERS AND COPYRIGHT



4.1 ACCREDITATION, DISCLAIMERS AND COPYRIGHT



This report relates only to the actual item/items tested.

Our UKAS Accreditation does not cover opinions and interpretations and any expressed are outside the scope of our UKAS Accreditation.

Results of tests not covered by our UKAS Accreditation Schedule are marked NUA (Not UKAS Accredited).

© 2022 TÜV SÜD
TÜV SÜD

Postal Address :Octagon House, Concorde Way, Fareham, Hampshire, UK, PO15 5RL



ANNEX A

MODULE LIST



Configuration 1			
Product	Product No	R-State	Serial No
Radio 4478 12A	KRC 161 881/3	R1B	DY3E001456
Software Version:	CXP9013268/15	Revision:	R89AJ