



Report On

FCC Testing of the
Ericsson Remote Radio Unit LTE, NB-IoT, NR, LTE + NR, KRC 161
879/1, LPRU 4410 B5 B12A (700 MHz and 850 MHz), with compatible
Main Unit in a Base Station configuration in accordance with FCC CFR
47 Part 2, FCC CFR 47 Part 22, and FCC CFR Part 27

COMMERCIAL-IN-CONFIDENCE

FCC: TA8AKRC161879-1

PREPARED BY

Handwritten signature of Glen Westwell in black ink.

Glen Westwell
Senior Test Engineer

APPROVED BY

Handwritten signature of Scott Drysdale in black ink.

Scott Drysdale
Authorized Signatory

DATED

May 11, 2020



CONTENTS

Section	Page No
1	REPORT INFORMATION 3
1.1	Report Details 4
1.2	Brief Summary of Results 5
1.3	Configuration Description 6
1.4	Declaration of Build Status 7
2	MAIN EUT 7
1.5	Product Information 9
1.6	Test Setup 10
1.7	Test Conditions 11
1.8	Deviation From The Standard 11
1.9	Modification Record 11
3	TEST DETAILS 12
2.1	Maximum Peak Output Power and Peak to Average Ratio - Conducted 13
2.2	Occupied Bandwidth 37
2.3	Band Edge 41
2.4	Transmitter Spurious Emissions 54
2.5	Frequency Stability 65
4	TEST EQUIPMENT USED 66
3.1	Test Equipment Used 67
3.2	Measurement Uncertainty 68
5	ACCREDITATION, DISCLAIMERS AND COPYRIGHT 69
4.1	Accreditation, Disclaimers and Copyright 70
ANNEX A	Module Lists A.1



SECTION 1

REPORT INFORMATION



1.1 REPORT DETAILS

Manufacturer	Ericsson
Address	Torshamnsgatan 23 Kista SE-16480 Stockholm Sweden
Product Name & Product Number	LPRU 4410 B5 B12A & KRC 161 879/1
Serial Number(s)	TD3F063153
Software Version	CXP 901 3268/17 Revision: R82GS
Hardware Version	R1B
Test Specification/Issue/Date	FCC CFR 47 Part 2: 2019 FCC CFR 47 Part 22: 2019 FCC CFR 47 Part 27: 2019
Test Plan	LPRU 4410 B5B12A_RA_testplan_NR_LTE (TUV SUD)
Product Name & Product Number	LPRU 4410 B5 B13 & KRC 161 887/1
Start of Test	21 April 2020
Finish of Test	24 April 2020
Name of Engineer(s)	Glen Westwell
Related Document(s)	KDB 971168 D01 v02r02 KDB 662911 D01 v02r01

ENGINEERING STATEMENT

The measurements shown in this report were made in accordance with the procedures described on test pages. All reported testing was carried out on a sample equipment to demonstrate compliance with FCC CFR 47 Part 22& 27. The sample tested was found to comply with the requirements defined in the applied rules.

Test Engineer(s);

Glen Westwell



1.2 BRIEF SUMMARY OF RESULTS

A brief summary of results for each configuration, in accordance with FCC CFR 47 Part 2, FCC CFR 47 Part 22 and FCC CFR 47 Part 27 are shown below.

Section	Specification Clause		Test Description	Result
	FCC CFR 47 Part 2	FCC CFR 47 Part 22		
2.1	2.1046	22.913 (a)	Maximum Peak Output Power and Peak to Average Ratio - Conducted	Pass*
2.2	2.1049	22.917 (b)	Occupied Bandwidth	Pass*
2.3	2.1051	22.917	Band Edge	Pass*
2.4	2.1051	22.917	Transmitter Spurious Emissions	Pass*
2.5	2.1055	-	Frequency Stability	Pass*

*Testing for B5 FCC Part 22 has not been performed on the LPRU 4410 B5 B12A, this B5 testing is being reused from Report 75947902 Report 01 which was performed on the LPRU 4410 B5 B13.

Section	Specification Clause		Test Description	Result
	FCC CFR 47 Part 2	FCC CFR 47 Part 27		
2.1	2.1046	27.50	Maximum Peak Output Power and Peak to Average Ratio - Conducted	Pass
2.2	2.1049	27.53	Occupied Bandwidth	Pass
2.3	2.1051	27.53 (g)	Band Edge	Pass
2.4	2.1051	27.53 (g)	Transmitter Spurious Emissions	Pass
2.5	2.1055	27.54	Frequency Stability	Pass

Measurement Uncertainty Decision Statement

Determination of conformity with the specification limits is based on the results of the compliance measurement and does not take into account measurement instrumentation uncertainty as defined in ANSI C63.26:2015 Clause 1.3.



1.3 CONFIGURATION DESCRIPTION

Configuration	RAT	No. Of carriers	Carrier Bandwidth	Carrier Frequency Configuration (MHz)		
				Bottom	Middle	Top
A	LTE	1	5 MHz	731.5	737.0	742.5
			10 MHz	734.0	737.0	740.0
	NR		5 MHz – SCS 15kHz	731.5	737.0	742.5
			10 MHz – SCS 15kHz	734.0	737.0	740.0
			15 MHz – SCS 15kHz	736.5	-	737.5
B	LTE	2	5 MHz	731.5+736.5	-	737.5+742.5
						-
	NR		5 MHz – SCS 15kHz	731.5+736.5	-	737.5+742.5
						-
NR + LTE	10 MHz + 5 MHz – SCS 15kHz	734.0+741.5	-	736.5+737.5		
C	LTE	3	5 MHz	731.5+736.5+742.5	-	732.5+737.5+742.5
						-
	NR		5 MHz – SCS 15kHz	731.5+736.5+741.5	-	732.5+737.5+742.5
NR + LTE	5 MHz + 5 MHz – SCS 15kHz	731.5+736.5+741.5	-	732.5+737.5+742.5		



1.4 DECLARATION OF BUILD STATUS

MAIN EUT	
MANUFACTURING DESCRIPTION	LPRU 4410 B5B12A
MANUFACTURER	Ericsson
TYPE	Remote Radio Base Station
PART NUMBER	KRC 161 879/1
SERIAL NUMBER	TD3F063153
HARDWARE VERSION	R1B
SOFTWARE VERSION	CXP9013268%17_R82GS
TRANSMITTER OPERATING RANGE	B5: 869-894 MHz, B13: 729-745MHz
RECEIVER OPERATING RANGE	B5: 824-849 MHz, B13: 699-715MHz
COUNTRY OF ORIGIN	China
INTERMEDIATE FREQUENCIES	None
EMISSION DESIGNATOR(S): (i.e. G1D, GXW)	B5 and B12A LTE: 5M00W7D, 10M0W7D B5 and B12A NBloT Guardband: 10M0W7D B5 NR: 5M00F9W, 10M0F9W, 15M0F9W, 20M0F9W B12A NR: 5M00F9W, 10M0F9W, 15M0F9W
MODULATION TYPES: (i.e. GMSK, QPSK)	LTE: QPSK, 16QAM, 64QAM, 256QAM NR: QPSK, 16QAM, 64QAM, 256QAM
HIGHEST INTERNALLY GENERATED FREQUENCY	0.894 GHz
OUTPUT POWER (W or dBm)	B5: 4 x 0.05W (17dBm) B12A: 4 x 0.05W (17dBm)
FCC ID	TA8AKRC161879-1
INDUSTRY CANADA ID	
TECHNICAL DESCRIPTION (a brief description of the intended use and operation)	LPRU 4410 B5B12A (KRC 161 879/1) is a Remote Radio Unit forming part of the Ericsson Radio Base Station (RBS) equipment. The LPRU provides radio access for mobile and fixed devices and is intended for the indoor environment. The radio operates over 8 Transmit ports in MRO (LTE, NBloT, and NR); Single, and Multi-Carrier transmission with a maximum rated RF Output of 0.05W per port over an operational temperature of 0°C to +50°C. The unit is designed to be rack mounted. .

Signature: 

Denis Lalonde

Date: 5 May 2020

Declaration of Build Status Serial Number: TD3F063153



No responsibility will be accepted by TÜV SÜD UK Limited as to the accuracy of the information declared in this document by the manufacturer.

1.5 PRODUCT INFORMATION

1.5.1 Technical Description

The Equipment Under Test (EUT) LPRU 4410 B5 B12A is an Ericsson AB Radio Unit working in the public mobile service (700 and 850 MHz) bands which provides communication connections to (700 and 850 MHz) network. The LPRU 4410 B5 B12A operates from a -48V DC supply.

The Equipment Under Test (EUT) is shown in the photograph below. A full technical description can be found in the Manufacturer's documentation.

Equipment Under Test



1.6 TEST SETUP

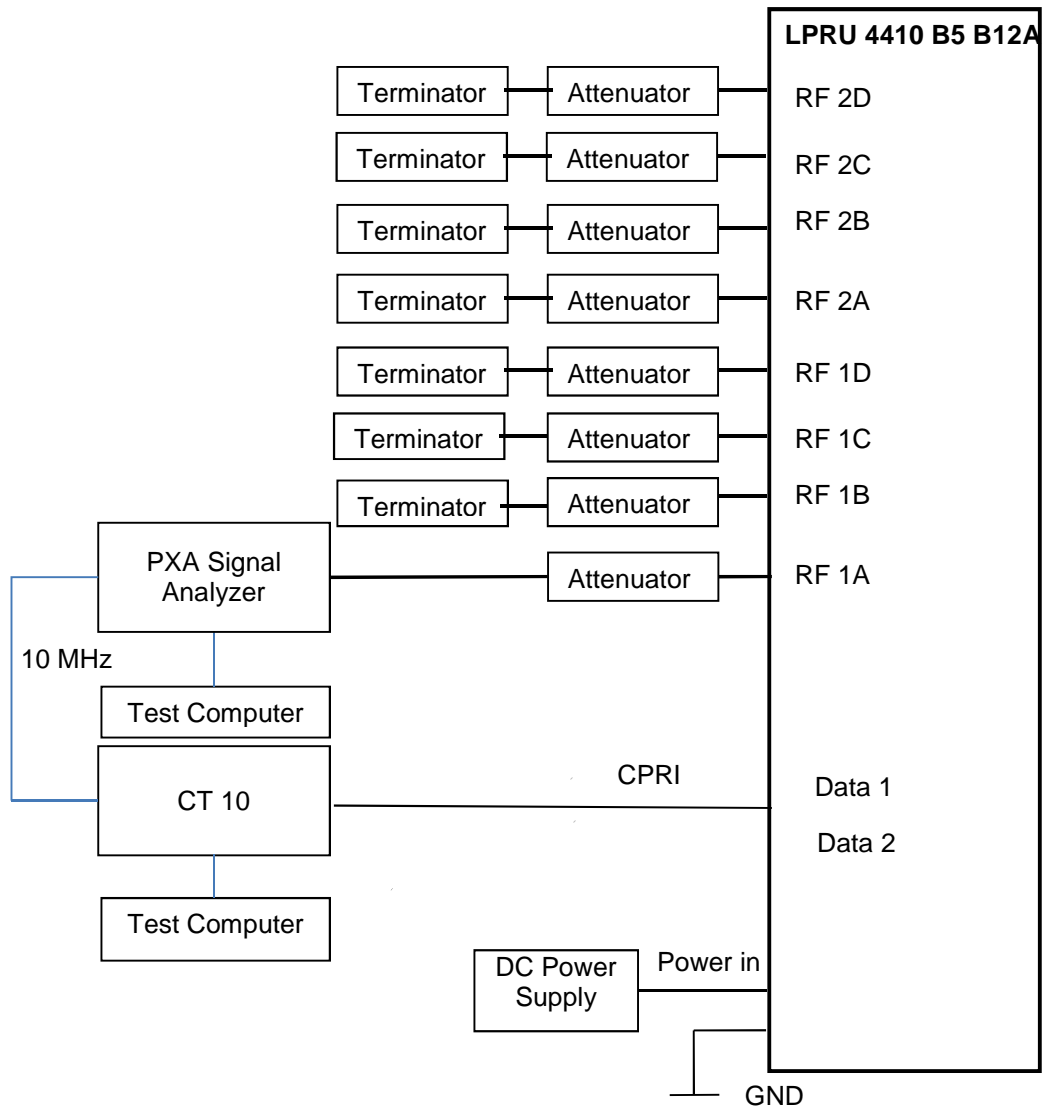



1.7 TEST CONDITIONS

For all tests the EUT was set up in accordance with the relevant test standard and to represent typical operating conditions. Tests were applied with the EUT situated as described in the Test Method for each Test.

The EUT was powered from a -48V DC supply.

FCC Measurement Facility Registration Number: CA4810

1.8 DEVIATION FROM THE STANDARD

No deviations from the applicable test standards or test plan were made during testing.

1.9 MODIFICATION RECORD

No modifications were made to the EUT during testing.



SECTION 2

TEST DETAILS



2.1 MAXIMUM PEAK OUTPUT POWER AND PEAK TO AVERAGE RATIO - CONDUCTED

2.1.1 Specification Reference

FCC CFR 47 Part 27, Clause 27.50
FCC CFR 47 Part 2, Clause 2.1046

2.1.2 Date of Test and Modification State

21 April 2020 - Modification State 0

2.1.3 Test Equipment Used

The major items of test equipment used for the above tests are identified in Section 3.1.

2.1.4 Environmental Conditions

Ambient Temperature	23.5°C
Relative Humidity	31.3%

2.1.5 Test Method

All measurements were made in accordance with FCC KDB 971168 D01, clause 5.2.1 and summed in accordance with FCC KDB 662911 D01.

2.1.6 Test Results



Configuration A

Maximum Output Power: 17.00 dBm per port.

Antenna	Modulation	Carrier Bandwidth	Peak to Average Ratio (PAR) / Output Power		
			Channel Position B		
			PAR (dB)	Average Power	
dBm	dBm/MHz				
A	LTE: QPSK	5.0 MHz	8.89	16.39	10.65
B	LTE: QPSK	5.0 MHz	8.95	16.26	10.47
C	LTE: QPSK	5.0 MHz	8.95	16.26	10.47
D	LTE: QPSK	5.0 MHz	8.98	16.36	10.65
Total			-	22.34	16.58
A	LTE: QPSK	10.0 MHz	9.05	15.89	7.64
B	LTE: QPSK	10.0 MHz	9.03	16.27	7.63
C	LTE: QPSK	10.0 MHz	8.97	15.96	7.47
D	LTE: QPSK	10.0 MHz	8.96	16.34	7.77
Total			-	22.14	13.65
A	NR: QPSK	5.0 MHz	8.93	16.46	10.81
B	NR: QPSK	5.0 MHz	8.93	16.56	10.89
C	NR: QPSK	5.0 MHz	8.99	16.44	10.91
D	NR: QPSK	5.0 MHz	8.95	16.53	10.96
Total			-	22.52	16.91
A	NR: QPSK	10.0 MHz	9.24	16.17	7.84
B	NR: QPSK	10.0 MHz	8.96	16.27	7.88
C	NR: QPSK	10.0 MHz	9.06	16.24	8.01
D	NR: QPSK	10.0 MHz	8.98	16.35	7.77
Total			-	22.28	13.90
A	NR: QPSK	15.0 MHz	9.27	16.68	6.30
B	NR: QPSK	15.0 MHz	9.09	16.17	5.91
C	NR: QPSK	15.0 MHz	9.11	16.10	5.64
D	NR: QPSK	15.0 MHz	9.05	16.08	5.77
Total			-	22.29	11.93

Remarks

All transmitter antenna port performance is presented. The plot results are presented for regulatory performance reference. Plot data performance for all transmitter ports are on file and available on request.

Antenna A - Modulation LTE: QPSK - Carrier Bandwidth 5.0 MHz - Channel Position B

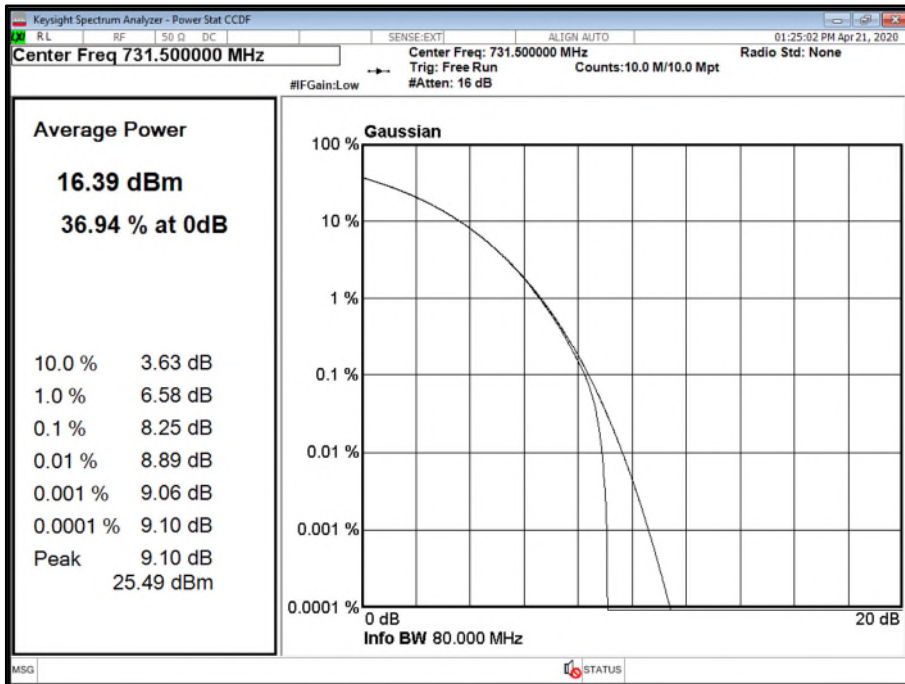

Antenna A - Modulation LTE: QPSK - Carrier Bandwidth 5.0 MHz - Channel Position B

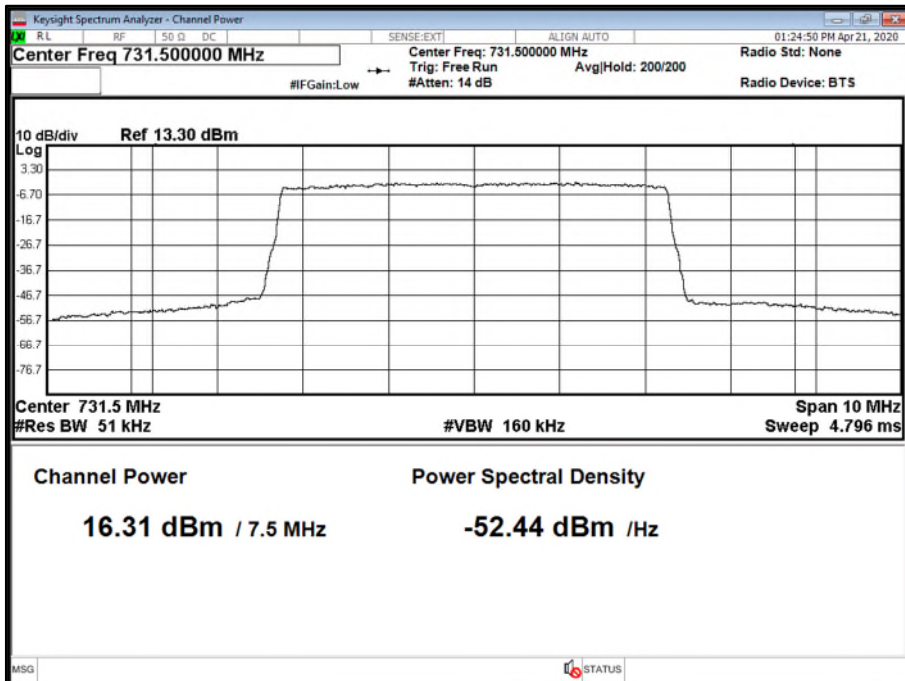

Antenna A - Modulation LTE: QPSK - Carrier Bandwidth 10.0 MHz - Channel Position B

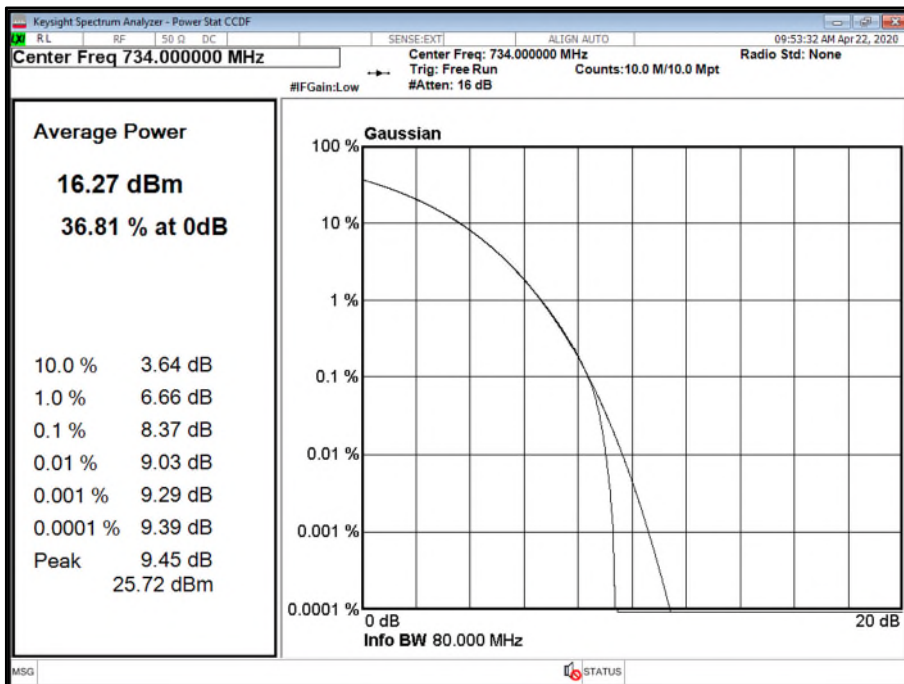

Antenna A - Modulation LTE: QPSK - Carrier Bandwidth 10.0 MHz - Channel Position B

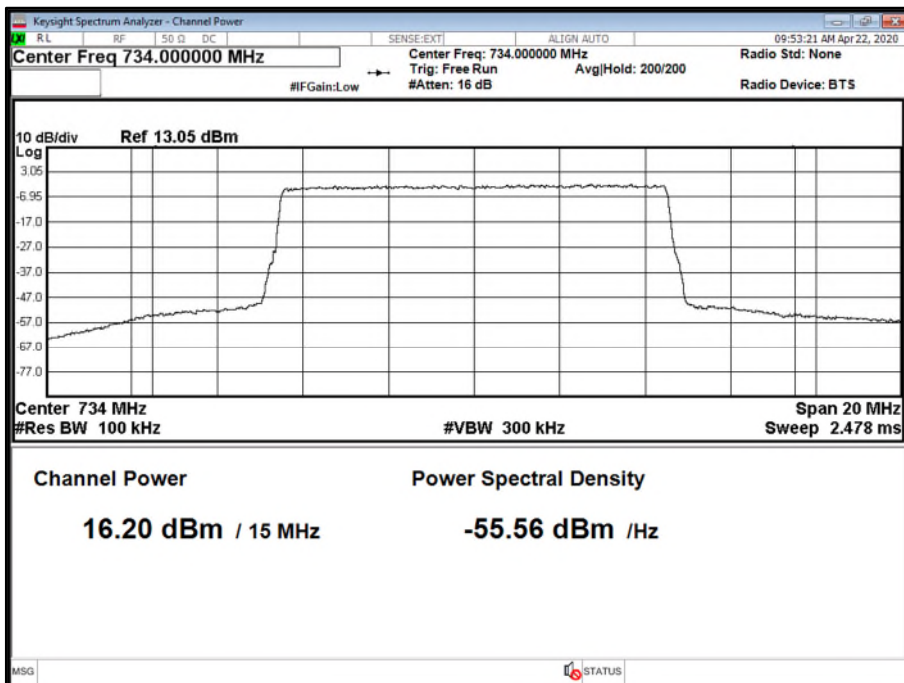

Antenna A - Modulation NR: QPSK - Carrier Bandwidth 5.0 MHz - Channel Position B

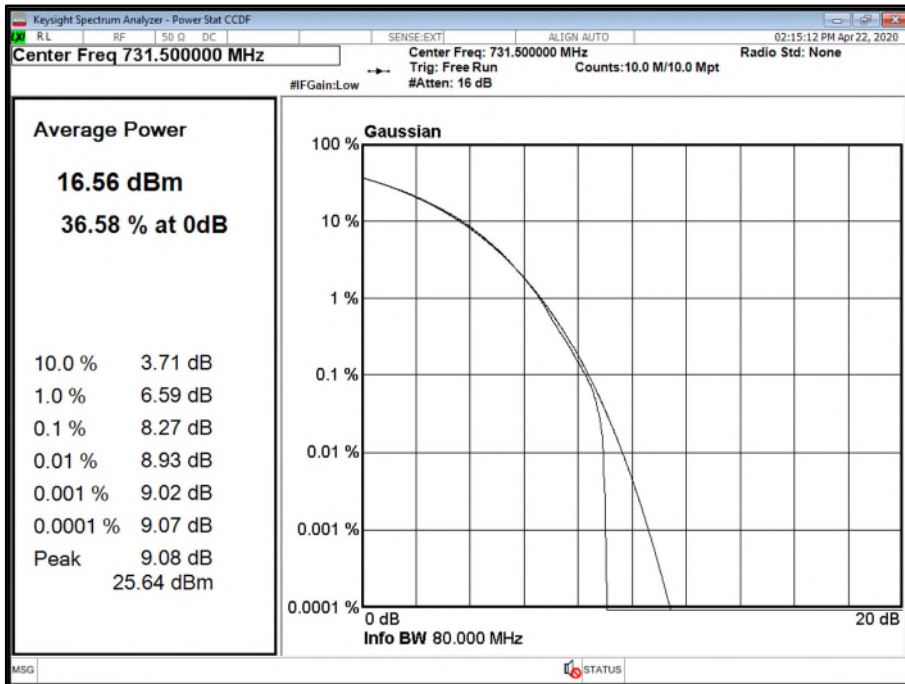

Antenna A - Modulation NR: QPSK - Carrier Bandwidth 5.0 MHz - Channel Position B

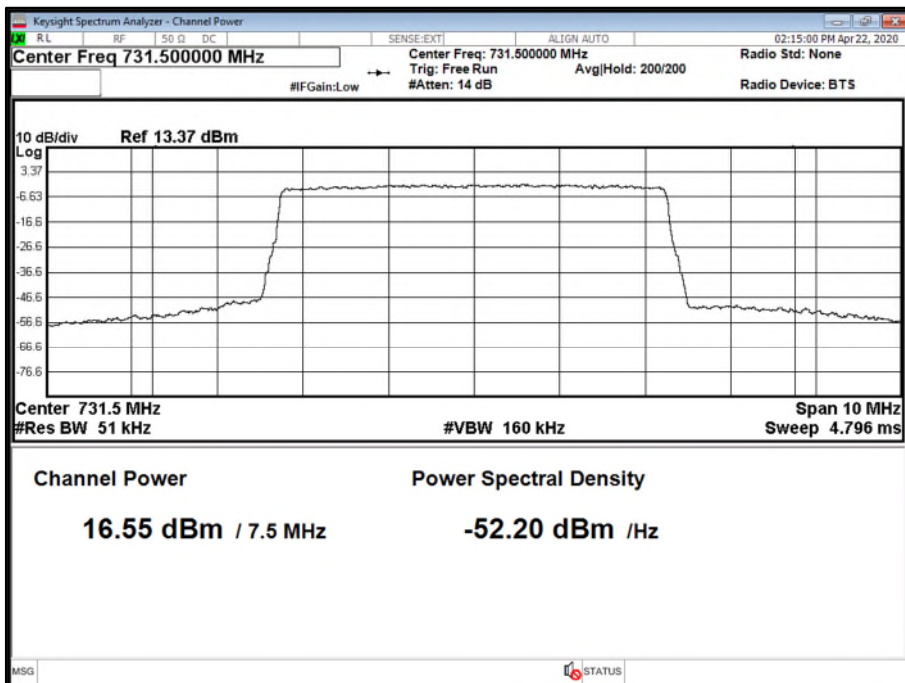



Antenna A - Modulation NR: QPSK - Carrier Bandwidth 10.0 MHz - Channel Position B

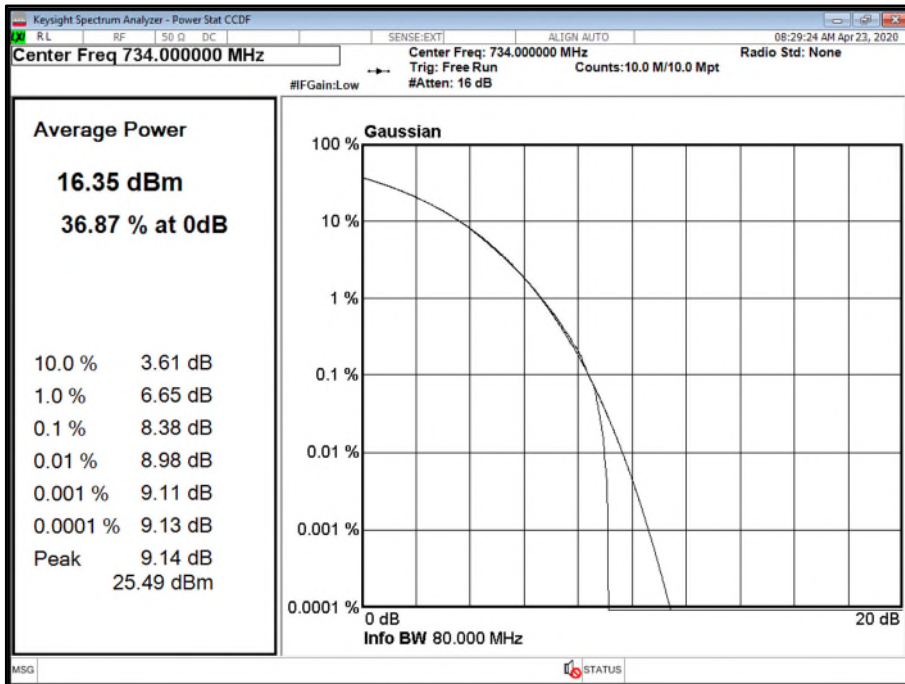

Antenna A - Modulation NR: QPSK - Carrier Bandwidth 10.0 MHz - Channel Position B

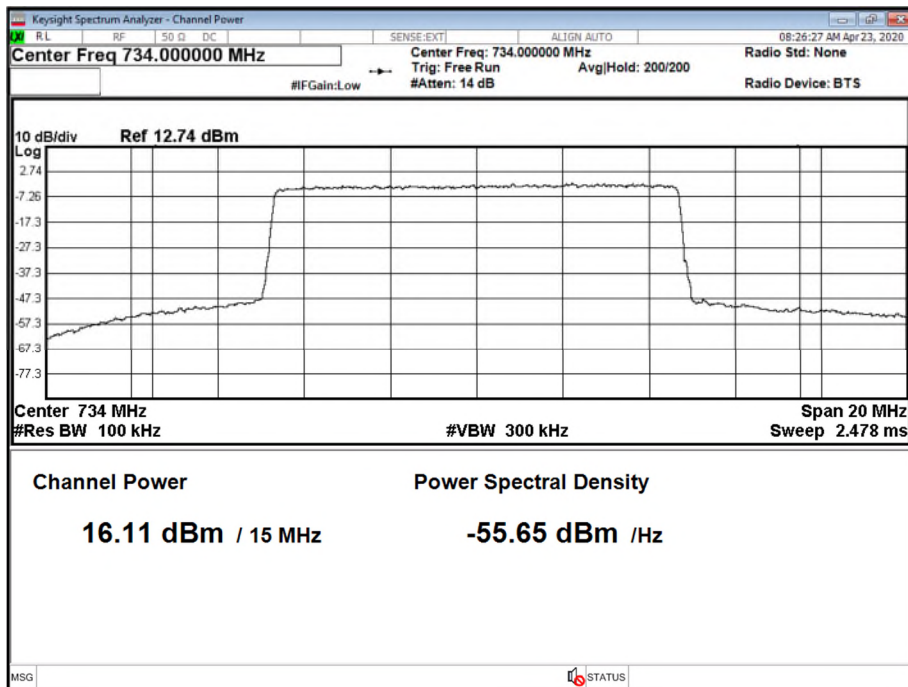



Antenna A - Modulation NR: QPSK - Carrier Bandwidth 15.0 MHz - Channel Position B

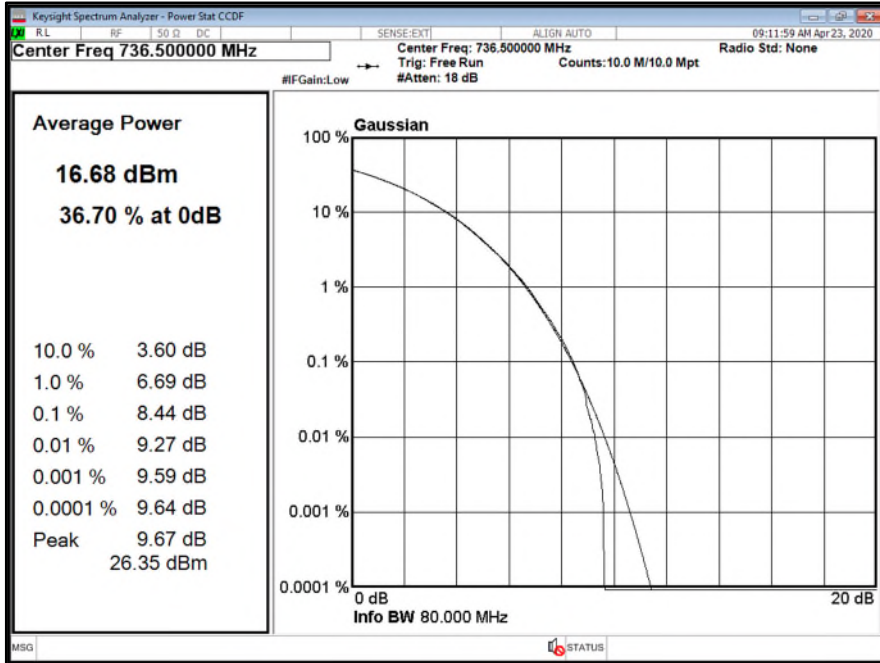

Antenna A - Modulation NR: QPSK - Carrier Bandwidth 15.0 MHz - Channel Position B

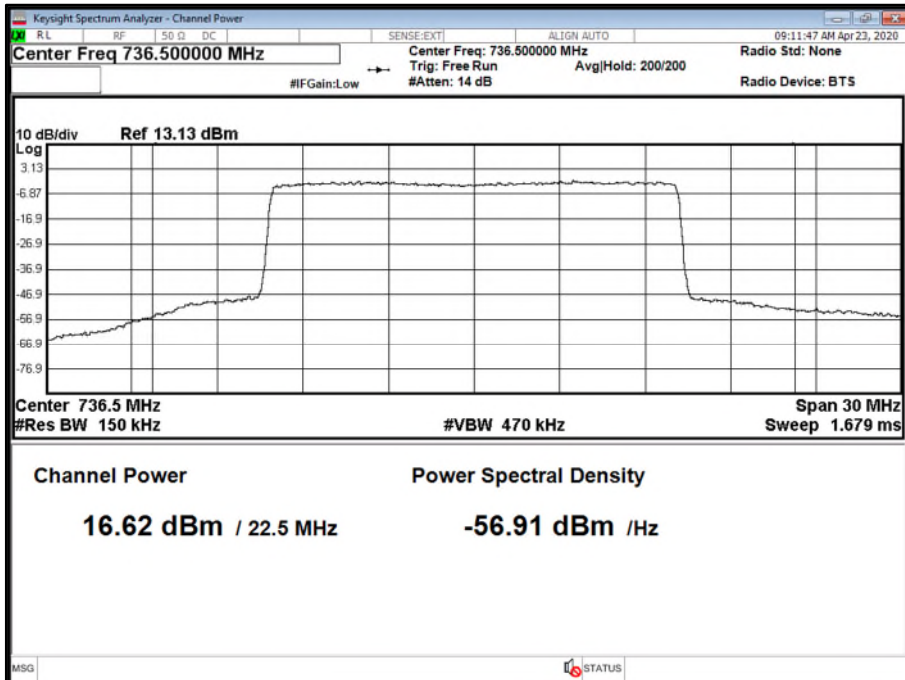



Configuration A

Maximum Output Power: 17.00 dBm per port.

Antenna	Modulation	Carrier Bandwidth	Peak to Average Ratio (PAR) / Output Power		
			Channel Position M		
			PAR (dB)	Average Power	
dBm	dBm/MHz				
A	LTE: QPSK	5.0 MHz	8.86	16.50	10.74
B	LTE: QPSK	5.0 MHz	8.97	16.44	10.75
C	LTE: QPSK	5.0 MHz	8.90	16.35	10.51
D	LTE: QPSK	5.0 MHz	8.94	16.44	10.77
Total			-	22.45	16.71
A	LTE: QPSK	10.0 MHz	8.92	16.39	7.76
B	LTE: QPSK	10.0 MHz	8.95	16.18	7.80
C	LTE: QPSK	10.0 MHz	8.90	16.50	7.92
D	LTE: QPSK	10.0 MHz	9.00	15.96	7.32
Total			-	22.28	13.73
A	NR: QPSK	5.0 MHz	8.89	16.50	10.96
B	NR: QPSK	5.0 MHz	8.94	16.47	10.86
C	NR: QPSK	5.0 MHz	8.88	16.37	10.91
D	NR: QPSK	5.0 MHz	8.88	16.49	10.83
Total			-	22.48	16.91
A	NR: QPSK	10.0 MHz	8.96	16.53	8.09
B	NR: QPSK	10.0 MHz	8.95	16.20	7.72
C	NR: QPSK	10.0 MHz	8.95	16.14	7.59
D	NR: QPSK	10.0 MHz	9.07	15.98	7.46
Total			-	22.24	13.74

Remarks

All transmitter antenna port performance is presented. The plot results are presented for regulatory performance reference. Plot data performance for all transmitter ports are on file and available on request. Note: 15MHz Ch. Have test results for bottom and top channels only due to spectrum restrictions of 16 MHz.



Antenna A - Modulation LTE: QPSK - Carrier Bandwidth 5.0 MHz - Channel Position M

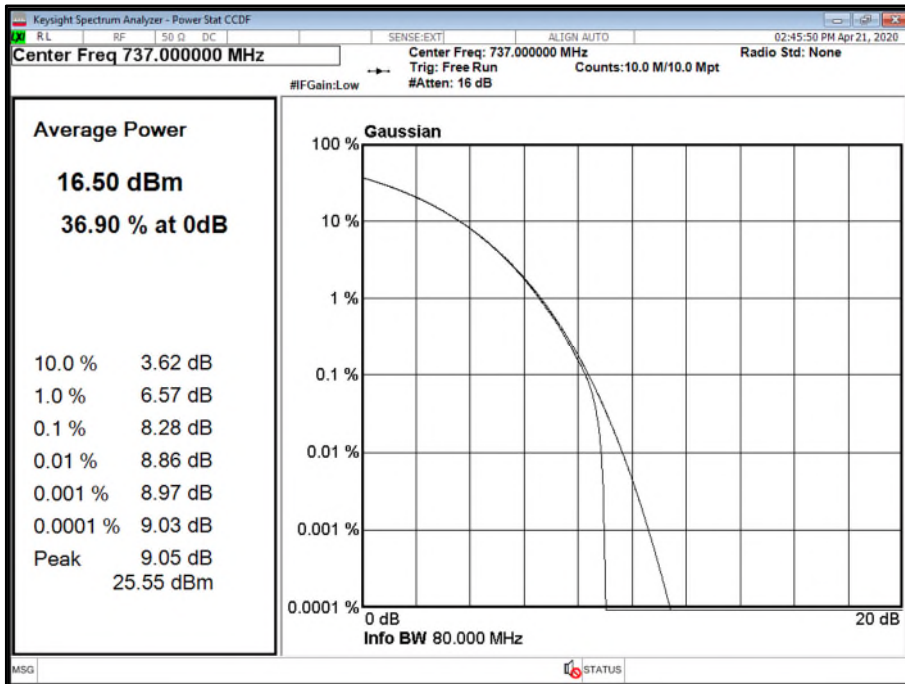

Antenna A - Modulation LTE: QPSK - Carrier Bandwidth 5.0 MHz - Channel Position M

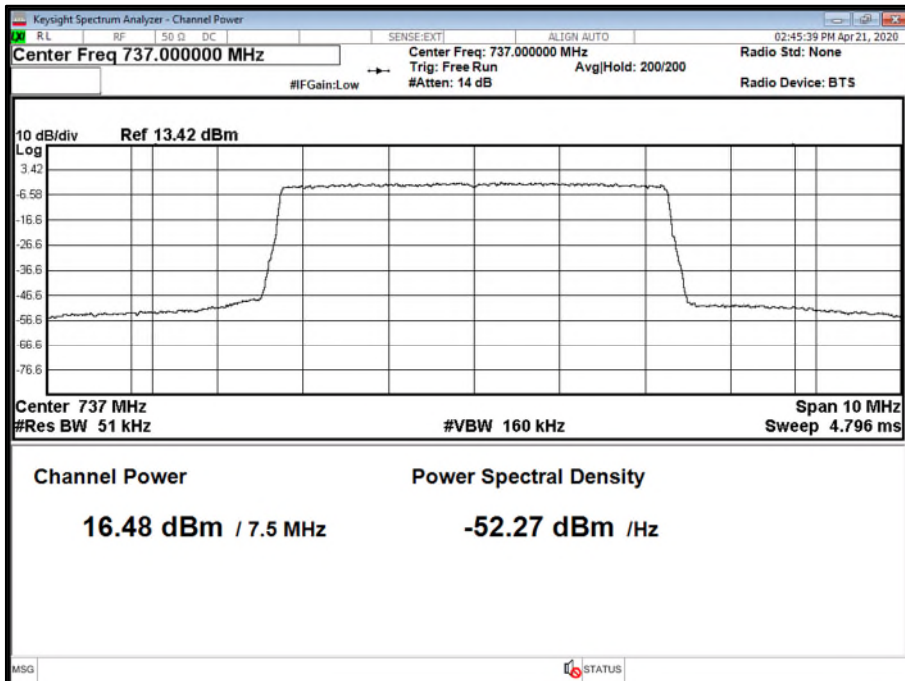

Antenna A - Modulation LTE: QPSK - Carrier Bandwidth 10.0 MHz - Channel Position M

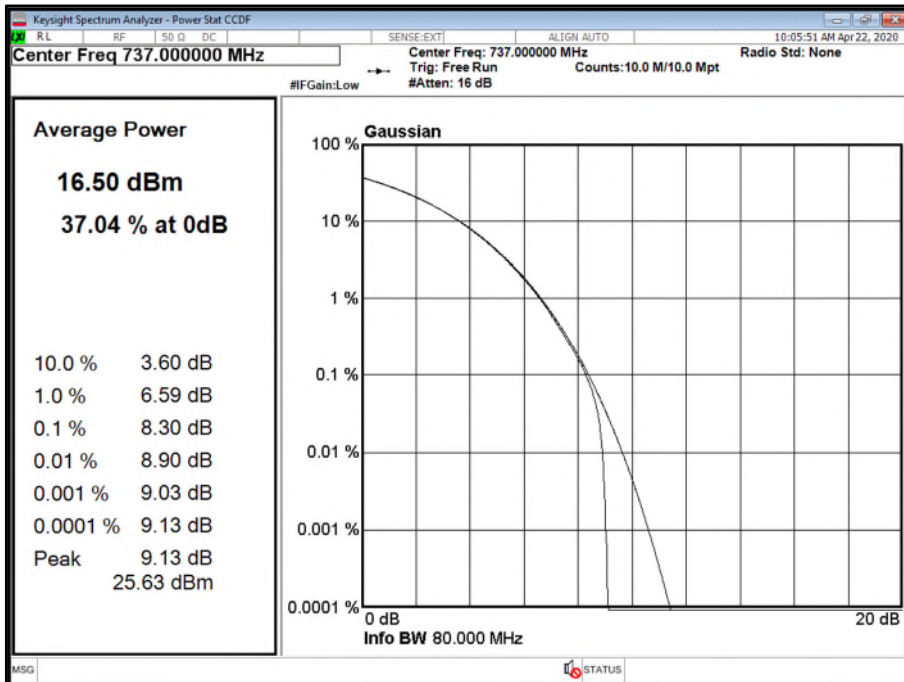

Antenna A - Modulation LTE: QPSK - Carrier Bandwidth 10.0 MHz - Channel Position M

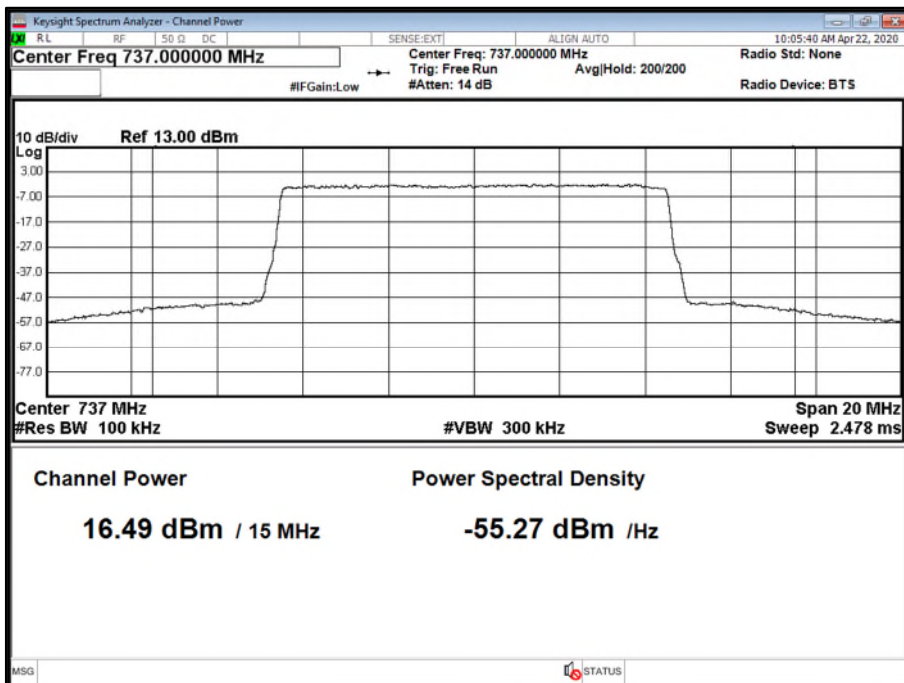

Antenna A - Modulation NR: QPSK - Carrier Bandwidth 5.0 MHz - Channel Position M

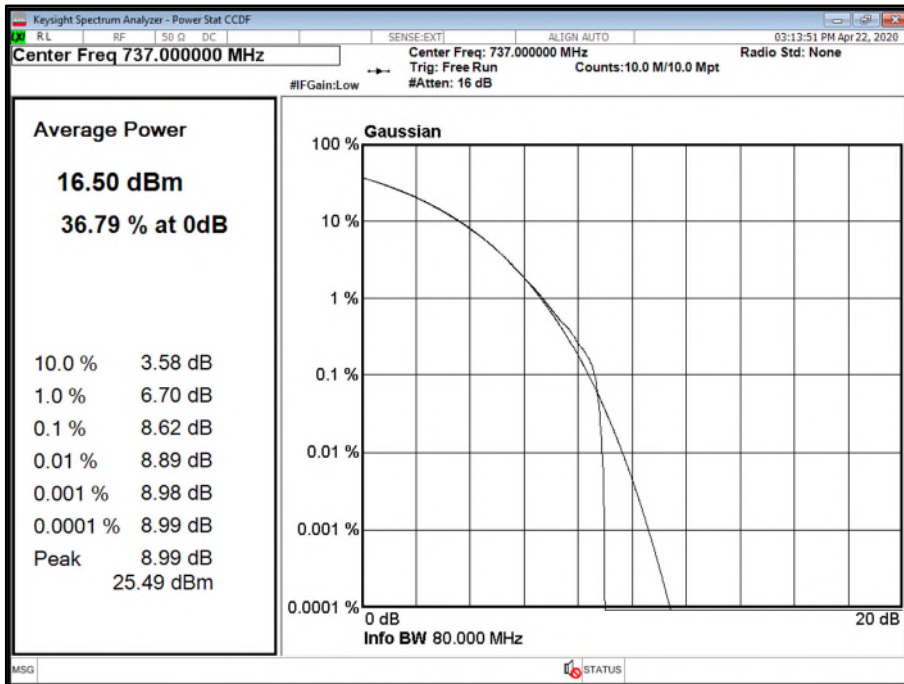

Antenna A - Modulation NR: QPSK - Carrier Bandwidth 5.0 MHz - Channel Position M

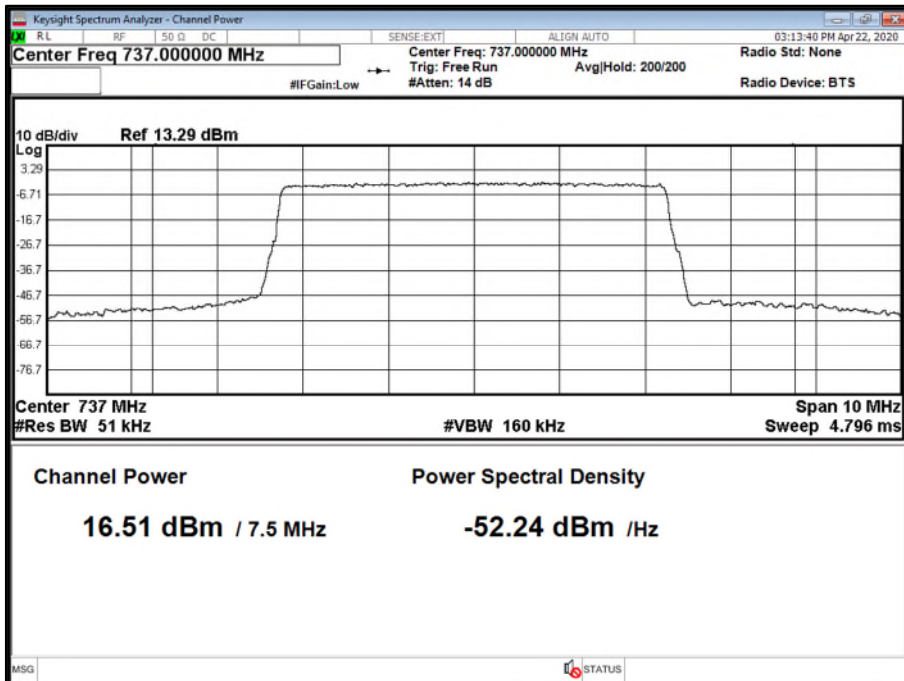



Antenna A - Modulation NR: QPSK - Carrier Bandwidth 10.0 MHz - Channel Position M

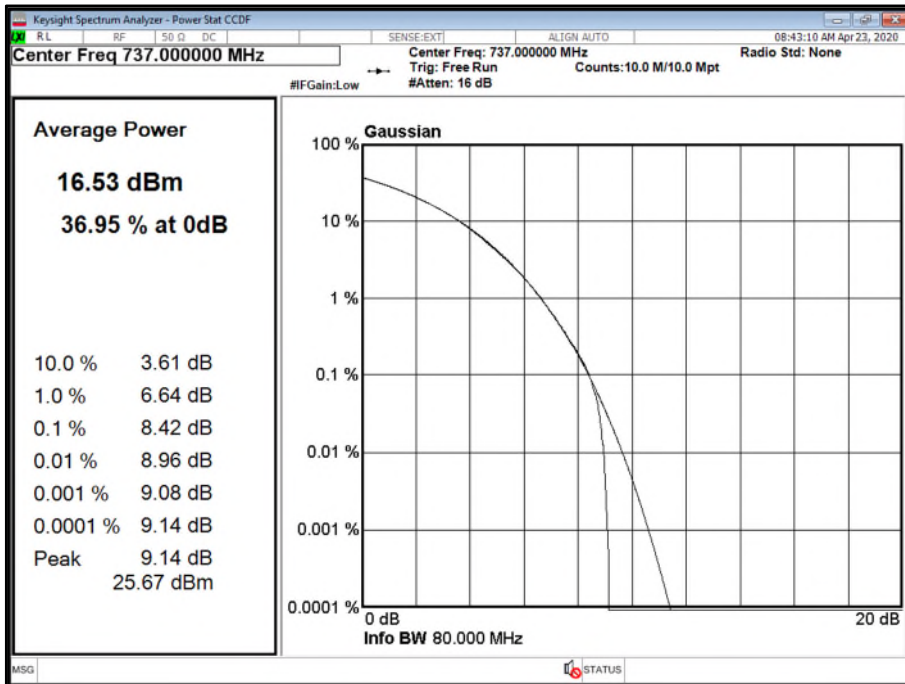

Antenna A - Modulation NR: QPSK - Carrier Bandwidth 10.0 MHz - Channel Position M

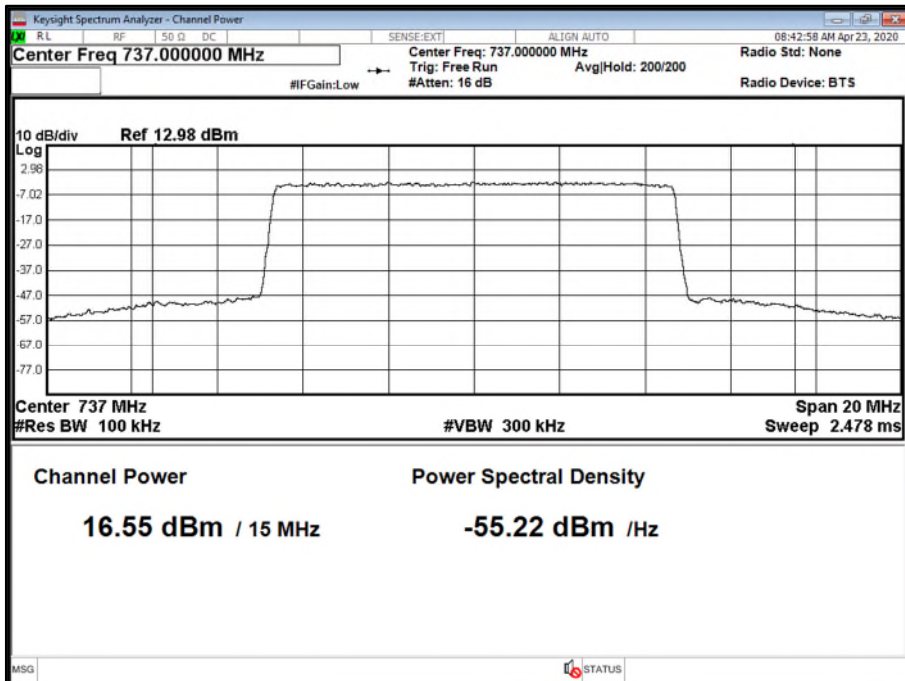



Configuration A

Maximum Output Power: 17.00 dBm per port.

Antenna	Modulation	Carrier Bandwidth	Peak to Average Ratio (PAR) / Output Power		
			PAR (dB)	Channel Position T	
				Average Power	
				dBm	dBm/MHz
A	LTE: QPSK	5.0 MHz	8.87	16.49	10.77
B	LTE: QPSK	5.0 MHz	9.01	16.73	11.10
C	LTE: QPSK	5.0 MHz	8.94	16.58	10.80
D	LTE: QPSK	5.0 MHz	8.93	16.14	10.35
Total			-	22.51	16.78
A	LTE: QPSK	10.0 MHz	8.89	16.28	7.88
B	LTE: QPSK	10.0 MHz	8.97	16.21	7.89
C	LTE: QPSK	10.0 MHz	8.91	16.11	7.70
D	LTE: QPSK	10.0 MHz	9.02	15.97	7.70
Total			-	22.16	13.81
A	NR: QPSK	5.0 MHz	8.91	16.53	10.95
B	NR: QPSK	5.0 MHz	8.93	16.49	11.07
C	NR: QPSK	5.0 MHz	8.91	16.58	11.01
D	NR: QPSK	5.0 MHz	8.95	16.33	10.67
Total			-	22.50	16.95
A	NR: QPSK	10.0 MHz	8.90	16.32	7.86
B	NR: QPSK	10.0 MHz	8.96	16.23	7.59
C	NR: QPSK	10.0 MHz	8.86	16.14	7.49
D	NR: QPSK	10.0 MHz	8.96	16.00	7.57
Total			-	22.19	13.65
A	NR: QPSK	15.0 MHz	9.13	16.67	6.29
B	NR: QPSK	15.0 MHz	9.02	15.93	5.74
C	NR: QPSK	15.0 MHz	9.06	16.12	5.86
D	NR: QPSK	15.0 MHz	9.04	15.85	5.33
Total			-	22.18	11.84

Remarks

All transmitter antenna port performance is presented. The plot results are presented for regulatory performance reference. Plot data performance for all transmitter ports are on file and available on request.



Antenna A - Modulation LTE: QPSK - Carrier Bandwidth 5.0 MHz - Channel Position T

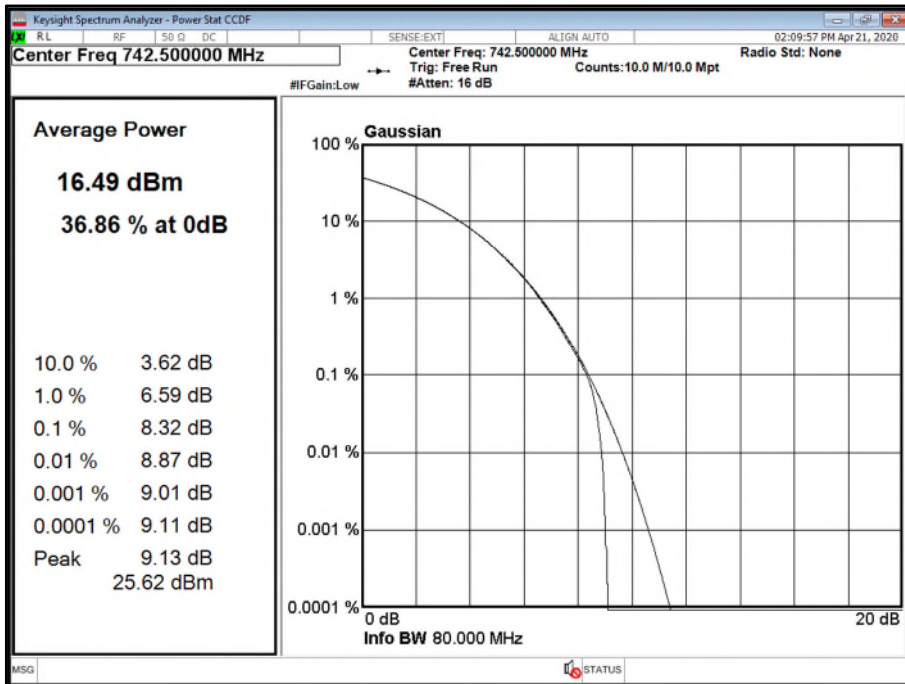

Antenna A - Modulation LTE: QPSK - Carrier Bandwidth 5.0 MHz - Channel Position T

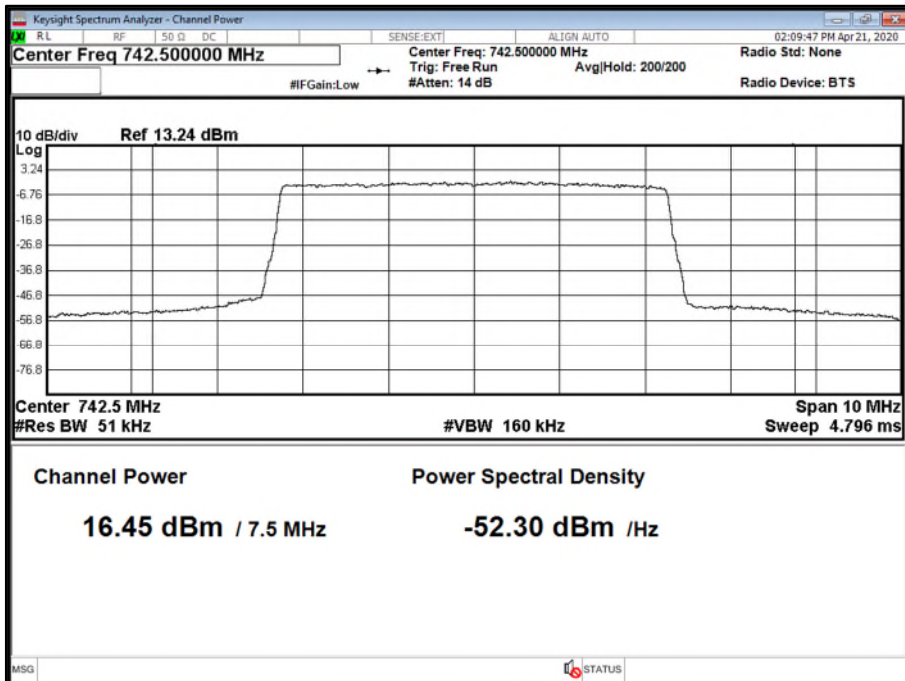

Antenna A - Modulation LTE: QPSK - Carrier Bandwidth 10.0 MHz - Channel Position T

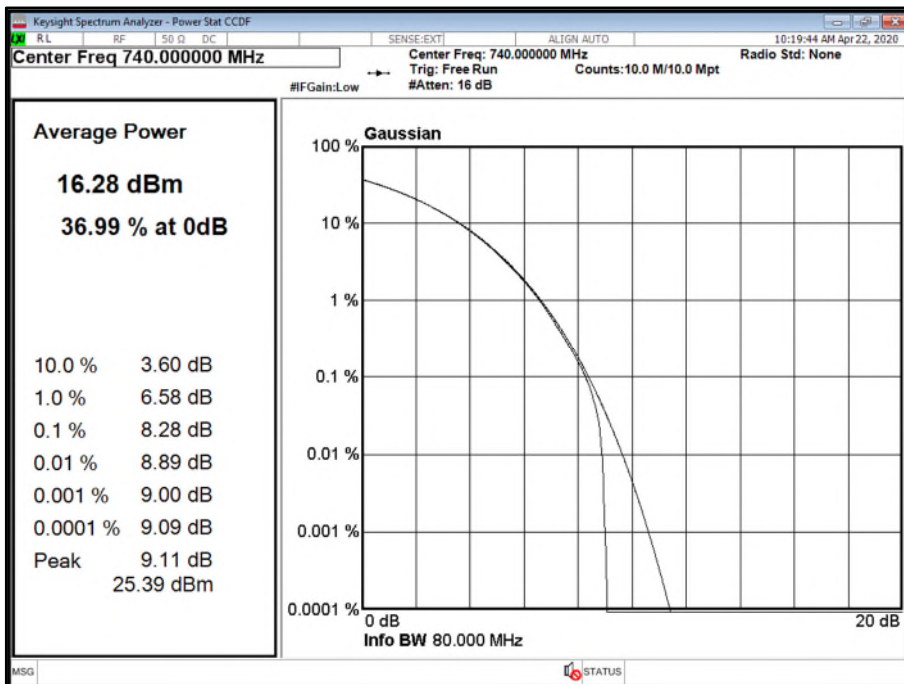

Antenna A - Modulation LTE: QPSK - Carrier Bandwidth 10.0 MHz - Channel Position T

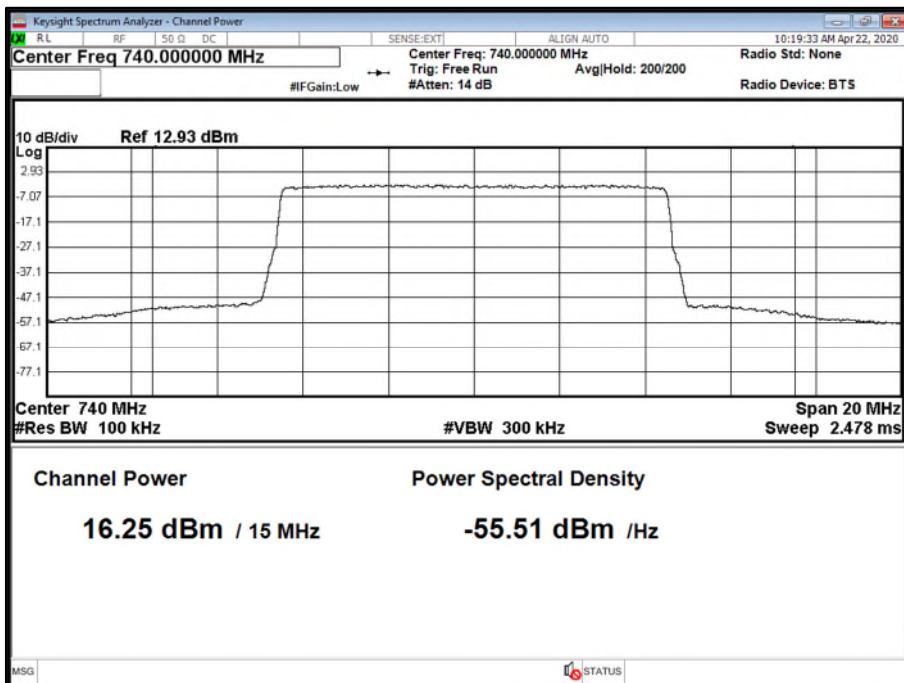



Antenna A - Modulation NR: QPSK - Carrier Bandwidth 5.0 MHz - Channel Position T

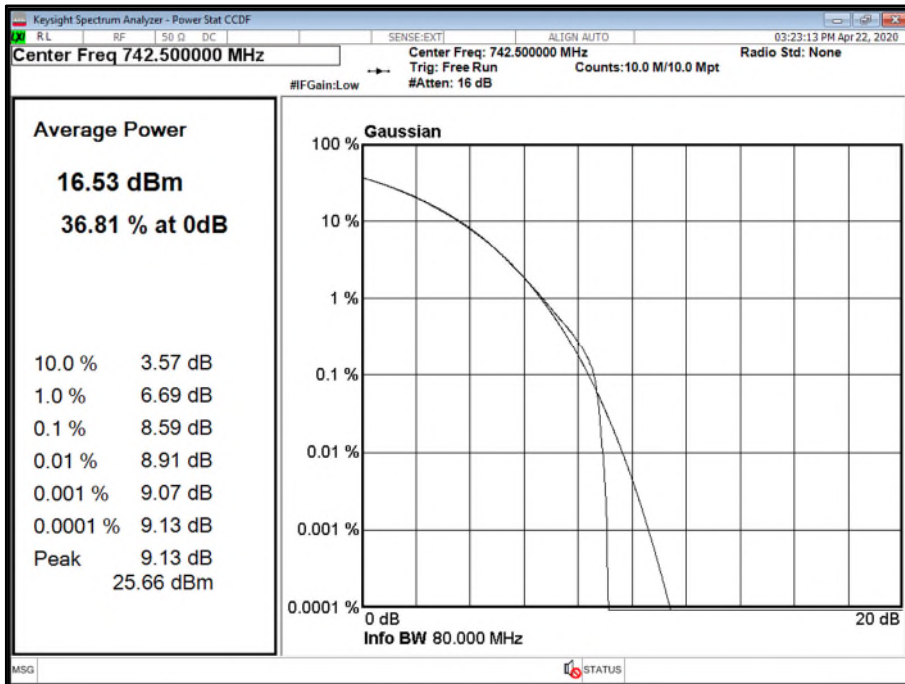

Antenna A - Modulation NR: QPSK - Carrier Bandwidth 5.0 MHz - Channel Position T

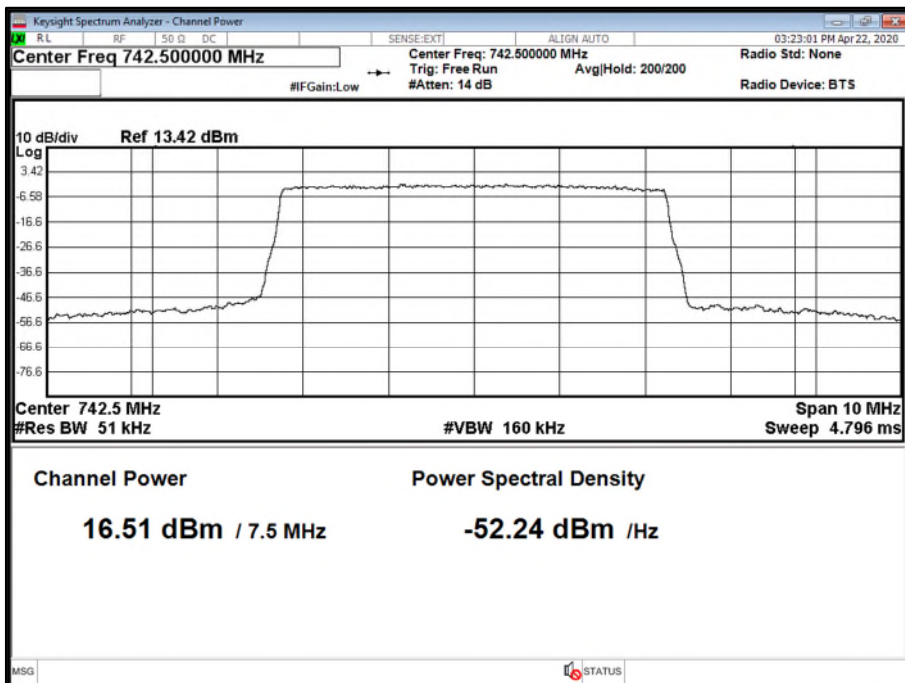

Antenna A - Modulation NR: QPSK - Carrier Bandwidth 10.0 MHz - Channel Position T

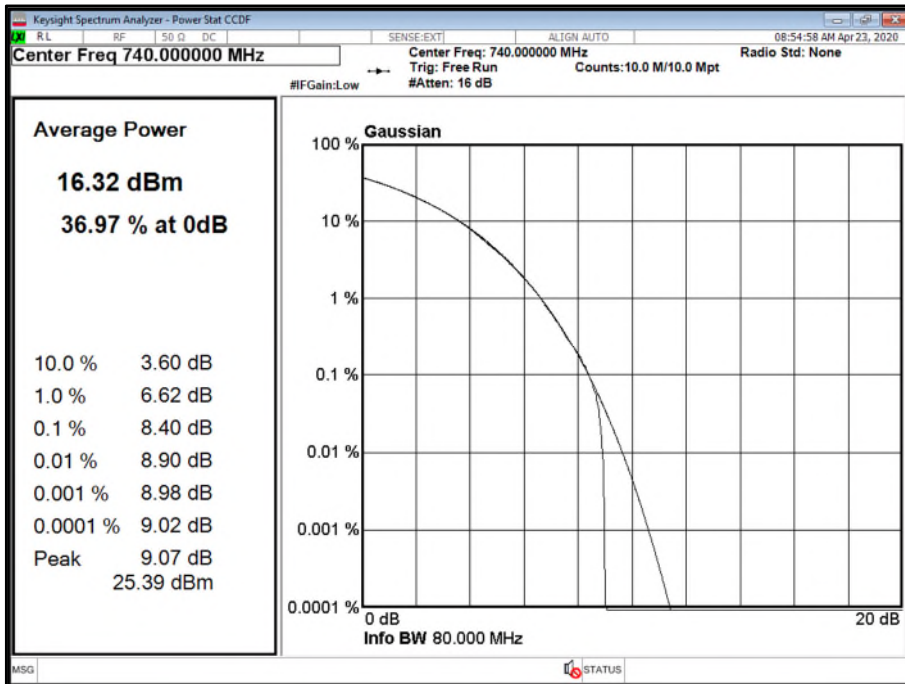

Antenna A - Modulation NR: QPSK - Carrier Bandwidth 10.0 MHz - Channel Position T

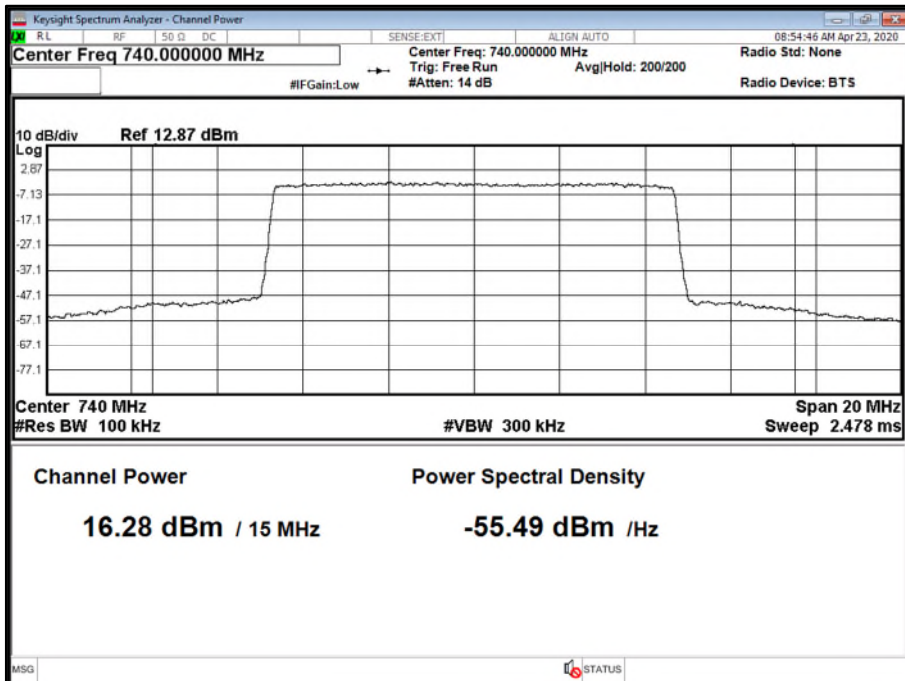



Antenna A - Modulation NR: QPSK - Carrier Bandwidth 15.0 MHz - Channel Position T

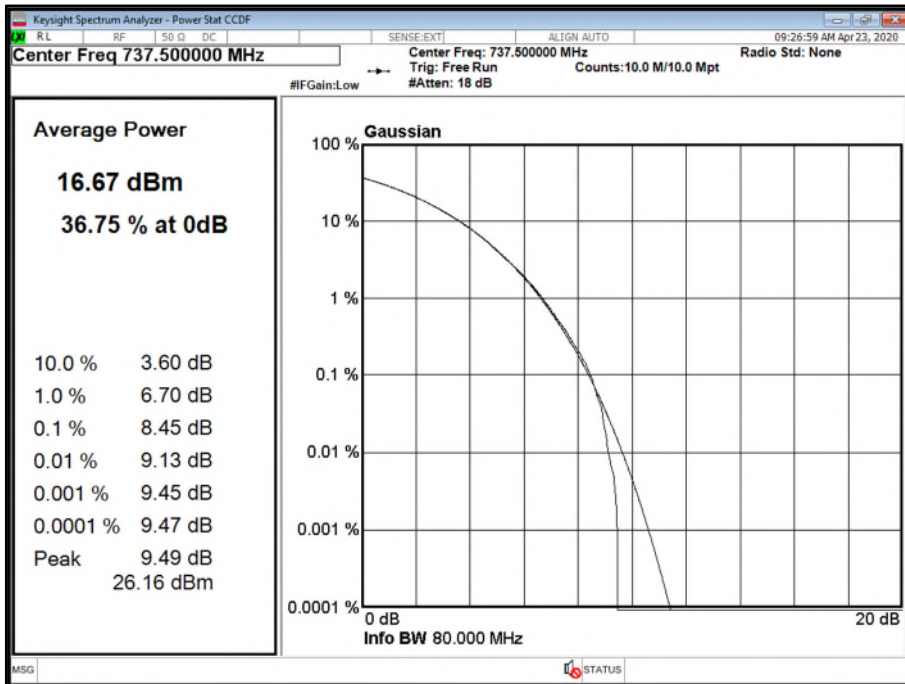

Antenna A - Modulation NR: QPSK - Carrier Bandwidth 15.0 MHz - Channel Position T

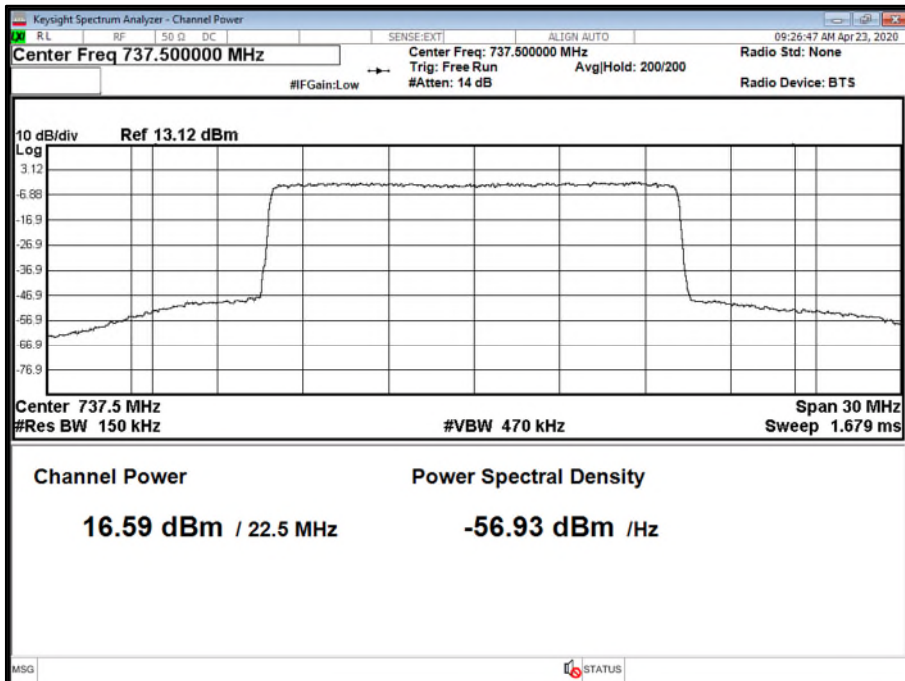



Configuration B

Maximum Output Power: 17.00 dBm per port.

Antenna	Modulation	Carrier Bandwidth	Peak to Average Ratio (PAR) / Output Power		
			Channel Position B		
			PAR (dB)	Average Power	
dBm	dBm/MHz				
A	LTE: QPSK	5.0+5.0 MHz	-	16.31	-
B	LTE: QPSK	5.0+5.0 MHz	-	16.24	-
C	LTE: QPSK	5.0+5.0 MHz	-	16.24	-
D	LTE: QPSK	5.0+5.0 MHz	-	16.21	-
Total			-	22.27	-
A	NR: QPSK	5.0+5.0 MHz	-	16.21	-
B	NR: QPSK	5.0+5.0 MHz	-	16.27	-
C	NR: QPSK	5.0+5.0 MHz	-	16.21	-
D	NR: QPSK	5.0+5.0 MHz	-	16.80	-
Total			-	22.40	-
A	LTE + NR: QPSK	L10 + NR5.0 MHz	-	16.18	-
B	LTE + NR: QPSK	L10 + NR5.0 MHz	-	15.82	-
C	LTE + NR: QPSK	L10 + NR5.0 MHz	-	15.98	-
D	LTE + NR: QPSK	L10 + NR5.0 MHz	-	15.70	-
Total			-	21.94	-

Remarks

10 MHz LTE has NB-IoT GB x2. Two carrier transmitter performance is presented. The plot results represent typical radio performance. Plot data performance for all transmitter ports and channels are on file and available on request.



Antenna A - Modulation LTE: QPSK - Carrier Bandwidth 5.0 +5.0 MHz - Channel Position B

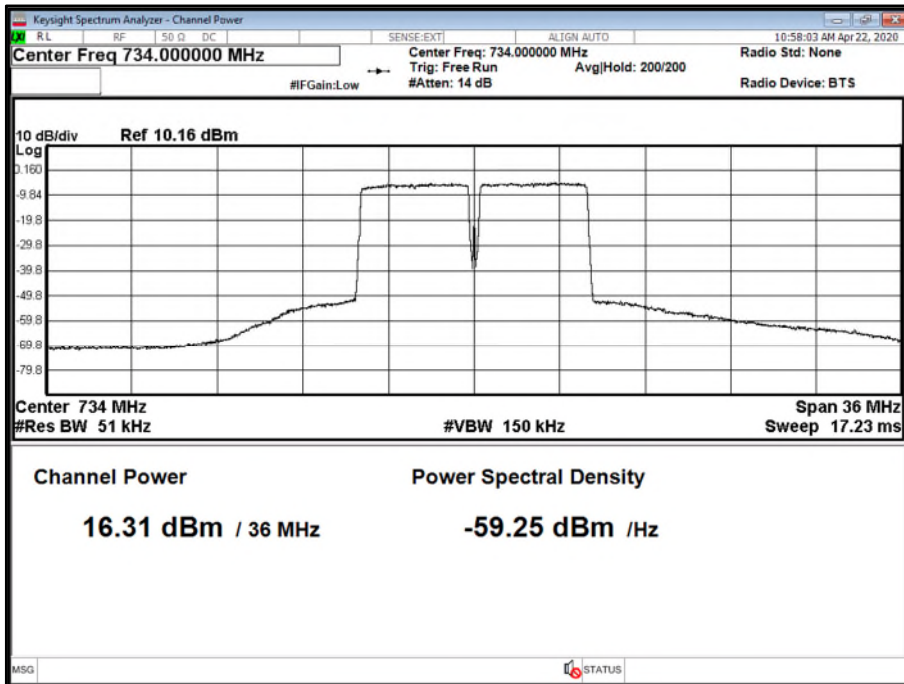

Antenna A - Modulation NR: QPSK - Carrier Bandwidth 5.0 +5.0 MHz - Channel Position B

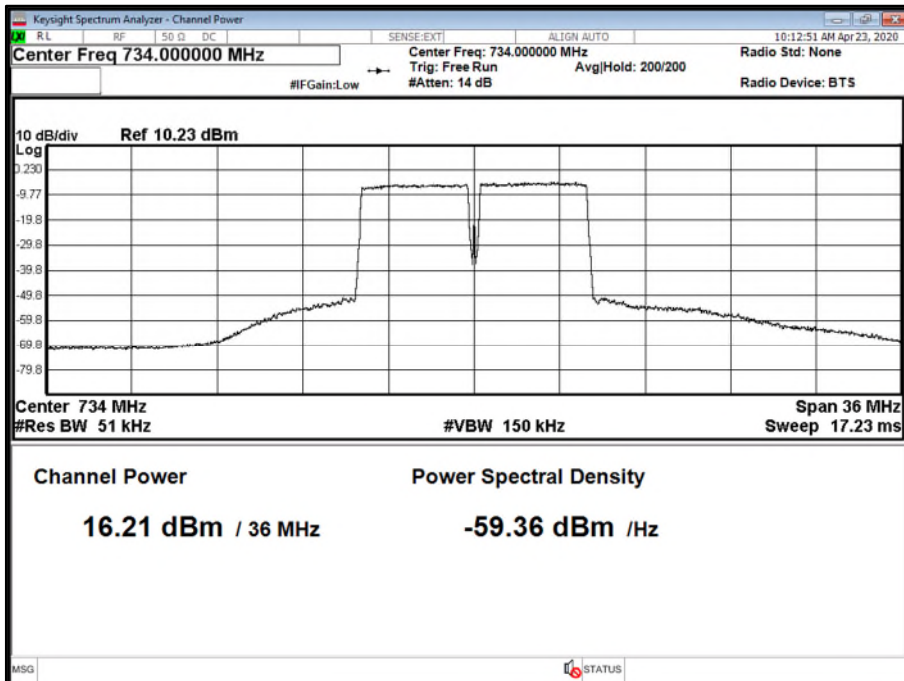



Antenna A - Modulation LTE + NR: QPSK - Carrier Bandwidth L10 + NR5 MHz - Channel Position B

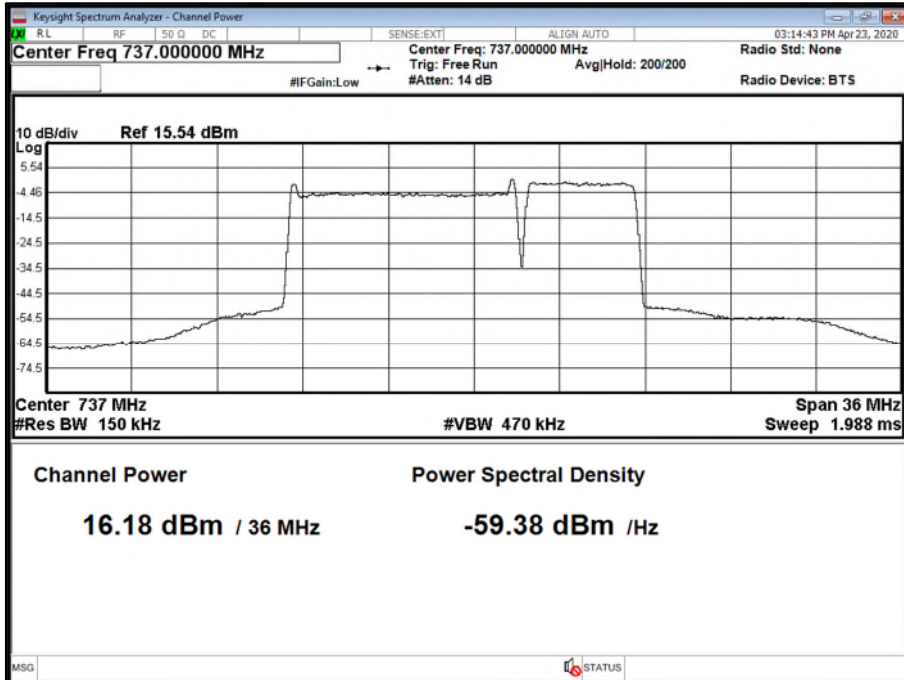



Configuration C

Maximum Output Power: 17.00 dBm per port.

Antenna	Modulation	Carrier Bandwidth	Peak to Average Ratio (PAR) / Output Power		
			Channel Position B		
			PAR (dB)	Average Power	
dBm	dBm/MHz				
A	LTE: QPSK	5.0+5.0+5.0 MHz	-	16.29	-
B	LTE: QPSK	5.0+5.0+5.0 MHz	-	15.84	-
C	LTE: QPSK	5.0+5.0+5.0 MHz	-	16.01	-
D	LTE: QPSK	5.0+5.0+5.0 MHz	-	15.75	-
Total			-	22.00	-
A	NR: QPSK	5.0+5.0+5.0 MHz	-	16.36	-
B	NR: QPSK	5.0+5.0+5.0 MHz	-	16.15	-
C	NR: QPSK	5.0+5.0+5.0 MHz	-	15.82	-
D	NR: QPSK	5.0+5.0+5.0 MHz	-	15.83	-
Total			-	22.07	-
A	LTE + NR: QPSK	L5 + 2NR5.0 MHz	-	16.33	-
B	LTE + NR: QPSK	L5 + 2NR5.0 MHz	-	16.14	-
C	LTE + NR: QPSK	L5 + 2NR5.0 MHz	-	16.07	-
D	LTE + NR: QPSK	L5 + 2NR5.0 MHz	-	15.85	-
Total			-	22.12	-

Remarks

Three carrier transmitter performance is presented. The plot results represent typical radio performance. Plot data performance for all transmitter ports and channels are on file and available on request.



Antenna A - Modulation LTE: QPSK - Carrier Bandwidth 5.0 +5.0 + 5.0 MHz - Channel Position B

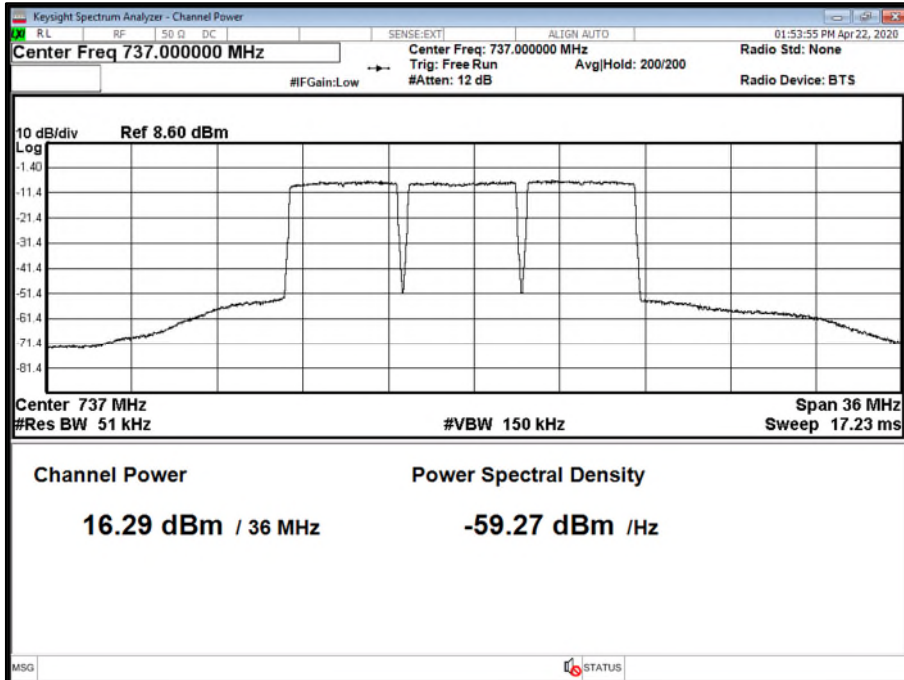

Antenna A - Modulation NR: QPSK - Carrier Bandwidth 5.0 +5.0 + 5.0 MHz - Channel Position B

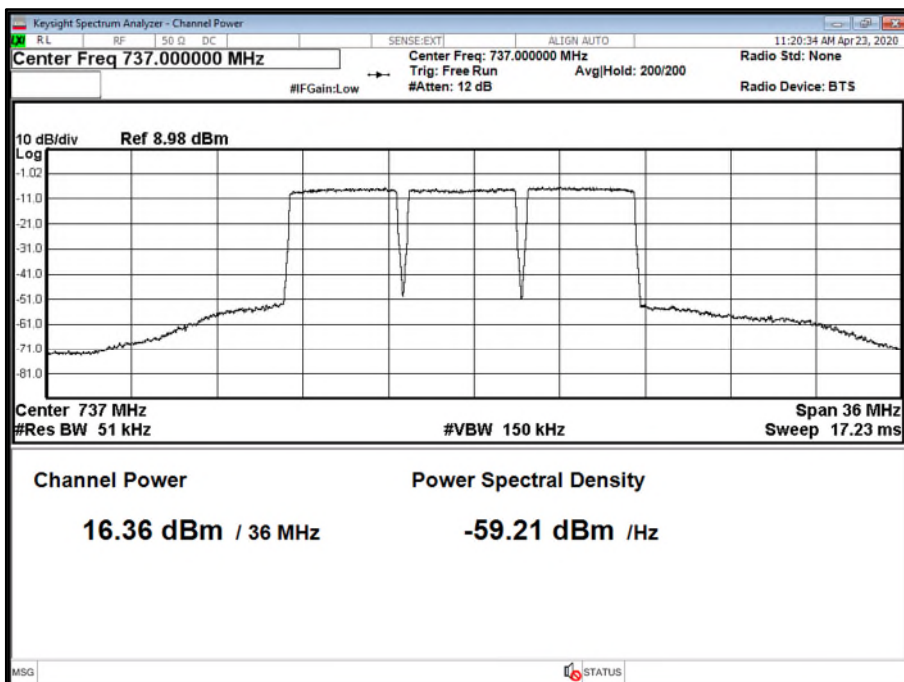



Antenna A - Modulation LTE + NR: QPSK - Carrier Bandwidth L5 + 2NR5.0 MHz - Channel Position B

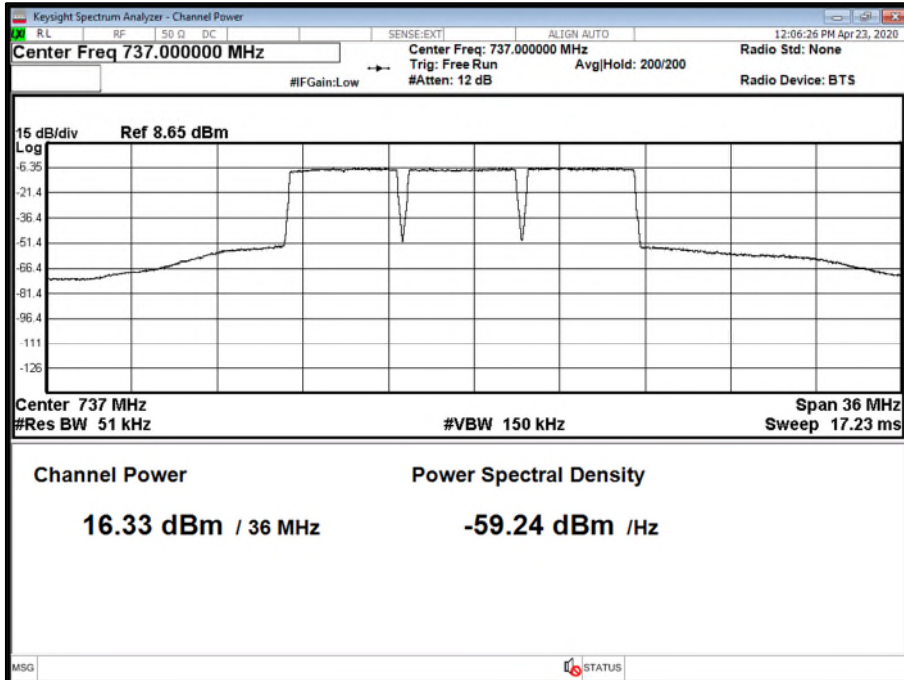

Limit	
Peak Power	≤ 1000 W/MHz or ≤ +60.0 dBm
Peak to Average Ratio	13 dB



2.2 OCCUPIED BANDWIDTH

2.2.1 Specification Reference

FCC CFR 47 Part 27, Clause 27.53
 FCC CFR 47 Part 2, Clause 2.1049

2.2.2 Date of Test and Modification State

21 April - Modification State 0

2.2.3 Test Equipment Used

The major items of test equipment used for the above tests are identified in Section 3.1.

2.2.4 Environmental Conditions

Ambient Temperature 23.5°C
 Relative Humidity 31.3%

2.2.5 Test Method

All measurements were made in accordance with FCC KDB 971168 D01.

2.2.6 Test Results

Configuration A

Maximum Output Power: 17.00 dBm per port.

Modulation	Carrier Bandwidth	Result (MHz)	
		Channel Bandwidth	
		Occupied Bandwidth	-26 dB Bandwidth
LTE: QPSK	LTE: 5.0 MHz	4.47	4.71
LTE: QPSK	LTE: 10.0 MHz	8.93	9.32
NR: QPSK	NR: 5.0 MHz	4.45	4.72
NR: QPSK	NR: 10.0 MHz	9.25	9.63
NR: QPSK	NR: 15.0 MHz	14.10	14.59

Remarks

Representative occupied bandwidth performance results presented. Plot data performance for all transmitter ports and channel positions are on file and available on request.



Antenna A - LTE Modulation QPSK - LTE Carrier Bandwidth 5.0 MHz - Channel Position M

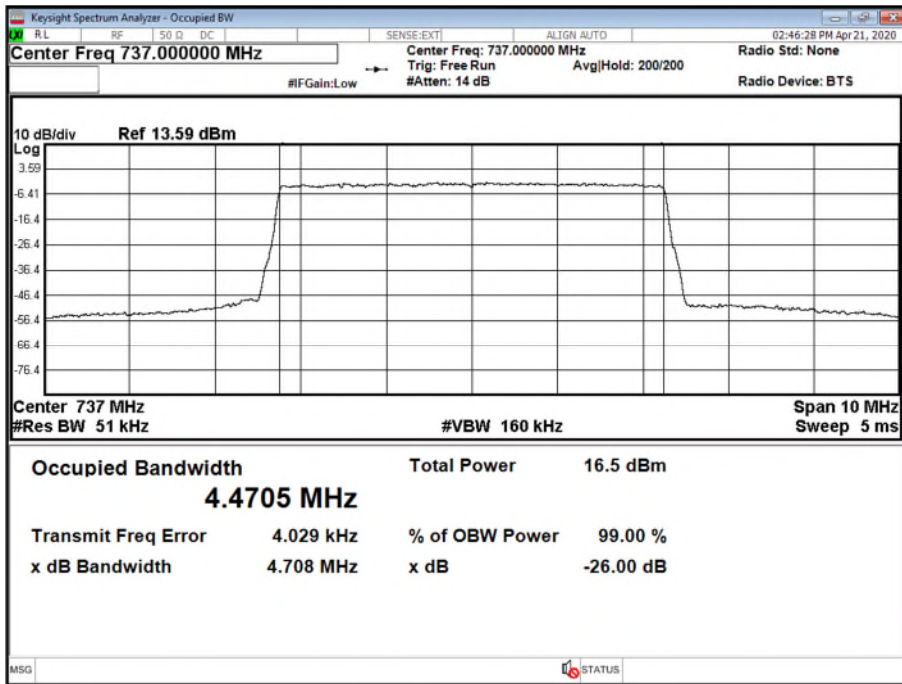

Antenna A - LTE Modulation QPSK - LTE Carrier Bandwidth 10.0 MHz - Channel Position M

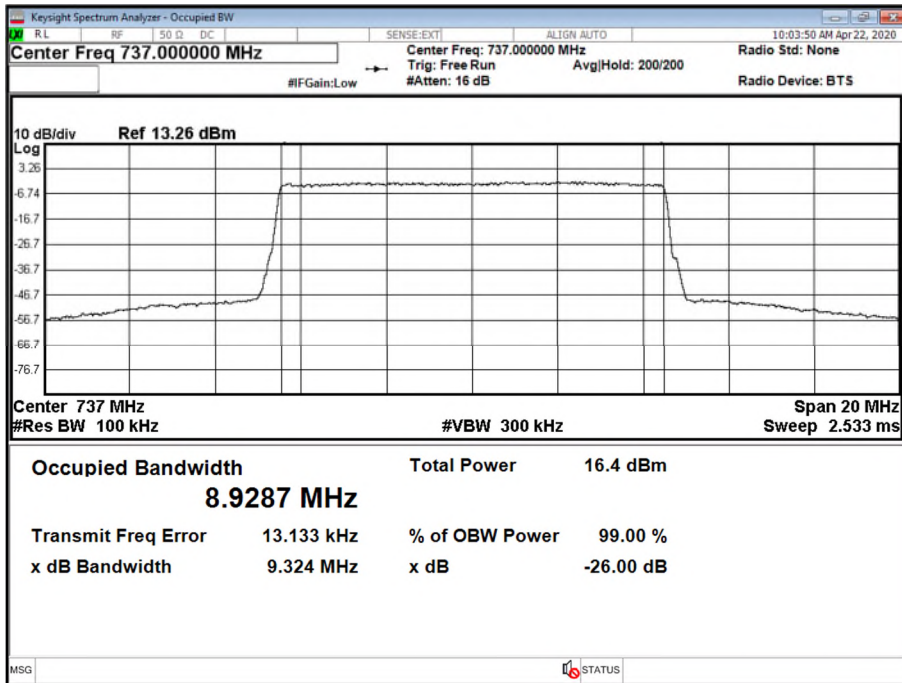



Antenna A - NR Modulation QPSK - NR Carrier Bandwidth 5.0 MHz- SCS 15 kHz - Channel Position M

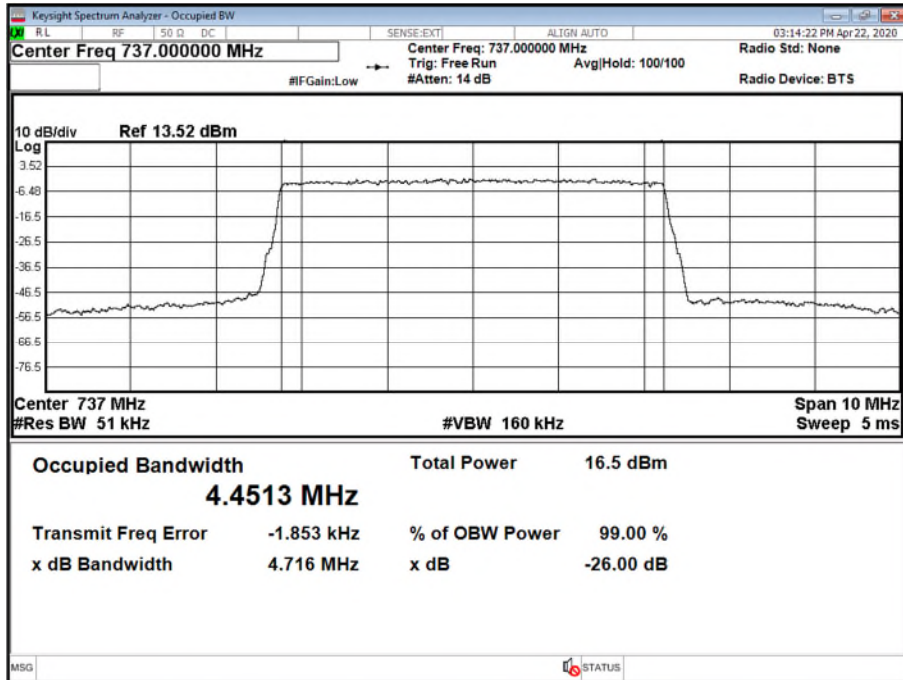

Antenna A - NR Modulation QPSK - NR Carrier Bandwidth 10.0 MHz- SCS 15 kHz - Channel Position M

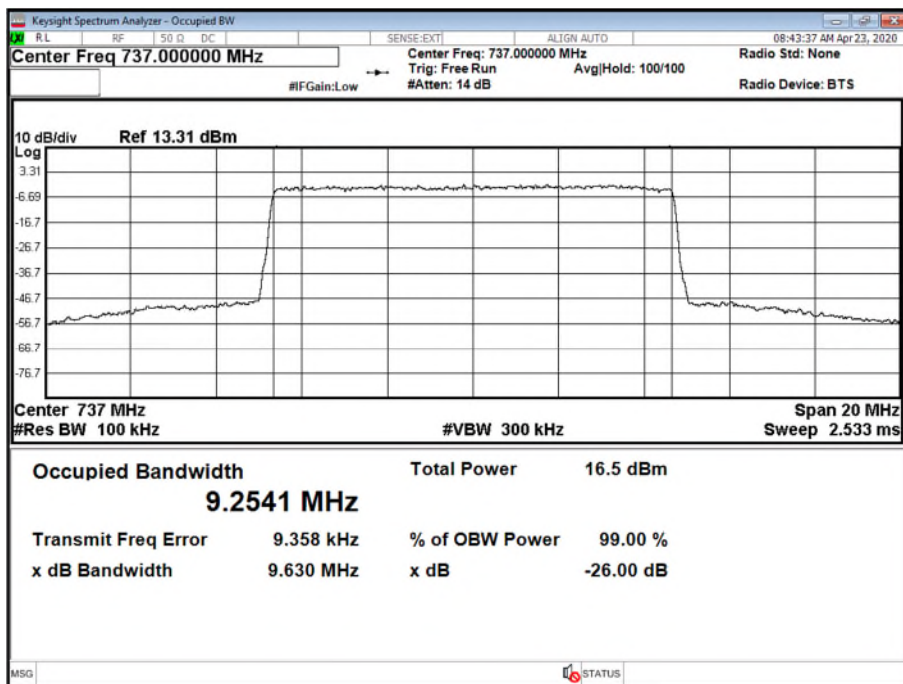



Antenna A - NR Modulation QPSK - NR Carrier Bandwidth 15.0 MHz- SCS 15 kHz - Channel Position B

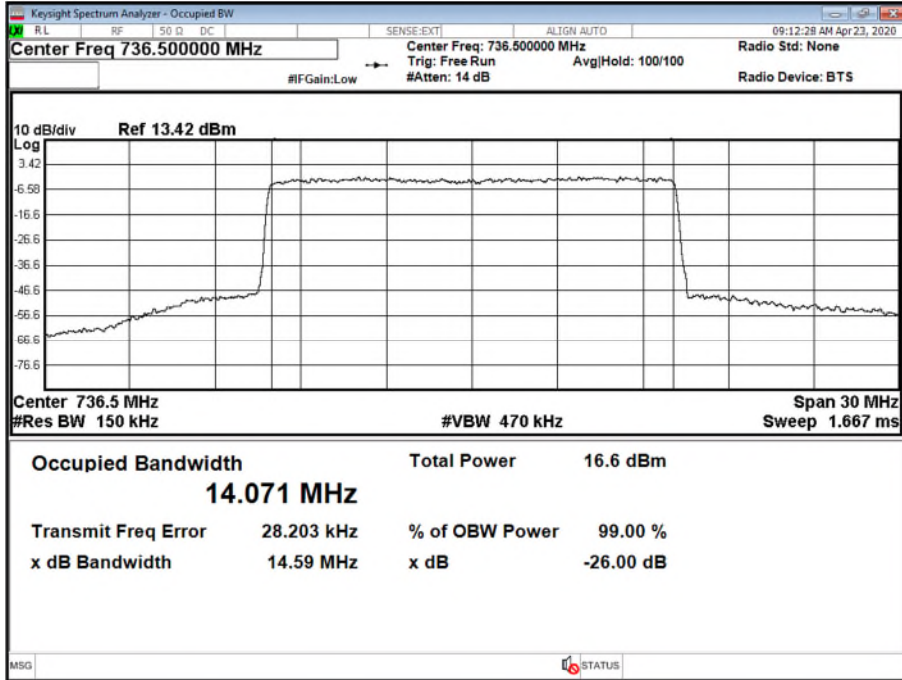



2.3 BAND EDGE

2.3.1 Specification Reference

FCC CFR 47 Part 27, Clause 27.53 (g)
 FCC CFR 47 Part 2, Clause 2.1051

2.3.2 Date of Test and Modification State

20 April 2020 - Modification State 0

2.3.3 Test Equipment Used

The major items of test equipment used for the above tests are identified in Section 3.1.

2.3.4 Environmental Conditions

Ambient Temperature 23.5°C
 Relative Humidity 31.3%

2.3.5 Test Method

All measurements were made in accordance with FCC KDB 971168 D01.

Each of the 2 bands of the EUT has 4 transmit ports, therefore, the test limits used were calculated on a worst-case basis accounting for an effective 4 port MIMO configuration. Testing was performed on this port with a test limit of $43+10\log(P) - 10\log(4) = -19$ dBm

2.3.6 Test Results

Configuration A

Maximum Output Power: 17.00 dBm per port.

Modulation	Carrier Bandwidth	Band Edge (MHz)	
		Channel Position B	Channel Position T
LTE: QPSK	LTE: 5.0 MHz	731.5	742.5
LTE: QPSK	LTE: 10.0 MHz	734.0	740.0
NR: QPSK	NR: 5.0 MHz	731.5	742.5
NR: QPSK	NR: 10.0 MHz	734.0	740.0
NR: QPSK	NR: 15.0 MHz	736.5	737.5

Remarks

Worst case bandedge data presented. Plot data performance for all transmitter ports and channel positions are on file and available on request.

Modulation LTE: QPSK - Carrier Bandwidth LTE: 5.0 MHz - Channel Position B

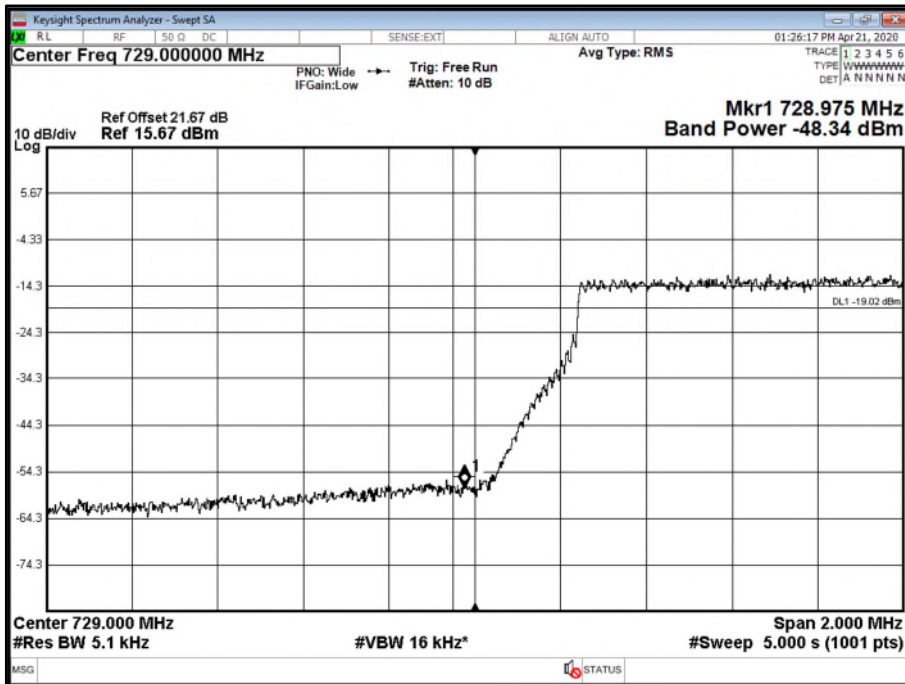

Modulation LTE: QPSK - Carrier Bandwidth LTE: 5.0 MHz - Channel Position T

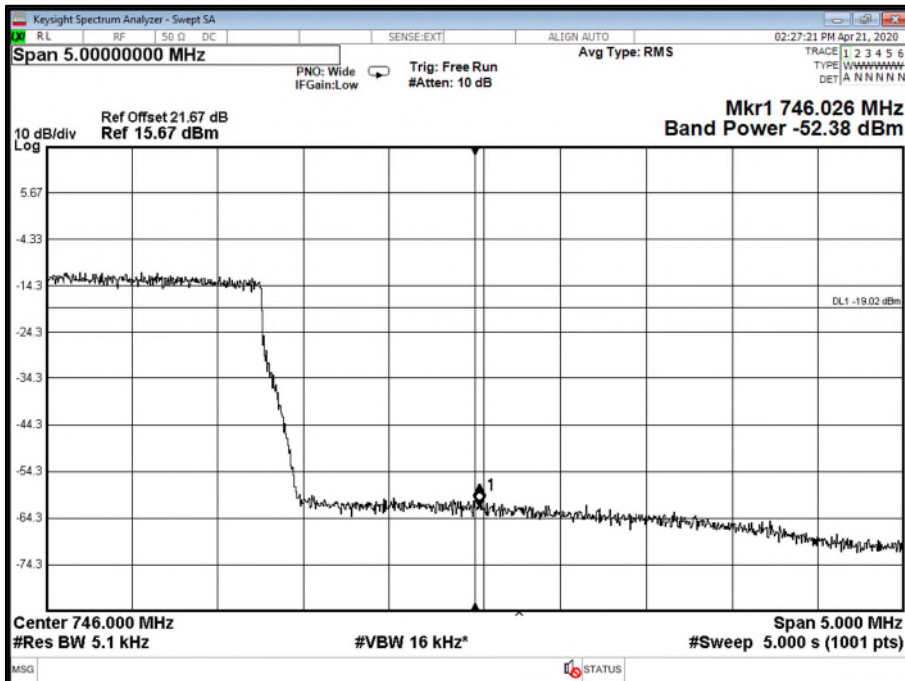



Modulation LTE: QPSK - Carrier Bandwidth LTE: 10.0 MHz - Channel Position B

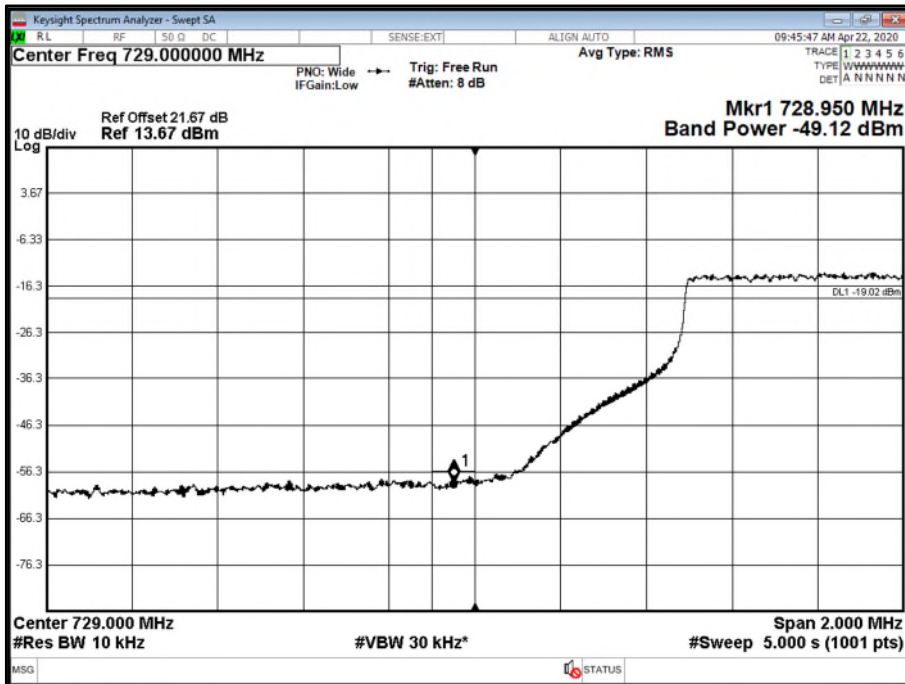

Modulation LTE: QPSK - Carrier Bandwidth LTE: 10.0 MHz - Channel Position T

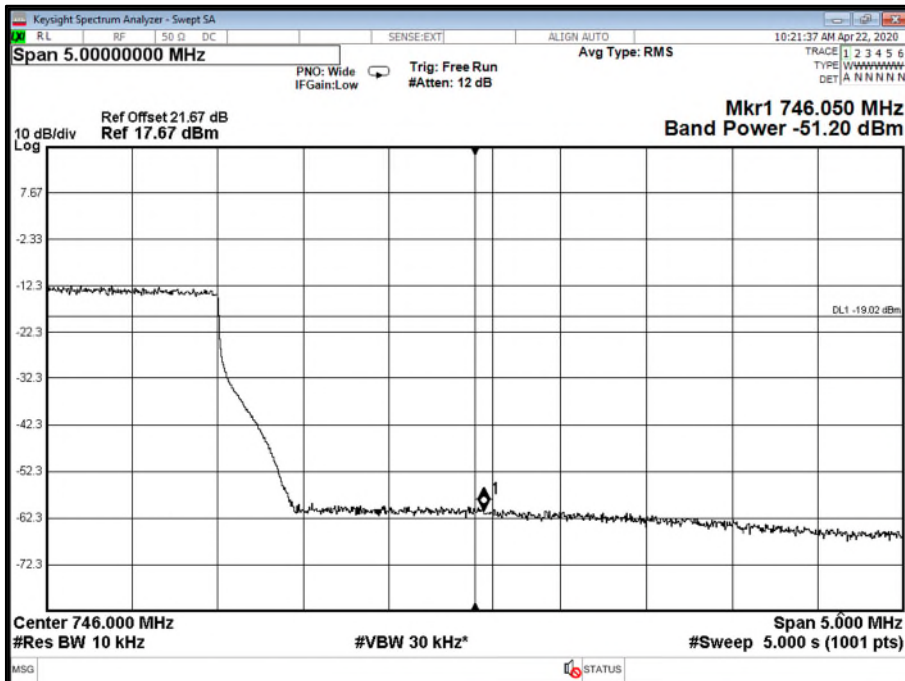



Modulation NR: QPSK - Carrier Bandwidth NR: 5.0 MHz - Channel Position B

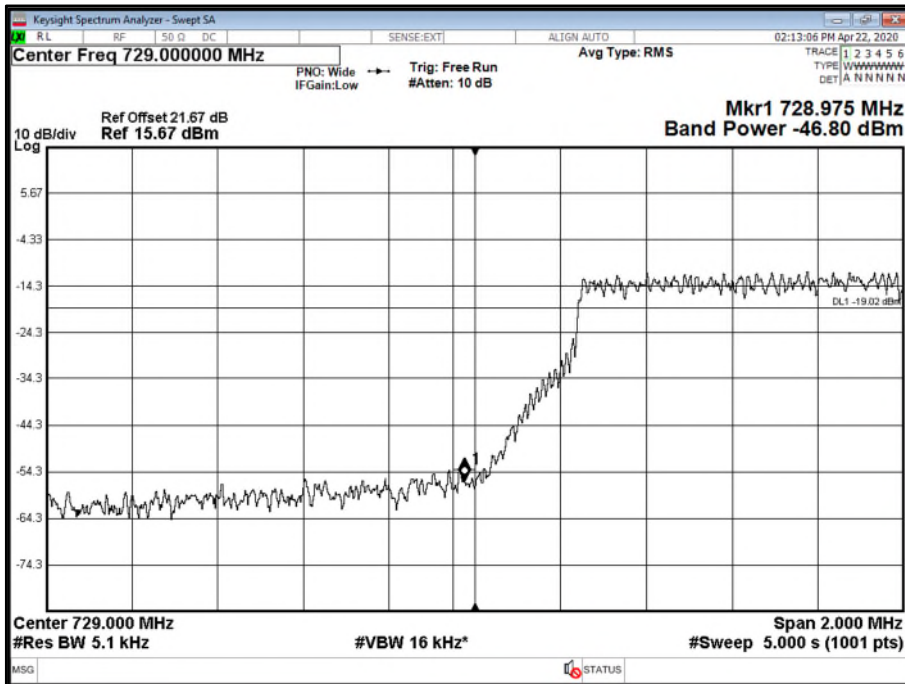

Modulation NR: QPSK - Carrier Bandwidth NR: 5.0 MHz - Channel Position T

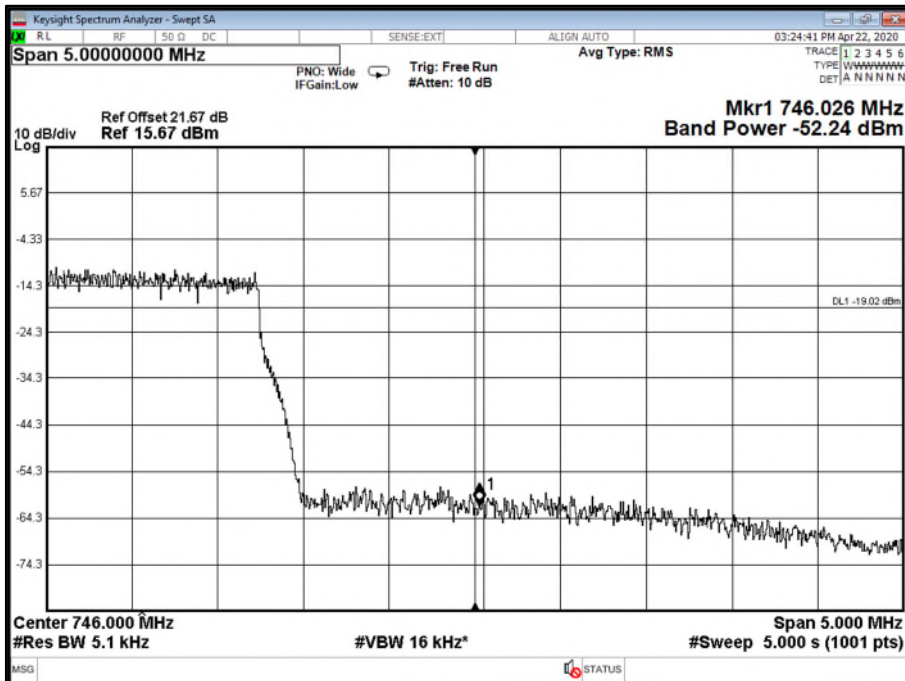

Modulation NR: QPSK - Carrier Bandwidth NR: 10.0 MHz - Channel Position B

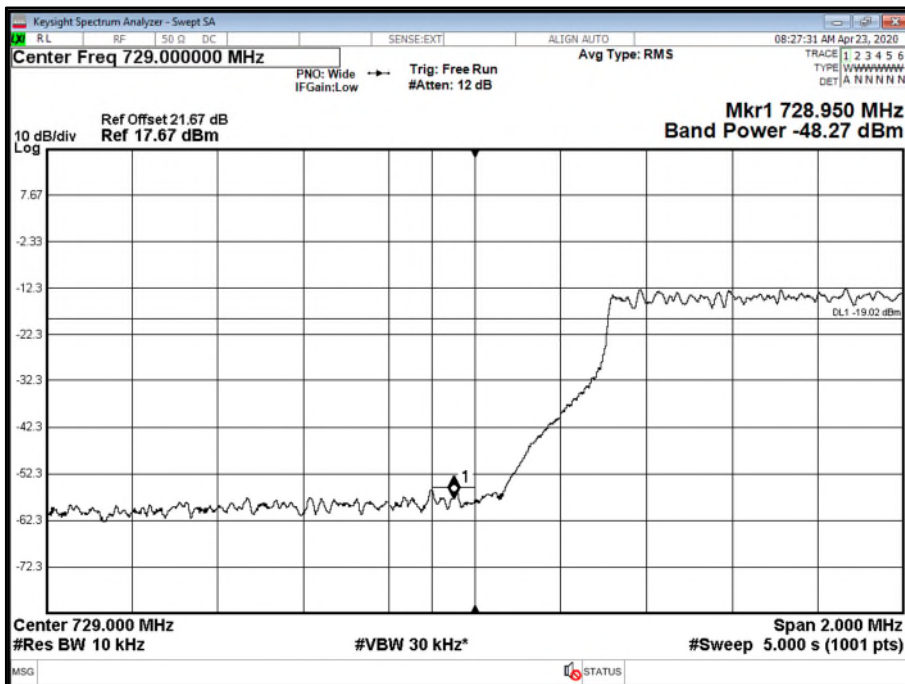

Modulation NR: QPSK - Carrier Bandwidth NR: 10.0 MHz - Channel Position T

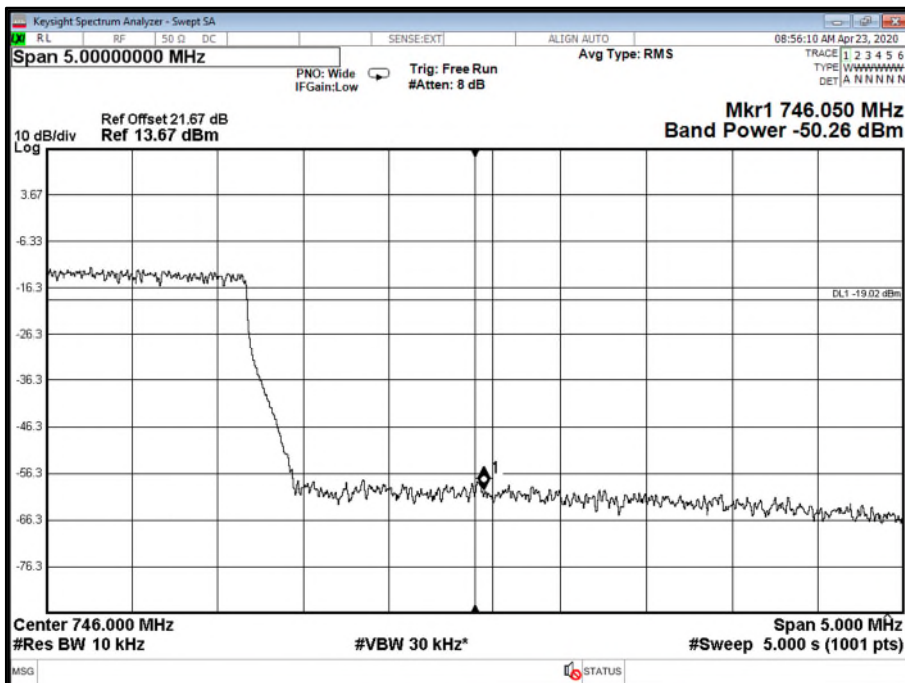



Modulation NR: QPSK - Carrier Bandwidth NR: 15.0 MHz - Channel Position B

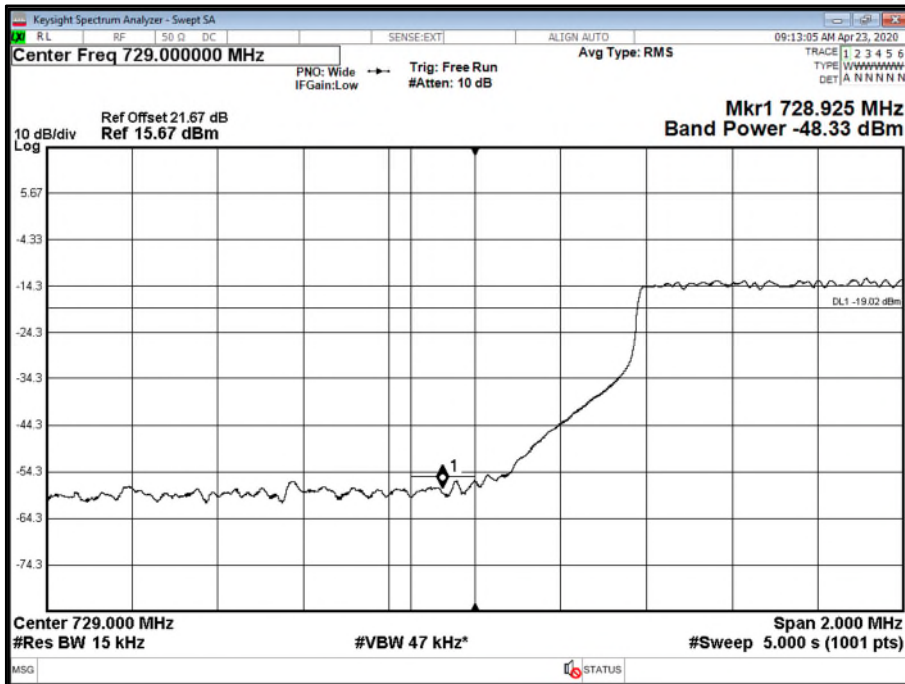

Modulation NR: QPSK - Carrier Bandwidth NR: 15.0 MHz - Channel Position T

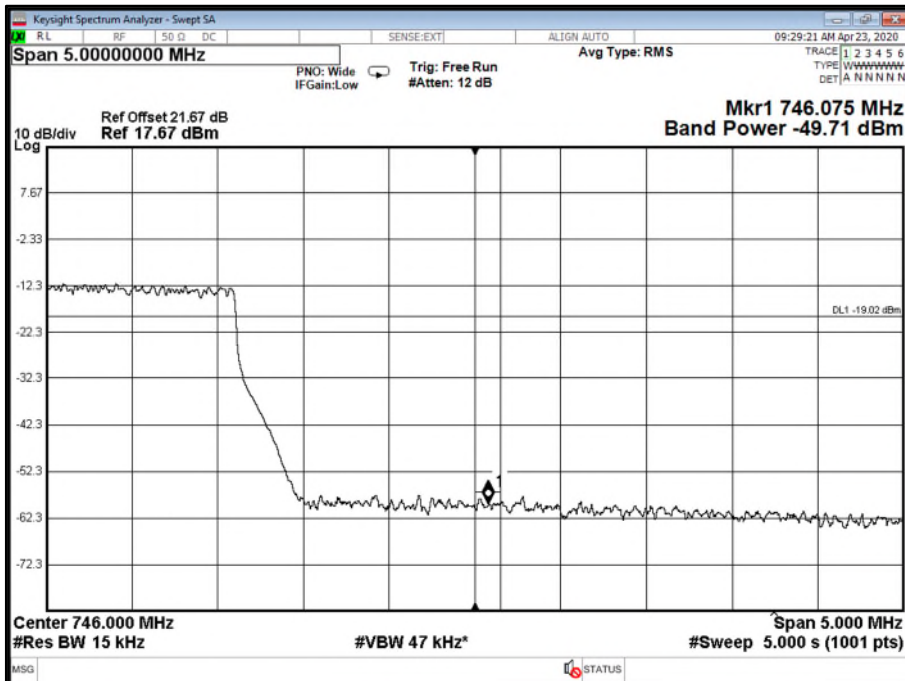



Configuration B

Maximum Output Power: 17.00 dBm per port.

Antenna	LTE Modulation	Carrier Bandwidth	Band Edge (MHz)	
			Channel Position B	Channel Position T
A	LTE: QPSK	5.0 + 5.0 MHz	731.5+736.5	742.5+737.5
A	NR: QPSK	5.0 + 5.0 MHz	731.5+736.5	742.5+737.5
A	LTE + NR QPSK	L10 + NR5.0 MHz	734.0+741.5	742.5+735.0

Remarks

10 MHz LTE has NB-IoT GB x2. Two carrier transmitter performance is presented. The plot results represent typical radio performance. Plot data performance for all transmitter ports and channels are on file and available on request.

Antenna A - LTE Modulation LTE: QPSK - Carrier Bandwidth 5.0 + 5.0 MHz - Channel Position B

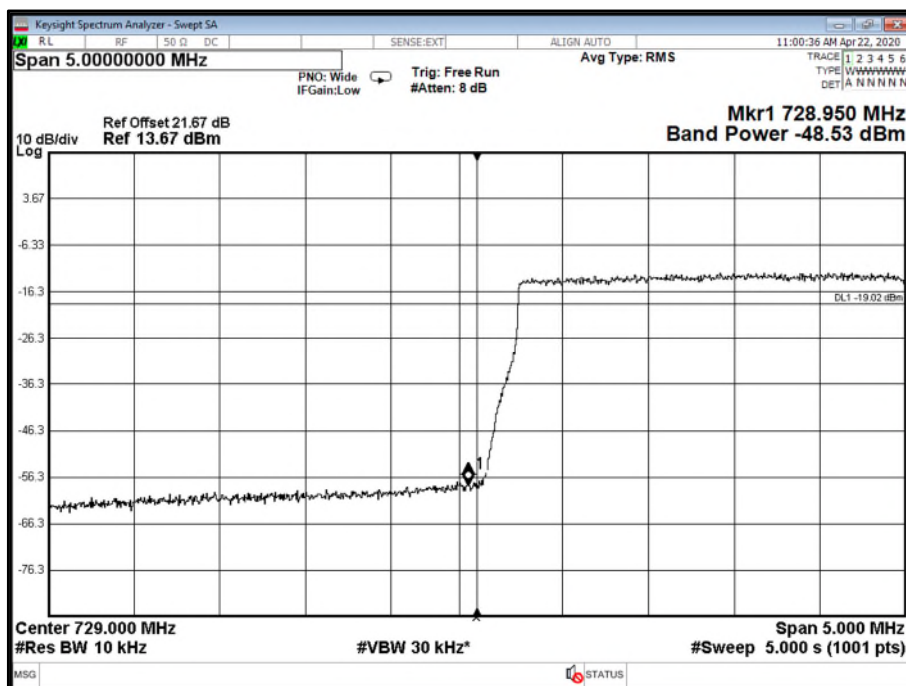



Antenna A - LTE Modulation LTE: QPSK - Carrier Bandwidth 5.0 + 5.0 MHz - Channel Position T



Antenna A - Modulation NR: QPSK - Carrier Bandwidth 5.0 + 5.0 MHz - Channel Position B

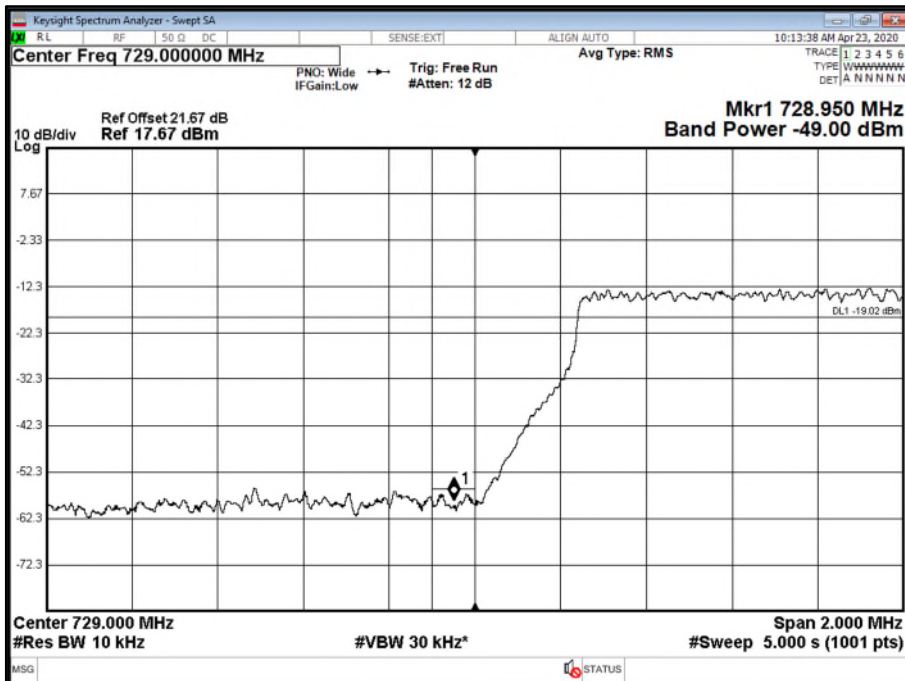

Antenna A - Modulation NR: QPSK - Carrier Bandwidth 5.0 + 5.0 MHz - Channel Position T

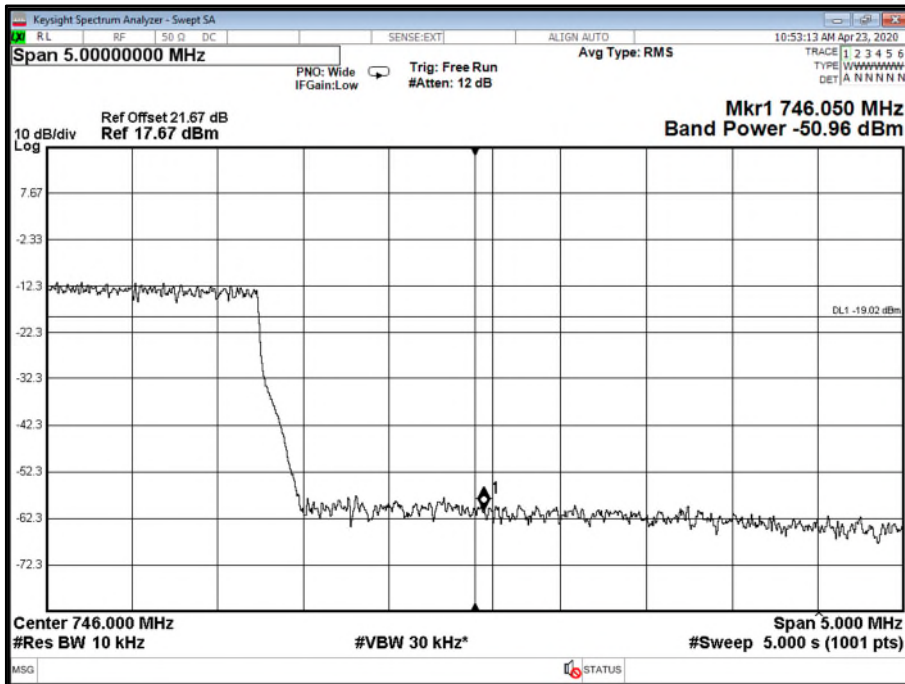

Antenna A - Modulation LTE + NR QPSK - Carrier Bandwidth L10 + NR5.0 MHz - Channel Position B

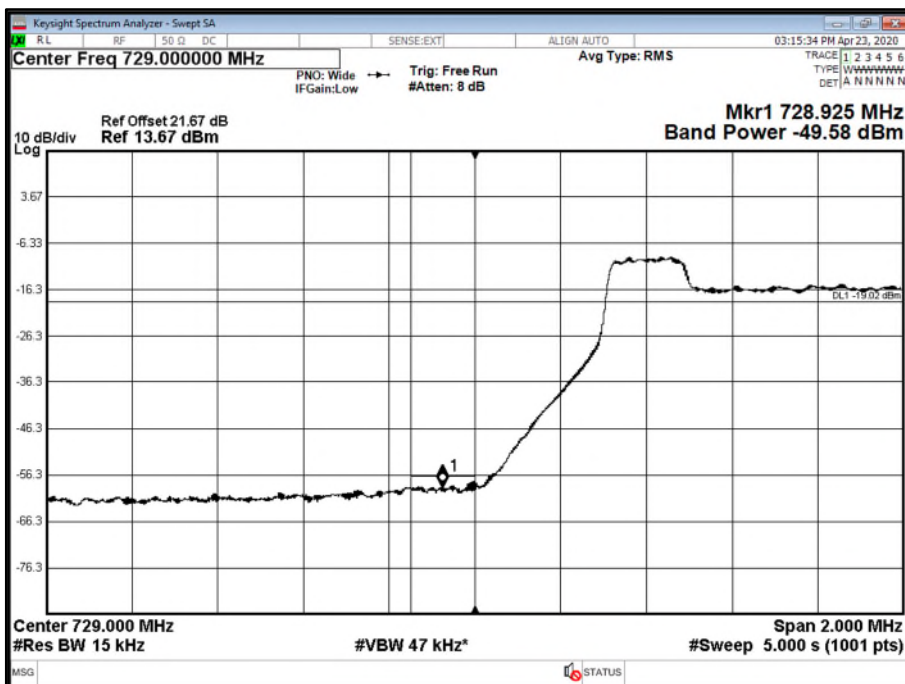



Antenna A - Modulation LTE + NR QPSK - Carrier Bandwidth L10 + NR5.0 MHz - Channel Position T

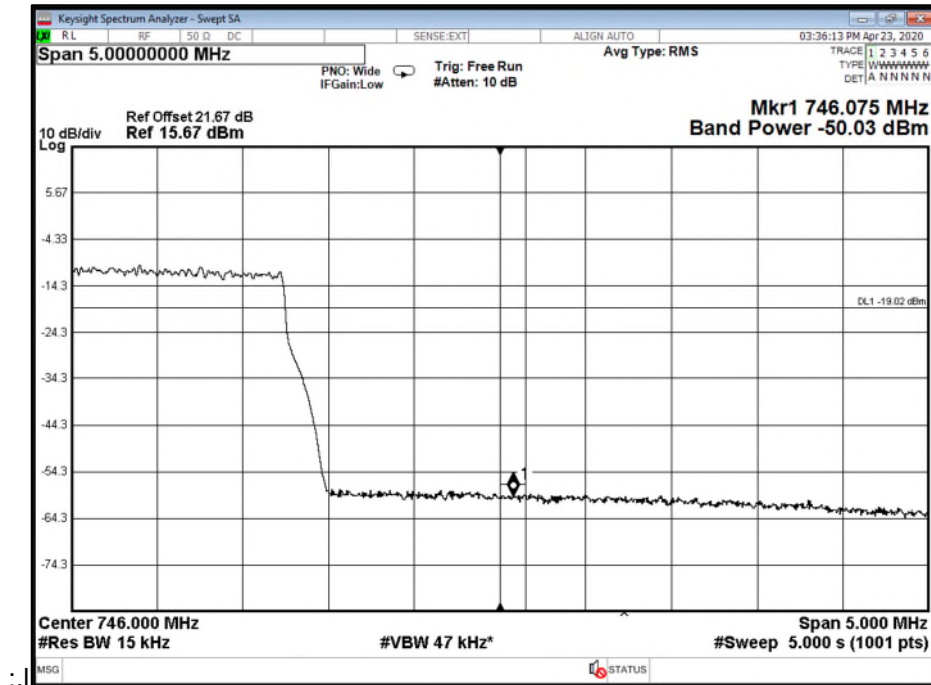

Configuration C

Maximum Output Power: 17.00 dBm per port.

Antenna	LTE Modulation	Carrier Bandwidth	Band Edge (MHz)	
			Channel Position B	Channel Position T
A	LTE: QPSK	5.0+5.0+5.0 MHz	731.5+736.5+741.5	742.5+737.5+732.5
A	NR: QPSK	5.0+5.0+5.0 MHz	731.5+736.5+741.5	742.5+737.5+732.5
A	LTE + NR QPSK	L5 + 2NR5.0 MHz	731.5+736.5+741.5	742.5+737.5+732.5

Remarks

Three carrier transmitter performance is presented. The plot results represent typical radio performance. Plot data performance for all transmitter ports and channels are on file and available on request.



Antenna A - LTE Modulation LTE: QPSK - LTE Carrier Bandwidth 5.0+5.0+5.0 MHz - Channel Position B

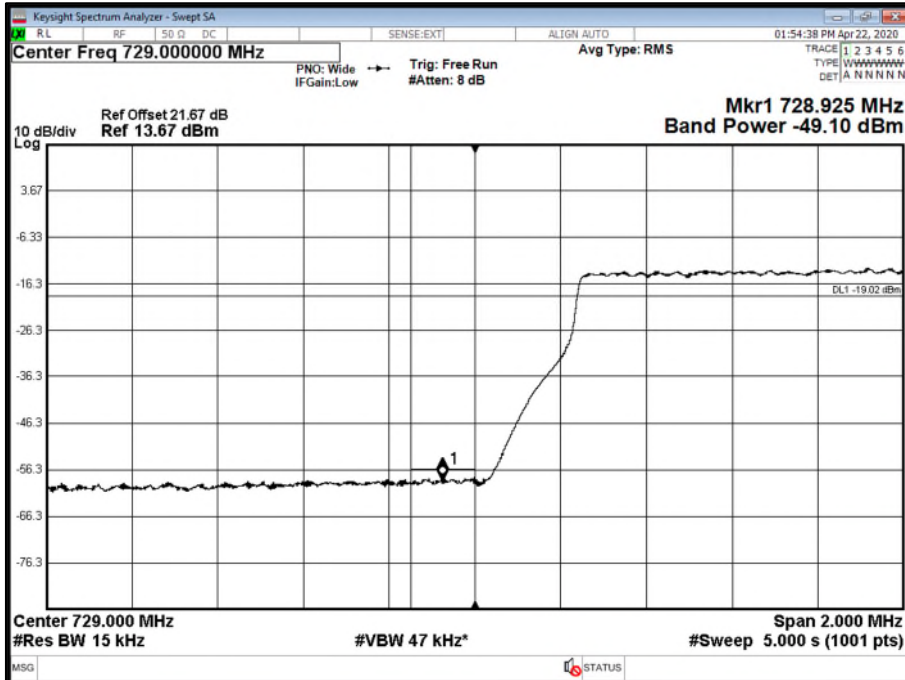

Antenna A - LTE Modulation LTE: QPSK - LTE Carrier Bandwidth 5.0+5.0+5.0 MHz - Channel Position T

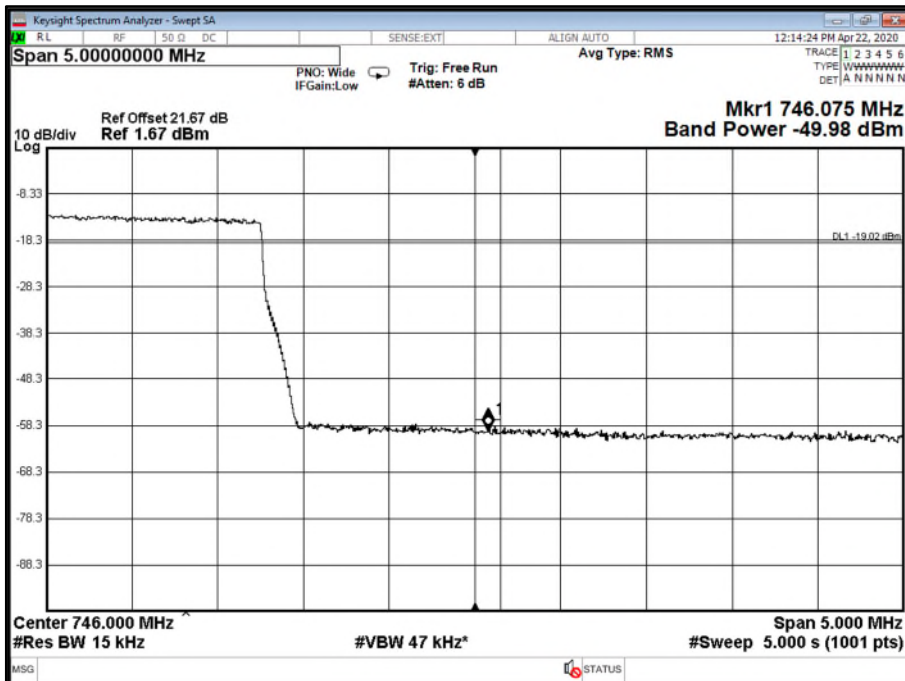



Antenna A - Modulation NR: QPSK - NR Carrier Bandwidth 5.0+5.0+5.0 MHz - Channel Position B

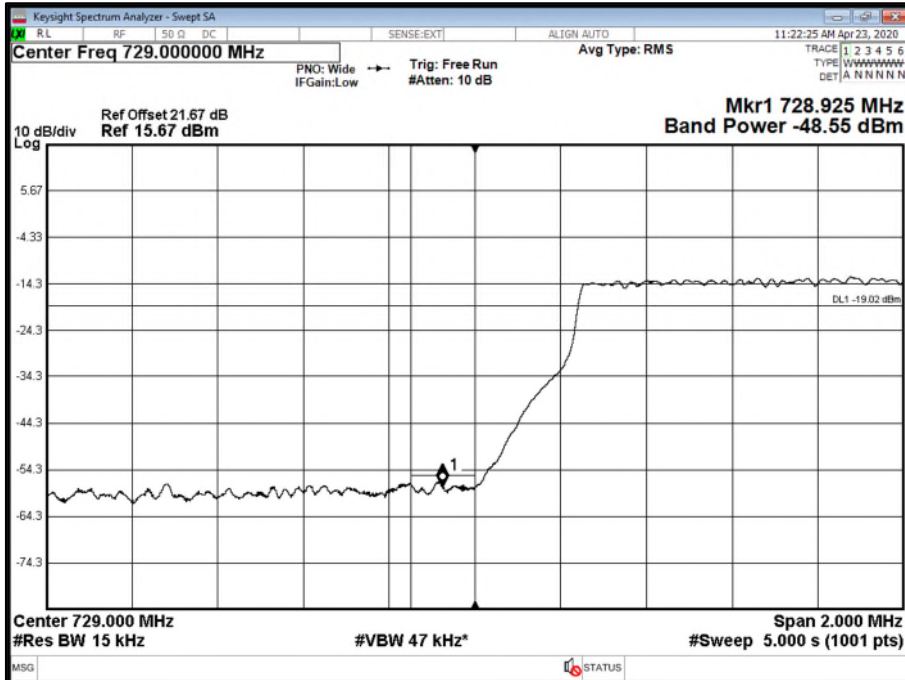

Antenna A - NR Modulation NR: QPSK - NR Carrier Bandwidth 5.0+5.0+5.0 MHz - Channel Position T

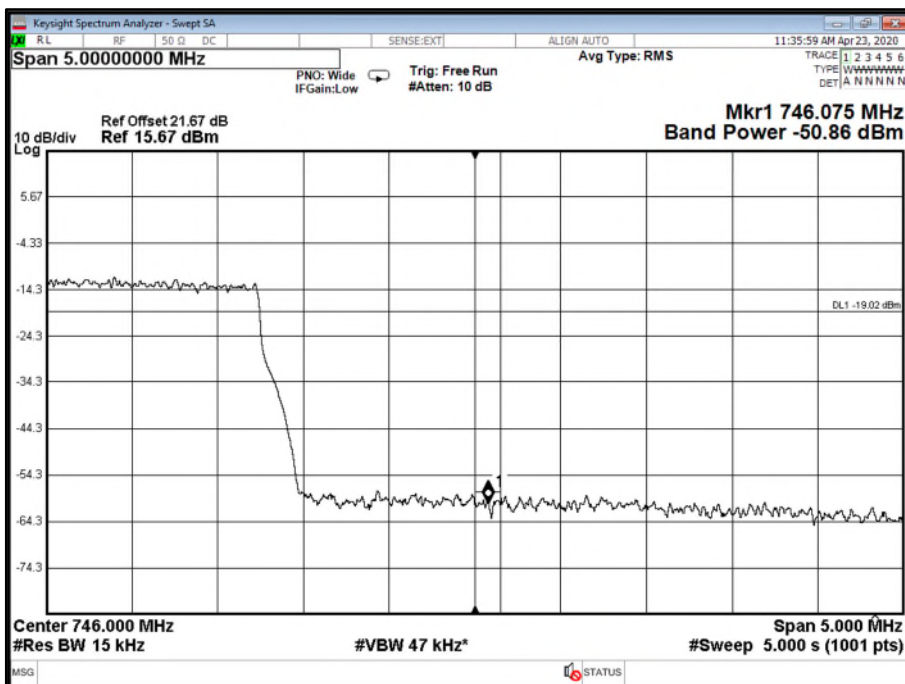

Antenna A - Modulation LTE + NR QPSK - Carrier Bandwidth L5 + 2NR5.0 MHz - Channel Position B

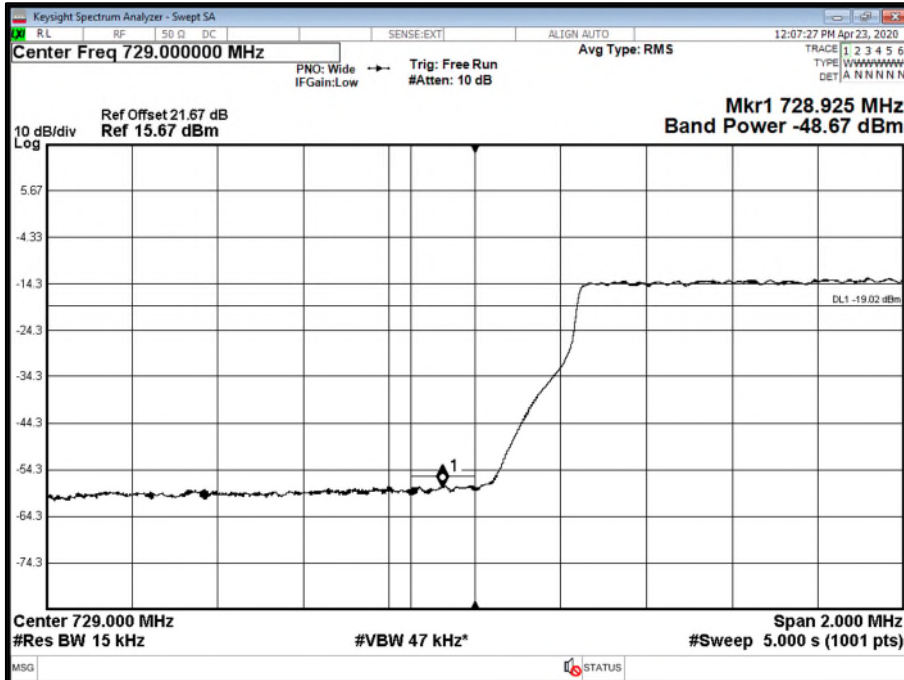

Antenna A - Modulation LTE + NR QPSK - Carrier Bandwidth L5 + 2NR5.0 MHz - Channel Position T

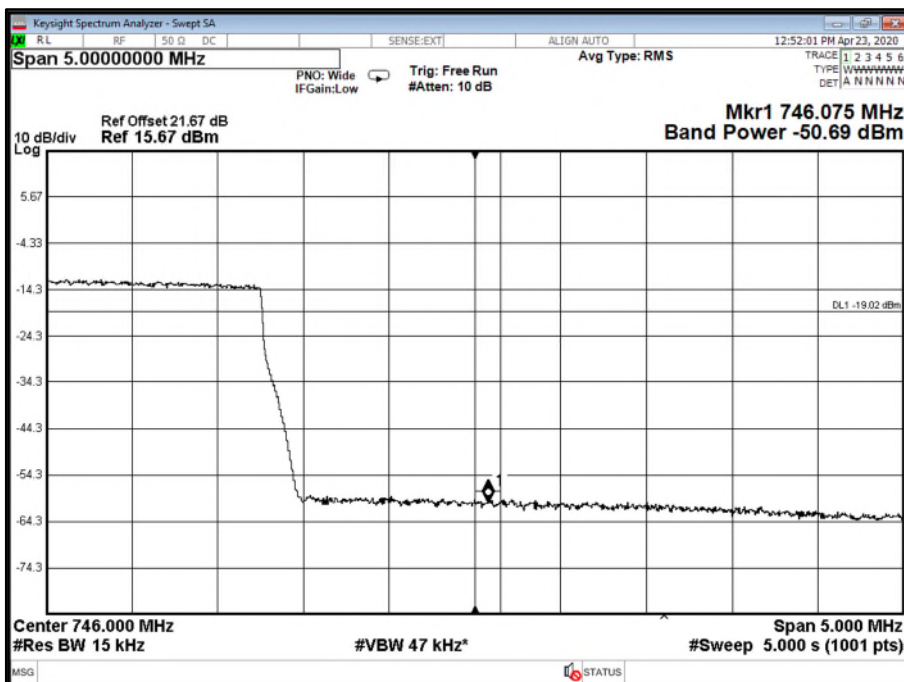

Limit	-19 dBm
-------	---------



2.4 TRANSMITTER SPURIOUS EMISSIONS

2.4.1 Specification Reference

FCC CFR 47 Part 27, Clause 27.53 (g)
FCC CFR 47 Part 2, Clause 2.1051

2.4.2 Date of Test and Modification State

20 April 2020 - Modification State 0

2.4.3 Test Equipment Used

The major items of test equipment used for the above tests are identified in Section 3.1.

2.4.4 Environmental Conditions

Ambient Temperature	23.5°C
Relative Humidity	31.3%

2.4.5 Test Method

All measurements were made in accordance with FCC KDB 971168 D01.

Each of the 2 bands of the EUT has 4 transmit ports, therefore, the test limits used were calculated on a worst-case basis accounting for an effective 4 port MIMO configuration. Testing was performed on this port with a test limit of $43+10\log(P) - 10\log(4) = -19$ dBm

2.4.6 Test Results

Configuration A

Maximum Output Power: 17.00 dBm per port.

Remarks

Spurious emissions have been searched for all channel bandwidths and antenna ports. Representative spurious emissions performance has been presented for LTE and NR modulations. Plot data performance for all transmitter ports, channel bandwidths, and channel positions are on file and available on request.



LTE Modulation LTE: QPSK - LTE Carrier Bandwidth 5.0 MHz - Channel Position M - Band 1.00 - Range 0.009 to 1000 MHz

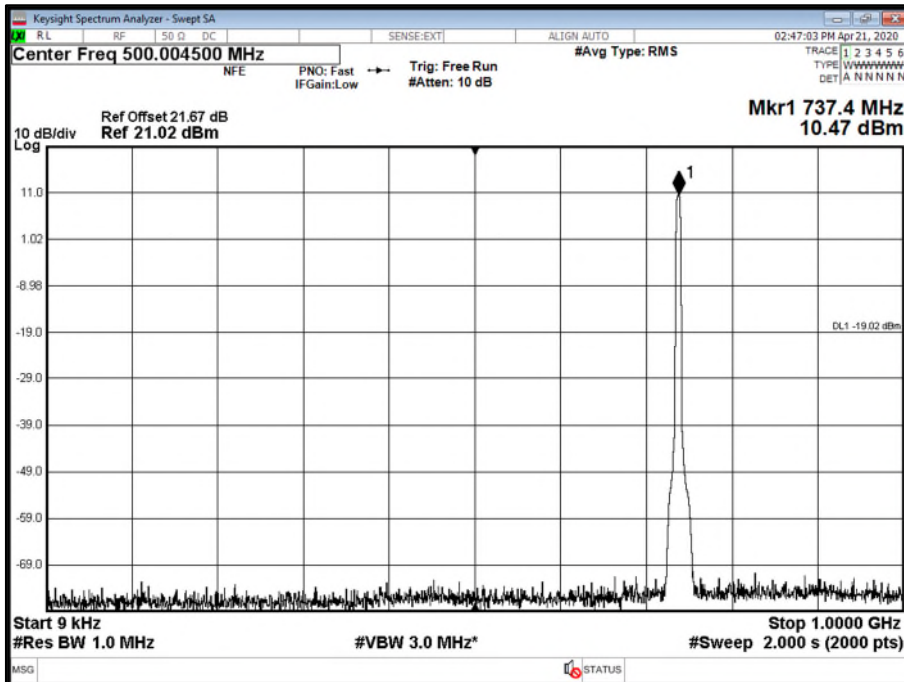

LTE Modulation LTE: QPSK - LTE Carrier Bandwidth 5.0 MHz - Channel Position M - Band 2.00 - Range 1000 to 8000 MHz

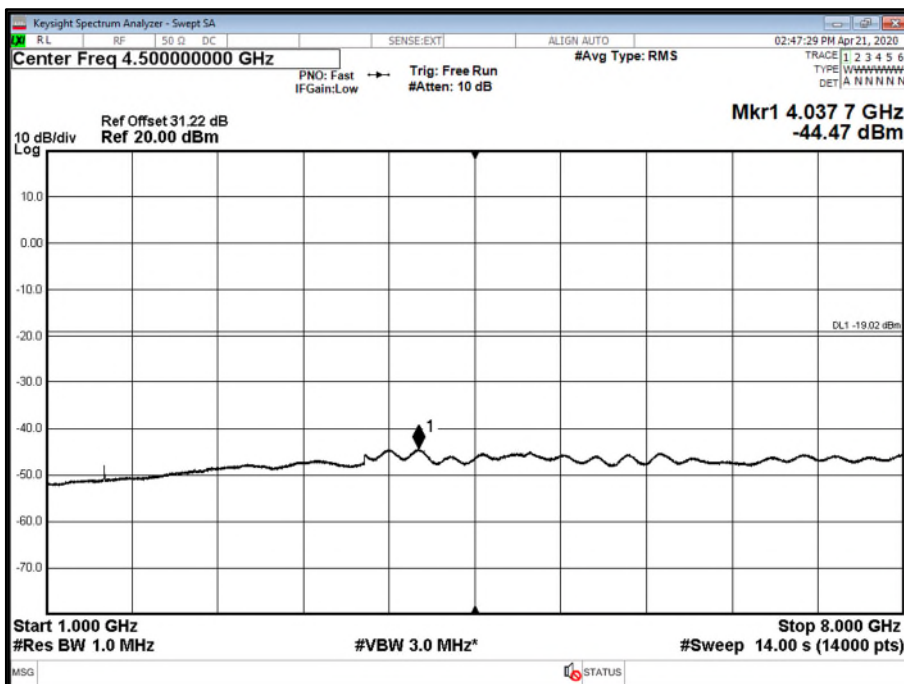



Modulation NR: QPSK - NR Carrier Bandwidth 5.0 MHz - Channel Position M - Band 1.00 - Range 0.009 to 1000 MHz

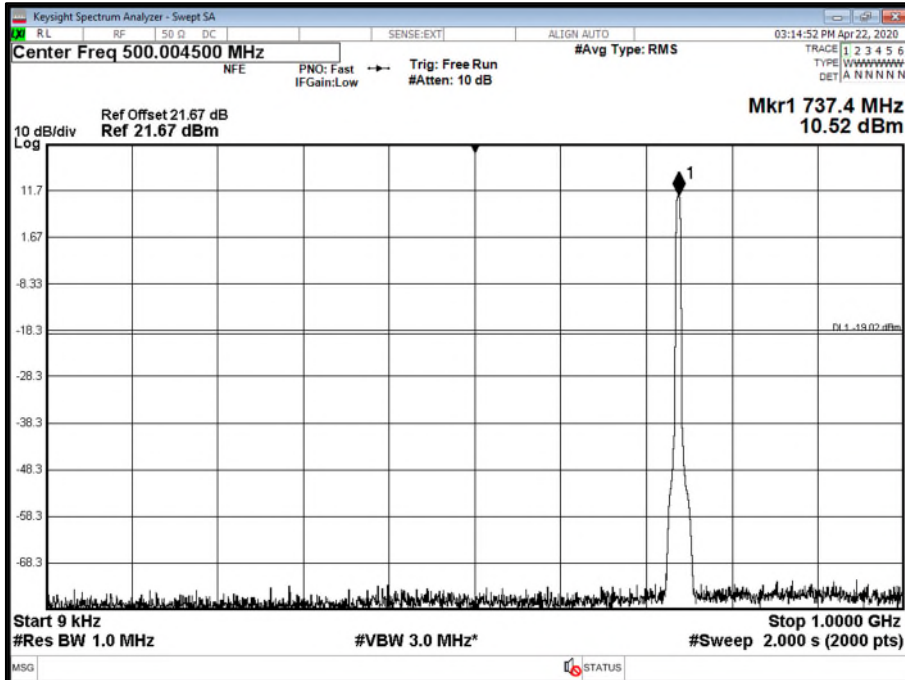

Modulation NR: QPSK - NR Carrier Bandwidth 5.0 MHz - Channel Position M - Band 2.00 - Range 1000 to 8000 MHz

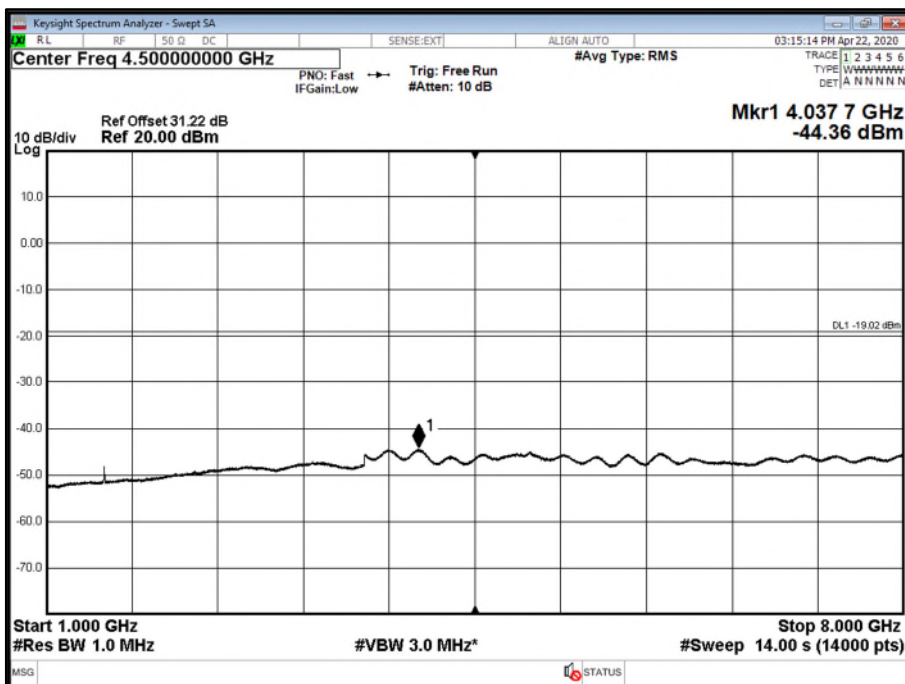



Configuration B

Maximum Output Power: 17.00 dBm per port.

Remarks

10 MHz LTE has NB-IoT GB x2. Two carrier transmitter performance is presented. The plot results represent typical radio performance. Plot data performance for all transmitter ports and channels are on file and available on request.

LTE Modulation LTE: QPSK - LTE Carrier Bandwidth 5.0 + 5.0 MHz - Channel Position B - Band 1.00 - Range 0.009 to 1000 MHz

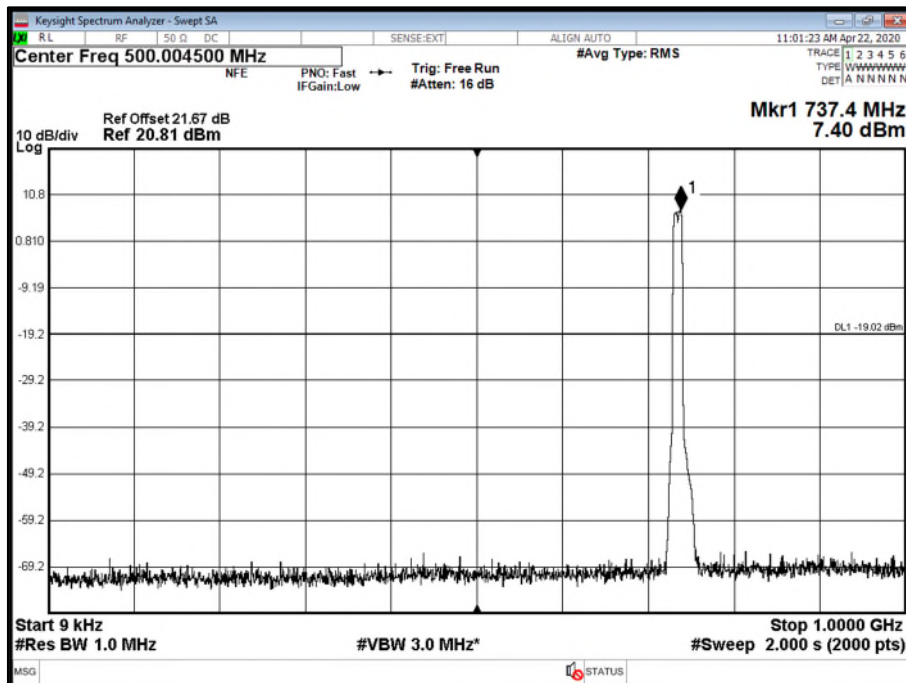



LTE Modulation LTE: QPSK - LTE Carrier Bandwidth 5.0 + 5.0 MHz - Channel Position B - Band 2.00 - Range 1000 to 8000 MHz

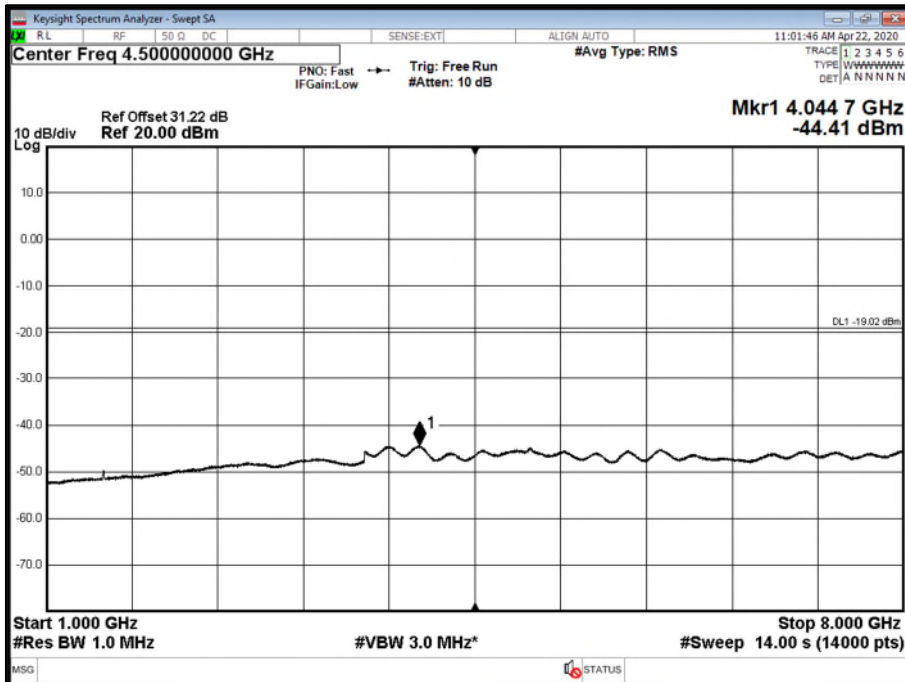

Modulation NR: QPSK - NR Carrier Bandwidth 5.0 + 5.0 MHz - Channel Position B - Band 1.00 - Range 0.009 to 1000 MHz

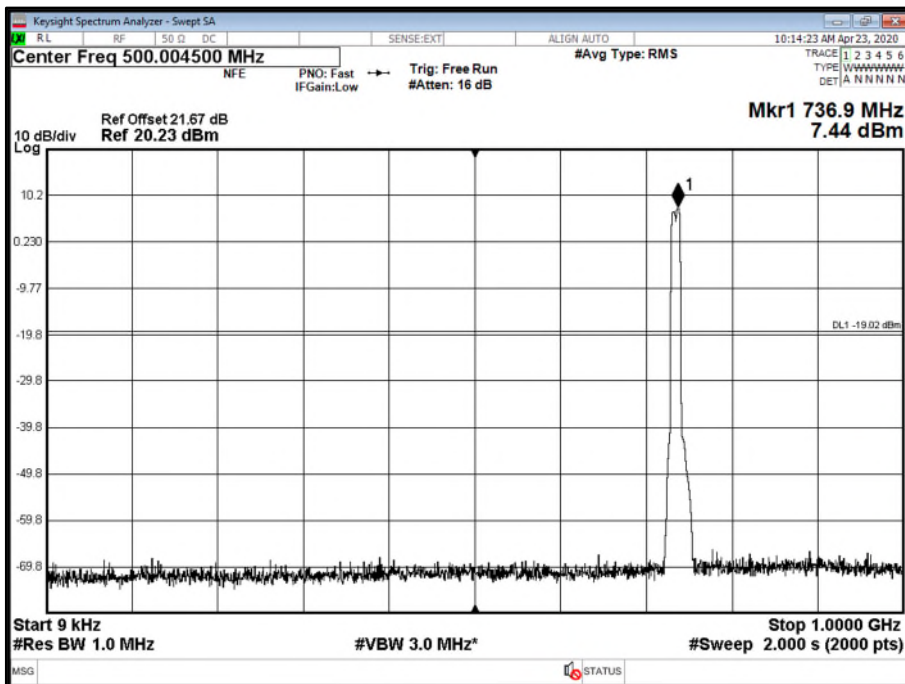



Modulation NR: QPSK - NR Carrier Bandwidth 5.0 + 5.0 MHz - Channel Position B - Band 2.00
- Range 1000 to 8000 MHz

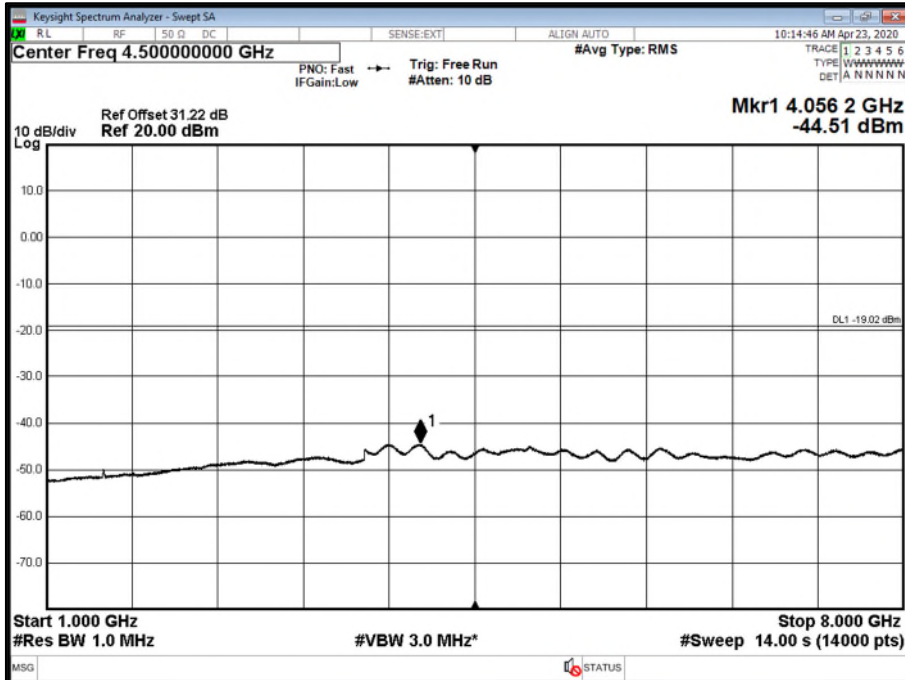

Modulation LTE + NR QPSK - Carrier Bandwidth L10 + NR5.0 MHz - Channel Position B - Band
1.00 - Range 0.009 to 1000 MHz

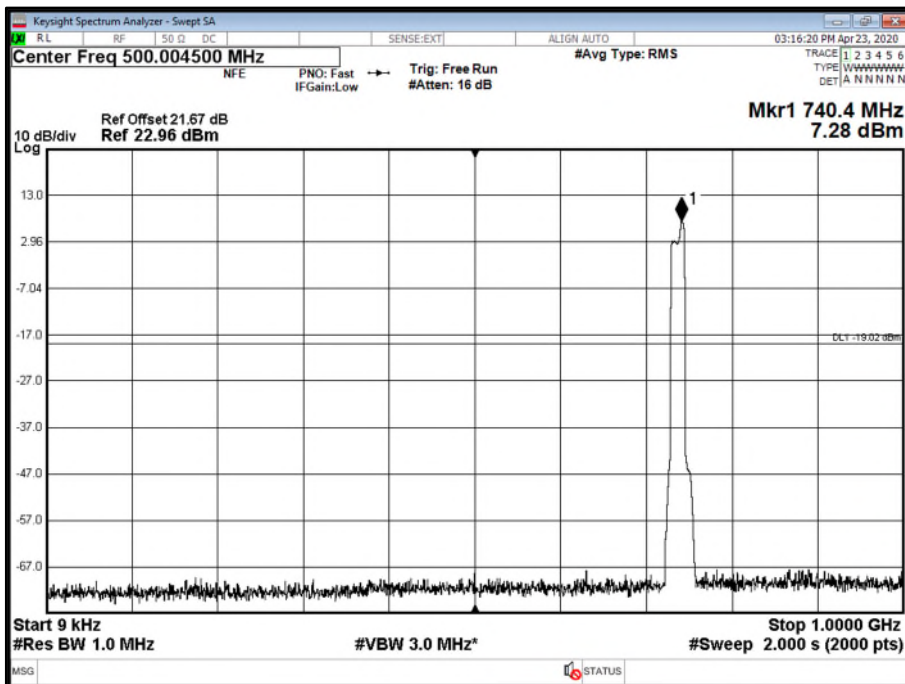



Modulation LTE + NR QPSK - Carrier Bandwidth L10 + NR5.0 MHz - Channel Position B - Band 2.00 - Range 1000 to 8000 MHz

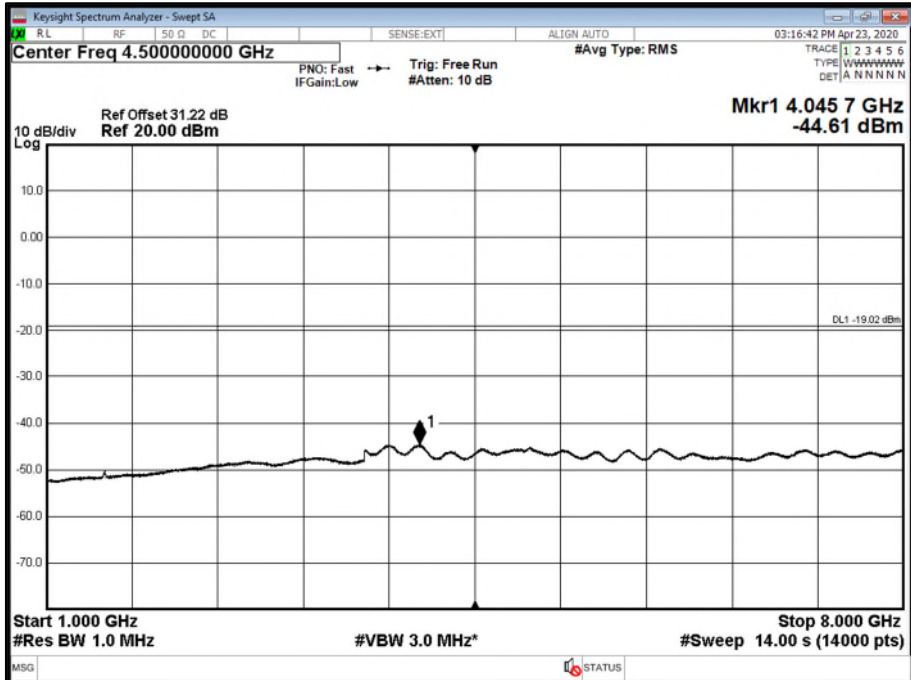

Configuration C

Maximum Output Power: 17.00 dBm per port.

Remarks

Three carrier transmitter performance is presented. The plot results represent typical radio performance. Plot data performance for all transmitter ports and channels are on file and available on request.

LTE Modulation LTE: QPSK - LTE Carrier Bandwidth 5.0+5.0+5.0 MHz - Channel Position B - Band 1.00 - Range 0.009 to 1000 MHz

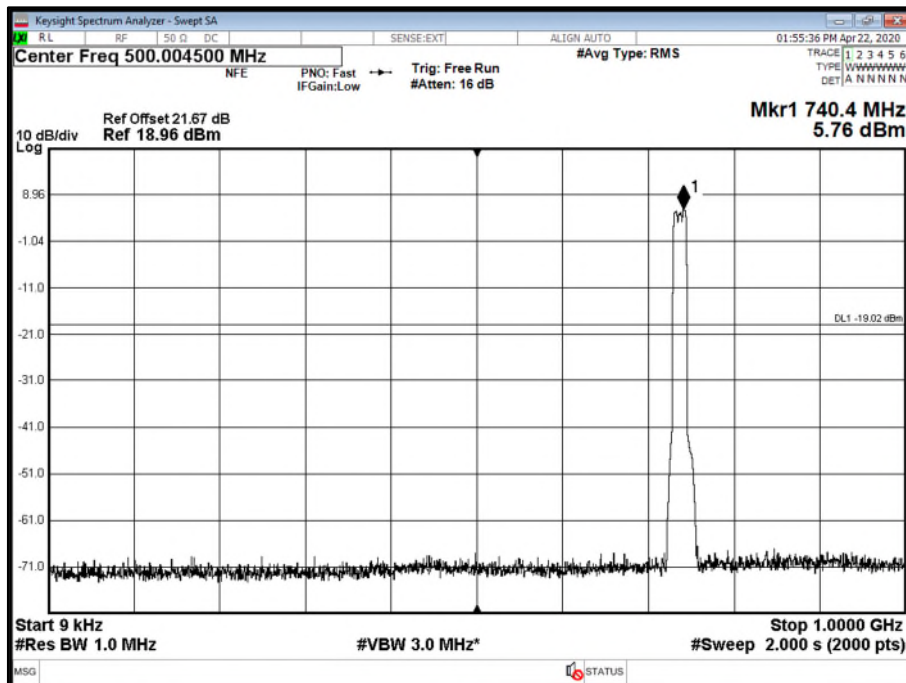



LTE Modulation LTE: QPSK - LTE Carrier Bandwidth 5.0+5.0+5.0 MHz - Channel Position B - Band 2.00 - Range 1000 to 8000 MHz

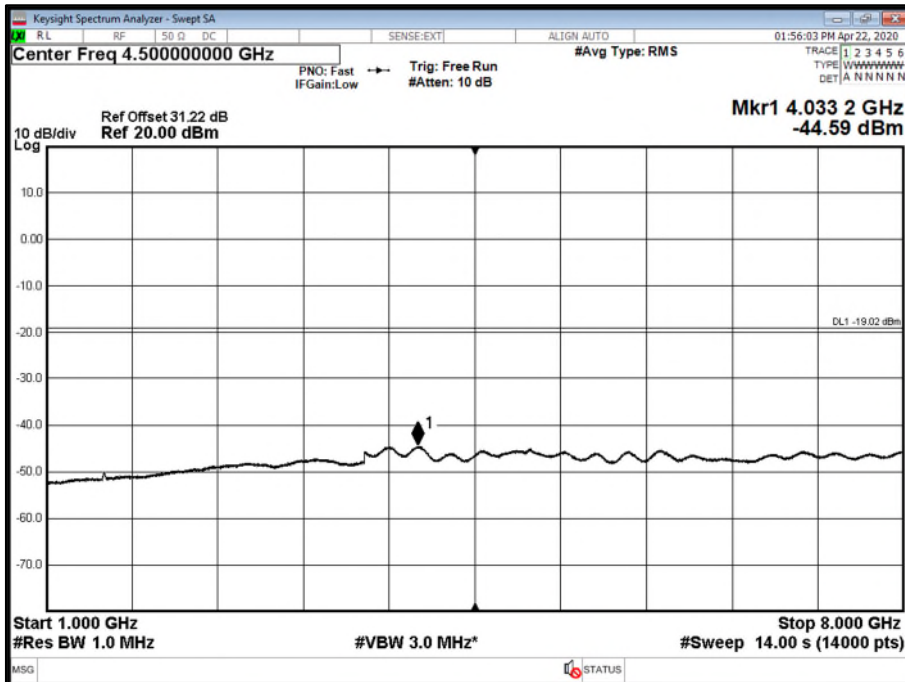

Modulation NR: QPSK - NR Carrier Bandwidth 5.0+5.0+5.0 MHz - Channel Position B - Band 1.00 - Range 0.009 to 1000 MHz

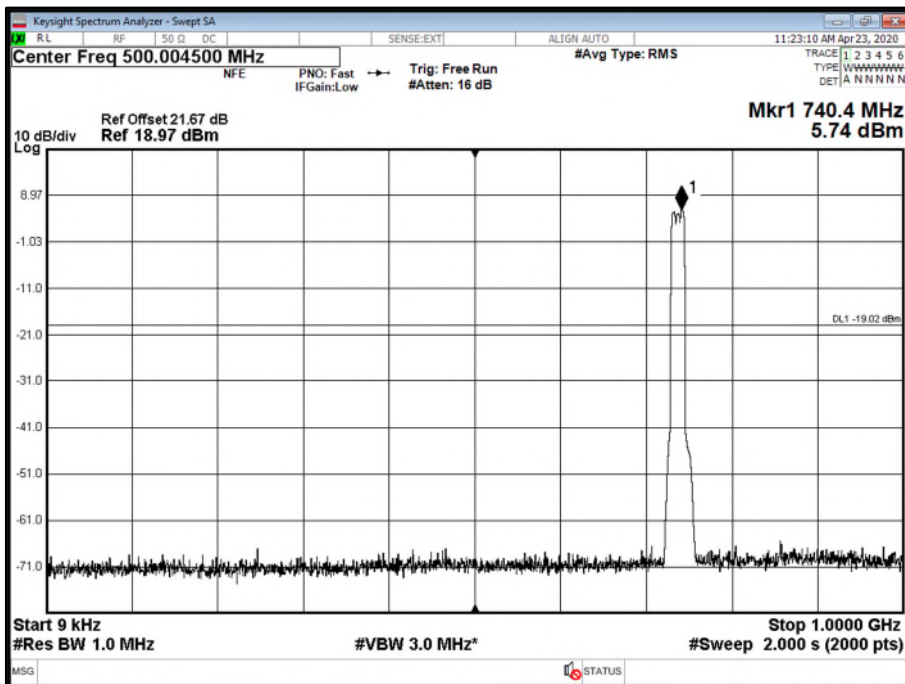



Modulation NR: QPSK - NR Carrier Bandwidth 5.0+5.0+5.0 MHz - Channel Position B - Band 2.00 - Range 1000 to 8000 MHz

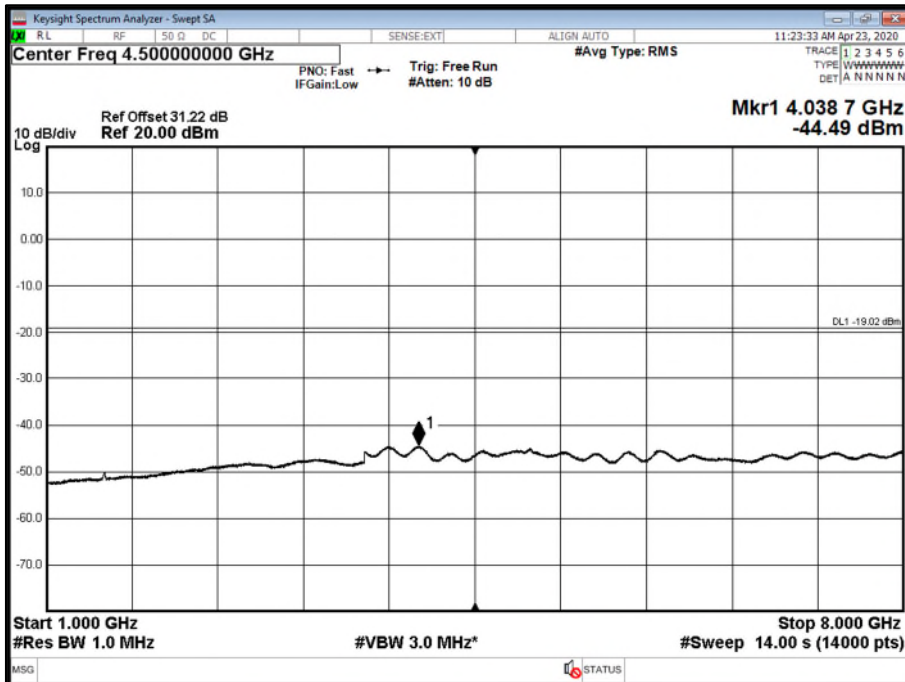

Modulation LTE + NR QPSK - Carrier Bandwidth L5 + 2NR5.0 MHz - Channel Position B - Band 1.00 - Range 0.009 to 1000 MHz

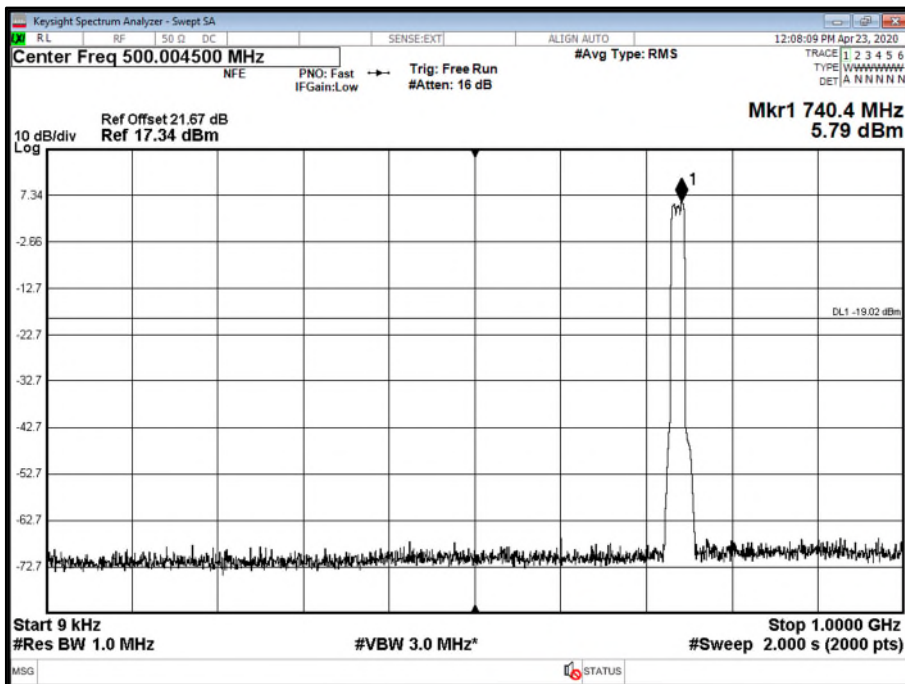



Modulation LTE + NR QPSK - Carrier Bandwidth L5 + 2NR5.0 MHz - Channel Position B - Band 2.00 - Range 1000 to 8000 MHz

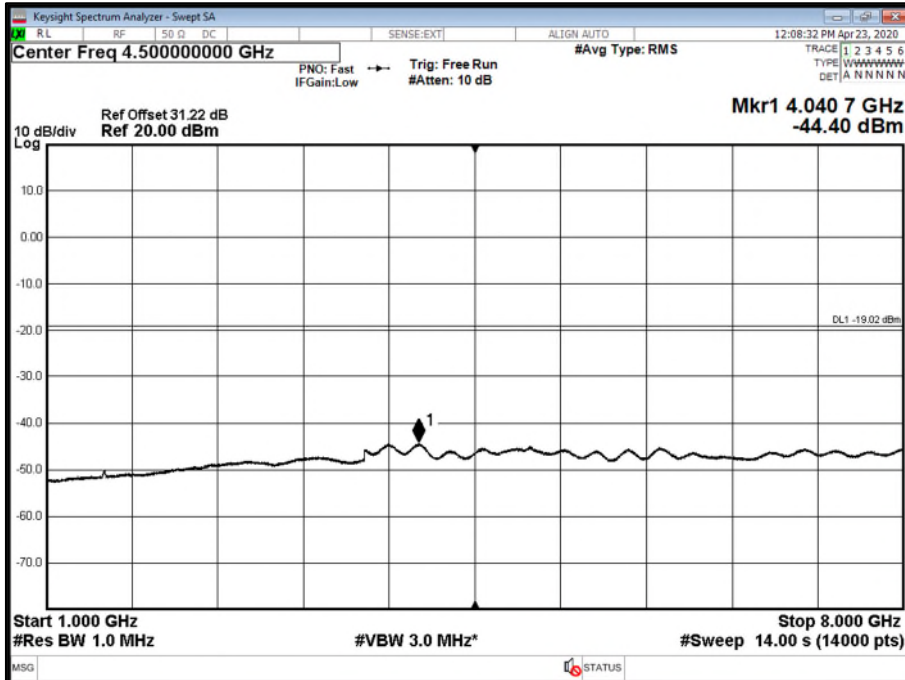

Limit	-19dBm
-------	--------



2.5 FREQUENCY STABILITY

2.5.1 Specification Reference

FCC CFR 47 Part 27, Clause 27.54
FCC CFR 47 Part 2, Clause 2.1055

2.5.2 Date of Test and Modification State

20 April 2020 - Modification State 0

2.5.3 Test Equipment Used

The major items of test equipment used for the above tests are identified in Section 3.1.

2.5.4 Environmental Conditions

Ambient Temperature 26.7°C
Relative Humidity 32.2%

2.5.5 Test Method

All measurements were made in accordance with FCC KDB 971168 D01.

2.5.6 Test Results

Configuration A

Maximum Output Power 17.00 dBm

Temperature	Voltage	Frequency Error (Hz)
		Channel Position M
-30°C	-48.0 V DC	N/A
-20°C	-48.0 V DC	N/A
-10°C	-48.0 V DC	1.20
0°C	-48.0 V DC	1.50
+10°C	-48.0 V DC	1.10
+20°C	-40.5 V DC	1.10
+20°C	-48.0 V DC	-1.10
+20°C	-57.5 V DC	-1.20
+30°C	-48.0 V DC	1.10
+40°C	-48.0 V DC	1.10
+50°C	-48.0 V DC	1.20

Limit	±1.5 ppm or ±1.093 kHz
-------	------------------------



SECTION 3

TEST EQUIPMENT USED



3.1 TEST EQUIPMENT USED

List of absolute measuring and other principal items of test equipment.

Instrument	Manufacturer	Type No.	TE No.	Cal.Cycle (Months)	Calibration Due
Spectrum Analyzer	Keysight	PXA N9030A	MY55410202	24	13-Sep-2020
Signal Generator	R&S	SMB 100A	SSG013949	24	01-Apr-2021
Digital Multimeter	Fluke	115	SSG013271	24	10-Sep-2020
Temp. / Humidity Meter	Omega	OM-CP-PRHTEMP2000	P44878	24	22-Oct-2020
PSU	Xantrex	XKW60-50	E00109862	-	O/P Mon
Attenuator (10dB)	Mini-Circuits	BW-K10-2W44+	-	-	O/P Mon
RF Switch Unit	Ericsson	RARSFW 4x1	1	-	O/P Mon
Switching Control Unit	H.P.	11713A	3748A060876	-	O/P Mon

N/A – Not Applicable

O/P Mon – Output Monitored with Calibrated Equipment



3.2 MEASUREMENT UNCERTAINTY

For a 95% confidence level, the measurement uncertainties for defined systems are:-

Test Discipline	Frequency / Parameter	MU	
Conducted Maximum Peak Output Power	30 MHz to 20 GHz Amplitude	± 0.7 dB	
Conducted Emissions	30 MHz to 20 GHz Amplitude	± 2.1 dB	
Frequency Stability	30 MHz to 2 GHz	± 5.0 Hz	
Occupied Bandwidth	Up to 20 MHz Bandwidth	5 MHz Bandwidth	± 11547 Hz
		10 MHz Bandwidth	± 23094 Hz
		15 MHz Bandwidth	± 34641 Hz
		20 MHz Bandwidth	± 46188 Hz
Band Edge	30 MHz to 20 GHz Amplitude	±0.8 dB	

Measurement Uncertainty Decision Rule

Determination of conformity with the specification limits is based on the decision rule according to IEC Guide 115: 2007, clause 4.4.3 and 4.5.1.



SECTION 5

ACCREDITATION, DISCLAIMERS AND COPYRIGHT



4.1 ACCREDITATION, DISCLAIMERS AND COPYRIGHT



This report relates only to the actual item/items tested.

This report does not imply product endorsement by any government, accreditation agency, or TÜV SÜD Canada Inc.

Opinions or interpretations expressed in this report, if any, are outside the scope of TÜV SÜD Canada Inc. accreditations. Any opinions expressed do not necessarily reflect the opinions of TÜV SÜD Canada Inc., unless otherwise stated.

© 2020 TÜV SÜD



ANNEX A

MODULE LIST

Configuration			
Product	Product No.	R-State	Serial No.
CT11	LPC 102 494/1	R2A	T01G495060
LPRU 4410 B5B12A	KRC 161 879/1	R1B	TD3F0631533
Software Version:	CXP 901 3268/17	Revision:	R82GS