



Add value.  
Inspire trust.



# Report On

FCC and ISED Testing of the  
Ericsson Radio 4499 44B2/B25 44B66A C, KRC 161 847/1, NR and  
NB-IoT (1900 MHz) Base Station in accordance with FCC CFR 47 Part  
2, FCC CFR 47 Part 24, ISED RSS-GEN and Industry Canada RSS-  
133

COMMERCIAL-IN-CONFIDENCE

FCC: TA8AKRC161847  
IC: 287AB-AS161847

PREPARED BY

Maggie Whiting  
Key Account Manager

APPROVED BY

Steve Scarfe  
Authorised Signatory

DATED

08 November 2022

Document 75955712 Report 11 Issue 1

November-2022



## CONTENTS

Section	Page No
<b>1</b>	<b>REPORT INFORMATION ..... 2</b>
1.1	Report Details ..... 3
1.2	Brief Summary of Results ..... 4
1.3	Test Rationale..... 5
1.4	Configuration Description ..... 6
1.5	Declaration of Build Status ..... 7
1.6	Product Information ..... 9
1.7	Test Setup ..... 10
1.8	Test Conditions..... 12
1.9	Deviation From The Standard ..... 12
1.10	Modification Record ..... 12
1.11	Additional Information ..... 13
<b>2</b>	<b>TEST DETAILS ..... 14</b>
2.1	Maximum Peak Output Power and Peak to Average Ratio - Conducted..... 15
2.2	Occupied Bandwidth..... 25
2.3	Band Edge ..... 33
2.4	Transmitter Spurious Emissions..... 39
2.5	Radiated Emissions ..... 64
<b>3</b>	<b>TEST EQUIPMENT USED ..... 69</b>
3.1	Test Equipment Used ..... 70
3.2	Measurement Uncertainty ..... 72
3.3	Measurement Software Used ..... 73
<b>4</b>	<b>ACCREDITATION, DISCLAIMERS AND COPYRIGHT..... 74</b>
4.1	Accreditation, Disclaimers and Copyright..... 75
<b>ANNEX A</b>	<b>Module Lists.....A.2</b>



## **SECTION 1**

### **REPORT INFORMATION**



## 1.1 REPORT DETAILS

Manufacturer	Ericsson AB
Address	Torshamnsgatan 23 Kista SE-16480 Stockholm Sweden
Product Name & Product Number	Radio 4499 44B2/B25 44B66A C - KRC 161 847/1
IC Model Name	AS161847
Serial Number(s)	E23C972483
Software Version	CXP9013268/15- R89MU15
Hardware Version	R2C
Test Specification/Issue/Date	FCC CFR 47 Part 2: 2021 FCC CFR 47 Part 24: 2021 ISED RSS-GEN: Issue 5: March 2019 Amendment 1, 2021 Amendment 2 Industry Canada RSS-133: Issue 6: January 2018 Amendment 1
Test Plan	MR7602-SP-2E _Spectrum Sharing with NB-IoT 11 Radios FCC and ISED_Rev-F
Start of Test	05-October-2022
Finish of Test	13-October-2022
Name of Engineer(s)	Neil Rousell, Graeme Lawler
Related Document(s)	KDB 971168 D01 v02r02 KDB 662911 D01 v02r01 ICES-003: Issue 7 (2020-10) ANSI C63.26-2015

---

### ENGINEERING STATEMENT

The measurements shown in this report were made in accordance with the procedures described on test pages. All reported testing was carried out on a sample equipment to demonstrate compliance with and FCC CFR 47 Part 2: 2021, FCC CFR 47 Part 24: 2021, ISED RSS-GEN: Issue 5: March 2019 Amendment 1, 2021 Amendment 2, Industry Canada RSS-133: Issue 6: January 2018 Amendment 1 The sample tested was found to comply with the requirements defined in the applied rules.

Test Engineer(s);

---

Neil Rousell      Graeme Lawler



## 1.2 BRIEF SUMMARY OF RESULTS

The tests that have been selected are detailed in the customer Test Plan as defined in section 1.1 of this report. The Test Plan is based on the TÜV SÜD FCC Test Plan Rationale, available on request.

A brief summary of results for each configuration, in accordance with FCC CFR 47 Part 2, FCC CFR 47 Part 24, ISED RSS-GEN and Industry Canada RSS-133 is shown below.

Section	Specification Clause				Test Description	Result
	FCC CFR 47 Part 2	FCC CFR 47 Part 24	RSS-GEN	RSS-133		
2.1	2.1046	24.232	-	6.4	Maximum Peak Output Power and Peak to Average Ratio - Conducted	Pass
2.2	2.1049	24.238 (b)	6.7		Occupied Bandwidth	Pass
2.3	2.1051	24.238 (b)	-	6.5	Band Edge	Pass
2.4	2.1051	24.238 (a)	6.13	6.5	Transmitter Spurious Emissions	Pass
2.5	2.1053	-	6.13	6.5	Radiated Emissions	Pass

Testing in this Report covers only B2 and B25 (1900 MHz)

For additional configurations and test cases not contained within this test report, refer to the following reports:

Document 759555712 Report 12 – Radio 4480 44B2/B25 44B66A C – B66A (2100 MHz)



### **1.3 TEST RATIONALE**

The tests that have been selected are detailed in the customer Test Plan as defined in section 1.1 of this report. The Test Plan is based on the TÜV SÜD FCC Test Plan Rationale, available on request.



#### 1.4 CONFIGURATION DESCRIPTION

Config	Band	RATs	Carriers	Pout (W)	Position	BW	Freq	NR-ARFCN
1	B25	NR in NR/ESS Setup (NB IoT IB) QPSK	1	60	B	10	1935	387000
					M	10	1962.5	392500
					T	10	1990	398000
					B	15	1937.5	387500
					M	15	1962.5	392500
					T	15	1987.5	397500
					B	20	1940	388000
					M	20	1962.5	392500
					T	20	1985	397000
2	B2	NR in NR/ESS Setup (NB IoT IB) QPSK	1	60	T	10	1985	397000
						15	1982.5	396500
						20	1980	396000



## 1.5 DECLARATION OF BUILD STATUS

Equipment Description			
Technical Description: (Please provide a brief description of the intended use of the equipment including the technologies the product supports)		Multi-standard remote radio unit Radio 4499 44B2/B25 44B66A C, 4Tx/4Rx	
Manufacturer:		Ericsson AB	
Model:		4499 44B2/B25 44B66A C	
Part Number:		KRC 161 847/1	
Hardware Version:		R2C	
Software Version:		CXP 9013268/15-R89MU15	
FCC ID of the product under test		TA8AKRC161847	
IC ID of the product under test		287AB-AS161847	
Intentional Radiators			
Frequency Range (MHz to MHz) B2 : GSM, WCDMA, LTE, NR, NB IoT SA/GB/IB	TX(DL):1930-1990MHz RX(UL):1850-1910MHz	IBW: 60MHz IBW: 60MHz	
Frequency Range (MHz to MHz) B25: WCDMA, LTE, NR, NB IoT SA/GB/IB	TX(DL):1930-1995MHz RX(UL):1850-1915MHz	IBW: 65MHz IBW: 65MHz	
Frequency Range (MHz to MHz) B66A: WCDMA, LTE, NR, NB IoT SA/GB/IB	TX(DL):2110 - 2180MHz RX(UL):1710 - 1780MHz	IBW: 70MHz IBW: 70MHz	
Conducted Declared Output Power (dBm)	47,8 Max output power per Band and port 49.0 Max output power per Port		
RAT SC carrier Power (Max) :	BW (LTE)	BW (NR)	PWR/C
	1.4MHz ( B2, B25)	not support	20W
	3MHz ( B2, B25)	not support	20W
	5MHz (B2,B25, B66A)	5MHz(B2,B25, B66A)	40 W
	10MHz (B2,B25, B66A)	10MHz(B2,B25, B66A)	60 W
	15MHz (B2,B25, B66A)	15MHz (B2,B25, B66A)	60 W
	20MHz (B2,B25, B66A)	20MHz (B2,B25, B66A)	60 W
RAT SC carrier Power (Max) :WCDMA (B2, B25, B66A)	5MHz	40W	
RAT SC carrier Power (Max) :GSM (B2)	200kHz	20W	
RAT SC carrier Power (Max) :NB-IoT SA (B2, B25, B66A)	200kHz	20 W	
Radio Configuration:	4RX / 4TX		
Duplex mode:	FDD		
Radio Access Technology, RAT(s) B2:	Single RAT: GSM, W, L, NB IoT SA, NR Multi RAT: GSM+ W+ L+ NR +NB IoT SA/GB/IB		
Supported Bandwidth(s) (MHz) B25:	Single RAT: W, L, NB IoT SA, NR Multi RAT: W+ L+ NR +NB IoT SA/GB/IB		
Supported Bandwidth(s) (MHz) B66A:	Single RAT: W, L, NB IoT SA, NR Multi RAT: WW+ L+ NR +NB IoT SA/GB/IB		





Antenna Gain (dBi)	Maximum antenna system gain (including cable loss), GANT (dBi) for the tested configurations to comply with maximum radiated output power in SRSP -513 and SRSP-510 calculated using measured and summed PSD from all 4 Ports	
Antenna Impedance( $\Omega$ )	50	
Supported modulation scheme, LTE:	QPSK, 16QAM, 64QAM, 256QAM	
Supported modulation scheme, NR:	QPSK, 16QAM, 64QAM, 256QAM	
Supported modulation scheme, WCDMA:	QPSK, 16QAM, 64QAM	
Supported modulation scheme, GSM:	GMSK, AQPSK, 8PSK	
Supported modulation scheme, NB-IoT :	QPSK	
NR SCS	15kHz	
RF power Tolerance:	.+0.6/-2.5dB	
Frequency Tolerance:	$\pm 0.05$ ppm	
Carrier Aggregation, CA	Supported	
Maximum supported number of DL NR carrier per port	6/multi-Band	
Maximum supported number of DL LTE carrier per port	6/multi-Band	
Maximum supported number of DL WCDMA carrier per port	6/multi-Band	
Maximum supported number of DL GSM carrier per port	4/multi-Band	
Maximum supported number of DL NB-IoT carrier per port	2/multi-Band	
Supported transmission modes:	4X4 MIMO	
Unintentional Radiators		
Highest frequency generated or used in the device or on which the device operates or tunes		Up to 10.1 Gbit/s
Lowest frequency generated or used in the device or on which the device operates or tunes if <30MHz		.-
Class A Digital Device (Use in commercial, industrial or business environment)		.-
Class B Digital Device (Use in residential environment)		Class B
DC Power Supply (Delete if Not Applicable)		
Nominal voltage: DC power supply		-48V
Extreme upper voltage:		-36.0V
Extreme lower voltage:		-58.5V
Max current:		32A
Temperature		
Minimum temperature:		-40°C
Maximum temperature:		55°C
I hereby declare that I am entitled to sign on behalf of the manufacturer and that the information supplied is correct and complete.		
Name:		Afrah Ali sadiq
Position held:		Regulatory Approval Engineer
Email address:		<a href="mailto:Afrah.ali.sadiq@ericsson.com">Afrah.ali.sadiq@ericsson.com</a>
Telephone number:		+.46724650796
Date:		03-Nov-2022

No responsibility will be accepted by TÜV SÜD as to the accuracy of the information declared in this document by the manufacturer.

## 1.6 PRODUCT INFORMATION

### 1.6.1 Technical Description

The Equipment Under Test (EUT) Radio 4499 44B2/B25 44B66A C - KRC 161 847/1 is an Ericsson AB Radio Unit working in the public mobile service Band 2/ Band 25 band which provides communication connections to Band 2/ Band 25 network.

The EUT is declared as operating from a nominal -48V DC supply.

The Equipment Under Test (EUT) is shown in the photograph below. A full technical description can be found in the Manufacturer's documentation.

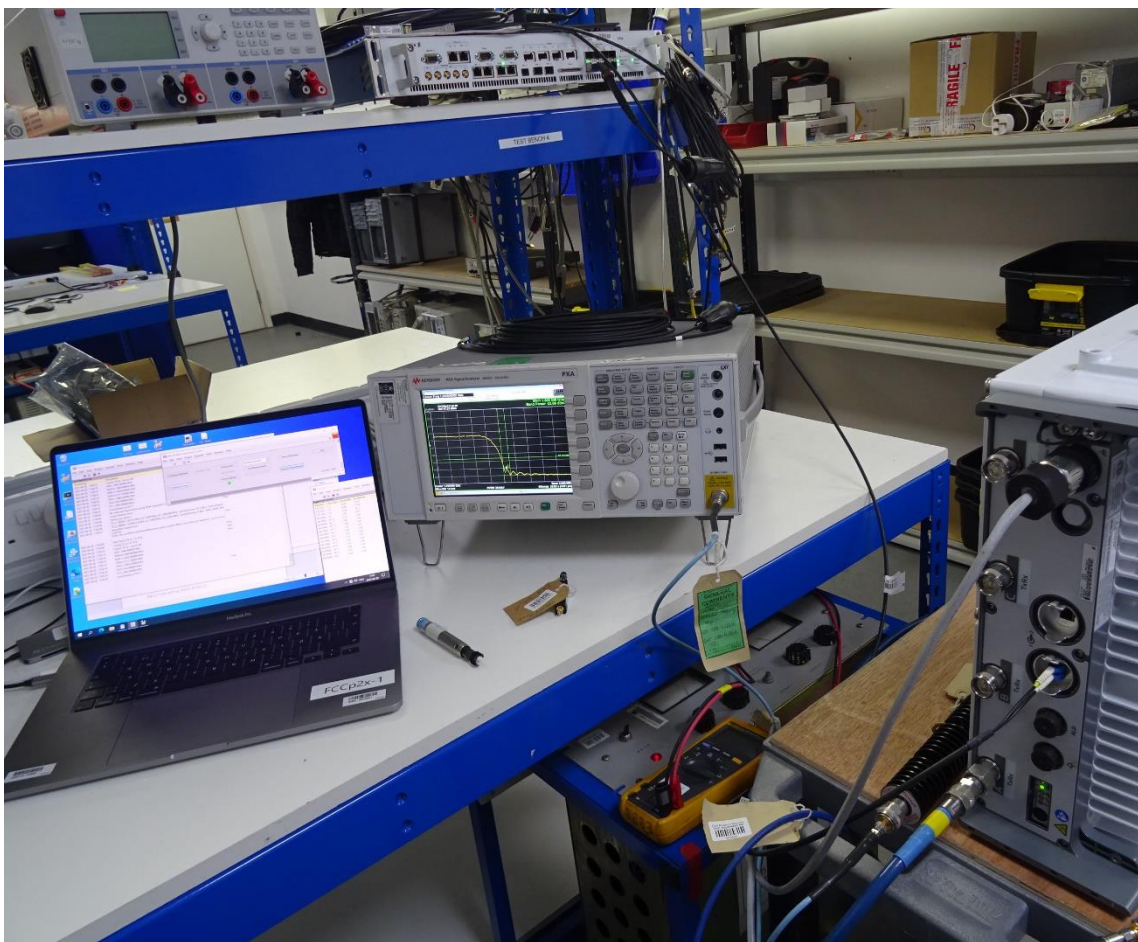

Equipment Under Test



## 1.7 TEST SETUP

### Conducted Test Set Up

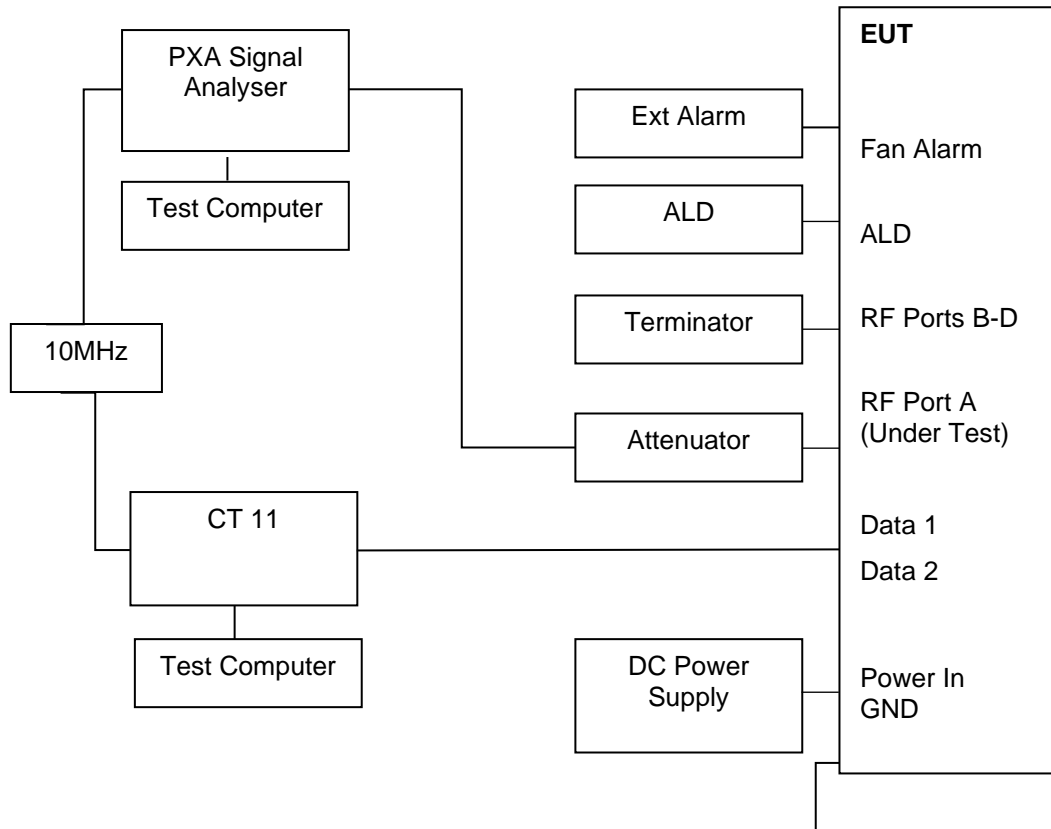



Radiated Test Set Up – Dashed line indicates equipment inside the Chamber for Radiated testing.

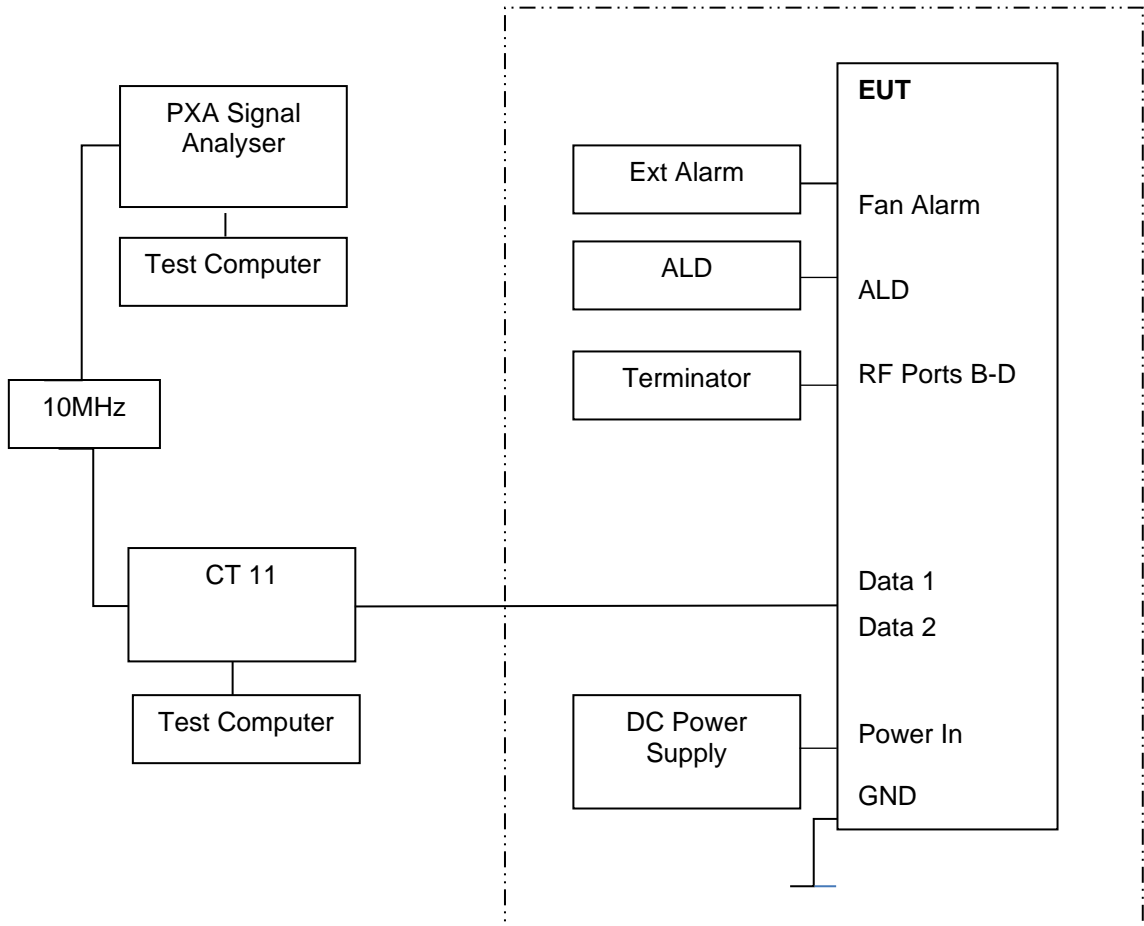



## 1.8 TEST CONDITIONS

For all tests the EUT was set up in accordance with the relevant test standard and to represent typical operating conditions. Tests were applied with the EUT situated as described in the Test Method for each Test.

The EUT was powered from a -48V DC supply unless otherwise stated.

FCC Measurement Facility Registration Number  
90987 Octagon House, Fareham Test Laboratory  
Postal Address: Octagon House, Concorde Way, Fareham, Hampshire, UK, PO15 5RL

ISED Accreditation  
IC#12669A Octagon House, Fareham Test Laboratory  
Postal Address: Octagon House, Concorde Way, Fareham, Hampshire, UK, PO15 5RL

Under our UKAS Accreditation, TÜV SÜD conducted the following tests Octagon House, Fareham Laboratory.

Test Name	Name of Engineer(s)
Maximum Peak Output Power and Peak to Average Ratio - Conducted	Neil Rousell
Occupied Bandwidth	Neil Rousell
Band Edge	Neil Rousell
Transmitter Spurious Emissions	Neil Rousell
Radiated Emissions	Graeme Lawler

## 1.9 DEVIATION FROM THE STANDARD

No deviations from the applicable test standards or test plan were made during testing.

## 1.10 MODIFICATION RECORD

No modifications were made to the EUT during testing.



## 1.11 ADDITIONAL INFORMATION

Ericsson will limit this product through the software from operating across the whole of Band 66, it will be limited to Band 66A.

This filing is for a Class 2 Permissive change to add NR with NB-IoT to a previously certified Radio for use in the USA and Canada under the following ID's:

FCC: TA8AKRC161847  
IC: 287AB-AS161847

This device is electrically identical as originally certified as no hardware changes have been made

Frequency Stability has been verified at time of original certification.

This EUT uses the same port for Tx and Rx and therefore RX Spurious Emissions has not been performed. Rx Spurious Emissions have been covered by testing to FCC Part 15B, which are covered by a separate test report.

Throughout this report the power unit dBm is used. dBm is a unit of level used to indicate that a power level is expressed in decibels (dB) with reference to one milliwatt (mW). It is used as a convenient measure of absolute power because of its capability to express both very large and very small values in a short form.



## **SECTION 2**

### **TEST DETAILS**



**2.1 MAXIMUM PEAK OUTPUT POWER AND PEAK TO AVERAGE RATIO - CONDUCTED**

**2.1.1 Specification Reference**

FCC CFR 47 Part 24, Clause 24.232  
 Industry Canada RSS-133, Clause 6.4  
 FCC CFR 47 Part 2, Clause 2.1046

**2.1.2 Date of Test and Modification State**

05-October-2022 - Modification State 0

**2.1.3 Test Equipment Used**

The major items of test equipment used for the above tests are identified in Section 3.1.

**2.1.4 Environmental Conditions**

Ambient Temperature 23.0-23.3°C  
 Relative Humidity 54.857.3%

**2.1.5 Test Method**

All measurements were made in accordance with FCC KDB 971168 D01, clause 5.2.1 and summed in accordance with FCC KDB 662911 D01.

**2.1.6 Test Results**

Configuration 1

Maximum Output Power 47.78 dBm

Antenna	NR Modulation	NR Carrier Bandwidth	Peak to Average Ratio (PAR) / Output Power / PSD						
			Channel Position B						
			PAR (dB)	Average Power/PSD		Total Power Ports A+B+C+D		GANT* Limit 62.15dB	GANT* Limit 65.15dB
			dBm	dBm/MHz	dBm	dBm/MHz	dBi	dBi	
A	QPSK	10.0 MHz 15 kHz SCS	7.43	47.15	38.91	53.17	44.93	17.22	20.22
A	QPSK	15.0 MHz 15 kHz SCS	7.62	47.09	38.32	53.11	44.34	17.81	20.81
A	QPSK	20.0 MHz 15 kHz SCS	7.67	47.22	38.09	53.24	44.11	18.04	21.04

Remarks

Calculations:

Total Power = Measured Output Power (port A, worst case) + 10log (NANT)  
 Where NANT refers to the number of Ports.

\* Maximum antenna system gain (including cable loss), GANT (dBi) 50 ohm, for the tested configurations, to comply with Maximum radiated output power in ISED SRSP-510, calculated using measured and summed PSD for all 4 ports.





Antenna A - NR Modulation QPSK - NR Carrier Bandwidth 10.0 MHz 15 kHz SCS - Channel Position B

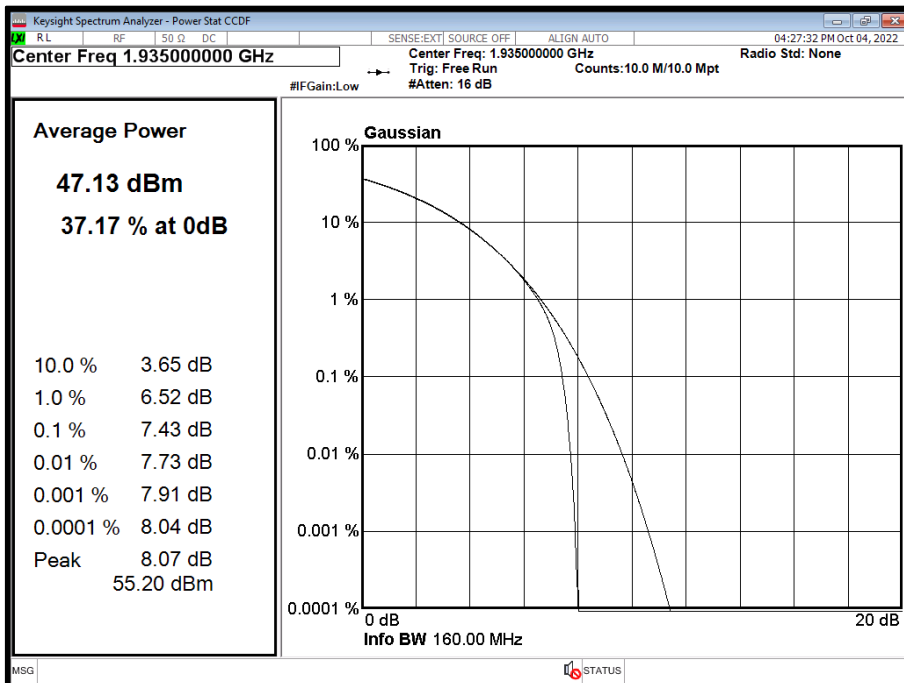

Antenna A - NR Modulation QPSK - NR Carrier Bandwidth 15.0 MHz 15 kHz SCS - Channel Position B

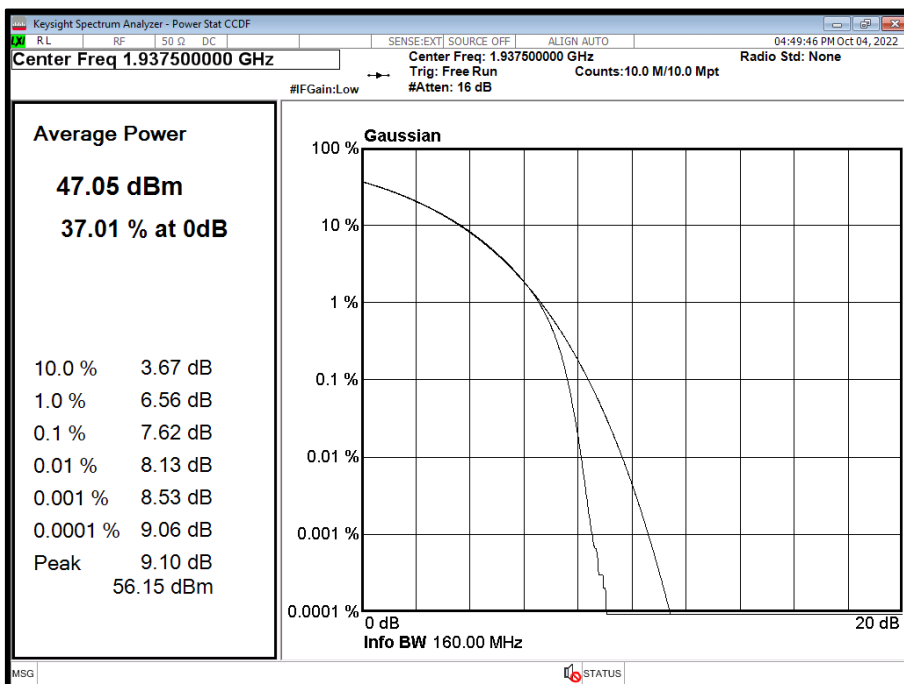



Antenna A - NR Modulation QPSK - NR Carrier Bandwidth 20.0 MHz 15 kHz SCS - Channel Position B

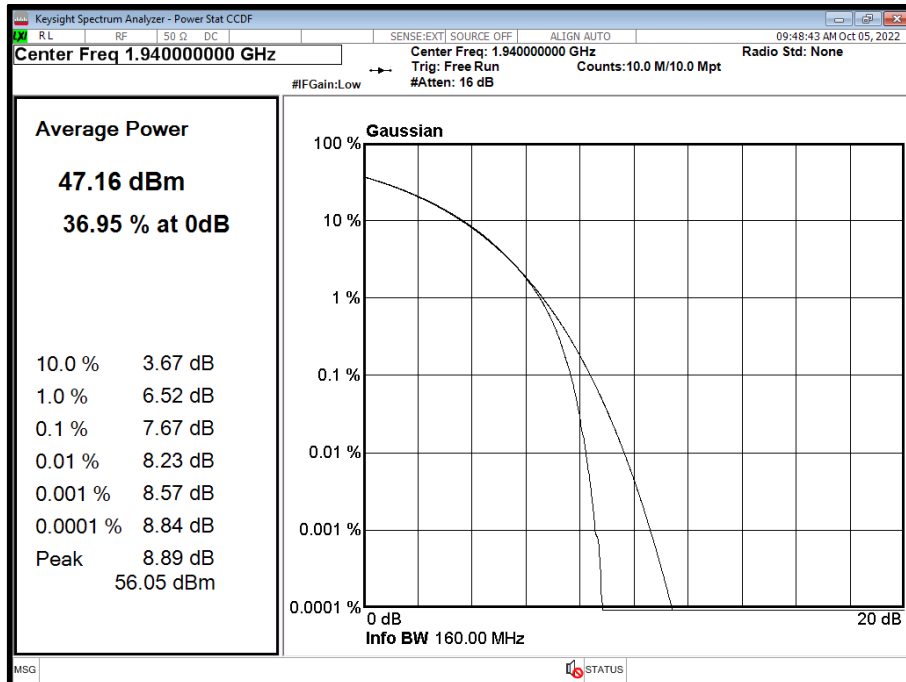

Configuration 1

Maximum Output Power 47.78 dBm

Antenna	NR Modulation	NR Carrier Bandwidth	Peak to Average Ratio (PAR) / Output Power / PSD						
			Channel Position M						
			PAR (dB)	Average Power/PSD		Total Power Ports A+B+C+D		GANT* Limit 62.15dB	GANT* Limit 65.15dB
			dBm	dBm/MHz	dBm	dBm/MHz	dBi	dBi	
A	QPSK	10.0 MHz 15 kHz SCS	7.35	47.51	39.14	53.53	45.16	16.99	19.99
A	QPSK	15.0 MHz 15 kHz SCS	7.42	47.50	38.57	53.52	44.59	17.56	20.56
A	QPSK	20.0 MHz 15 kHz SCS	7.38	47.49	38.37	53.51	44.39	17.76	20.76

Remarks

Calculations:

Total Power = Measured Output Power (port A, worst case) + 10log (NANT)  
 Where NANT refers to the number of Ports.

\* Maximum antenna system gain (including cable loss), GANT (dBi) 50 ohm, for the tested configurations, to comply with Maximum radiated output power in ISED SRSP-510, calculated using measured and summed PSD for all 4 ports.



Antenna A - NR Modulation QPSK - NR Carrier Bandwidth 10.0 MHz 15 kHz SCS - Channel Position M

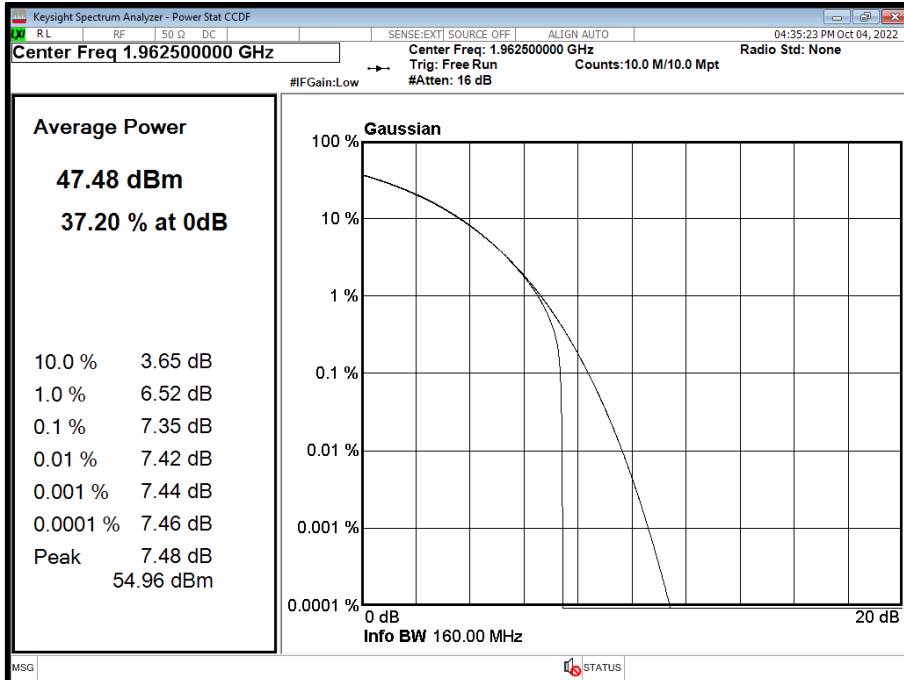

Antenna A - NR Modulation QPSK - NR Carrier Bandwidth 15.0 MHz 15 kHz SCS - Channel Position M

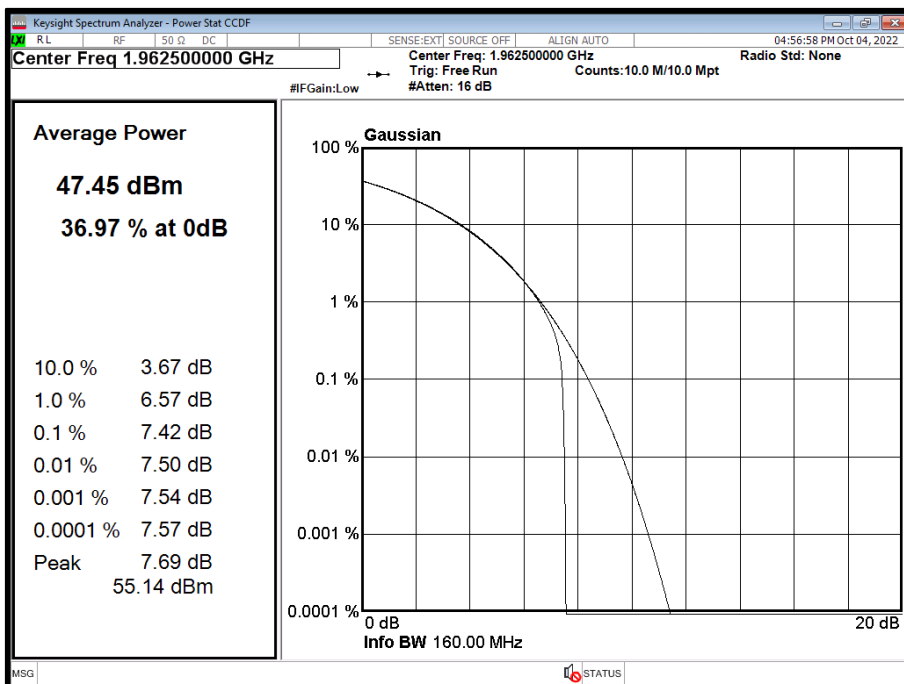



Antenna A - NR Modulation QPSK - NR Carrier Bandwidth 20.0 MHz 15 kHz SCS - Channel Position M

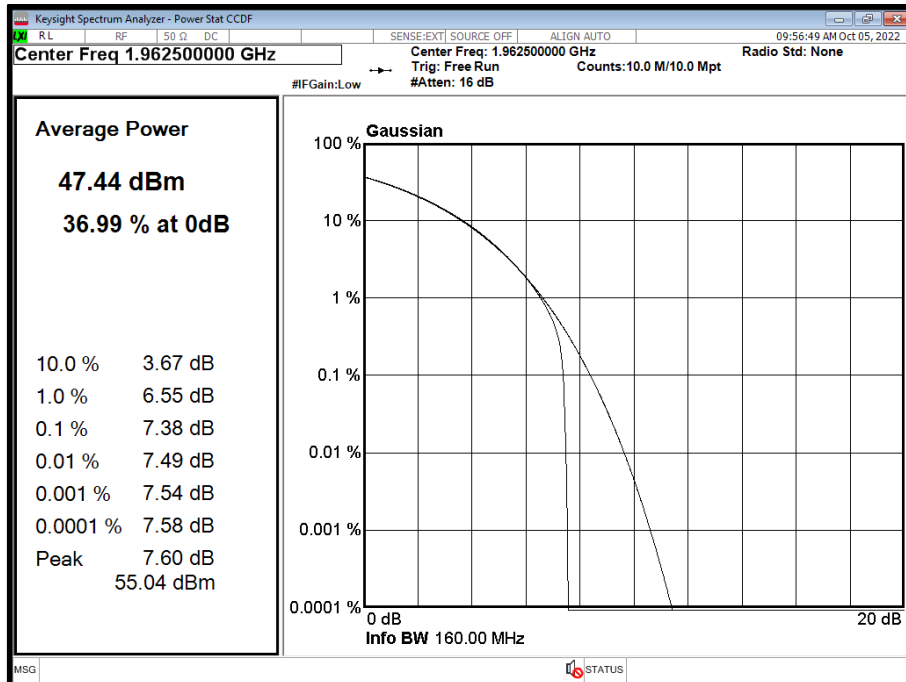

Configuration 1

Maximum Output Power 47.78 dBm

Antenna	NR Modulation	NR Carrier Bandwidth	Peak to Average Ratio (PAR) / Output Power / PSD						
			Channel Position T						
			PAR (dB)	Average Power/PSD		Total Power Ports A+B+C+D		GANT* Limit 62.15dB	GANT* Limit 65.15dB
	dBm	dBm/MHz	dBm	dBm/MHz	dBi	dBi			
A	QPSK	10.0 MHz 15 kHz SCS	7.37	47.36	39.14	53.38	45.16	16.99	19.99
A	QPSK	15.0 MHz 15 kHz SCS	7.46	47.41	38.53	53.43	44.55	17.60	20.60
A	QPSK	20.0 MHz 15 kHz SCS	7.49	47.48	38.34	53.50	44.36	17.79	20.79

Remarks

Calculations:

Total Power = Measured Output Power (port A, worst case) + 10log (NANT)  
 Where NANT refers to the number of Ports.

\* Maximum antenna system gain (including cable loss), GANT (dBi) 50 ohm, for the tested configurations, to comply with Maximum radiated output power in ISED SRSP-510, calculated using measured and summed PSD for all 4 ports.



Antenna A - NR Modulation QPSK - NR Carrier Bandwidth 10.0 MHz 15 kHz SCS - Channel Position T

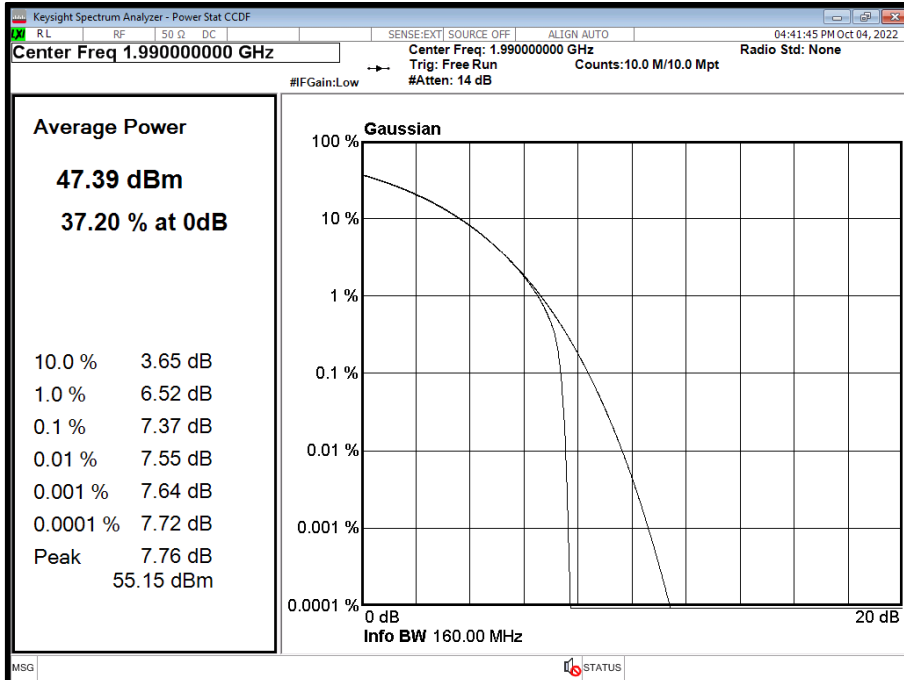

Antenna A - NR Modulation QPSK - NR Carrier Bandwidth 15.0 MHz 15 kHz SCS - Channel Position T

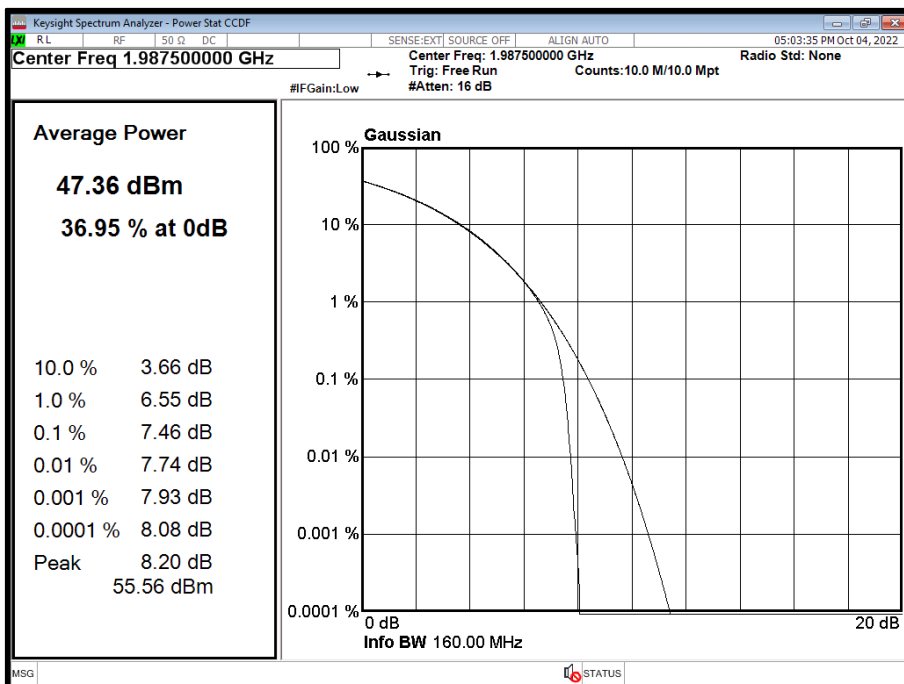



Antenna A - NR Modulation QPSK - NR Carrier Bandwidth 20.0 MHz 15 kHz SCS - Channel Position T

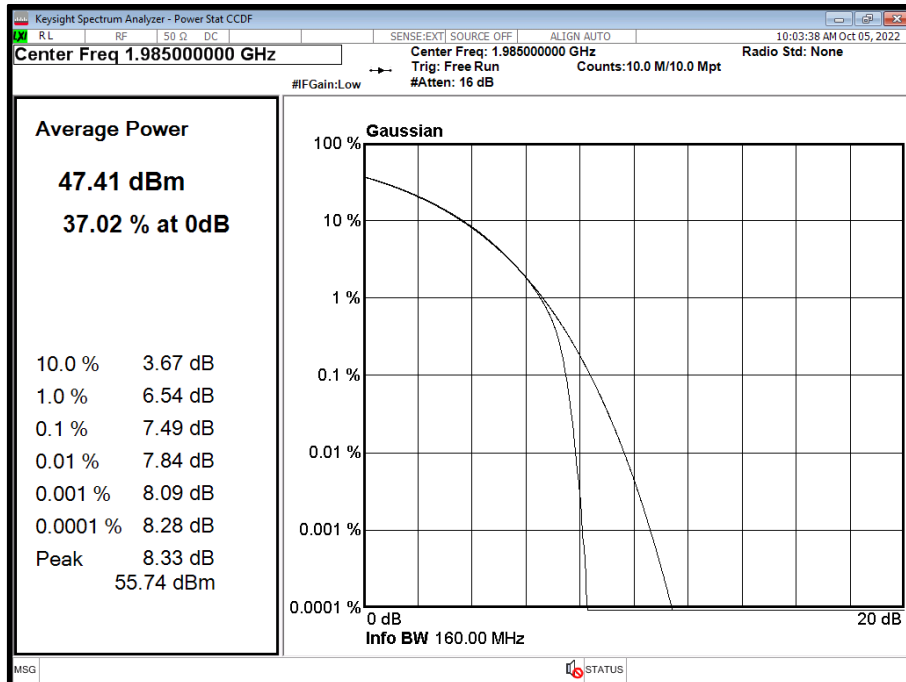

Configuration 2

Maximum Output Power 47.78 dBm

Antenna	NR Modulation	NR Carrier Bandwidth	Peak to Average Ratio (PAR) / Output Power / PSD						
			Channel Position T						
			PAR (dB)	Average Power/PSD		Total Power Ports A+B+C+D		GANT* Limit 62.15dB	GANT* Limit 65.15dB
	dBm	dBm/MHz	dBm	dBm/MHz	dBi	dBi			
A	QPSK	10.0 MHz 15 kHz SCS	7.37	47.49	39.17	53.51	45.19	16.96	19.96
A	QPSK	15.0 MHz 15 kHz SCS	7.45	47.45	38.56	53.47	44.58	17.57	20.57
A	QPSK	20.0 MHz 15 kHz SCS	7.41	47.52	38.44	53.54	44.46	17.69	20.69

Remarks

Calculations:

Total Power = Measured Output Power (port A, worst case) + 10log (NANT)

Where NANT refers to the number of Ports.

\* Maximum antenna system gain (including cable loss), GANT (dBi) 50 ohm, for the tested configurations, to comply with Maximum radiated output power in ISED SRSP-510, calculated using measured and summed PSD for all 4 ports.



Antenna A - NR Modulation QPSK - NR Carrier Bandwidth 10.0 MHz 15 kHz SCS - Channel Position T

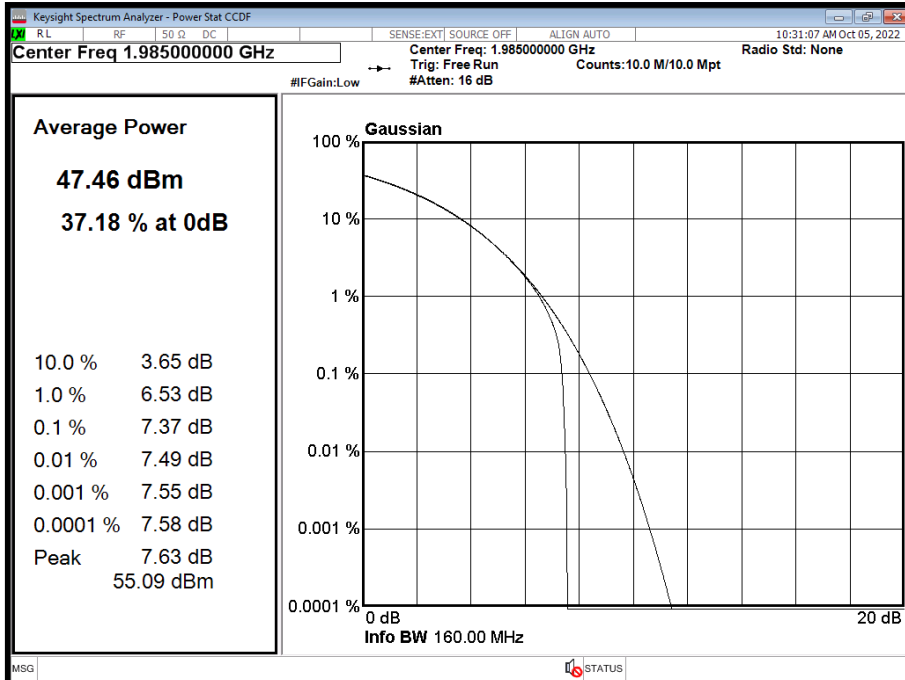

Antenna A - NR Modulation QPSK - NR Carrier Bandwidth 15.0 MHz 15 kHz SCS - Channel Position T

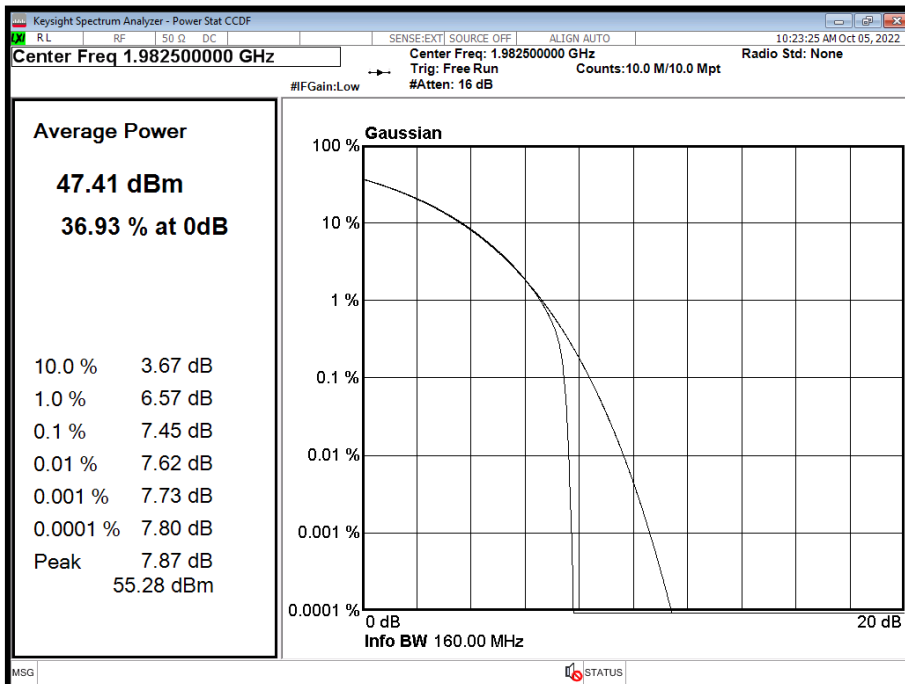



Antenna A - NR Modulation QPSK - NR Carrier Bandwidth 20.0 MHz 15 kHz SCS - Channel Position T

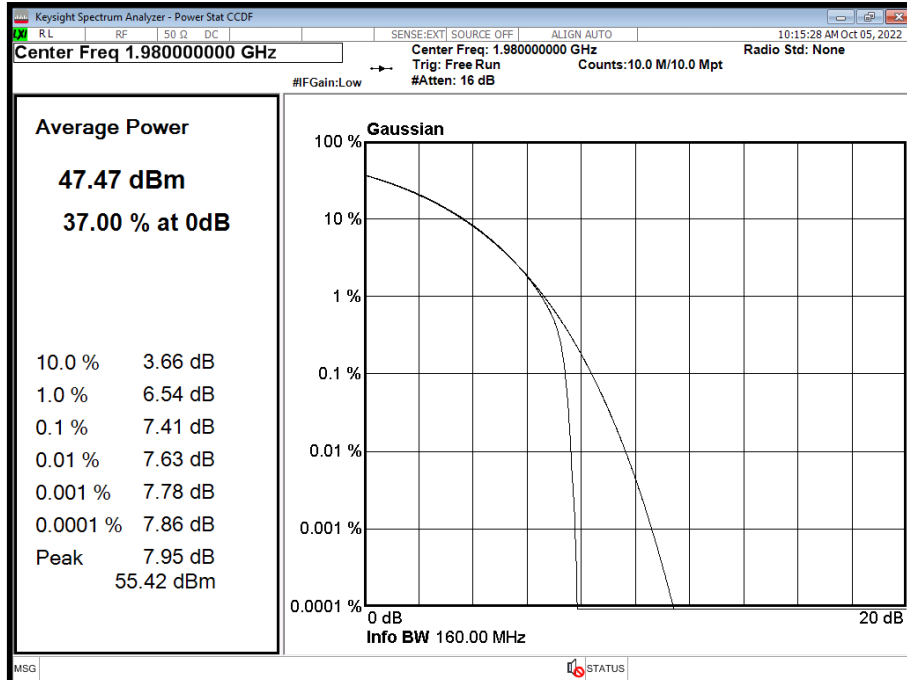

FCC Part 24.232 Clauses (a) & (b)

Limit	
Maximum ERP (Urban)	≤ 1640 W or ≤+62.15 dBm (antenna height ≤300m) ≤ 1070 W or ≤+60.30 dBm (antenna height ≤500m) ≤ 490 W or ≤+56.90 dBm (antenna height ≤1000m) ≤ 270 W or ≤+54.31 dBm (antenna height ≤1500m) ≤ 160 W or ≤+52.04 dBm (antenna height ≤2000m)
Maximum ERP (Non-Urban)	≤ 3280 W or ≤+65.15 dBm (antenna height ≤300m) ≤ 2140 W or ≤+63.30 dBm (antenna height ≤500m) ≤ 980 W or ≤+59.91 dBm (antenna height ≤1000m) ≤ 540 W or ≤+57.32 dBm (antenna height ≤1500m) ≤ 320 W or ≤+55.05 dBm (antenna height ≤2000m)

RSS-133 Clause 6.4

Limit	
Peak to Average Ratio	13 dB





SRSP-510 Power and Antenna Height Limitations Clause 5.1.1 & 5.1.2

Limit	
Maximum EIRP (Non-Urban)	$\leq 3280 \text{ W/MHz}$ or $\leq +65.15 \text{ dBm}$
Maximum EIRP (Urban)	$\leq 1640 \text{ W/MHz}$ or $\leq +62.15 \text{ dBm}$ (antenna height $\leq 300\text{m}$ )
	$\leq 1070 \text{ W/MHz}$ or $\leq +60.30 \text{ dBm}$ (antenna height $\leq 500\text{m}$ )
	$\leq 490 \text{ W/MHz}$ or $\leq +56.90 \text{ dBm}$ (antenna height $\leq 1000\text{m}$ )
	$\leq 270 \text{ W/MHz}$ or $\leq +54.31 \text{ dBm}$ (antenna height $\leq 1500\text{m}$ )
	$\leq 160 \text{ W/MHz}$ or $\leq +52.04 \text{ dBm}$ (antenna height $\leq 2000\text{m}$ )



## **2.2 OCCUPIED BANDWIDTH**

### **2.2.1 Specification Reference**

FCC CFR 47 Part 24, Clause 24.238 (b)  
ISED RSS-GEN, Clause 6.7  
FCC CFR 47 Part 2, Clause 2.1049

### **2.2.2 Date of Test and Modification State**

05-October-2022 - Modification State 0

### **2.2.3 Test Equipment Used**

The major items of test equipment used for the above tests are identified in Section 3.1.

### **2.2.4 Environmental Conditions**

Ambient Temperature	23.0-23.3°C
Relative Humidity	54.8-57.3%

### **2.2.5 Test Method**

All measurements were made in accordance with FCC KDB 971168 D01, Clause 4.2 and 4.3. The Spectrum Analyser RBW was configured to be at least 1% of the channel bandwidth of the carrier to be measured.

For 26 dB Bandwidth, in accordance with KDB 971168 D01, a peak detector and a trace setting of Max Hold were used. The trace was allowed to stabilise. Using the Spectrum Analyser function, the 26dB measurement result was obtained.

#### **4.2 Occupied bandwidth – relative measurement procedure**

The reference value is the highest level of the spectral envelope of the modulated signal, unless otherwise specified in an applicable rule section.

Subclause 5.4.3 of ANSI C63.26-2015 is applicable.

#### **4.3 Occupied bandwidth – power bandwidth (99 %) measurement procedure**

Subclause 5.4.4 of ANSI C63.26-2015 is applicable (wherein the recommendation is to use the 99 % power bandwidth function of a spectrum analyzer).

### **2.2.6 Test Results**

Configuration 1

Maximum Output Power 47.78 dBm



Antenna	NR Modulation	NR Carrier Bandwidth	Result (kHz)					
			Channel Position B		Channel Position M		Channel Position T	
			Occupied Bandwidth	-26 dB Bandwidth	Occupied Bandwidth	-26 dB Bandwidth	Occupied Bandwidth	-26 dB Bandwidth
A	QPSK	10.0 MHz 15 kHz SCS	9435.52	9800.99	9438.29	9806.10	9441.88	9809.50
A	QPSK	15.0 MHz 15 kHz SCS	14357.62	14795.53	14367.52	14813.67	14359.06	14805.46
A	QPSK	20.0 MHz 15 kHz SCS	19181.41	19741.78	19185.40	19759.59	19183.87	19760.58

Antenna A - NR Modulation QPSK - NR Carrier Bandwidth 10.0 MHz 15 kHz SCS - Channel Position B

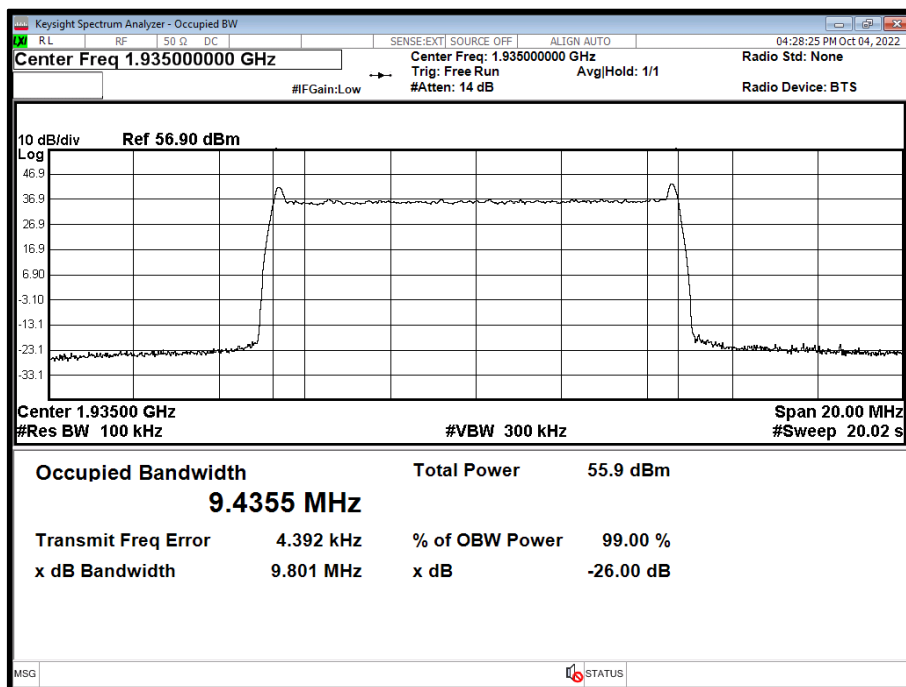



Antenna A - NR Modulation QPSK - NR Carrier Bandwidth 10.0 MHz 15 kHz SCS - Channel Position M

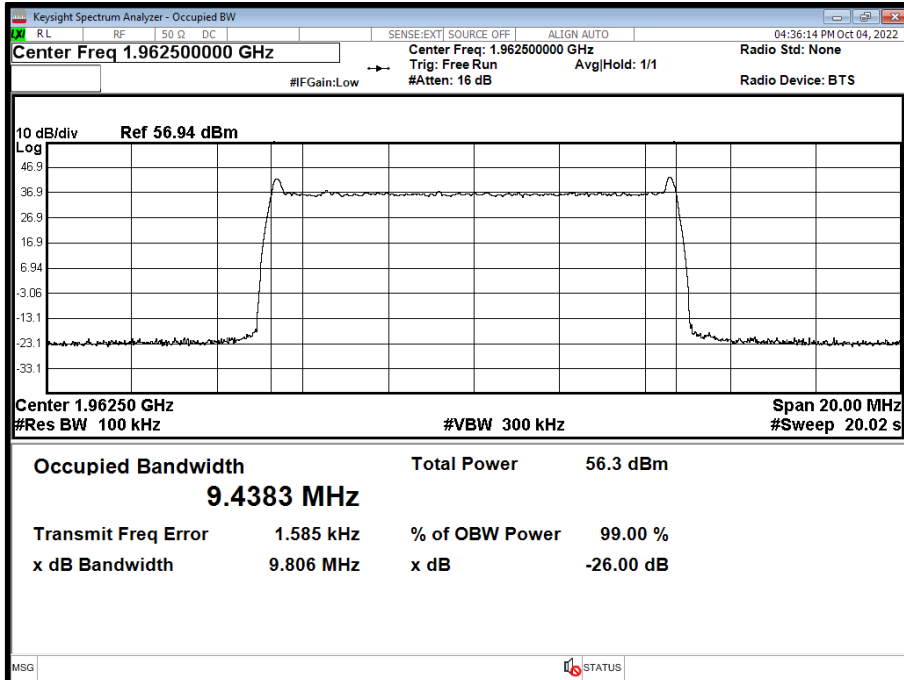

Antenna A - NR Modulation QPSK - NR Carrier Bandwidth 10.0 MHz 15 kHz SCS - Channel Position T

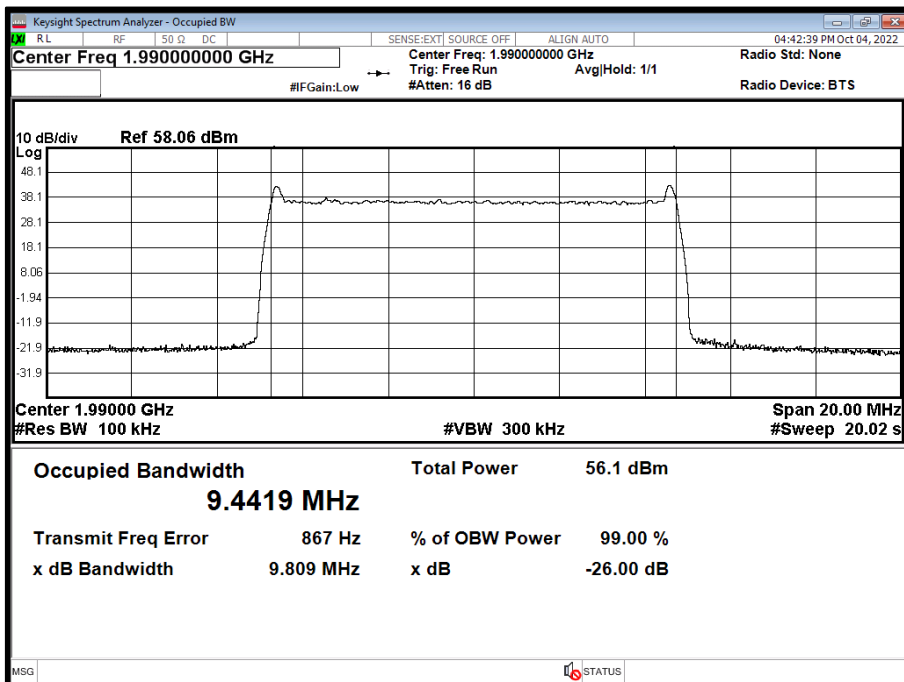



Antenna A - NR Modulation QPSK - NR Carrier Bandwidth 15.0 MHz 15 kHz SCS - Channel Position B

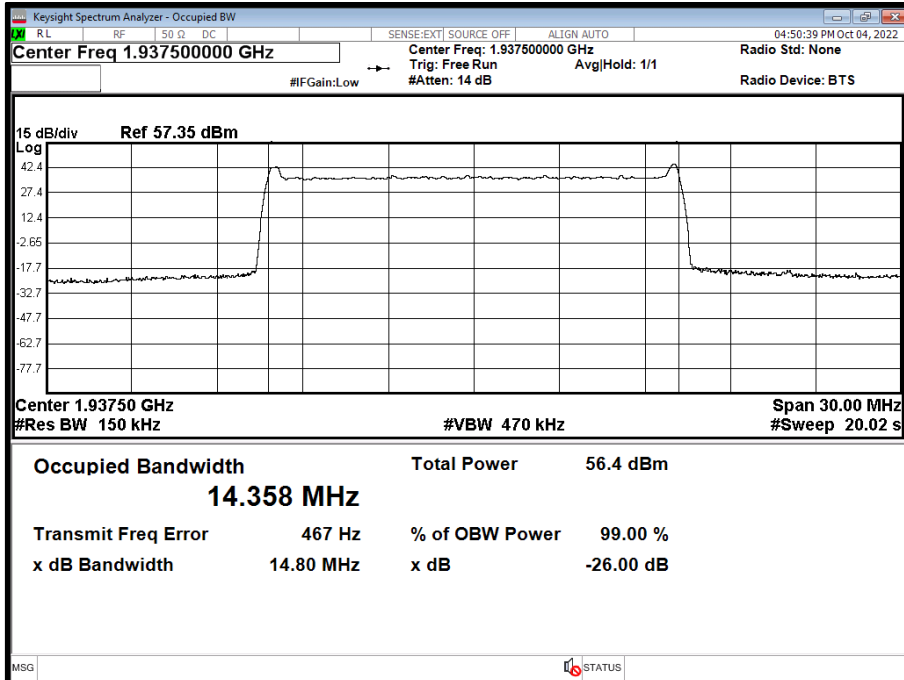

Antenna A - NR Modulation QPSK - NR Carrier Bandwidth 15.0 MHz 15 kHz SCS - Channel Position M

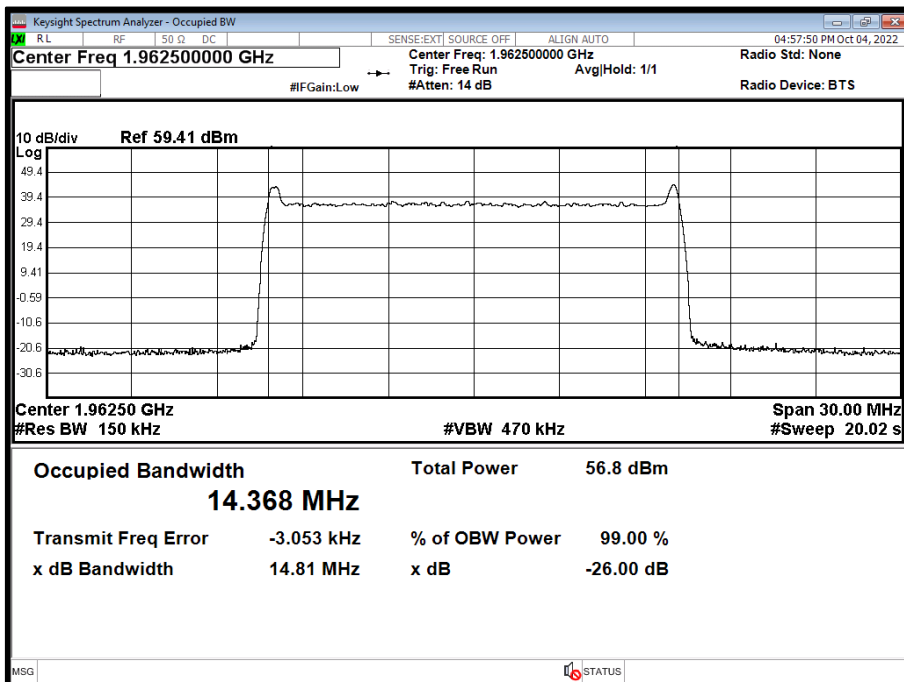



Antenna A - NR Modulation QPSK - NR Carrier Bandwidth 15.0 MHz 15 kHz SCS - Channel Position T

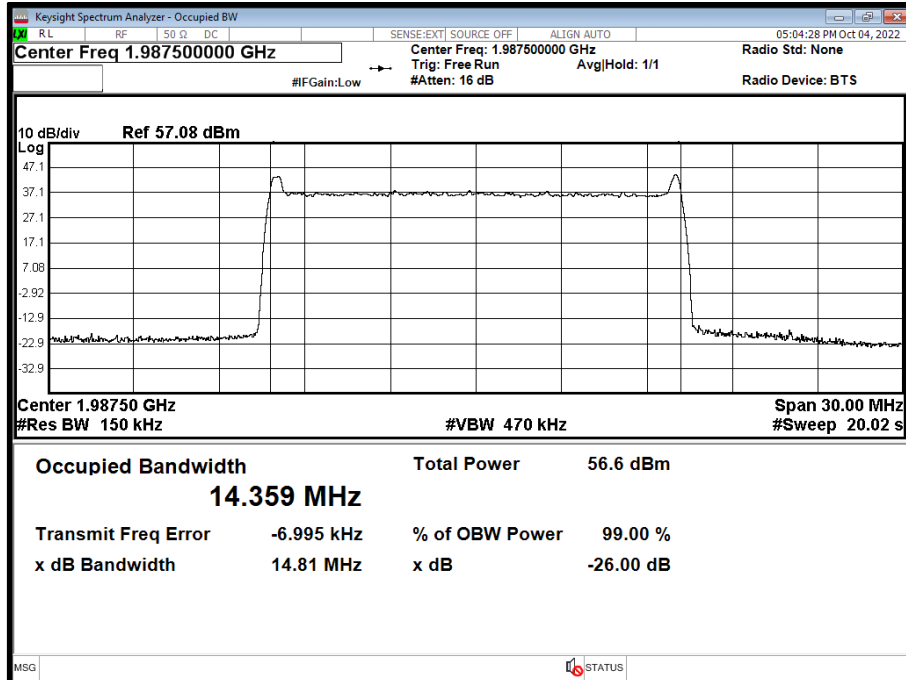

Antenna A - NR Modulation QPSK - NR Carrier Bandwidth 20.0 MHz 15 kHz SCS - Channel Position B

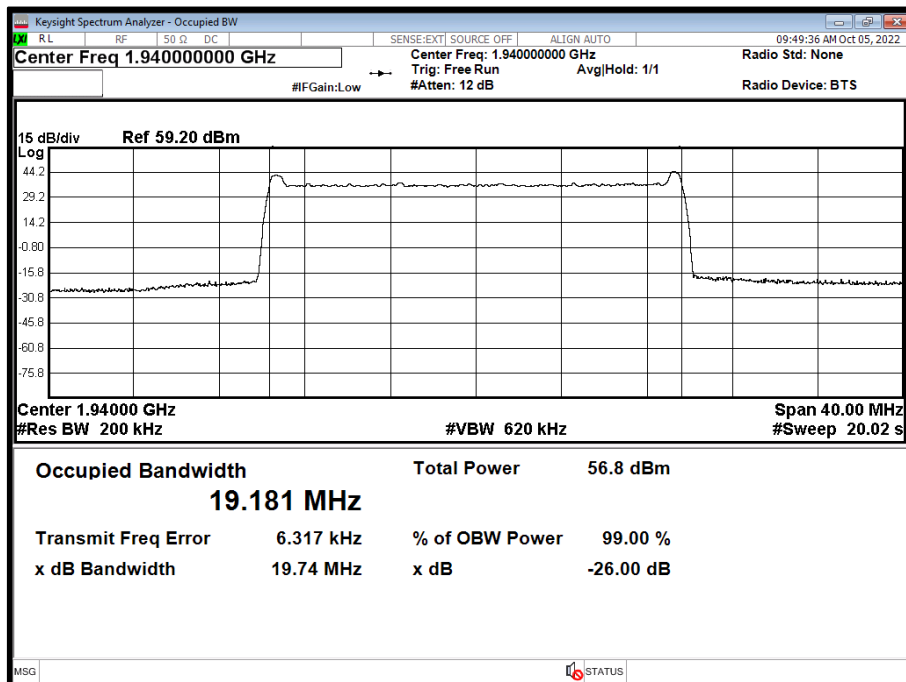



Antenna A - NR Modulation QPSK - NR Carrier Bandwidth 20.0 MHz 15 kHz SCS - Channel Position M

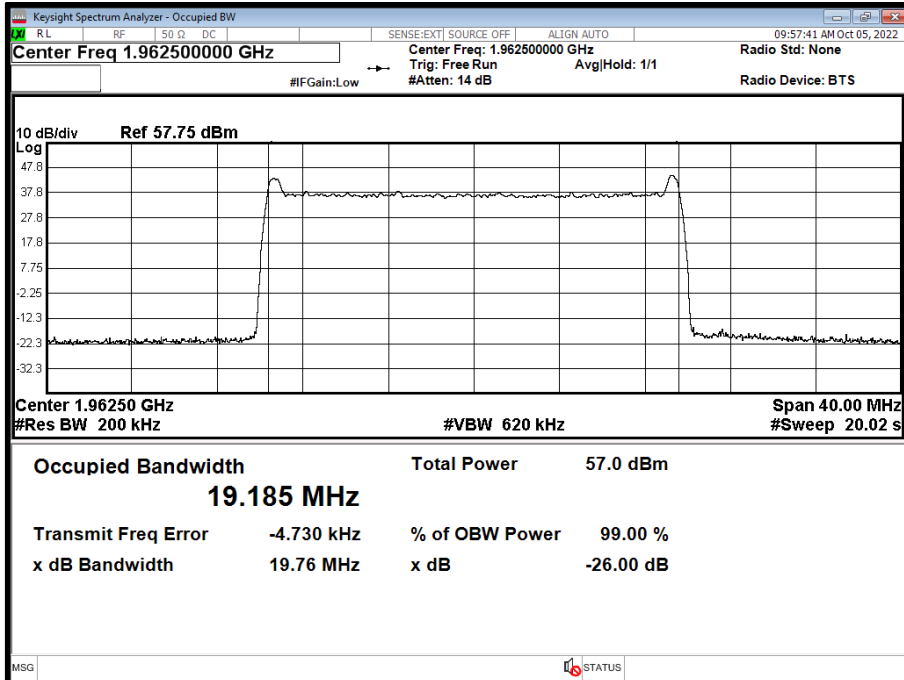

Antenna A - NR Modulation QPSK - NR Carrier Bandwidth 20.0 MHz 15 kHz SCS - Channel Position T

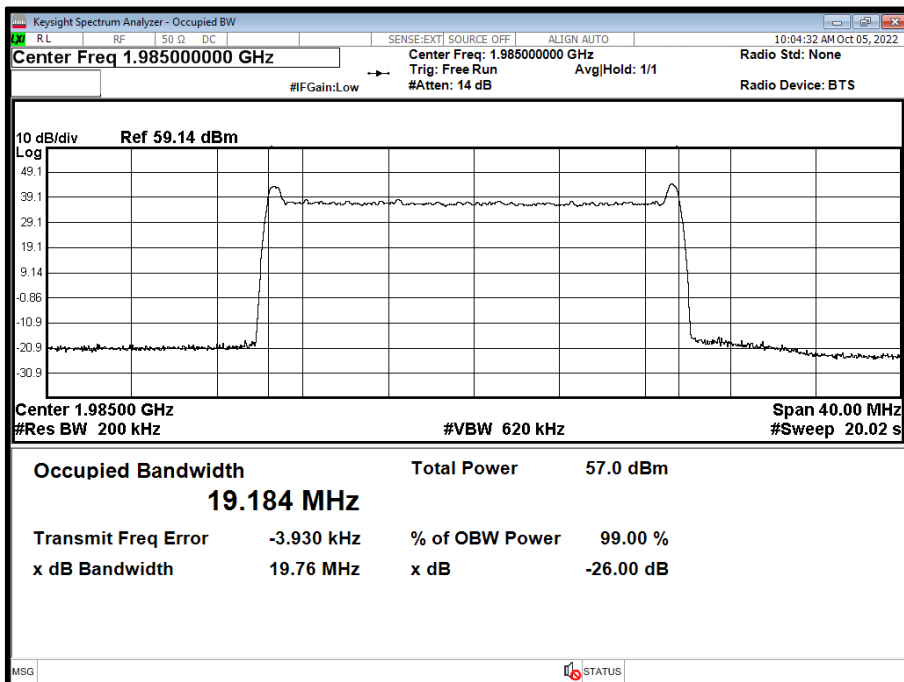



Configuration 2

Maximum Output Power 47.78 dBm

Antenna	NR Modulation	NR Carrier Bandwidth	Result (kHz)					
			Channel Position B		Channel Position M		Channel Position T	
			Occupied Bandwidth	-26 dB Bandwidth	Occupied Bandwidth	-26 dB Bandwidth	Occupied Bandwidth	-26 dB Bandwidth
A	QPSK	10.0 MHz 15 kHz SCS	-	-	-	-	9442.33	9808.25
A	QPSK	15.0 MHz 15 kHz SCS	-	-	-	-	14368.07	14804.30
A	QPSK	20.0 MHz 15 kHz SCS	-	-	-	-	19187.52	19744.87

Antenna A - NR Modulation QPSK - NR Carrier Bandwidth 10.0 MHz 15 kHz SCS - Channel Position T

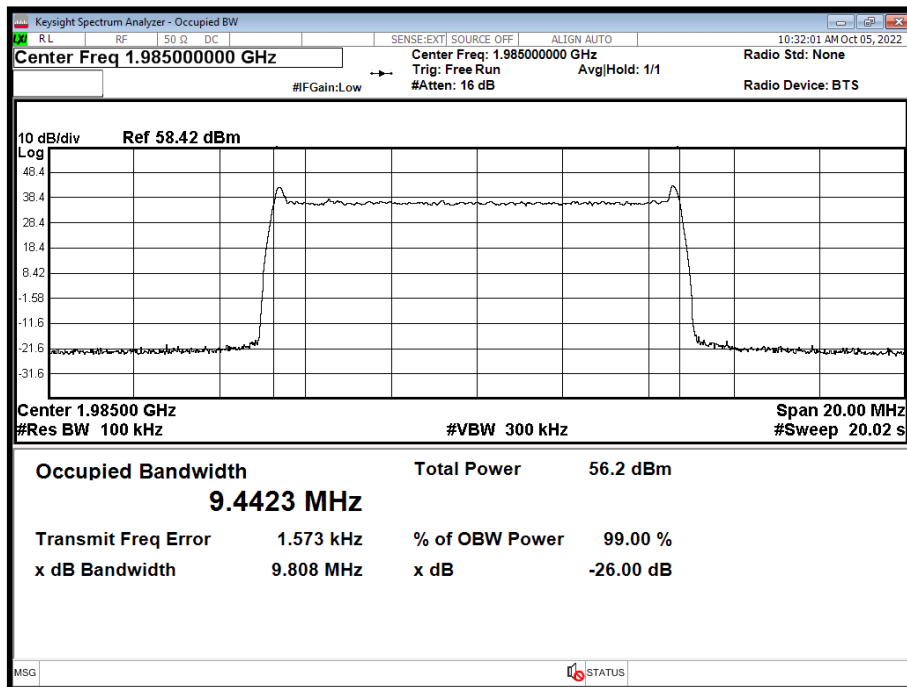





Antenna A - NR Modulation QPSK - NR Carrier Bandwidth 15.0 MHz 15 kHz SCS - Channel Position T

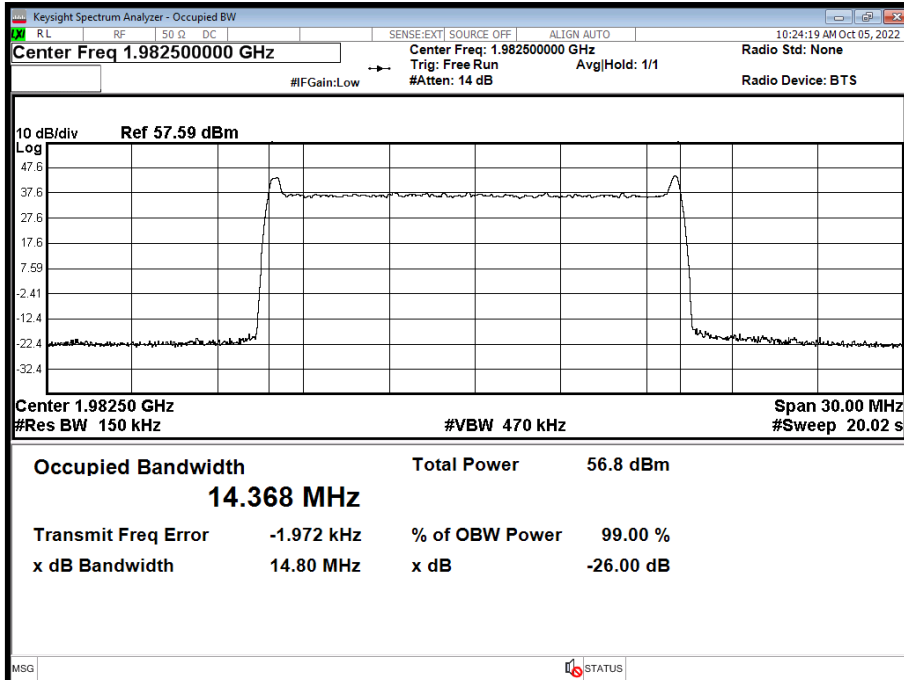

Antenna A - NR Modulation QPSK - NR Carrier Bandwidth 20.0 MHz 15 kHz SCS - Channel Position T

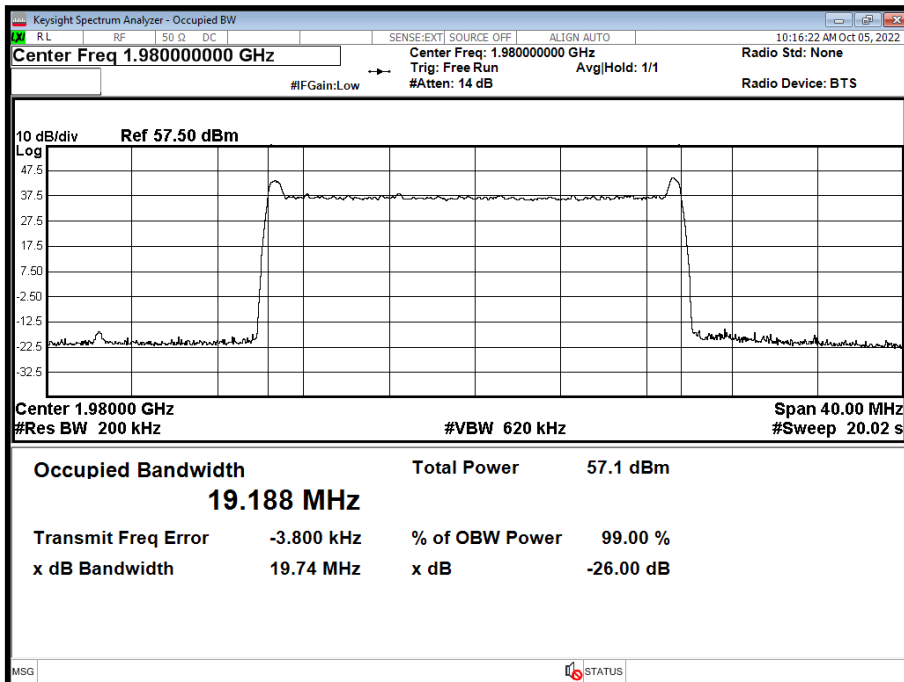



**2.3 BAND EDGE**

**2.3.1 Specification Reference**

FCC CFR 47 Part 24, Clause 24.238 (b)  
Industry Canada RSS-133, Clause 6.5  
FCC CFR 47 Part 2, Clause 2.1051

**2.3.2 Date of Test and Modification State**

05-October-2022 - Modification State 0

**2.3.3 Test Equipment Used**

The major items of test equipment used for the above tests are identified in Section 3.1.

**2.3.4 Environmental Conditions**

Ambient Temperature 23.0°C  
Relative Humidity 54.8%

**2.3.5 Test Method**

All measurements were made in accordance with FCC KDB 971168 D01, Clause 6.0.

Band Edge measurements were used an Integration Bandwidth of at least 1% of the measured 26dB Bandwidth.

Each antenna port has been declared as being equivalent, therefore measurements were made on one antenna port only. To account for this, the limit was tightened by  $10 * \text{Log}(N)$ , where N is equal to the number of MIMO antenna ports.

For single port, the limit was calculated as being  $-13 \text{ dBm} - 10 * \text{Log}(4) = -19 \text{ dBm}$ .

**2.3.6 Test Results**

Configuration 1

Maximum Output Power 47.78 dBm

Antenna	NR Modulation	NR Carrier Bandwidth	Band Edge (MHz)	
			Channel Position B	Channel Position T
A	QPSK	10.0 MHz 15 kHz SCS	1,935.0	1,990.0
A	QPSK	15.0 MHz 15 kHz SCS	1,937.5	1,987.5
A	QPSK	20.0 MHz 15 kHz SCS	1,940.0	1,985.0



Antenna A - NR Modulation QPSK - NR Carrier Bandwidth 10.0 MHz 15 kHz SCS - Channel Position B

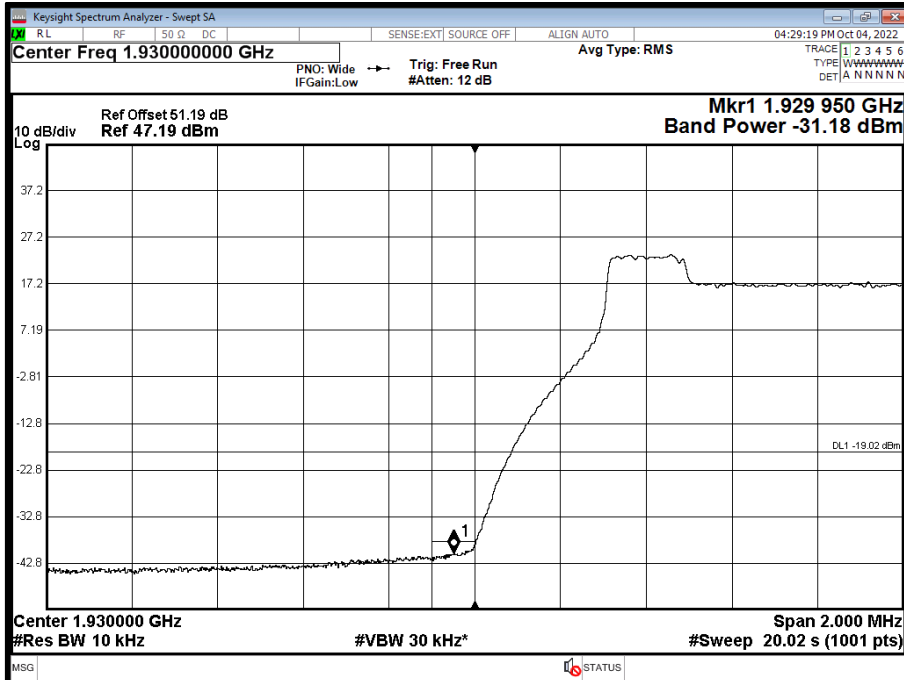

Antenna A - NR Modulation QPSK - NR Carrier Bandwidth 10.0 MHz 15 kHz SCS - Channel Position T

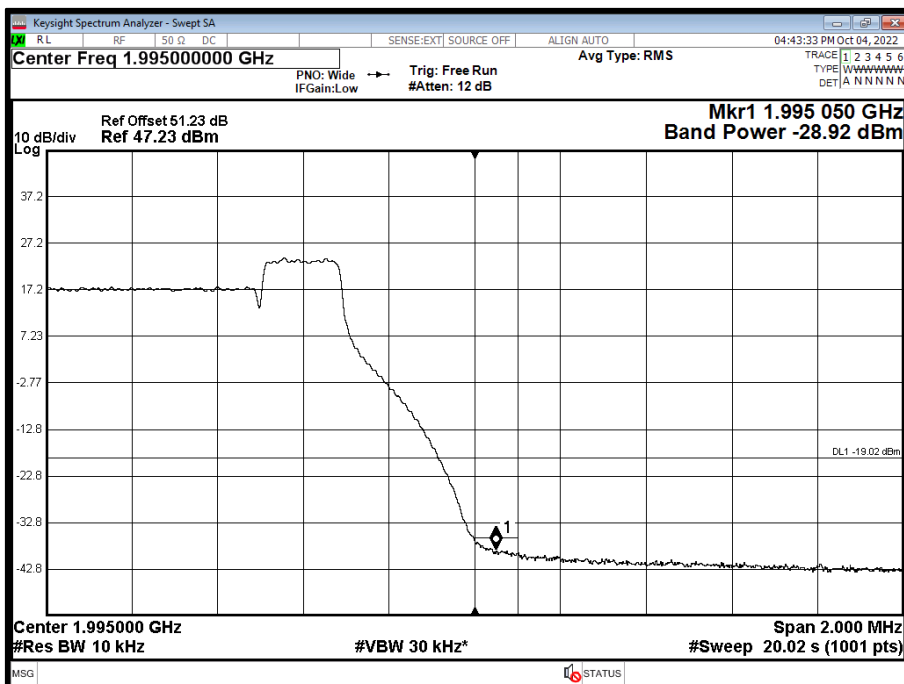



Antenna A - NR Modulation QPSK - NR Carrier Bandwidth 15.0 MHz 15 kHz SCS - Channel Position B

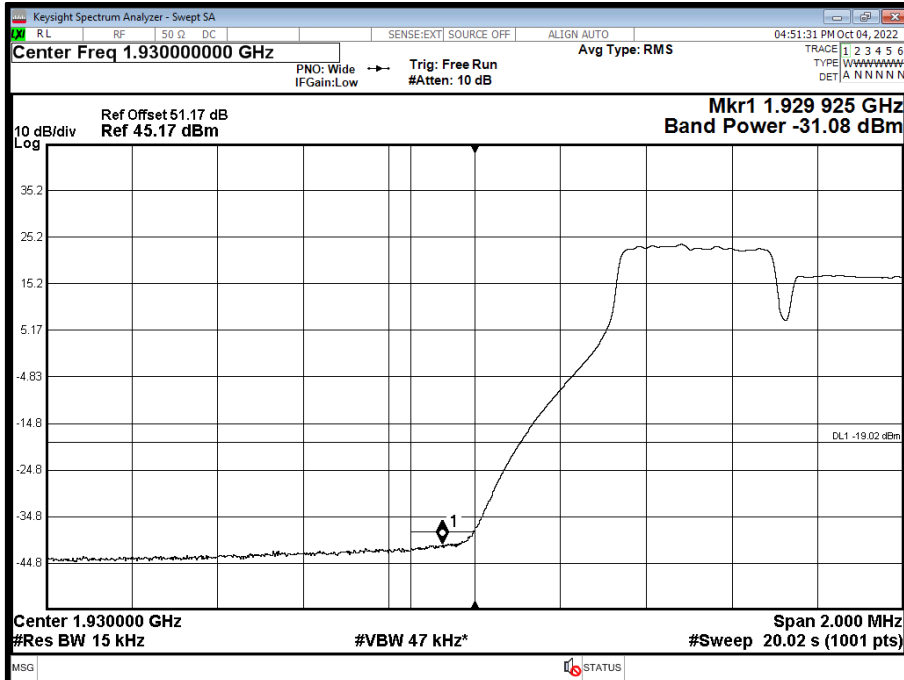

Antenna A - NR Modulation QPSK - NR Carrier Bandwidth 15.0 MHz 15 kHz SCS - Channel Position T

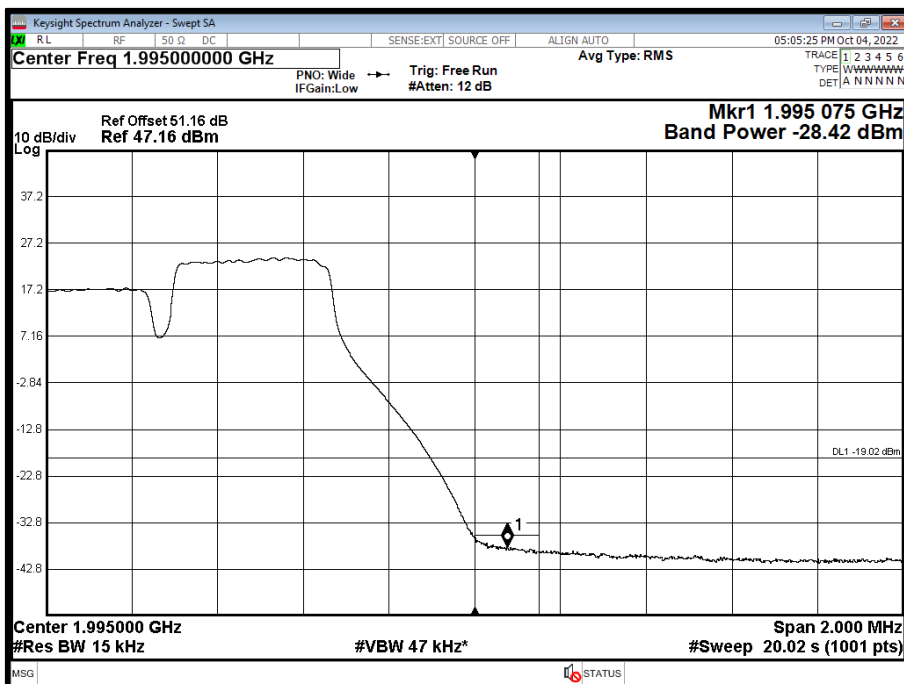



Antenna A - NR Modulation QPSK - NR Carrier Bandwidth 20.0 MHz 15 kHz SCS - Channel Position B

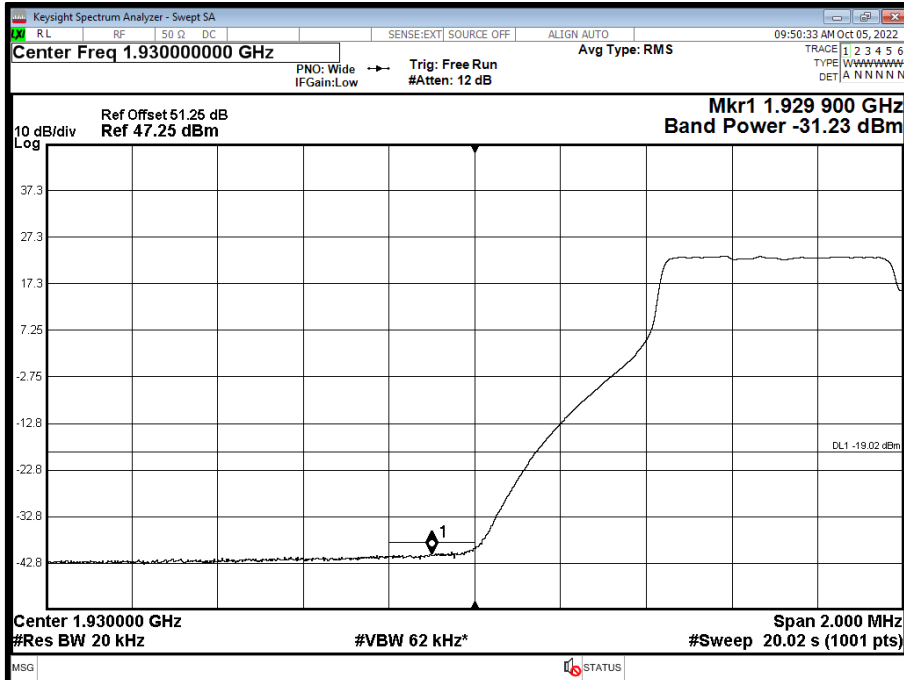

Antenna A - NR Modulation QPSK - NR Carrier Bandwidth 20.0 MHz 15 kHz SCS - Channel Position T

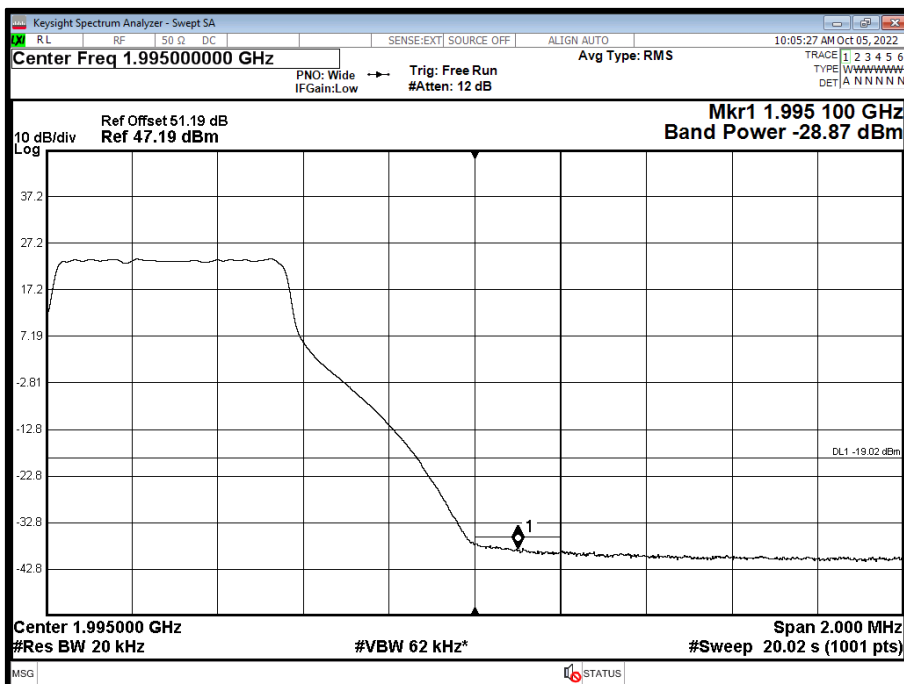



Configuration 2

Maximum Output Power 47.78 dBm

Antenna	NR Modulation	NR Carrier Bandwidth	Band Edge (MHz)	
			Channel Position B	Channel Position T
A	QPSK	10.0 MHz 15 kHz SCS	-	1,985.0
A	QPSK	15.0 MHz 15 kHz SCS	-	1,982.5
A	QPSK	20.0 MHz 15 kHz SCS	-	1,980.0

Antenna A - NR Modulation QPSK - NR Carrier Bandwidth 10.0 MHz 15 kHz SCS - Channel Position T

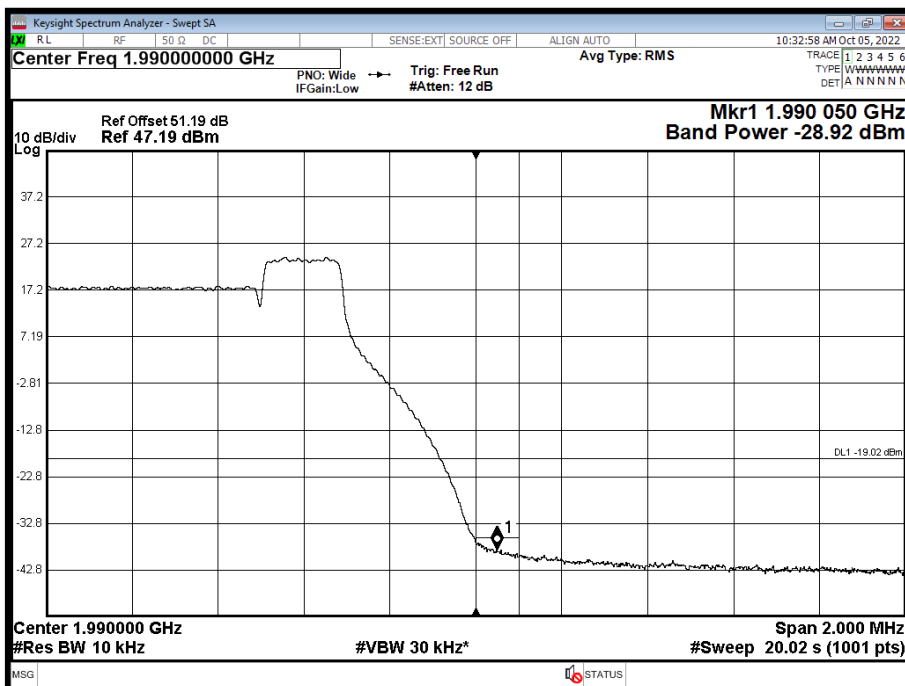



Antenna A - NR Modulation QPSK - NR Carrier Bandwidth 15.0 MHz 15 kHz SCS - Channel Position T

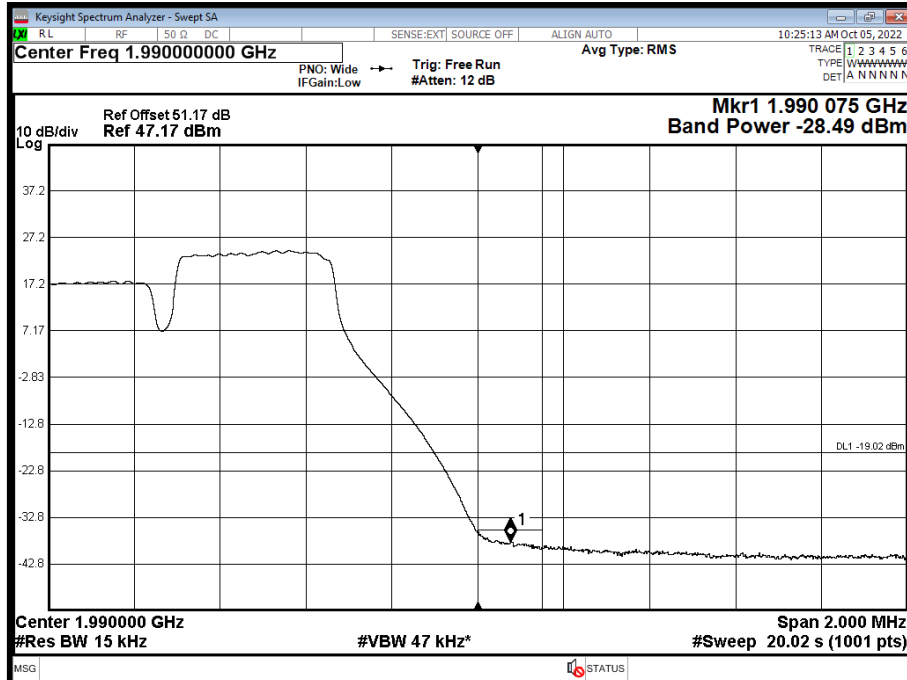

Antenna A - NR Modulation QPSK - NR Carrier Bandwidth 20.0 MHz 15 kHz SCS - Channel Position T

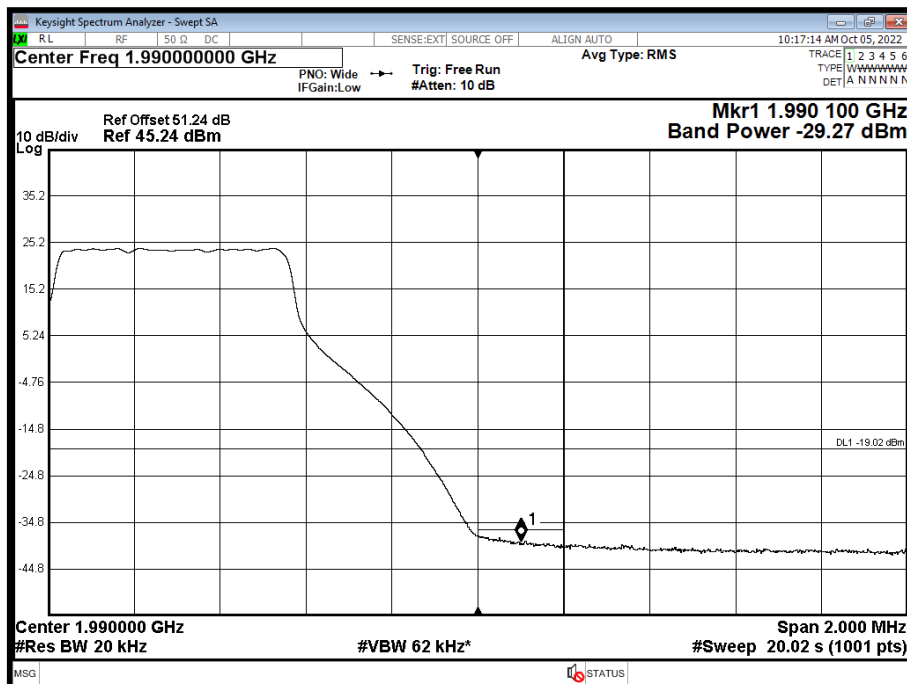

Limit	-19 dBm
-------	---------



## **2.4 TRANSMITTER SPURIOUS EMISSIONS**

### **2.4.1 Specification Reference**

FCC CFR 47 Part 24, Clause 24.238 (a)  
ISED RSS-GEN, Clause 6.13  
Industry Canada RSS-133, Clause 6.5  
FCC CFR 47 Part 2, Clause 2.1051

### **2.4.2 Date of Test and Modification State**

05-October-2022 - Modification State 0

### **2.4.3 Test Equipment Used**

The major items of test equipment used for the above tests are identified in Section 3.1.

### **2.4.4 Environmental Conditions**

Ambient Temperature	23.0°C
Relative Humidity	54.8%

### **2.4.5 Test Method**

All measurements were made in accordance with FCC KDB 971168 D01, Clause 6.1.

Each antenna port has been declared as being equivalent, therefore measurements were made on one antenna port only. To account for this, the limit was tightened by  $10 * \text{Log}(N)$ , where N is equal to the number of MIMO antenna ports.

For single port, the limit was calculated as being  $-13 \text{ dBm} - 10 * \text{Log}(4) = -19 \text{ dBm}$ .

### **2.4.6 Test Results**

Configuration 1

Maximum Output Power 47.78 dBm





Antenna A - NR Modulation QPSK - NR Carrier Bandwidth 10.0 MHz 15 kHz SCS - Channel Position B - Band 1 - Range 0.009 to 3500 MHz

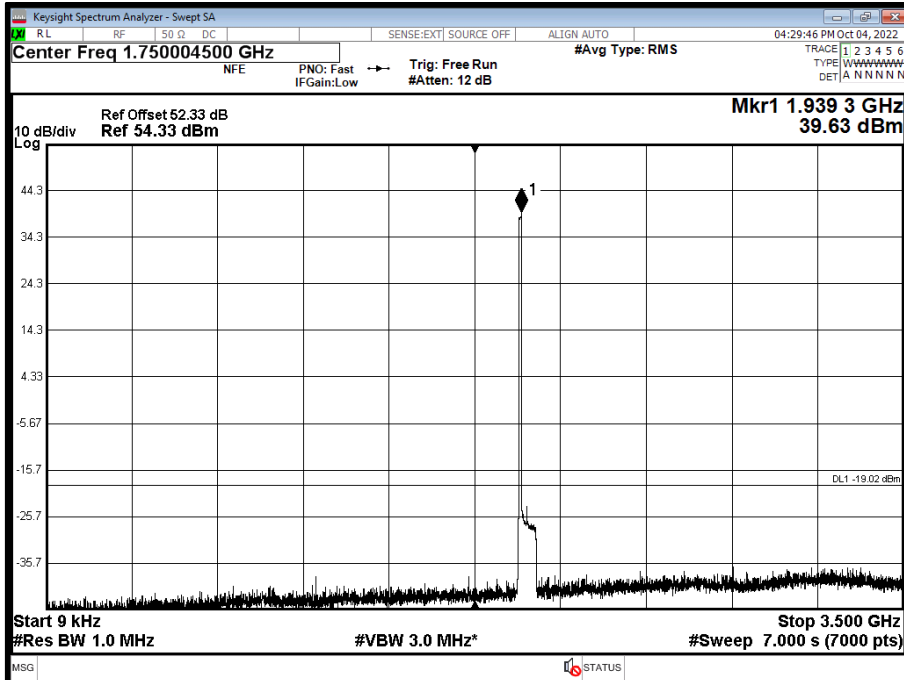

Antenna A - NR Modulation QPSK - NR Carrier Bandwidth 10.0 MHz 15 kHz SCS - Channel Position B - Band 2 - Range 3500 to 12000 MHz

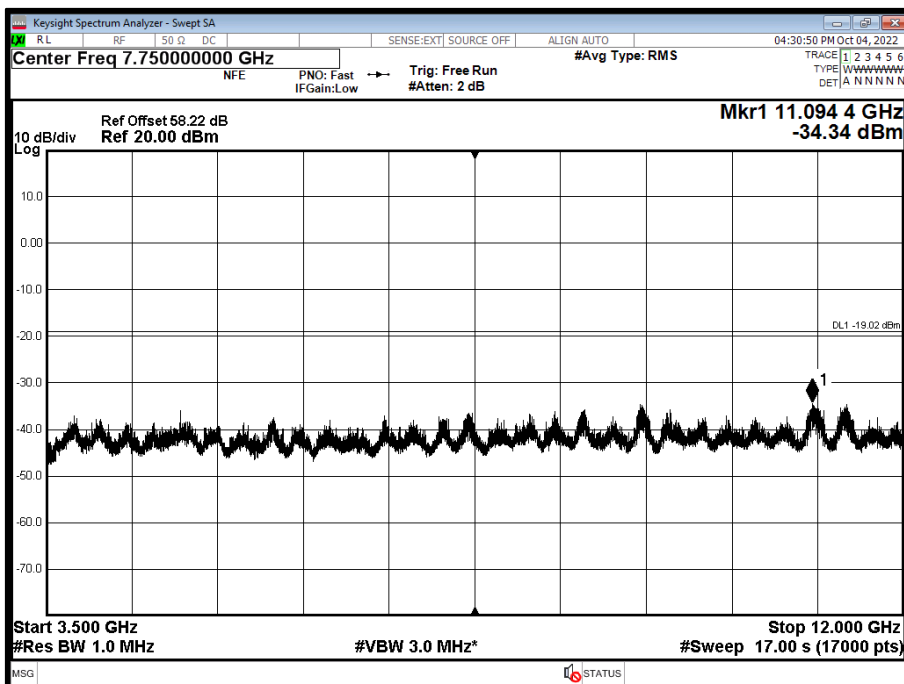



Antenna A - NR Modulation QPSK - NR Carrier Bandwidth 10.0 MHz 15 kHz SCS - Channel Position B - Band 3 - Range 12000 to 18000 MHz

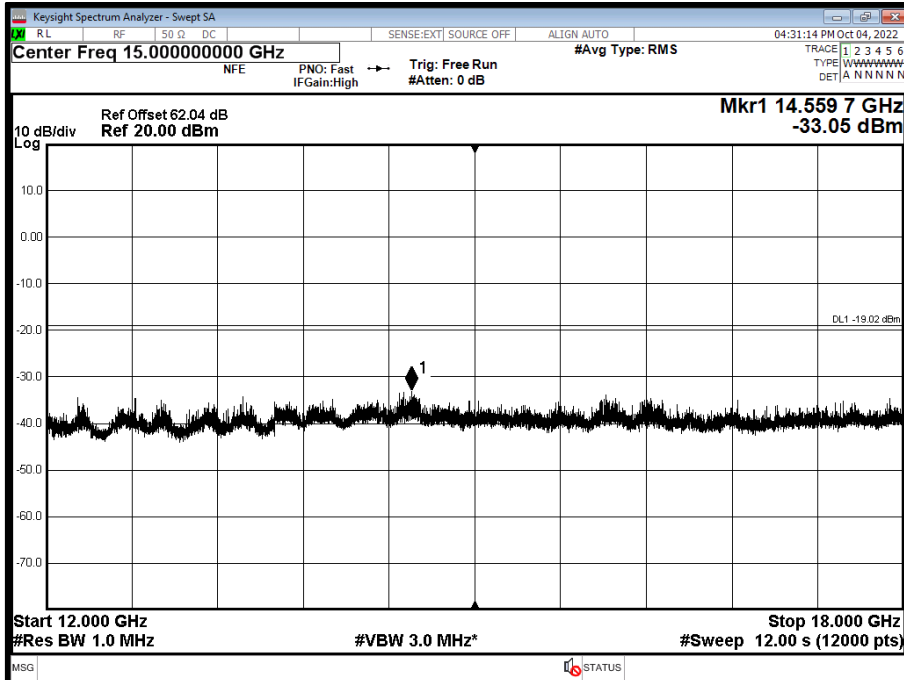

Antenna A - NR Modulation QPSK - NR Carrier Bandwidth 10.0 MHz 15 kHz SCS - Channel Position B - Band 4 - Range 18000 to 20000 MHz

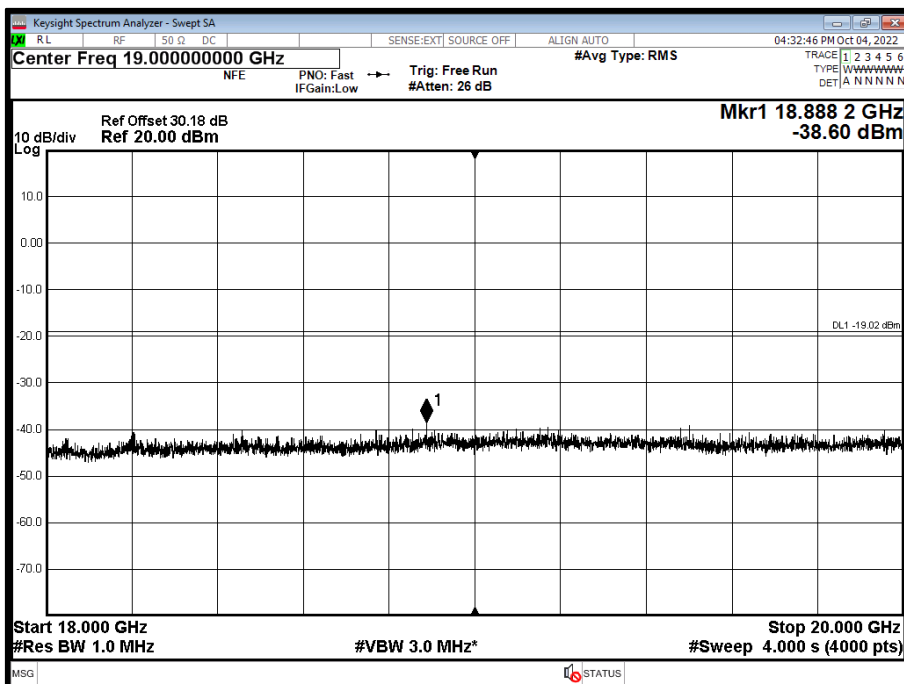



Antenna A - NR Modulation QPSK - NR Carrier Bandwidth 10.0 MHz 15 kHz SCS - Channel Position M - Band 1 - Range 0.009 to 3500 MHz

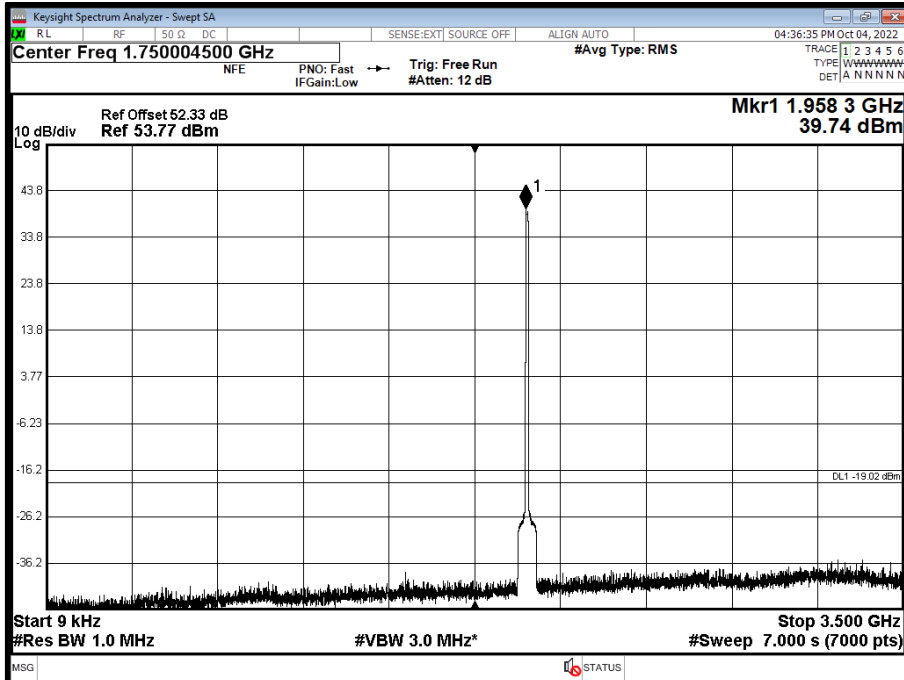

Antenna A - NR Modulation QPSK - NR Carrier Bandwidth 10.0 MHz 15 kHz SCS - Channel Position M - Band 2 - Range 3500 to 12000 MHz

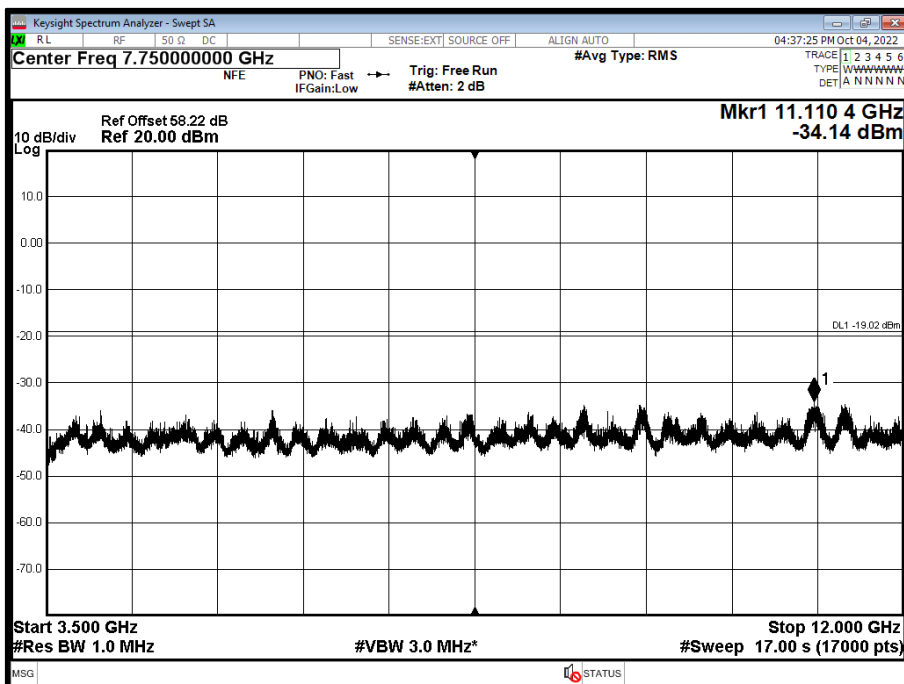



Antenna A - NR Modulation QPSK - NR Carrier Bandwidth 10.0 MHz 15 kHz SCS - Channel Position M - Band 3 - Range 12000 to 18000 MHz

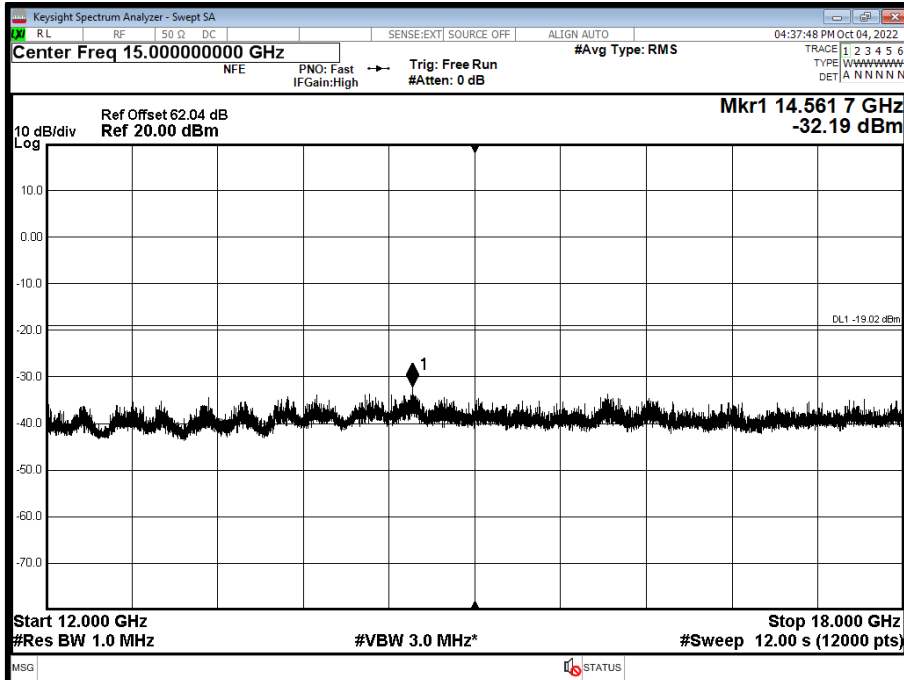

Antenna A - NR Modulation QPSK - NR Carrier Bandwidth 10.0 MHz 15 kHz SCS - Channel Position M - Band 4 - Range 18000 to 20000 MHz

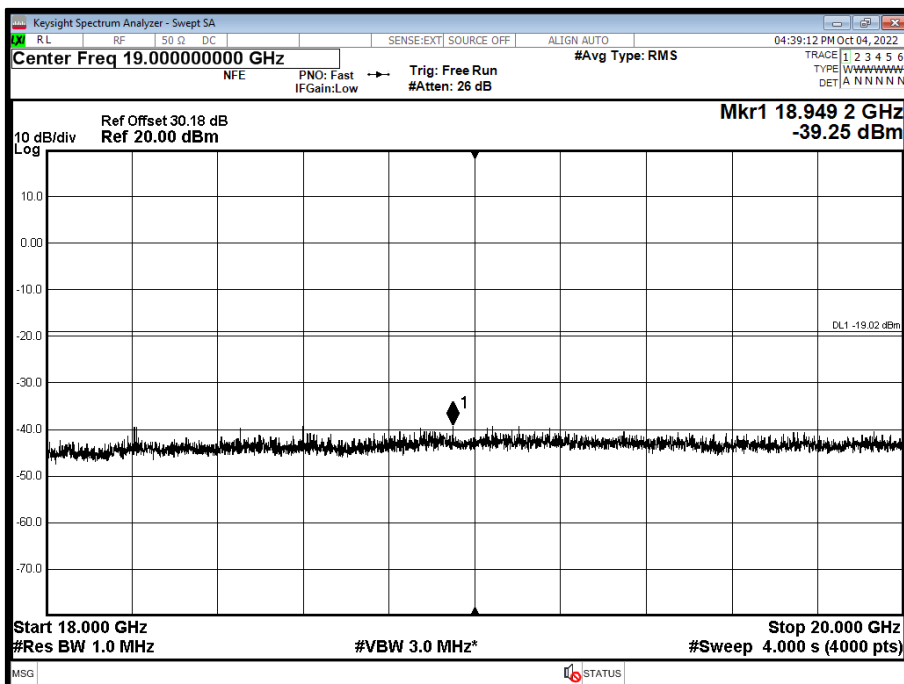



Antenna A - NR Modulation QPSK - NR Carrier Bandwidth 10.0 MHz 15 kHz SCS - Channel Position T - Band 1 - Range 0.009 to 3500 MHz

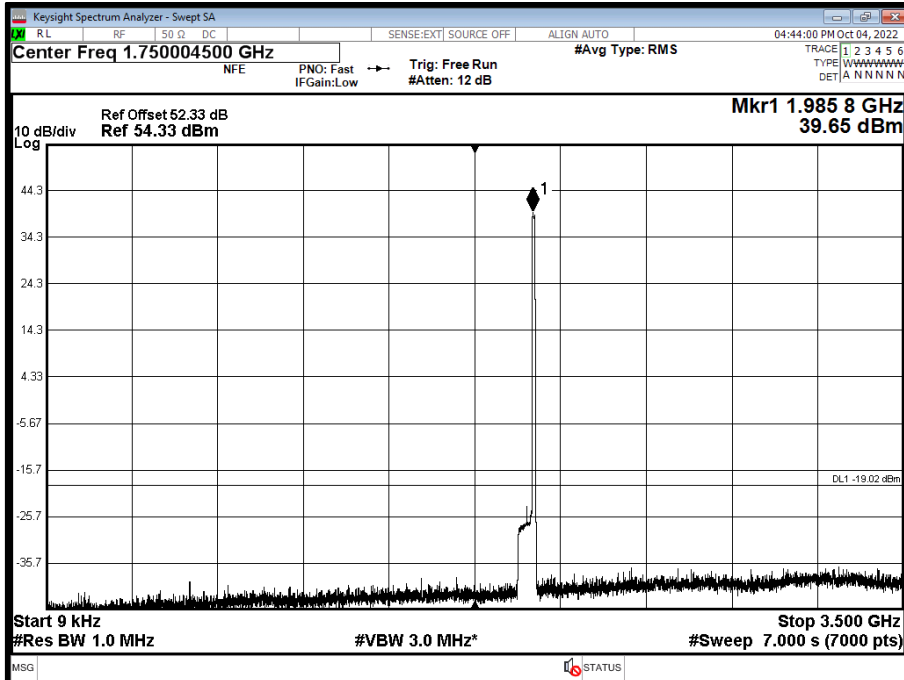

Antenna A - NR Modulation QPSK - NR Carrier Bandwidth 10.0 MHz 15 kHz SCS - Channel Position T - Band 2 - Range 3500 to 12000 MHz

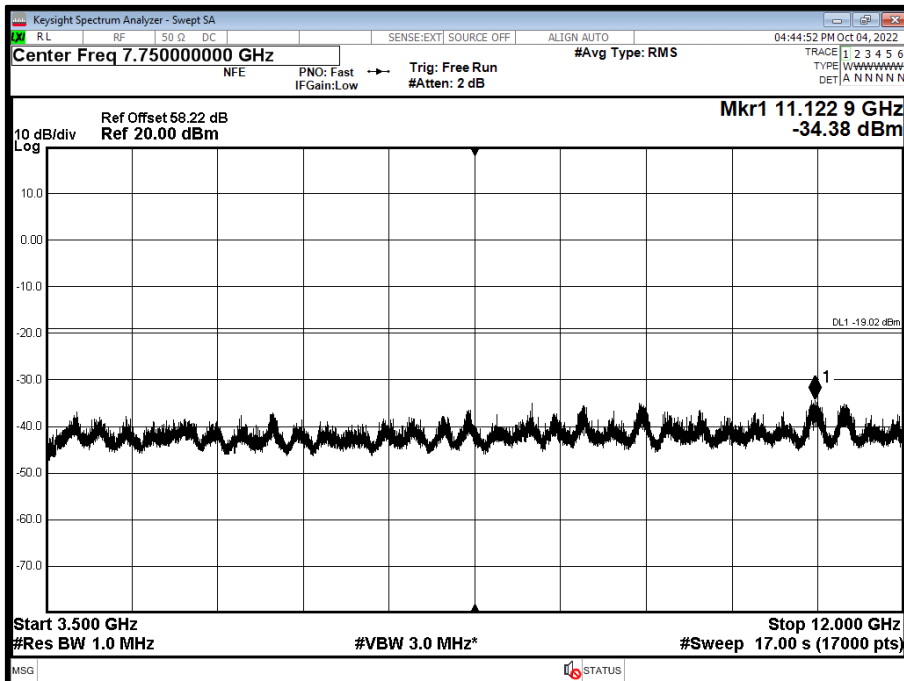



Antenna A - NR Modulation QPSK - NR Carrier Bandwidth 10.0 MHz 15 kHz SCS - Channel Position T - Band 3 - Range 12000 to 18000 MHz

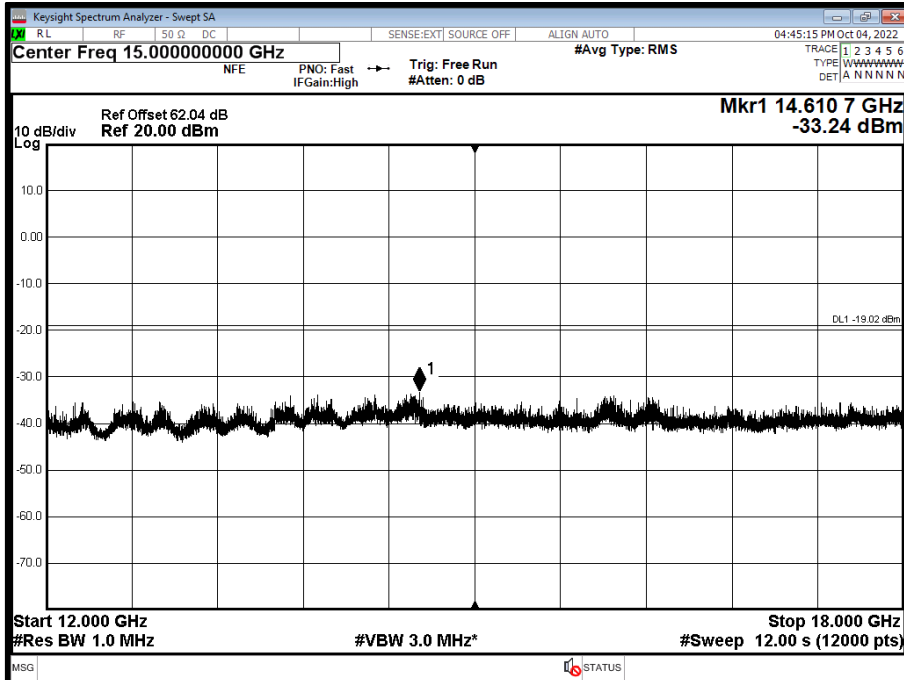

Antenna A - NR Modulation QPSK - NR Carrier Bandwidth 10.0 MHz 15 kHz SCS - Channel Position T - Band 4 - Range 18000 to 20000 MHz

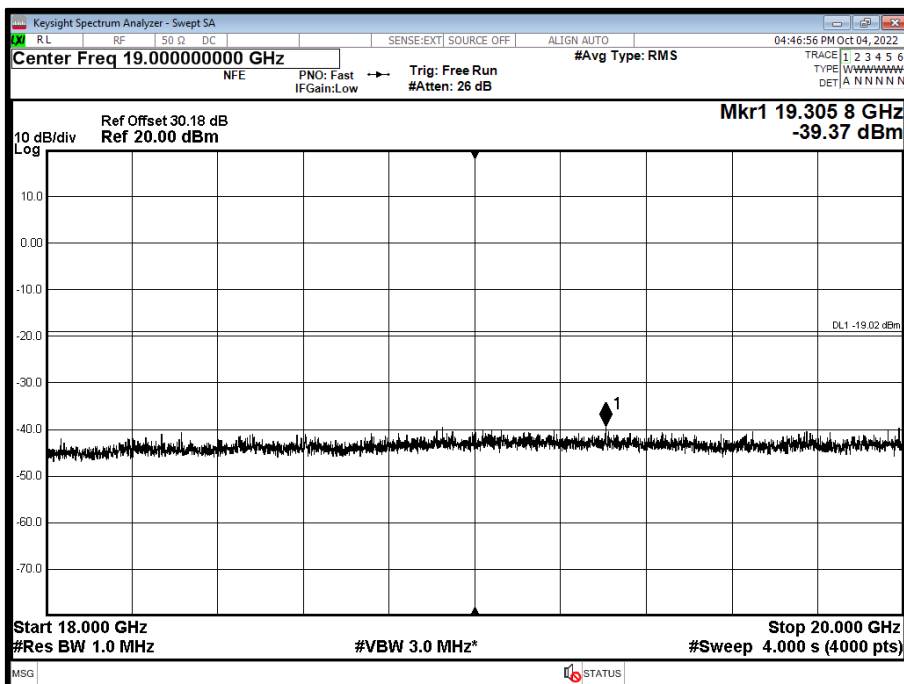



Antenna A - NR Modulation QPSK - NR Carrier Bandwidth 15.0 MHz 15 kHz SCS - Channel Position B - Band 1 - Range 0.009 to 3500 MHz

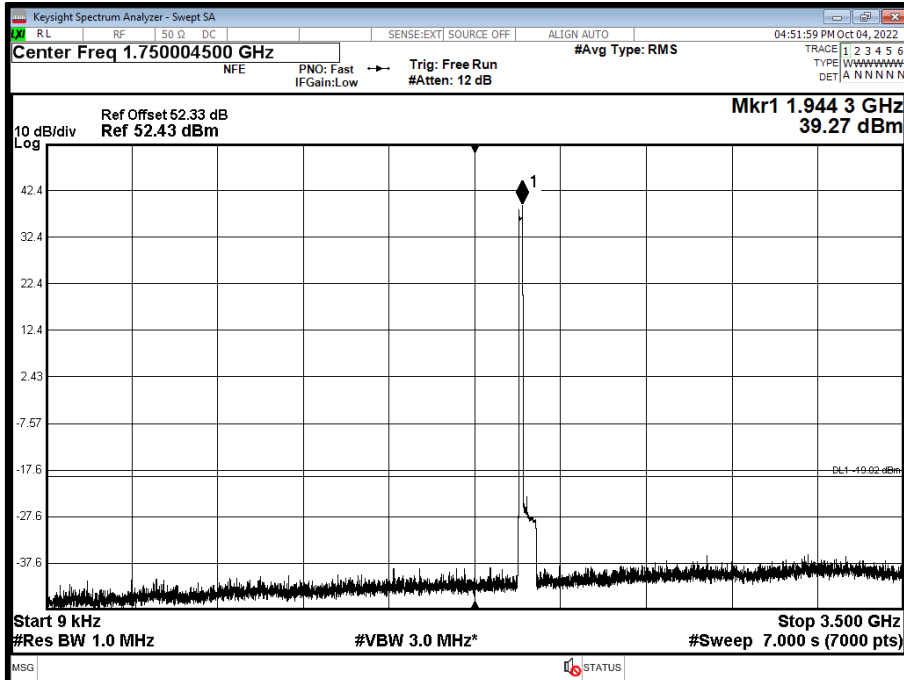

Antenna A - NR Modulation QPSK - NR Carrier Bandwidth 15.0 MHz 15 kHz SCS - Channel Position B - Band 2 - Range 3500 to 12000 MHz

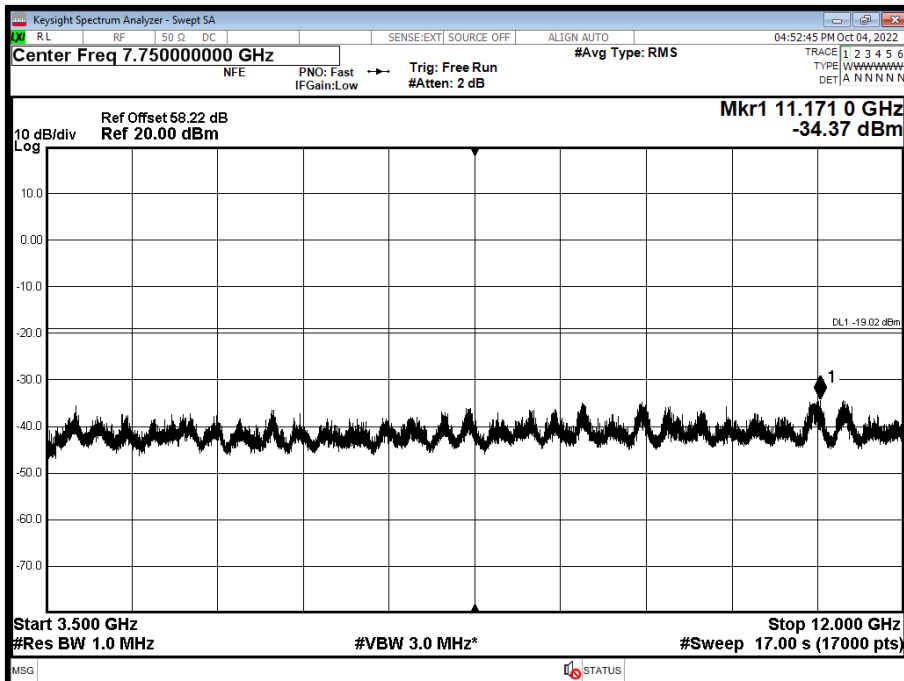



Antenna A - NR Modulation QPSK - NR Carrier Bandwidth 15.0 MHz 15 kHz SCS - Channel Position B - Band 3 - Range 12000 to 18000 MHz

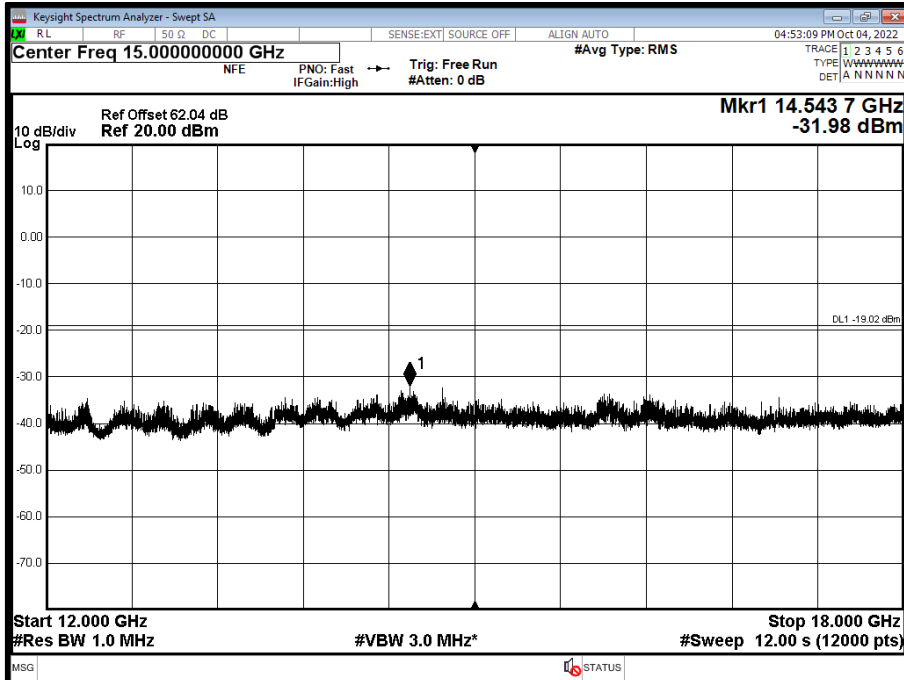

Antenna A - NR Modulation QPSK - NR Carrier Bandwidth 15.0 MHz 15 kHz SCS - Channel Position B - Band 4 - Range 18000 to 20000 MHz

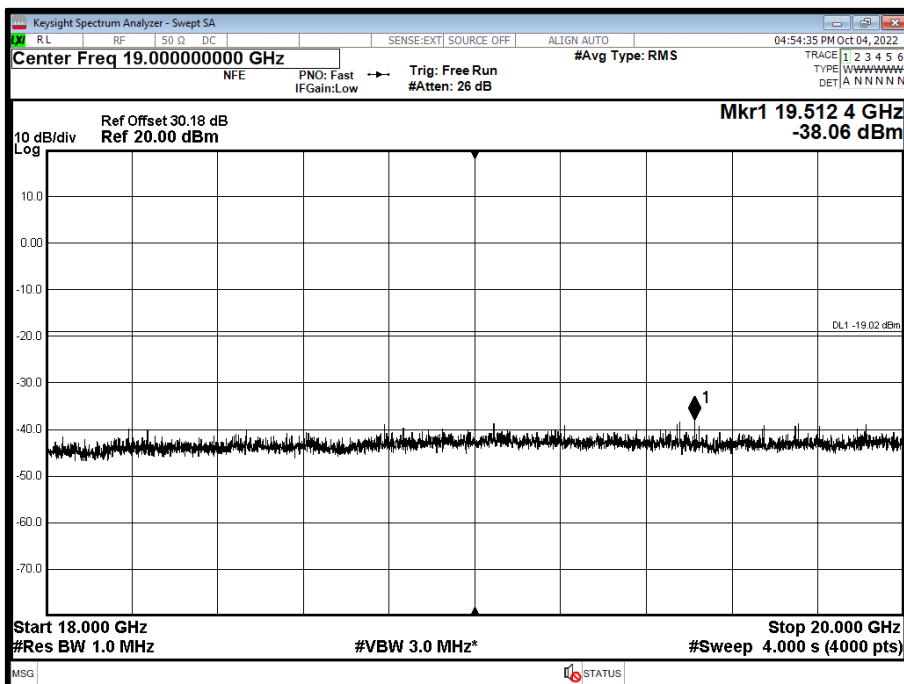





Antenna A - NR Modulation QPSK - NR Carrier Bandwidth 15.0 MHz 15 kHz SCS - Channel Position M - Band 1 - Range 0.009 to 3500 MHz

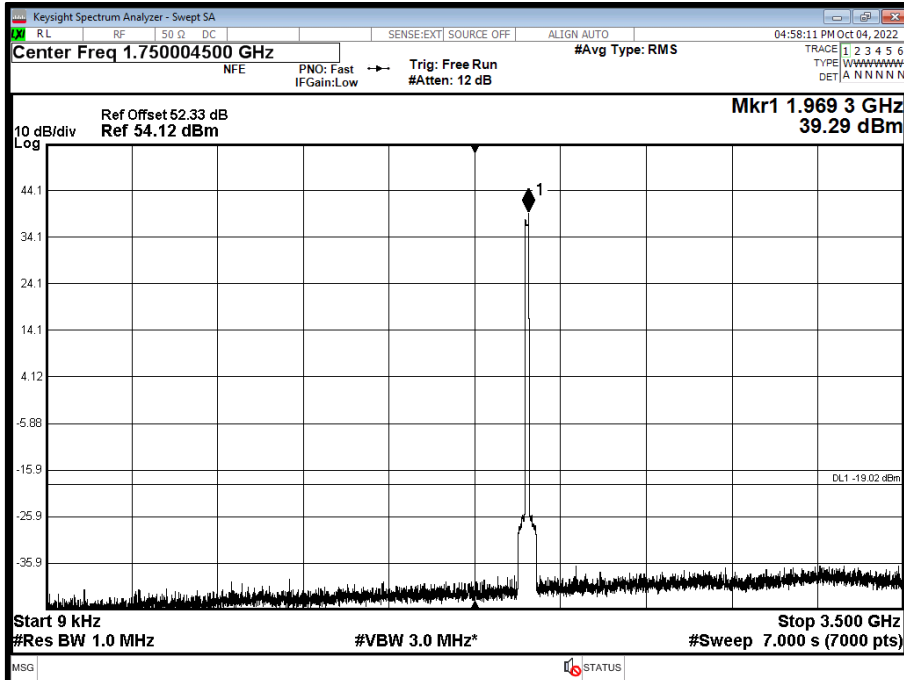

Antenna A - NR Modulation QPSK - NR Carrier Bandwidth 15.0 MHz 15 kHz SCS - Channel Position M - Band 2 - Range 3500 to 12000 MHz

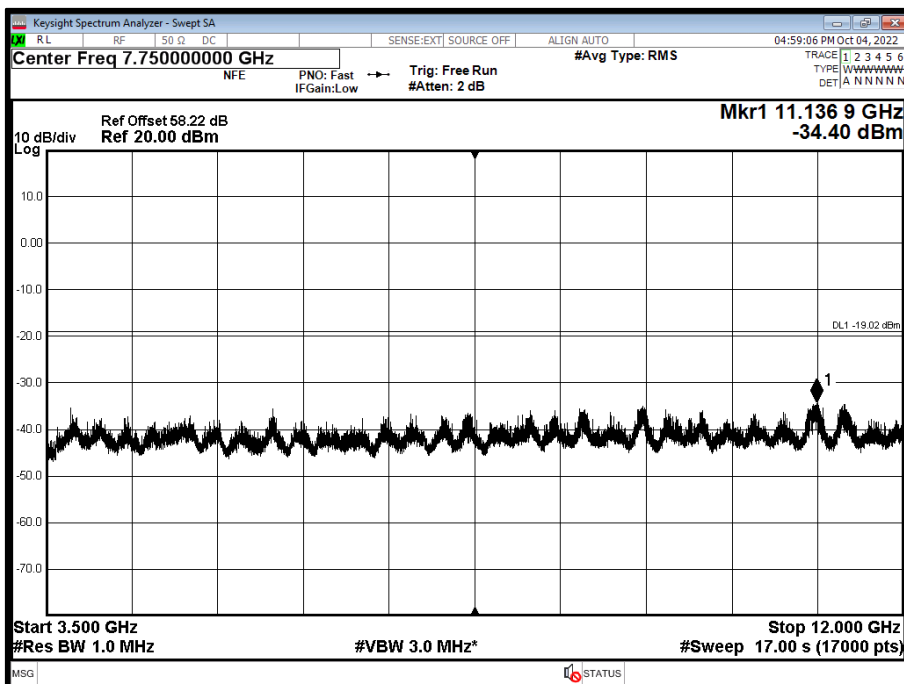



Antenna A - NR Modulation QPSK - NR Carrier Bandwidth 15.0 MHz 15 kHz SCS - Channel Position M - Band 3 - Range 12000 to 18000 MHz

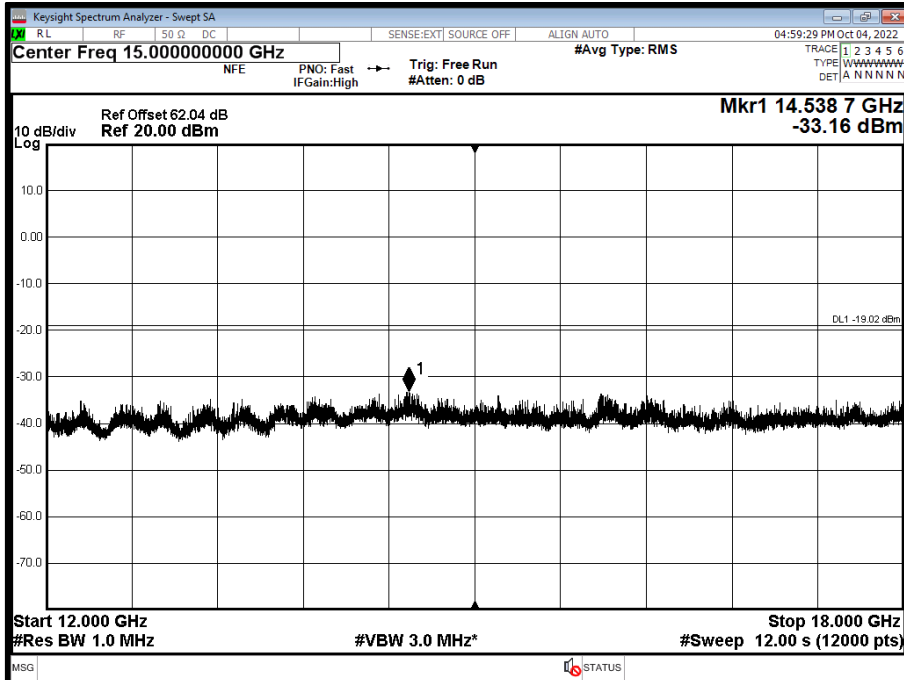

Antenna A - NR Modulation QPSK - NR Carrier Bandwidth 15.0 MHz 15 kHz SCS - Channel Position M - Band 4 - Range 18000 to 20000 MHz

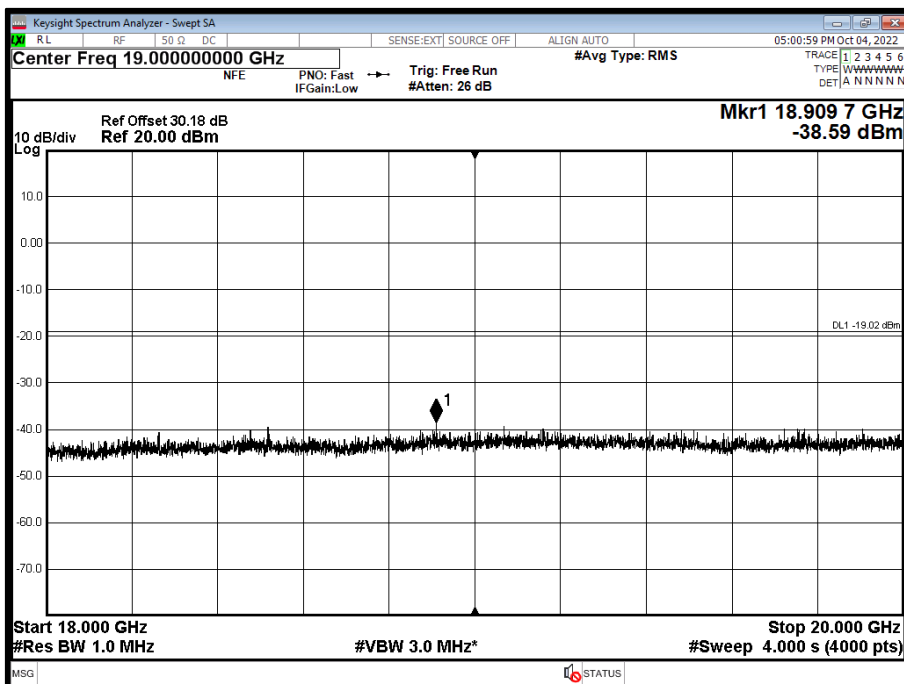



Antenna A - NR Modulation QPSK - NR Carrier Bandwidth 15.0 MHz 15 kHz SCS - Channel Position T - Band 1 - Range 0.009 to 3500 MHz

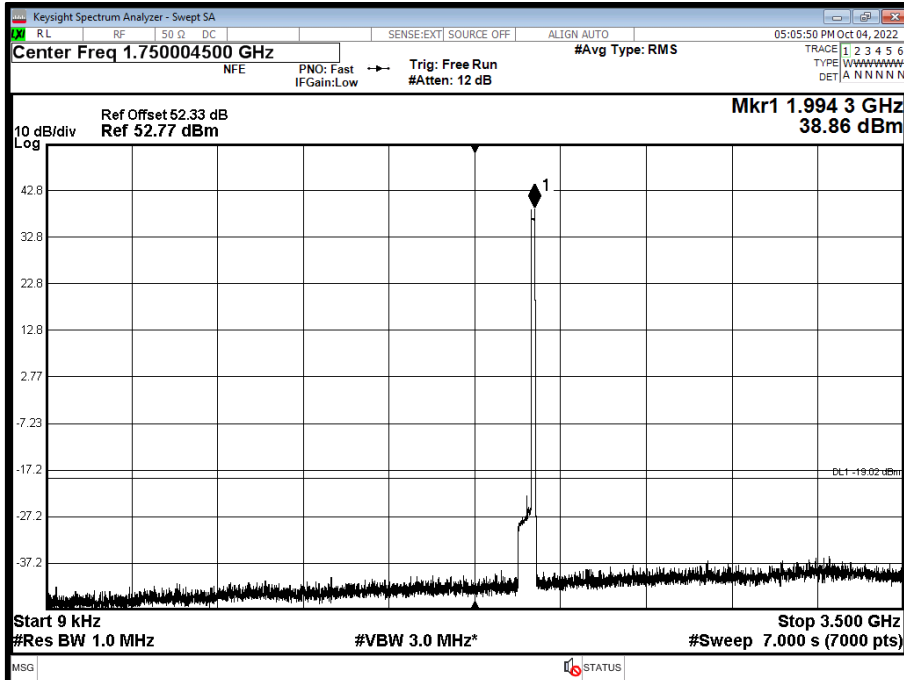

Antenna A - NR Modulation QPSK - NR Carrier Bandwidth 15.0 MHz 15 kHz SCS - Channel Position T - Band 2 - Range 3500 to 12000 MHz

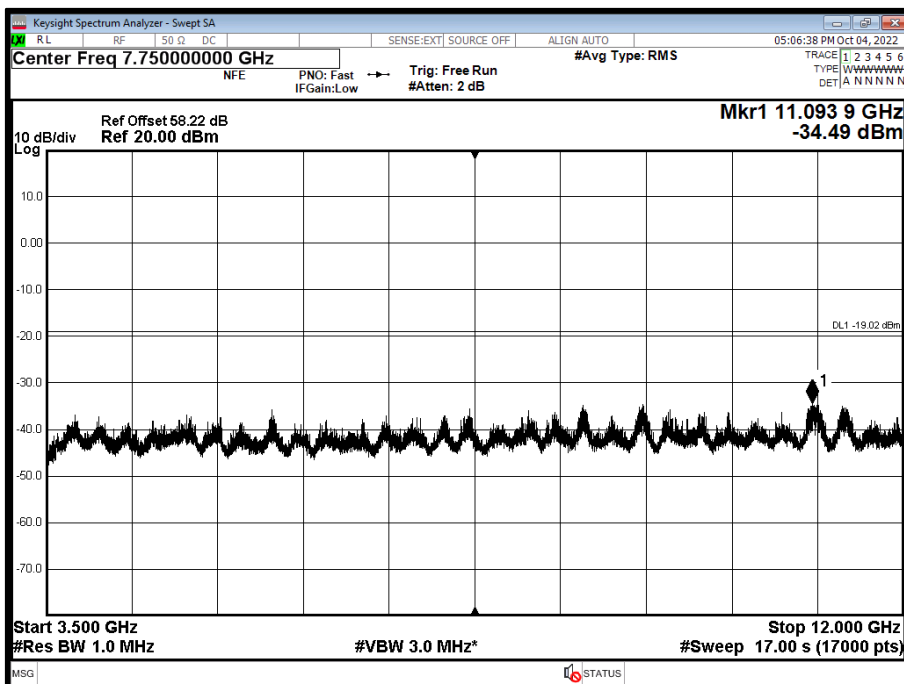



Antenna A - NR Modulation QPSK - NR Carrier Bandwidth 15.0 MHz 15 kHz SCS - Channel Position T - Band 3 - Range 12000 to 18000 MHz

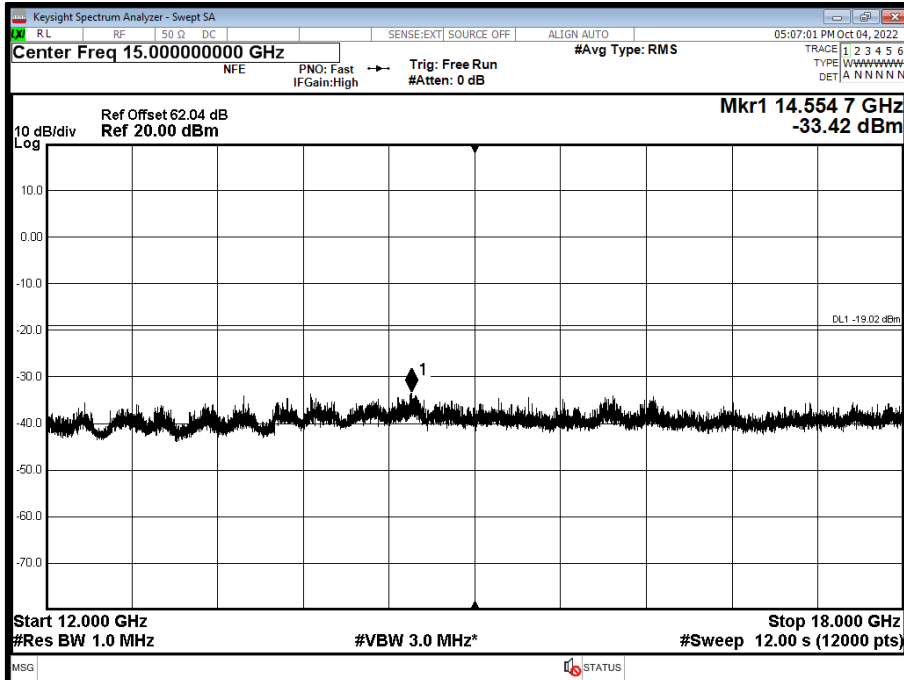

Antenna A - NR Modulation QPSK - NR Carrier Bandwidth 15.0 MHz 15 kHz SCS - Channel Position T - Band 4 - Range 18000 to 20000 MHz

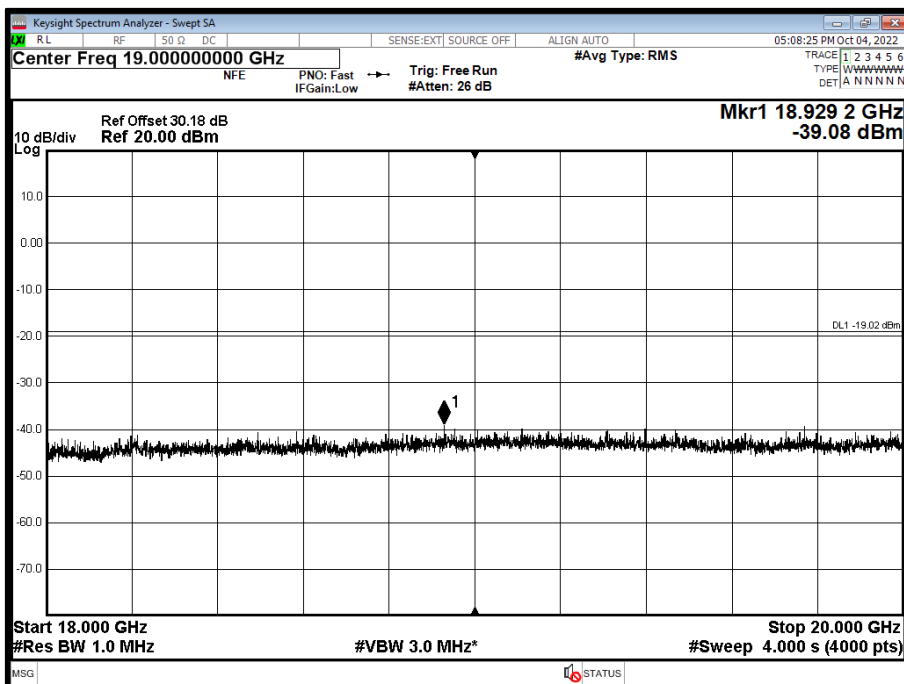



Antenna A - NR Modulation QPSK - NR Carrier Bandwidth 20.0 MHz 15 kHz SCS - Channel Position B - Band 1 - Range 0.009 to 3500 MHz

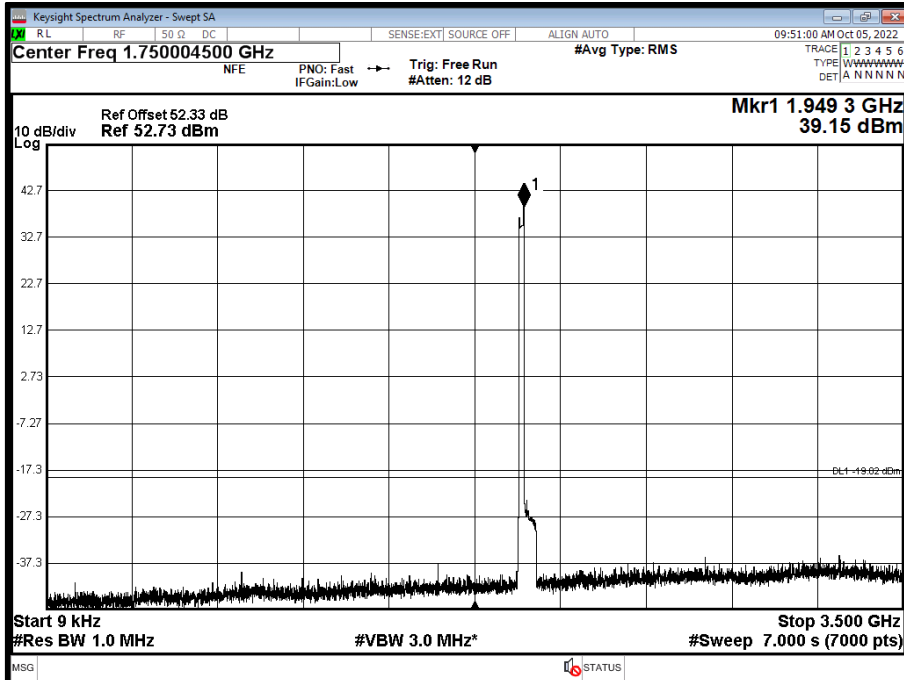

Antenna A - NR Modulation QPSK - NR Carrier Bandwidth 20.0 MHz 15 kHz SCS - Channel Position B - Band 2 - Range 3500 to 12000 MHz

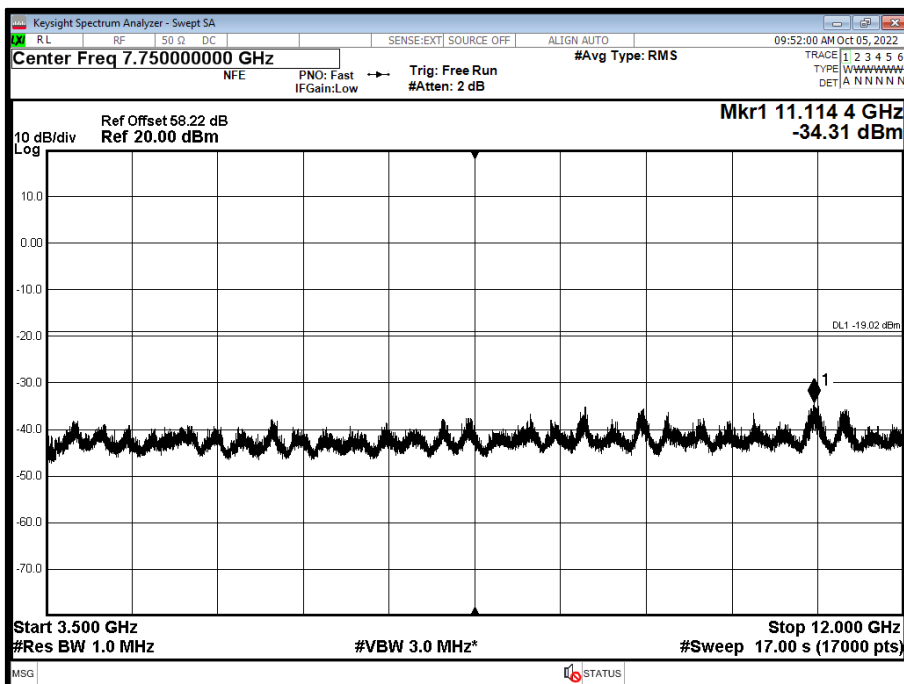



Antenna A - NR Modulation QPSK - NR Carrier Bandwidth 20.0 MHz 15 kHz SCS - Channel Position B - Band 3 - Range 12000 to 18000 MHz

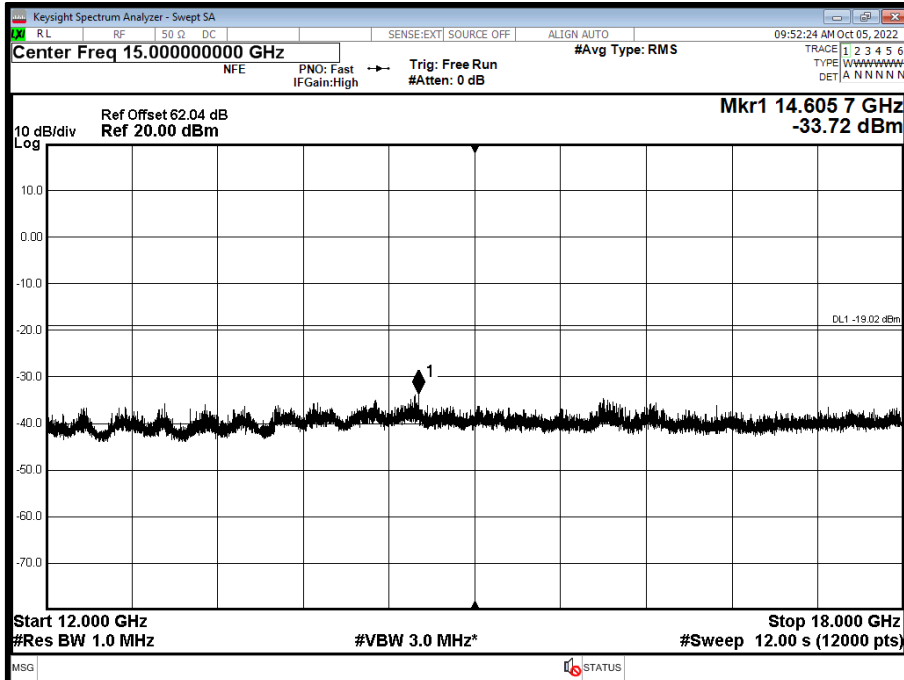

Antenna A - NR Modulation QPSK - NR Carrier Bandwidth 20.0 MHz 15 kHz SCS - Channel Position B - Band 4 - Range 18000 to 20000 MHz

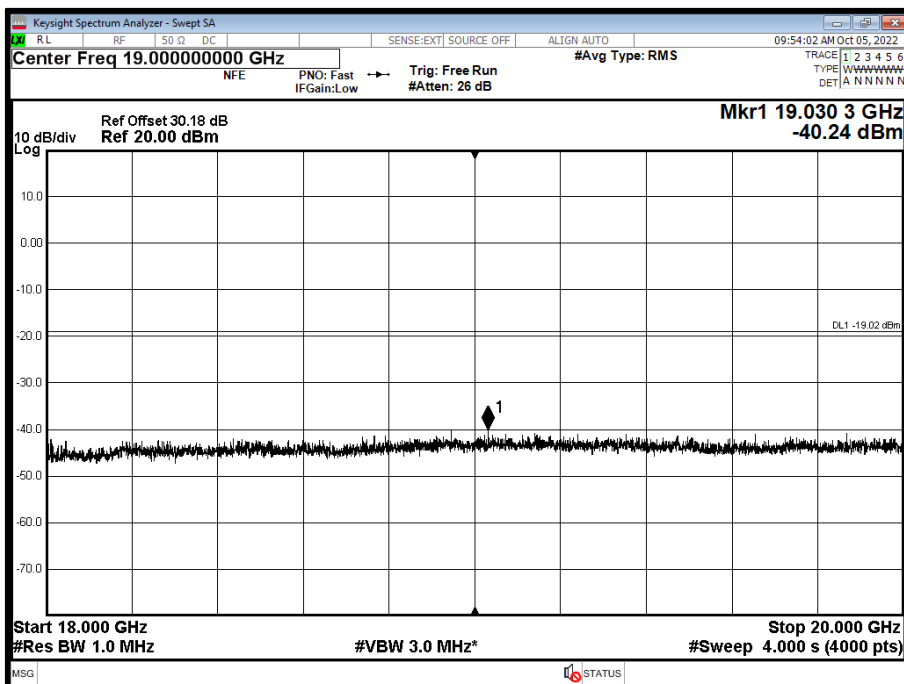



Antenna A - NR Modulation QPSK - NR Carrier Bandwidth 20.0 MHz 15 kHz SCS - Channel Position M - Band 1 - Range 0.009 to 3500 MHz

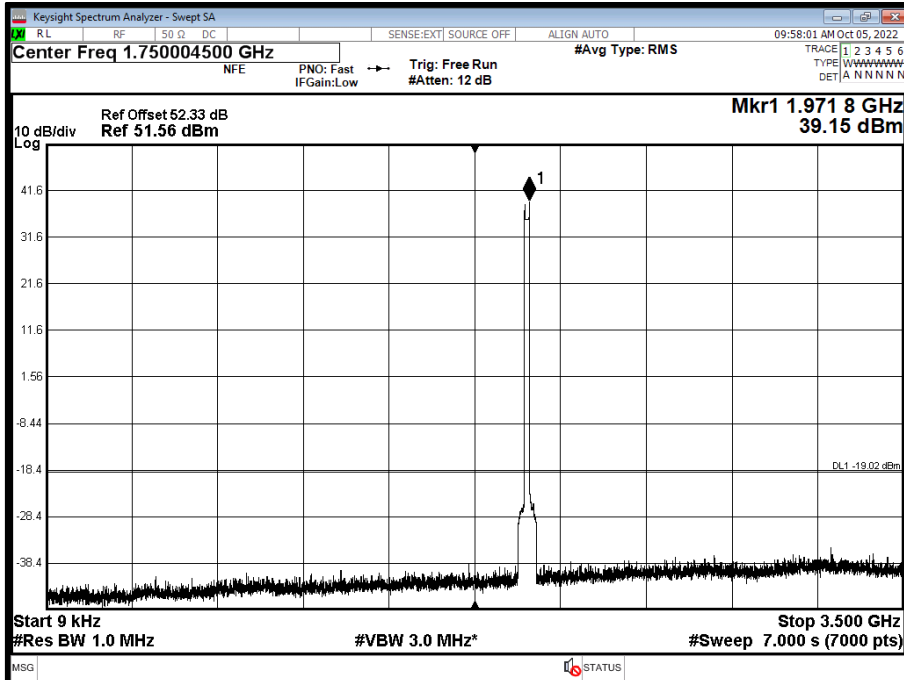

Antenna A - NR Modulation QPSK - NR Carrier Bandwidth 20.0 MHz 15 kHz SCS - Channel Position M - Band 2 - Range 3500 to 12000 MHz

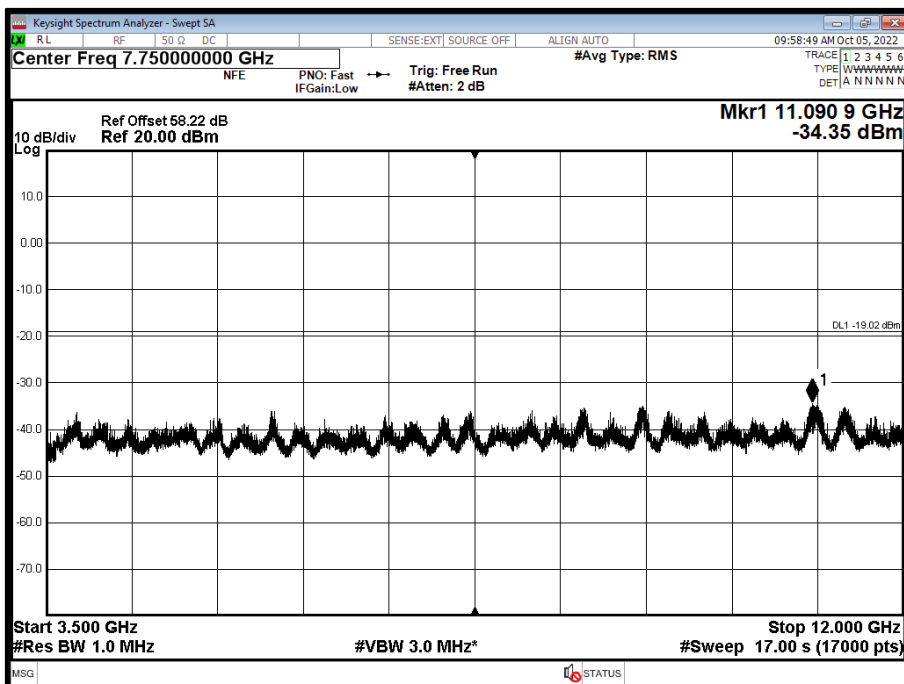



Antenna A - NR Modulation QPSK - NR Carrier Bandwidth 20.0 MHz 15 kHz SCS - Channel Position M - Band 3 - Range 12000 to 18000 MHz

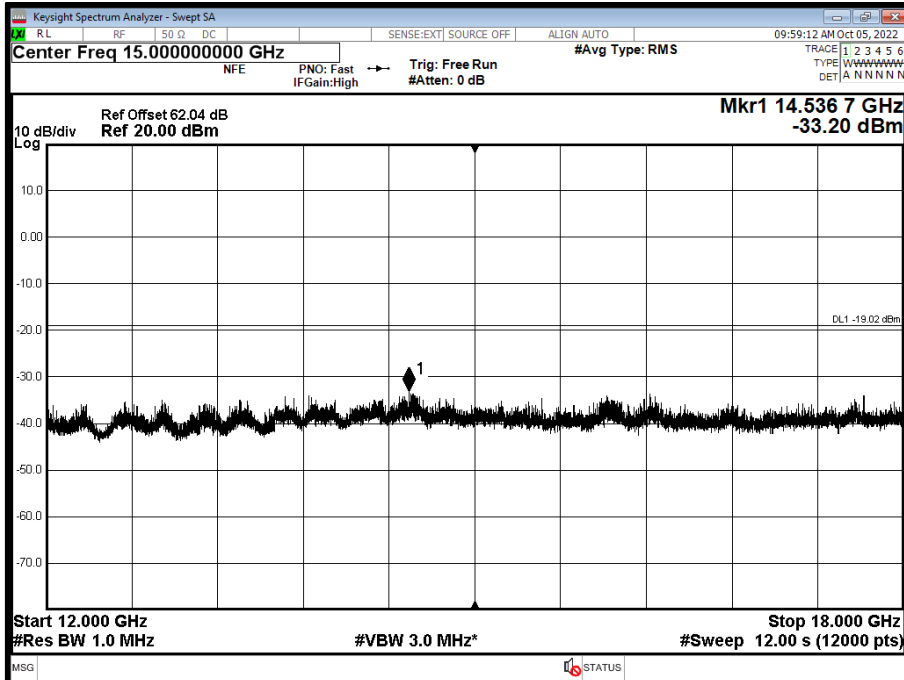

Antenna A - NR Modulation QPSK - NR Carrier Bandwidth 20.0 MHz 15 kHz SCS - Channel Position M - Band 4 - Range 18000 to 20000 MHz

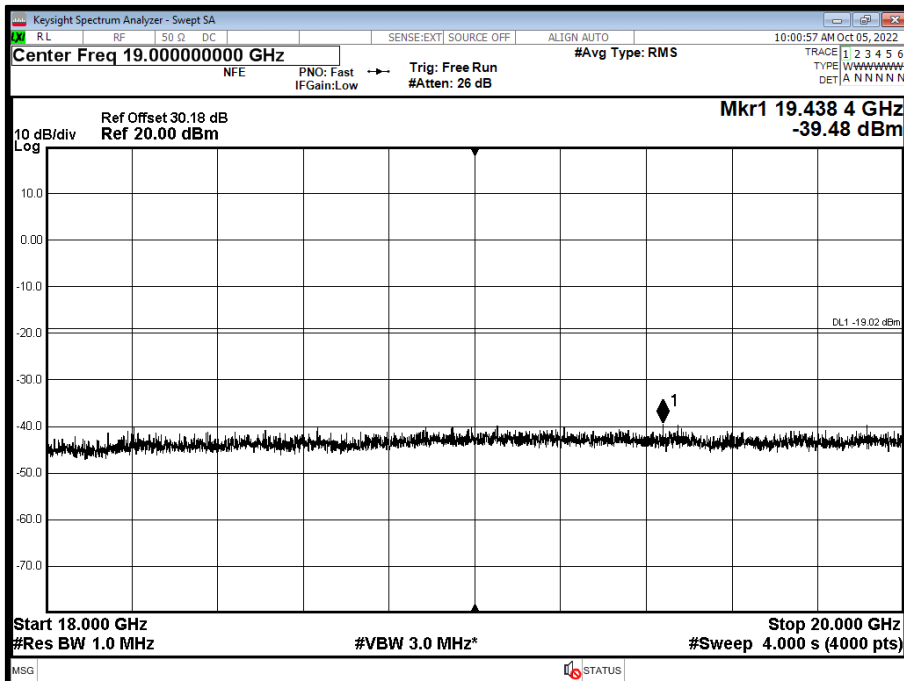





Antenna A - NR Modulation QPSK - NR Carrier Bandwidth 20.0 MHz 15 kHz SCS - Channel Position T - Band 1 - Range 0.009 to 3500 MHz

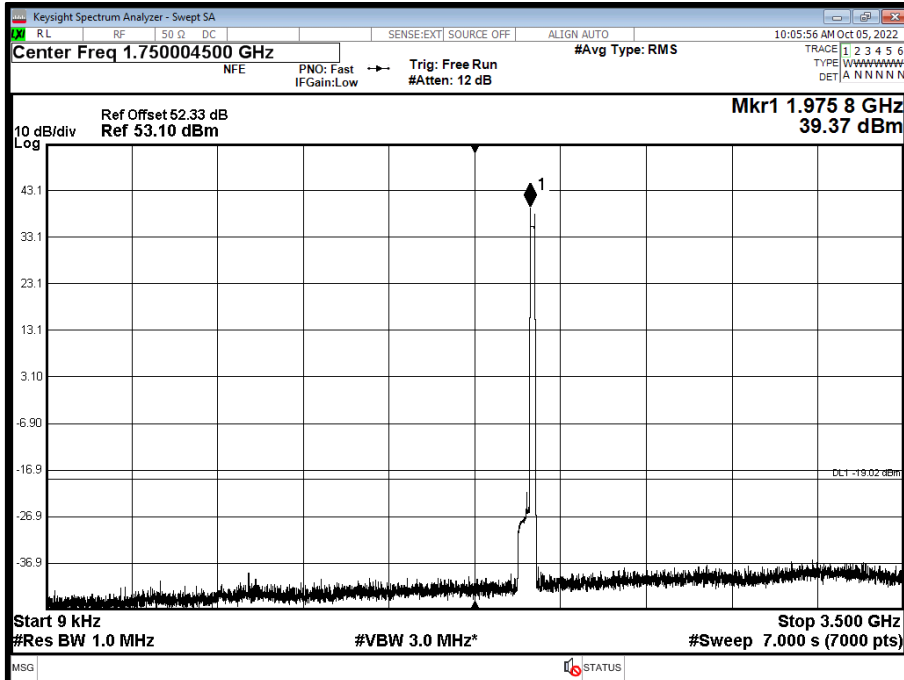

Antenna A - NR Modulation QPSK - NR Carrier Bandwidth 20.0 MHz 15 kHz SCS - Channel Position T - Band 2 - Range 3500 to 12000 MHz

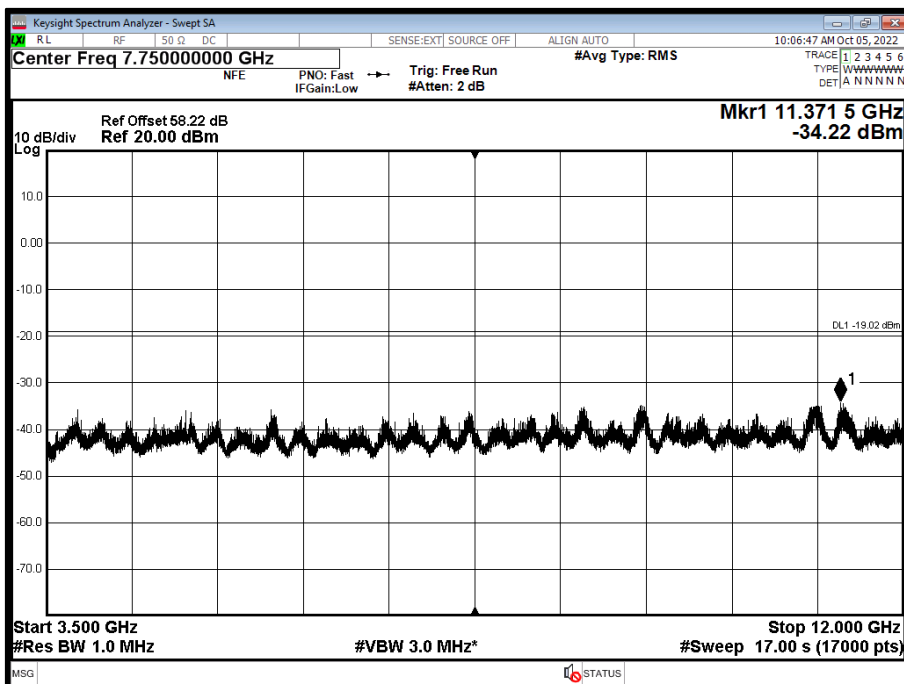



Antenna A - NR Modulation QPSK - NR Carrier Bandwidth 20.0 MHz 15 kHz SCS - Channel Position T - Band 3 - Range 12000 to 18000 MHz

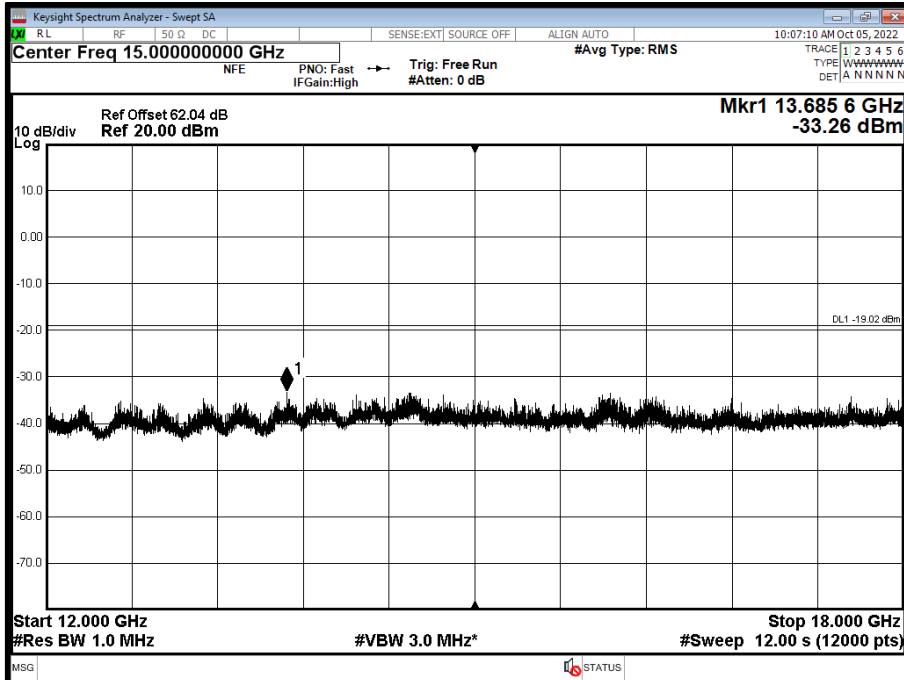

Antenna A - NR Modulation QPSK - NR Carrier Bandwidth 20.0 MHz 15 kHz SCS - Channel Position T - Band 4 - Range 18000 to 20000 MHz

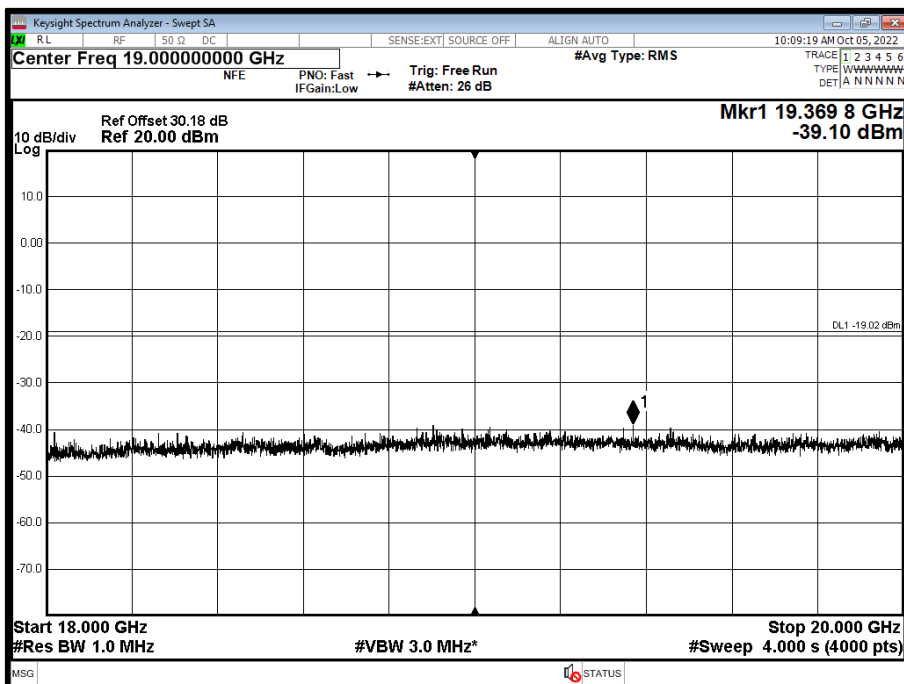



Configuration 2

Maximum Output Power 47.78 dBm

Antenna A - NR Modulation QPSK - NR Carrier Bandwidth 10.0 MHz 15 kHz SCS - Channel Position T - Band 1 - Range 0.009 to 3500 MHz

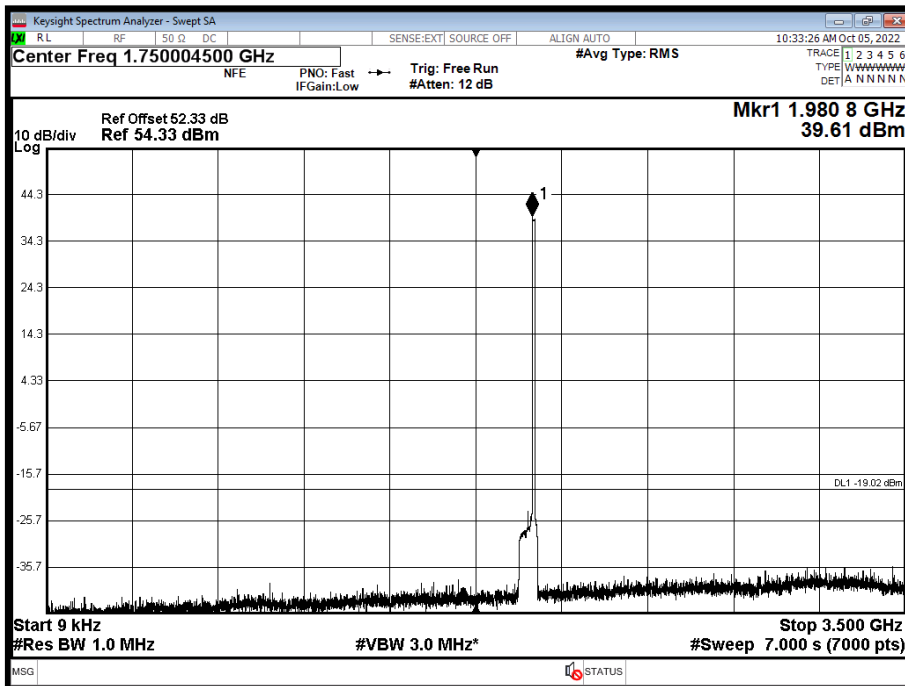

Antenna A - NR Modulation QPSK - NR Carrier Bandwidth 10.0 MHz 15 kHz SCS - Channel Position T - Band 2 - Range 3500 to 12000 MHz

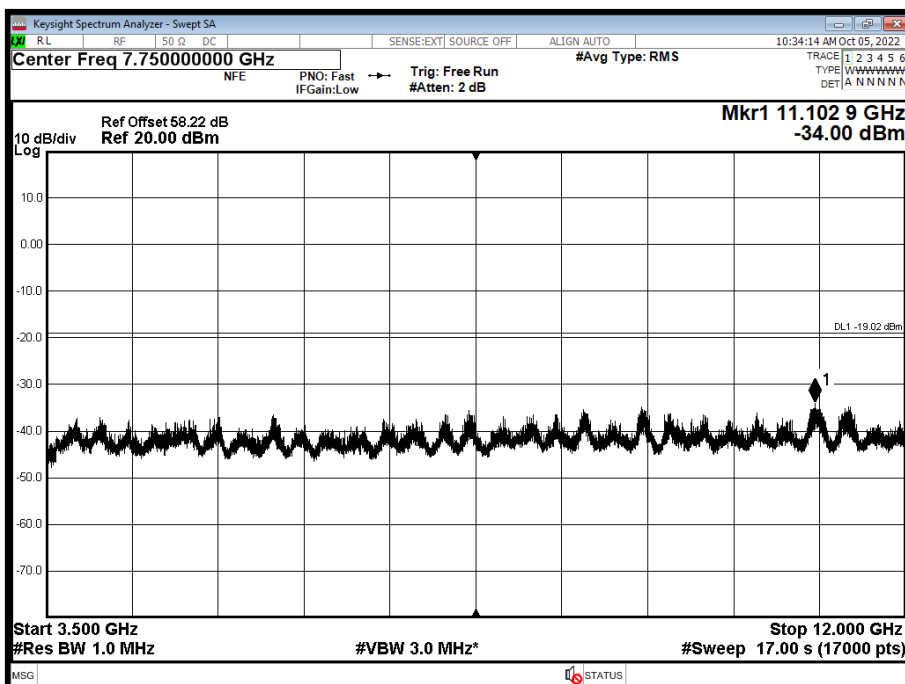



Antenna A - NR Modulation QPSK - NR Carrier Bandwidth 10.0 MHz 15 kHz SCS - Channel Position T - Band 3 - Range 12000 to 18000 MHz

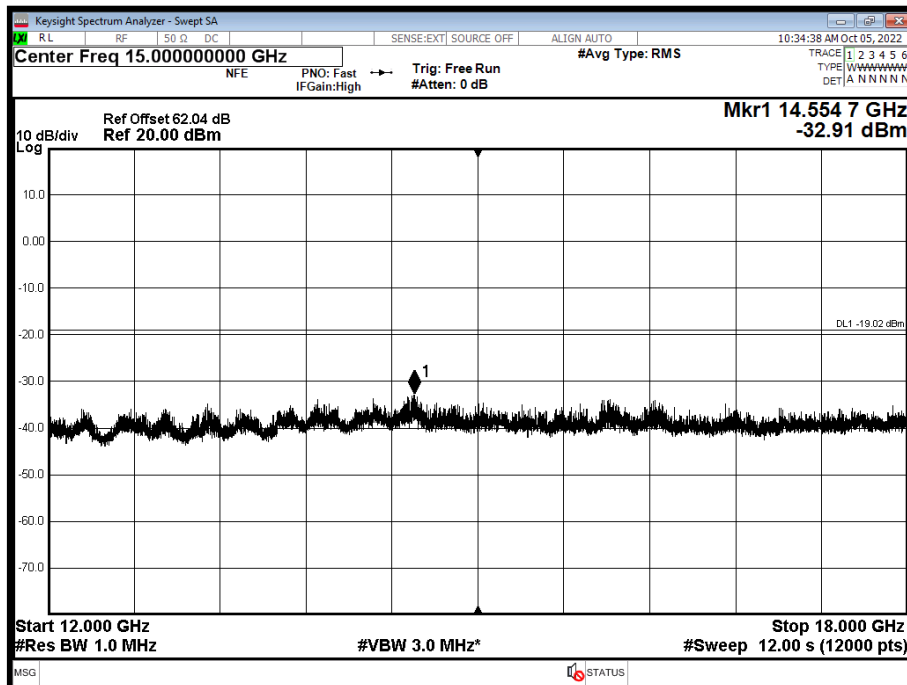

Antenna A - NR Modulation QPSK - NR Carrier Bandwidth 10.0 MHz 15 kHz SCS - Channel Position T - Band 4 - Range 18000 to 20000 MHz

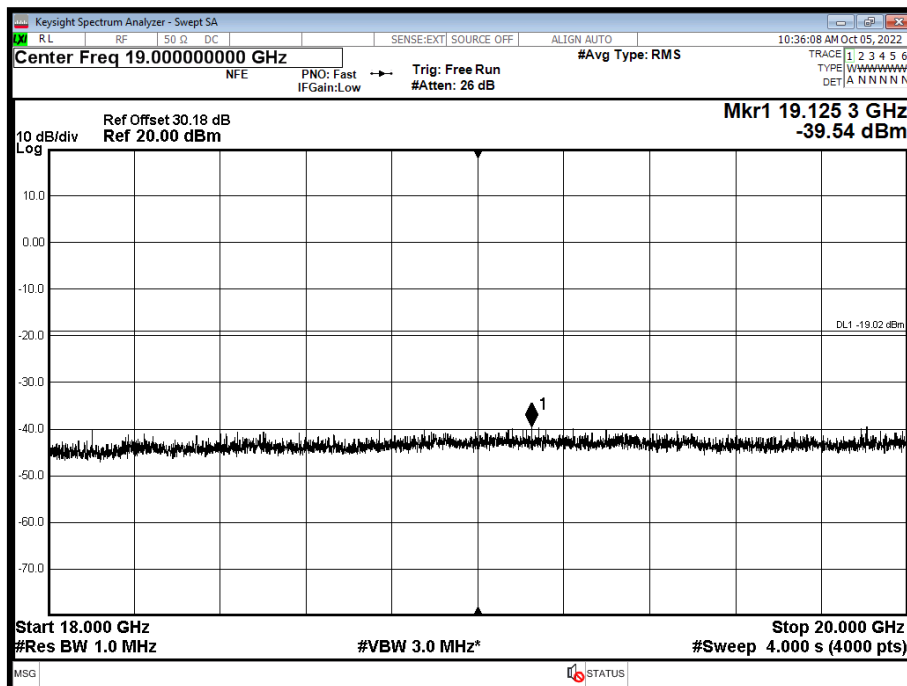



Antenna A - NR Modulation QPSK - NR Carrier Bandwidth 15.0 MHz 15 kHz SCS - Channel Position T - Band 1 - Range 0.009 to 3500 MHz

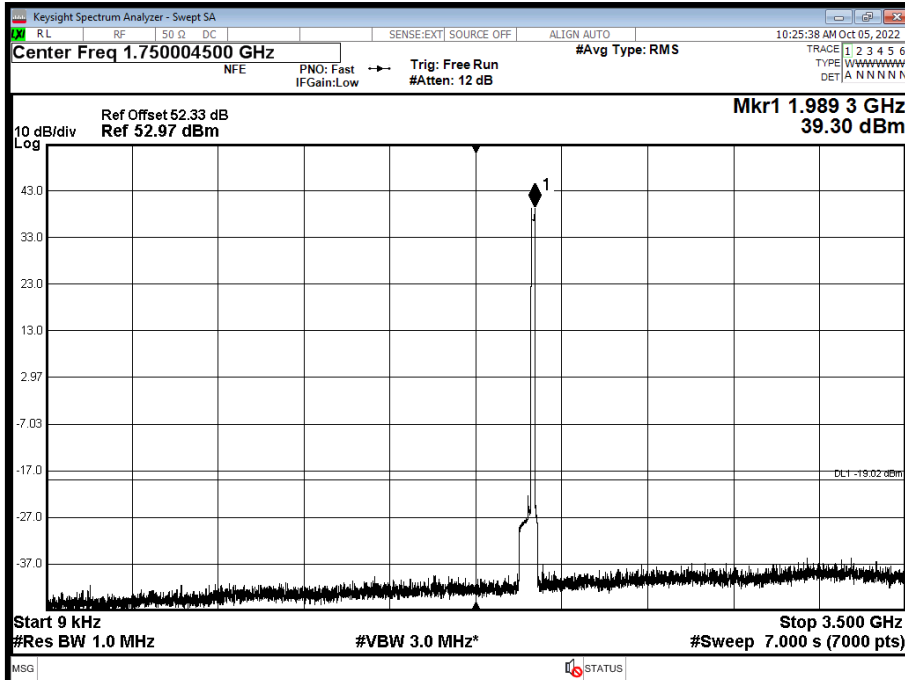

Antenna A - NR Modulation QPSK - NR Carrier Bandwidth 15.0 MHz 15 kHz SCS - Channel Position T - Band 2 - Range 3500 to 12000 MHz

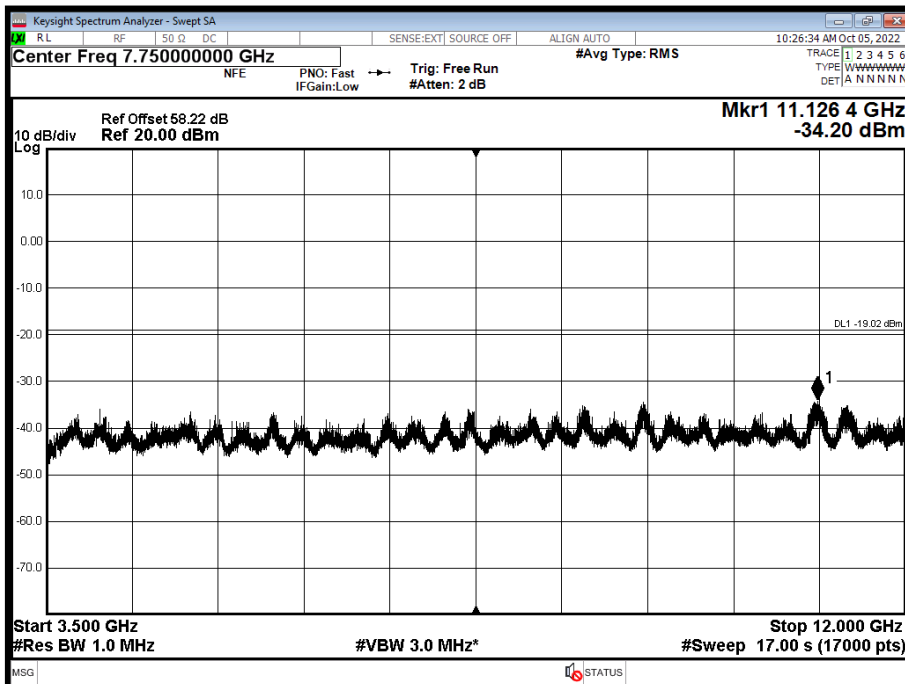



Antenna A - NR Modulation QPSK - NR Carrier Bandwidth 15.0 MHz 15 kHz SCS - Channel Position T - Band 3 - Range 12000 to 18000 MHz

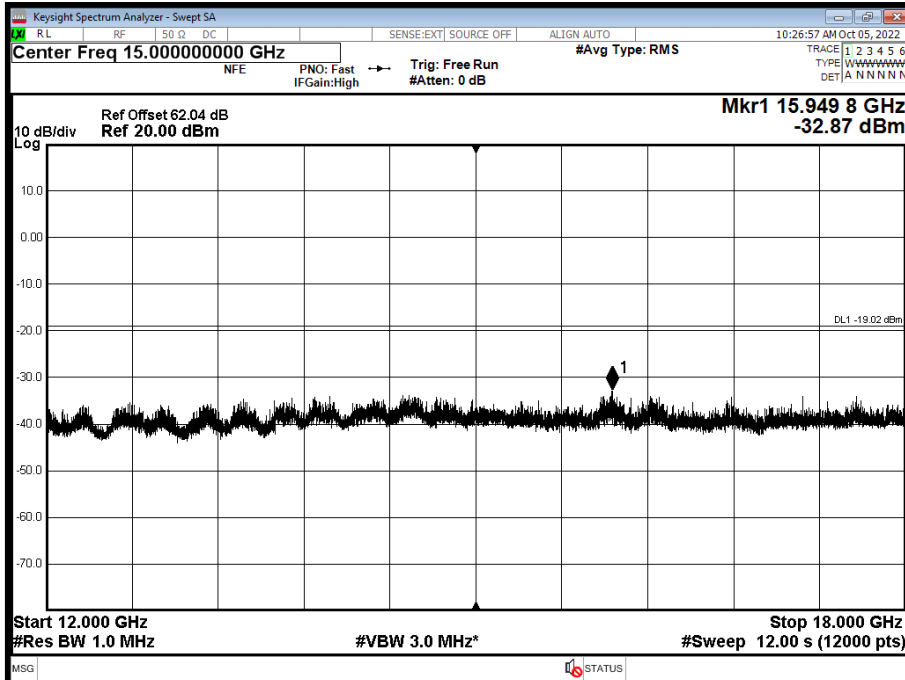

Antenna A - NR Modulation QPSK - NR Carrier Bandwidth 15.0 MHz 15 kHz SCS - Channel Position T - Band 4 - Range 18000 to 20000 MHz

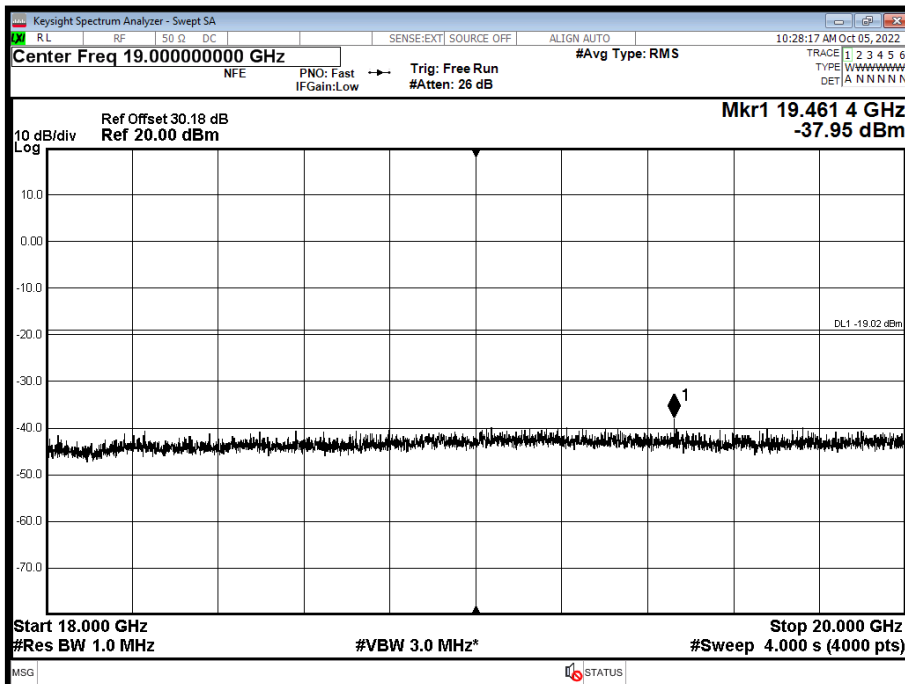



Antenna A - NR Modulation QPSK - NR Carrier Bandwidth 20.0 MHz 15 kHz SCS - Channel Position T - Band 1 - Range 0.009 to 3500 MHz

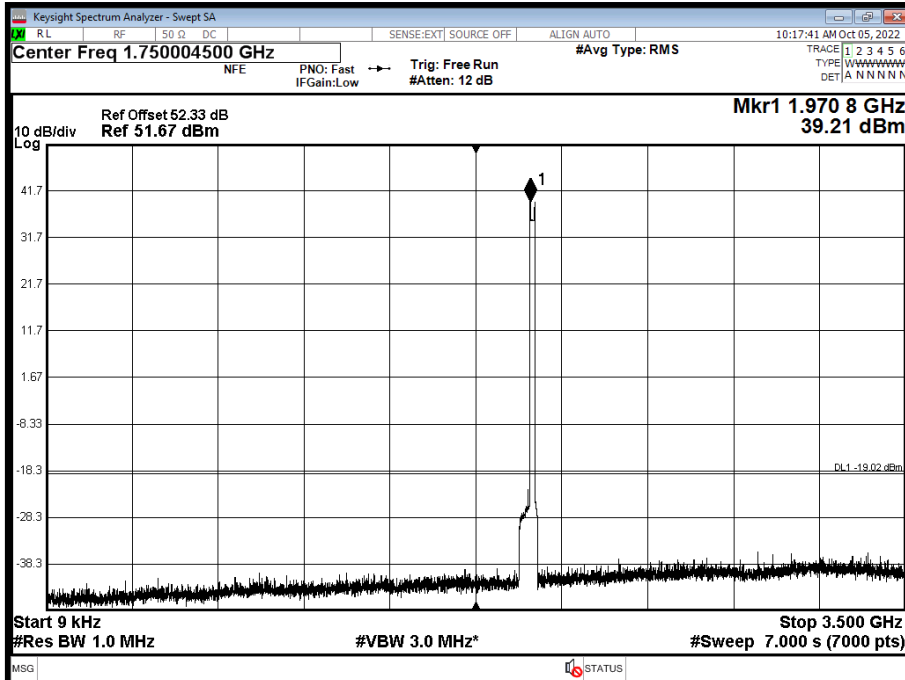

Antenna A - NR Modulation QPSK - NR Carrier Bandwidth 20.0 MHz 15 kHz SCS - Channel Position T - Band 2 - Range 3500 to 12000 MHz

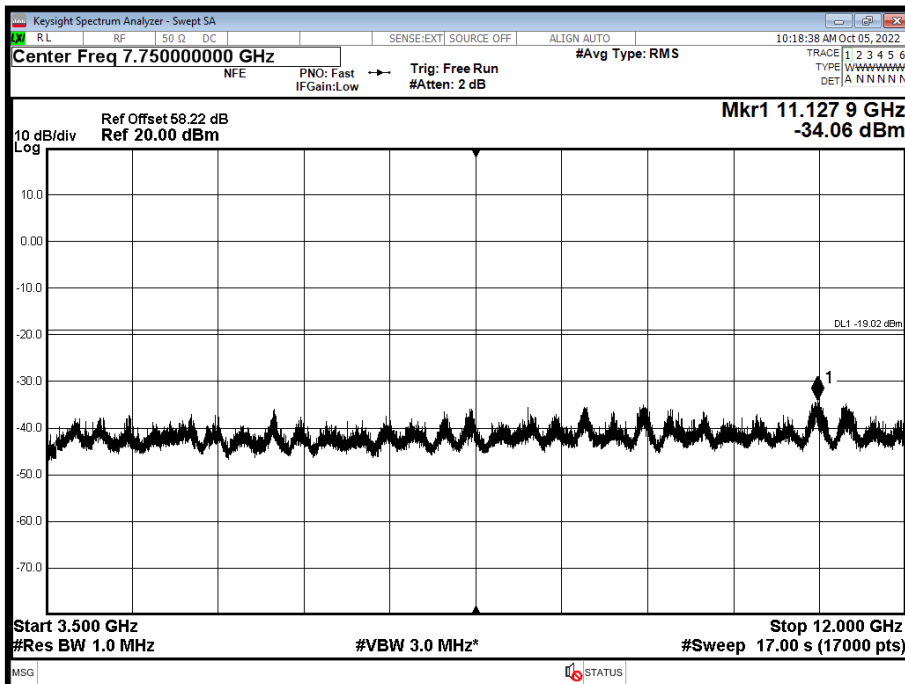



Antenna A - NR Modulation QPSK - NR Carrier Bandwidth 20.0 MHz 15 kHz SCS - Channel Position T - Band 3 - Range 12000 to 18000 MHz

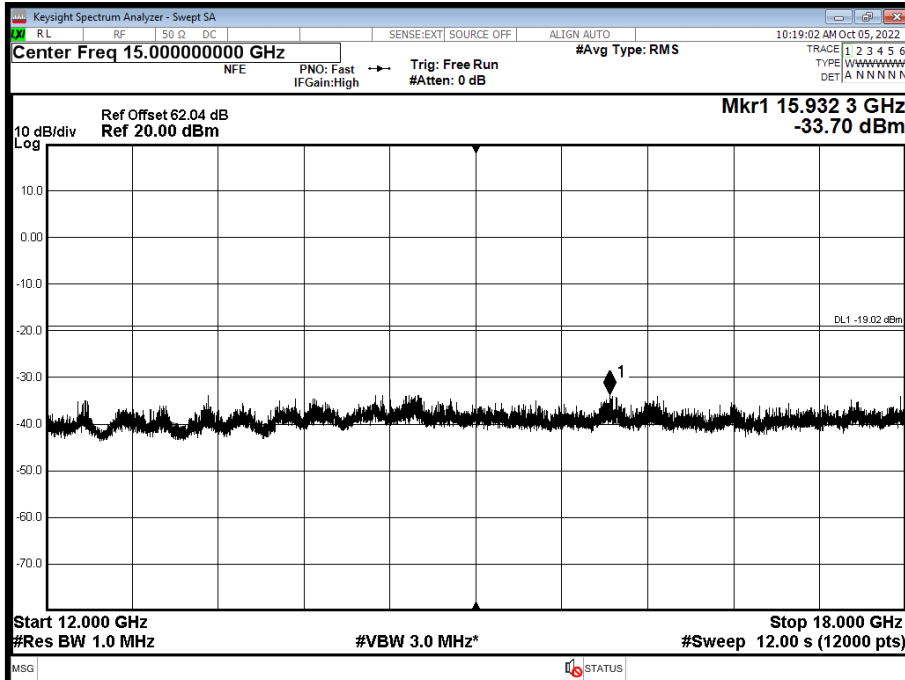

Antenna A - NR Modulation QPSK - NR Carrier Bandwidth 20.0 MHz 15 kHz SCS - Channel Position T - Band 4 - Range 18000 to 20000 MHz

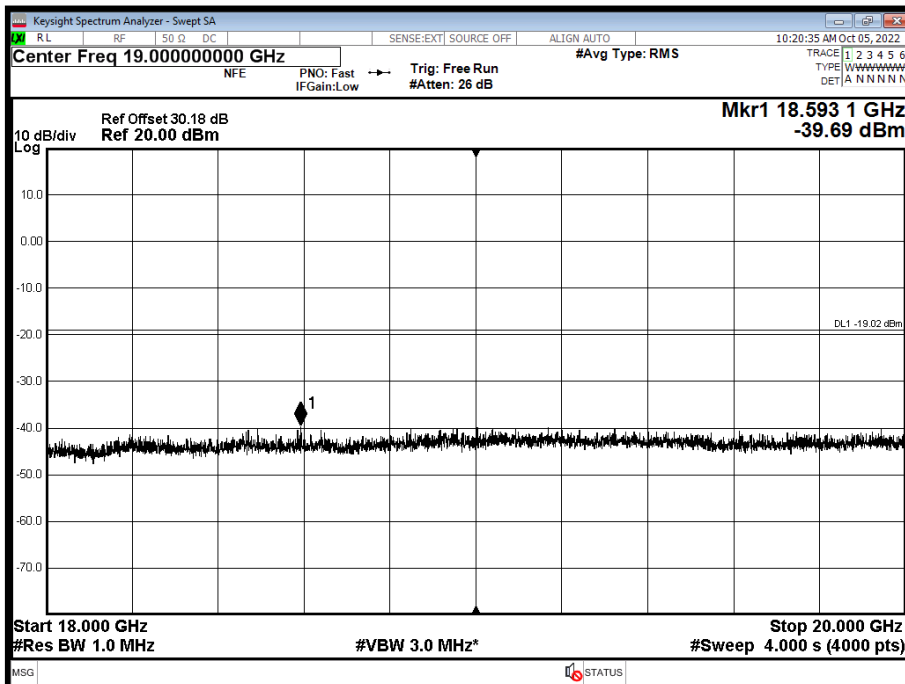

Limit	-19dBm
-------	--------





**2.5 RADIATED EMISSIONS**

**2.5.1 Specification Reference**

ISED RSS-GEN, Clause 6.13  
Industry Canada RSS-133, Clause 6.5  
FCC CFR 47 Part 2, Clause 2.1053

**2.5.2 Date of Test and Modification State**

12 and 13-October-2022 - Modification State 0

**2.5.3 Test Equipment Used**

The major items of test equipment used for the above tests are identified in Section 3.1.

**2.5.4 Environmental Conditions**

Ambient Temperature 22.5-25.1°C  
Relative Humidity 37.1-44.6%

**2.5.5 Test Method**

The test was performed in accordance with ANSI C63.26 Clause 5. The EUT was configured as defined in ANSI C63.26, clause 5.5.2.3.2.

The EUT was set up on a support replicating typical installation conditions at a height of 0.8 m above the reference ground plane for measurements below 1GHz, (see setup photos) within a semi-anechoic chamber on a remotely controlled turntable. Above 1 GHz, the height was increased to 1.5 m above the reference ground plane.

**2.5.6 Test Results**

Configuration 1

Maximum Output Power 47.78 dBm

Frequency (MHz)	Level (dBm)	Limit (dBm)	Margin (dB)	Detector	Angle (°)	Height (cm)	Polarisation
*							

Top - NR&NB-IoT - B2, 1985MHz, 30 MHz to 22.5 GHz

\*No emissions found within 6 dB of the limit.

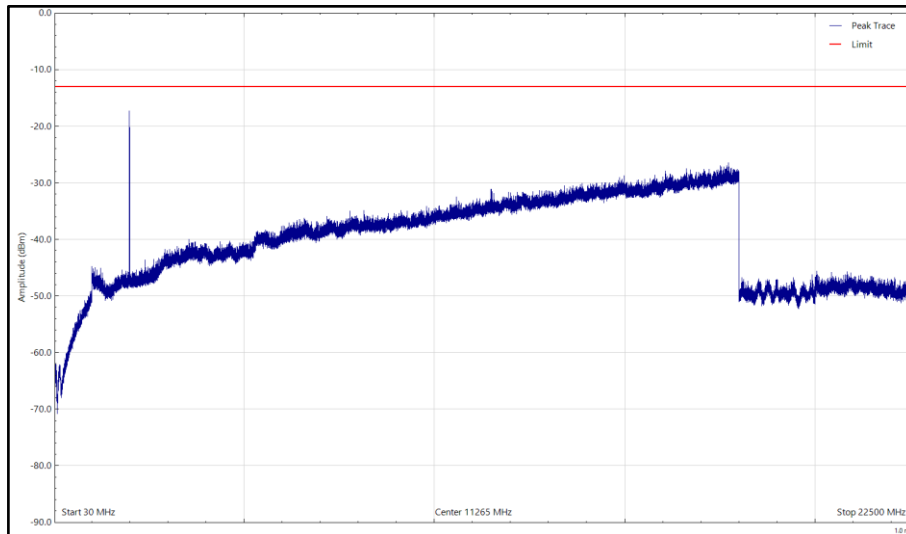

Top - NR&NB-IoT - B2, 1985MHz, 30 MHz to 22.5 GHz, Horizontal (Peak)

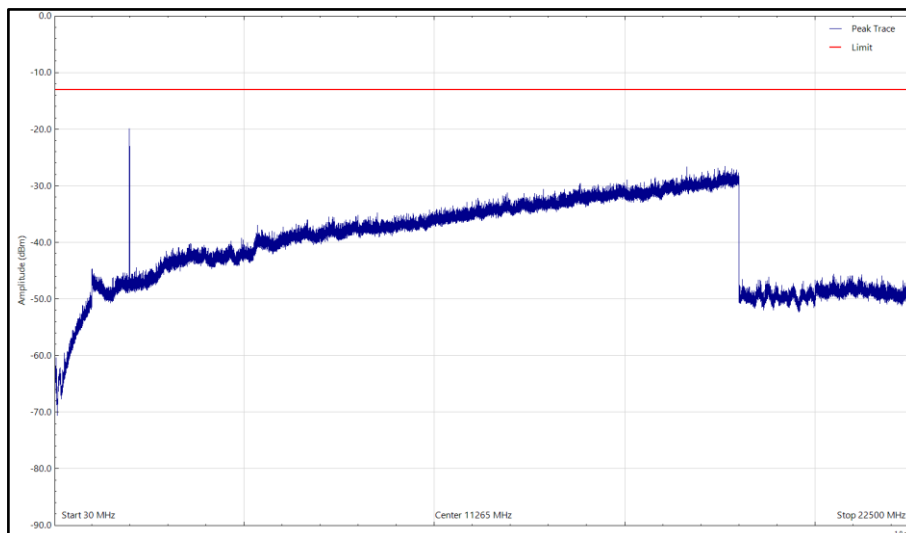

Top - NR&NB-IoT - B2, 1985MHz, 30 MHz to 22.5 GHz, Vertical (Peak)



Frequency (MHz)	Level (dBm)	Limit (dBm)	Margin (dB)	Detector	Angle (°)	Height (cm)	Polarisation
*							

Top - NR&NB-IoT - B25, 1990MHz, 30 MHz to 22.5 GHz

\*No emissions found within 6 dB of the limit.

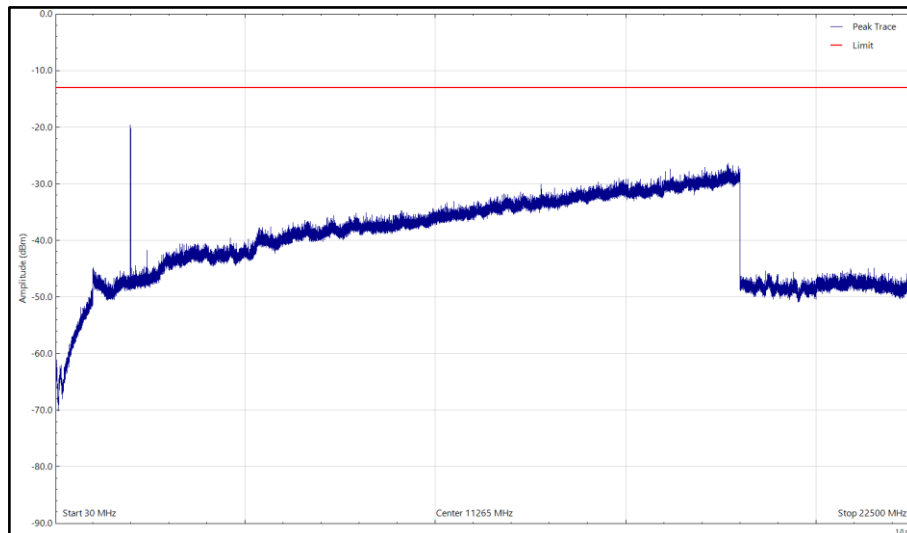

Top - NR&NB-IoT - B25, 1990MHz, 30 MHz to 22.5 GHz, Horizontal (Peak)

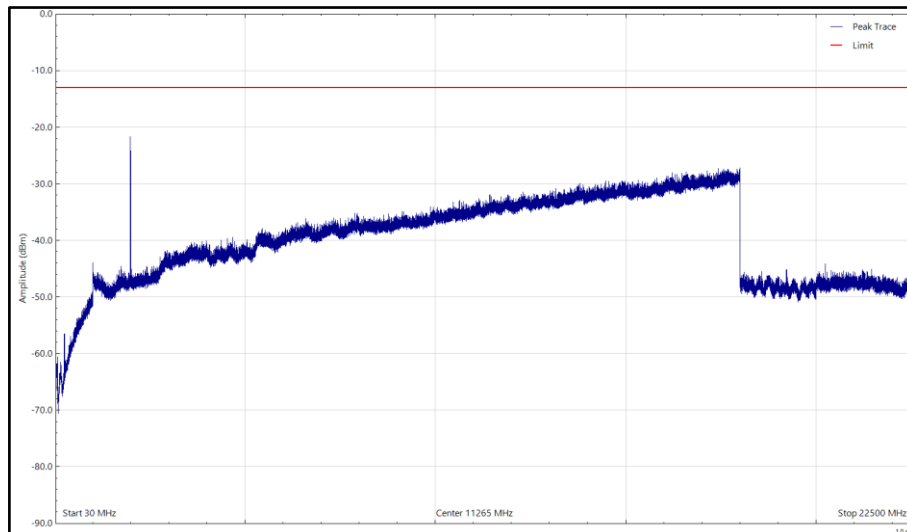

Top - NR&NB-IoT - B25, 1990MHz, 30 MHz to 22.5 GHz, Vertical (Peak)



Frequency (MHz)	Level (dBm)	Limit (dBm)	Margin (dB)	Detector	Angle (°)	Height (cm)	Polarisation
*							

Bot - NR&NB-IoT - B25, 1935MHz, 30 MHz to 22.5 GHz

\*No emissions found within 6 dB of the limit.

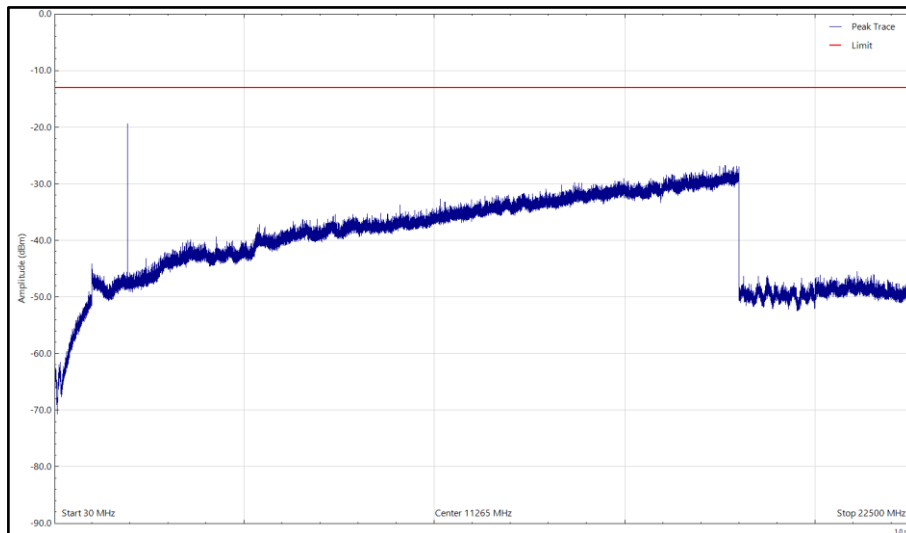

Bot - NR&NB-IoT - B25, 1935MHz, 30 MHz to 22.5 GHz, Horizontal (Peak)

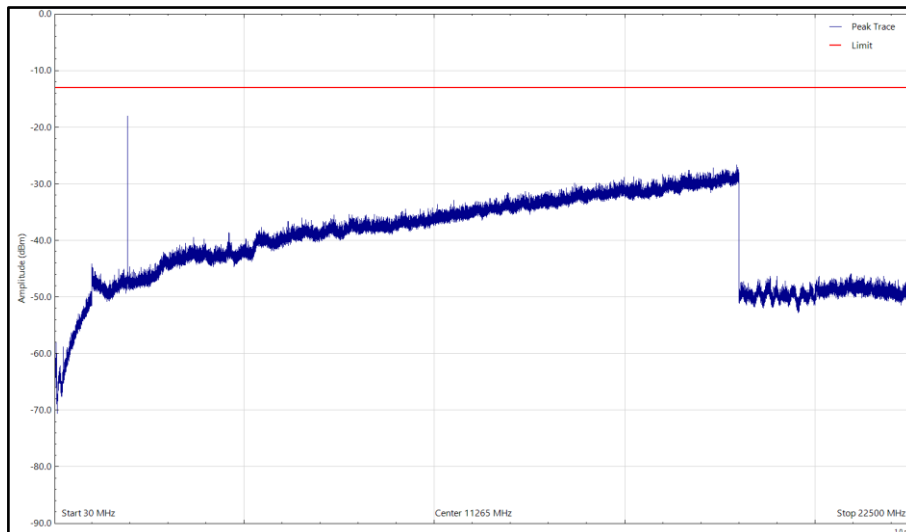

Bot - NR&NB-IoT - B25, 1935MHz, 30 MHz to 22.5 GHz, Vertical (Peak)



Frequency (MHz)	Level (dBm)	Limit (dBm)	Margin (dB)	Detector	Angle (°)	Height (cm)	Polarisation
*							

Mid - NR&NB-IoT - B25, 1962.5MHz, 30 MHz to 22.5 GHz

\*No emissions found within 6 dB of the limit.

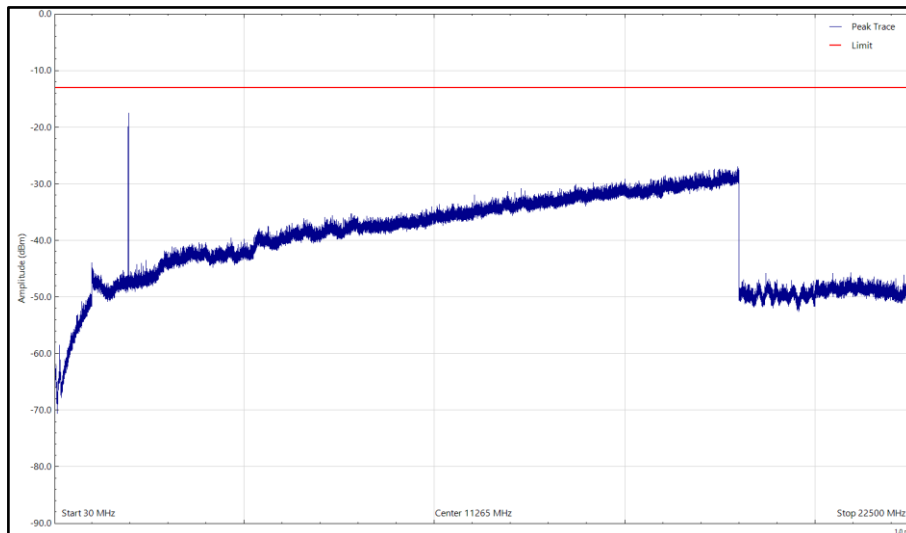

Mid - NR&NB-IoT - B25, 1962.5MHz, 30 MHz to 22.5 GHz, Horizontal (Peak)

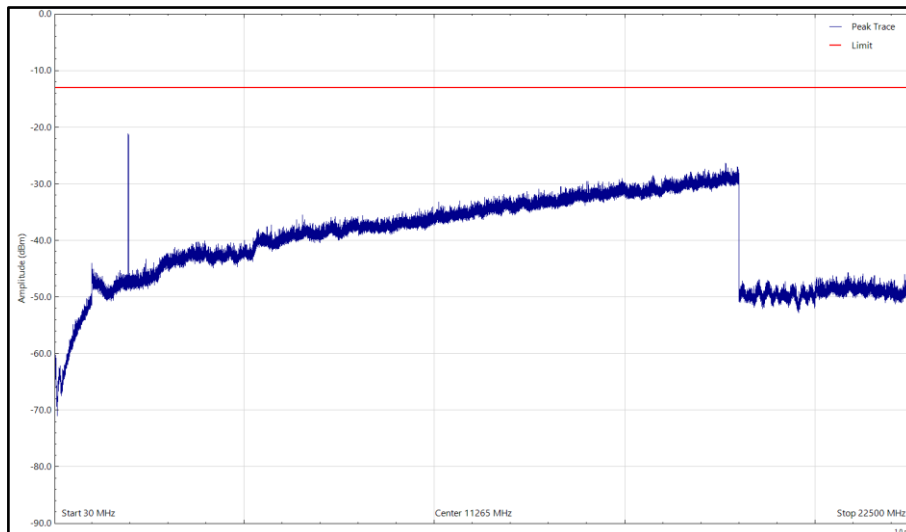

Mid - NR&NB-IoT - B25, 1962.5MHz, 30 MHz to 22.5 GHz, Vertical (Peak)

Limit	-19dBm
-------	--------



### **SECTION 3**

#### **TEST EQUIPMENT USED**



### 3.1 TEST EQUIPMENT USED

List of absolute measuring and other principal items of test equipment.

Instrument	Manufacturer	Type No.	TE No.	Calibration Period (months)	Calibration Due
<b>Maximum Peak Output Power and Peak to Average Ratio - Conducted</b>					
Hygrometer	PCE Instruments	PCE-THB-40	5475	12	25-Apr-2023
Frequency Standard	Spectracom	SecureSync 1200-0408-0601	4393	6	01-Feb-2023
Analyser	Keysight	N9030A	4654	12	24-Nov-2022
Power Supply	Farnell	H60-25	1092	-	OP-MON
Multimeter	Fluke	177	3833	12	16-Dec-2022
Attenuator	Weinschel	48-20-43-LIM	5133	12	02-Dec-2022
Attenuator	Weinschel	48-30-43-LIM	5135	12	20-Aug-2023
Network Analyser	Rohde & Schwarz	ZVA 40	3548	12	24-Feb-2023
Calibration kit	Rohde & Schwarz	ZV-Z55	4368	12	24-Feb-2023
<b>Occupied Bandwidth</b>					
Hygrometer	PCE Instruments	PCE-THB-40	5475	12	25-Apr-2023
Frequency Standard	Spectracom	SecureSync 1200-0408-0601	4393	6	01-Feb-2023
Analyser	Keysight	N9030A	4654	12	24-Nov-2022
Power Supply	Farnell	H60-25	1092	-	OP-MON
Multimeter	Fluke	177	3833	12	16-Dec-2022
Attenuator	Weinschel	48-20-43-LIM	5133	12	02-Dec-2022
Attenuator	Weinschel	48-30-43-LIM	5135	12	20-Aug-2023
Network Analyser	Rohde & Schwarz	ZVA 40	3548	12	24-Feb-2023
Calibration kit	Rohde & Schwarz	ZV-Z55	4368	12	24-Feb-2023
<b>Band Edge</b>					
Hygrometer	PCE Instruments	PCE-THB-40	5475	12	25-Apr-2023
Frequency Standard	Spectracom	SecureSync 1200-0408-0601	4393	6	01-Feb-2023
Analyser	Keysight	N9030A	4654	12	24-Nov-2022
Power Supply	Farnell	H60-25	1092	-	OP-MON
Multimeter	Fluke	177	3833	12	16-Dec-2022
Attenuator	Weinschel	48-20-43-LIM	5133	12	02-Dec-2022
Attenuator	Weinschel	48-30-43-LIM	5135	12	20-Aug-2023
Network Analyser	Rohde & Schwarz	ZVA 40	3548	12	24-Feb-2023
Calibration kit	Rohde & Schwarz	ZV-Z55	4368	12	24-Feb-2023
<b>Transmitter Spurious Emissions</b>					
Hygrometer	PCE Instruments	PCE-THB-40	5475	12	25-Apr-2023
Frequency Standard	Spectracom	SecureSync 1200-0408-0601	4393	6	01-Feb-2023
Analyser	Keysight	N9030A	4654	12	24-Nov-2022



Instrument	Manufacturer	Type No.	TE No.	Calibration Period (months)	Calibration Due
Power Supply	Farnell	H60-25	1092	-	OP-MON
Multimeter	Fluke	177	3833	12	16-Dec-2022
Attenuator	Weinschel	48-20-43-LIM	5133	12	02-Dec-2022
Attenuator	Weinschel	48-30-43-LIM	5135	12	20-Aug-2023
Network Analyser	Rohde & Schwarz	ZVA 40	3548	12	24-Feb-2023
Calibration kit	Rohde & Schwarz	ZV-Z55	4368	12	24-Feb-2023
Waveguide filter	Quasar	QWS20SB-UBR-UBR-50	5789	12	12-May-2023
WG20 Coaxial Adapter	Quasar	QWC20SB-UBR-K-F	5785	-	OP-MON
WG20 Coaxial Adapter	Quasar	QWC20SB-UBR-K-F	5786	-	OP-MON
Cable attenuator	Aralab	CSF6767C-C2S6500	5175	-	OP-MON
HPF	Wainwright	WHKX12-2580-3000-18000-80SS	5547	12	11-May-2023
<b>Radiated Emissions</b>					
True RMS Multimeter	Fluke	79 Series III	411	12	13-Oct-2023
Power Supply (60V-50A)	Farnell	H 60/50	1056	-	TU
Screened Room (5)	Rainford	Rainford	1545	36	15-Apr-2024
Turntable Controller	Inn-Co GmbH	CO 1000	1606	-	TU
Hygromer	Rotronic	Hygropalm	2404	12	18-Jul-2023
Signal Analyser	Rohde & Schwarz	FSQ 26	3545	12	27-Apr-2023
Mast Controller	Maturo GmbH	NCD	4810	-	TU
Tilt Antenna Mast	Maturo GmbH	TAM 4.0-P	4811	-	TU
Antenna (DRG 1-10.5GHz)	Schwarzbeck	BBHA9120B	4848	12	28-May-2023
DRG Horn Antenna (7.5-18GHz)	Schwarzbeck	HWRD750	5216	12	29-May-2023
Antenna (DRG Horn 7.5-18GHz)	Schwarzbeck	HWRD750	5348	12	16-Oct-2023
Cable (SMA to SMA, 2 m)	Junkosha	MWX221-02000AMSAMS/A	5517	12	12-Apr-2023
Cable (N-Type to N-Type, 8 m)	Junkosha	MWX221-08000NMSNMS/B	5520	12	24-Mar-2023
EMI Test Receiver	Rohde & Schwarz	ESW44	5527	12	28-Apr-2023
Antenna (DRG, 7.5 GHz to 18 GHz)	Schwarzbeck	HWRD750	5610	12	16-Oct-2023
Cable (K Type 2m)	Junkosha	MWX241-01000KMSKMS/B	5936	12	14-May-2023
Cable (K Type 2m)	Junkosha	MWX241-01000KMSKMS/B	5938	12	14-May-2023
TRILOG Super Broadband Test Antenna	Schwarzbeck	VULB 9168	5942	24	03-Feb-2024
Double Ridge Active Horn Antenna (18-40 GHz)	Com-Power	AHA-840	6189	24	02-Jun-2024
Attenuator 4dB	Pasternack	PE7074-4	6204	24	16-Jul-2024

TU – Traceability Unscheduled

N/A – Not Applicable

O/P Mon – Output Monitored with Calibrated Equipment





### 3.2 MEASUREMENT UNCERTAINTY

For a 95% confidence level, the measurement uncertainties for defined systems are:-

Test Discipline	Frequency / Parameter	MU
Conducted Maximum Peak Output Power	9 kHz to 40 GHz Amplitude	± 1.0 dB
Conducted Emissions	9 kHz to 40 GHz Amplitude	± 3.5 dB
Occupied Bandwidth	10 MHz Bandwidth	± 16.7 kHz
	15 MHz Bandwidth	
	20 MHz Bandwidth	
Band Edge	< 3.6 GHz Amplitude	± 0.6 dB
Radiated Spurious Emissions	30 MHz to 1 GHz	± 5.2 dB
	1 GHz to 40 GHz	± 6.3 dB

#### Measurement Uncertainty Decision Rule

Determination of conformity with the specification limits is based on the results of the compliance measurement and does not take into account measurement instrumentation uncertainty as defined in ANSI C63.26:2015 Clause 1.3.

Risk: The uncertainty of measurement about the measured result is negligible with regard to the final pass/fail decision. The measurement result can be directly compared with the test limit to determine conformance with the requirement (compare IEC Guide 115). The level of risk to falsely accept and falsely reject items is further described in ILAC-G8



### 3.3 MEASUREMENT SOFTWARE USED

List of measurement software versions used for testing.

Instrument/Software	Manufacturer	Type No.	TE No.	Software Version
PXA Signal Analyser	Keysight	N9030A	4654	A 22.08
HP-VEE Software	TUV SUD	HP_VEE	N/A	V3.29
eMx	TUV SUD	N/A	N/A	V3.1.4



## **SECTION 4**

### **ACCREDITATION, DISCLAIMERS AND COPYRIGHT**



#### 4.1 ACCREDITATION, DISCLAIMERS AND COPYRIGHT

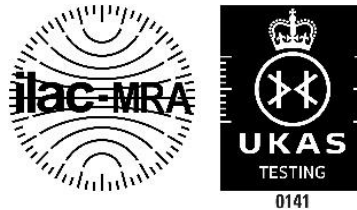

This report relates only to the actual item/items tested.

Our UKAS Accreditation does not cover opinions and interpretations and any expressed are outside the scope of our UKAS Accreditation.

Results of tests not covered by our UKAS Accreditation Schedule are marked NUA (Not UKAS Accredited).

© 2022 TÜV SÜD  
TÜV SÜD

Postal Address :Octagon House, Concorde Way, Fareham, Hampshire, UK, PO15 5RL



## **ANNEX A**

### **MODULE LIST**



Configurations 1 & 2			
Product	Product No	R-State	Serial No
Radio 4499	KRC 161 847/1	R2C	E23C972483
Software Version:	CXP9013268/15	Revision:	R89MU15