



Add value.
Inspire trust.



Report On

FCC and ISED Testing of the
Ericsson Radio 4480 44B2/B25 44B66A C, KRC 161 844/1, NR and
NB-IoT Inband (1900 MHz) Base Station in accordance with FCC CFR
47 Part 2, FCC CFR 47 Part 24, ISED RSS-GEN and Industry Canada
RSS-133

COMMERCIAL-IN-CONFIDENCE

FCC: TA8AKRC161844

IC: 287AB-AS161844

PREPARED BY

Maggie Whiting
Key Account Manager

APPROVED BY

Steve Scarfe
Authorised Signatory

DATED

26 October 2022

Document 75955712 Report 02 Issue 1

October-2022



CONTENTS

Section	Page No
1	REPORT INFORMATION 2
1.1	Report Details 3
1.2	Brief Summary of Results 4
1.3	Test Rationale..... 5
1.4	Configuration Description 6
1.5	Declaration of Build Status 7
1.6	Product Information 9
1.7	Test Setup 10
1.8	Test Conditions..... 12
1.9	Deviation From The Standard 12
1.10	Modification Record 12
1.11	Additional Information 13
2	TEST DETAILS 14
2.1	Maximum Peak Output Power and Peak to Average Ratio - Conducted..... 15
2.2	Occupied Bandwidth..... 25
2.3	Band Edge 37
2.4	Transmitter Spurious Emissions 45
2.5	Radiated Emissions 82
3	TEST EQUIPMENT USED 87
3.1	Test Equipment Used 88
3.2	Measurement Uncertainty 90
3.3	Measurement Software Used 91
4	ACCREDITATION, DISCLAIMERS AND COPYRIGHT..... 92
4.1	Accreditation, Disclaimers and Copyright..... 93
ANNEX A	Module Lists.....A.2



SECTION 1

REPORT INFORMATION



1.1 REPORT DETAILS

Manufacturer	Ericsson AB
Address	Torshamnsgatan 23 Kista SE-16480 Stockholm Sweden
Product Name & Product Number	Radio 4480 44B2/B25 44B66A C - KRC 161 844/1
IC Model Name	AS161844
Serial Number(s)	E23C418848
Software Version	CXP9013268/15 Revision R89MU15
Hardware Version	R2B
Non-Tested Variant (See Section 1.11 Additional Information)	Radio 4480 44B2/B25 44B66A C - KRC 161 844/3
Test Specification/Issue/Date	FCC CFR 47 Part 2: 2021 FCC CFR 47 Part 24: 2021 ISED RSS-GEN: Issue 5: March 2019 Amendment 1, 2021 Amendment 2 Industry Canada RSS-133: Issue 6: January 2018 Amendment 1
Test Plan	MR7602-SP-2E _Spectrum Sharing with NB-IoT 11 Radios FCC and ISED_Rev-F
Start of Test	04-October-2022
Finish of Test	10-October-2022
Name of Engineer(s)	Neil Rousell, Graeme Lawler
Related Document(s)	KDB 971168 D01 v02r02 KDB 662911 D01 v02r01 ICES-003:Issue 7 (2020-10) ANSI C63.26-2015

ENGINEERING STATEMENT

The measurements shown in this report were made in accordance with the procedures described on test pages. All reported testing was carried out on a sample equipment to demonstrate compliance with and FCC CFR 47 Part 2: 2021, FCC CFR 47 Part 24: 2021, ISED RSS-GEN: Issue 5: March 2019 Amendment 1, 2021 Amendment 2 Industry Canada RSS-133: Issue 6: January 2018 Amendment 1 The sample tested was found to comply with the requirements defined in the applied rules.

Test Engineer(s);

Neil Rousell, Graeme Lawler



1.2 BRIEF SUMMARY OF RESULTS

The tests that have been selected are detailed in the customer Test Plan as defined in section 1.1 of this report. The Test Plan is based on the TÜV SÜD FCC Test Plan Rationale, available on request.

A brief summary of results for each configuration, in accordance with FCC CFR 47 Part 2, FCC CFR 47 Part 24, ISED RSS-GEN and Industry Canada RSS-133 is shown below.

Section	Specification Clause				Test Description	Result
	FCC CFR 47 Part 2	FCC CFR 47 Part 24	RSS-GEN	RSS-133		
2.1	2.1046	24.232	-	6.4	Maximum Peak Output Power and Peak to Average Ratio - Conducted	Pass
2.2	2.1049	24.238 (b)	6.7		Occupied Bandwidth	Pass
2.3	2.1051	24.238 (b)	-	6.5	Band Edge	Pass
2.4	2.1051	24.238 (a)	6.13	6.5	Transmitter Spurious Emissions	Pass
2.5	2.1053	-	6.13	6.5	Radiated Emissions	Pass

Testing in this Report covers only B2 and B25 (1900 MHz)

For additional configurations and test cases not contained within this test report, refer to the following reports:

Document 759555712 Report 03 – Radio 4480 44B2/B25 44B66A C – B66A (2100 MHz)



1.3 TEST RATIONALE

The tests that have been selected are detailed in the customer Test Plan as defined in section 1.1 of this report. The Test Plan is based on the TÜV SÜD FCC Test Plan Rationale, available on request.



1.4 CONFIGURATION DESCRIPTION

Config	Band	RATs	Carriers	Pout (W)	Position	BW	Freq	NR-ARFCN
1	B25	NR in NR/ESS Setup (NB IoT IB) QPSK	1	60	B	10	1935	387000
					M	10	1962.5	392500
					T	10	1990	398000
					B	15	1937.5	387500
					M	15	1962.5	392500
					T	15	1987.5	397500
					B	20	1940	388000
					M	20	1962.5	392500
2	B2	NR in NR/ESS Setup (NB IoT IB) QPSK	1	60	T	10	1985	397000
						15	1982.5	396500
						20	1980	396000



1.5 DECLARATION OF BUILD STATUS

Equipment Description			
Technical Description: (Please provide a brief description of the intended use of the equipment including the technologies the product supports)		Multi-standard remote radio unit Radio 4480 44B2/B25 44B66A C, 4Tx/4Rx	
Manufacturer:		Ericsson AB	
Model:		4480 44B2/B25 44B66A C	
Part Number:		KRC 161 844/1 KRC 161 844/3 (NEBS variant)	
Hardware Version:		R2B	
Software Version:		CXP 9013268/15-R89MU15	
FCC ID of the product under test		TA8AKRC161844	
IC ID of the product under test		287AB-AS161844	
Intentional Radiators			
Frequency Range (MHz to MHz) B2 : GSM, WCDMA, LTE ,NR, NB-IoT (IB, GB), NB-IoT SA,	TX(DL):1930-1990MHz RX(UL):1850-1910MHz	BW: 60MHz BW: 60MHz	
Frequency Range (MHz to MHz) B25: WCDMA, LTE ,NR, NB-IoT SA, NB-IoT (IB, GB);	TX(DL):1930-1995MHz RX(UL):1850-1915MHz	BW: 65MHz BW: 65MHz	
Frequency Range (MHz to MHz) B66A: WCDMA, LTE ,NR, NB-IoT SA, NB-IoT (IB, GB);	TX(DL):2110 - 2180MHz RX(UL):1710 - 1780MHz	BW: 70MHz BW: 70MHz	
Conducted Declared Output Power (dBm)	47,8 Max output power per Band 50.0 Max output power per Port		
RAT SC carrier Power (Max) :	BW (LTE)	BW (NR)	PWR/C
	1.4MHz (B2, B25)	x	20W
	3MHz (B2, B25)	x	20W
	5MHz (B25, B66A)	5MHz (B25, B66A)	40 W
	10MHz (B25, B66A)	10MHz (B25, B66A)	60 W
	15MHz (B25, B66A)	15MHz (B25, B66A)	60 W
	20MHz (B25, B66A)	20MHz (B25, B66A)	60 W
RAT SC carrier Power (Max) :WCDMA (B2, B25, B66A)	5MHz	40W	
RAT SC carrier Power (Max) :GSM (B2)	200kHz	20W	
RAT SC carrier Power (Max) :NB-IoT SA (B2, B25, B66A)	200kHz	20 W	
Radio Configuration:	4RX / 4TX		
Duplex mode:	FDD		
Radio Access Technology, RAT(s) B2:	Single RAT: GSM, W, L, NB IoT SA, NR Multi RAT: G+W+NB IoT SA; G+L+NB IoT SA ; W+L+NB IoT SA NR+L+NB IoT SA; G+L+NR; W+L+NR		
Supported Bandwidth(s) (MHz) B25:	Single RAT: W, L, NB IoT SA, NR Multi RAT: W+L+NB IoT SA; NR+L+NB IoT SA; W+L+NR		
Supported Bandwidth(s) (MHz) B66A:	Single RAT: W, L, NB IoT SA, NR Multi RAT: W+L+NB IoT SA; NR+L+NB IoT SA; W+L+NR		
Antenna Gain (dBi)	Maximum antenna system gain (including cable loss), GANT (dBi) for the tested configurations to comply with maximum radiated output power in SRSP -513 and SRSP-510 calculated using measured and summed PSD from all 4 Ports		
Antenna Impedance(Ω)	50		
Supported modulation scheme, LTE:	QPSK, 16QAM, 64QAM, 256QAM		
Supported modulation scheme, NR:	QPSK, 16QAM, 64QAM, 256QAM		
Supported modulation scheme, WCDMA:	QPSK, 16QAM, 64QAM		



Supported modulation scheme, GSM:	GMSK, AQPSK, 8PSK	
Supported modulation scheme, NB-IoT :	QPSK	
NR SCS	15kHz	
RF power Tolerance:	.+0.6/-2.5dB	
Frequency Tolerance:	±0.05 ppm	
Carrier Aggregation, CA	Supported	
Maximum supported number of DL NR carrier per port	6/multi-Band	
Maximum supported number of DL LTE carrier per port	6/multi-Band	
Maximum supported number of DL WCDMA carrier per port	6/multi-Band	
Maximum supported number of DL GSM carrier per port	4/multi-Band	
Maximum supported number of DL NB-IoT carrier per port	2/multi-Band	
Nominal output power per Antenna Port / Band	Multi Band: 100W (50,0 dBm)	
Supported transmission modes:	4X4 MIMO	
Unintentional Radiators		
Highest frequency generated or used in the device or on which the device operates or tunes		Up to 10.1 Gbit/s
Lowest frequency generated or used in the device or on which the device operates or tunes if <30MHz		.-
Class A Digital Device (Use in commercial, industrial or business environment)		.-
Class B Digital Device (Use in residential environment)		Class B
DC Power Supply (Delete if Not Applicable)		
Nominal voltage: DC power supply		-48V
Extreme upper voltage:		-36.0V
Extreme lower voltage:		-58.5V
Max current:		32A
Temperature		
Minimum temperature:		-40°C
Maximum temperature:		55°C
I hereby declare that I am entitled to sign on behalf of the manufacturer and that the information supplied is correct and complete.		
Name:		Afrah Ali sadiq
Position held:		Regulatory Approval Engineer
Email address:		Afrah.ali.sadiq@ericsson.com
Telephone number:		+.46724650796
Date:		18-Oct-2022

No responsibility will be accepted by TÜV SÜD as to the accuracy of the information declared in this document by the manufacturer.

1.6 PRODUCT INFORMATION

1.6.1 Technical Description

The Equipment Under Test (EUT) Radio 4480 44B2/B25 44B66A C - KRC 161 844/3 is an Ericsson AB Radio Unit working in the public mobile service Band 2 band which provides communication connections to Band 2 network.

The EUT is declared as operating from a nominal -48V DC supply.

The Equipment Under Test (EUT) is shown in the photograph below. A full technical description can be found in the Manufacturer's documentation.

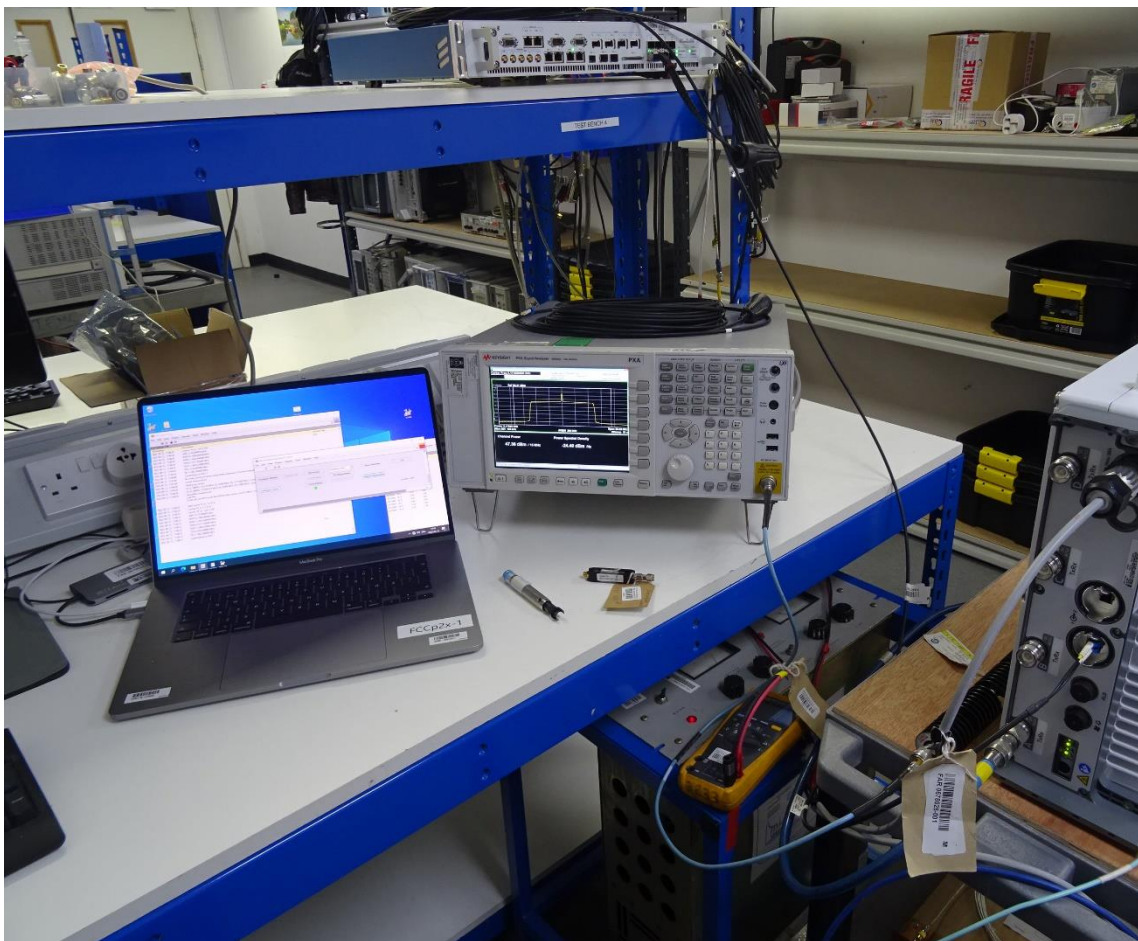

Equipment Under Test

1.7 TEST SETUP

Conducted Test Set Up

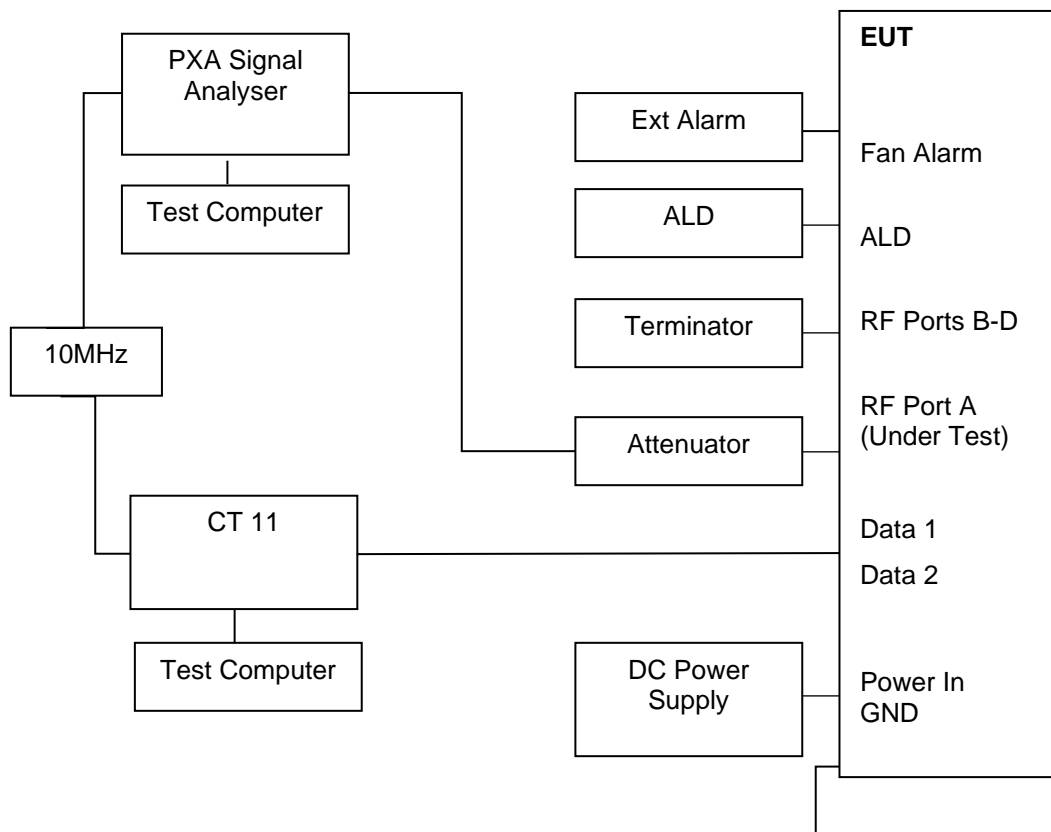



Radiated Test Set Up – Dashed line indicates equipment inside the Chamber for Radiated testing.

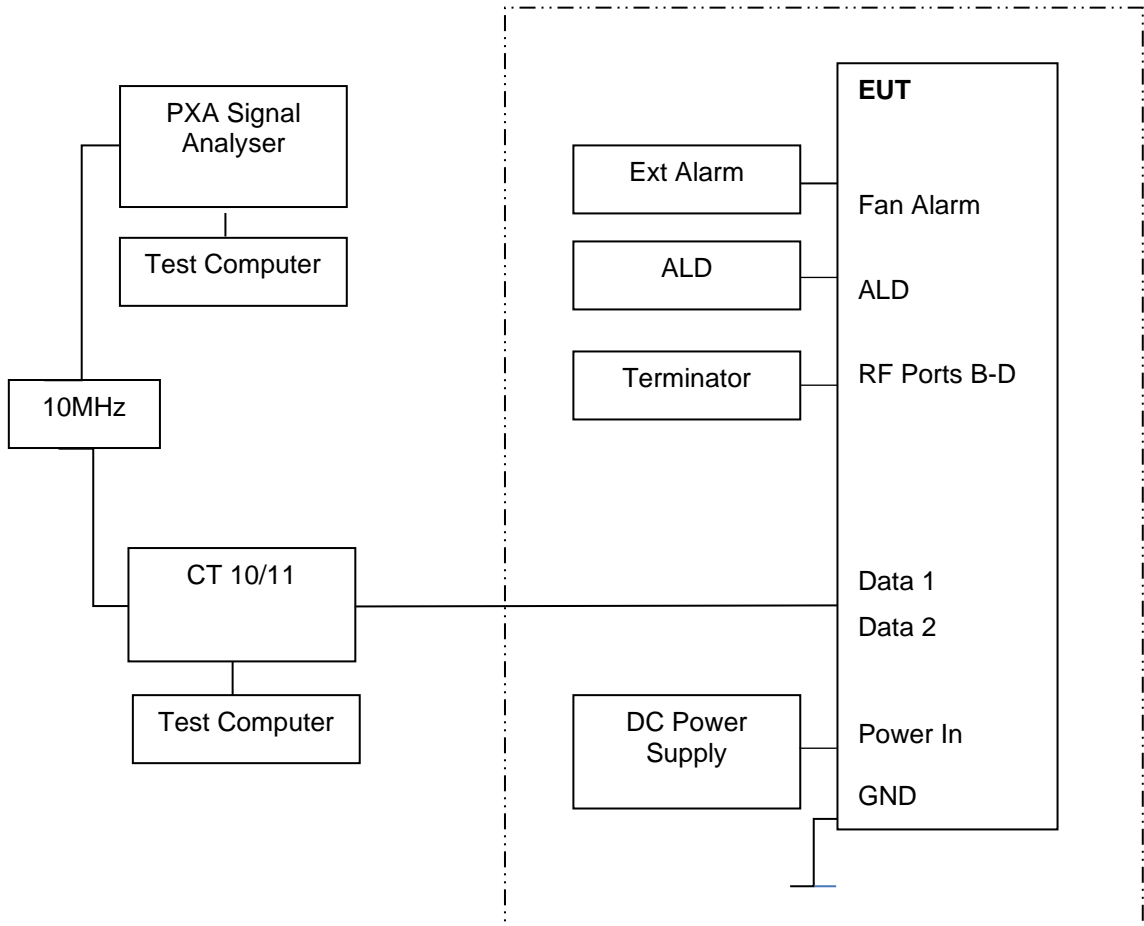



1.8 TEST CONDITIONS

For all tests the EUT was set up in accordance with the relevant test standard and to represent typical operating conditions. Tests were applied with the EUT situated as described in the Test Method for each Test.

The EUT was powered from a -48V DC supply unless otherwise stated.

FCC Measurement Facility Registration Number
90987 Octagon House, Fareham Test Laboratory
Postal Address: Octagon House, Concorde Way, Fareham, Hampshire, UK, PO15 5RL

ISED Accreditation
IC#12669A Octagon House, Fareham Test Laboratory
Postal Address: Octagon House, Concorde Way, Fareham, Hampshire, UK, PO15 5RL

Under our UKAS Accreditation, TÜV SÜD conducted the following tests Octagon House, Fareham Laboratory.

Test Name	Name of Engineer(s)
Maximum Peak Output Power and Peak to Average Ratio - Conducted	Neil Rousell
Occupied Bandwidth	Neil Rousell
Band Edge	Neil Rousell
Transmitter Spurious Emissions	Neil Rousell
Radiated Emissions	Graeme Lawler

1.9 DEVIATION FROM THE STANDARD

No deviations from the applicable test standards or test plan were made during testing.

1.10 MODIFICATION RECORD

No modifications were made to the EUT during testing.



1.11 ADDITIONAL INFORMATION

This filing is for a Class 2 Permissive change to add NR with NB-IoT to a previously certified Radio for use in the USA and Canada under the following ID's:

FCC: TA8AKRC161844
IC: 287AB-AS161844

This device is electrically identical as originally certified as no hardware changes have been made

Frequency Stability has been verified at time of original certification.

NEBS variant, The difference between KRC 161 844/1 and KRC 161 844/3 is a thicker casing on the filter unit on KRC 161 844/3 to fulfill NEBS requirements. The thickness is on the large surface outwards making the radio a little deeper. They are electrically identical, and the cavities are identical. Ericsson regards that this difference does not affect RF performance

This EUT uses the same port for Tx and Rx and therefore RX Spurious Emissions has not been performed. Rx Spurious Emissions have been covered by testing to FCC Part 15B, which are covered by a separate test report.

Throughout this report the power unit dBm is used. dBm is a unit of level used to indicate that a power level is expressed in decibels (dB) with reference to one milliwatt (mW). It is used as a convenient measure of absolute power because of its capability to express both very large and very small values in a short form.



SECTION 2

TEST DETAILS



2.1 MAXIMUM PEAK OUTPUT POWER AND PEAK TO AVERAGE RATIO - CONDUCTED

2.1.1 Specification Reference

FCC CFR 47 Part 24, Clause 24.232
 Industry Canada RSS-133, Clause 6.4
 FCC CFR 47 Part 2, Clause 2.1046

2.1.2 Date of Test and Modification State

04-October-2022 - Modification State 0

2.1.3 Test Equipment Used

The major items of test equipment used for the above tests are identified in Section 3.1.

2.1.4 Environmental Conditions

Ambient Temperature 22.7°C
 Relative Humidity 50.2%

2.1.5 Test Method

All measurements were made in accordance with FCC KDB 971168 D01, clause 5.2.1 and summed in accordance with FCC KDB 662911 D01.

2.1.6 Test Results

Configuration 1

Maximum Output Power 47.78 dBm

Antenna	NR Modulation	NR Carrier Bandwidth	Peak to Average Ratio (PAR) / Output Power / PSD						
			Channel Position B						
			PAR (dB)	Average Power/PSD		Total Power Port A+B+C+D		G _{ANT} * Limit 62.15dB	G _{ANT} * Limit 65.15dB
				dBm	dBm/MHz	dBm	dBm/MHz	dBi	dBi
A	QPSK	10.0 MHz 15 kHz SCS	7.46	47.23	39.07	53.25	45.09	17.06	20.06
A	QPSK	15.0 MHz 15 kHz SCS	7.65	47.18	38.56	53.20	44.58	17.57	20.57
A	QPSK	20.0 MHz 15 kHz SCS	7.76	47.31	38.36	53.33	44.38	17.77	20.77

Remarks

Calculations:

Total Power = Measured Output Power (port A, worst case) + 10log (NANT)

Where NANT refers to the number of Ports.

* Maximum antenna system gain (including cable loss), GANT (dBi) 50 ohm, for the tested configurations, to comply with Maximum radiated output power in ISED SRSP-510, calculated using measured and summed PSD for all 4 ports.



Antenna A - NR Modulation QPSK - NR Carrier Bandwidth 10.0 MHz 15 kHz SCS - Channel Position B

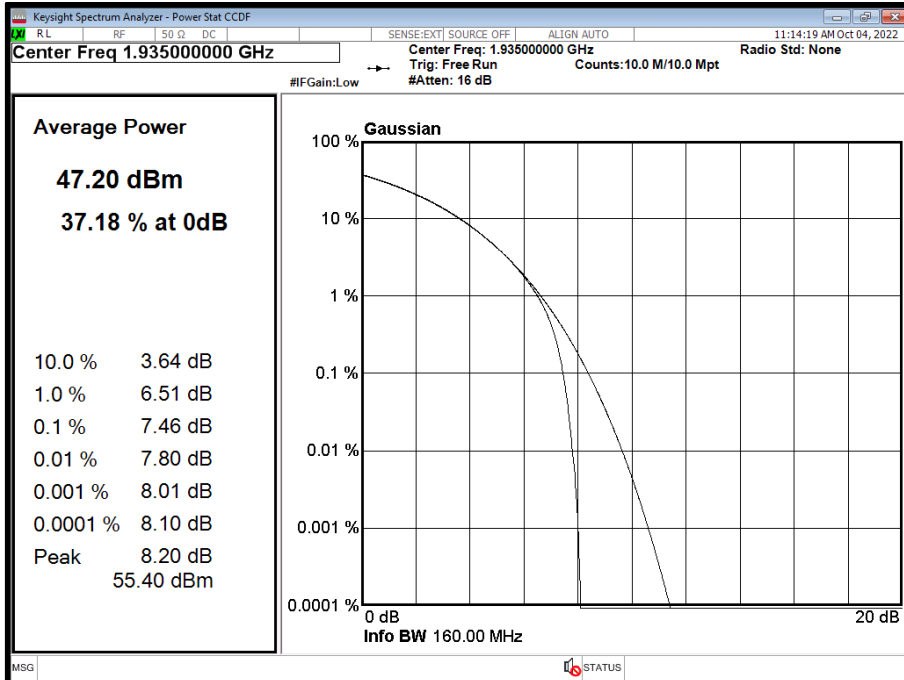

Antenna A - NR Modulation QPSK - NR Carrier Bandwidth 15.0 MHz 15 kHz SCS - Channel Position B

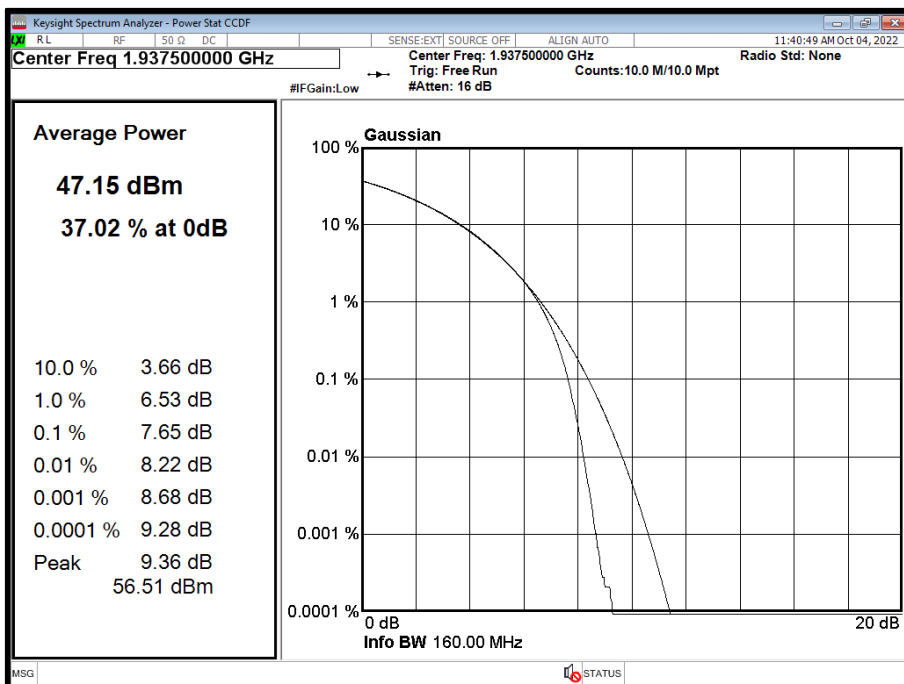



Antenna A - NR Modulation QPSK - NR Carrier Bandwidth 20.0 MHz 15 kHz SCS - Channel Position B

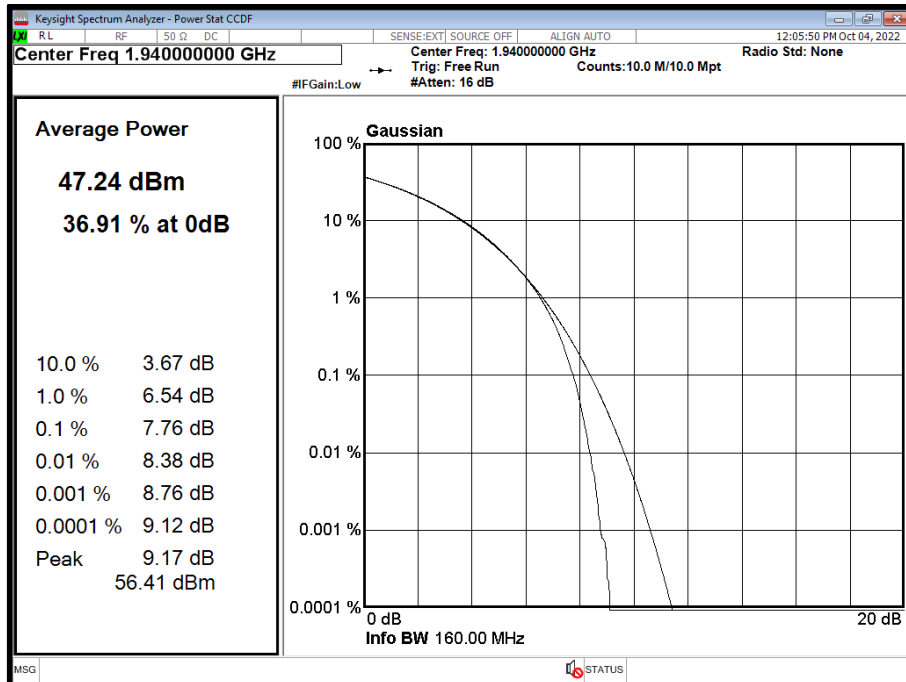

Configuration 1

Maximum Output Power 47.78 dBm

Antenna	NR Modulation	NR Carrier Bandwidth	Peak to Average Ratio (PAR) / Output Power / PSD						
			Channel Position M						
			PAR (dB)	Average Power/PSD		Total Power Port A+B+C+D		G _{ANT} * Limit 62.15dB	G _{ANT} * Limit 65.15dB
			dBm	dBm/MHz	dBm	dBm/MHz	dBi	dBi	
A	QPSK	10.0 MHz 15 kHz SCS	7.35	47.60	38.97	53.62	44.99	17.16	20.16
A	QPSK	15.0 MHz 15 kHz SCS	7.43	47.55	38.54	53.57	44.56	17.59	20.59
A	QPSK	20.0 MHz 15 kHz SCS	7.37	47.54	38.30	53.56	44.32	17.83	20.83

Remarks

Calculations:

Total Power = Measured Output Power (port A, worst case) + 10log (NANT)

Where NANT refers to the number of Ports.

* Maximum antenna system gain (including cable loss), GANT (dBi) 50 ohm, for the tested configurations, to comply with Maximum radiated output power in ISED SRSP-510, calculated using measured and summed PSD for all 4 ports.



Antenna A - NR Modulation QPSK - NR Carrier Bandwidth 10.0 MHz 15 kHz SCS - Channel Position M

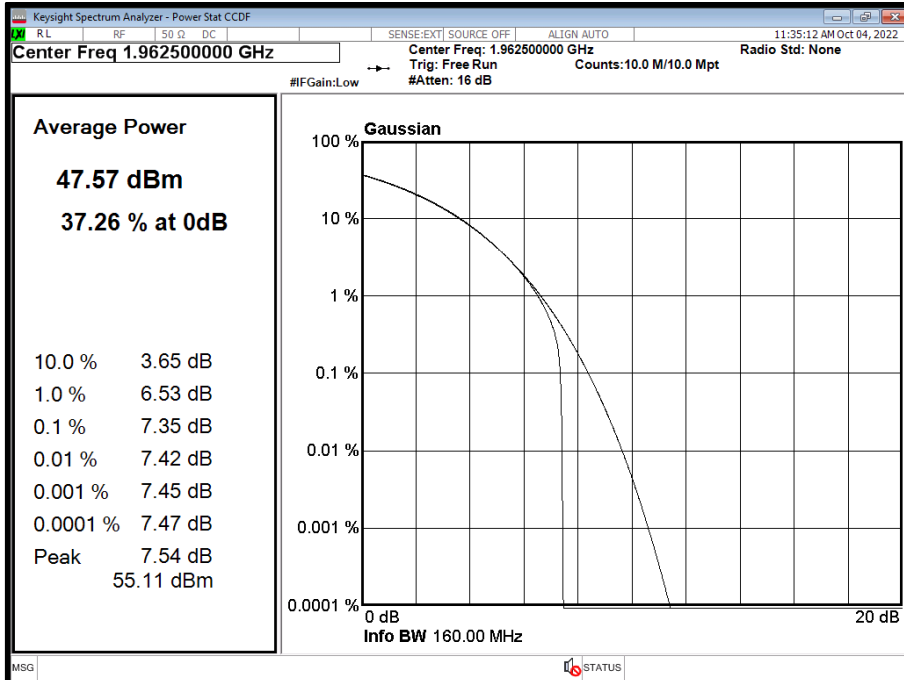

Antenna A - NR Modulation QPSK - NR Carrier Bandwidth 15.0 MHz 15 kHz SCS - Channel Position M

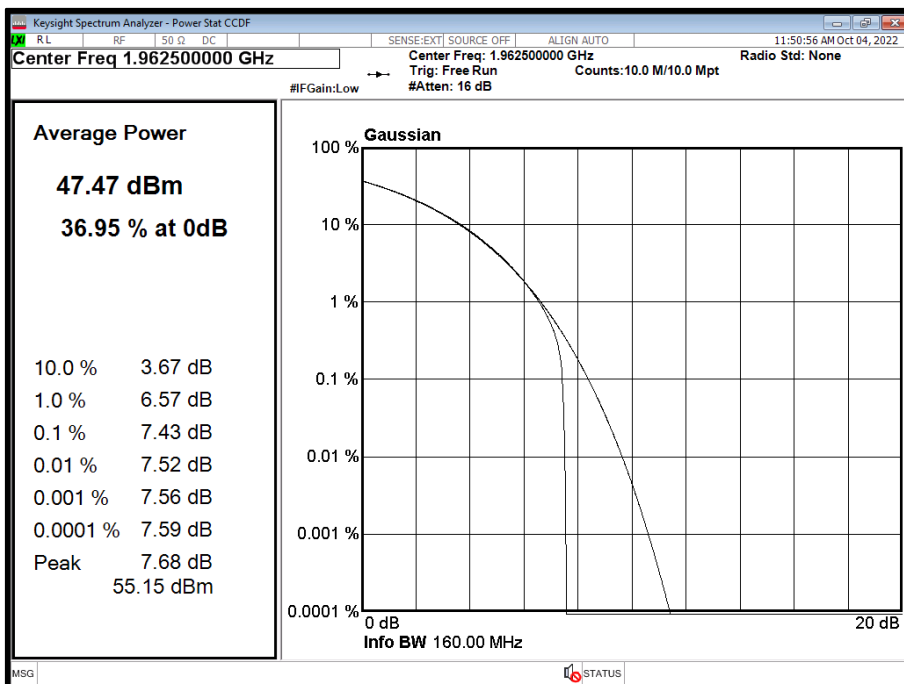



Antenna A - NR Modulation QPSK - NR Carrier Bandwidth 20.0 MHz 15 kHz SCS - Channel Position M

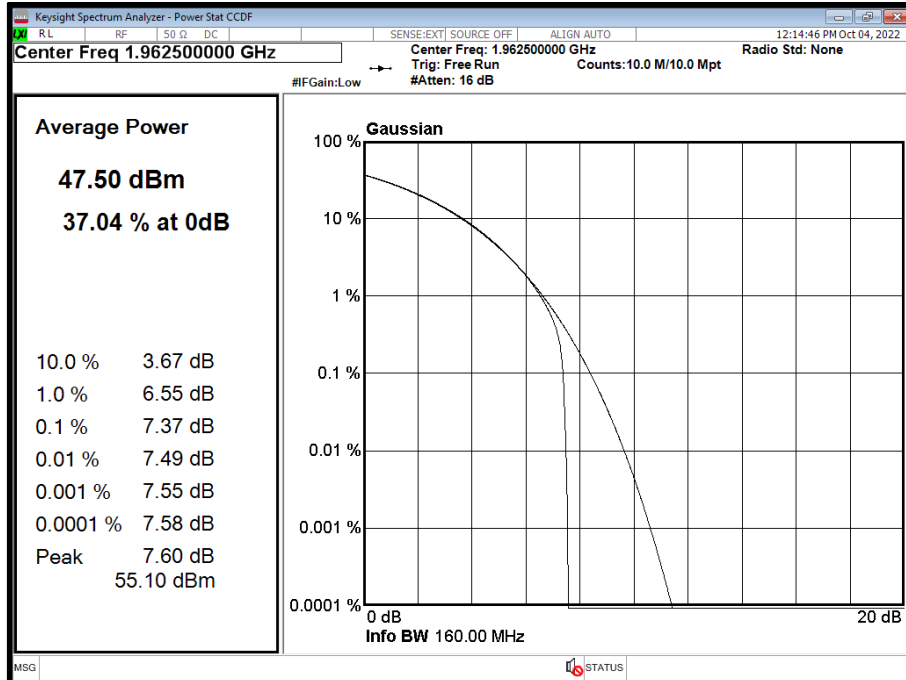

Configuration 1

Maximum Output Power 47.78 dBm

Antenna	NR Modulation	NR Carrier Bandwidth	Peak to Average Ratio (PAR) / Output Power / PSD						
			Channel Position T						
			PAR (dB)	Average Power/PSD		Total Power Port A+B+C+D		G _{ANT} * Limit 62.15dB	G _{ANT} * Limit 65.15dB
			dBm	dBm/MHz	dBm	dBm/MHz	dBi	dBi	
A	QPSK	10.0 MHz 15 kHz SCS	7.38	47.43	39.05	53.45	45.07	17.08	20.08
A	QPSK	15.0 MHz 15 kHz SCS	7.45	47.49	38.55	53.51	44.57	17.58	20.58
A	QPSK	20.0 MHz 15 kHz SCS	7.47	47.51	38.37	53.53	44.39	17.76	20.76

Remarks

Calculations:

Total Power = Measured Output Power (port A, worst case) + 10log (NANT)

Where NANT refers to the number of Ports.

* Maximum antenna system gain (including cable loss), GANT (dBi) 50 ohm, for the tested configurations, to comply with Maximum radiated output power in ISED SRSP-510, calculated using measured and summed PSD for all 4 ports.



Antenna A - NR Modulation QPSK - NR Carrier Bandwidth 10.0 MHz 15 kHz SCS - Channel Position T

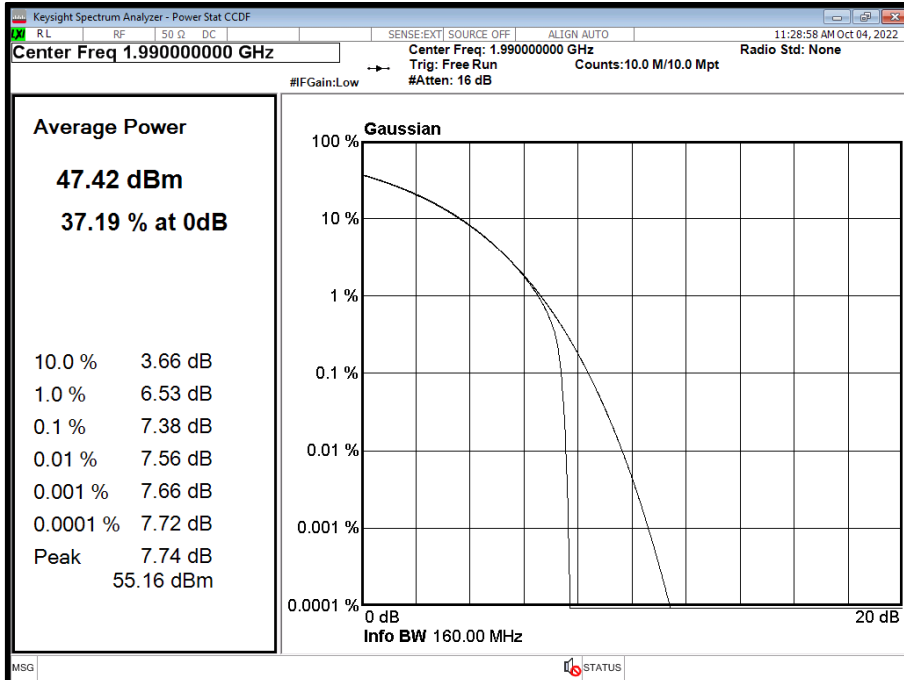

Antenna A - NR Modulation QPSK - NR Carrier Bandwidth 15.0 MHz 15 kHz SCS - Channel Position T

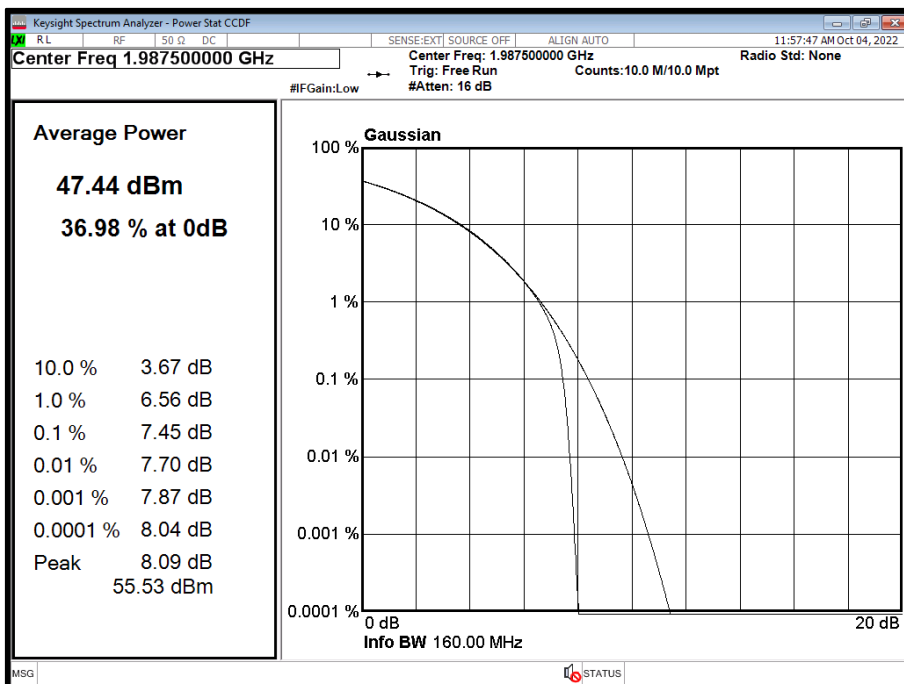



Antenna A - NR Modulation QPSK - NR Carrier Bandwidth 20.0 MHz 15 kHz SCS - Channel Position T

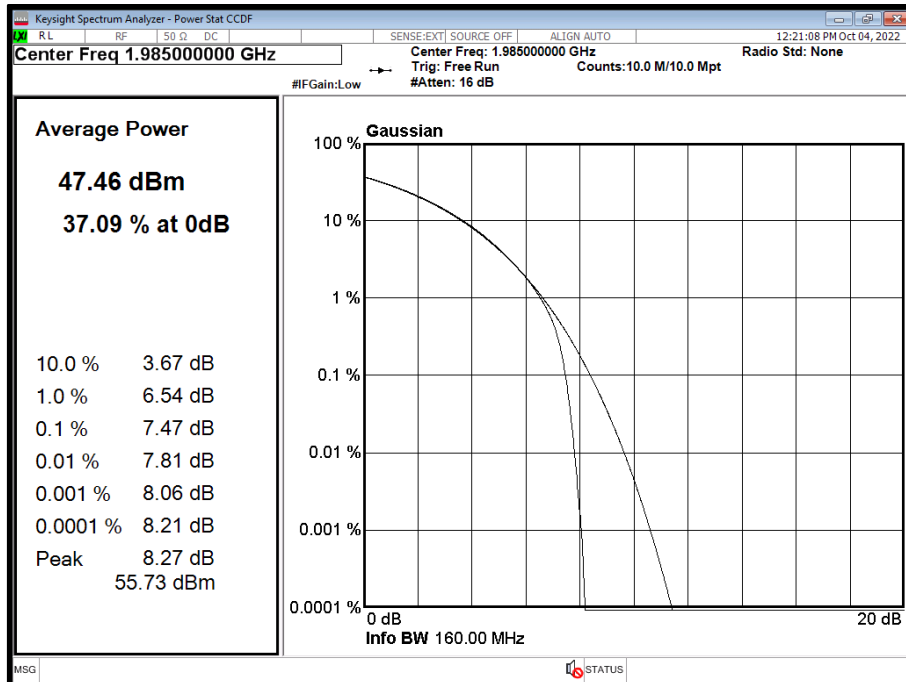

Configuration 2

Maximum Output Power 47.78 dBm

Antenna	NR Modulation	NR Carrier Bandwidth	Peak to Average Ratio (PAR) / Output Power / PSD						
			Channel Position T						
			PAR (dB)	Average Power/PSD		Total Power Port A+B+C+D		G _{ANT} * Limit 62.15dB	G _{ANT} * Limit 65.15dB
			dBm	dBm/MHz	dBm	dBm/MHz	dBi	dBi	
A	QPSK	10.0 MHz 15 kHz SCS	7.35	47.51	39.04	53.53	45.06	17.09	20.09
A	QPSK	15.0 MHz 15 kHz SCS	7.44	47.45	38.39	53.47	44.41	17.74	20.74
A	QPSK	20.0 MHz 15 kHz SCS	7.39	47.61	38.34	53.63	44.36	17.79	20.79

Remarks

Calculations:

Total Power = Measured Output Power (port A, worst case) + 10log (NANT)
 Where NANT refers to the number of Ports.

* Maximum antenna system gain (including cable loss), GANT (dBi) 50 ohm, for the tested configurations, to comply with Maximum radiated output power in ISED SRSP-510, calculated using measured and summed PSD for all 4 ports.



Antenna A - NR Modulation QPSK - NR Carrier Bandwidth 10.0 MHz 15 kHz SCS - Channel Position B

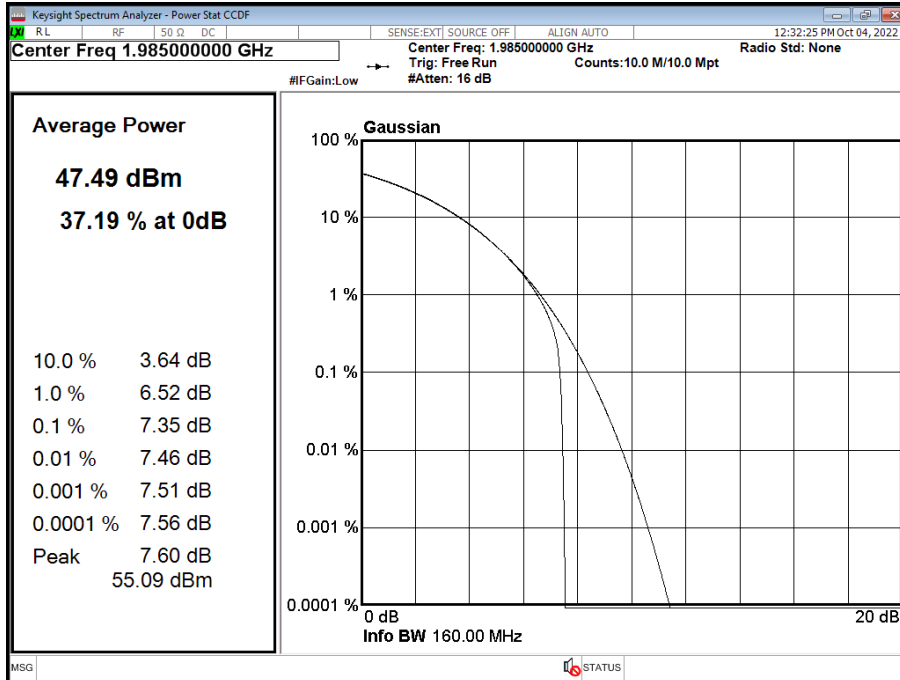

Antenna A - NR Modulation QPSK - NR Carrier Bandwidth 15.0 MHz 15 kHz SCS - Channel Position B

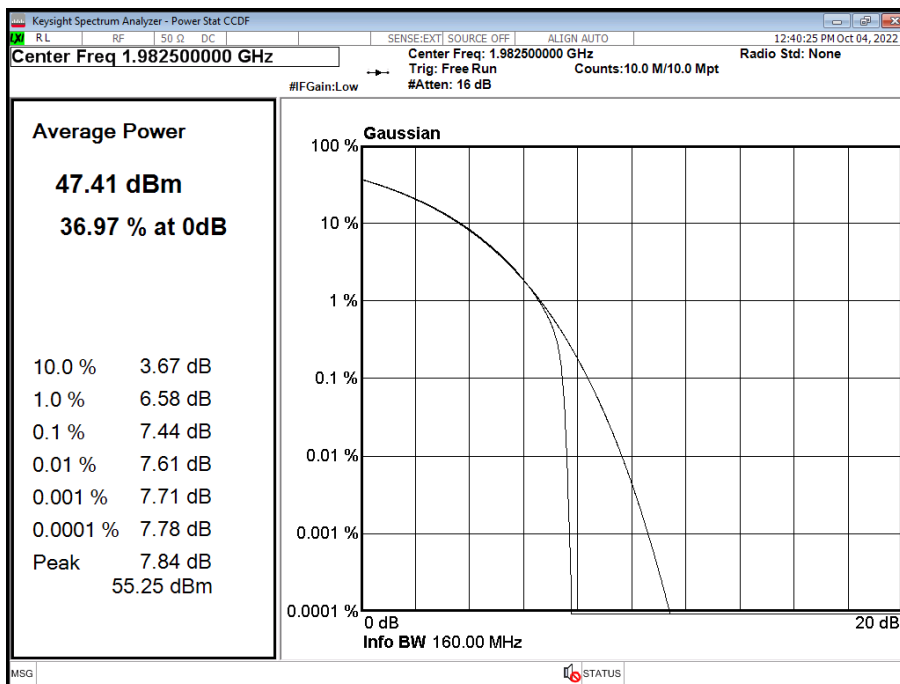



Antenna A - NR Modulation QPSK - NR Carrier Bandwidth 20.0 MHz 15 kHz SCS - Channel Position B

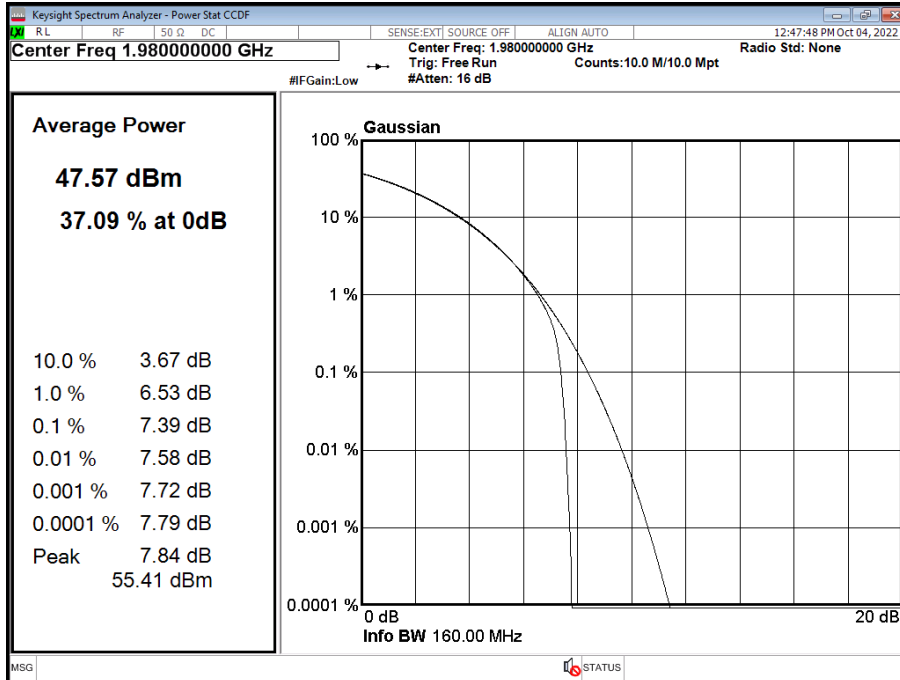

FCC Part 24.232 Clauses (a) & (b)

Limit	
Maximum ERP (Urban)	$\leq 1640 \text{ W}$ or $\leq +62.15 \text{ dBm}$ (antenna height $\leq 300\text{m}$) $\leq 1070 \text{ W}$ or $\leq +60.30 \text{ dBm}$ (antenna height $\leq 500\text{m}$) $\leq 490 \text{ W}$ or $\leq +56.90 \text{ dBm}$ (antenna height $\leq 1000\text{m}$) $\leq 270 \text{ W}$ or $\leq +54.31 \text{ dBm}$ (antenna height $\leq 1500\text{m}$) $\leq 160 \text{ W}$ or $\leq +52.04 \text{ dBm}$ (antenna height $\leq 2000\text{m}$)
Maximum ERP (Non-Urban)	$\leq 3280 \text{ W}$ or $\leq +65.15 \text{ dBm}$ (antenna height $\leq 300\text{m}$) $\leq 2140 \text{ W}$ or $\leq +63.30 \text{ dBm}$ (antenna height $\leq 500\text{m}$) $\leq 980 \text{ W}$ or $\leq +59.91 \text{ dBm}$ (antenna height $\leq 1000\text{m}$) $\leq 540 \text{ W}$ or $\leq +57.32 \text{ dBm}$ (antenna height $\leq 1500\text{m}$) $\leq 320 \text{ W}$ or $\leq +55.05 \text{ dBm}$ (antenna height $\leq 2000\text{m}$)

RSS-133 Clause 6.4

Limit	
Peak to Average Ratio	13 dB



SRSP-510 Power and Antenna Height Limitations Clause 5.1.1 & 5.1.2

Limit	
Maximum EIRP (Non-Urban)	≤ 3280 W/MHz or $\leq +65.15$ dBm
Maximum EIRP (Urban)	≤ 1640 W/MHz or $\leq +62.15$ dBm (antenna height ≤ 300 m)
	≤ 1070 W/MHz or $\leq +60.30$ dBm (antenna height ≤ 500 m)
	≤ 490 W/MHz or $\leq +56.90$ dBm (antenna height ≤ 1000 m)
	≤ 270 W/MHz or $\leq +54.31$ dBm (antenna height ≤ 1500 m)
	≤ 160 W/MHz or $\leq +52.04$ dBm (antenna height ≤ 2000 m)



2.2 OCCUPIED BANDWIDTH

2.2.1 Specification Reference

FCC CFR 47 Part 24, Clause 24.238 (b)
ISED RSS-GEN, Clause 6.7
FCC CFR 47 Part 2, Clause 2.1049

2.2.2 Date of Test and Modification State

04-October-2022 - Modification State 0

2.2.3 Test Equipment Used

The major items of test equipment used for the above tests are identified in Section 3.1.

2.2.4 Environmental Conditions

Ambient Temperature	22.7°C
Relative Humidity	50.2%

2.2.5 Test Method

All measurements were made in accordance with FCC KDB 971168 D01, Clause 4.2 and 4.3. The Spectrum Analyser RBW was configured to be at least 1% of the channel bandwidth of the carrier to be measured.

For 26 dB Bandwidth, in accordance with KDB 971168 D01, a peak detector and a trace setting of Max Hold were used. The trace was allowed to stabilise. Using the Spectrum Analyser function, the 26dB measurement result was obtained.

4.2 Occupied bandwidth – relative measurement procedure

The reference value is the highest level of the spectral envelope of the modulated signal, unless otherwise specified in an applicable rule section.

Subclause 5.4.3 of ANSI C63.26-2015 is applicable.

4.3 Occupied bandwidth – power bandwidth (99 %) measurement procedure

Subclause 5.4.4 of ANSI C63.26-2015 is applicable (wherein the recommendation is to use the 99 % power bandwidth function of a spectrum analyzer).

2.2.6 Test Results

Configuration 1

Maximum Output Power 47.78 dBm



Antenna	NR Modulation	NR Carrier Bandwidth	Result (kHz)					
			Channel Position B		Channel Position M		Channel Position T	
			Occupied Bandwidth	-26 dB Bandwidth	Occupied Bandwidth	-26 dB Bandwidth	Occupied Bandwidth	-26 dB Bandwidth
A	QPSK	10.0 MHz 15 kHz SCS	9434.09	9798.63	9438.42	9805.85	9446.61	9802.88
A	QPSK	15.0 MHz 15 kHz SCS	14365.28	14796.06	14365.04	14801.59	14366.14	14814.15
A	QPSK	20.0 MHz 15 kHz SCS	19180.29	19739.83	19185.60	19750.24	19184.95	19762.45

Antenna A - NR Modulation QPSK - NR Carrier Bandwidth 10.0 MHz 15 kHz SCS - Channel Position B

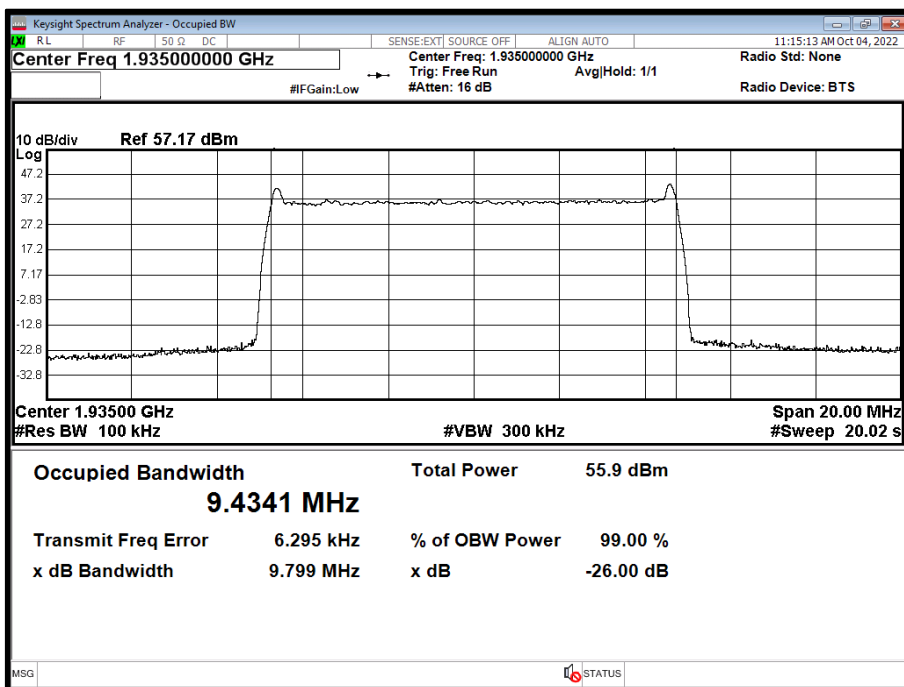



Antenna A - NR Modulation QPSK - NR Carrier Bandwidth 10.0 MHz 15 kHz SCS - Channel Position M

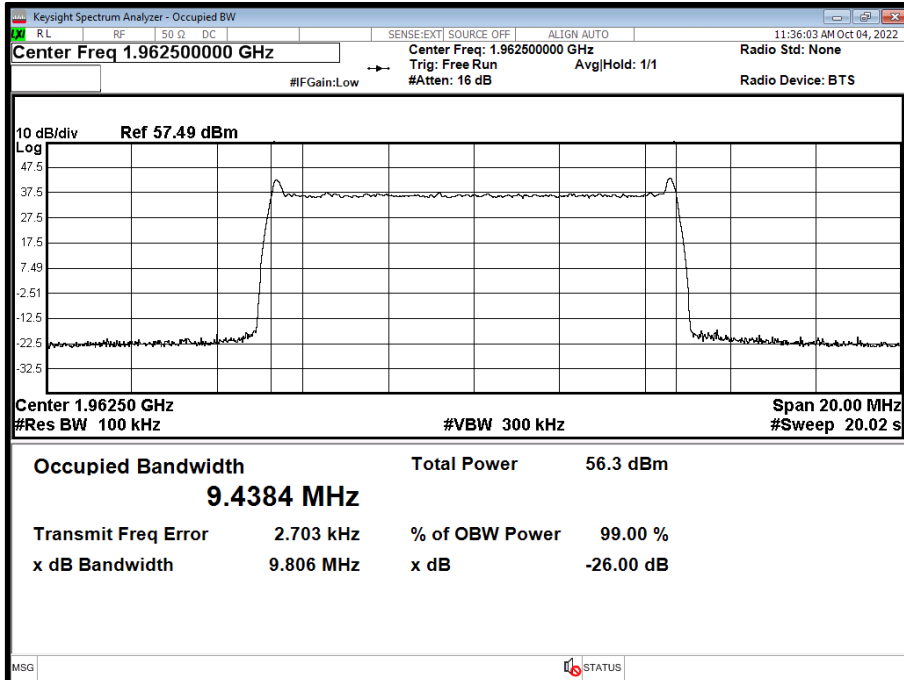

Antenna A - NR Modulation QPSK - NR Carrier Bandwidth 10.0 MHz 15 kHz SCS - Channel Position T

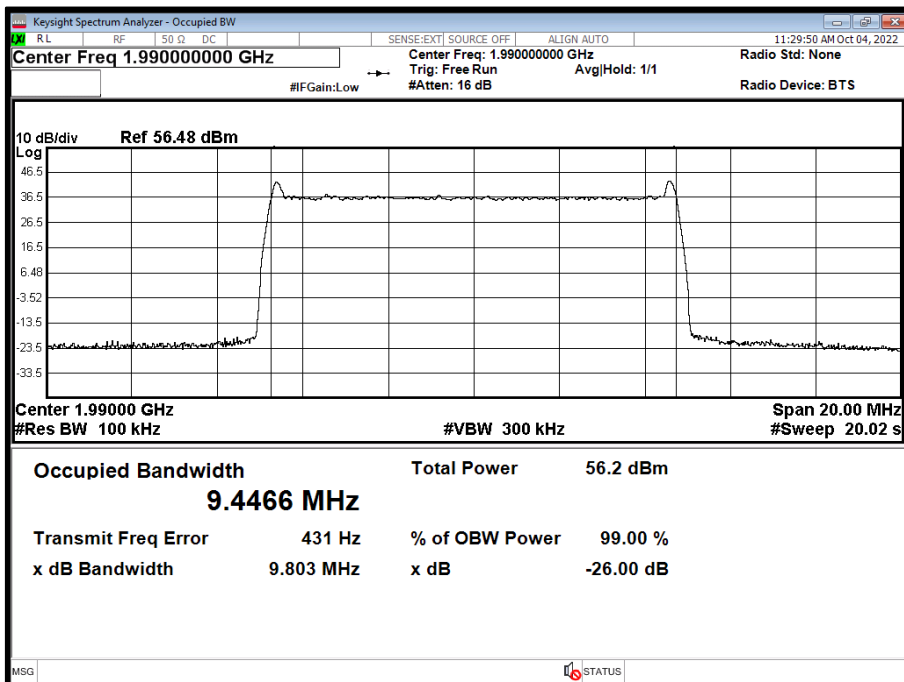



Antenna A - NR Modulation QPSK - NR Carrier Bandwidth 15.0 MHz 15 kHz SCS - Channel Position B

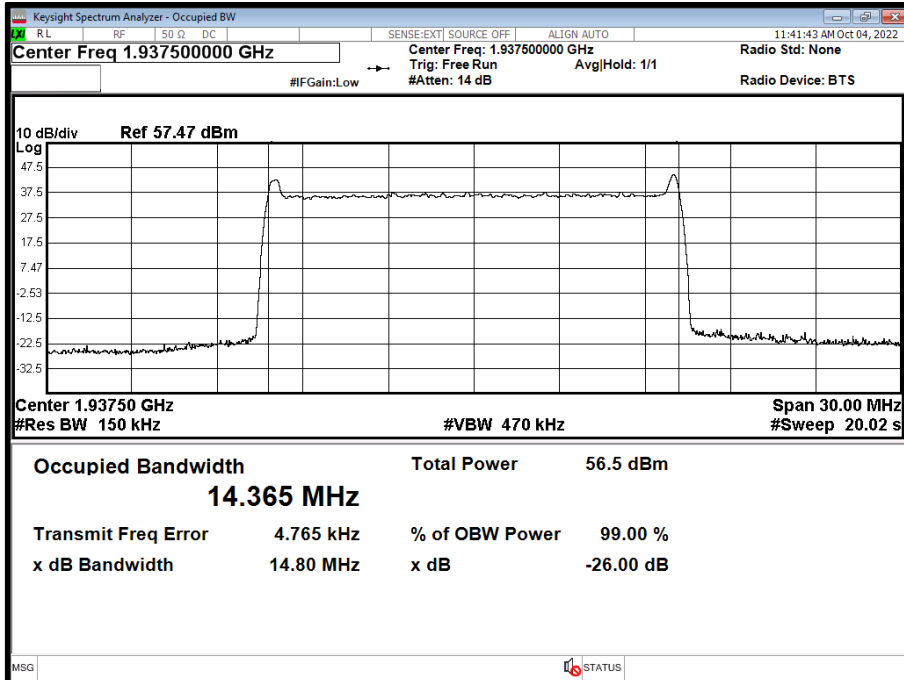

Antenna A - NR Modulation QPSK - NR Carrier Bandwidth 15.0 MHz 15 kHz SCS - Channel Position M

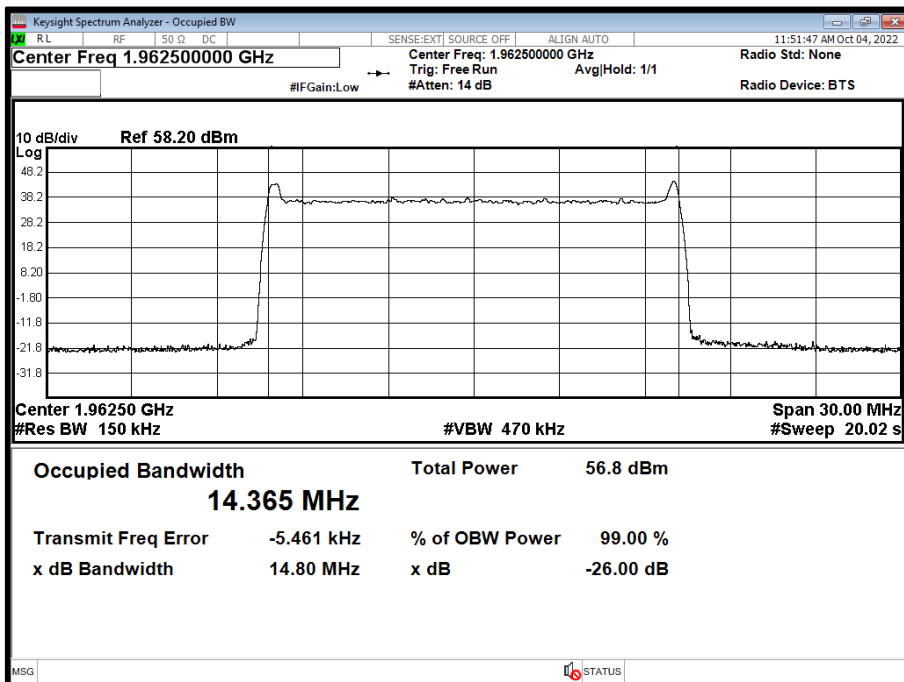



Antenna A - NR Modulation QPSK - NR Carrier Bandwidth 15.0 MHz 15 kHz SCS - Channel Position T

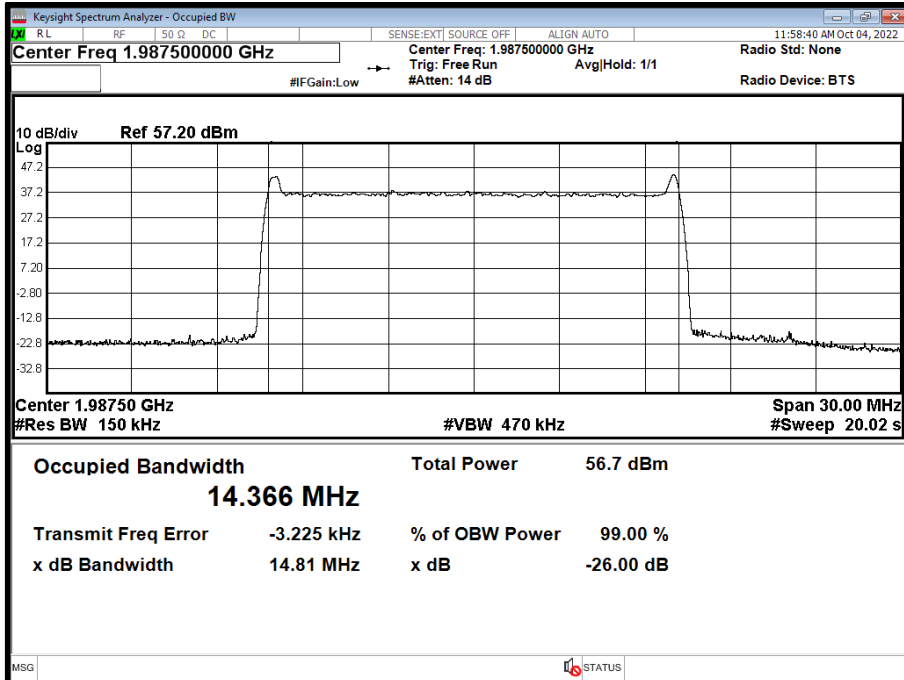

Antenna A - NR Modulation QPSK - NR Carrier Bandwidth 20.0 MHz 15 kHz SCS - Channel Position B

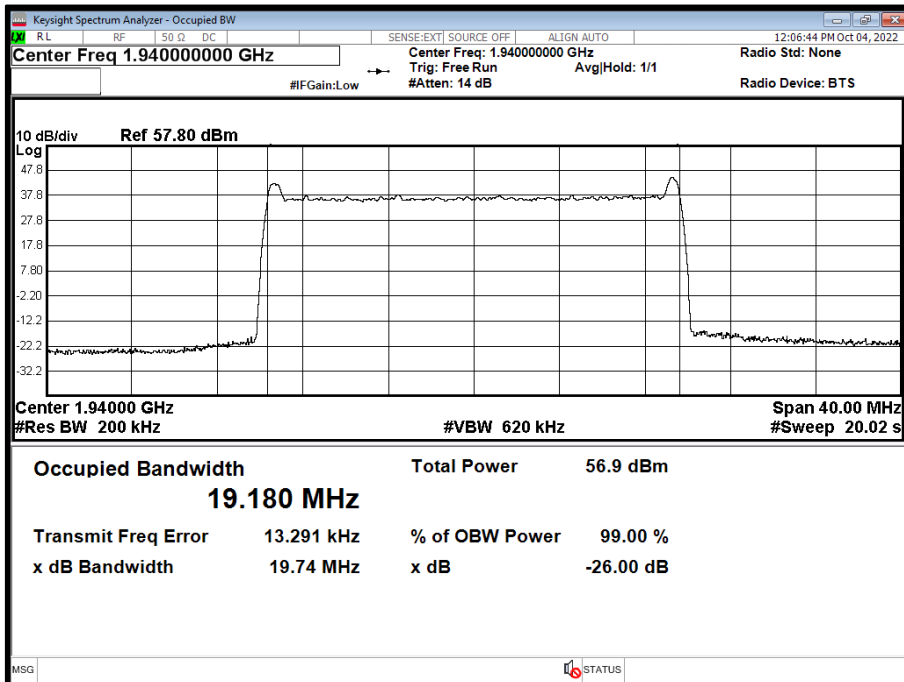



Antenna A - NR Modulation QPSK - NR Carrier Bandwidth 20.0 MHz 15 kHz SCS - Channel Position M

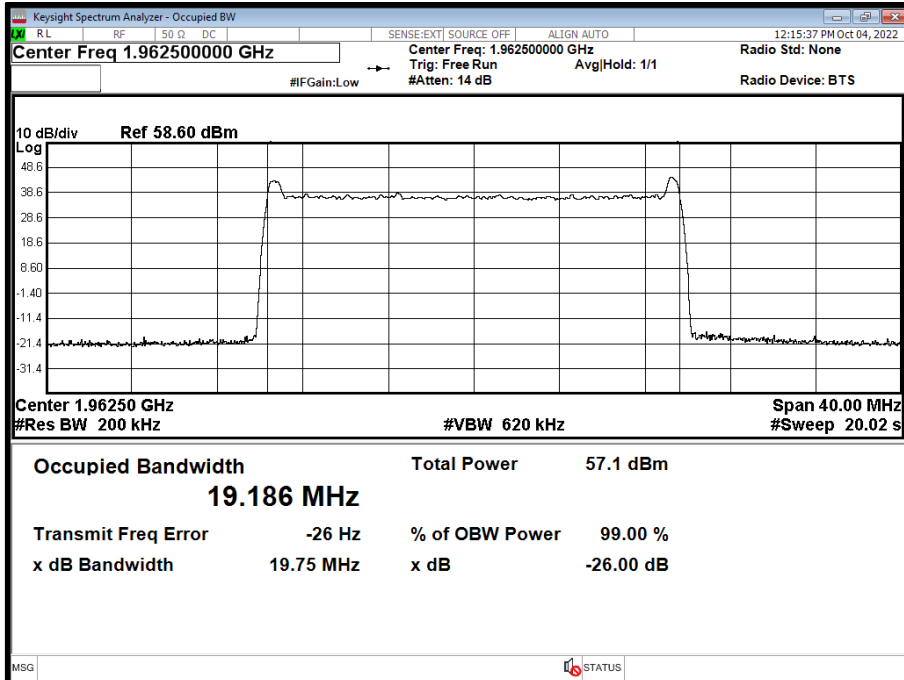

Antenna A - NR Modulation QPSK - NR Carrier Bandwidth 20.0 MHz 15 kHz SCS - Channel Position T

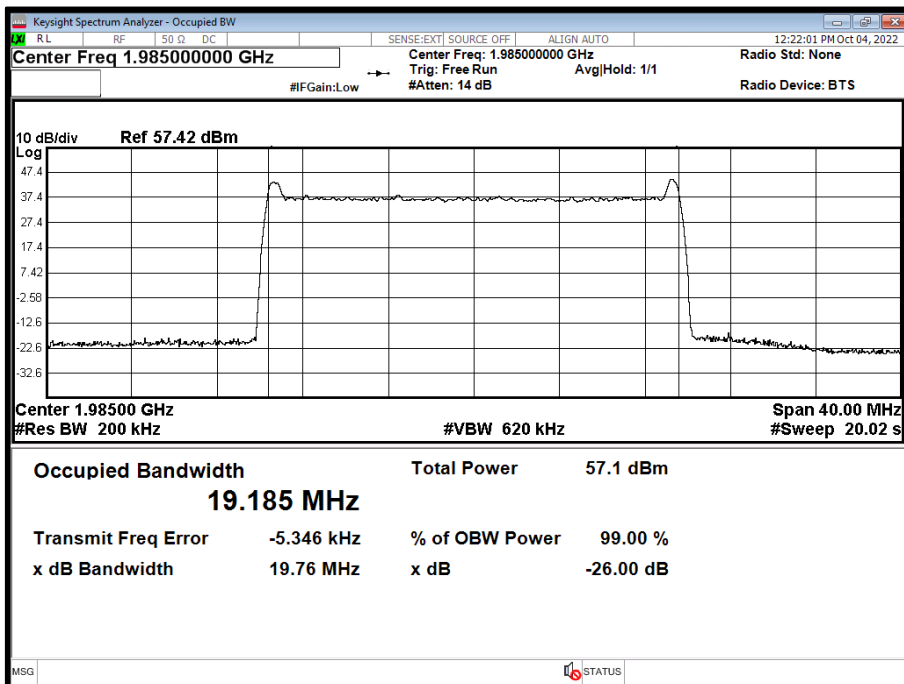



Configuration 2

Maximum Output Power 47.78 dBm

Antenna	NR Modulation	NR Carrier Bandwidth	Result (kHz)					
			Channel Position B		Channel Position M		Channel Position T	
			Occupied Bandwidth	-26 dB Bandwidth	Occupied Bandwidth	-26 dB Bandwidth	Occupied Bandwidth	-26 dB Bandwidth
A	QPSK	10.0 MHz 15 kHz SCS	9434.09	9798.63	9438.42	9805.85	9446.61	9802.88
A	QPSK	15.0 MHz 15 kHz SCS	14365.28	14796.06	14365.04	14801.59	14366.14	14814.15
A	QPSK	20.0 MHz 15 kHz SCS	19180.29	19739.83	19185.60	19750.24	19184.95	19762.45



Antenna A - NR Modulation QPSK - NR Carrier Bandwidth 10.0 MHz 15 kHz SCS - Channel Position B

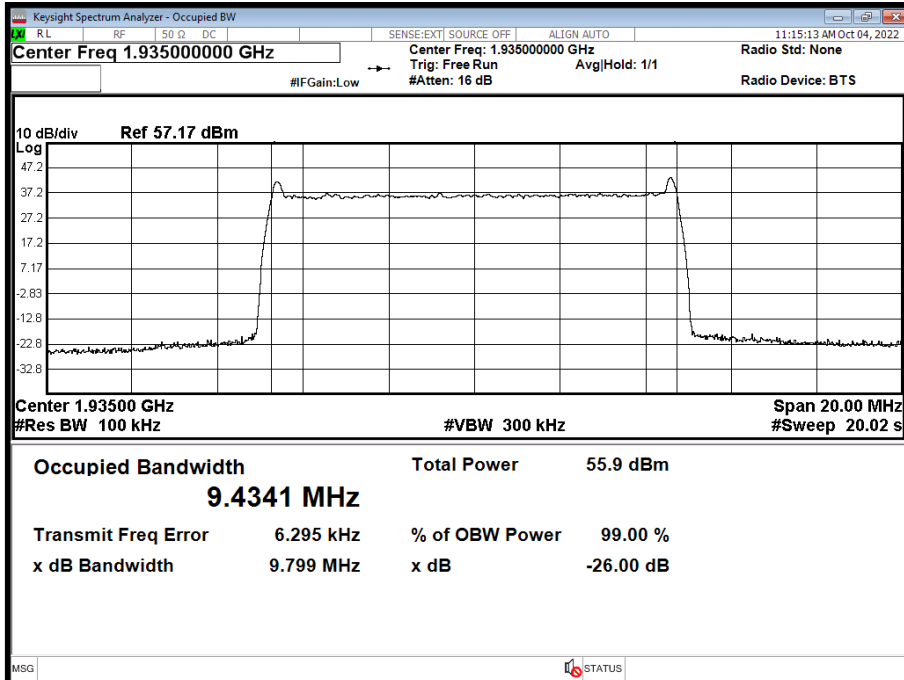

Antenna A - NR Modulation QPSK - NR Carrier Bandwidth 10.0 MHz 15 kHz SCS - Channel Position M

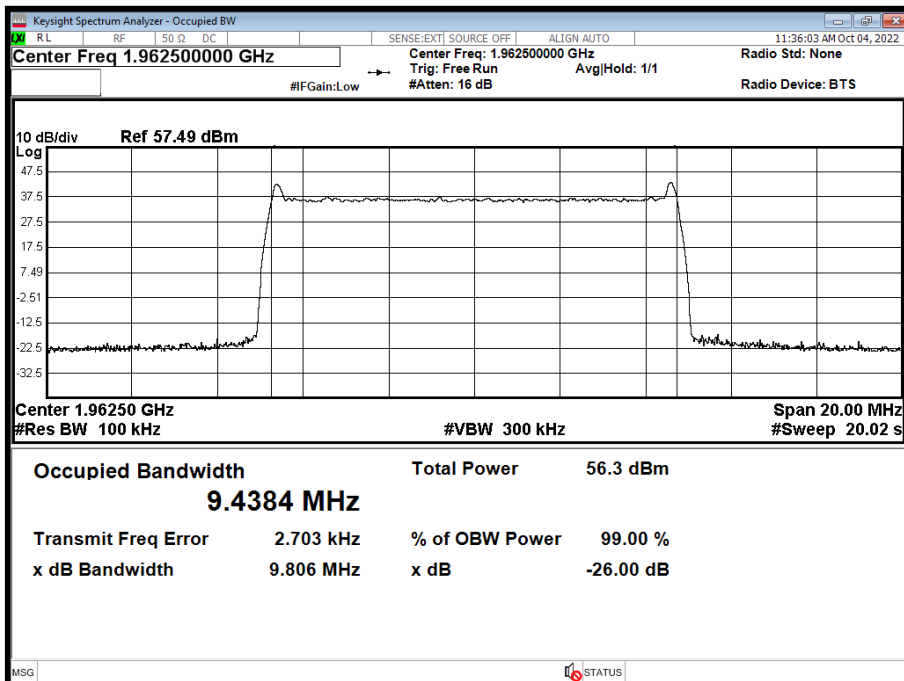



Antenna A - NR Modulation QPSK - NR Carrier Bandwidth 10.0 MHz 15 kHz SCS - Channel Position T

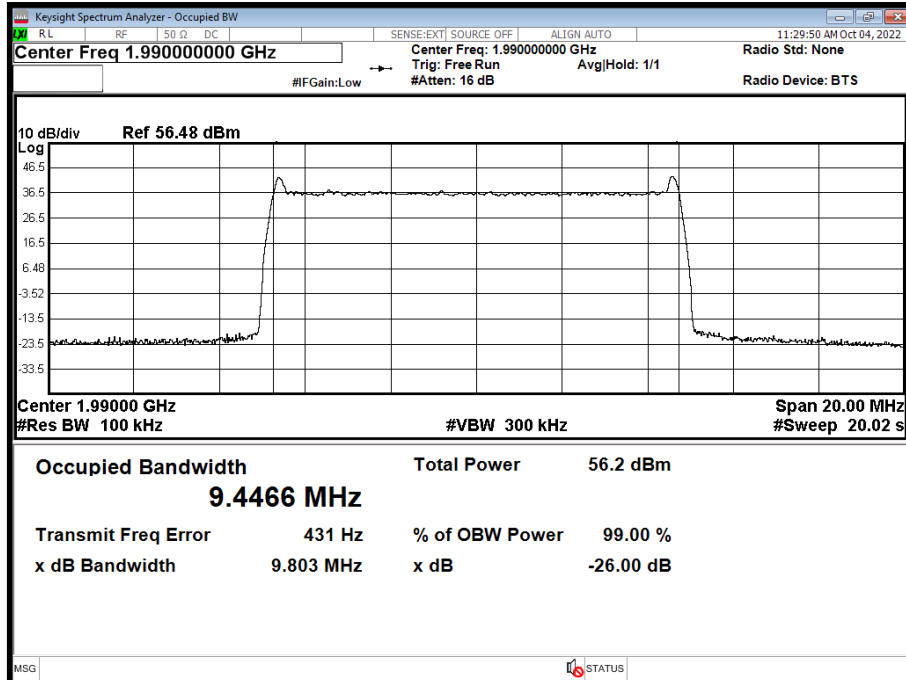

Antenna A - NR Modulation QPSK - NR Carrier Bandwidth 15.0 MHz 15 kHz SCS - Channel Position B

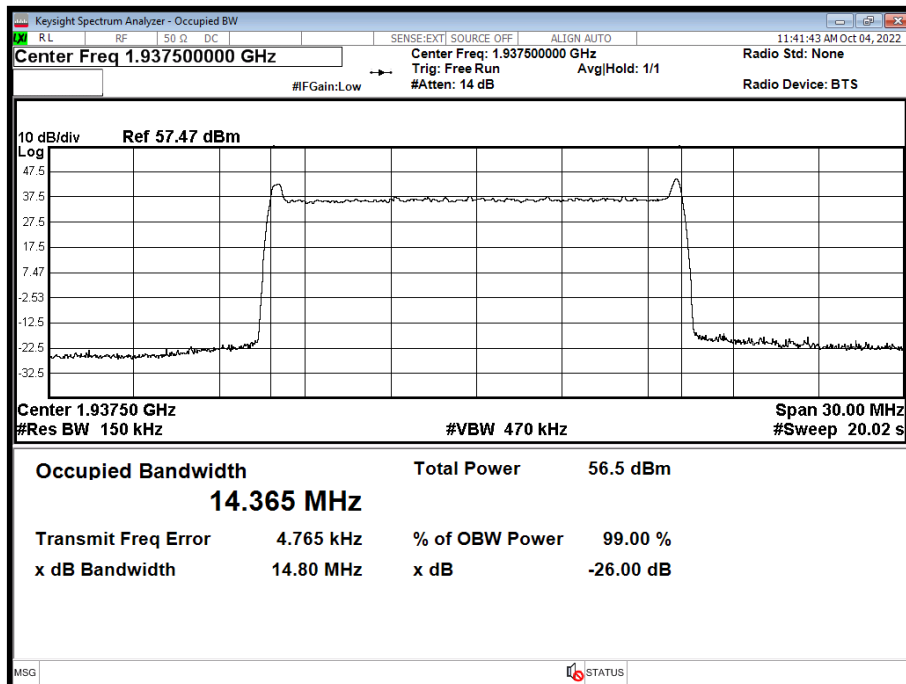



Antenna A - NR Modulation QPSK - NR Carrier Bandwidth 15.0 MHz 15 kHz SCS - Channel Position M

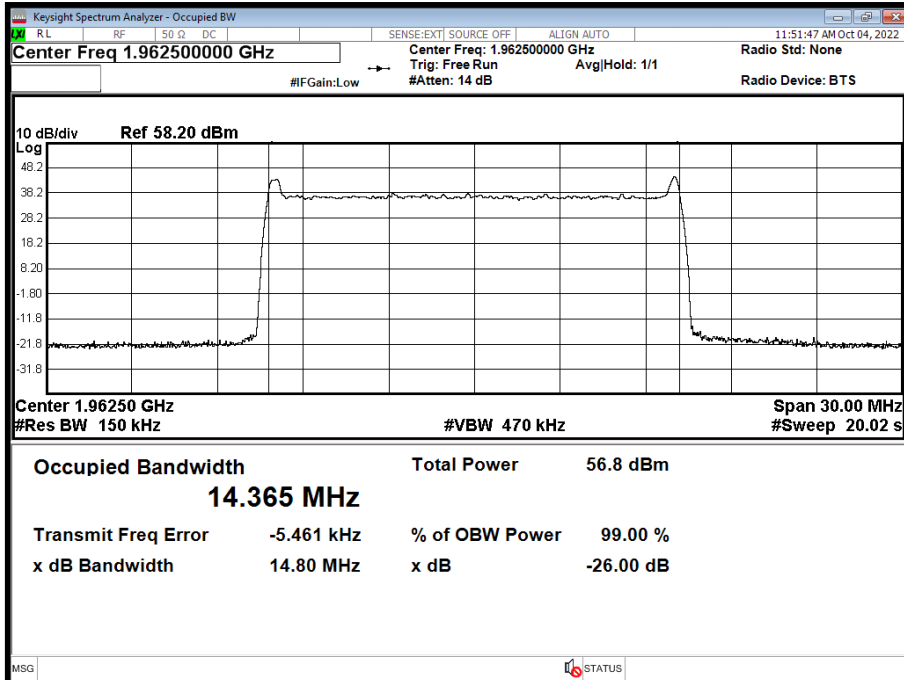

Antenna A - NR Modulation QPSK - NR Carrier Bandwidth 15.0 MHz 15 kHz SCS - Channel Position T

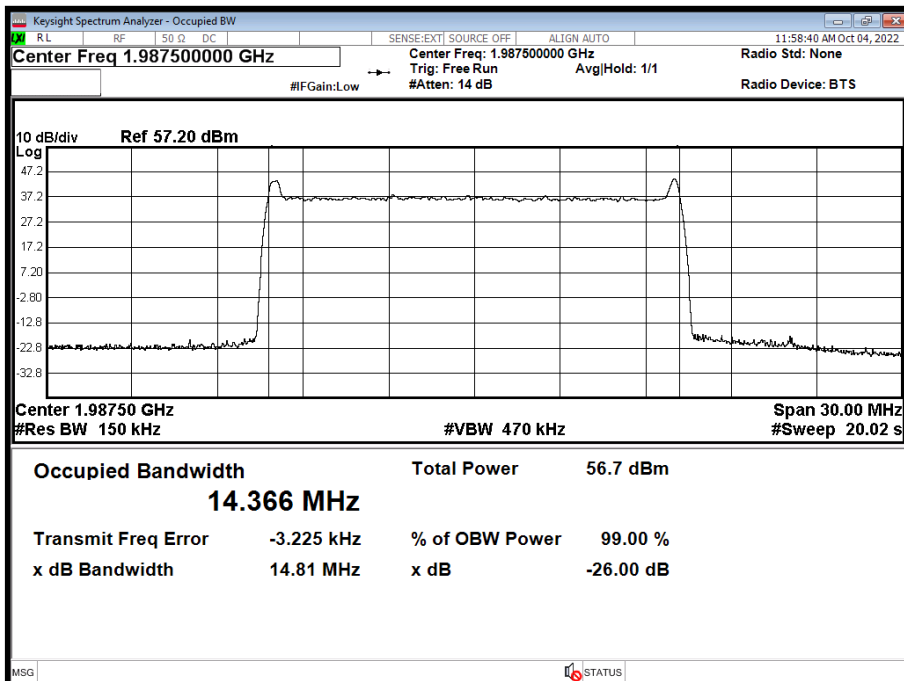



Antenna A - NR Modulation QPSK - NR Carrier Bandwidth 20.0 MHz 15 kHz SCS - Channel Position B

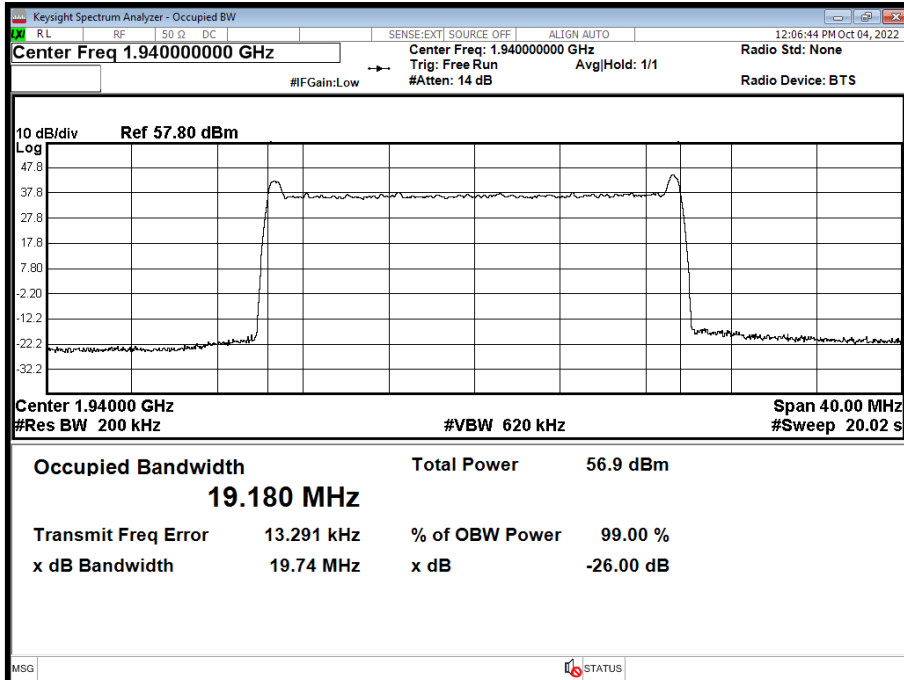

Antenna A - NR Modulation QPSK - NR Carrier Bandwidth 20.0 MHz 15 kHz SCS - Channel Position M

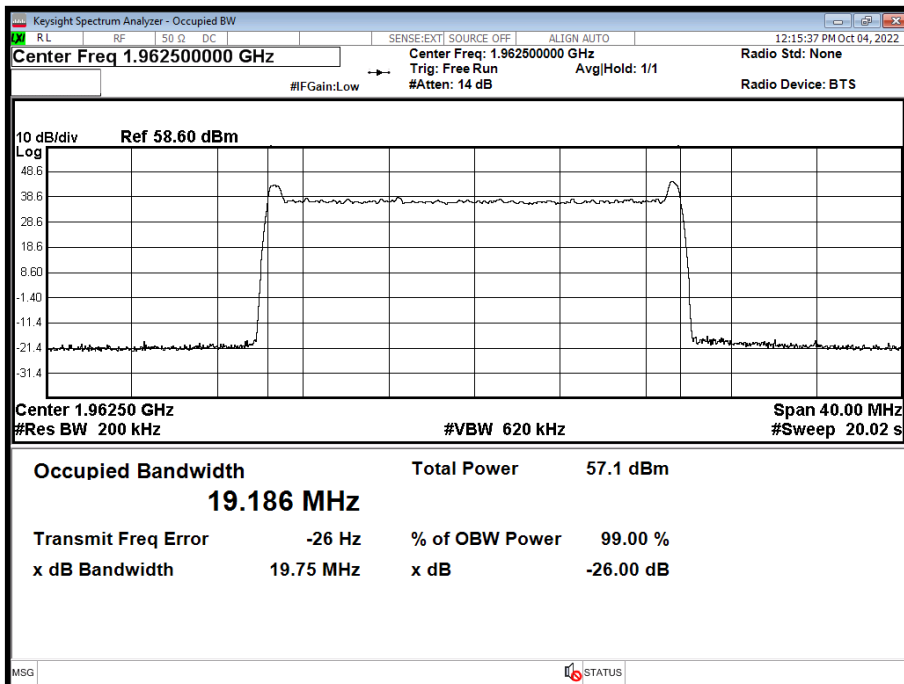



Antenna A - NR Modulation QPSK - NR Carrier Bandwidth 20.0 MHz 15 kHz SCS - Channel Position T

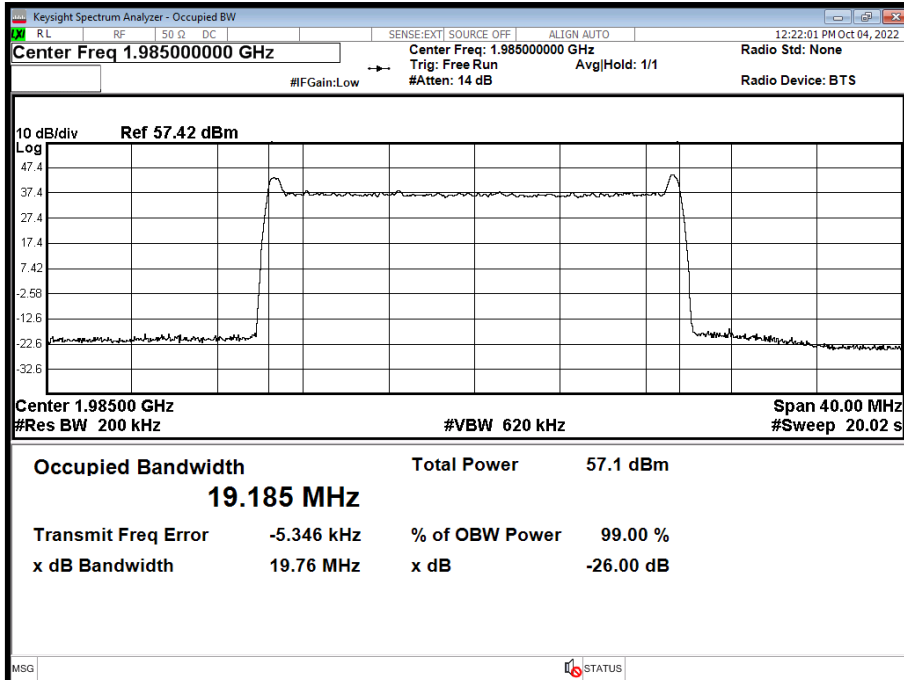



2.3 BAND EDGE

2.3.1 Specification Reference

FCC CFR 47 Part 24, Clause 24.238 (b)
Industry Canada RSS-133, Clause 6.5
FCC CFR 47 Part 2, Clause 2.1051

2.3.2 Date of Test and Modification State

04-October-2022 - Modification State 0

2.3.3 Test Equipment Used

The major items of test equipment used for the above tests are identified in Section 3.1.

2.3.4 Environmental Conditions

Ambient Temperature 22.7°C
Relative Humidity 50.2%

2.3.5 Test Method

All measurements were made in accordance with FCC KDB 971168 D01, Clause 6.0.

Band Edge measurements were used an Integration Bandwidth of at least 1% of the measured 26dB Bandwidth.

Each antenna port has been declared as being equivalent, therefore measurements were made on one antenna port only. To account for this, the limit was tightened by $10 * \text{Log}(N)$, where N is equal to the number of MIMO antenna ports.

For single port, the limit was calculated as being $-13 \text{ dBm} - 10 * \text{Log}(4) = -19 \text{ dBm}$.

2.3.6 Test Results

Configuration 1

Maximum Output Power 47.78 dBm

Antenna	NR Modulation	NR Carrier Bandwidth	Band Edge (MHz)	
			Channel Position B	Channel Position T
A	QPSK	10.0 MHz 15 kHz SCS	1,935.0	1,990.0
A	QPSK	15.0 MHz 15 kHz SCS	1,937.5	1,987.5
A	QPSK	20.0 MHz 15 kHz SCS	1,940.0	1,985.0



Antenna A - NR Modulation QPSK - NR Carrier Bandwidth 10.0 MHz 15 kHz SCS - Channel Position B

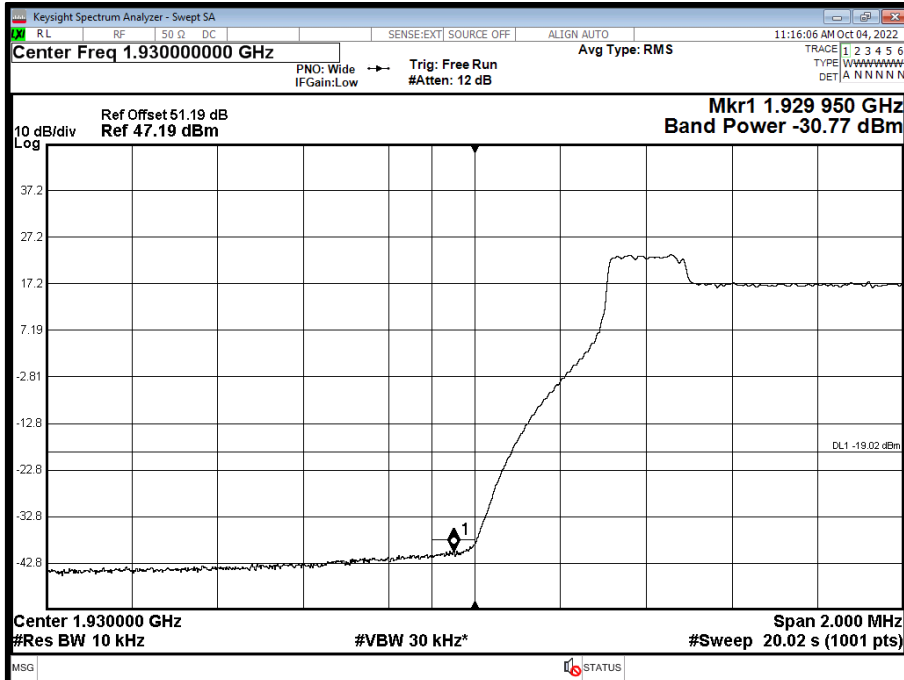

Antenna A - NR Modulation QPSK - NR Carrier Bandwidth 10.0 MHz 15 kHz SCS - Channel Position T

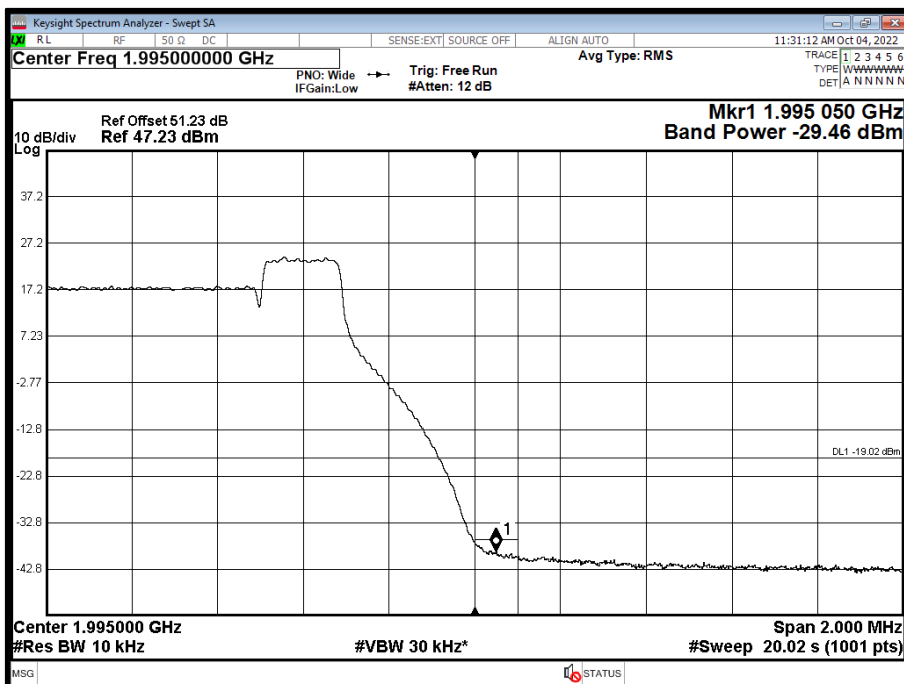



Antenna A - NR Modulation QPSK - NR Carrier Bandwidth 15.0 MHz 15 kHz SCS - Channel Position B

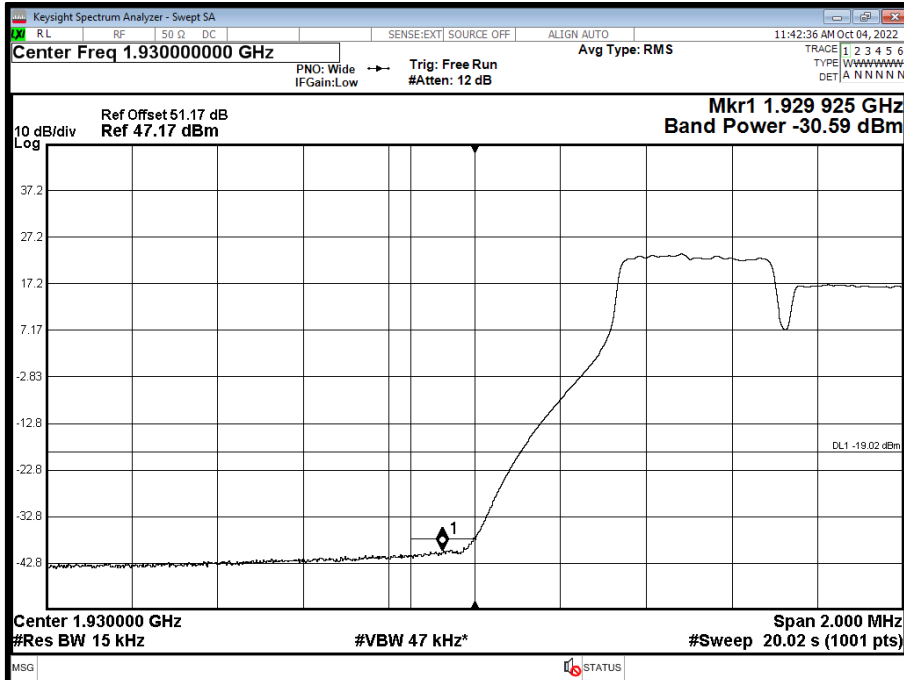

Antenna A - NR Modulation QPSK - NR Carrier Bandwidth 15.0 MHz 15 kHz SCS - Channel Position T

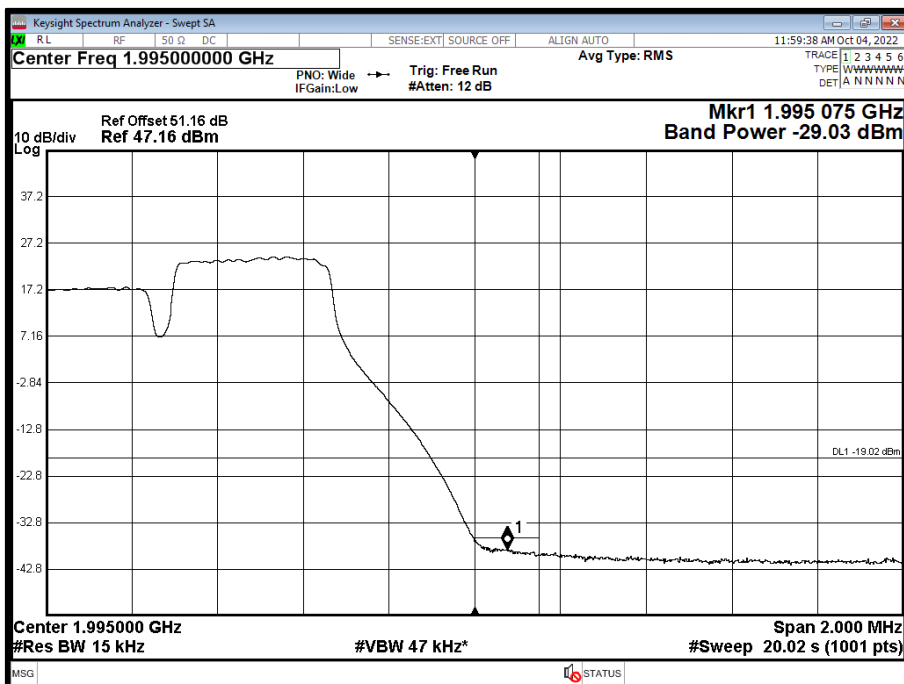



Antenna A - NR Modulation QPSK - NR Carrier Bandwidth 20.0 MHz 15 kHz SCS - Channel Position B

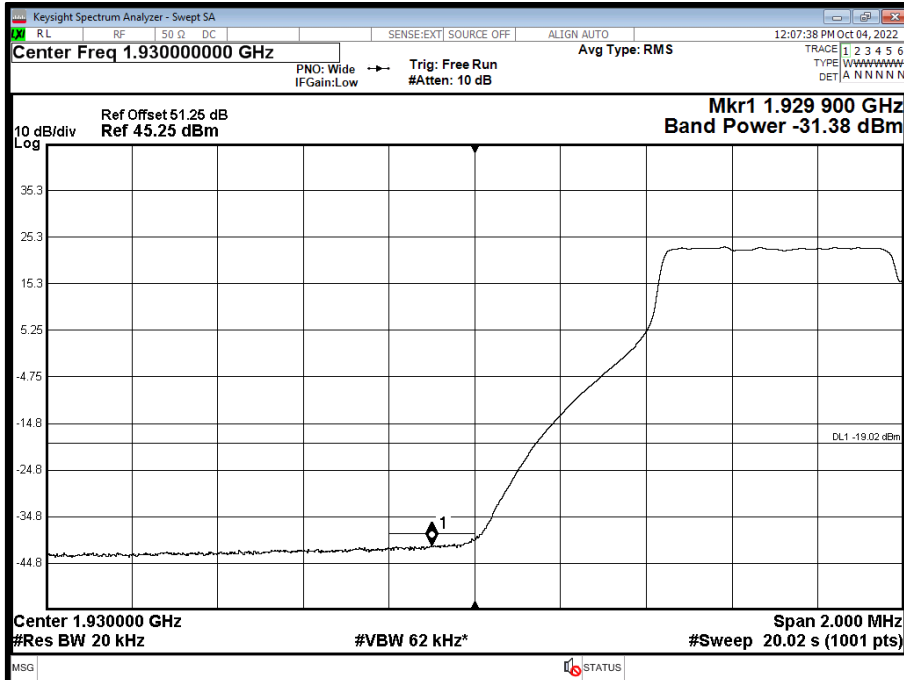

Antenna A - NR Modulation QPSK - NR Carrier Bandwidth 20.0 MHz 15 kHz SCS - Channel Position T

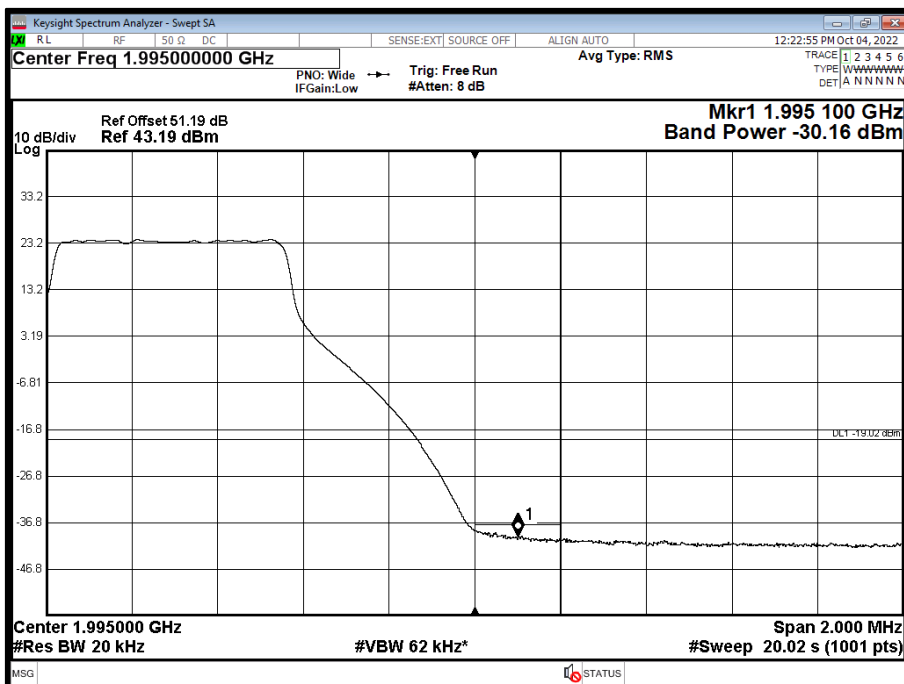



Configuration 2

Maximum Output Power 47.78 dBm

Antenna	NR Modulation	NR Carrier Bandwidth	Band Edge (MHz)	
			Channel Position B	Channel Position T
A	QPSK	10.0 MHz 15 kHz SCS	1,935.0	1,990.0
A	QPSK	15.0 MHz 15 kHz SCS	1,937.5	1,987.5
A	QPSK	20.0 MHz 15 kHz SCS	1,940.0	1,985.0



Antenna A - NR Modulation QPSK - NR Carrier Bandwidth 10.0 MHz 15 kHz SCS - Channel Position B

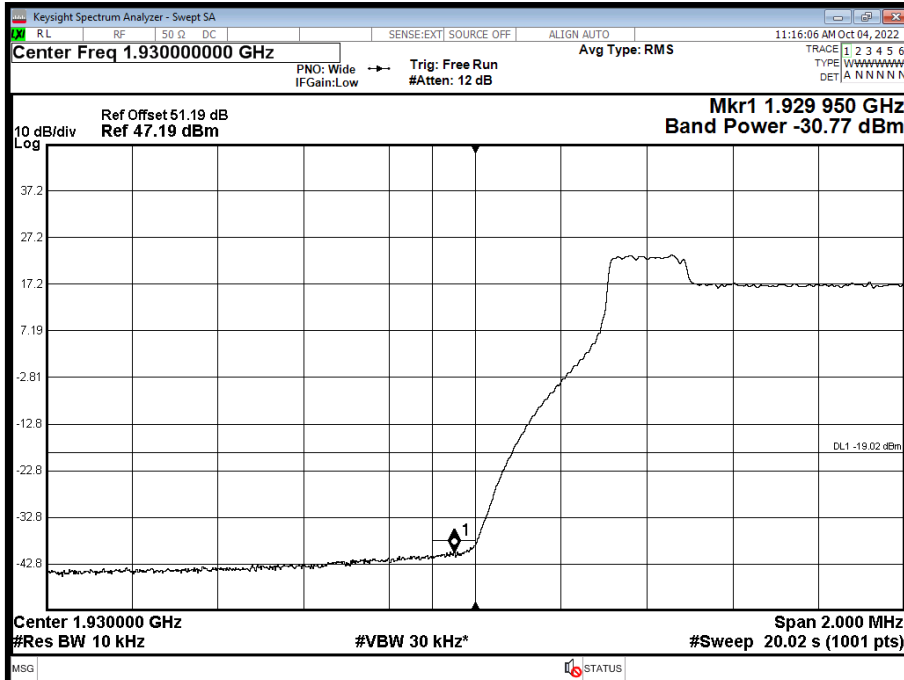

Antenna A - NR Modulation QPSK - NR Carrier Bandwidth 10.0 MHz 15 kHz SCS - Channel Position T

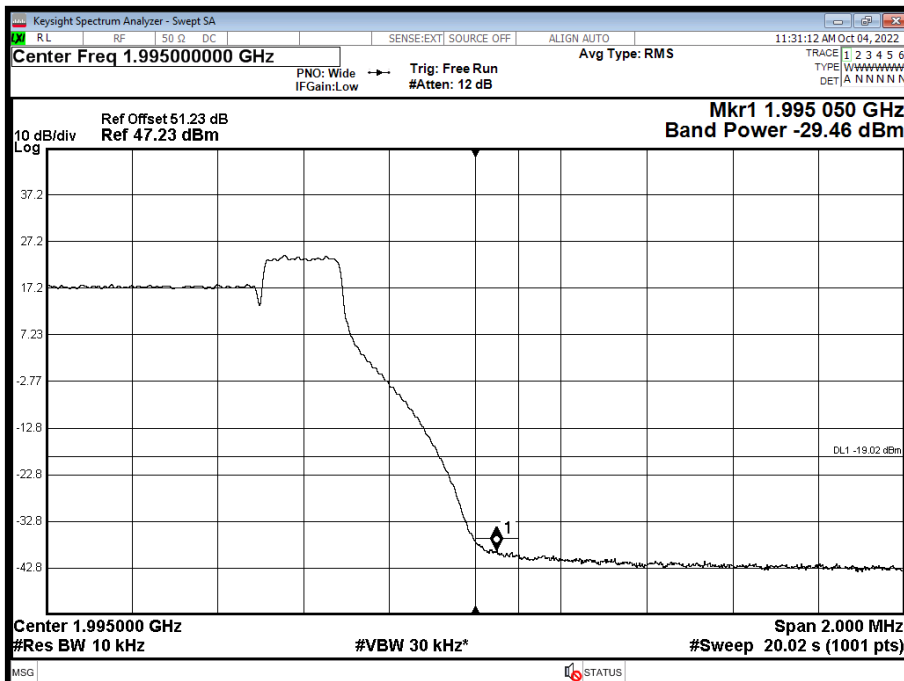



Antenna A - NR Modulation QPSK - NR Carrier Bandwidth 15.0 MHz 15 kHz SCS - Channel Position B

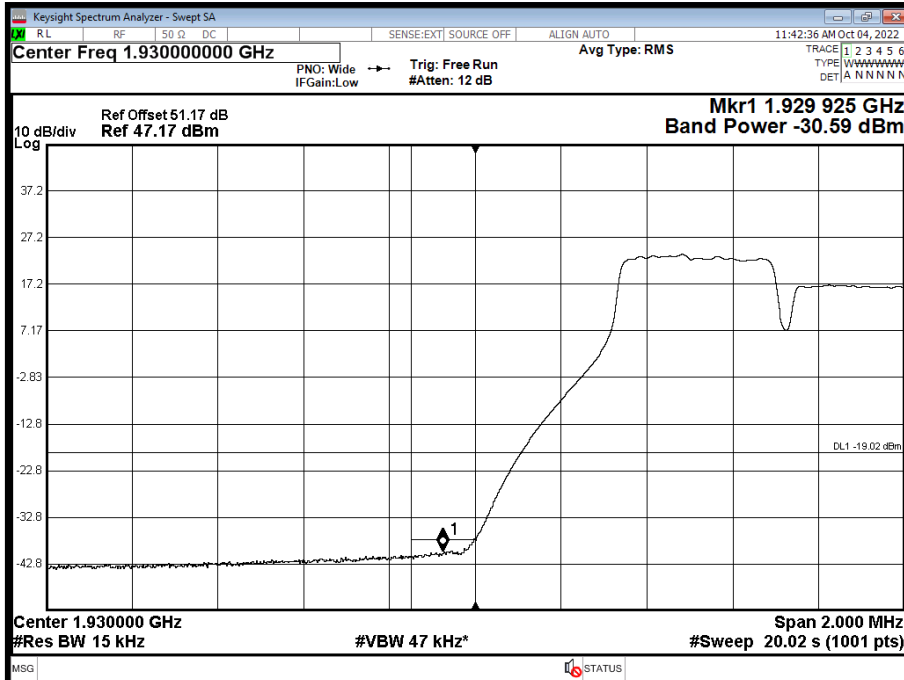

Antenna A - NR Modulation QPSK - NR Carrier Bandwidth 15.0 MHz 15 kHz SCS - Channel Position T

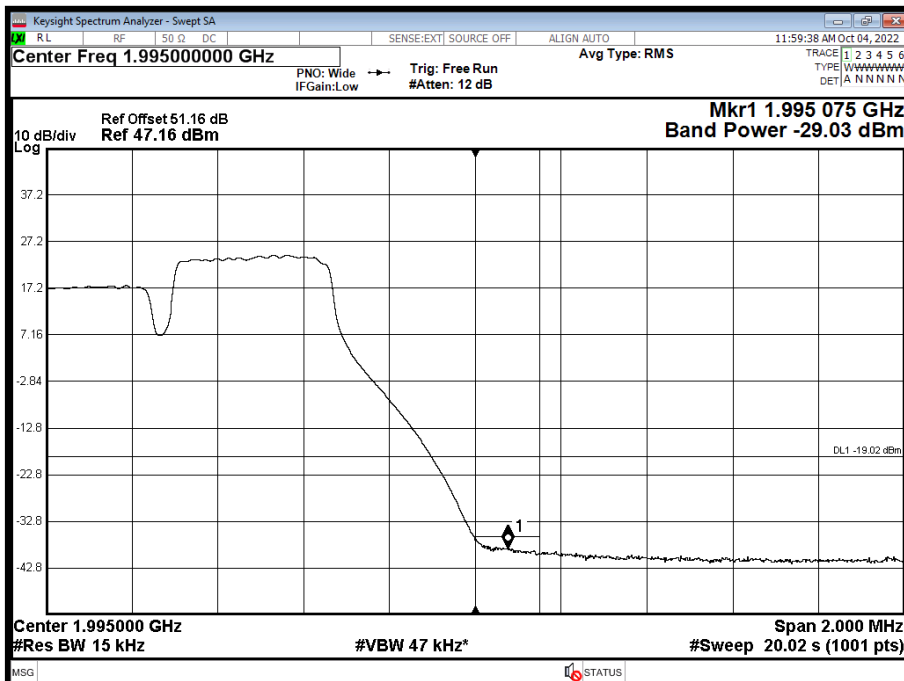



Antenna A - NR Modulation QPSK - NR Carrier Bandwidth 20.0 MHz 15 kHz SCS - Channel Position B

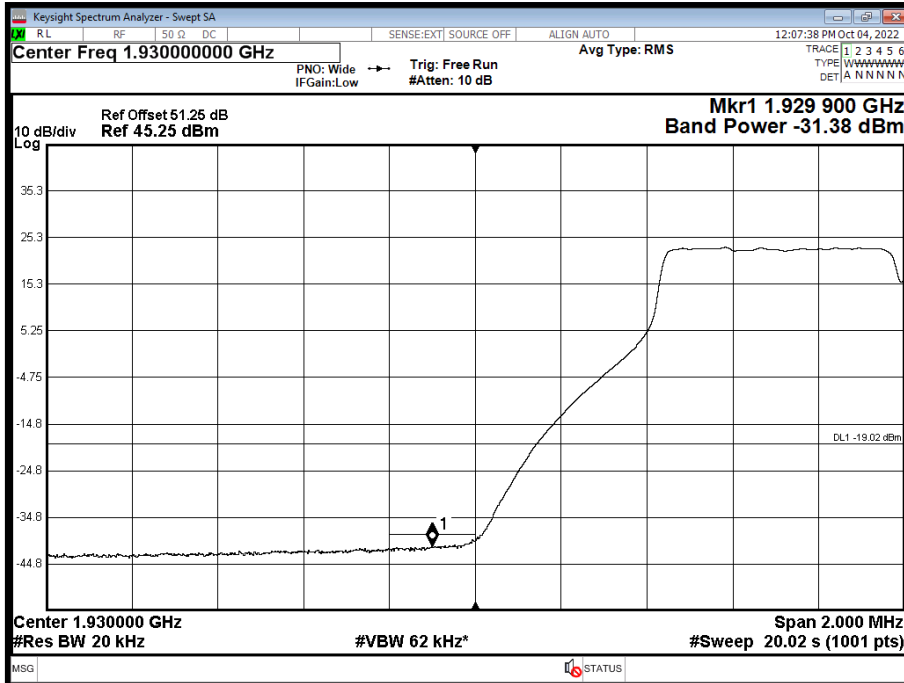

Antenna A - NR Modulation QPSK - NR Carrier Bandwidth 20.0 MHz 15 kHz SCS - Channel Position T

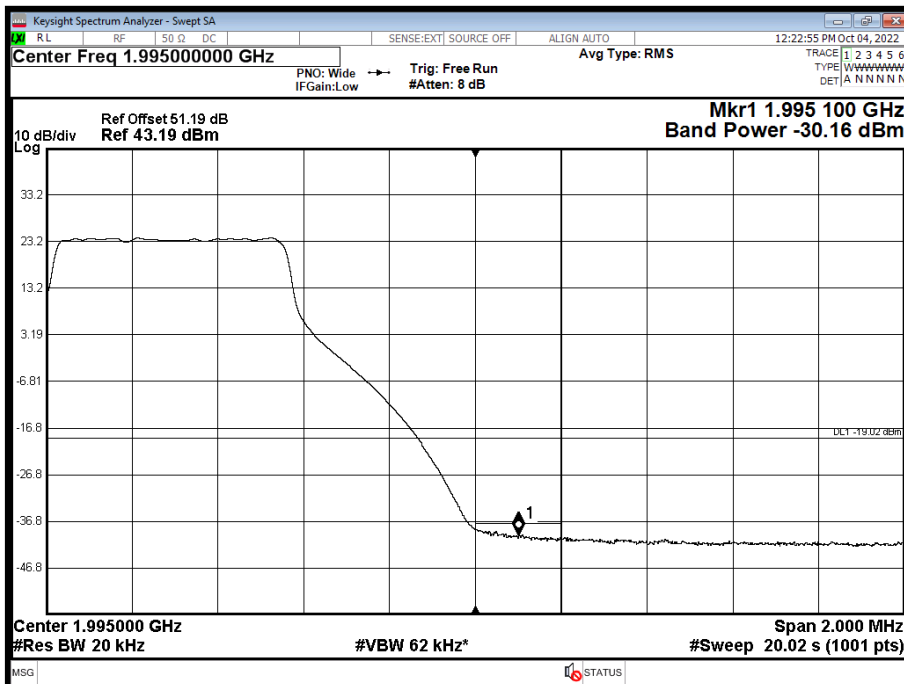

Limit	-19 dBm
-------	---------



2.4 TRANSMITTER SPURIOUS EMISSIONS

2.4.1 Specification Reference

FCC CFR 47 Part 24, Clause 24.238 (a)
ISED RSS-GEN, Clause 6.13
Industry Canada RSS-133, Clause 6.5
FCC CFR 47 Part 2, Clause 2.1051

2.4.2 Date of Test and Modification State

04-October-2022 - Modification State 0

2.4.3 Test Equipment Used

The major items of test equipment used for the above tests are identified in Section 3.1.

2.4.4 Environmental Conditions

Ambient Temperature	22.7°C
Relative Humidity	50.2%

2.4.5 Test Method

All measurements were made in accordance with FCC KDB 971168 D01, Clause 6.1.

Each antenna port has been declared as being equivalent, therefore measurements were made on one antenna port only. To account for this, the limit was tightened by $10 * \text{Log}(N)$, where N is equal to the number of MIMO antenna ports.

For single port, the limit was calculated as being $-13 \text{ dBm} - 10 * \text{Log}(1) = -19 \text{ dBm}$.

2.4.6 Test Results

Configuration 1

Maximum Output Power 47.78 dBm



Antenna A - NR Modulation QPSK - NR Carrier Bandwidth 10.0 MHz 15 kHz SCS - Channel Position B - Band 1 - Range 0.009 to 3500 MHz

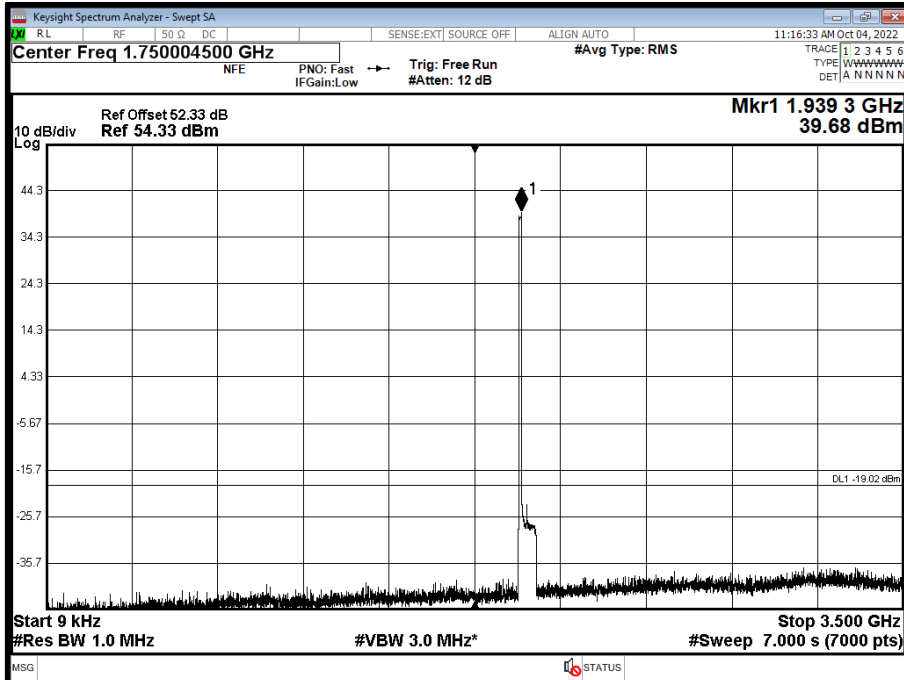

Antenna A - NR Modulation QPSK - NR Carrier Bandwidth 10.0 MHz 15 kHz SCS - Channel Position B - Band 2 - Range 3500 to 12000 MHz

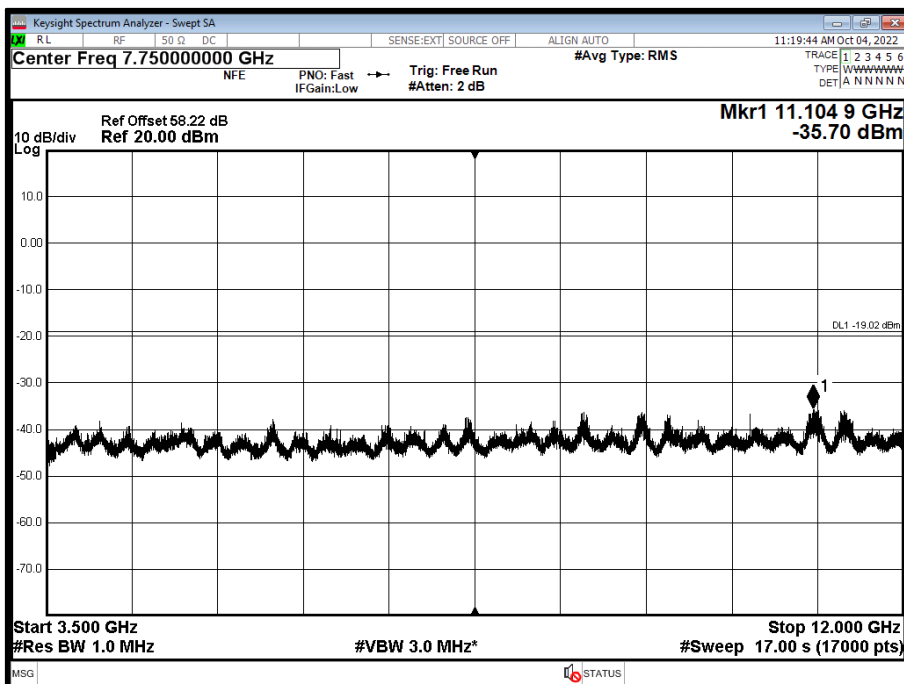



Antenna A - NR Modulation QPSK - NR Carrier Bandwidth 10.0 MHz 15 kHz SCS - Channel Position B - Band 3 - Range 12000 to 18000 MHz

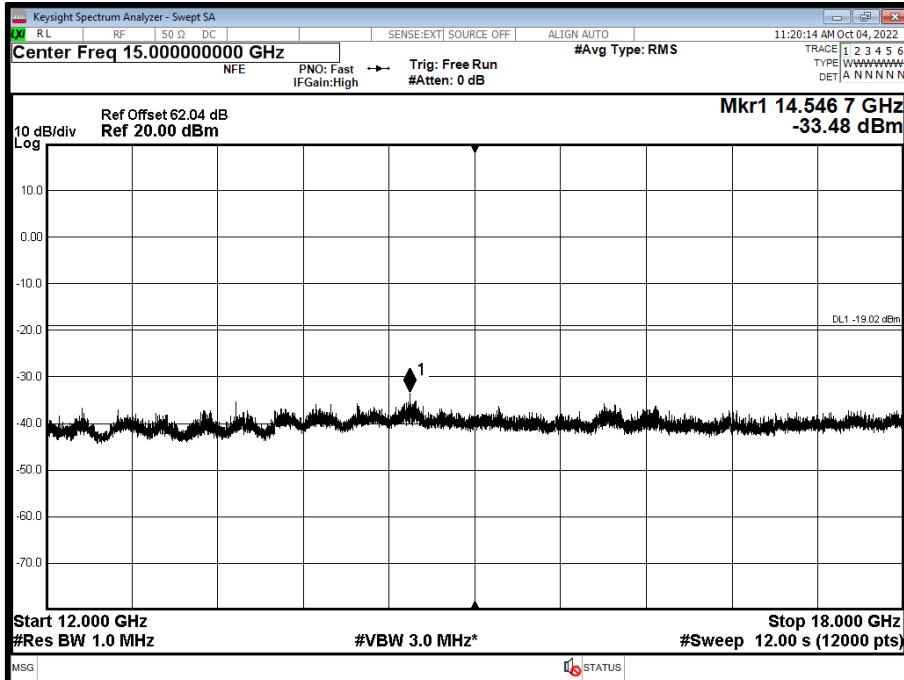

Antenna A - NR Modulation QPSK - NR Carrier Bandwidth 10.0 MHz 15 kHz SCS - Channel Position B - Band 4 - Range 18000 to 20000 MHz

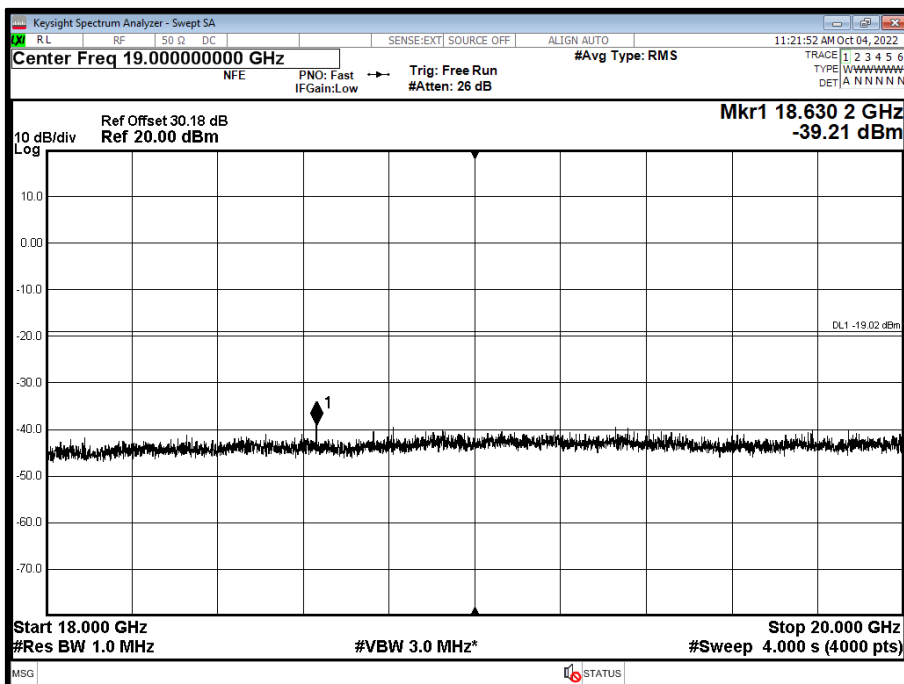



Antenna A - NR Modulation QPSK - NR Carrier Bandwidth 10.0 MHz 15 kHz SCS - Channel Position M - Band 1 - Range 0.009 to 3500 MHz

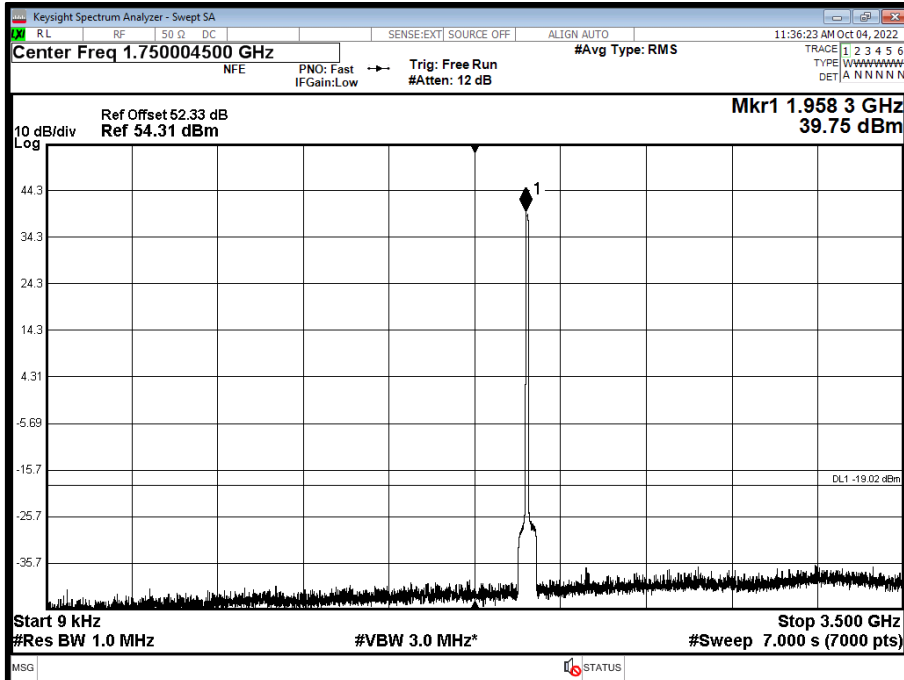

Antenna A - NR Modulation QPSK - NR Carrier Bandwidth 10.0 MHz 15 kHz SCS - Channel Position M - Band 2 - Range 3500 to 12000 MHz

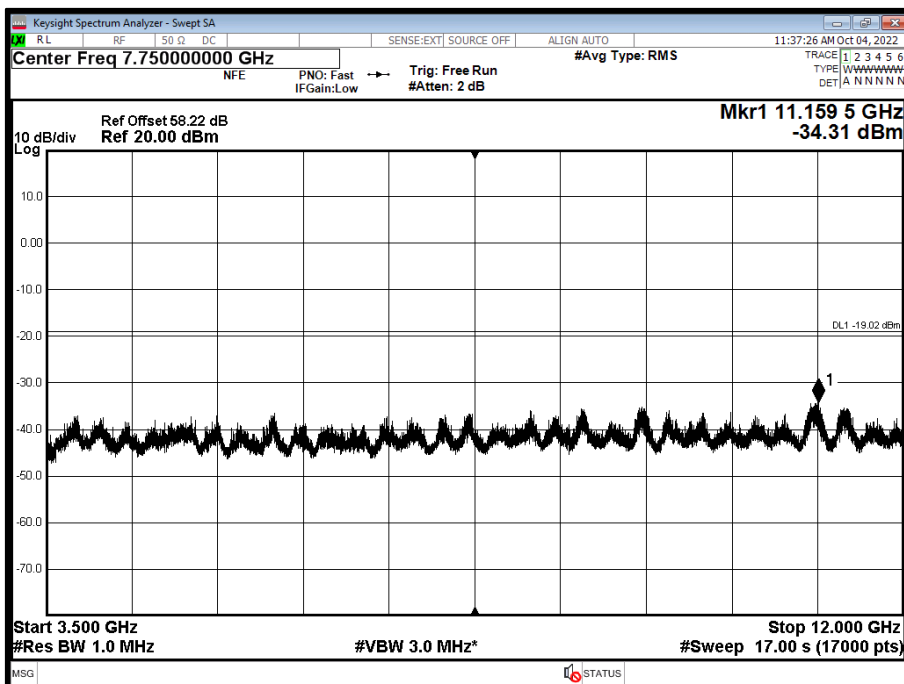



Antenna A - NR Modulation QPSK - NR Carrier Bandwidth 10.0 MHz 15 kHz SCS - Channel Position M - Band 3 - Range 12000 to 18000 MHz

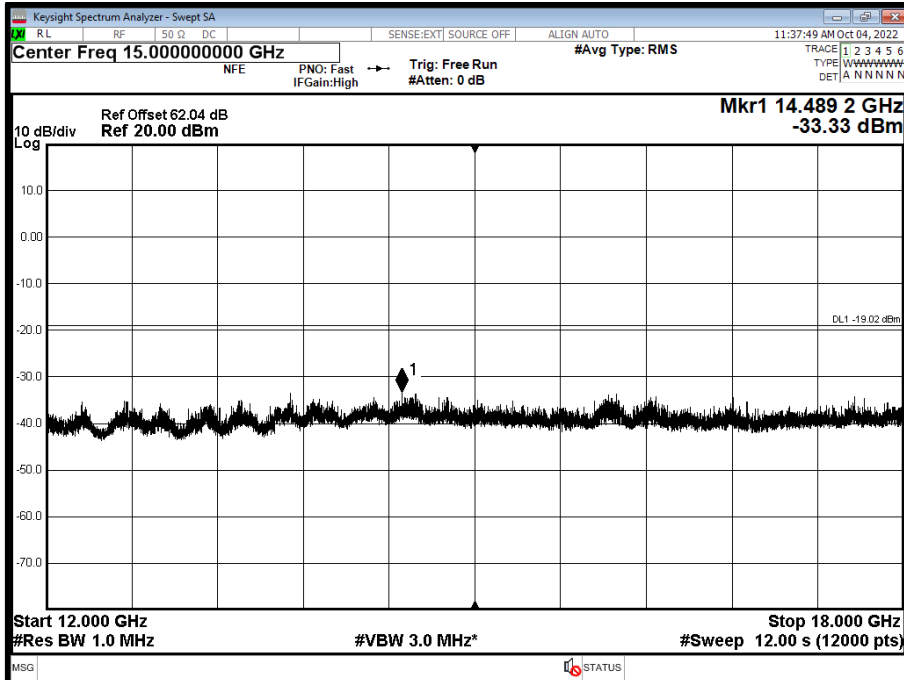

Antenna A - NR Modulation QPSK - NR Carrier Bandwidth 10.0 MHz 15 kHz SCS - Channel Position M - Band 4 - Range 18000 to 20000 MHz

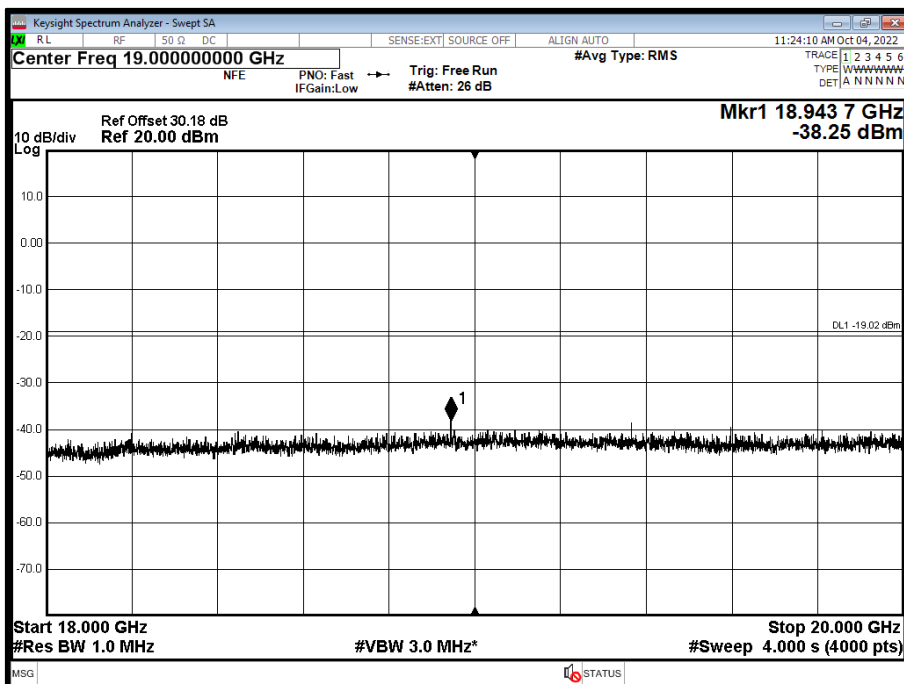



Antenna A - NR Modulation QPSK - NR Carrier Bandwidth 10.0 MHz 15 kHz SCS - Channel Position T - Band 1 - Range 0.009 to 3500 MHz

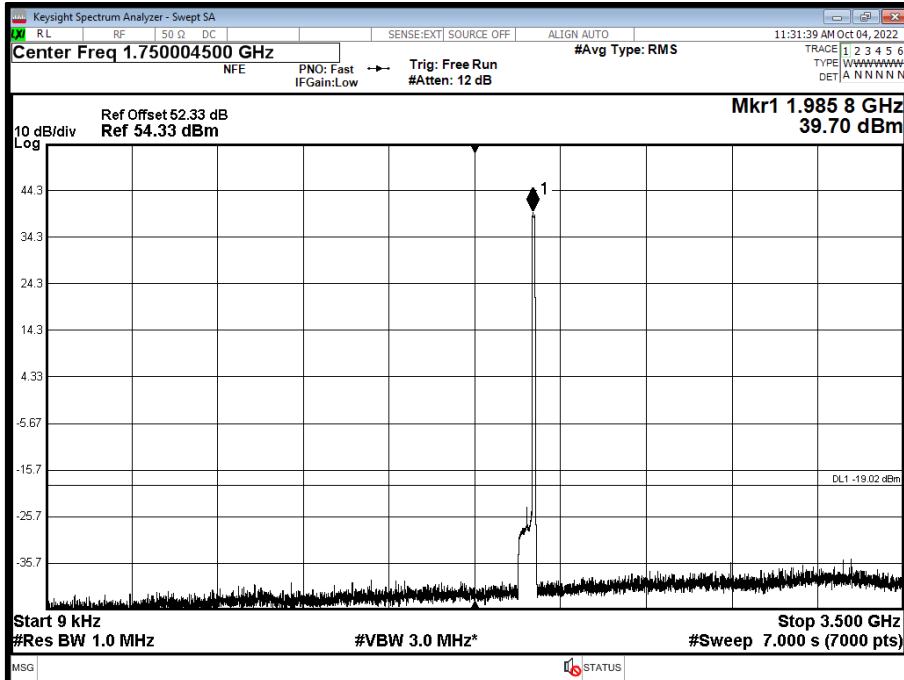

Antenna A - NR Modulation QPSK - NR Carrier Bandwidth 10.0 MHz 15 kHz SCS - Channel Position T - Band 2 - Range 3500 to 12000 MHz

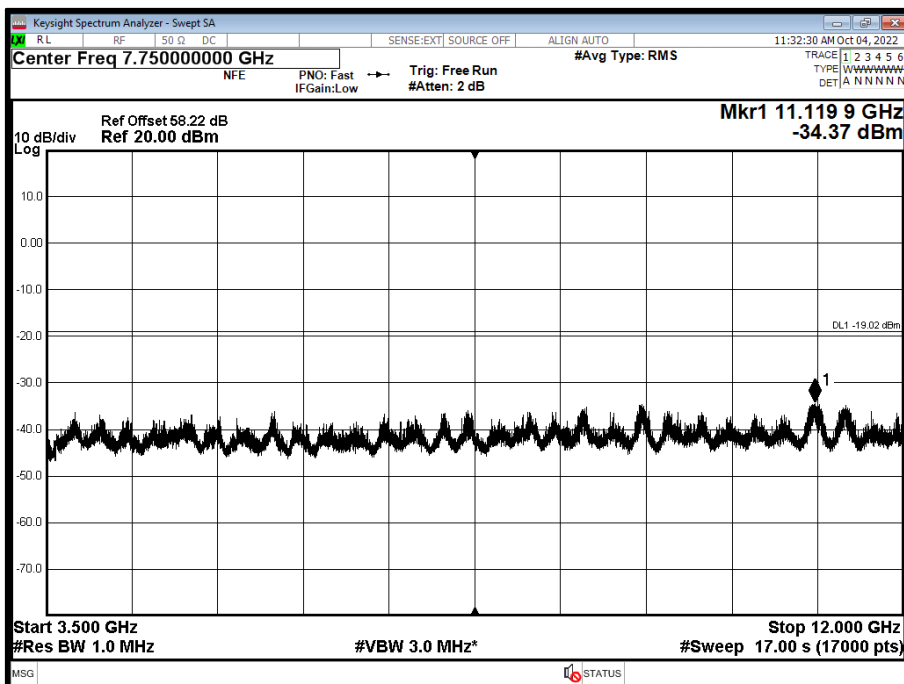



Antenna A - NR Modulation QPSK - NR Carrier Bandwidth 10.0 MHz 15 kHz SCS - Channel Position T - Band 3 - Range 12000 to 18000 MHz

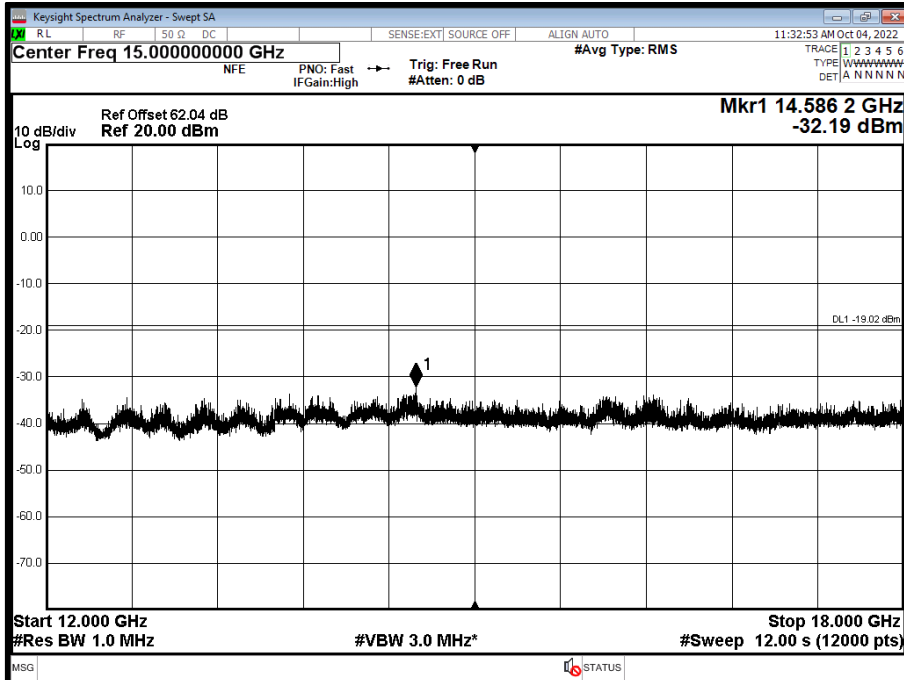

Antenna A - NR Modulation QPSK - NR Carrier Bandwidth 10.0 MHz 15 kHz SCS - Channel Position T - Band 4 - Range 18000 to 20000 MHz

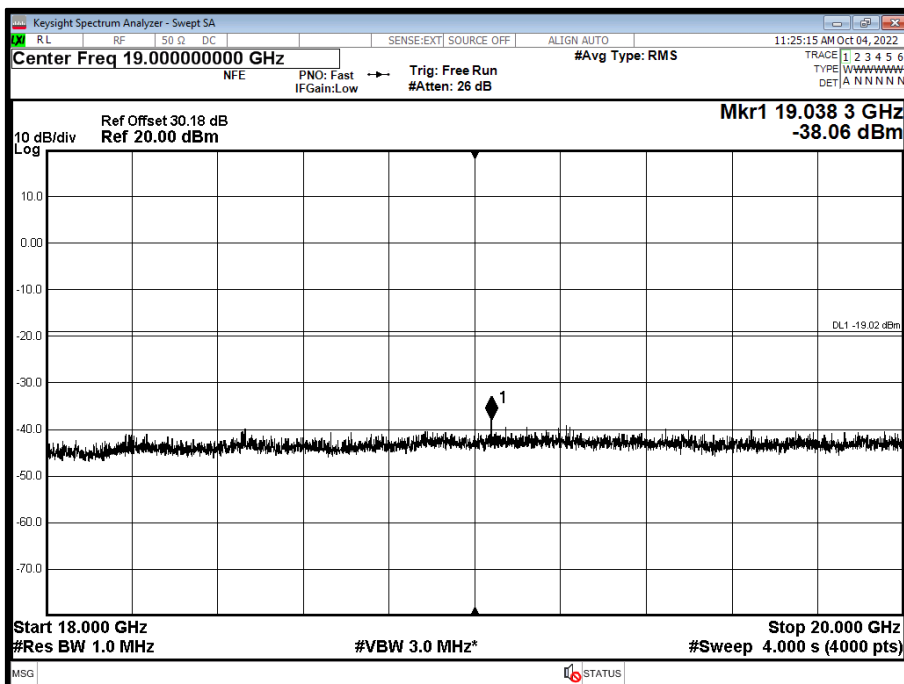



Antenna A - NR Modulation QPSK - NR Carrier Bandwidth 15.0 MHz 15 kHz SCS - Channel Position B - Band 1 - Range 0.009 to 3500 MHz

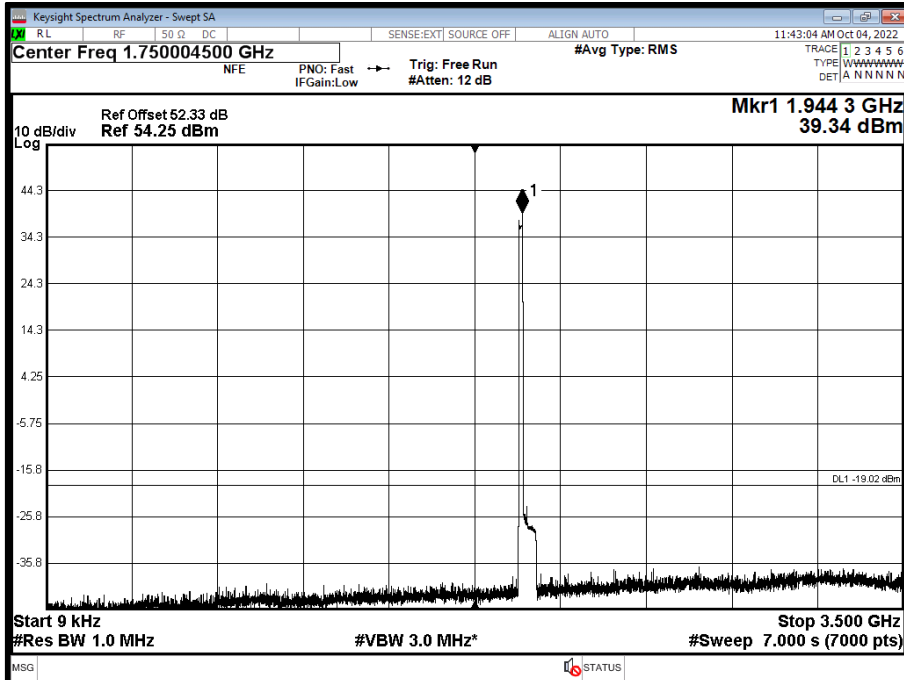

Antenna A - NR Modulation QPSK - NR Carrier Bandwidth 15.0 MHz 15 kHz SCS - Channel Position B - Band 2 - Range 3500 to 12000 MHz

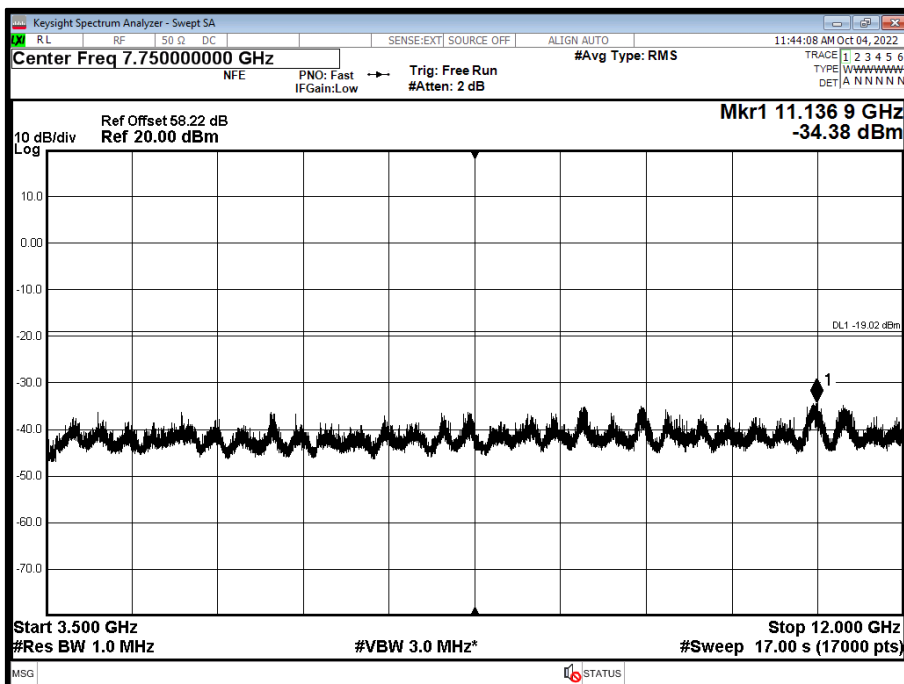



Antenna A - NR Modulation QPSK - NR Carrier Bandwidth 15.0 MHz 15 kHz SCS - Channel Position B - Band 3 - Range 12000 to 18000 MHz

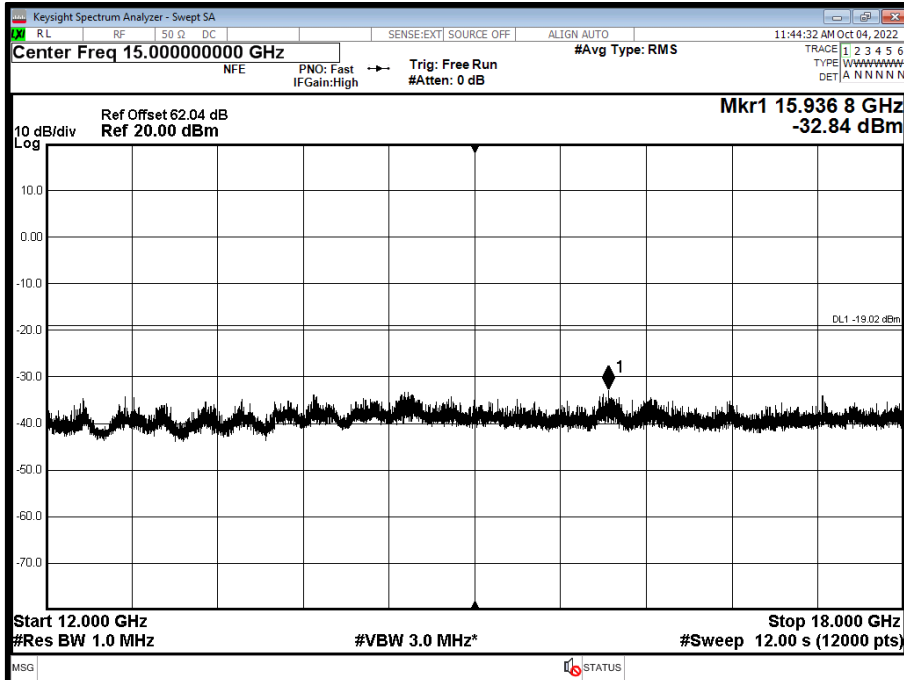

Antenna A - NR Modulation QPSK - NR Carrier Bandwidth 15.0 MHz 15 kHz SCS - Channel Position B - Band 4 - Range 18000 to 20000 MHz

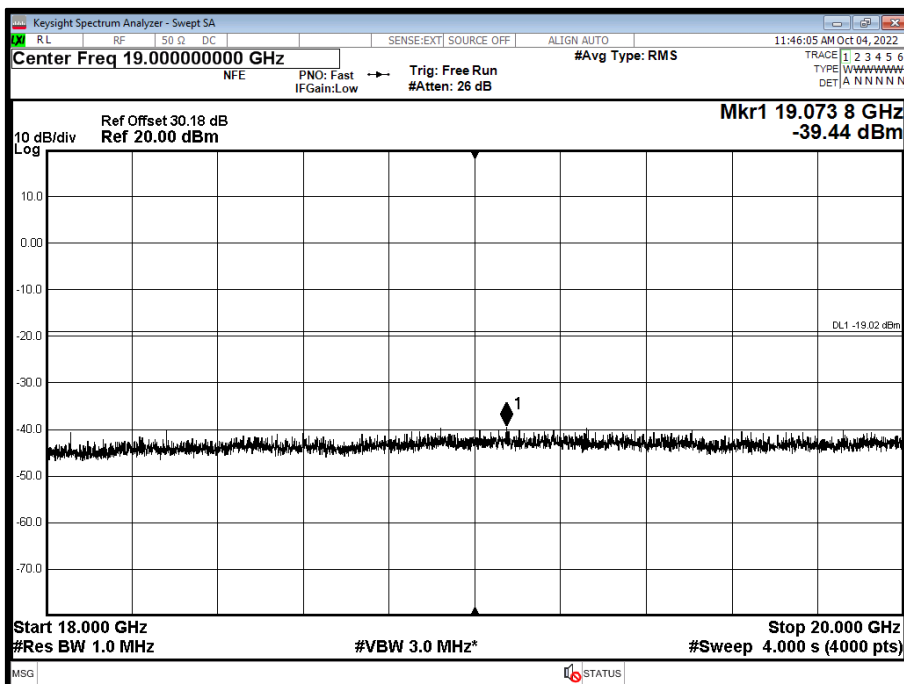



Antenna A - NR Modulation QPSK - NR Carrier Bandwidth 15.0 MHz 15 kHz SCS - Channel Position M - Band 1 - Range 0.009 to 3500 MHz

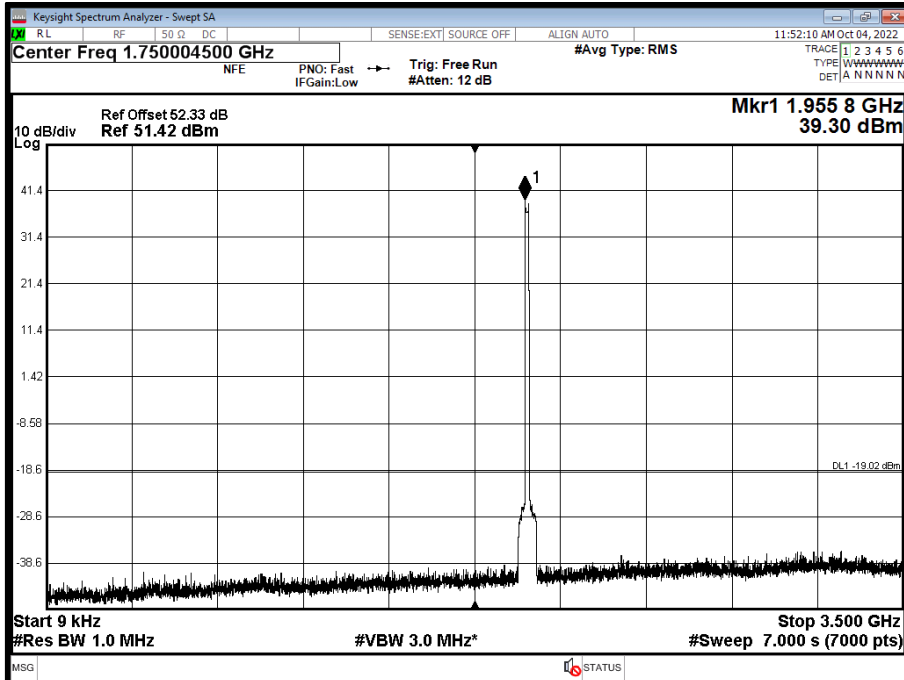

Antenna A - NR Modulation QPSK - NR Carrier Bandwidth 15.0 MHz 15 kHz SCS - Channel Position M - Band 2 - Range 3500 to 12000 MHz

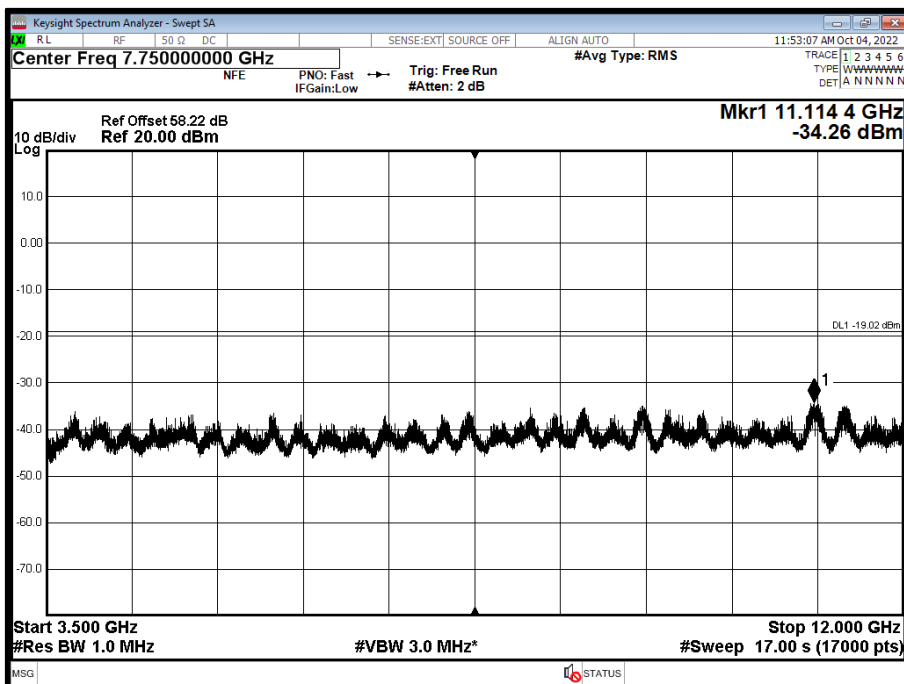



Antenna A - NR Modulation QPSK - NR Carrier Bandwidth 15.0 MHz 15 kHz SCS - Channel Position M - Band 3 - Range 12000 to 18000 MHz

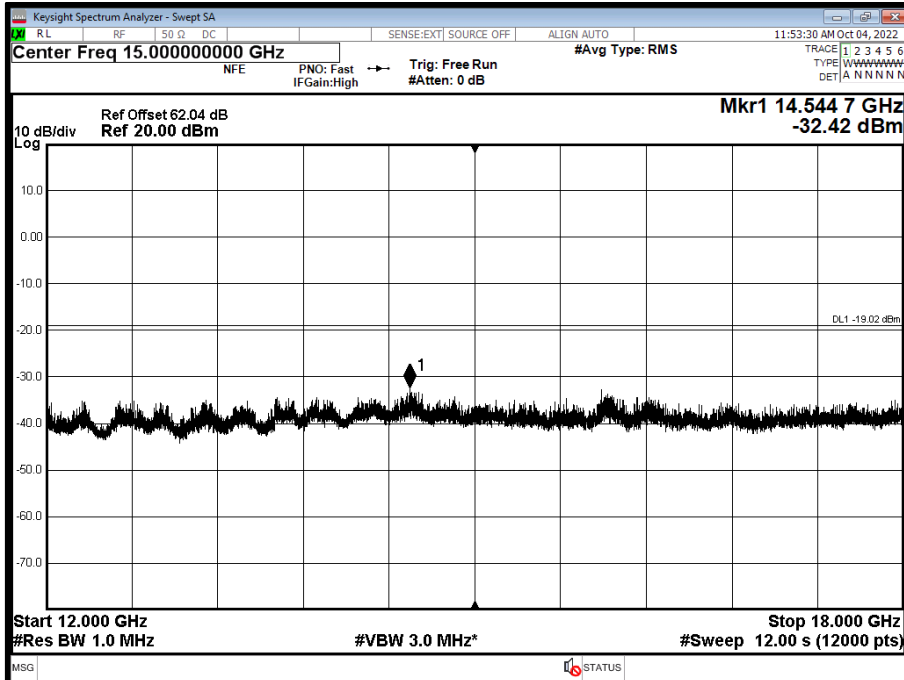

Antenna A - NR Modulation QPSK - NR Carrier Bandwidth 15.0 MHz 15 kHz SCS - Channel Position M - Band 4 - Range 18000 to 20000 MHz

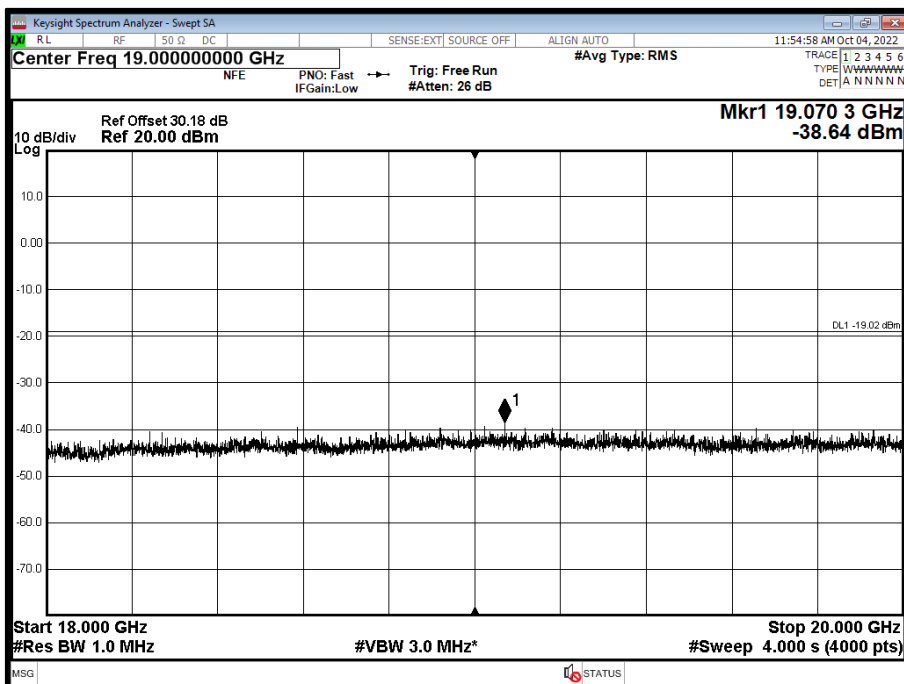



Antenna A - NR Modulation QPSK - NR Carrier Bandwidth 15.0 MHz 15 kHz SCS - Channel Position T - Band 1 - Range 0.009 to 3500 MHz

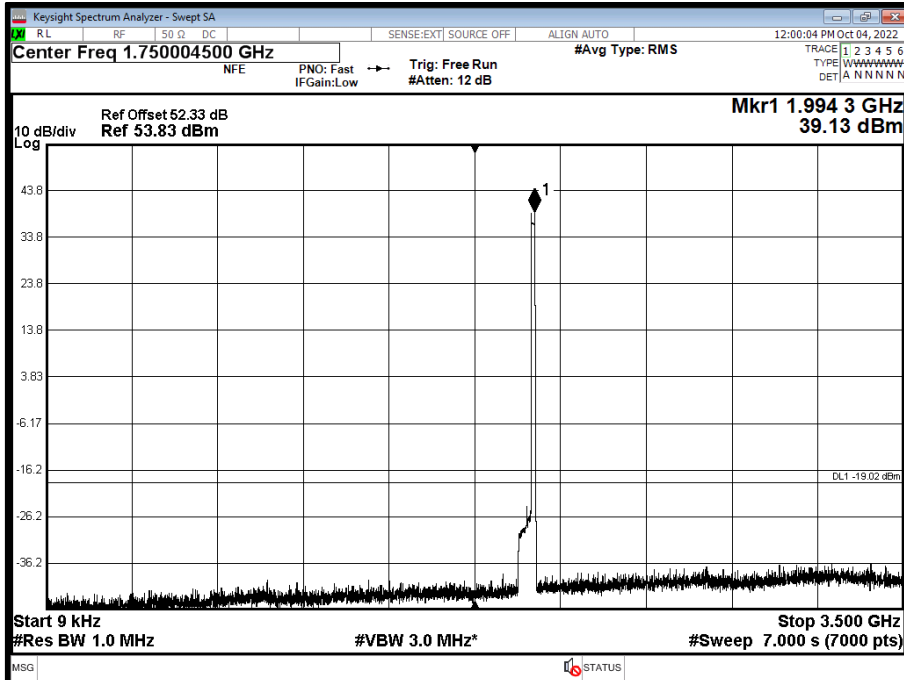

Antenna A - NR Modulation QPSK - NR Carrier Bandwidth 15.0 MHz 15 kHz SCS - Channel Position T - Band 2 - Range 3500 to 12000 MHz

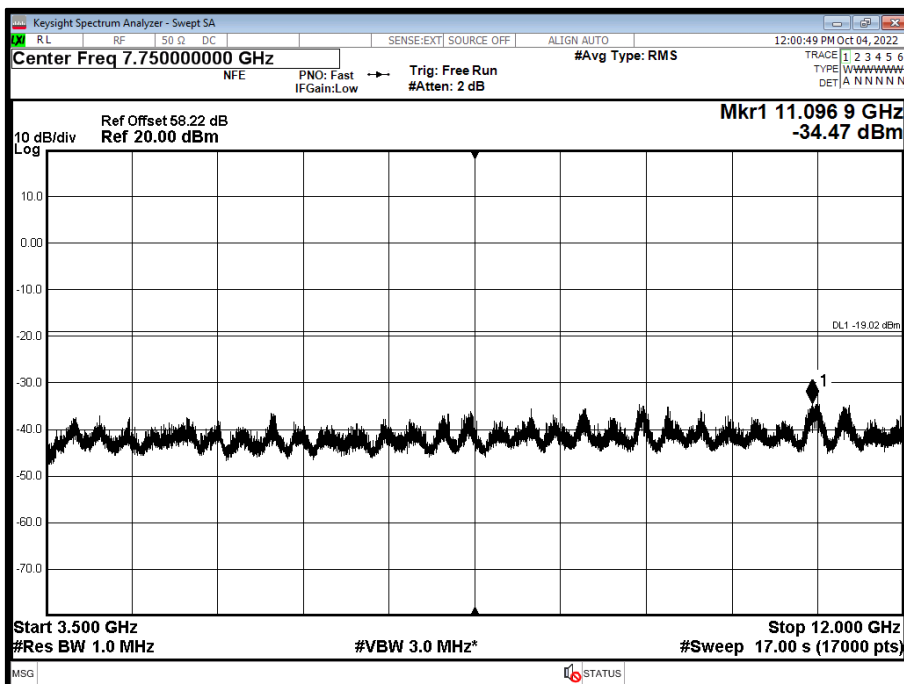



Antenna A - NR Modulation QPSK - NR Carrier Bandwidth 15.0 MHz 15 kHz SCS - Channel Position T - Band 3 - Range 12000 to 18000 MHz

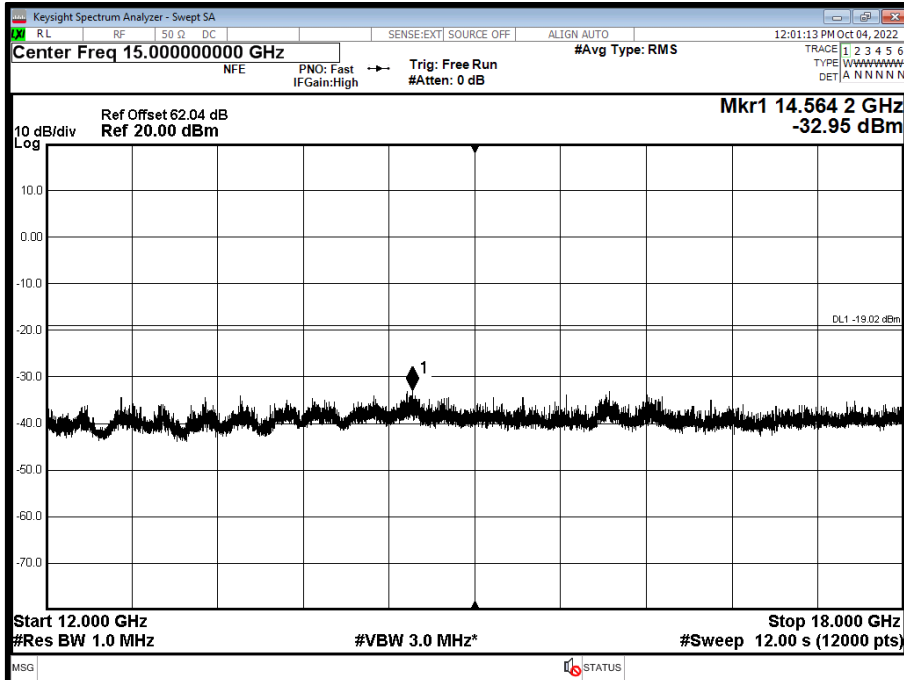

Antenna A - NR Modulation QPSK - NR Carrier Bandwidth 15.0 MHz 15 kHz SCS - Channel Position T - Band 4 - Range 18000 to 20000 MHz

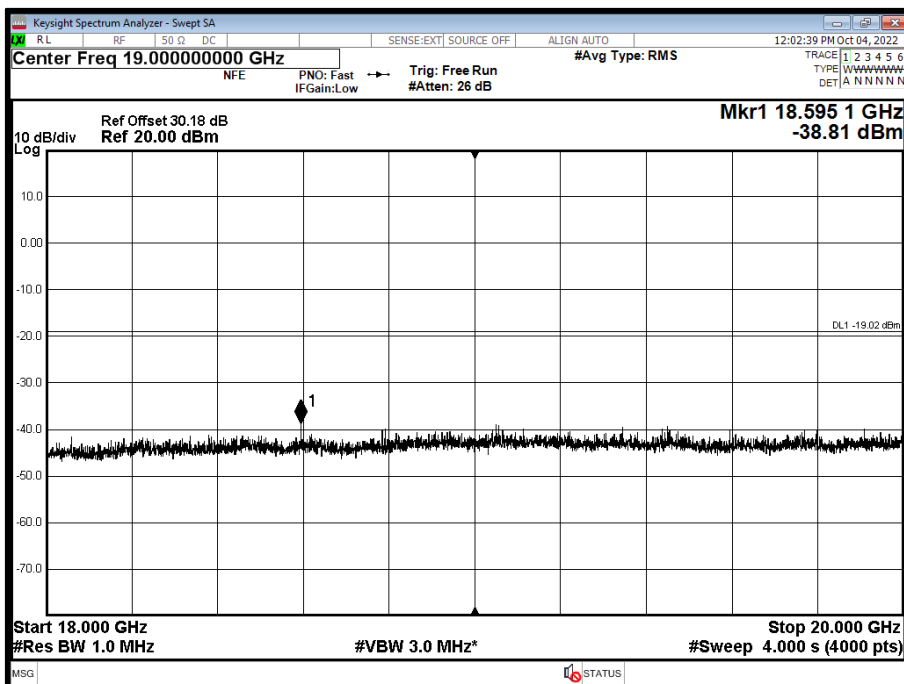



Antenna A - NR Modulation QPSK - NR Carrier Bandwidth 20.0 MHz 15 kHz SCS - Channel Position B - Band 1 - Range 0.009 to 3500 MHz

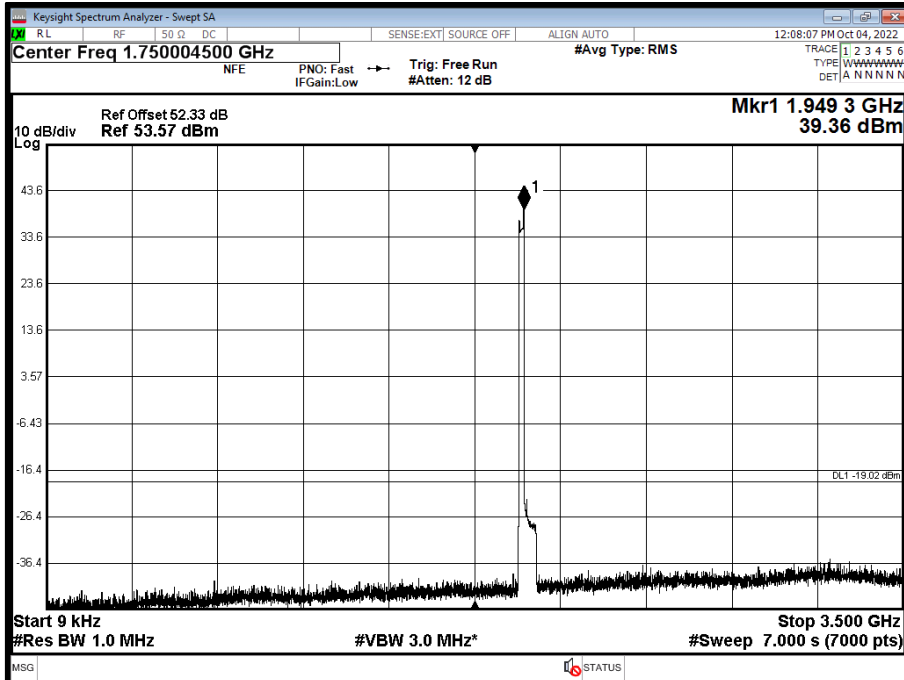

Antenna A - NR Modulation QPSK - NR Carrier Bandwidth 20.0 MHz 15 kHz SCS - Channel Position B - Band 2 - Range 3500 to 12000 MHz

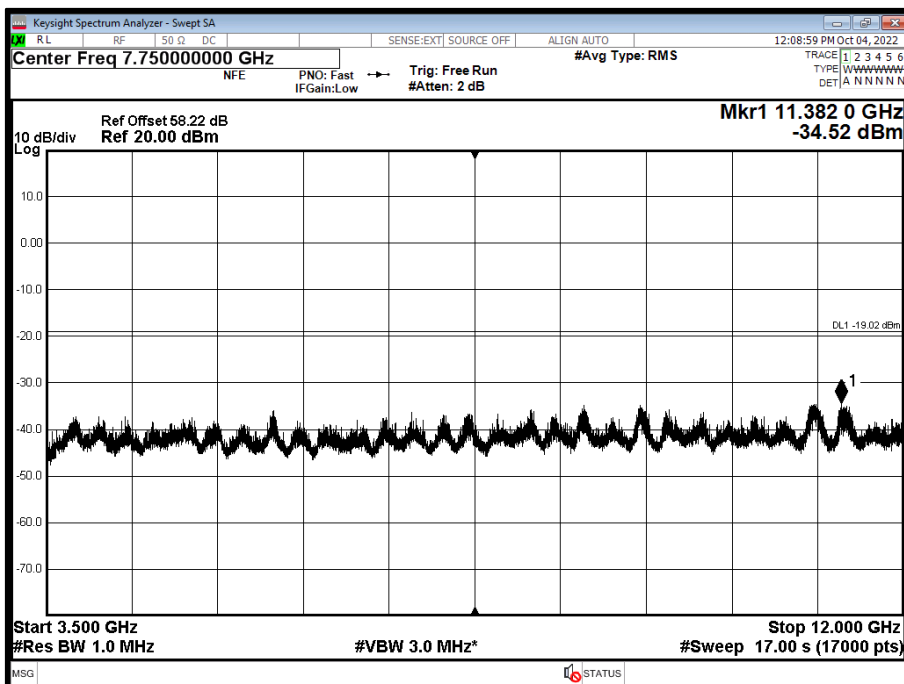



Antenna A - NR Modulation QPSK - NR Carrier Bandwidth 20.0 MHz 15 kHz SCS - Channel Position B - Band 3 - Range 12000 to 18000 MHz

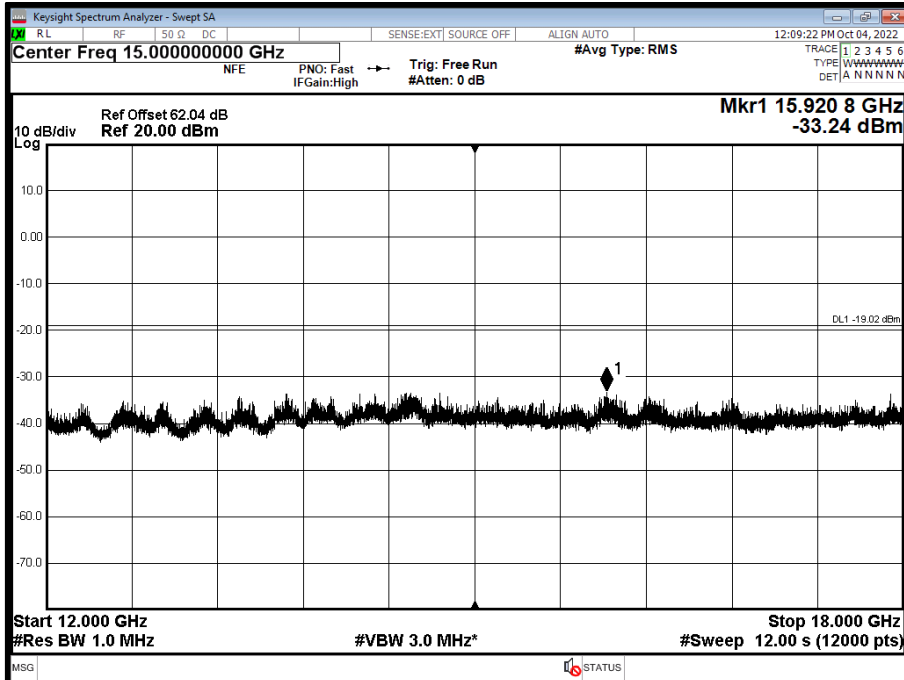

Antenna A - NR Modulation QPSK - NR Carrier Bandwidth 20.0 MHz 15 kHz SCS - Channel Position B - Band 4 - Range 18000 to 20000 MHz

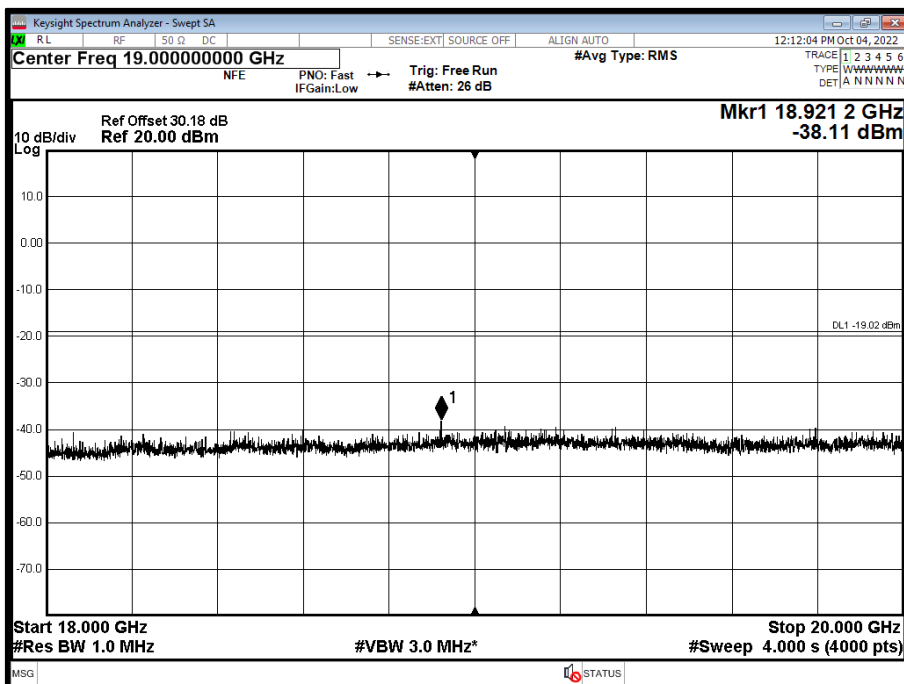



Antenna A - NR Modulation QPSK - NR Carrier Bandwidth 20.0 MHz 15 kHz SCS - Channel Position M - Band 1 - Range 0.009 to 3500 MHz

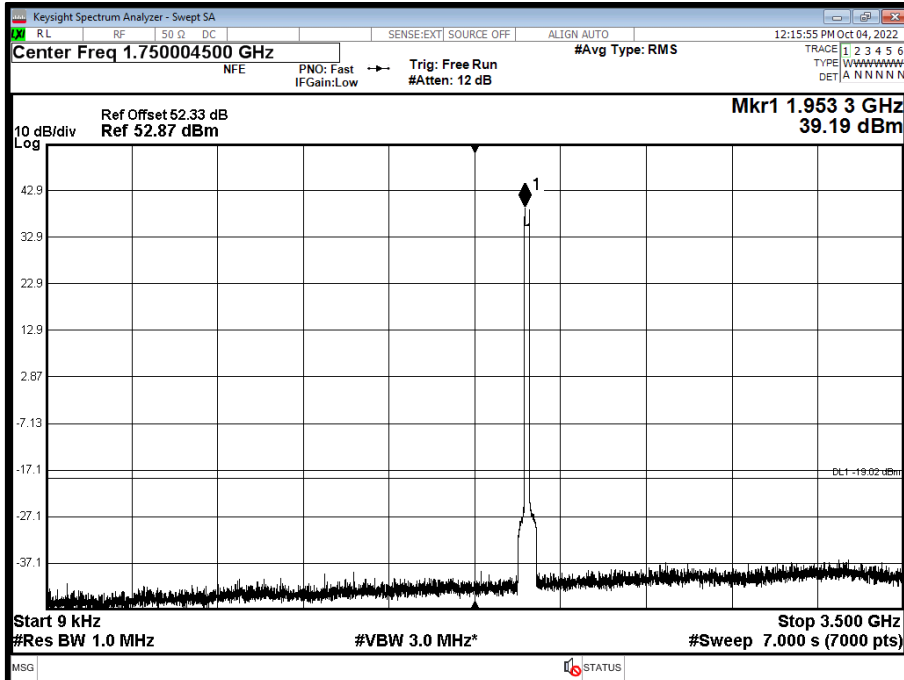

Antenna A - NR Modulation QPSK - NR Carrier Bandwidth 20.0 MHz 15 kHz SCS - Channel Position M - Band 2 - Range 3500 to 12000 MHz

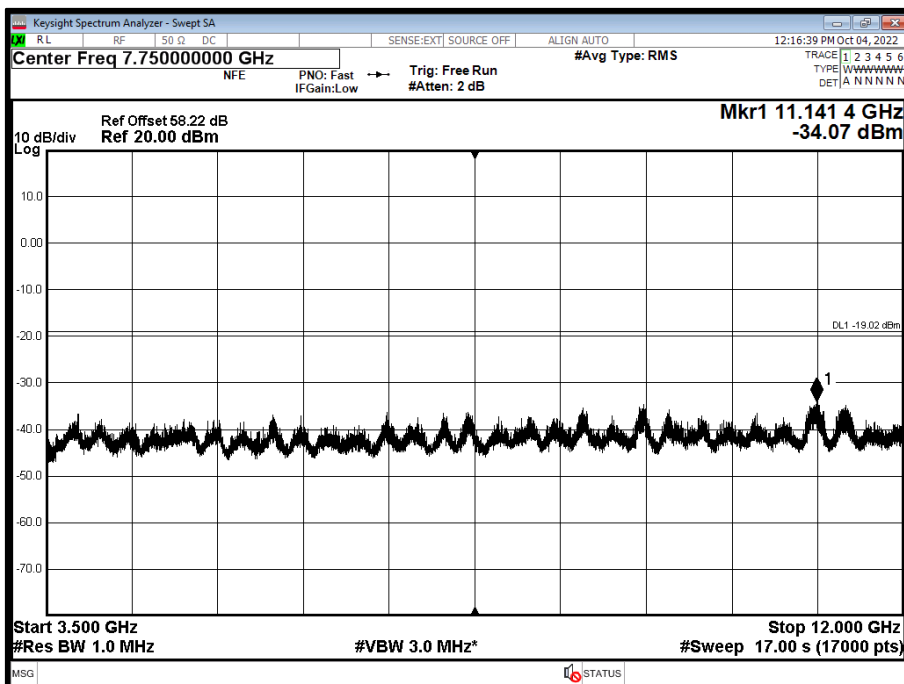



Antenna A - NR Modulation QPSK - NR Carrier Bandwidth 20.0 MHz 15 kHz SCS - Channel Position M - Band 3 - Range 12000 to 18000 MHz

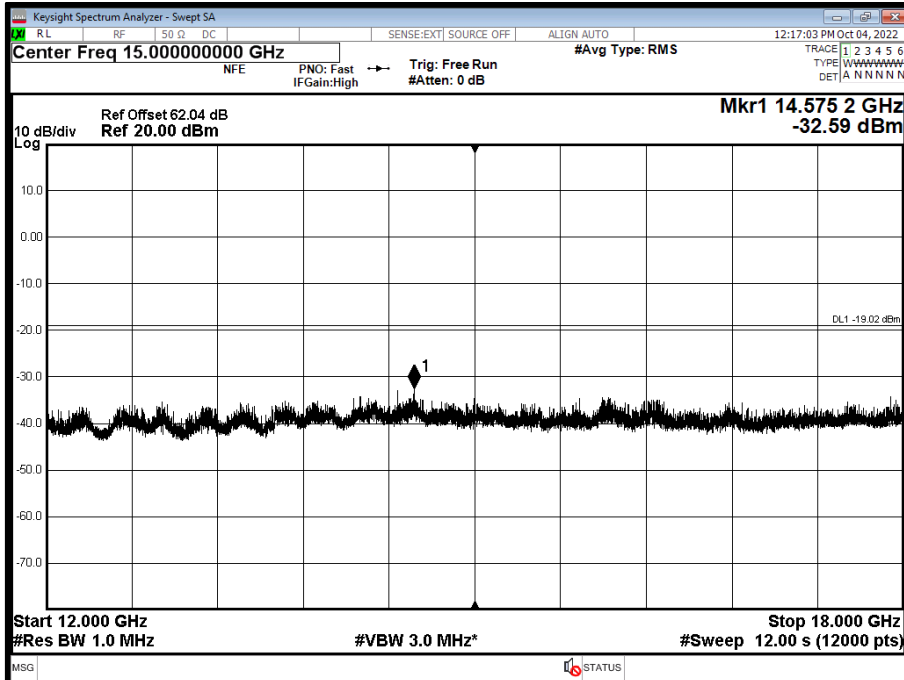

Antenna A - NR Modulation QPSK - NR Carrier Bandwidth 20.0 MHz 15 kHz SCS - Channel Position M - Band 4 - Range 18000 to 20000 MHz

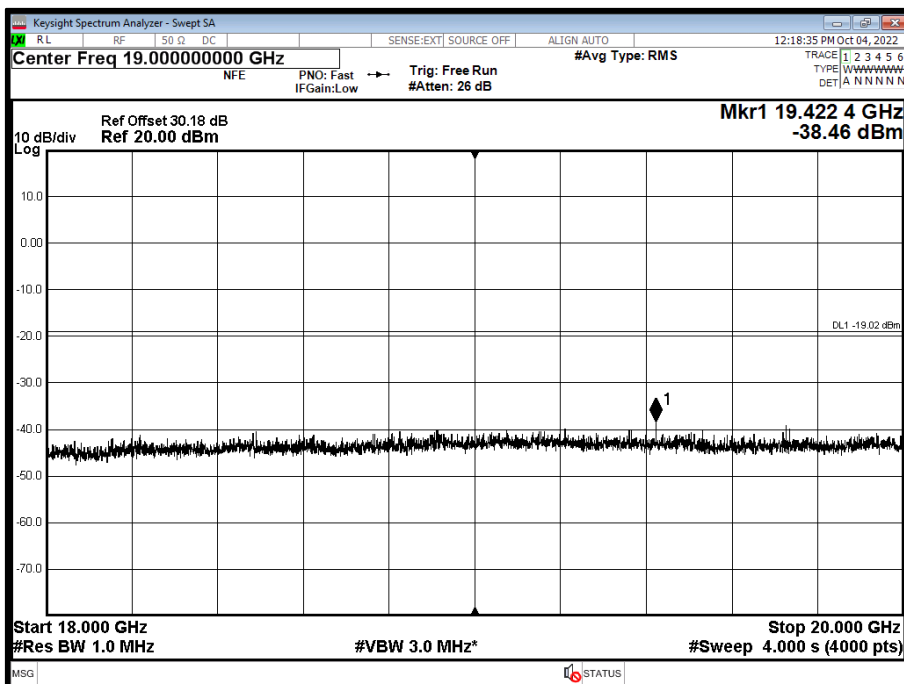



Antenna A - NR Modulation QPSK - NR Carrier Bandwidth 20.0 MHz 15 kHz SCS - Channel Position T - Band 1 - Range 0.009 to 3500 MHz

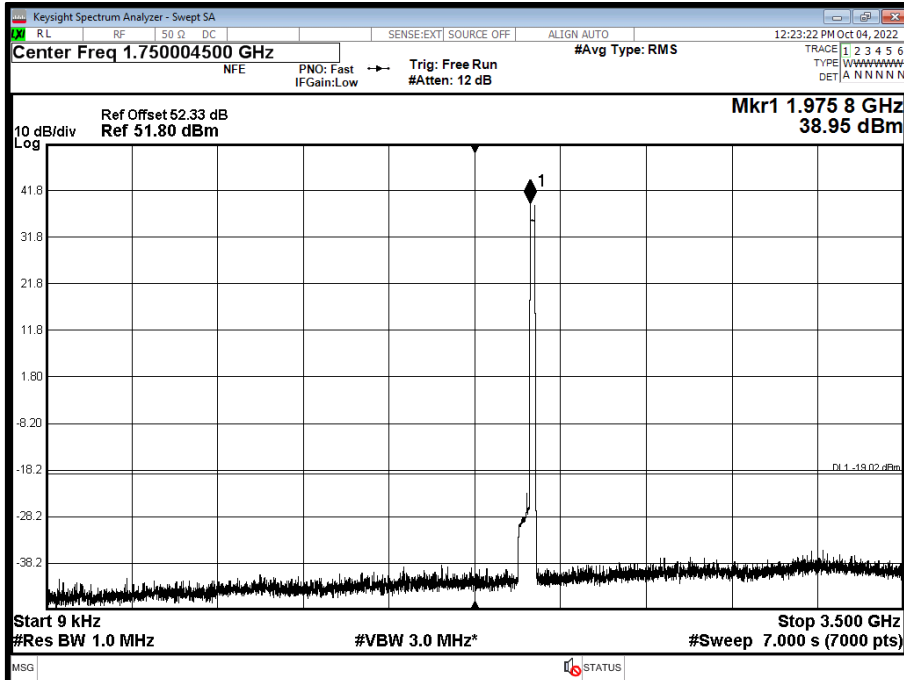

Antenna A - NR Modulation QPSK - NR Carrier Bandwidth 20.0 MHz 15 kHz SCS - Channel Position T - Band 2 - Range 3500 to 12000 MHz

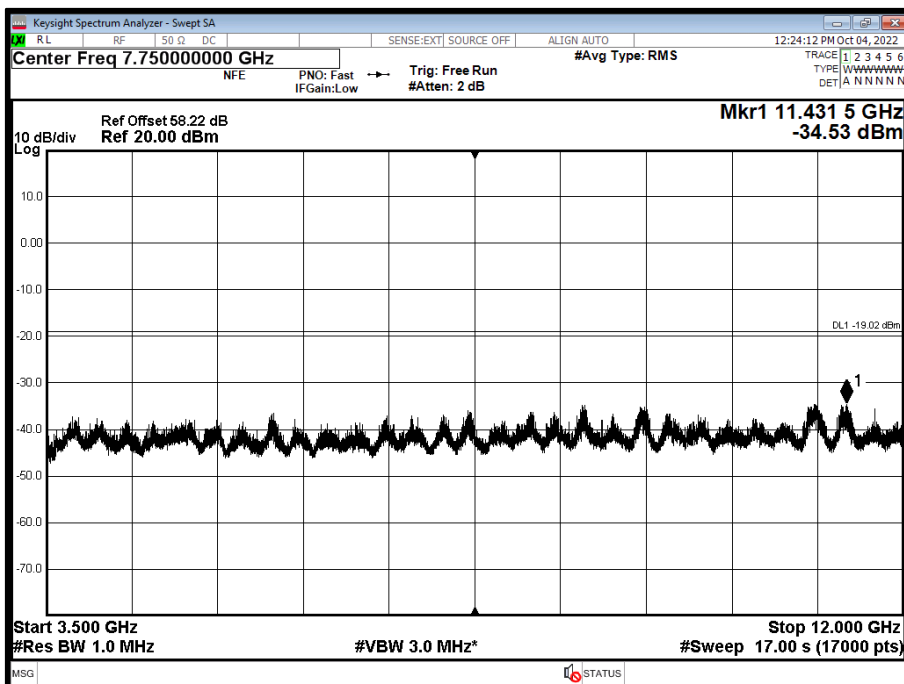



Antenna A - NR Modulation QPSK - NR Carrier Bandwidth 20.0 MHz 15 kHz SCS - Channel Position T - Band 3 - Range 12000 to 18000 MHz

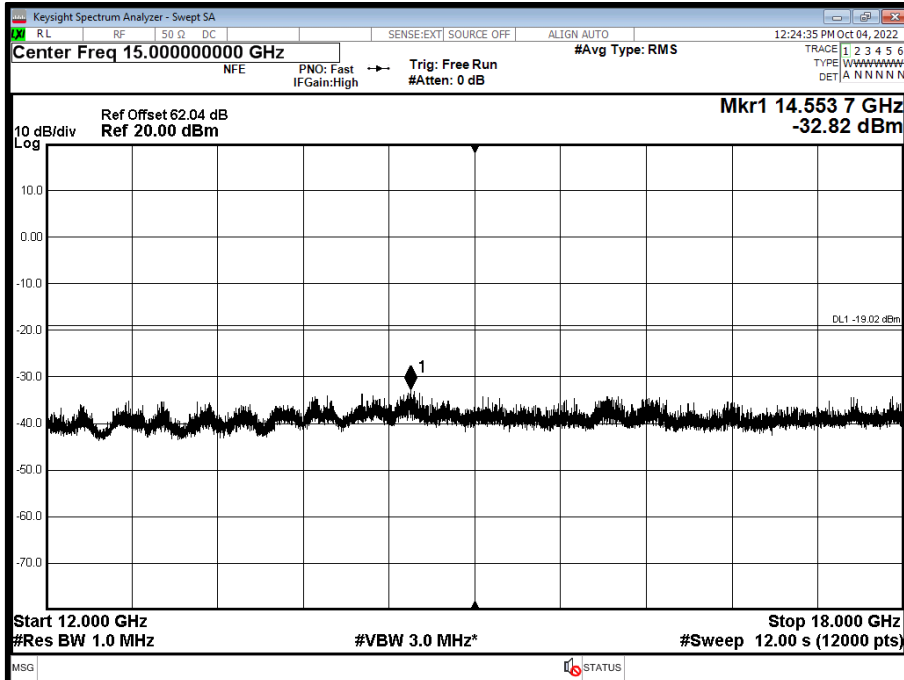

Antenna A - NR Modulation QPSK - NR Carrier Bandwidth 20.0 MHz 15 kHz SCS - Channel Position T - Band 4 - Range 18000 to 20000 MHz

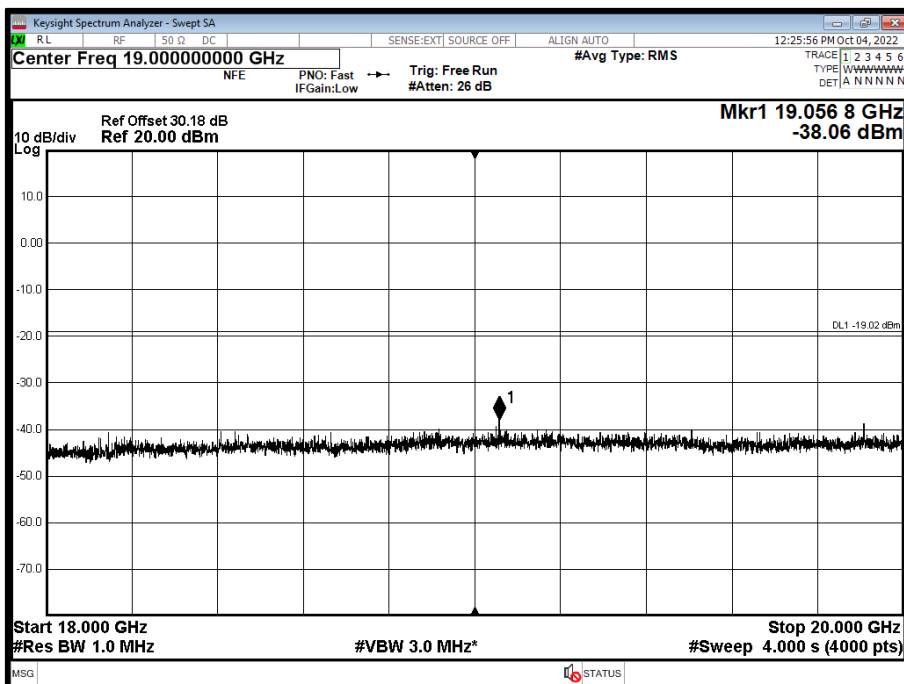



Configuration 2

Maximum Output Power 47.78 dBm

Antenna A - NR Modulation QPSK - NR Carrier Bandwidth 10.0 MHz 15 kHz SCS - Channel Position B - Band 1 - Range 0.009 to 3500 MHz

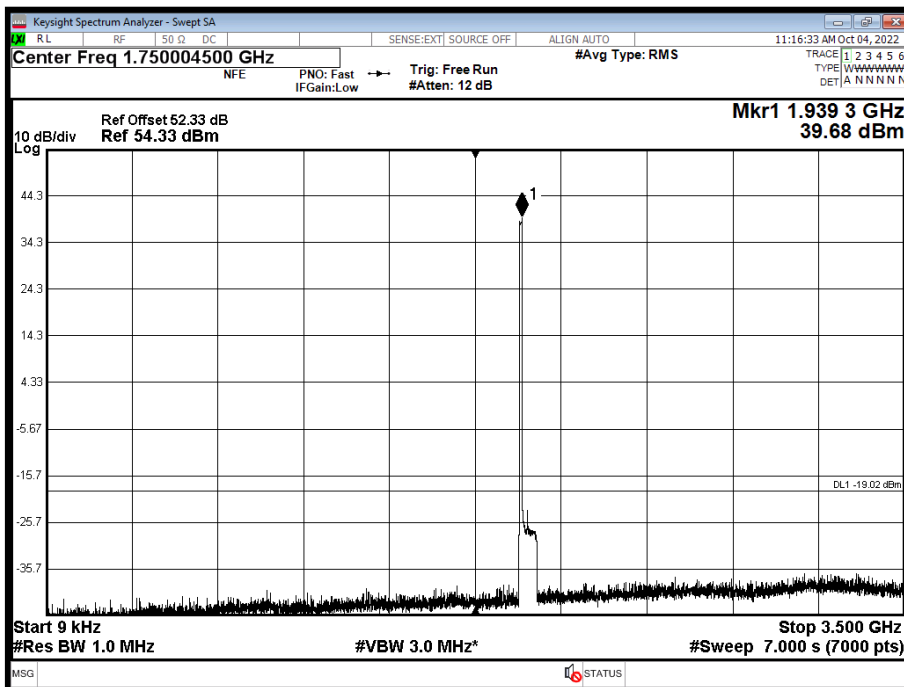

Antenna A - NR Modulation QPSK - NR Carrier Bandwidth 10.0 MHz 15 kHz SCS - Channel Position B - Band 2 - Range 3500 to 12000 MHz

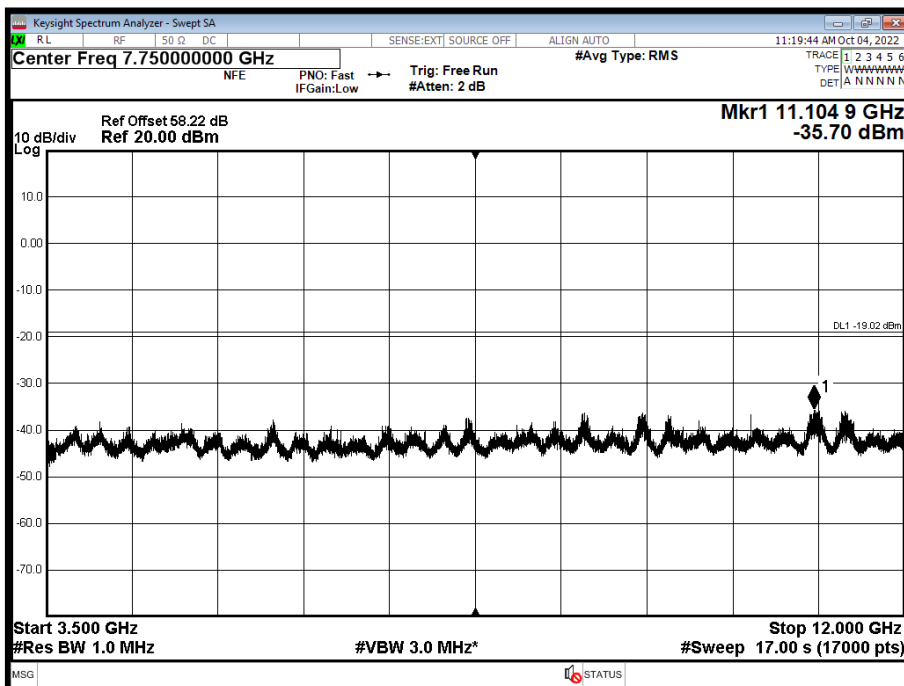



Antenna A - NR Modulation QPSK - NR Carrier Bandwidth 10.0 MHz 15 kHz SCS - Channel Position B - Band 3 - Range 12000 to 18000 MHz

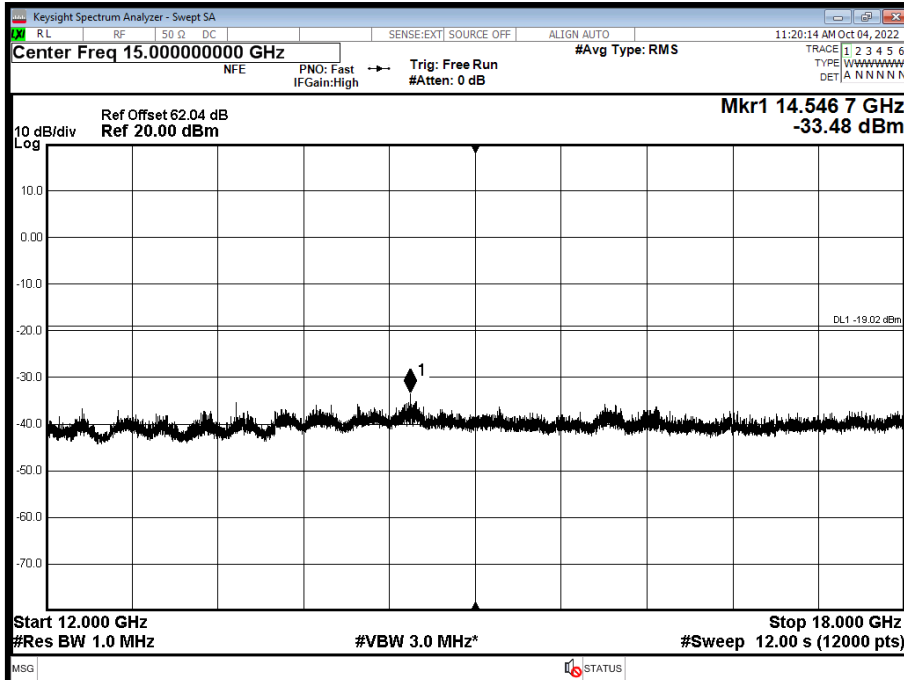

Antenna A - NR Modulation QPSK - NR Carrier Bandwidth 10.0 MHz 15 kHz SCS - Channel Position B - Band 4 - Range 18000 to 20000 MHz

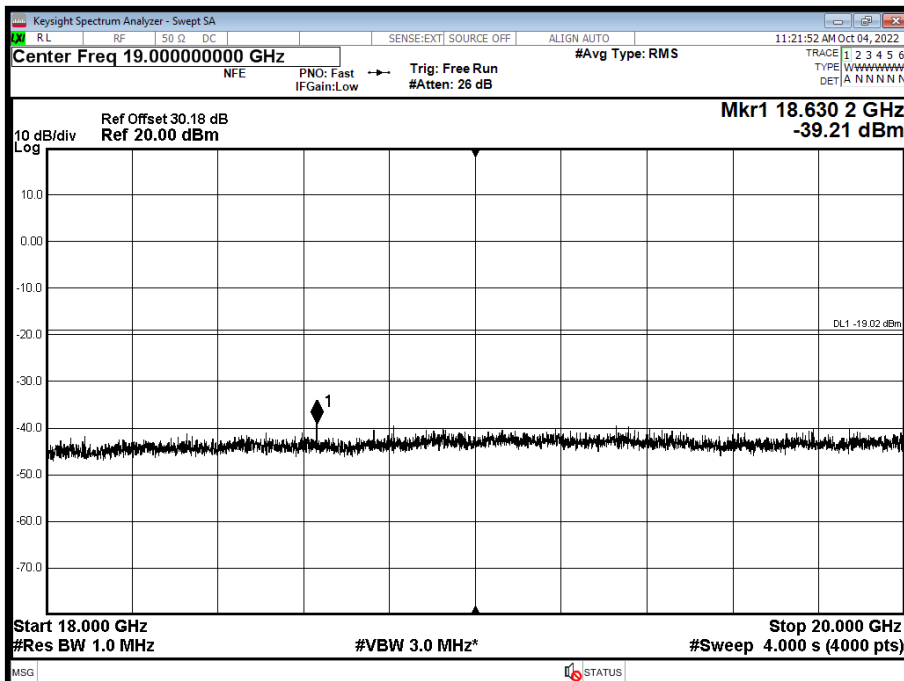



Antenna A - NR Modulation QPSK - NR Carrier Bandwidth 10.0 MHz 15 kHz SCS - Channel Position M - Band 1 - Range 0.009 to 3500 MHz

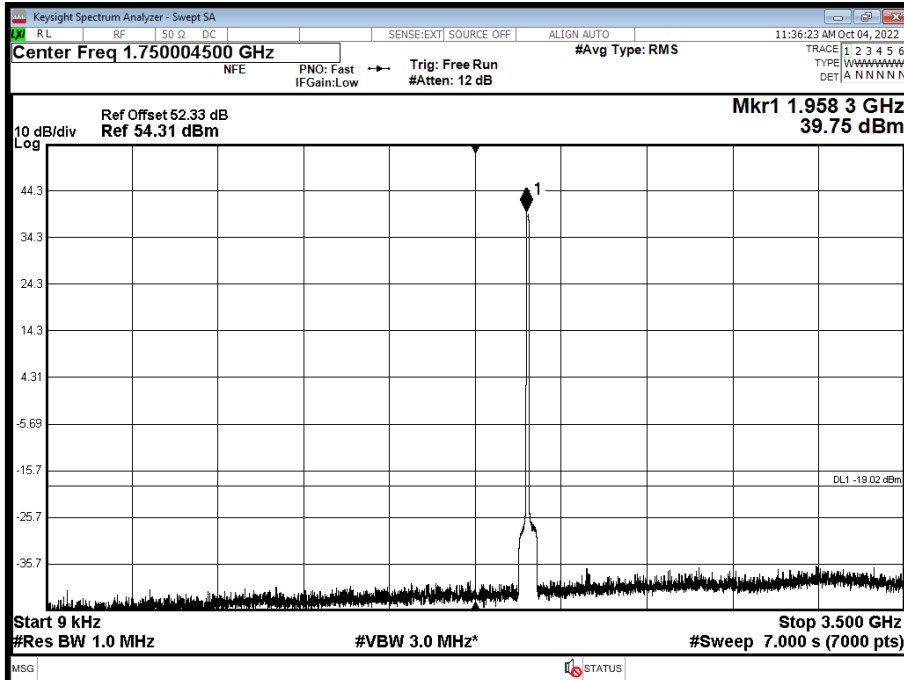

Antenna A - NR Modulation QPSK - NR Carrier Bandwidth 10.0 MHz 15 kHz SCS - Channel Position M - Band 2 - Range 3500 to 12000 MHz

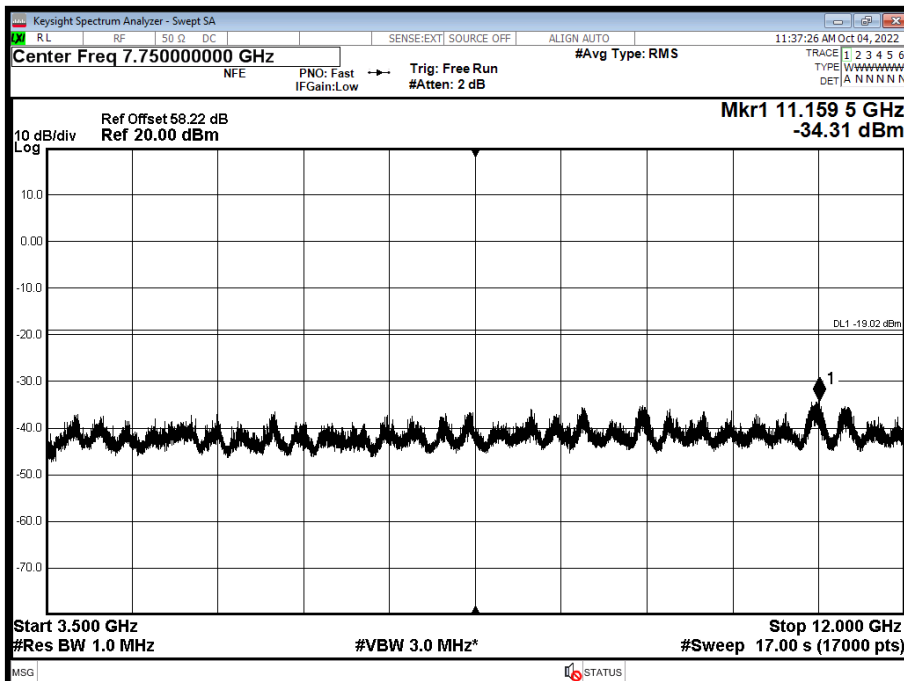



Antenna A - NR Modulation QPSK - NR Carrier Bandwidth 10.0 MHz 15 kHz SCS - Channel Position M - Band 3 - Range 12000 to 18000 MHz

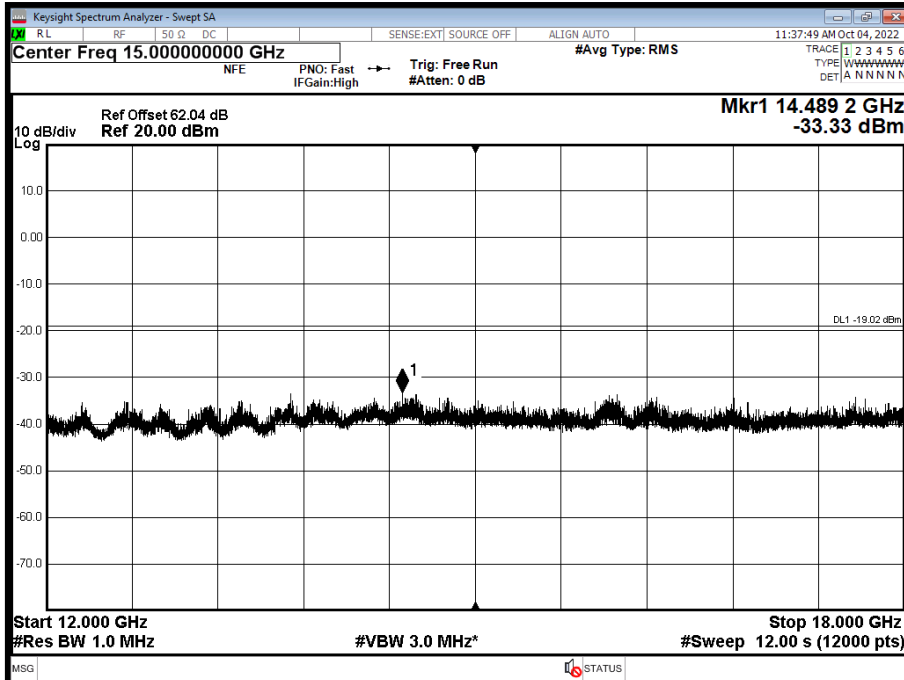

Antenna A - NR Modulation QPSK - NR Carrier Bandwidth 10.0 MHz 15 kHz SCS - Channel Position M - Band 4 - Range 18000 to 20000 MHz

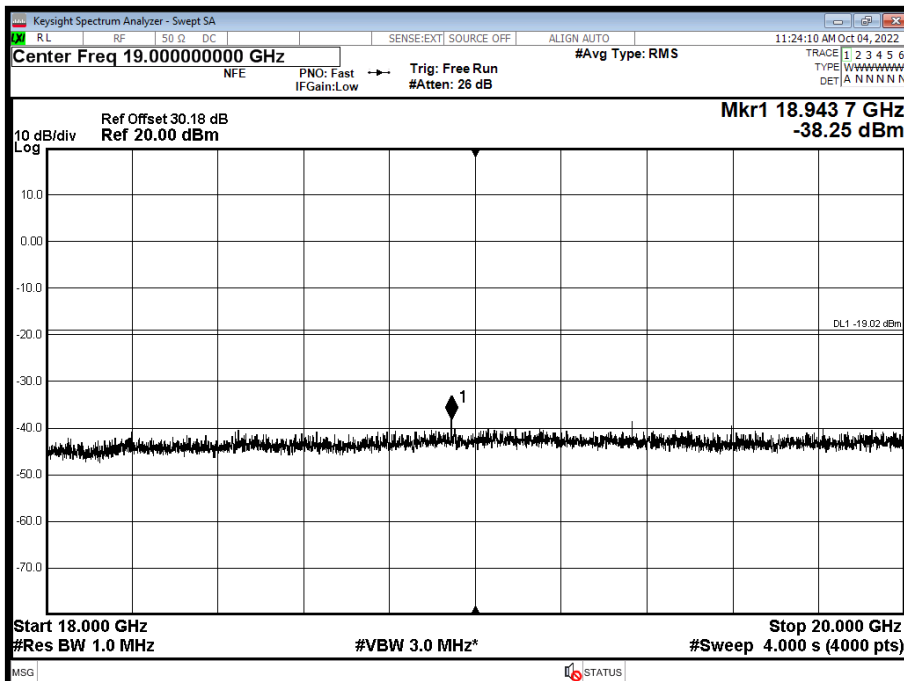



Antenna A - NR Modulation QPSK - NR Carrier Bandwidth 10.0 MHz 15 kHz SCS - Channel Position T - Band 1 - Range 0.009 to 3500 MHz

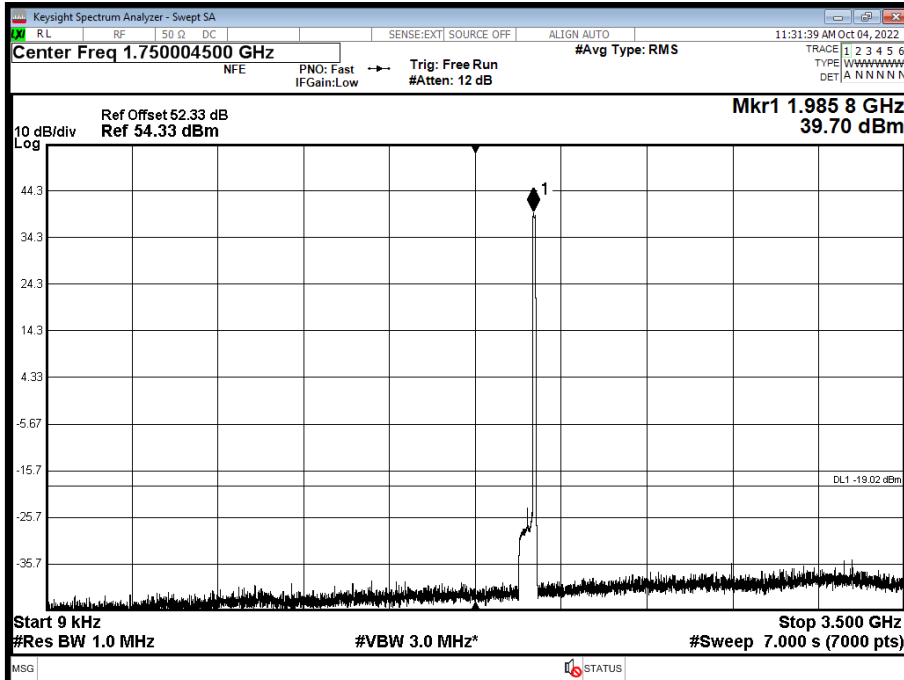

Antenna A - NR Modulation QPSK - NR Carrier Bandwidth 10.0 MHz 15 kHz SCS - Channel Position T - Band 2 - Range 3500 to 12000 MHz

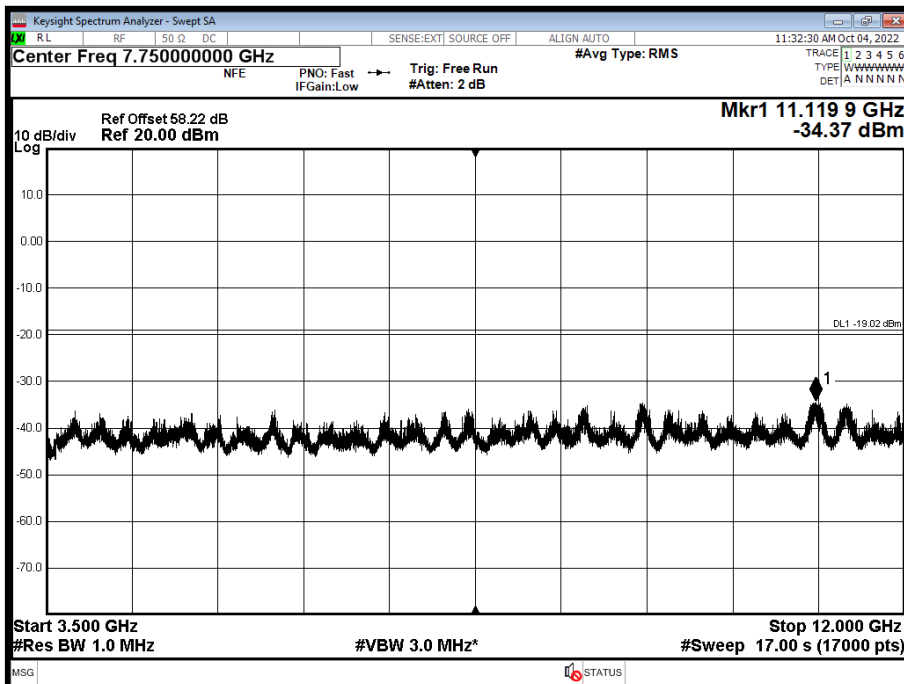



Antenna A - NR Modulation QPSK - NR Carrier Bandwidth 10.0 MHz 15 kHz SCS - Channel Position T - Band 3 - Range 12000 to 18000 MHz

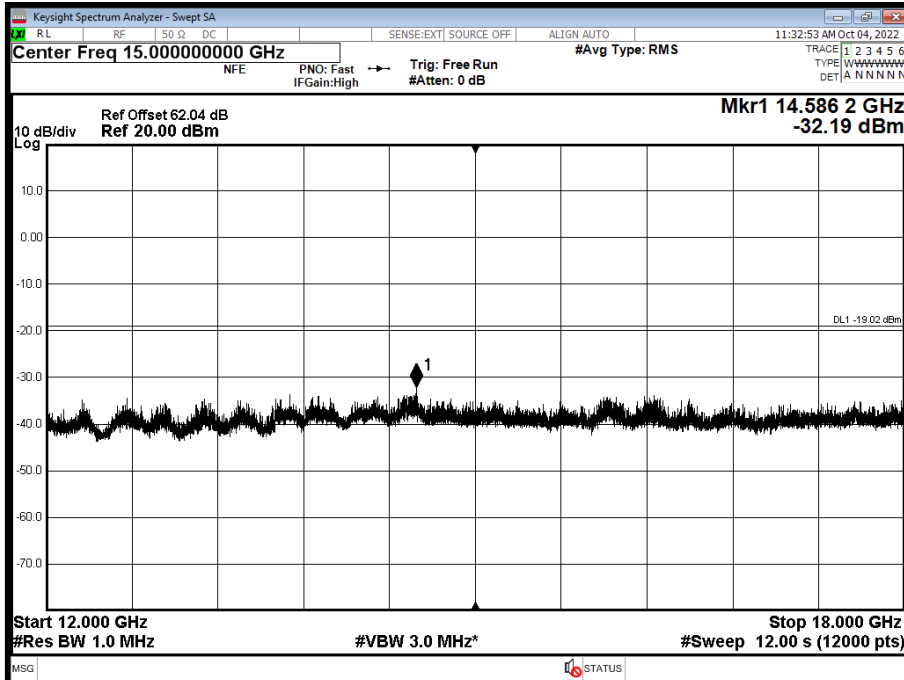

Antenna A - NR Modulation QPSK - NR Carrier Bandwidth 10.0 MHz 15 kHz SCS - Channel Position T - Band 4 - Range 18000 to 20000 MHz

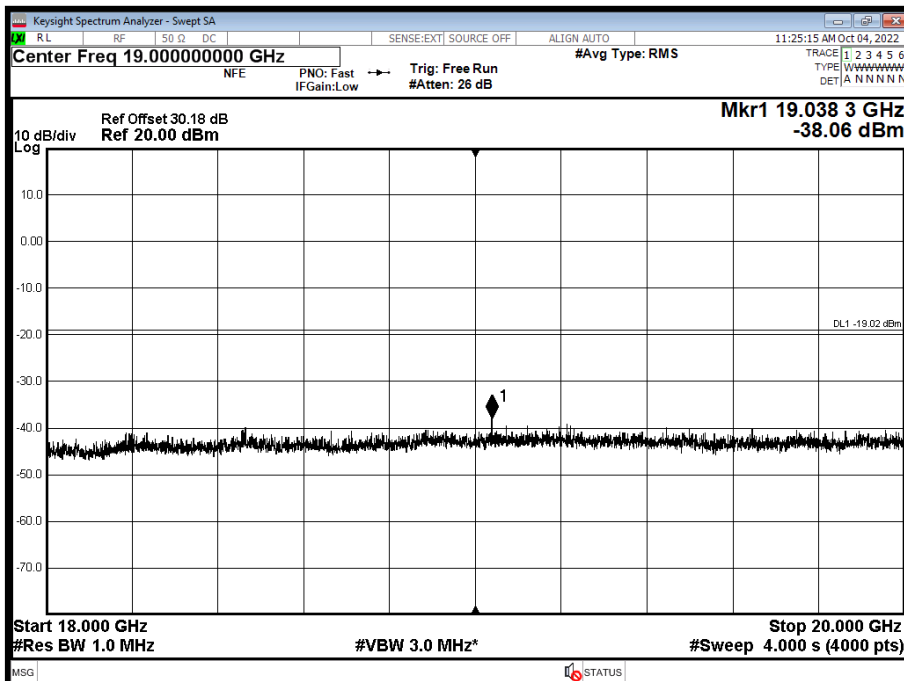



Antenna A - NR Modulation QPSK - NR Carrier Bandwidth 15.0 MHz 15 kHz SCS - Channel Position B - Band 1 - Range 0.009 to 3500 MHz

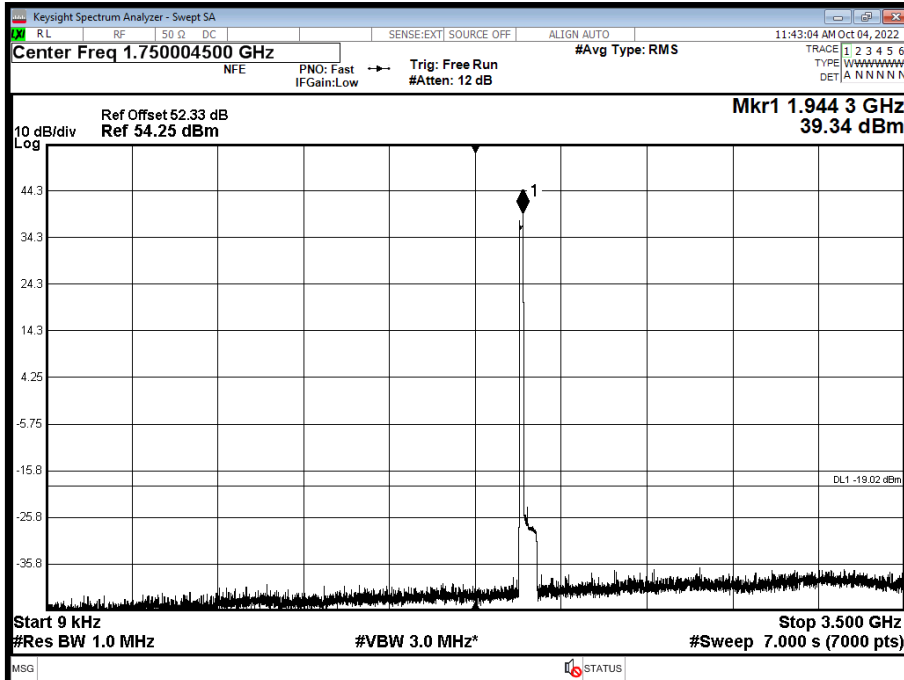

Antenna A - NR Modulation QPSK - NR Carrier Bandwidth 15.0 MHz 15 kHz SCS - Channel Position B - Band 2 - Range 3500 to 12000 MHz

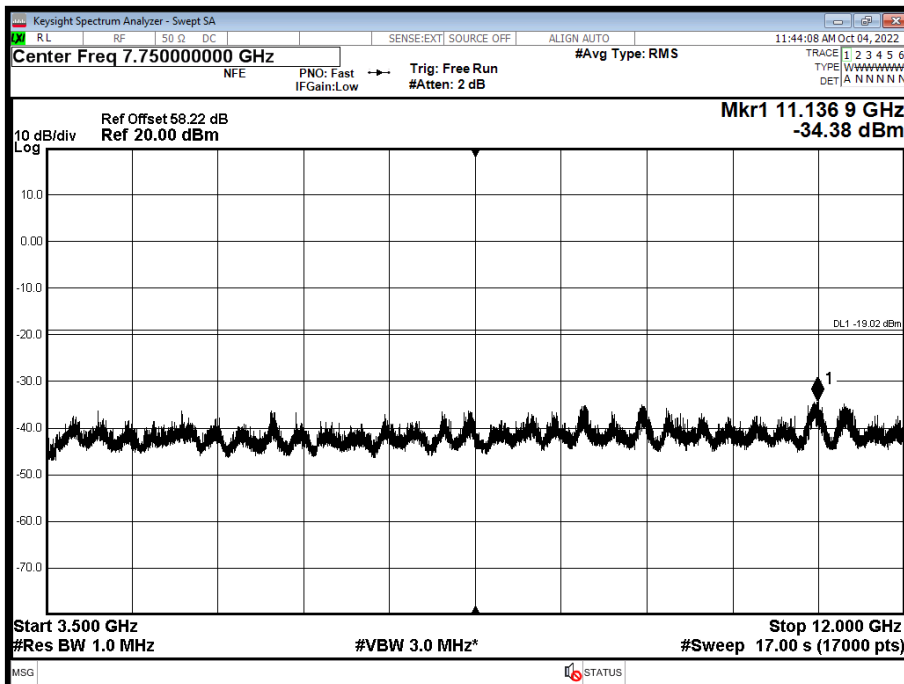



Antenna A - NR Modulation QPSK - NR Carrier Bandwidth 15.0 MHz 15 kHz SCS - Channel Position B - Band 3 - Range 12000 to 18000 MHz

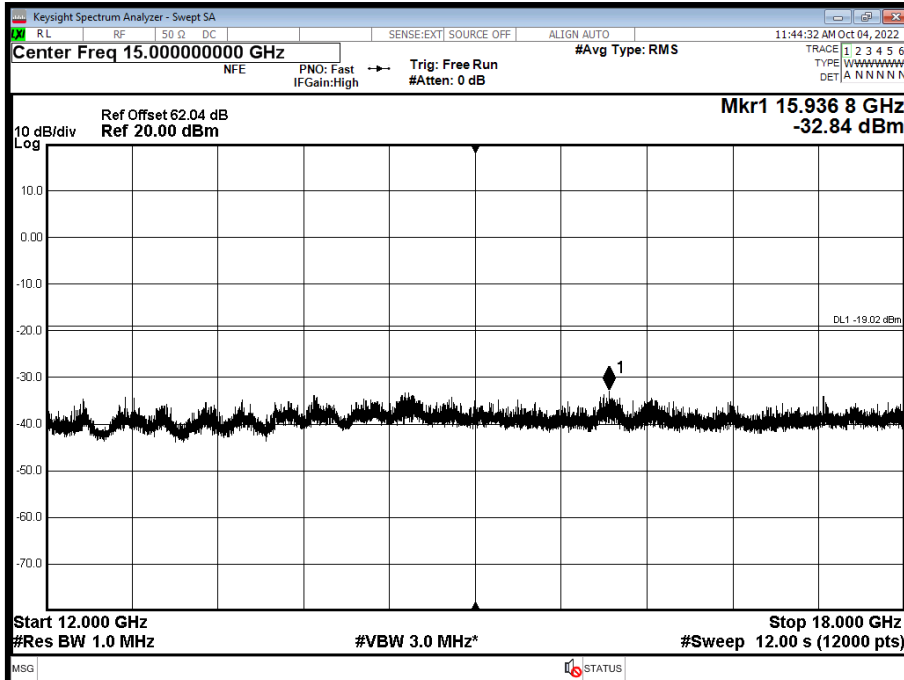

Antenna A - NR Modulation QPSK - NR Carrier Bandwidth 15.0 MHz 15 kHz SCS - Channel Position B - Band 4 - Range 18000 to 20000 MHz

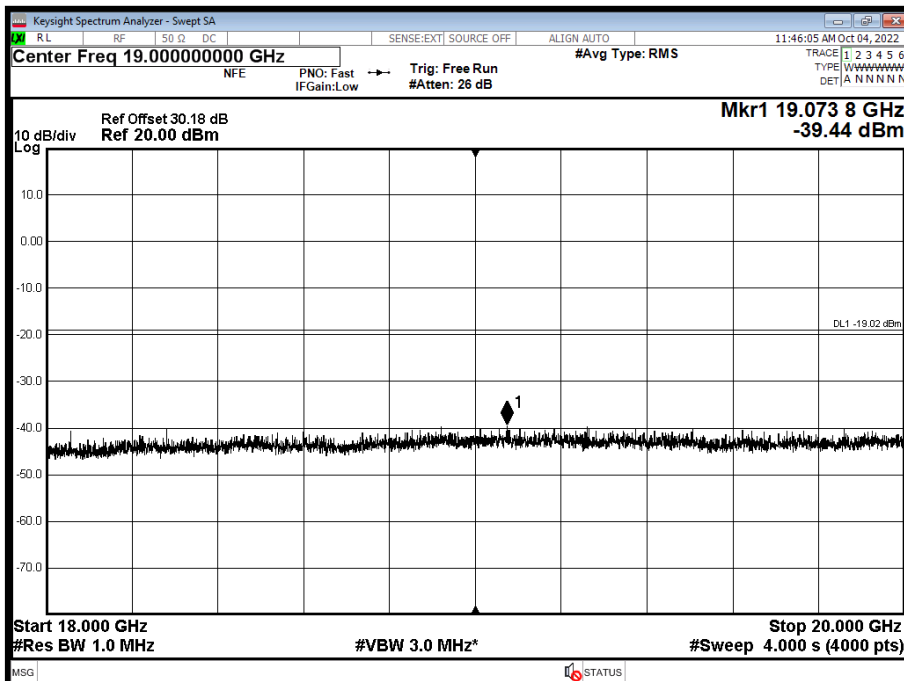



Antenna A - NR Modulation QPSK - NR Carrier Bandwidth 15.0 MHz 15 kHz SCS - Channel Position M - Band 1 - Range 0.009 to 3500 MHz

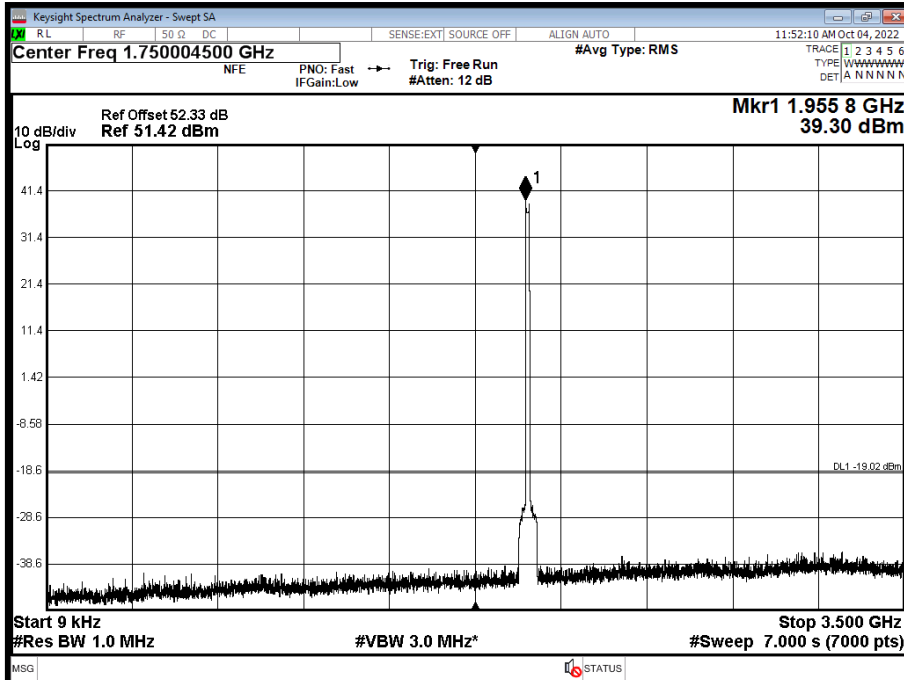

Antenna A - NR Modulation QPSK - NR Carrier Bandwidth 15.0 MHz 15 kHz SCS - Channel Position M - Band 2 - Range 3500 to 12000 MHz

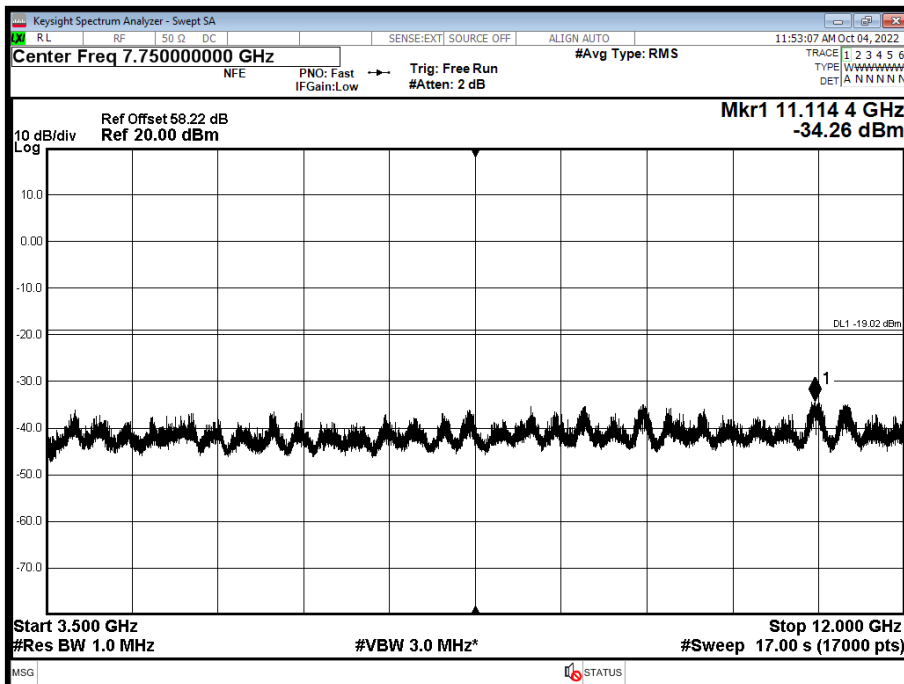



Antenna A - NR Modulation QPSK - NR Carrier Bandwidth 15.0 MHz 15 kHz SCS - Channel Position M - Band 3 - Range 12000 to 18000 MHz

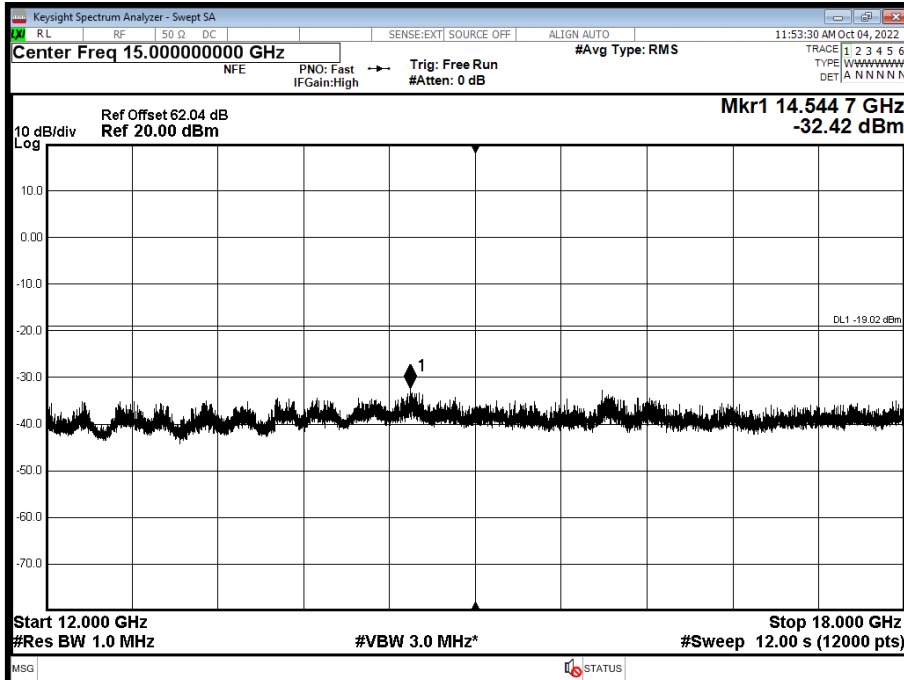

Antenna A - NR Modulation QPSK - NR Carrier Bandwidth 15.0 MHz 15 kHz SCS - Channel Position M - Band 4 - Range 18000 to 20000 MHz

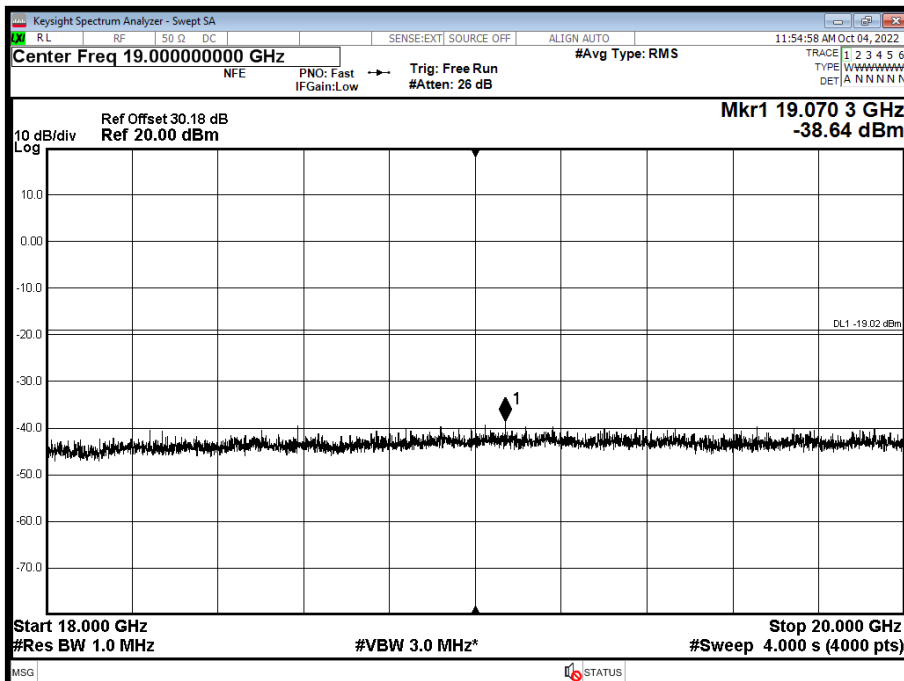



Antenna A - NR Modulation QPSK - NR Carrier Bandwidth 15.0 MHz 15 kHz SCS - Channel Position T - Band 1 - Range 0.009 to 3500 MHz

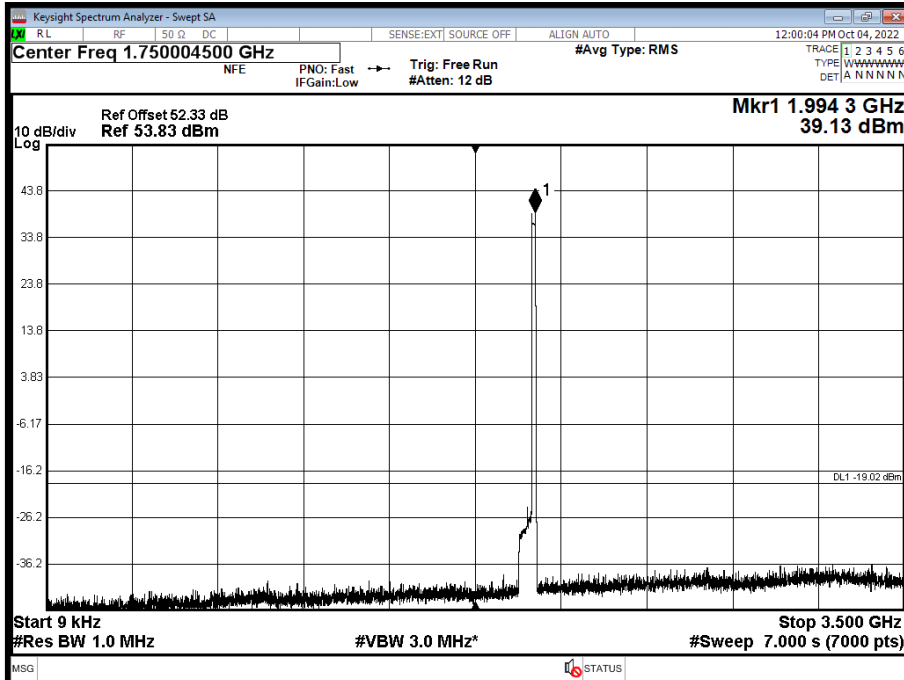

Antenna A - NR Modulation QPSK - NR Carrier Bandwidth 15.0 MHz 15 kHz SCS - Channel Position T - Band 2 - Range 3500 to 12000 MHz

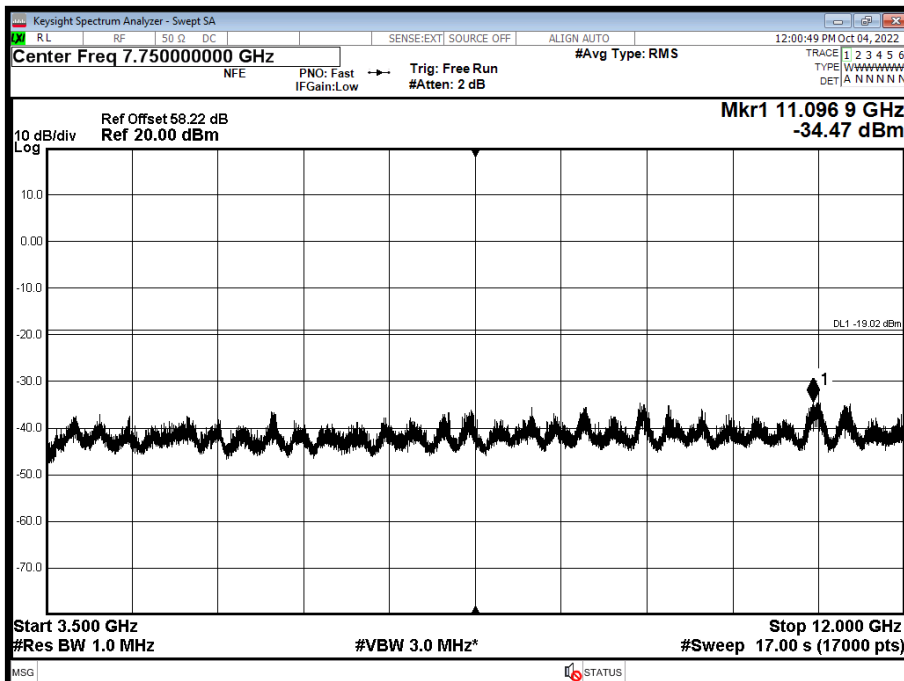



Antenna A - NR Modulation QPSK - NR Carrier Bandwidth 15.0 MHz 15 kHz SCS - Channel Position T - Band 3 - Range 12000 to 18000 MHz

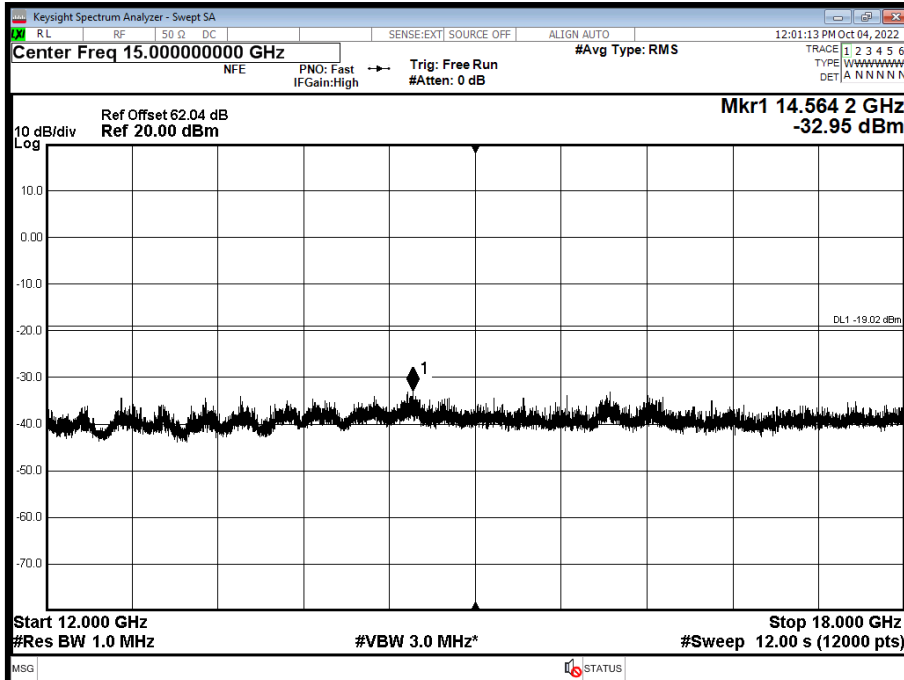

Antenna A - NR Modulation QPSK - NR Carrier Bandwidth 15.0 MHz 15 kHz SCS - Channel Position T - Band 4 - Range 18000 to 20000 MHz

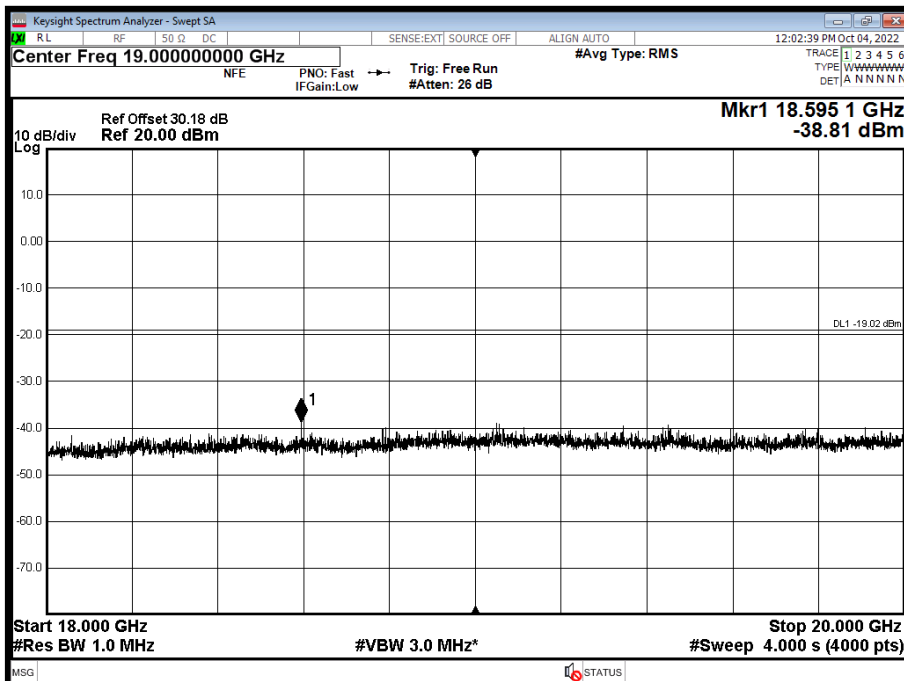



Antenna A - NR Modulation QPSK - NR Carrier Bandwidth 20.0 MHz 15 kHz SCS - Channel Position B - Band 1 - Range 0.009 to 3500 MHz

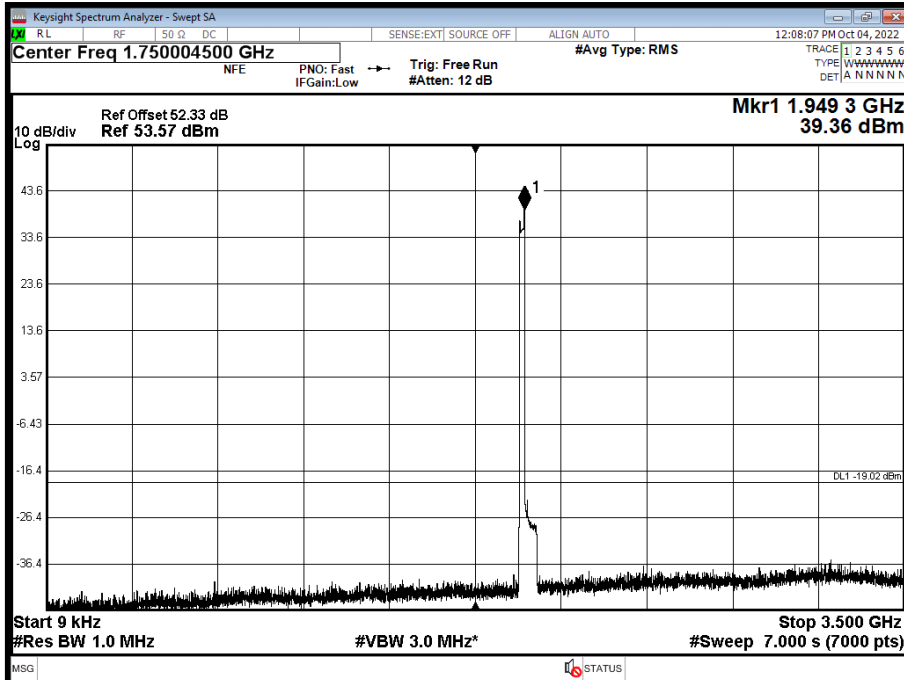

Antenna A - NR Modulation QPSK - NR Carrier Bandwidth 20.0 MHz 15 kHz SCS - Channel Position B - Band 2 - Range 3500 to 12000 MHz

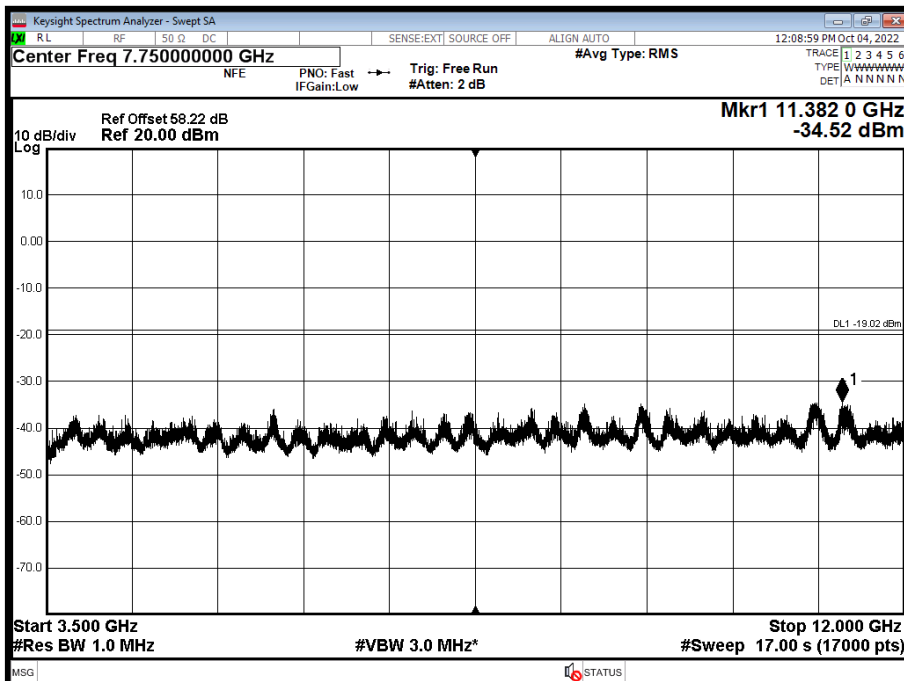



Antenna A - NR Modulation QPSK - NR Carrier Bandwidth 20.0 MHz 15 kHz SCS - Channel Position B - Band 3 - Range 12000 to 18000 MHz

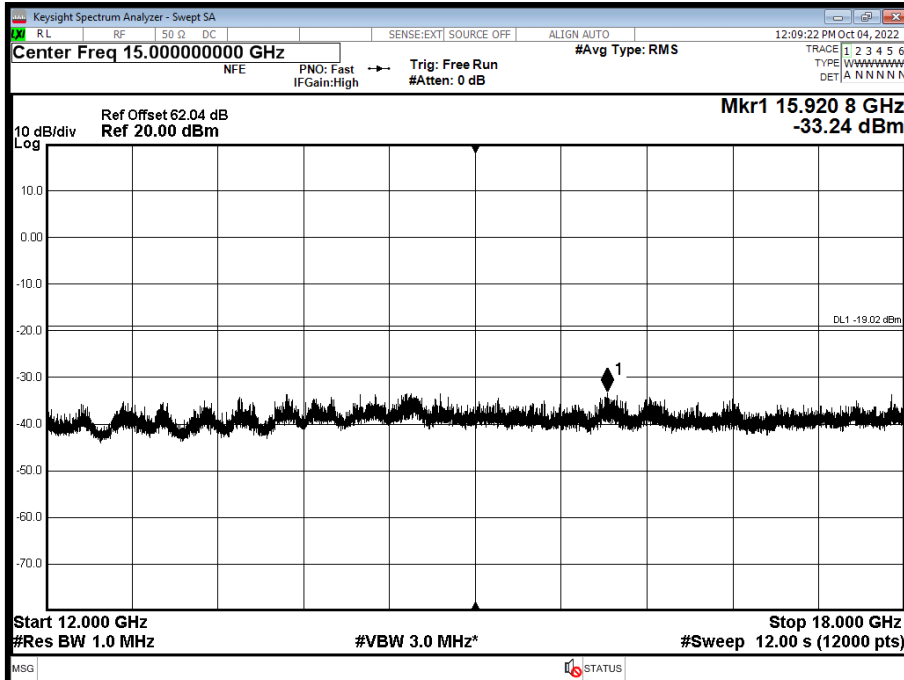

Antenna A - NR Modulation QPSK - NR Carrier Bandwidth 20.0 MHz 15 kHz SCS - Channel Position B - Band 4 - Range 18000 to 20000 MHz

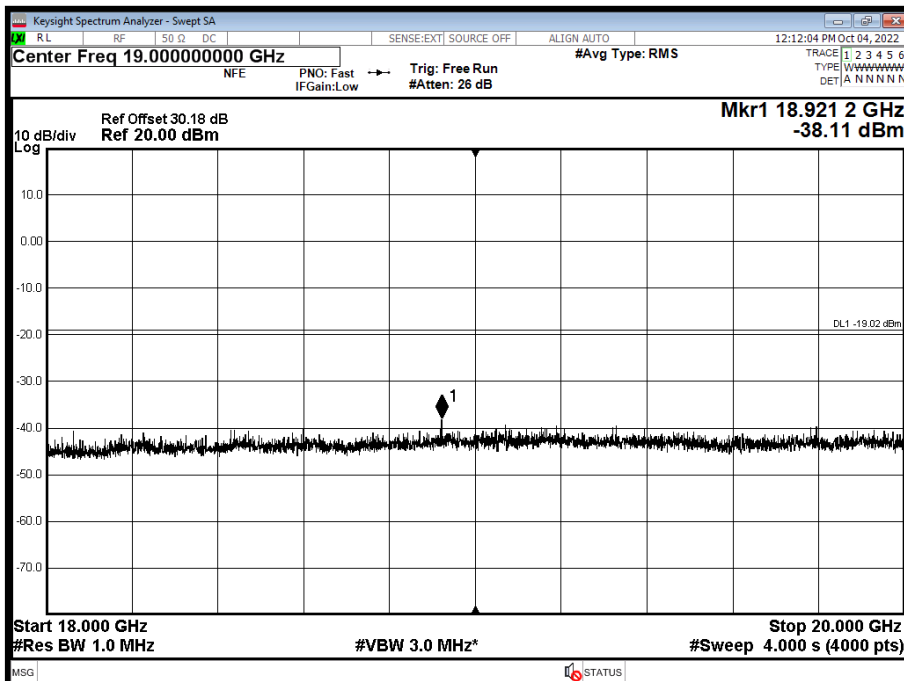



Antenna A - NR Modulation QPSK - NR Carrier Bandwidth 20.0 MHz 15 kHz SCS - Channel Position M - Band 1 - Range 0.009 to 3500 MHz

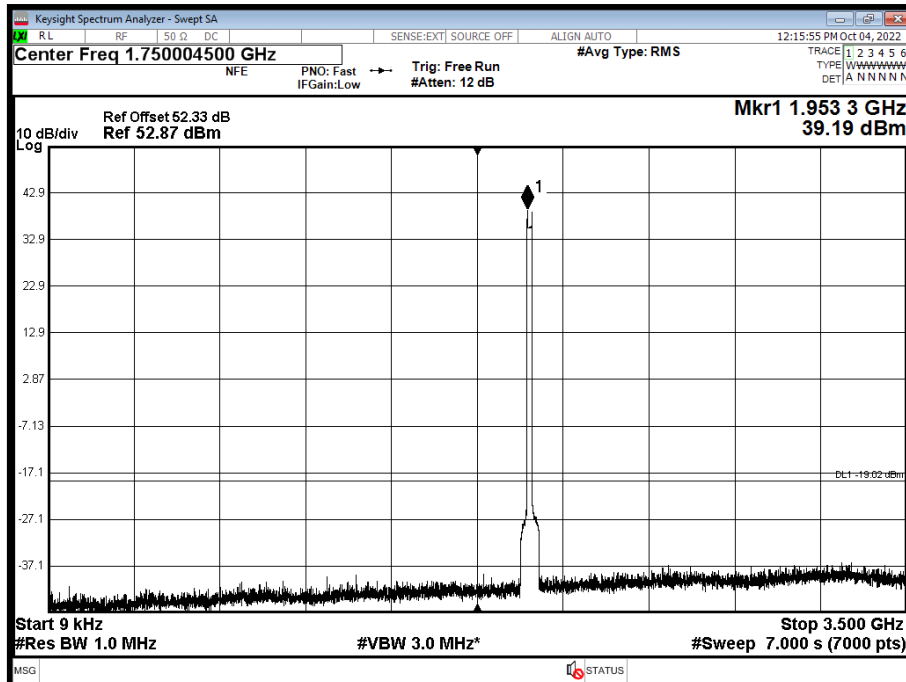

Antenna A - NR Modulation QPSK - NR Carrier Bandwidth 20.0 MHz 15 kHz SCS - Channel Position M - Band 2 - Range 3500 to 12000 MHz

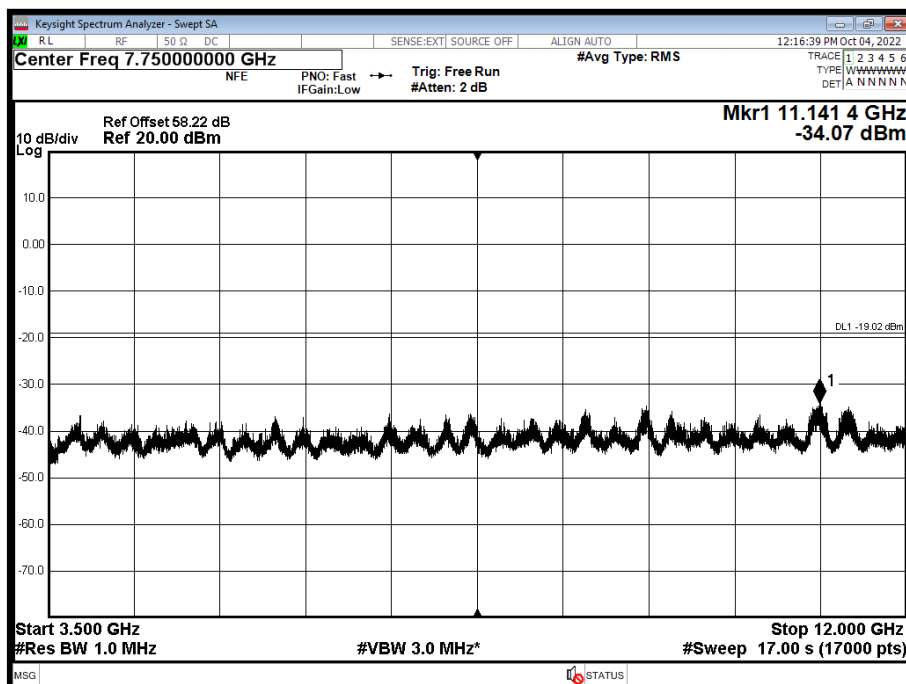



Antenna A - NR Modulation QPSK - NR Carrier Bandwidth 20.0 MHz 15 kHz SCS - Channel Position M - Band 3 - Range 12000 to 18000 MHz

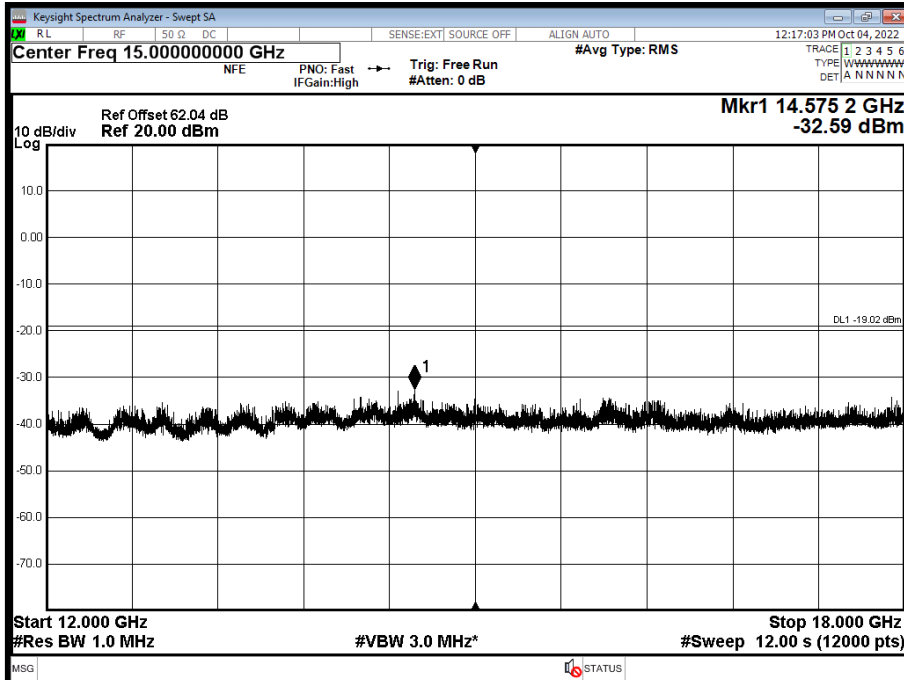

Antenna A - NR Modulation QPSK - NR Carrier Bandwidth 20.0 MHz 15 kHz SCS - Channel Position M - Band 4 - Range 18000 to 20000 MHz

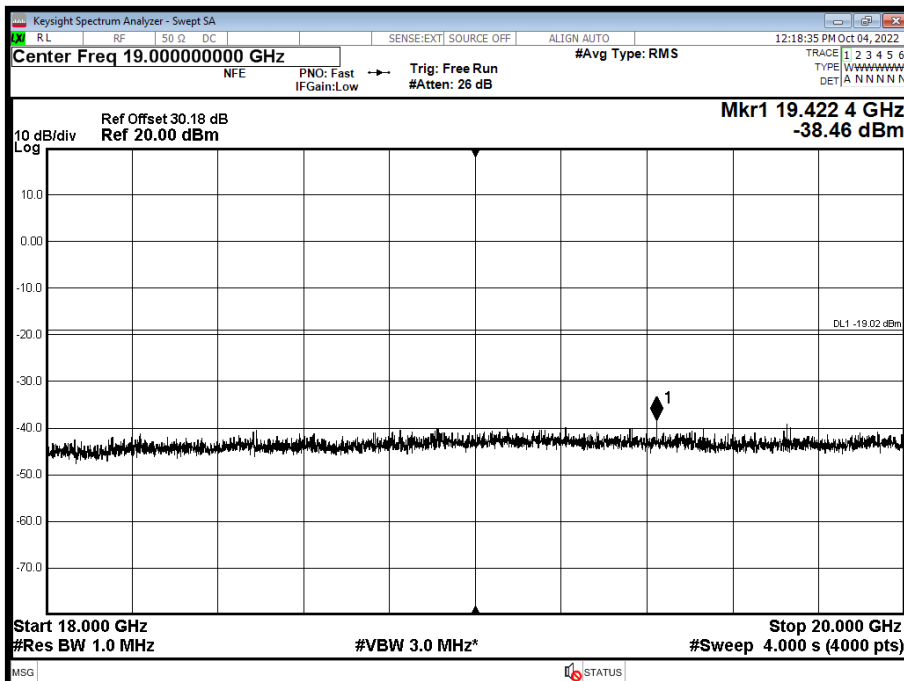



Antenna A - NR Modulation QPSK - NR Carrier Bandwidth 20.0 MHz 15 kHz SCS - Channel Position T - Band 1 - Range 0.009 to 3500 MHz

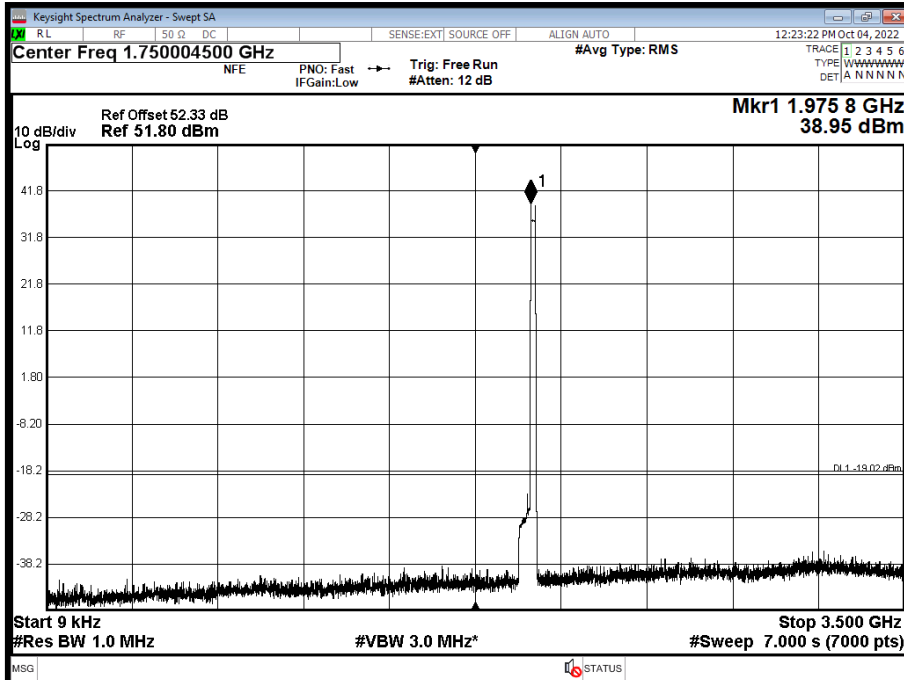

Antenna A - NR Modulation QPSK - NR Carrier Bandwidth 20.0 MHz 15 kHz SCS - Channel Position T - Band 2 - Range 3500 to 12000 MHz

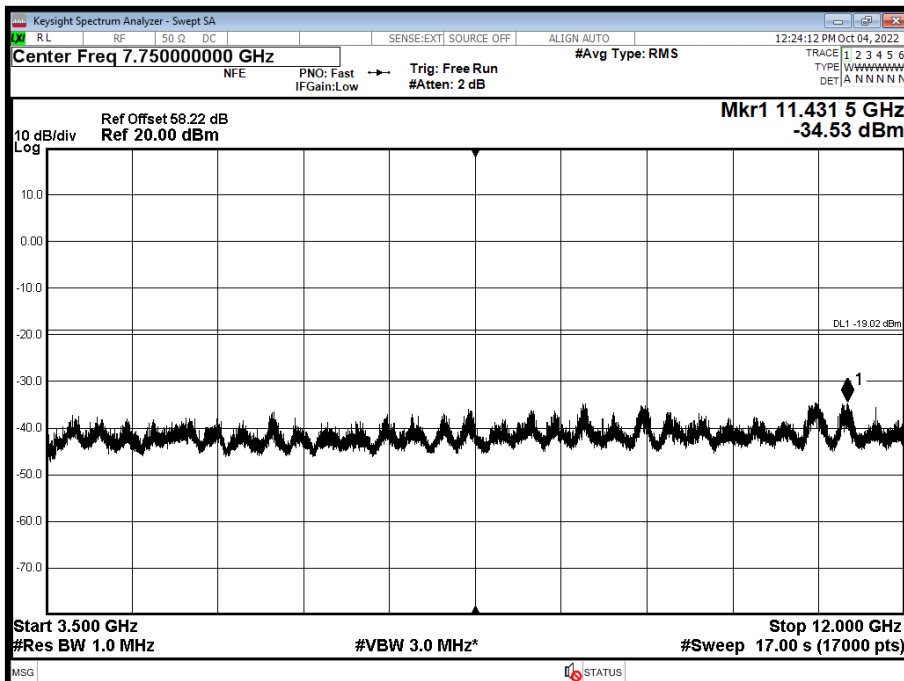



Antenna A - NR Modulation QPSK - NR Carrier Bandwidth 20.0 MHz 15 kHz SCS - Channel Position T - Band 3 - Range 12000 to 18000 MHz

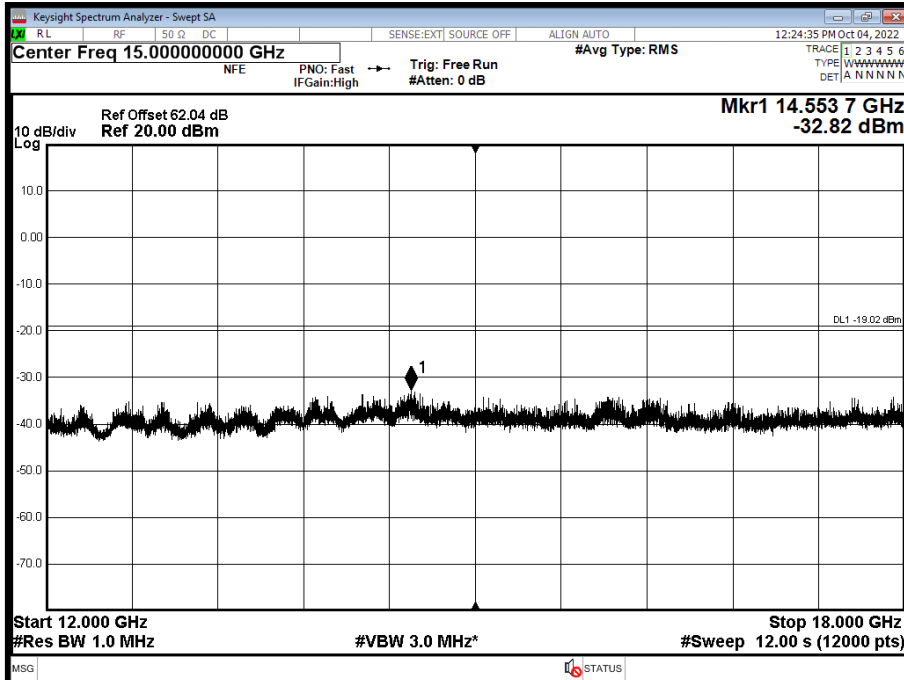

Antenna A - NR Modulation QPSK - NR Carrier Bandwidth 20.0 MHz 15 kHz SCS - Channel Position T - Band 4 - Range 18000 to 20000 MHz

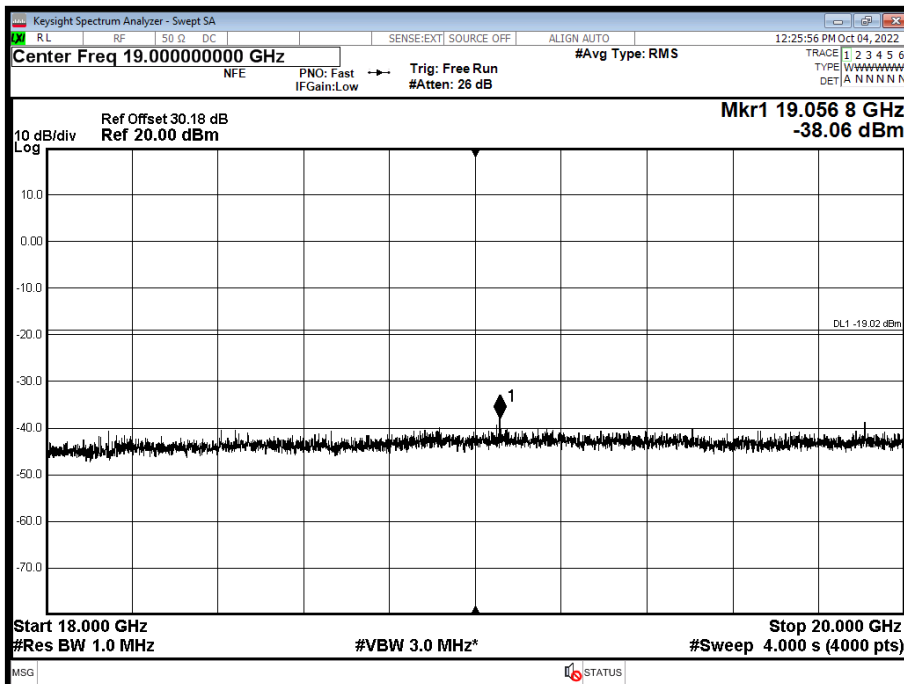

Limit	-13dBm
-------	--------



2.5 RADIATED EMISSIONS

2.5.1 Specification Reference

ISED RSS-GEN, Clause 6.13
Industry Canada RSS-133, Clause 6.5
FCC CFR 47 Part 2, Clause 2.1053

2.5.2 Date of Test and Modification State

10-October-2022 - Modification State 0

2.5.3 Test Equipment Used

The major items of test equipment used for the above tests are identified in Section 3.1.

2.5.4 Environmental Conditions

Ambient Temperature 24.0°C
Relative Humidity 45.5%

2.5.5 Test Method

The test was performed in accordance with ANSI C63.26 Clause 5. The EUT was configured as defined in ANSI C63.26, clause 5.5.2.3.2.

The EUT was set up on a support replicating typical installation conditions at a height of 0.8 m above the reference ground plane for measurements below 1GHz, (see setup photos) within a semi-anechoic chamber on a remotely controlled turntable. Above 1 GHz, the height was increased to 1.5 m above the reference ground plane.

2.5.6 Test Results

Configuration 1

Maximum Output Power 47.78 dBm

Frequency (MHz)	Level (dBm)	Limit (dBm)	Margin (dB)	Detector	Angle (°)	Height (cm)	Polarisation
*							

Top - NR&NB-IoT - B2, 1985MHz, 30 MHz to 22.5 GHz

*No emissions found within 6 dB of the limit.

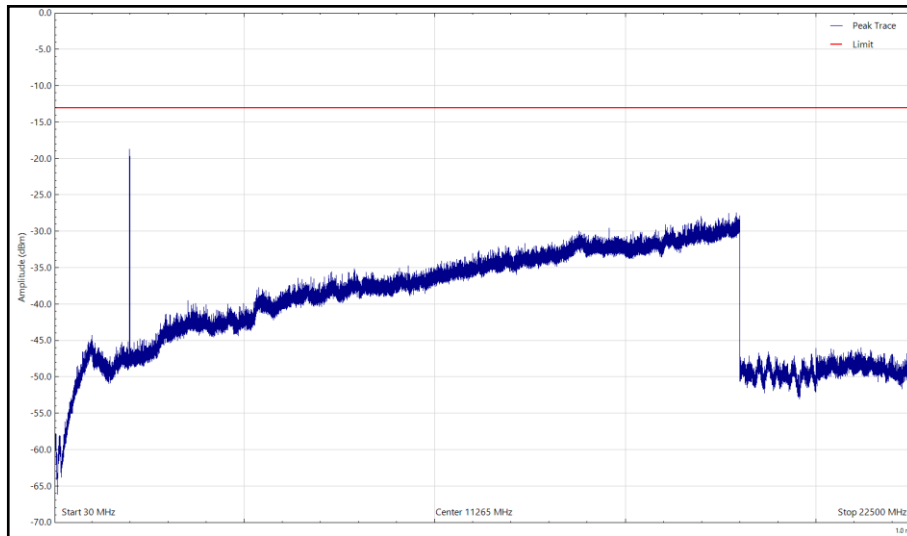

Top - NR&NB-IoT - B2, 1985MHz, 30 MHz to 22.5 GHz, Horizontal (Peak)

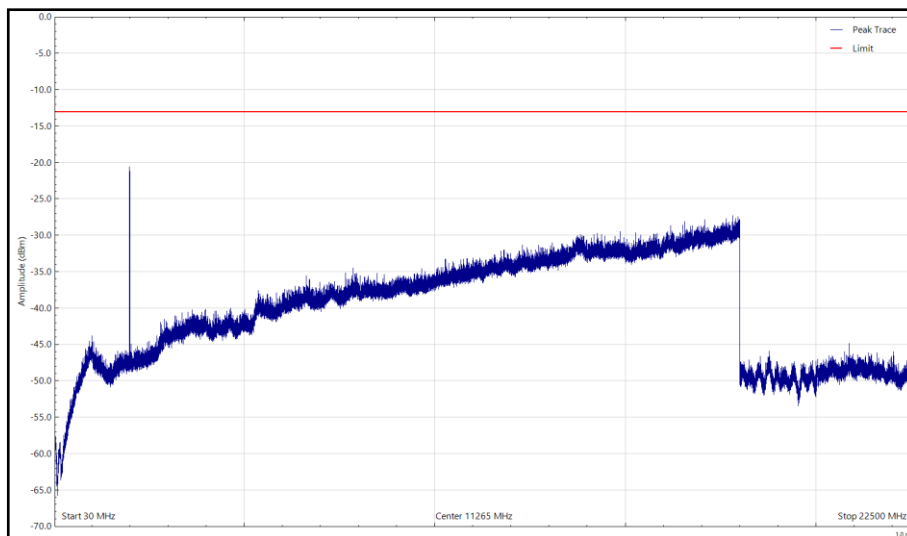

Top - NR&NB-IoT - B2, 1985MHz, 30 MHz to 22.5 GHz, Vertical (Peak)



Frequency (MHz)	Level (dBm)	Limit (dBm)	Margin (dB)	Detector	Angle (°)	Height (cm)	Polarisation
*							

Top - NR&NB-IoT - B25, 1990MHz, 30 MHz to 22.5 GHz

*No emissions found within 6 dB of the limit.

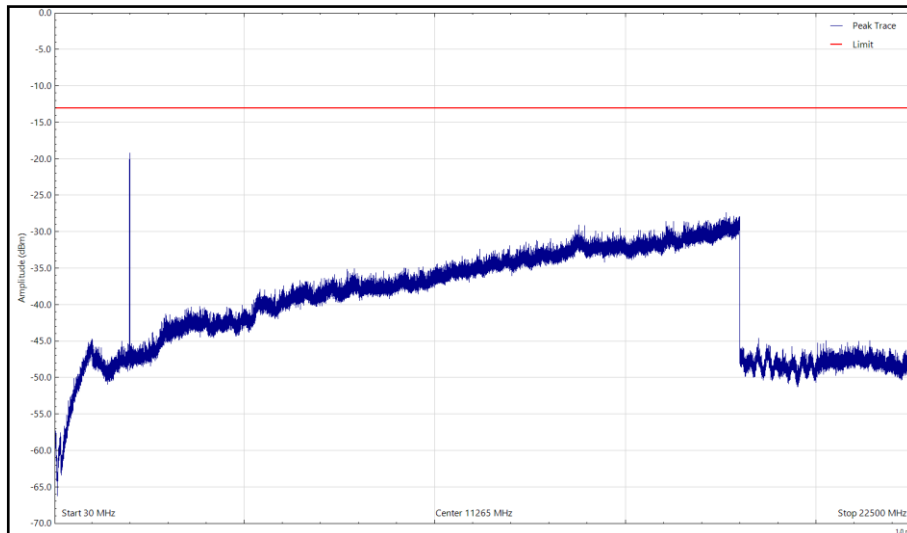

Top - NR&NB-IoT - B25, 1990MHz, 30 MHz to 22.5 GHz, Horizontal (Peak)

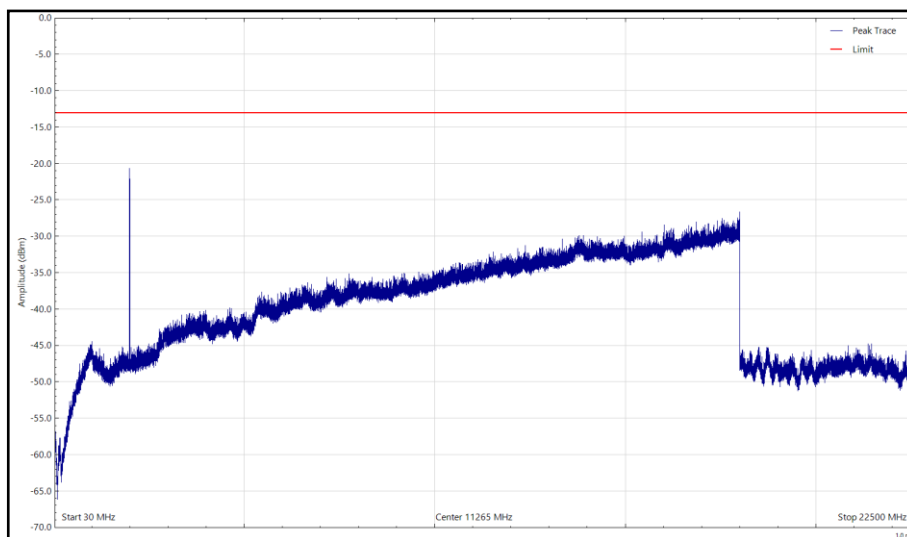

Top - NR&NB-IoT - B25, 1990MHz, 30 MHz to 22.5 GHz, Vertical (Peak)



Frequency (MHz)	Level (dBm)	Limit (dBm)	Margin (dB)	Detector	Angle (°)	Height (cm)	Polarisation
*							

Bot - NR&NB-IoT - B25, 1935MHz, 30 MHz to 22.5 GHz

*No emissions found within 6 dB of the limit.

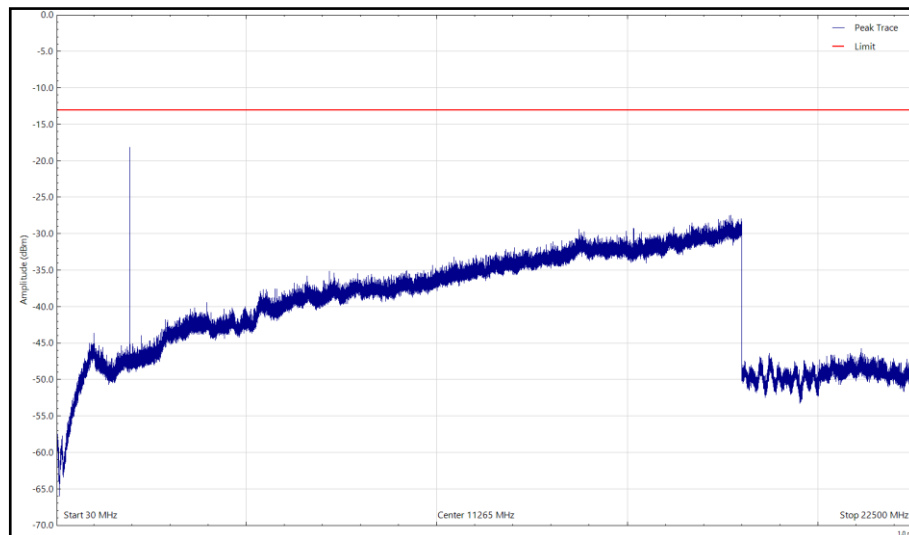

Bot - NR&NB-IoT - B25, 1935MHz, 30 MHz to 22.5 GHz, Horizontal (Peak)

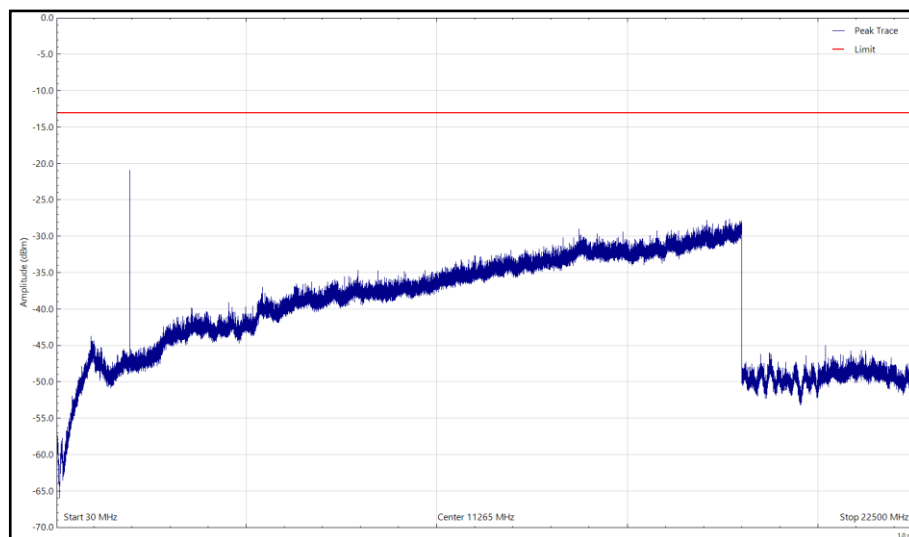

Bot - NR&NB-IoT - B25, 1935MHz, 30 MHz to 22.5 GHz, Vertical (Peak)



Frequency (MHz)	Level (dBm)	Limit (dBm)	Margin (dB)	Detector	Angle (°)	Height (cm)	Polarisation
*							

Mid - NR&NB-IoT - B25, 1962.5MHz, 30 MHz to 22.5 GHz

*No emissions found within 6 dB of the limit.

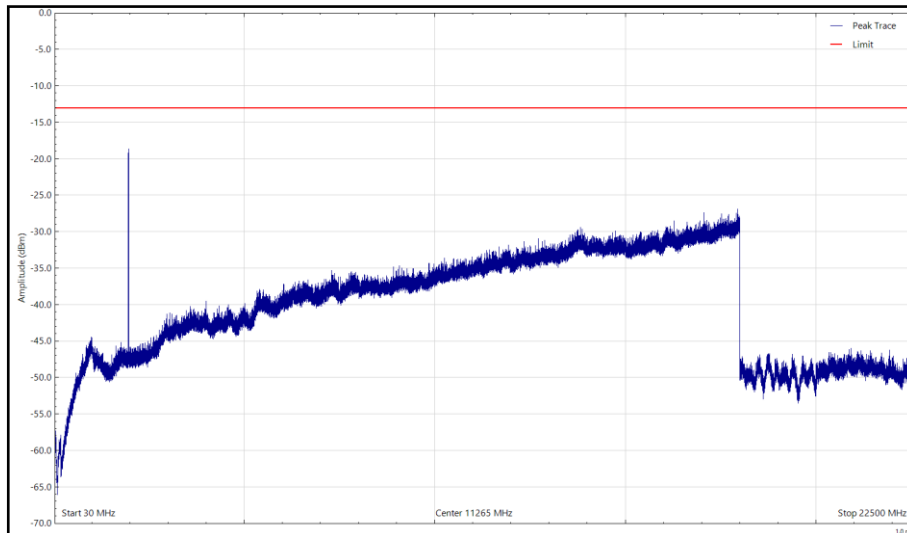

Mid - NR&NB-IoT - B25, 1962.5MHz, 30 MHz to 22.5 GHz, Horizontal (Peak)

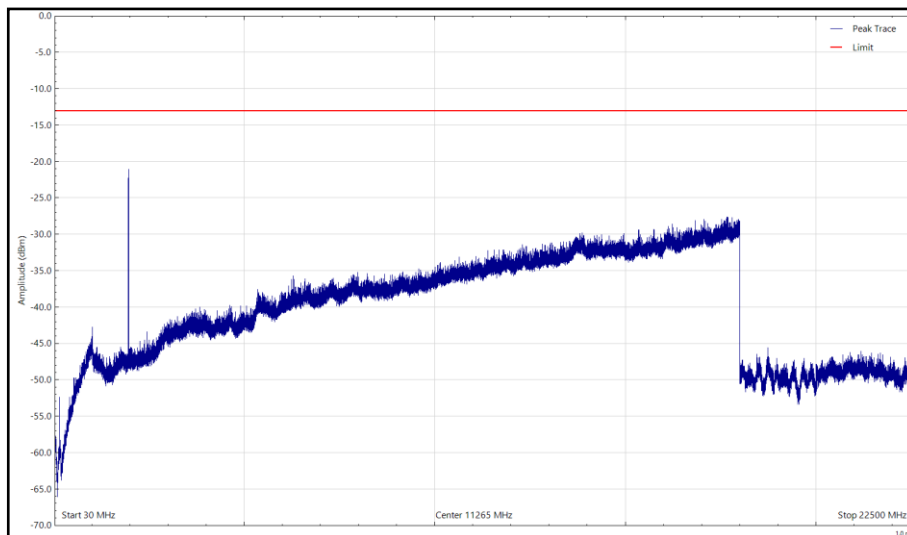

Mid - NR&NB-IoT - B25, 1962.5MHz, 30 MHz to 22.5 GHz, Vertical (Peak)

Limit	-13.0 dBm
-------	-----------



SECTION 3

TEST EQUIPMENT USED



3.1 TEST EQUIPMENT USED

List of absolute measuring and other principal items of test equipment.

Instrument	Manufacturer	Type No.	TE No.	Calibration Period (months)	Calibration Due
Maximum Peak Output Power and Peak to Average Ratio - Conducted					
Hygrometer	PCE Instruments	PCE-THB-40	5475	12	25-Apr-2023
Frequency Standard	Spectracom	SecureSync 1200-0408-0601	4393	6	01-Feb-2023
Analyser	Keysight	N9030A	4654	12	24-Nov-2022
Power Supply	Farnell	H60-25	1092	-	OP-MON
Multimeter	Fluke	177	3833	12	16-Dec-2022
Attenuator	Weinschel	48-20-43-LIM	5133	12	02-Dec-2022
Attenuator	Weinschel	48-30-43-LIM	5135	12	20-Aug-2023
Network Analyser	Rohde & Schwarz	ZVA 40	3548	12	24-Feb-2023
Calibration kit	Rohde & Schwarz	ZV-Z55	4368	12	24-Feb-2023
Occupied Bandwidth					
Hygrometer	PCE Instruments	PCE-THB-40	5475	12	25-Apr-2023
Frequency Standard	Spectracom	SecureSync 1200-0408-0601	4393	6	01-Feb-2023
Analyser	Keysight	N9030A	4654	12	24-Nov-2022
Power Supply	Farnell	H60-25	1092	-	OP-MON
Multimeter	Fluke	177	3833	12	16-Dec-2022
Attenuator	Weinschel	48-20-43-LIM	5133	12	02-Dec-2022
Attenuator	Weinschel	48-30-43-LIM	5135	12	20-Aug-2023
Network Analyser	Rohde & Schwarz	ZVA 40	3548	12	24-Feb-2023
Calibration kit	Rohde & Schwarz	ZV-Z55	4368	12	24-Feb-2023
Band Edge					
Hygrometer	PCE Instruments	PCE-THB-40	5475	12	25-Apr-2023
Frequency Standard	Spectracom	SecureSync 1200-0408-0601	4393	6	01-Feb-2023
Analyser	Keysight	N9030A	4654	12	24-Nov-2022
Power Supply	Farnell	H60-25	1092	-	OP-MON
Multimeter	Fluke	177	3833	12	16-Dec-2022
Attenuator	Weinschel	48-20-43-LIM	5133	12	02-Dec-2022
Attenuator	Weinschel	48-30-43-LIM	5135	12	20-Aug-2023
Network Analyser	Rohde & Schwarz	ZVA 40	3548	12	24-Feb-2023
Calibration kit	Rohde & Schwarz	ZV-Z55	4368	12	24-Feb-2023
Transmitter Spurious Emissions					
Hygrometer	PCE Instruments	PCE-THB-40	5475	12	25-Apr-2023
Frequency Standard	Spectracom	SecureSync 1200-0408-0601	4393	6	01-Feb-2023
Analyser	Keysight	N9030A	4654	12	24-Nov-2022



Instrument	Manufacturer	Type No.	TE No.	Calibration Period (months)	Calibration Due
Power Supply	Farnell	H60-25	1092	-	OP-MON
Multimeter	Fluke	177	3833	12	16-Dec-2022
Attenuator	Weinschel	48-20-43-LIM	5133	12	02-Dec-2022
Attenuator	Weinschel	48-30-43-LIM	5135	12	20-Aug-2023
Network Analyser	Rohde & Schwarz	ZVA 40	3548	12	24-Feb-2023
Calibration kit	Rohde & Schwarz	ZV-Z55	4368	12	24-Feb-2023
Waveguide filter	Quasar	QWS20SB-UBR-UBR-50	5789	12	12-May-2023
WG20 Coaxial Adapter	Quasar	QWC20SB-UBR-K-F	5785	-	OP-MON
WG20 Coaxial Adapter	Quasar	QWC20SB-UBR-K-F	5786	-	OP-MON
Cable attenuator	Aralab	CSF6767C-C2S6500	5175	-	OP-MON
HPF	Wainwright	WHKX12-2580-3000-18000-80SS	5547	12	11-May-2023
Radiated Emissions					
True RMS Multimeter	Fluke	79 Series III	411.00	12.00	13-Oct-2022
Power Supply (60V-50A)	Farnell	H 60/50	1056.00	0.00	TU
Screened Room (5)	Rainford	Rainford	1545.00	36.00	15-Apr-2024
Turntable Controller	Inn-Co GmbH	CO 1000	1606.00	0.00	TU
Hygromer	Rotronic	Hygropalm	2404.00	12.00	18-Jul-2023
Signal Analyser	Rohde & Schwarz	FSQ 26	3545.00	12.00	27-Apr-2023
Mast Controller	Maturo GmbH	NCD	4810.00	0.00	TU
Tilt Antenna Mast	Maturo GmbH	TAM 4.0-P	4811.00	0.00	TU
Antenna (DRG 1-10.5GHz)	Schwarzbeck	BBHA9120B	4848.00	12.00	28-May-2023
Cable (SMA to SMA, 2 m)	Junkosha	MWX221-02000AMSAMS/A	5517.00	12.00	12-Apr-2023
Cable (N-Type to N-Type, 8 m)	Junkosha	MWX221-08000NMSNMS/B	5520.00	12.00	24-Mar-2023
EMI Test Receiver	Rohde & Schwarz	ESW44	5527.00	12.00	28-Apr-2023
Cable (K Type 2m)	Junkosha	MWX241-01000KMSKMS/B	5936.00	12.00	14-May-2023
TRILOG Super Broadband Test Antenna	Schwarzbeck	VULB 9168	5942.00	24.00	03-Feb-2024
Double Ridge Active Horn Antenna (18-40 GHz)	Com-Power	AHA-840	6189.00	24.00	02-Jun-2024
Attenuator 4dB	Pasternack	PE7074-4	6204.00	24.00	16-Jul-2024

TU – Traceability Unschedule

N/A – Not Applicable

O/P Mon – Output Monitored with Calibrated Equipment



3.2 MEASUREMENT UNCERTAINTY

For a 95% confidence level, the measurement uncertainties for defined systems are:-

Test Discipline	Frequency / Parameter	MU
Conducted Maximum Peak Output Power	9 kHz to 40 GHz Amplitude	± 1.0 dB
Conducted Emissions	9 kHz to 40 GHz Amplitude	± 3.5 dB
Occupied Bandwidth	10 MHz Bandwidth	± 16.7 kHz
	15 MHz Bandwidth	
	20 MHz Bandwidth	
Band Edge	< 3.6 GHz Amplitude	± 0.6 dB
Radiated Spurious Emissions	30 MHz to 1 GHz	± 5.2 dB
	1 GHz to 40 GHz	± 6.3 dB

Measurement Uncertainty Decision Rule

Determination of conformity with the specification limits is based on the results of the compliance measurement and does not take into account measurement instrumentation uncertainty as defined in ANSI C63.26:2015 Clause 1.3.

Risk: The uncertainty of measurement about the measured result is negligible with regard to the final pass/fail decision. The measurement result can be directly compared with the test limit to determine conformance with the requirement (compare IEC Guide 115). The level of risk to falsely accept and falsely reject items is further described in ILAC-G8



3.3 MEASUREMENT SOFTWARE USED

List of measurement software versions used for testing.

Instrument/Software	Manufacturer	Type No.	TE No.	Software Version
PXA Signal Analyser	Keysight	N9030A	4654	A 22.08
HP-VEE Software	TUV SUD	HP_VEE	N/A	V3.29
eMx	TUV SUD	N/A	N/A	V3.1.4



SECTION 4

ACCREDITATION, DISCLAIMERS AND COPYRIGHT



4.1 ACCREDITATION, DISCLAIMERS AND COPYRIGHT

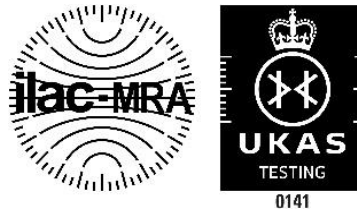

This report relates only to the actual item/items tested.

Our UKAS Accreditation does not cover opinions and interpretations and any expressed are outside the scope of our UKAS Accreditation.

Results of tests not covered by our UKAS Accreditation Schedule are marked NUA (Not UKAS Accredited).

© 2022 TÜV SÜD
TÜV SÜD

Postal Address :Octagon House, Concorde Way, Fareham, Hampshire, UK, PO15 5RL



ANNEX A

MODULE LIST



Configuration 1			
Product	Product No	R-State	Serial No
Radio 4480	KRC 161 844/1	R2B	E23C418848
Software Version:	CXP9013268/15	Revision:	R89MU15