



Add value.
Inspire trust.



Report On

FCC and ISED Testing of the
Ericsson Radio 4455 B2/B25 B66A, KRC 161 823-1 NR (1900 MHz)
Base Station in accordance with FCC CFR 47 Part 2, FCC CFR 47 Part
24, ISED RSS-GEN and Industry Canada RSS-133

COMMERCIAL-IN-CONFIDENCE

FCC: TA8AKRC161823-1
IC: 287AB-AS1618231

PREPARED BY

Maggie Whiting
Key Account Manager

APPROVED BY

Steve Scarfe
Authorised Signatory

DATED

04 May 2022

Document 75954487 Report 05 Issue 1

May-2022



CONTENTS

Section	Page No
1	REPORT INFORMATION 2
1.1	Report Details 3
1.2	Brief Summary of Results 4
1.3	Test Rationale..... 5
1.4	Configuration Description 6
1.5	Declaration of Build Status 7
1.6	Product Information 9
1.7	Test Setup 10
1.8	Test Conditions..... 12
1.9	Deviation From The Standard 12
1.10	Modification Record 12
1.11	Additional Information 13
2	TEST DETAILS 14
2.1	Maximum Peak Output Power and Peak to Average Ratio - Conducted..... 15
2.2	Occupied Bandwidth..... 25
2.3	Band Edge 33
2.4	Transmitter Spurious Emissions..... 39
2.5	Radiated Emissions 64
3	TEST EQUIPMENT USED 70
3.1	Test Equipment Used 71
3.2	Measurement Uncertainty 73
3.3	Measurement Software Used 74
4	ACCREDITATION, DISCLAIMERS AND COPYRIGHT..... 75
4.1	Accreditation, Disclaimers and Copyright..... 76
ANNEX A	Module Lists.....A.2



SECTION 1

REPORT INFORMATION



1.1 REPORT DETAILS

Manufacturer	Ericsson
Address	Torshamnsgatan 23 Kista SE-16480 Stockholm Sweden
Product Name & Product Number	Radio 4455 B2/B25 B66A - KRC 161 823-1
IC Model Name	AS1618231
Serial Number(s)	D829275242
Software Version	CXP9013268/15-R89JD
Hardware Version	R1C
Test Specification/Issue/Date	FCC CFR 47 Part 2: 2020 FCC CFR 47 Part 24: 2020 ISED RSS-GEN: Issue 5: March 2019 Amendment 1, 2021 Amendment 2 Industry Canada RSS-133: Issue 6: January 2018 Amendment 1
Test Plan	MR7602- _LTE-NR_FDD_Spectrum_Sharing_with_NB-IoT 9 Radios FCC and ISED V 1.0
Start of Test	07-March-2022
Finish of Test	30-March-2022
Name of Engineer(s)	Neil Rousell, Graeme Lawler
Related Document(s)	KDB 971168 D01 v02r02 KDB 662911 D01 v02r01 ICES-003:Issue 7 (2020-10) ANSI C63.26-2015

ENGINEERING STATEMENT

The measurements shown in this report were made in accordance with the procedures described on test pages. All reported testing was carried out on a sample equipment to demonstrate compliance with and FCC CFR 47 Part 2: 2020, FCC CFR 47 Part 24: 2020, ISED RSS-GEN: Issue 5: March 2019 Amendment 1, 2021 Amendment 2, Industry Canada RSS-133: Issue 6: January 2018 Amendment 1 The sample tested was found to comply with the requirements defined in the applied rules.

Test Engineer(s);

Neil Rousell, Graeme Lawler



1.2 BRIEF SUMMARY OF RESULTS

A brief summary of results for each configuration, in accordance with FCC CFR 47 Part 2, FCC CFR 47 Part 24, ISED RSS-GEN and Industry Canada RSS-133 is shown below.

Section	Specification Clause				Test Description	Result
	FCC CFR 47 Part 2	FCC CFR 47 Part 24	RSS-GEN	RSS-133		
2.1	2.1046	24.232	-	6.4	Maximum Peak Output Power and Peak to Average Ratio - Conducted	Pass
2.2	2.1049	24.238 (b)	6.7		Occupied Bandwidth	Pass
2.3	2.1051	24.238 (b)	-	6.5	Band Edge	Pass
2.4	2.1051	24.238 (a)	6.13	6.5	Transmitter Spurious Emissions	Pass
2.5	2.1053	-	6.13	6.5	Radiated Emissions	Pass

Testing in this Report covers only B2 B25 (1900 MHz)

For additional configurations and test cases not contained within this test report, refer to the following reports:

Document 75954487 Report 06 – Radio 4455 B2/B25 B66A 2100 MHz)



1.3 TEST RATIONALE

The tests that have been selected are detailed in the customer Test Plan as defined in section 1.1 of this report. The Test Plan is based on the TÜV SÜD FCC Test Plan Rationale, available on request.



1.4 CONFIGURATION DESCRIPTION

Config Number	Band	Carrier configurations	Carriers	Pout (W)	NR Main carrier			
		RATs			Position	BW	Freq	NR-ARFCN
1	B25	NR in NR/ESS Setup (NB IoT IB) QPSK	1	30	B	10	1935	387000
	B25	NR in NR/ESS Setup (NB IoT IB) QPSK	1	30	M	10	1962.5	392500
	B25	NR in NR/ESS Setup (NB IoT IB) QPSK	1	30	T	10	1990	398000
	B25	NR in NR/ESS Setup (NB IoT IB) QPSK	1	30	B	15	1937.5	387500
	B25	NR in NR/ESS Setup (NB IoT IB) QPSK	1	30	M	15	1962.5	392500
	B25	NR in NR/ESS Setup (NB IoT IB) QPSK	1	30	T	15	1987.5	397500
	B25	NR in NR/ESS Setup (NB IoT IB) QPSK	1	30	B	20	1940	388000
	B25	NR in NR/ESS Setup (NB IoT IB) QPSK	1	30	M	20	1962.5	392500
	B25	NR in NR/ESS Setup (NB IoT IB) QPSK	1	30	T	20	1985	397000
2	B2	NR in NR/ESS Setup (NB IoT IB) QPSK	1	30	T	10	1985	397000
	B2	NR in NR/ESS Setup (NB IoT IB) QPSK	1	30	T	15	1982.5	396500
	B2	NR in NR/ESS Setup (NB IoT IB) QPSK	1	30	T	20	1980	396000



1.5 DECLARATION OF BUILD STATUS

Equipment Description		
Technical Description: (Please provide a brief description of the intended use of the equipment including the technologies the product supports)	Multi-standard remote radio unit Radio 4455 B2/B25 B66A, 4RX/ 4TX	
Manufacturer:	Ericsson AB	
Model:	Radio 4455 B2/B25 B66A	
Part Number:	KRC 161 823/1	
Hardware Version:	R1C	
Software Version:	CXP9013268/15-R89JD	
FCC ID of the product under test	TA8AKRC161823-1	
IC ID of the product under test	287AB-AS1618231	
Intentional Radiators		
Frequency Range (MHz to MHz) B2 : WCDMA, LTE ,NR; NB-IoT SA	TX (DL): 1930 - 1990 MHz RX (UL): 1850 - 1910 MHz	BW: 60MHz BW: 60MHz
Frequency Range (MHz to MHz) B25: LTE ,NR; NB-IoT SA	TX (DL): 1930 - 1995 MHz RX (UL): 1850 - 1915 MHz	BW: 65MHz BW: 65MHz
Frequency Range (MHz to MHz) B66A:WCDMA, LTE ,NR; NB-IoT SA	TX (DL): 2110 - 2180 MHz RX (UL): 1710 - 1780 MHz	RF BW: 70MHz RF BW: 70MHz
Conducted Declared Output Power (dBm)	44.8 Max output power per port 30W	
RAT SC carrier Power (Max) :NR, LTE	BW	PWR/Carrier(Max)
	5MHz	30 W
	10MHz	30 W
	15MHz	30 W
	20MHz	30 W
RAT SC carrier Power (Max) :WCDMA	5MHz	30 W
Radio Configuration:	4RX / 4TX	
Duplex mode:	FDD	
Radio Access Technology, RAT(s):	Single RAT :WCDMA, LTE, NR, NB-IoT (IB, GB, SA) Multi RAT : WCDMA,+LTE ; WCDMA,+ NR: LTE+ NR; LTE+ NB-IoT LTE+ NR + WCDMA; LTE+ NR + NB-IoT SA; LTE+ WCDMA+ NB-IoT SA	
Supported Bandwidth(s) (MHz)	NR: 5MHz, 10MHz, 15MHz, 20MHz LTE:1.4MHz, 3MHz , 5MHz, 10MHz, 15MHz, 20MHz WCDMA : 5MHz NB-IoT(SA): 200 kHz	
Antenna Gain (dBi)	Maximum antenna system gain (including cable loss), GANT (dBi) for the tested configurations to comply with maximum radiated output power in SRSP -510 and SRSP-513 calculated using measured and summed PSD from all 4 Ports	
Antenna Impedance(Ω)	50	
Supported modulation scheme, LTE:	QPSK, 16QAM, 64QAM, 256QAM	



Supported modulation scheme, NR:	QPSK, 16QAM, 64QAM, 256QAM		
Supported modulation scheme, WCDMA:	QPSK, 16QAM, 64QAM		
Supported modulation scheme, NB-IoT :	QPSK		
NR SCS	15kHz		
RF power Tolerance:	.+0.6/-2.0 dB		
Frequency Tolerance:	±0.05 ppm		
Carrier Aggregation, CA	Supported		
Maximum supported number of DL NR carrier per port	6/Band		
Maximum supported number of DL LTE carrier per port	6/Band		
Maximum supported number of DL WCDMA carrier per port	6/Band		
Maximum supported number of DL CDMA carrier per port	1/Band		
Nominal output power per Antenna Port / Band	SRO / MRO: Single / Multi Carrier: 40W (46,0 dBm)		
Supported transmission modes:	4X4 MIMO		
Unintentional Radiators			
Highest frequency generated or used in the device or on which the device operates or tunes	Up to 10.1 Gbit/s		
Lowest frequency generated or used in the device or on which the device operates or tunes if <30MHz	.-		
Class A Digital Device (Use in commercial, industrial or business environment)	.-		
Class B Digital Device (Use in residential environment)	Class B		
DC Power Supply (Delete if Not Applicable)			
Nominal voltage: AC power supply	100-127 V / 200-250V		
Extreme upper voltage:	275V AC		
Extreme lower voltage:	85V AC		
Max current:	10A/5A		
Temperature			
Minimum temperature:	-40°C		
Maximum temperature:	55°C		
Ancillaries			
Manufacturer:	X	Part Number:	X
Model:	X	Model:	X
I hereby declare that I am entitled to sign on behalf of the manufacturer and that the information supplied is correct and complete.			
Name:	Afrah Ali sadiq		
Position held:	Regulatory Approval Engineer		
Email address:	Afrah.ali.sadiq@ericsson.com		
Telephone number:	.+46724650796		
Date:	02-May-2022		

No responsibility will be accepted by TÜV SÜD as to the accuracy of the information declared in this document by the manufacturer.

1.6 PRODUCT INFORMATION

1.6.1 Technical Description

The Equipment Under Test (EUT) Radio 4455 B2/B25 B66A - KRC 161 823-1 is an Ericsson AB Radio Unit working in the public mobile service Band 2 and Band 25 bands which provides communication connections to Band 2 and Band 25 network. The EUT operates from a -48V DC supply.

The Equipment Under Test (EUT) is shown in the photograph below. A full technical description can be found in the Manufacturer's documentation.

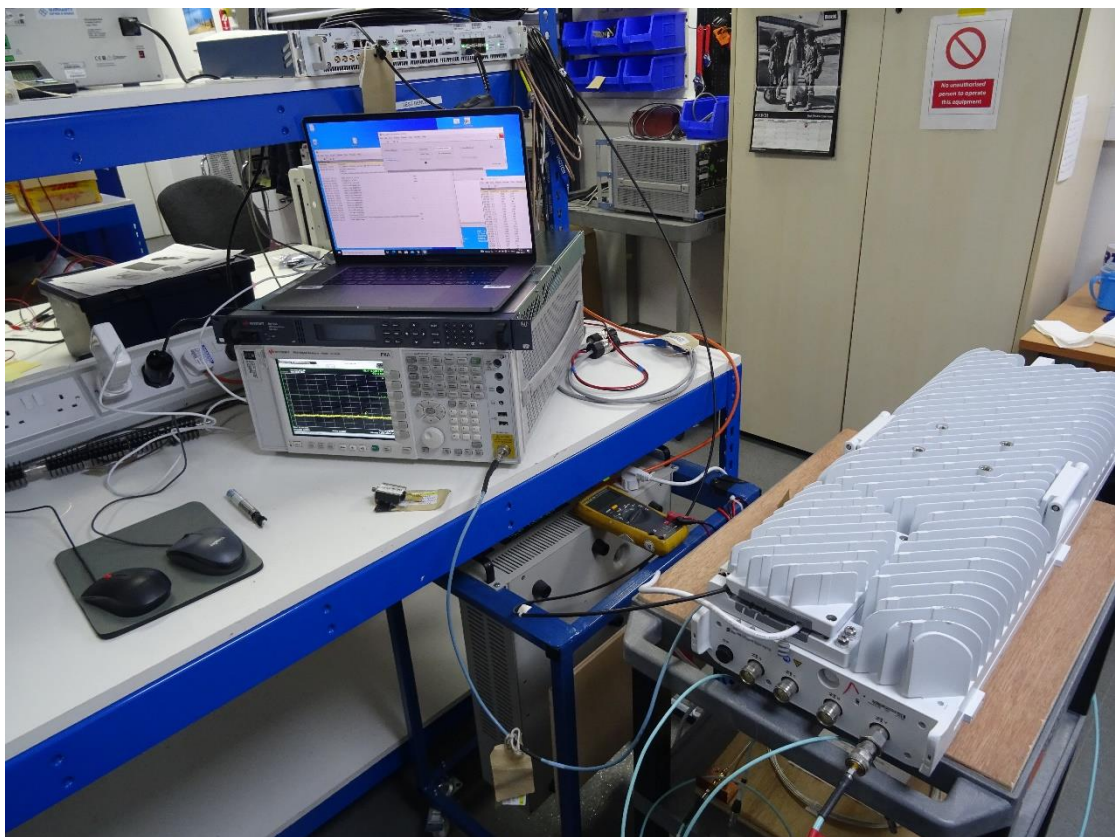

Equipment Under Test

1.7 TEST SETUP

Conducted Test Set Up

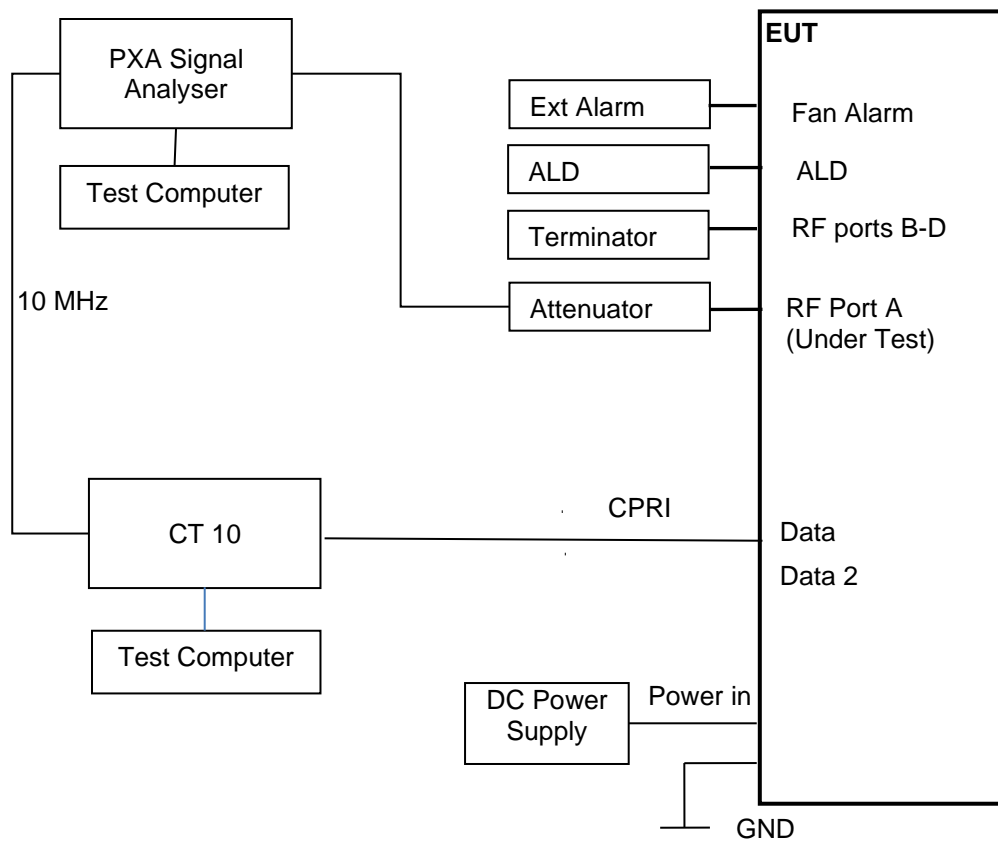



Radiated Test Set Up – Dashed line indicates equipment inside the Chamber for Radiated testing.

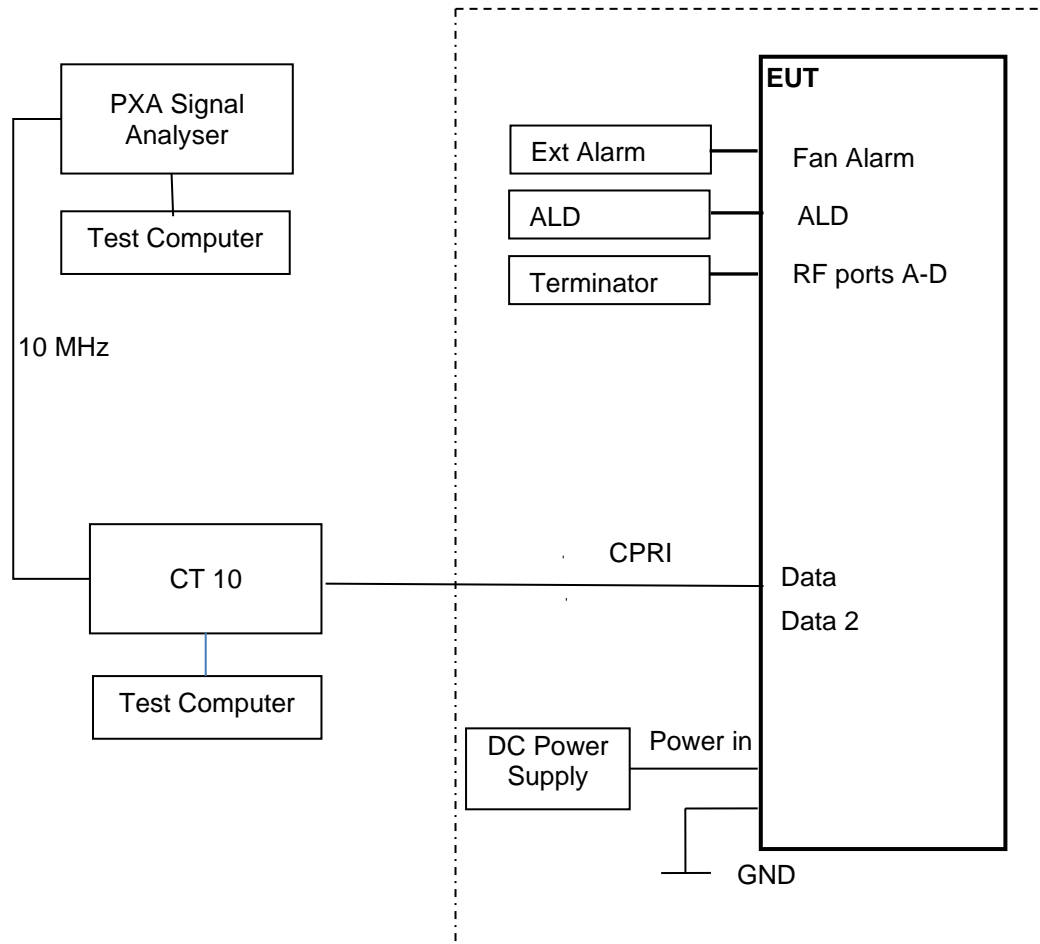



1.8 TEST CONDITIONS

For all tests the EUT was set up in accordance with the relevant test standard and to represent typical operating conditions. Tests were applied with the EUT situated as described in the Test Method for each Test.

The EUT was powered from a -48V DC supply.

FCC Measurement Facility Registration Number
90987 Octagon House, Fareham Test Laboratory
Postal Address: Octagon House, Concorde Way, Fareham, Hampshire, UK, PO15 5RL

ISED Accreditation
IC#12669A Octagon House, Fareham Test Laboratory
Postal Address: Octagon House, Concorde Way, Fareham, Hampshire, UK, PO15 5RL

Under our UKAS Accreditation, TÜV SÜD conducted the following tests Octagon House, Fareham Laboratory.

Test Name	Name of Engineer(s)
Maximum Peak Output Power and Peak to Average Ratio - Conducted	Neil Rousell
Occupied Bandwidth	Neil Rousell
Band Edge	Neil Rousell
Transmitter Spurious Emissions	Neil Rousell
Radiated Emissions	Graeme Lawler

1.9 DEVIATION FROM THE STANDARD

No deviations from the applicable test standards or test plan were made during testing.

1.10 MODIFICATION RECORD

No modifications were made to the EUT during testing.



1.11 ADDITIONAL INFORMATION

This filing is for a Class II permissive change procedure for FCC and the class III permissive change procedure for ISED of the added NB-IoT functionality to NR to a previously certified Radio for use in the USA and Canada under the following ID's:

FCC ID: TA8AKRC161823-1
ISED ID: 287AB-AS1618231
Hardware Version R1C

This device is electrically identical as originally certified as no hardware changes have been made

This EUT uses the same port for Tx and Rx and therefore RX Spurious Emissions has not been performed. Rx Spurious Emissions have been covered by testing to FCC Part 15B, which are covered by a separate test report.

Frequency Stability was verified at the time of the original certification and is covered by a separate report.

In RSS-Gen Clause 6.9 the requirement is to test on channels as follows;

1 near the bottom, 1 near the middle and 1 near the top

Therefore testing has only been performed on the top channel for B2 as the 1 near the bottom and 1 near the middle are covered by the B25 testing.



SECTION 2

TEST DETAILS



2.1 MAXIMUM PEAK OUTPUT POWER AND PEAK TO AVERAGE RATIO - CONDUCTED

2.1.1 Specification Reference

FCC CFR 47 Part 24, Clause 24.232
 Industry Canada RSS-133, Clause 6.4
 FCC CFR 47 Part 2, Clause 2.1046

2.1.2 Date of Test and Modification State

07-March-2022 - Modification State 0

2.1.3 Test Equipment Used

The major items of test equipment used for the above tests are identified in Section 3.1.

2.1.4 Environmental Conditions

Ambient Temperature 21.1 - 23.1°C
 Relative Humidity 27.9 - 31.2%

2.1.5 Test Method

All measurements were made in accordance with FCC KDB 971168 D01, clause 5.2.1 and summed in accordance with FCC KDB 662911 D01.

2.1.6 Test Results

Configuration 1

Maximum Output Power 44.77 dBm

Antenna	NR Modulation	NR Carrier Bandwidth	Peak to Average Ratio (PAR) / Output Power / PSD						
			PAR (dB)	Channel Position B					
				Average Power/PSD		Total Power Port A + B + C +D	Total Power Port A + B + C +D	GANT* Limit 62.15dB	GANT* Limit 65.15dB
				dBm	dBm/MHz	dBm	dBm/MHz	dBi	dBi
A	QPSK	10.0 MHz 15 kHz SCS	7.42	43.71	35.07	49.73	41.09	21.06	24.06
A	QPSK	15.0 MHz 15 kHz SCS	7.62	43.62	34.62	49.64	40.64	21.51	24.51
A	QPSK	20.0 MHz 15 kHz SCS	7.63	43.78	34.62	49.80	40.64	21.51	24.51

Remarks

Calculations:

Total Power = Measured Output Power (port A) + 10log (NANT)

Where NANT refers to the number of Ports.



* Maximum antenna system gain (including cable loss), GANT (dBi) 50 ohm, for the tested configurations, to comply with Maximum radiated output power in ISED SRSP-510, calculated using measured and summed PSD from all 4 ports.

Antenna A - NR Modulation QPSK - NR Carrier Bandwidth 10.0 MHz 15 kHz SCS - Channel Position B

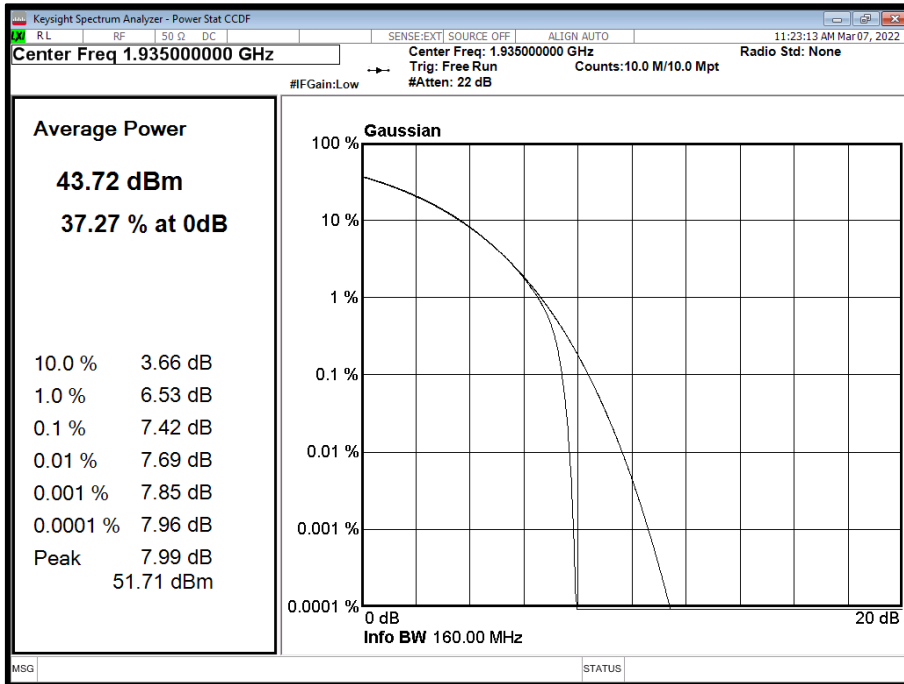

Antenna A - NR Modulation QPSK - NR Carrier Bandwidth 15.0 MHz 15 kHz SCS - Channel Position B

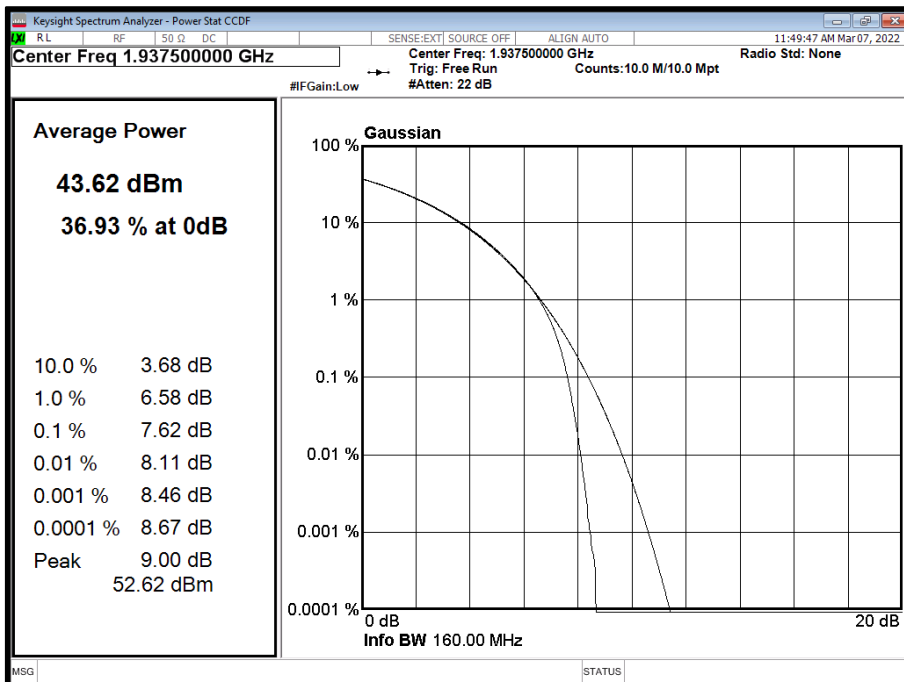



Antenna A - NR Modulation QPSK - NR Carrier Bandwidth 20.0 MHz 15 kHz SCS - Channel Position B

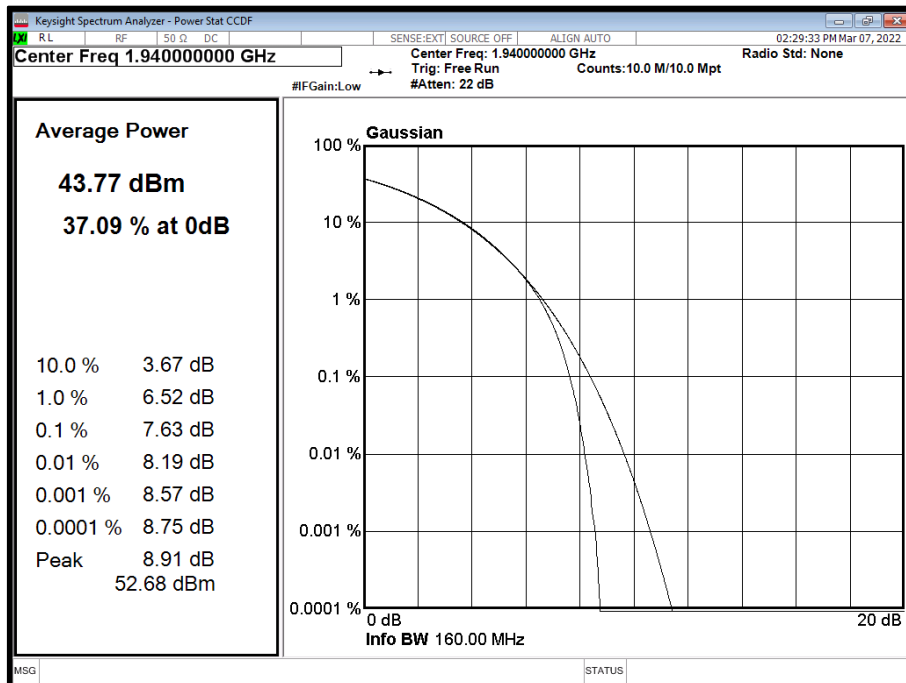

Configuration 1

Maximum Output Power 44.77 dBm

Antenna	NR Modulation	NR Carrier Bandwidth	Peak to Average Ratio (PAR) / Output Power / PSD						
			Channel Position M						
			PAR (dB)	Average Power/PSD		Total Power Port A + B + C + D	GANT* Limit 62.15dB	GANT* Limit 65.15dB	
				dBm	dBm/MHz	dBm			dBm/MHz
A	QPSK	10.0 MHz 15 kHz SCS	7.35	43.82	35.05	49.84	41.07	21.08	24.08
A	QPSK	15.0 MHz 15 kHz SCS	7.43	43.74	34.48	49.76	40.50	21.65	24.65
A	QPSK	20.0 MHz 15 kHz SCS	7.39	43.83	34.60	49.85	40.62	21.53	24.53



Remarks

Calculations:

$$\text{Total Power} = \text{Measured Output Power (port A)} + 10\log(\text{NANT})$$

Where NANT refers to the number of Ports.

* Maximum antenna system gain (including cable loss), GANT (dBi) 50 ohm, for the tested configurations, to comply with Maximum radiated output power in ISED SRSP-510, calculated using measured and summed PSD from all 4 ports.

Antenna A - NR Modulation QPSK - NR Carrier Bandwidth 10.0 MHz 15 kHz SCS - Channel Position M

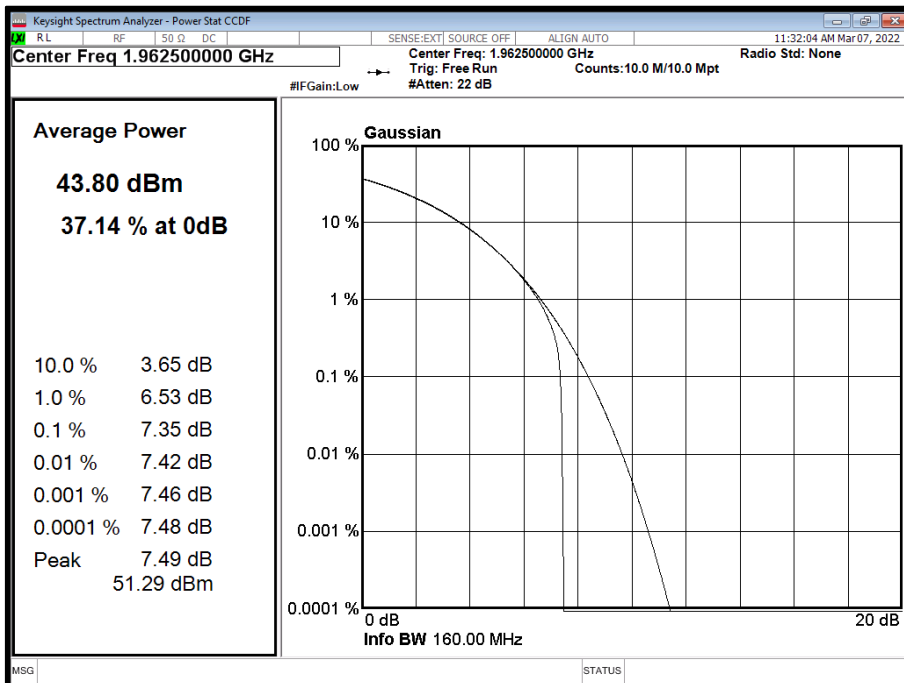



Antenna A - NR Modulation QPSK - NR Carrier Bandwidth 15.0 MHz 15 kHz SCS - Channel Position M

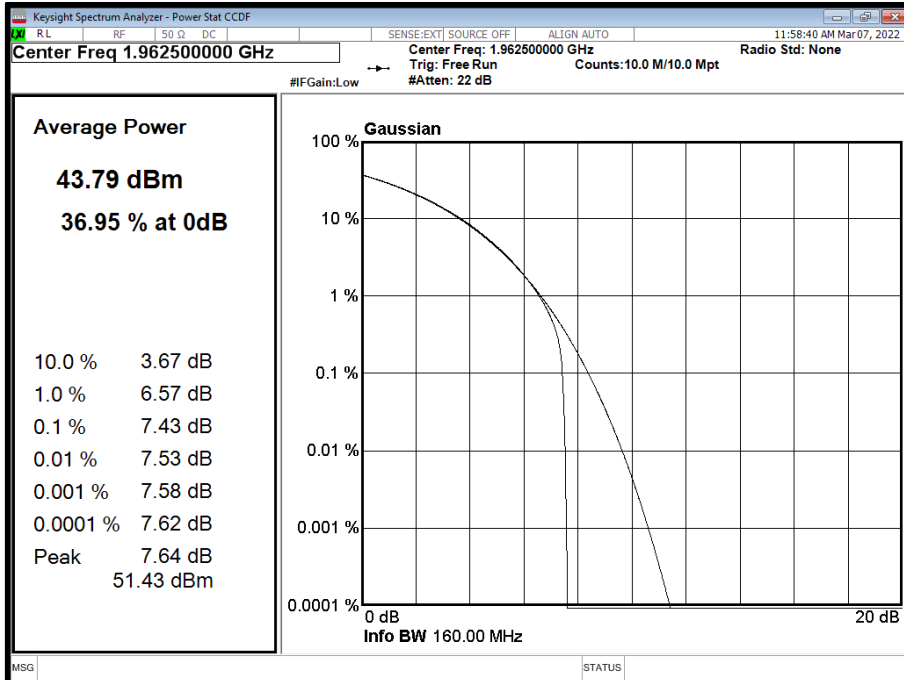

Antenna A - NR Modulation QPSK - NR Carrier Bandwidth 20.0 MHz 15 kHz SCS - Channel Position M

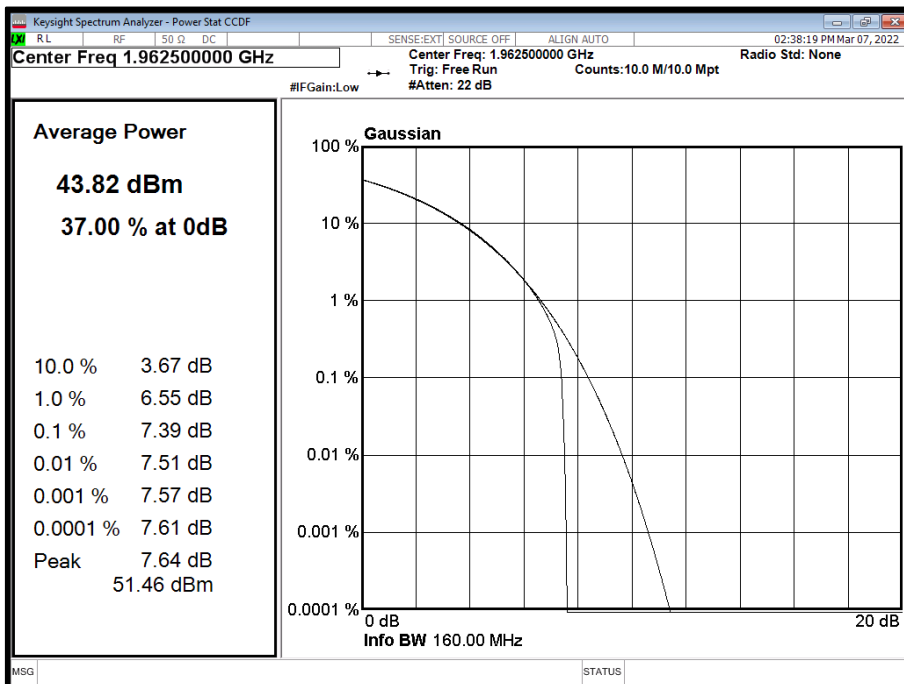



Configuration 1

Maximum Output Power 44.77 dBm

Antenna	NR Modulation	NR Carrier Bandwidth	Peak to Average Ratio (PAR) / Output Power / PSD						
			Channel Position T						
			PAR (dB)	Average Power/PSD		Total Power Port A + B + C + D	Total Power Port A + B + C + D	GANT* Limit 62.15dB	GANT* Limit 65.15dB
dBm	dBm/MHz	dBm		dBm/MHz	dBi	dBi			
A	QPSK	10.0 MHz 15 kHz SCS	7.39	43.78	35.07	49.80	41.09	21.06	24.06
A	QPSK	15.0 MHz 15 kHz SCS	7.48	43.74	34.56	49.76	40.58	21.57	24.57
A	QPSK	20.0 MHz 15 kHz SCS	7.48	43.72	34.37	49.74	40.39	21.76	24.76

Remarks

Calculations:

Total Power = Measured Output Power (port A) + 10log (NANT)

Where NANT refers to the number of Ports.

* Maximum antenna system gain (including cable loss), GANT (dBi) 50 ohm, for the tested configurations, to comply with Maximum radiated output power in ISED SRSP-510, calculated using measured and summed PSD from all 4 ports.

Antenna A - NR Modulation QPSK - NR Carrier Bandwidth 10.0 MHz 15 kHz SCS - Channel Position T

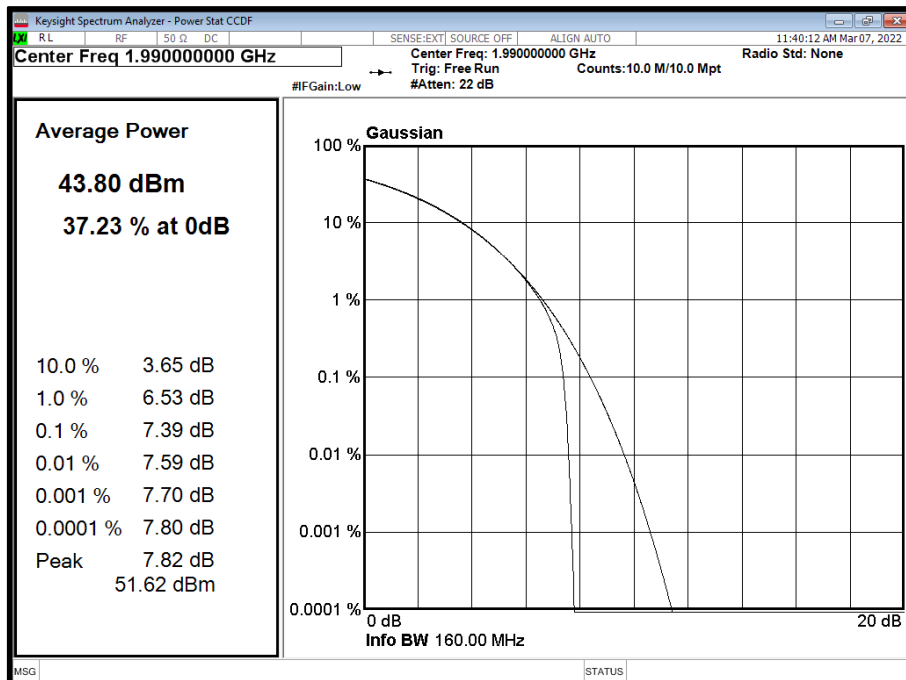



Antenna A - NR Modulation QPSK - NR Carrier Bandwidth 15.0 MHz 15 kHz SCS - Channel Position T

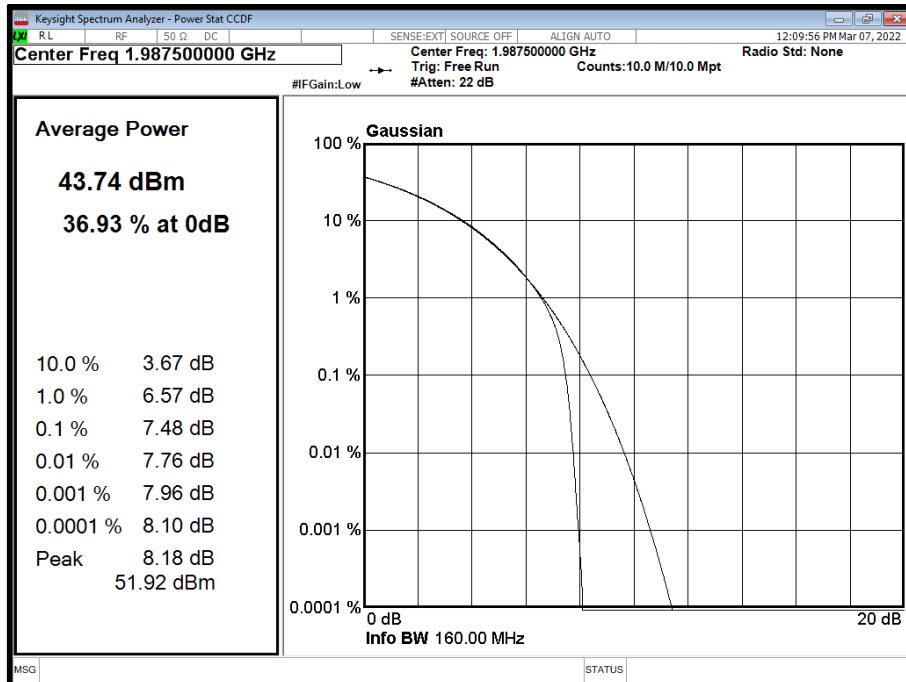

Antenna A - NR Modulation QPSK - NR Carrier Bandwidth 20.0 MHz 15 kHz SCS - Channel Position T

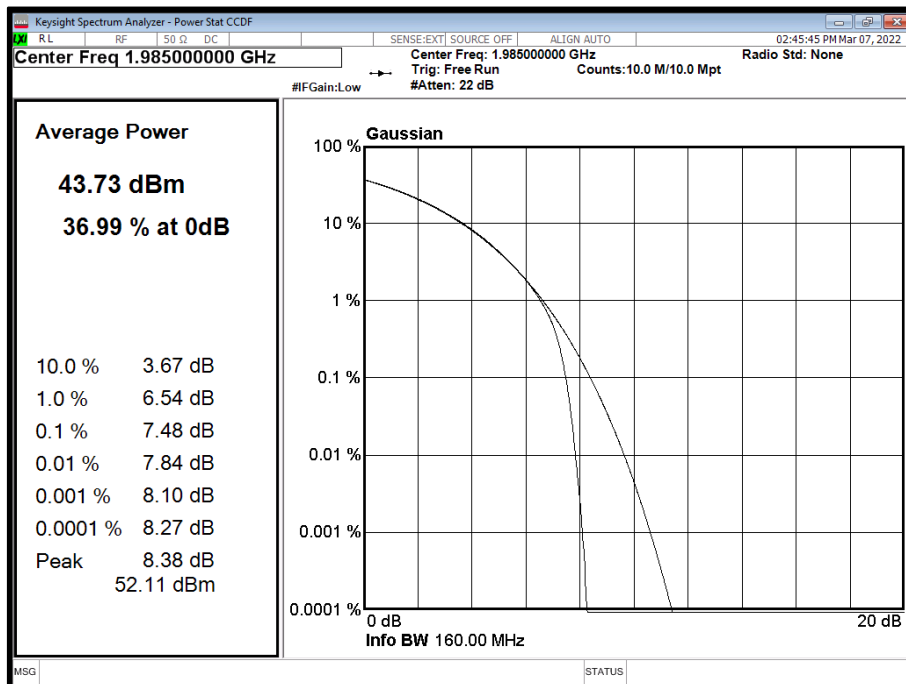



Configuration 2

Maximum Output Power 44.77 dBm

Antenna	NR Modulation	NR Carrier Bandwidth	Peak to Average Ratio (PAR) / Output Power / PSD				
			Channel Position T				
			PAR (dB)	Average Power/PSD		Total Power Port A + B + C + D	Total Power Port A + B + C + D
dBm	dBm/MHz	dBm		dBm/MHz			
A	QPSK	10.0 MHz 15 kHz SCS	7.37	43.81	34.95	49.83	40.97
A	QPSK	15.0 MHz 15 kHz SCS	7.44	43.72	34.54	49.74	40.56
A	QPSK	20.0 MHz 15 kHz SCS	7.42	43.80	34.48	49.82	40.50

Remarks

Calculations:

Total Power = Measured Output Power (port A) + 10log (NANT) Where NANT refers to the number of Ports.

Antenna A - NR Modulation QPSK - NR Carrier Bandwidth 10.0 MHz 15 kHz SCS - Channel Position T

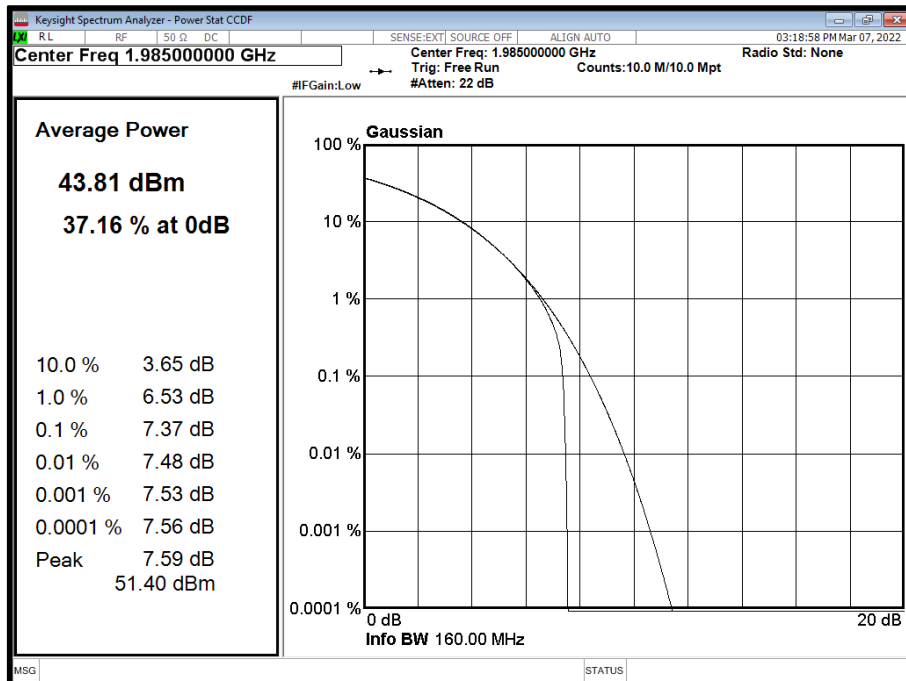



Antenna A - NR Modulation QPSK - NR Carrier Bandwidth 15.0 MHz 15 kHz SCS - Channel Position T

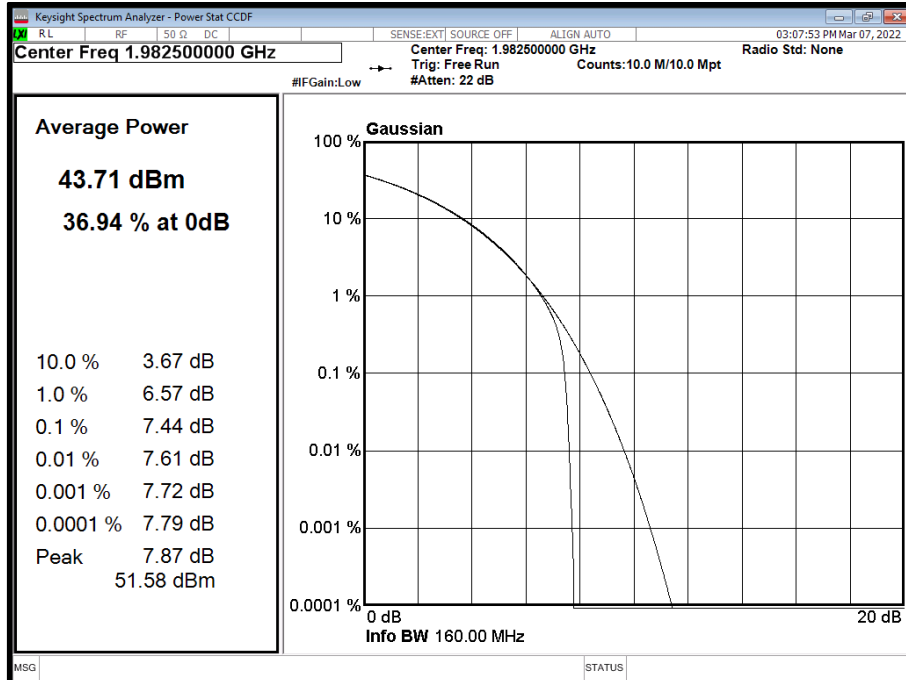

Antenna A - NR Modulation QPSK - NR Carrier Bandwidth 20.0 MHz 15 kHz SCS - Channel Position T

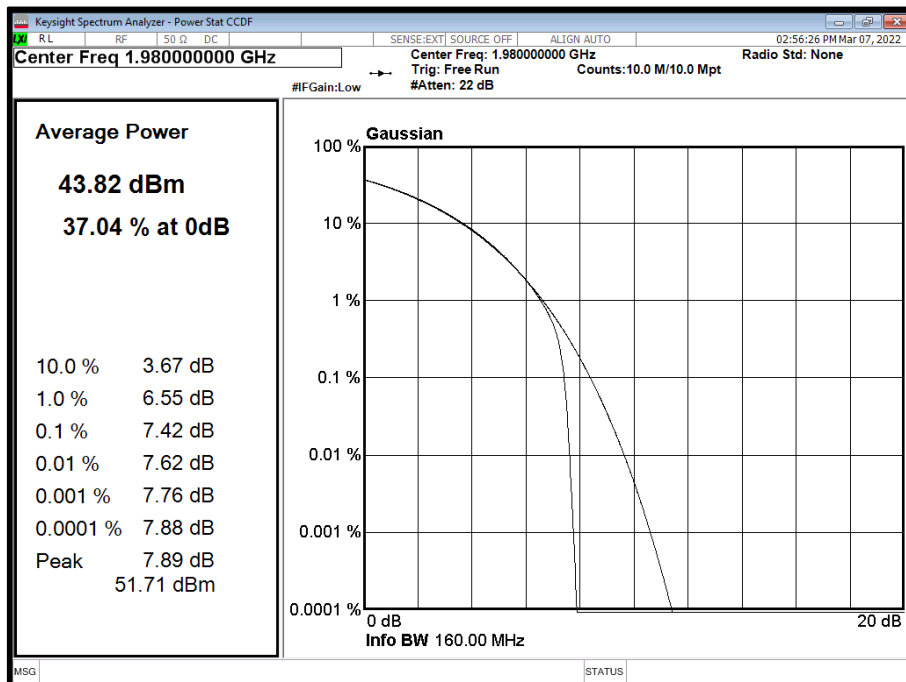



FCC Part 24.232 Clauses (a) & (b)

Limit	
Maximum ERP (Urban)	$\leq 1640 \text{ W}$ or $\leq +62.15 \text{ dBm}$ (antenna height $\leq 300\text{m}$) $\leq 1070 \text{ W}$ or $\leq +60.30 \text{ dBm}$ (antenna height $\leq 500\text{m}$) $\leq 490 \text{ W}$ or $\leq +56.90 \text{ dBm}$ (antenna height $\leq 1000\text{m}$) $\leq 270 \text{ W}$ or $\leq +54.31 \text{ dBm}$ (antenna height $\leq 1500\text{m}$) $\leq 160 \text{ W}$ or $\leq +52.04 \text{ dBm}$ (antenna height $\leq 2000\text{m}$)
Maximum ERP (Non-Urban)	$\leq 3280 \text{ W}$ or $\leq +65.15 \text{ dBm}$ (antenna height $\leq 300\text{m}$) $\leq 2140 \text{ W}$ or $\leq +63.30 \text{ dBm}$ (antenna height $\leq 500\text{m}$) $\leq 980 \text{ W}$ or $\leq +59.91 \text{ dBm}$ (antenna height $\leq 1000\text{m}$) $\leq 540 \text{ W}$ or $\leq +57.32 \text{ dBm}$ (antenna height $\leq 1500\text{m}$) $\leq 320 \text{ W}$ or $\leq +55.05 \text{ dBm}$ (antenna height $\leq 2000\text{m}$)

RSS-133 Clause 6.4

Limit	
Peak to Average Ratio	13 dB

SRSP-510 Power and Antenna Height Limitations Clause 5.1.1 & 5.1.2

Limit	
Maximum EIRP (Non-Urban)	$\leq 3280 \text{ W/MHz}$ or $\leq +65.15 \text{ dBm}$
Maximum EIRP (Urban)	$\leq 1640 \text{ W/MHz}$ or $\leq +62.15 \text{ dBm}$ (antenna height $\leq 300\text{m}$) $\leq 1070 \text{ W/MHz}$ or $\leq +60.30 \text{ dBm}$ (antenna height $\leq 500\text{m}$) $\leq 490 \text{ W/MHz}$ or $\leq +56.90 \text{ dBm}$ (antenna height $\leq 1000\text{m}$) $\leq 270 \text{ W/MHz}$ or $\leq +54.31 \text{ dBm}$ (antenna height $\leq 1500\text{m}$) $\leq 160 \text{ W/MHz}$ or $\leq +52.04 \text{ dBm}$ (antenna height $\leq 2000\text{m}$)



2.2 OCCUPIED BANDWIDTH

2.2.1 Specification Reference

FCC CFR 47 Part 24, Clause 24.238 (b)
ISED RSS-GEN, Clause 6.7
FCC CFR 47 Part 2, Clause 2.1049

2.2.2 Date of Test and Modification State

07-March-2022 - Modification State 0

2.2.3 Test Equipment Used

The major items of test equipment used for the above tests are identified in Section 3.1.

2.2.4 Environmental Conditions

Ambient Temperature	21.1 - 23.1°C
Relative Humidity	27.9 - 31.2%

2.2.5 Test Method

All measurements were made in accordance with FCC KDB 971168 D01, Clause 4.2 and 4.3. The Spectrum Analyser RBW was configured to be at least 1% of the channel bandwidth of the carrier to be measured.

For 26 dB Bandwidth, in accordance with KDB 971168 D01, a peak detector and a trace setting of Max Hold were used. The trace was allowed to stabilise. Using the Spectrum Analyser function, the 26dB measurement result was obtained.

4.2 Occupied bandwidth – relative measurement procedure

The reference value is the highest level of the spectral envelope of the modulated signal, unless otherwise specified in an applicable rule section.

Subclause 5.4.3 of ANSI C63.26-2015 is applicable.

4.3 Occupied bandwidth – power bandwidth (99 %) measurement procedure

Subclause 5.4.4 of ANSI C63.26-2015 is applicable (wherein the recommendation is to use the 99 % power bandwidth function of a spectrum analyzer).

2.2.6 Test Results



Configuration 1

Maximum Output Power 44.77 dBm

Antenna	NR Modulation	NR Carrier Bandwidth	Result (kHz)					
			Channel Position B		Channel Position M		Channel Position T	
			Occupied Bandwidth	-26 dB Bandwidth	Occupied Bandwidth	-26 dB Bandwidth	Occupied Bandwidth	-26 dB Bandwidth
A	QPSK	10.0 MHz 15 kHz SCS	9443.89	9795.56	9446.44	9800.50	9438.12	9809.80
A	QPSK	15.0 MHz 15 kHz SCS	14365.96	14808.27	14368.01	14803.02	14370.40	14816.68
A	QPSK	20.0 MHz 15 kHz SCS	19183.84	19751.56	19187.67	19742.05	19186.43	19766.42

Antenna A - NR Modulation QPSK - NR Carrier Bandwidth 10.0 MHz 15 kHz SCS - Channel Position B

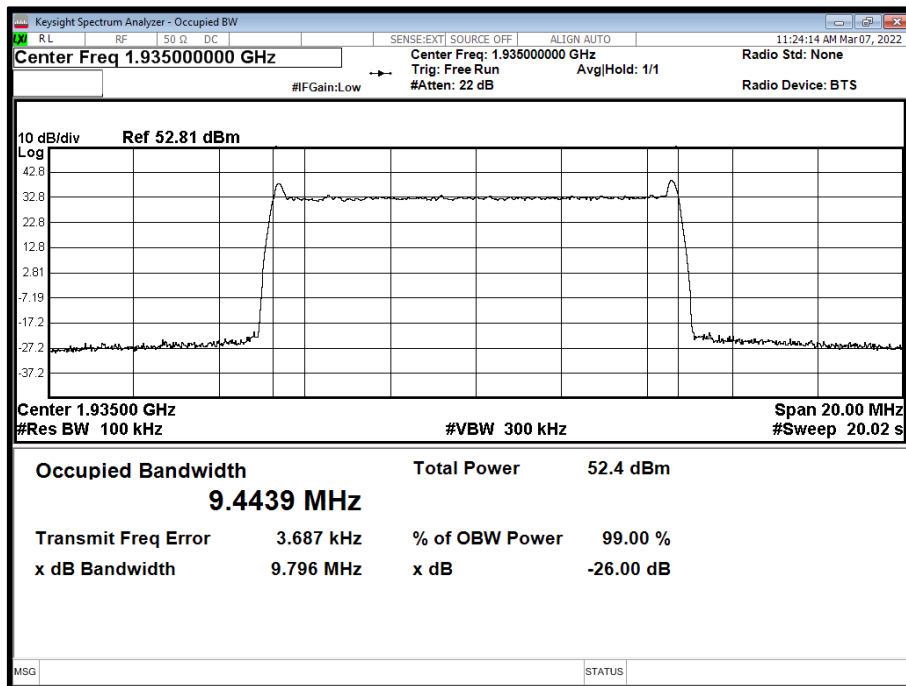



Antenna A - NR Modulation QPSK - NR Carrier Bandwidth 10.0 MHz 15 kHz SCS - Channel Position M

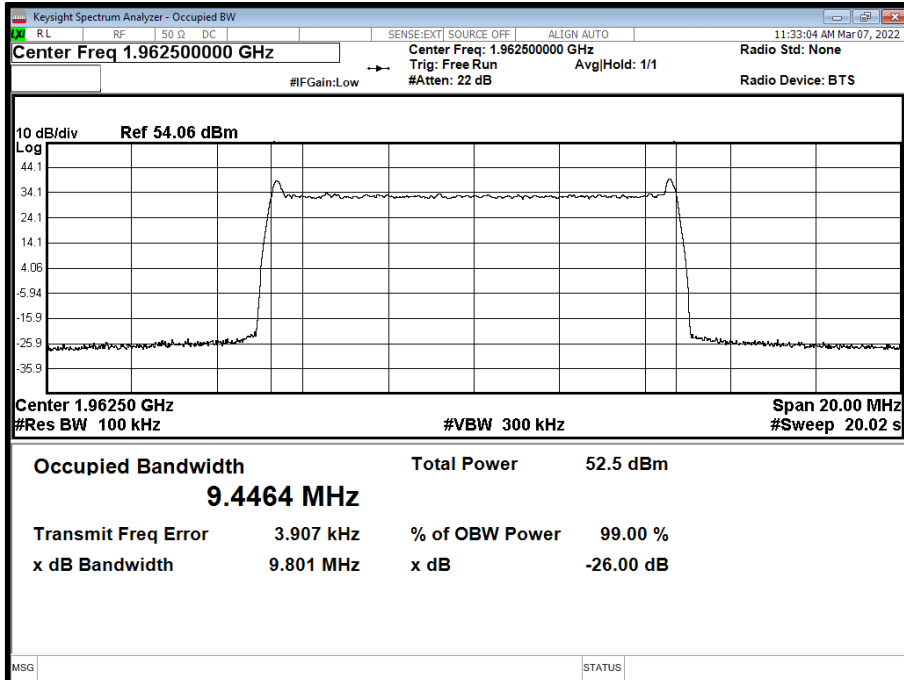

Antenna A - NR Modulation QPSK - NR Carrier Bandwidth 10.0 MHz 15 kHz SCS - Channel Position T

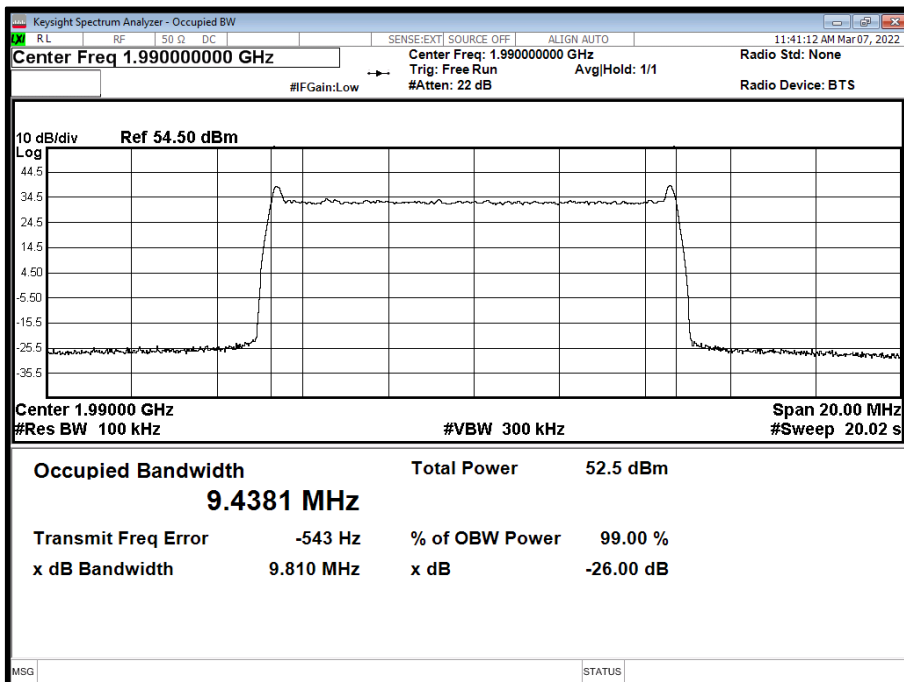



Antenna A - NR Modulation QPSK - NR Carrier Bandwidth 15.0 MHz 15 kHz SCS - Channel Position B

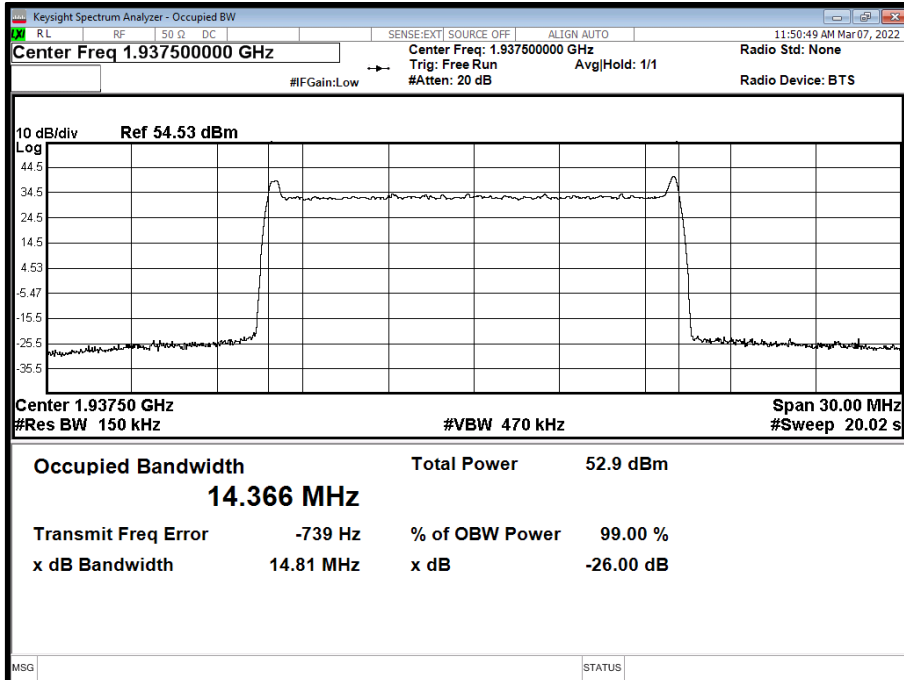

Antenna A - NR Modulation QPSK - NR Carrier Bandwidth 15.0 MHz 15 kHz SCS - Channel Position M

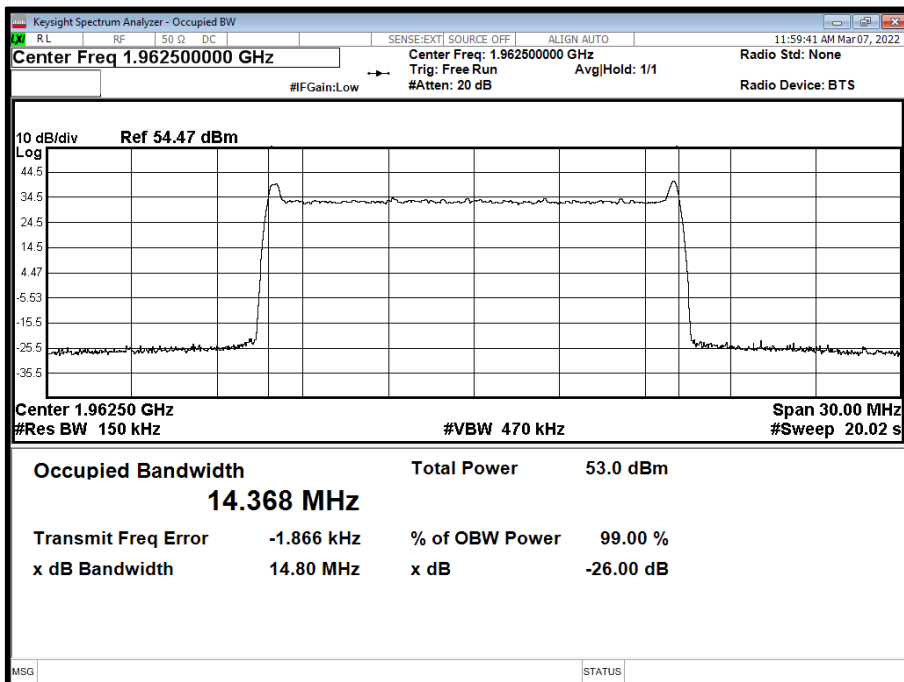



Antenna A - NR Modulation QPSK - NR Carrier Bandwidth 15.0 MHz 15 kHz SCS - Channel Position T

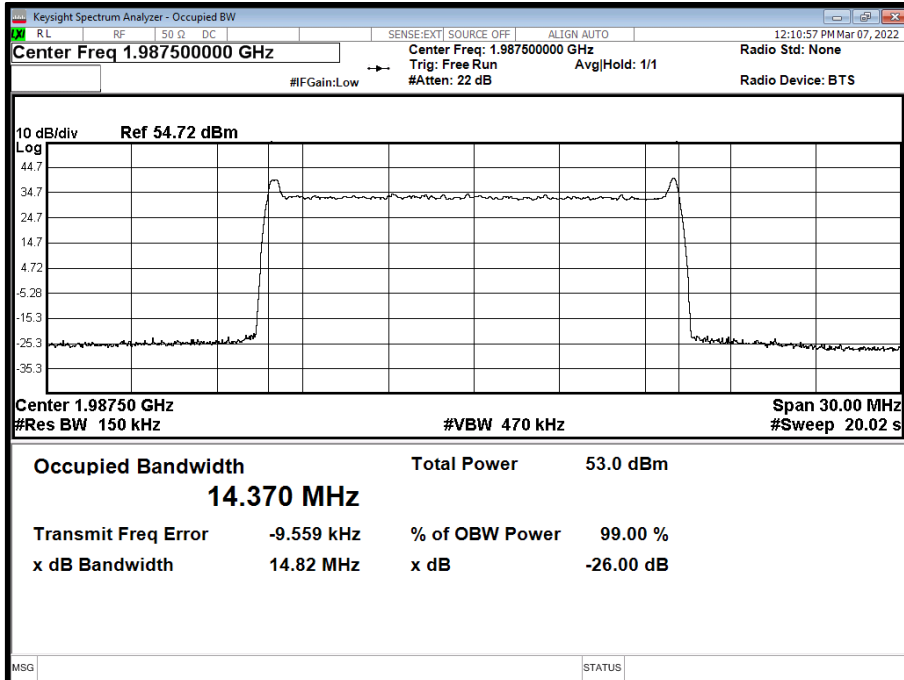

Antenna A - NR Modulation QPSK - NR Carrier Bandwidth 20.0 MHz 15 kHz SCS - Channel Position B

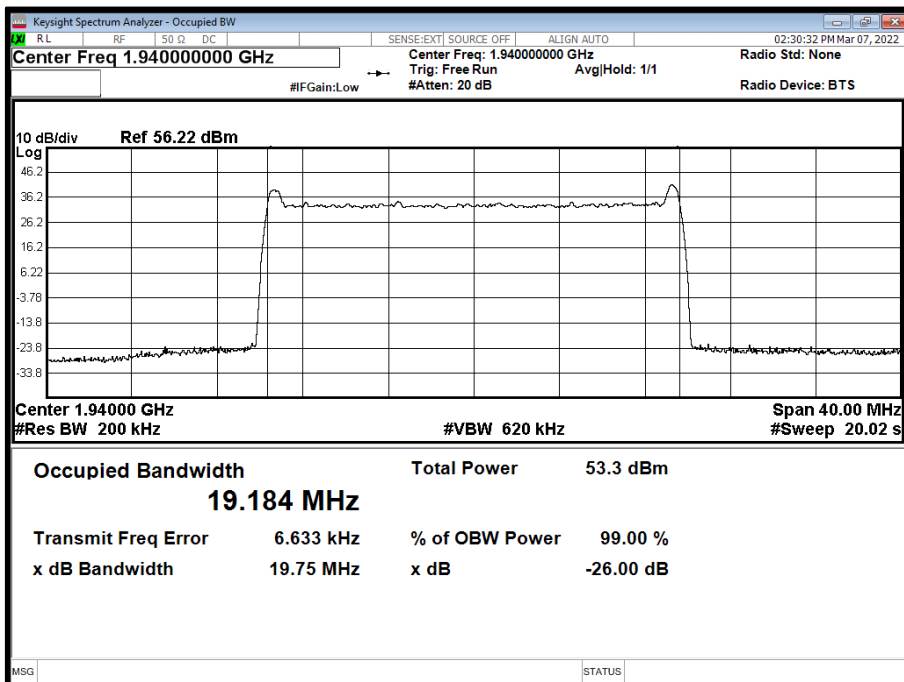



Antenna A - NR Modulation QPSK - NR Carrier Bandwidth 20.0 MHz 15 kHz SCS - Channel Position M

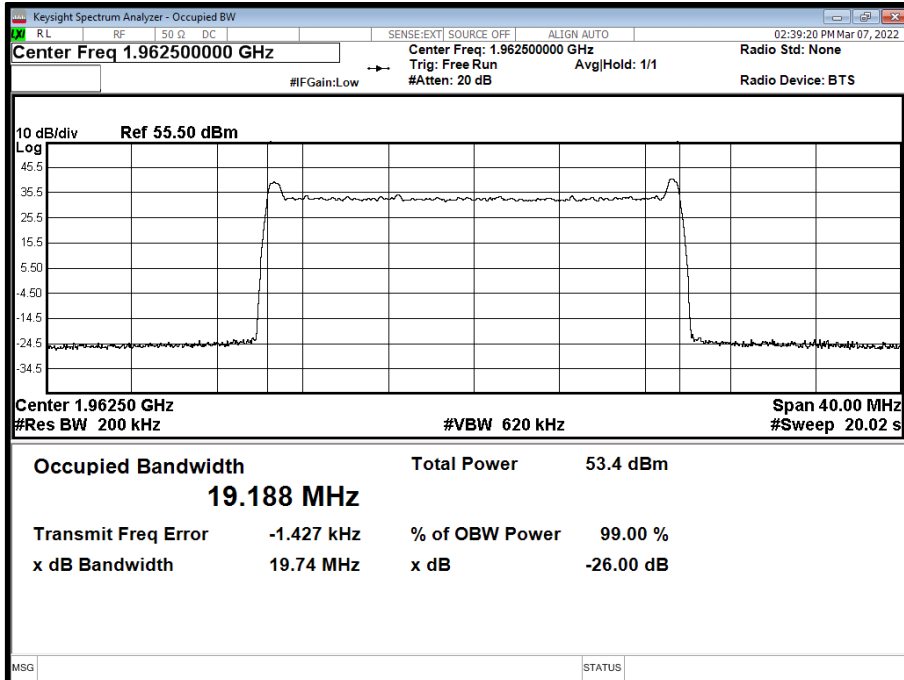

Antenna A - NR Modulation QPSK - NR Carrier Bandwidth 20.0 MHz 15 kHz SCS - Channel Position T

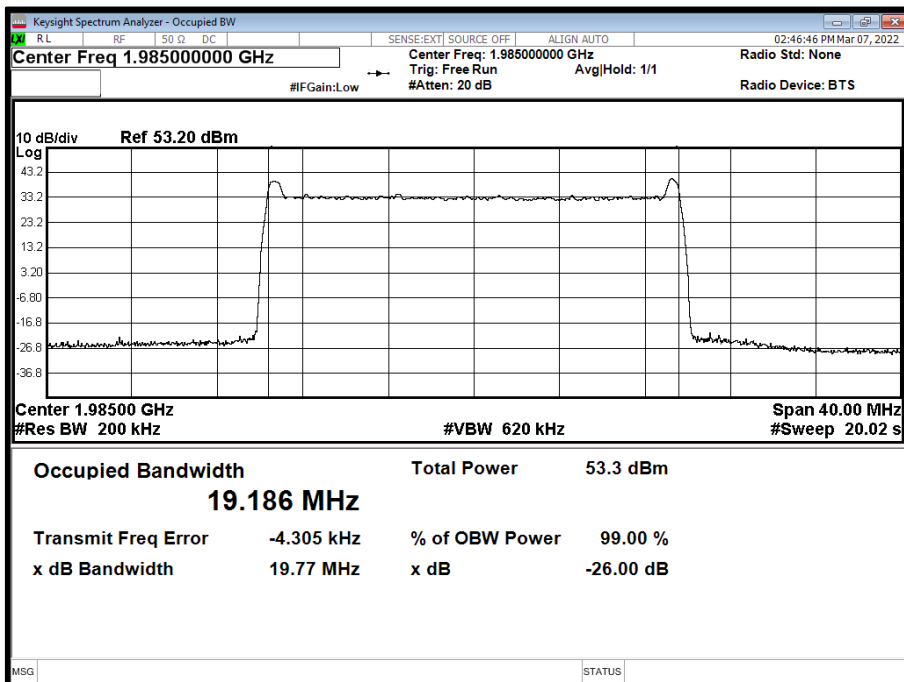



Configuration 2

Maximum Output Power 44.77 dBm

Antenna	NR Modulation	NR Carrier Bandwidth	Result (kHz)					
			Channel Position B		Channel Position M		Channel Position T	
			Occupied Bandwidth	-26 dB Bandwidth	Occupied Bandwidth	-26 dB Bandwidth	Occupied Bandwidth	-26 dB Bandwidth
A	QPSK	10.0 MHz 15 kHz SCS	-	-	-	-	9446.26	9802.78
A	QPSK	15.0 MHz 15 kHz SCS	-	-	-	-	14360.23	14803.54
A	QPSK	20.0 MHz 15 kHz SCS	-	-	-	-	19188.71	19750.93

Antenna A - NR Modulation QPSK - NR Carrier Bandwidth 10.0 MHz 15 kHz SCS - Channel Position T

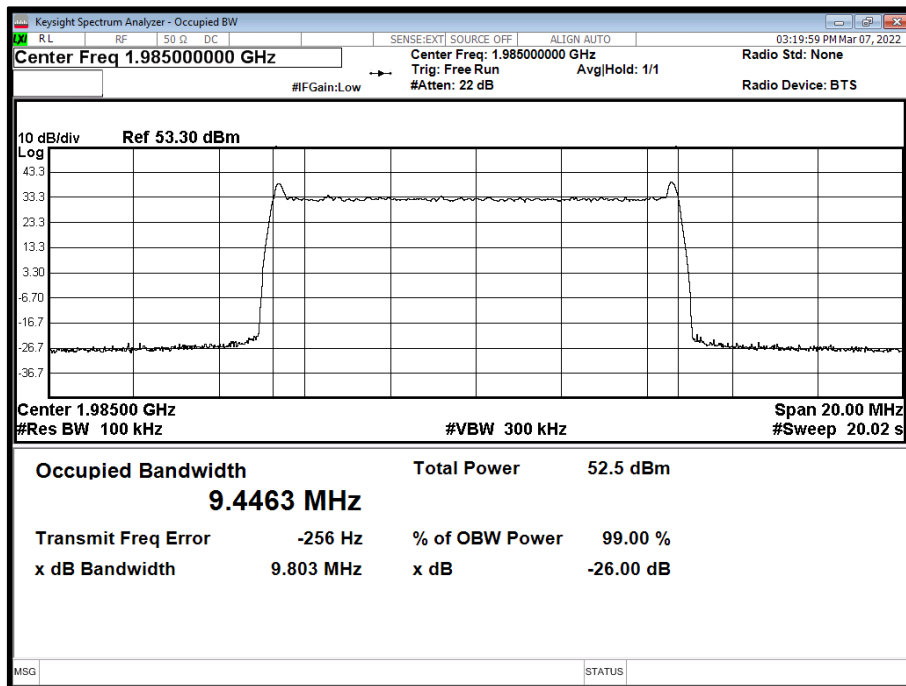



Antenna A - NR Modulation QPSK - NR Carrier Bandwidth 15.0 MHz 15 kHz SCS - Channel Position T

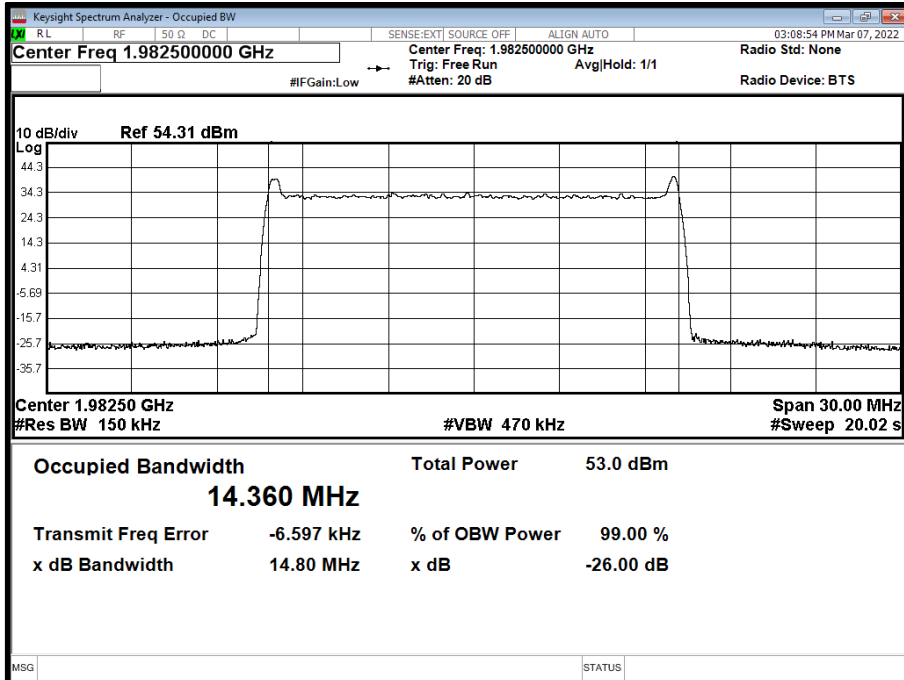

Antenna A - NR Modulation QPSK - NR Carrier Bandwidth 20.0 MHz 15 kHz SCS - Channel Position T

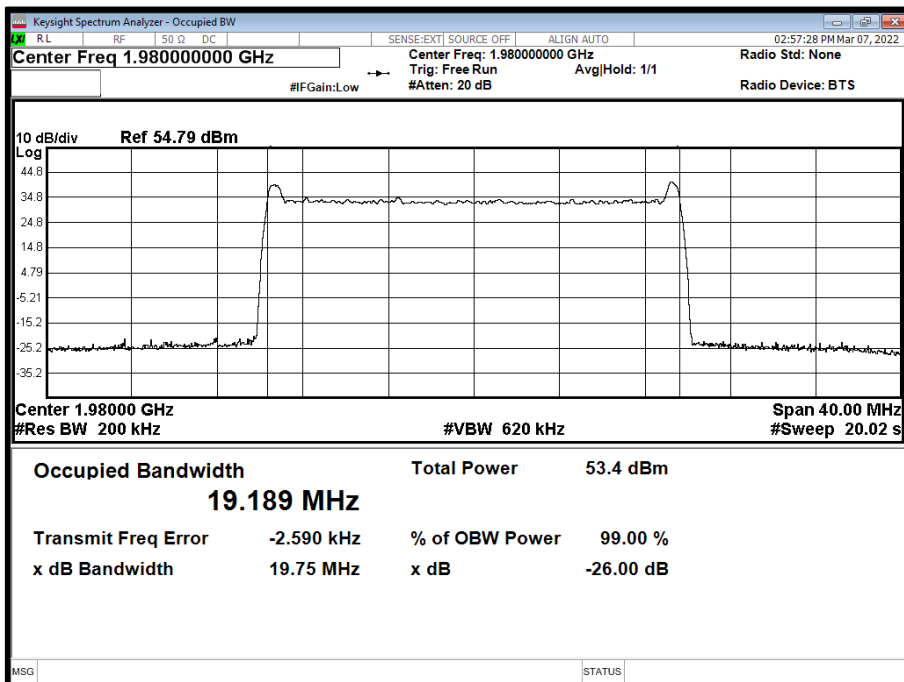



2.3 BAND EDGE

2.3.1 Specification Reference

FCC CFR 47 Part 24, Clause 24.238 (b)
Industry Canada RSS-133, Clause 6.5
FCC CFR 47 Part 2, Clause 2.1051

2.3.2 Date of Test and Modification State

07-March-2022 - Modification State 0

2.3.3 Test Equipment Used

The major items of test equipment used for the above tests are identified in Section 3.1.

2.3.4 Environmental Conditions

Ambient Temperature 21.1 - 23.1°C
Relative Humidity 27.9 - 31.2%

2.3.5 Test Method

All measurements were made in accordance with FCC KDB 971168 D01, Clause 6.0.

Band Edge measurements were used an Integration Bandwidth of at least 1% of the measured 26dB Bandwidth.

Each antenna port has been declared as being equivalent, therefore measurements were made on one antenna port only. To account for this, the limit was tightened by $10 * \text{Log}(N)$, where N is equal to the number of MIMO antenna ports.

For single port, the limit was calculated as being $-13 \text{ dBm} - 10 * \text{Log}(4) = -19 \text{ dBm}$.

2.3.6 Test Results

Configuration 1

Maximum Output Power 44.77 dBm

Antenna	NR Modulation	NR Carrier Bandwidth	Band Edge (MHz)	
			Channel Position B	Channel Position T
A	QPSK	10.0 MHz 15 kHz SCS	1,935.0	1,990.0
A	QPSK	15.0 MHz 15 kHz SCS	1,937.5	1,987.5
A	QPSK	20.0 MHz 15 kHz SCS	1,940.0	1,985.0



Antenna A - NR Modulation QPSK - NR Carrier Bandwidth 10.0 MHz 15 kHz SCS - Channel Position B

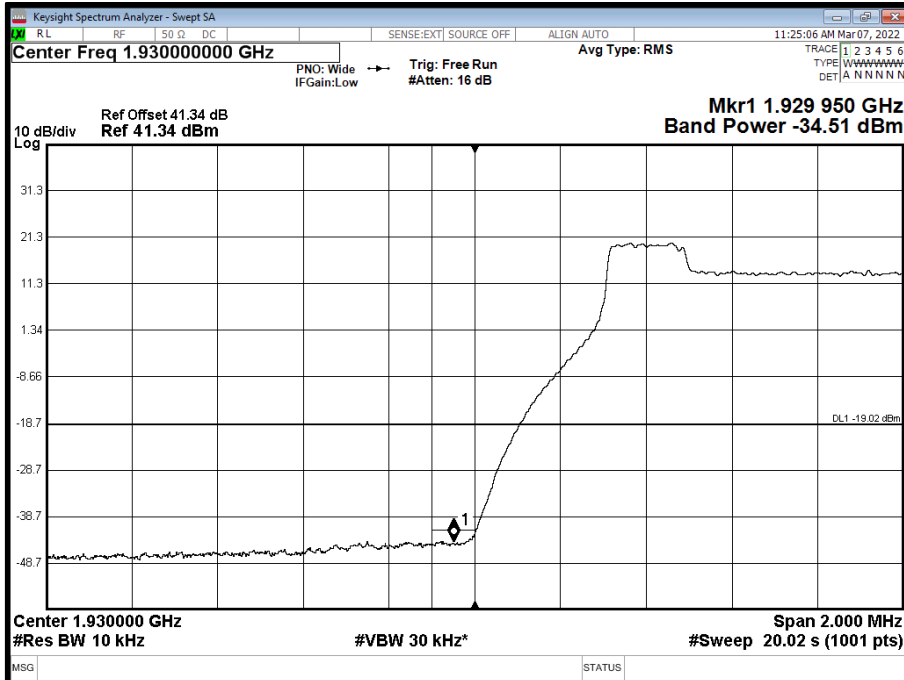

Antenna A - NR Modulation QPSK - NR Carrier Bandwidth 10.0 MHz 15 kHz SCS - Channel Position T

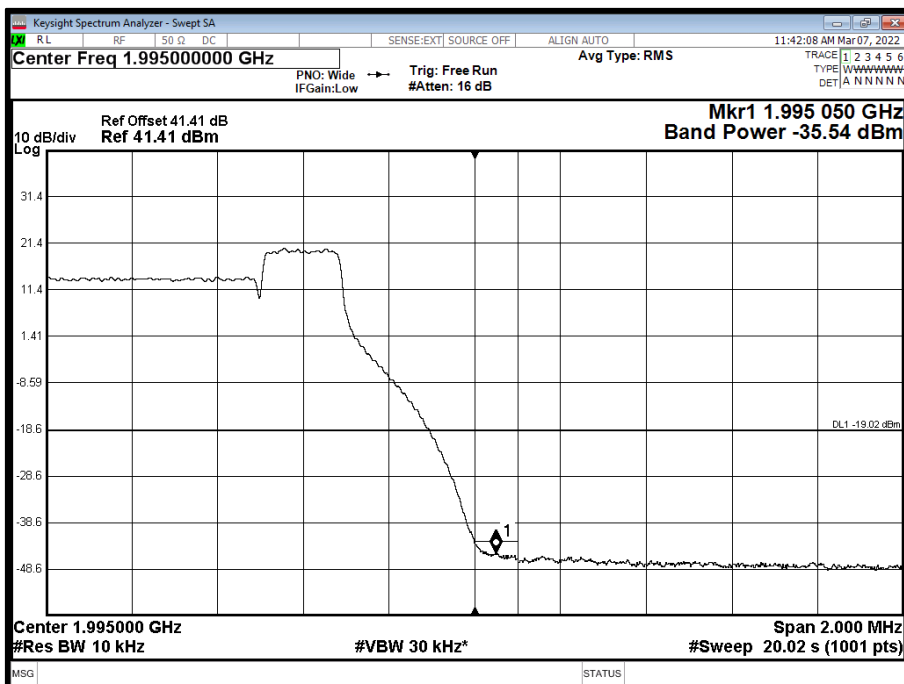



Antenna A - NR Modulation QPSK - NR Carrier Bandwidth 15.0 MHz 15 kHz SCS - Channel Position B

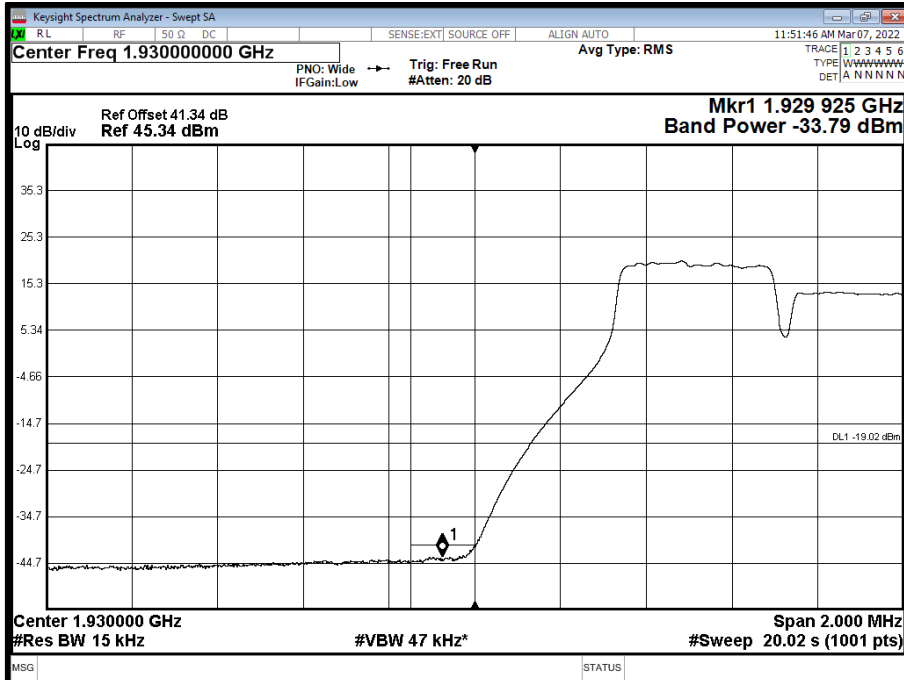

Antenna A - NR Modulation QPSK - NR Carrier Bandwidth 15.0 MHz 15 kHz SCS - Channel Position T

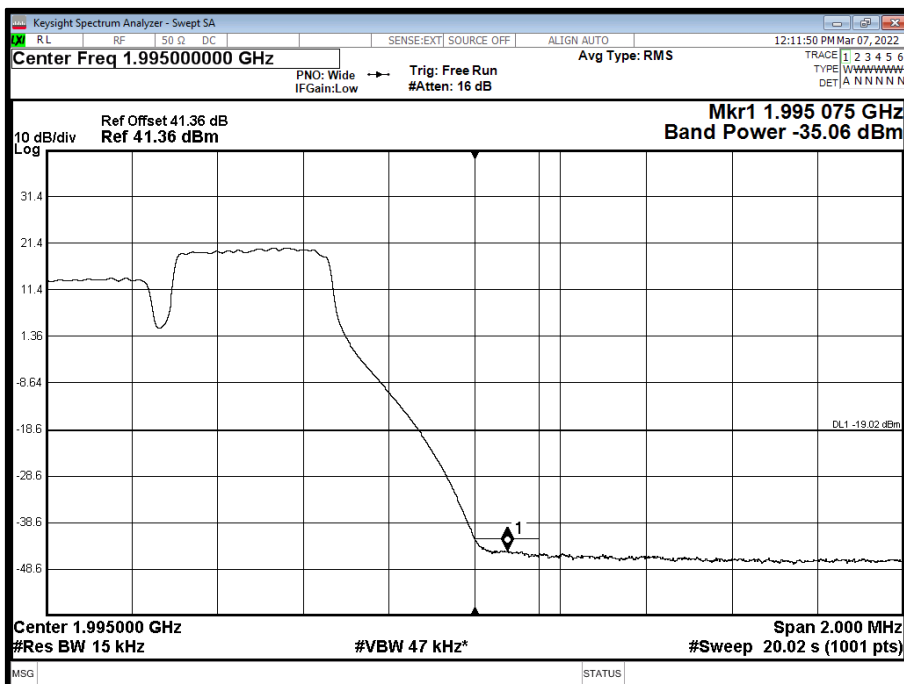



Antenna A - NR Modulation QPSK - NR Carrier Bandwidth 20.0 MHz 15 kHz SCS - Channel Position B

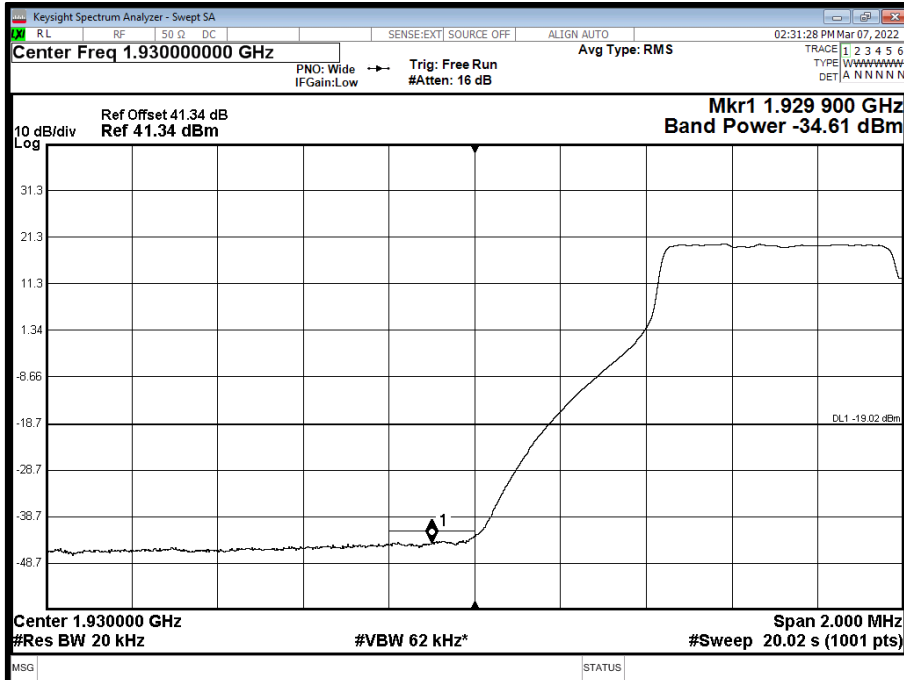

Antenna A - NR Modulation QPSK - NR Carrier Bandwidth 20.0 MHz 15 kHz SCS - Channel Position T

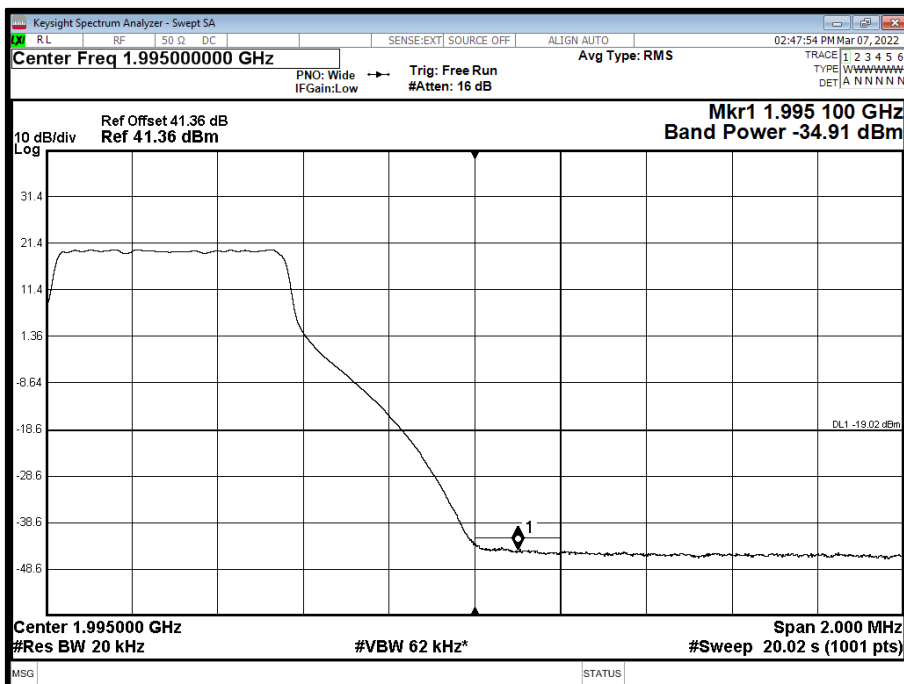



Configuration 2

Maximum Output Power 44.77 dBm

Antenna	NR Modulation	NR Carrier Bandwidth	Band Edge (MHz)	
			Channel Position B	Channel Position T
A	QPSK	10.0 MHz 15 kHz SCS	-	1,985.0
A	QPSK	15.0 MHz 15 kHz SCS	-	1,982.5
A	QPSK	20.0 MHz 15 kHz SCS	-	1,980.0

Antenna A - NR Modulation QPSK - NR Carrier Bandwidth 10.0 MHz 15 kHz SCS - Channel Position T

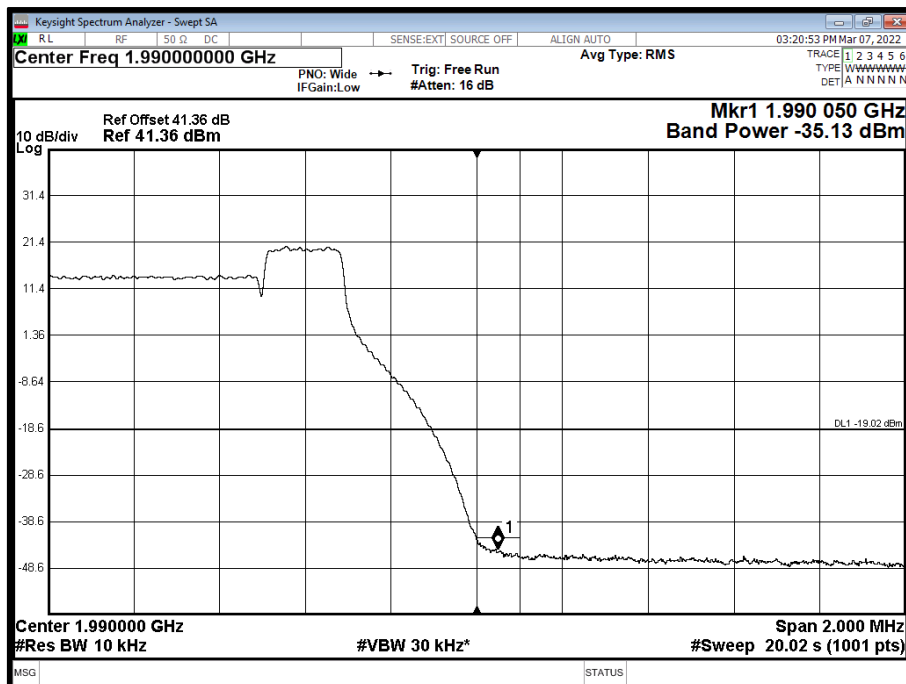



Antenna A - NR Modulation QPSK - NR Carrier Bandwidth 15.0 MHz 15 kHz SCS - Channel Position T

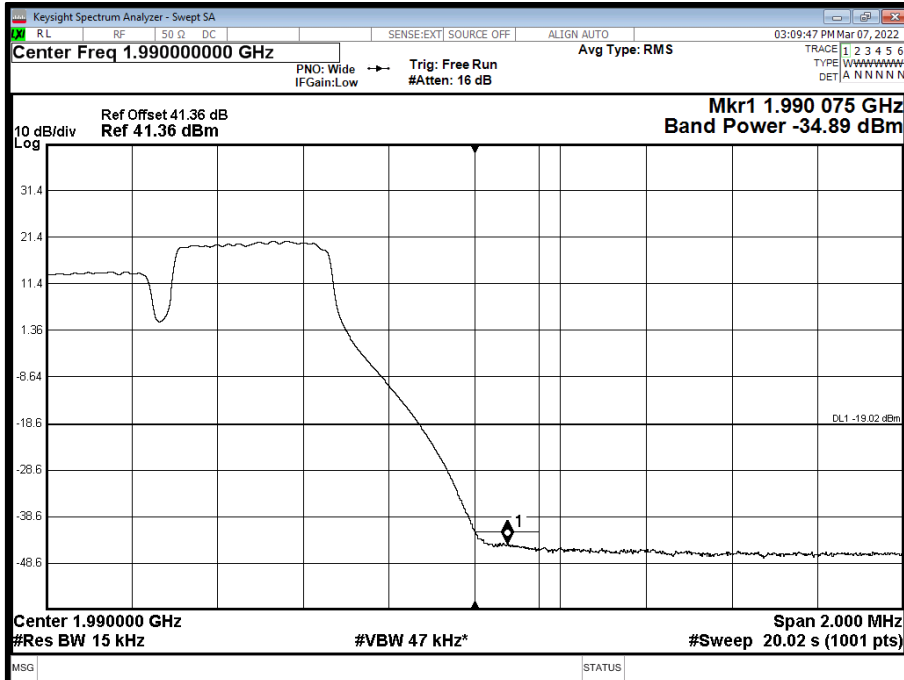

Antenna A - NR Modulation QPSK - NR Carrier Bandwidth 20.0 MHz 15 kHz SCS - Channel Position T

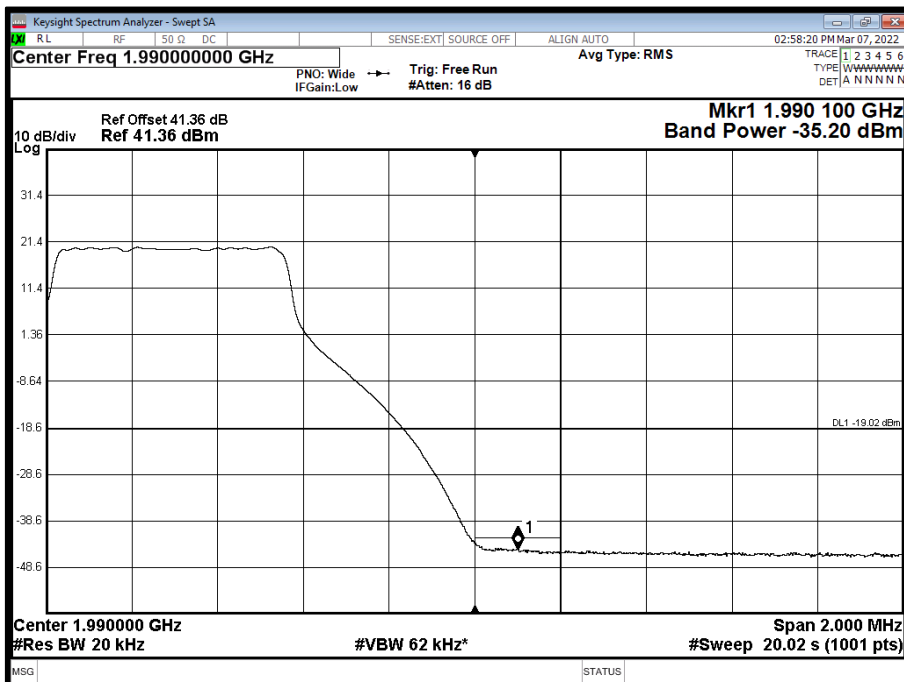



2.4 TRANSMITTER SPURIOUS EMISSIONS

2.4.1 Specification Reference

FCC CFR 47 Part 24, Clause 24.238 (a)
ISED RSS-GEN, Clause 6.13
Industry Canada RSS-133, Clause 6.5
FCC CFR 47 Part 2, Clause 2.1051

2.4.2 Date of Test and Modification State

07-March-2022 - Modification State 0

2.4.3 Test Equipment Used

The major items of test equipment used for the above tests are identified in Section 3.1.

2.4.4 Environmental Conditions

Ambient Temperature	21.1 - 23.1°C
Relative Humidity	27.9 - 31.2%

2.4.5 Test Method

All measurements were made in accordance with FCC KDB 971168 D01, Clause 6.1.

Each antenna port has been declared as being equivalent, therefore measurements were made on one antenna port only. To account for this, the limit was tightened by $10 * \text{Log}(N)$, where N is equal to the number of MIMO antenna ports.

For single port, the limit was calculated as being $-13 \text{ dBm} - 10 * \text{Log}(4) = -19 \text{ dBm}$.

2.4.6 Test Results

Configuration 1

Maximum Output Power 44.77 dBm



Antenna A - NR Modulation QPSK - NR Carrier Bandwidth 10.0 MHz 15 kHz SCS - Channel Position B - Band 1 - Range 0.009 to 3500 MHz

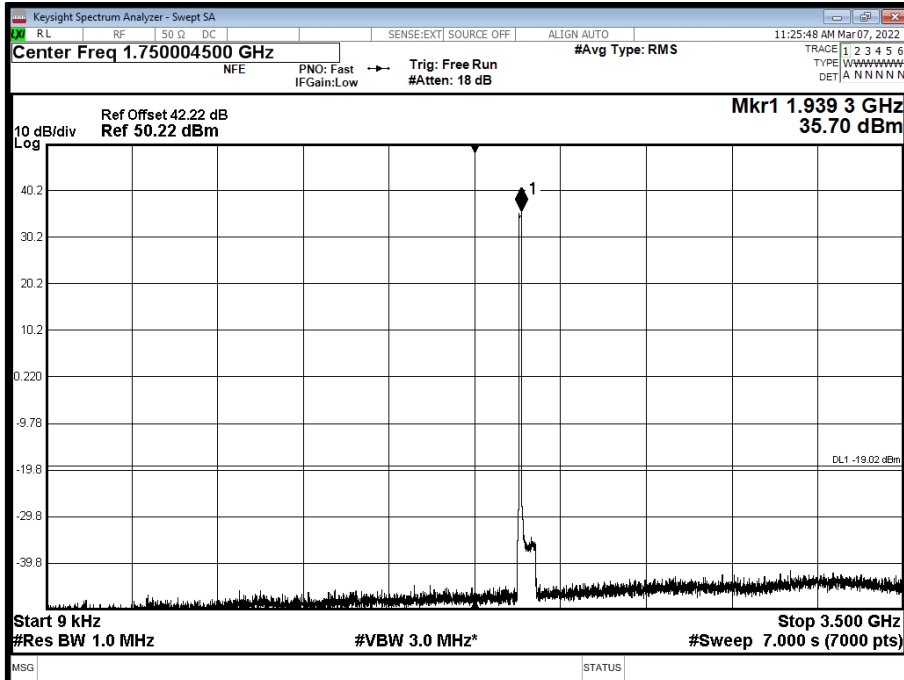

Antenna A - NR Modulation QPSK - NR Carrier Bandwidth 10.0 MHz 15 kHz SCS - Channel Position B - Band 2 - Range 3500 to 12000 MHz

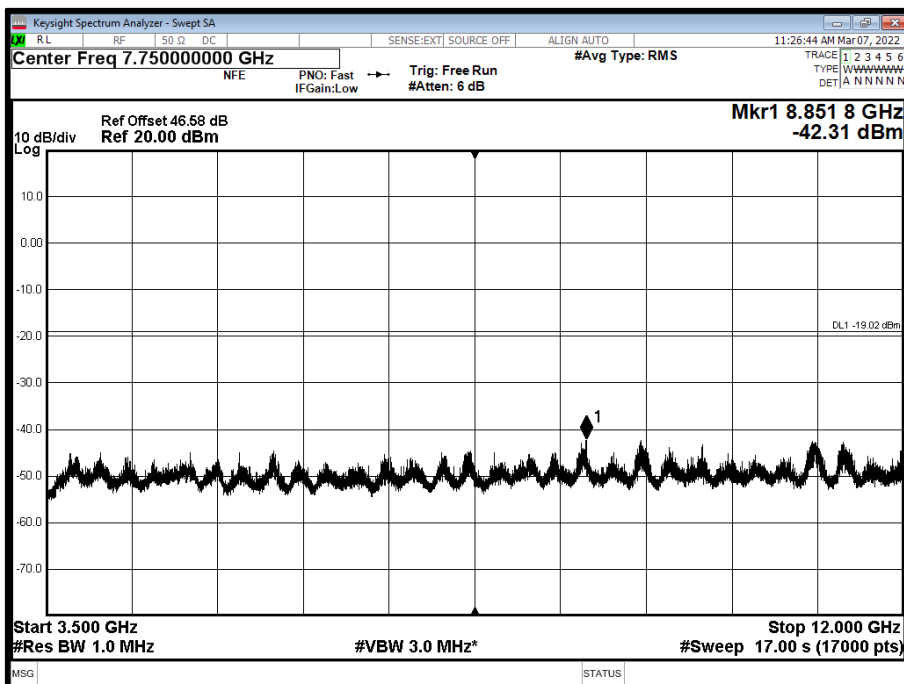



Antenna A - NR Modulation QPSK - NR Carrier Bandwidth 10.0 MHz 15 kHz SCS - Channel Position B - Band 3 - Range 12000 to 18000 MHz

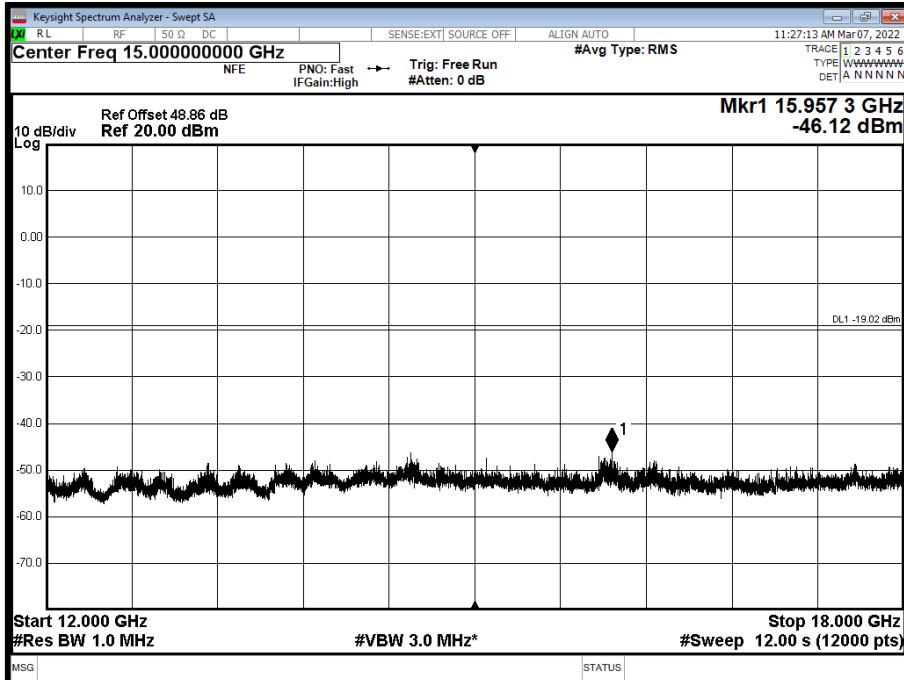

Antenna A - NR Modulation QPSK - NR Carrier Bandwidth 10.0 MHz 15 kHz SCS - Channel Position B - Band 4 - Range 18000 to 20000 MHz

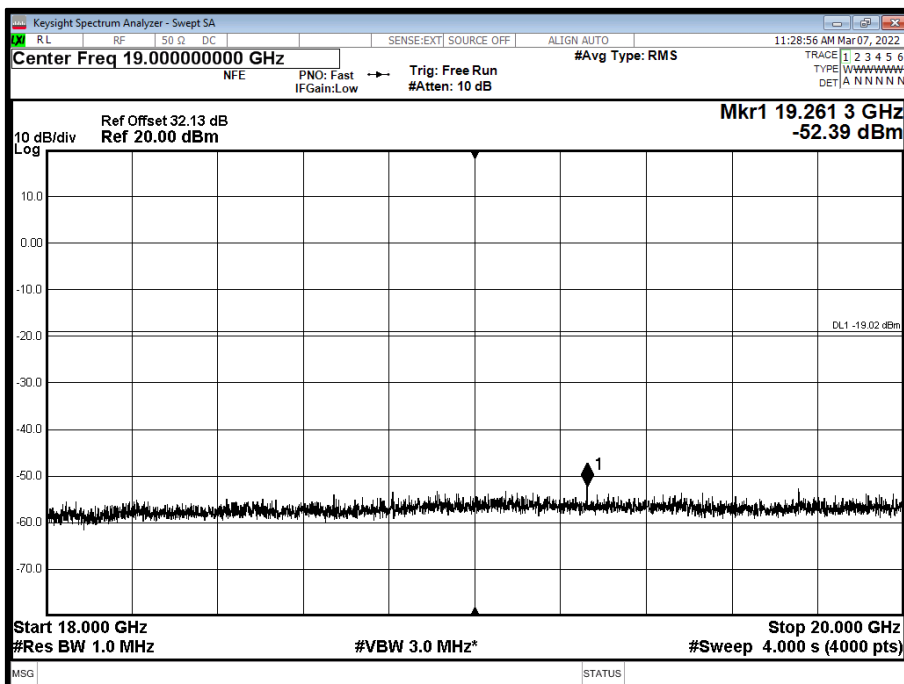



Antenna A - NR Modulation QPSK - NR Carrier Bandwidth 10.0 MHz 15 kHz SCS - Channel Position M - Band 1 - Range 0.009 to 3500 MHz

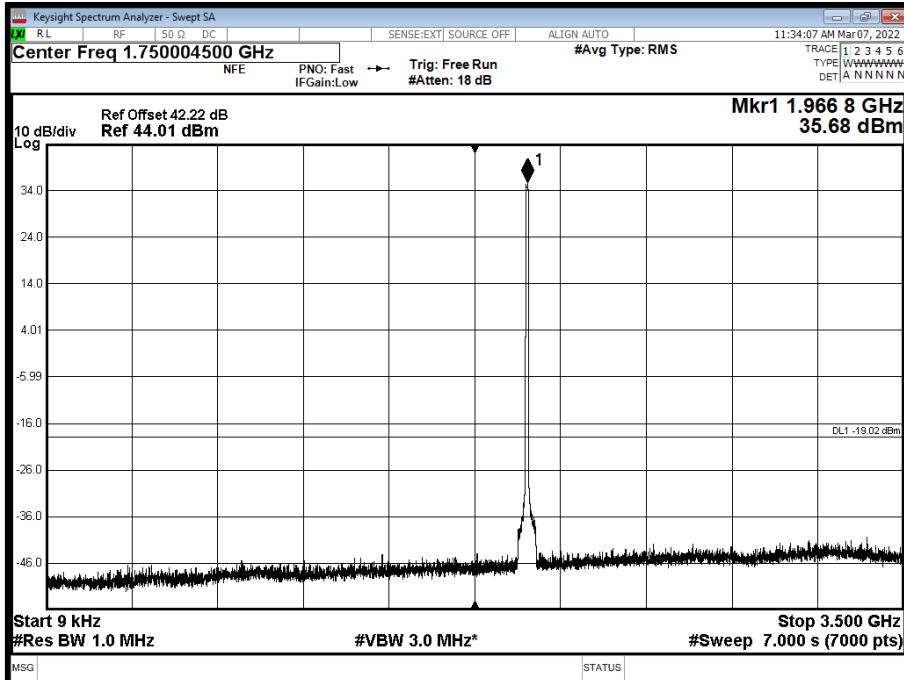

Antenna A - NR Modulation QPSK - NR Carrier Bandwidth 10.0 MHz 15 kHz SCS - Channel Position M - Band 2 - Range 3500 to 12000 MHz

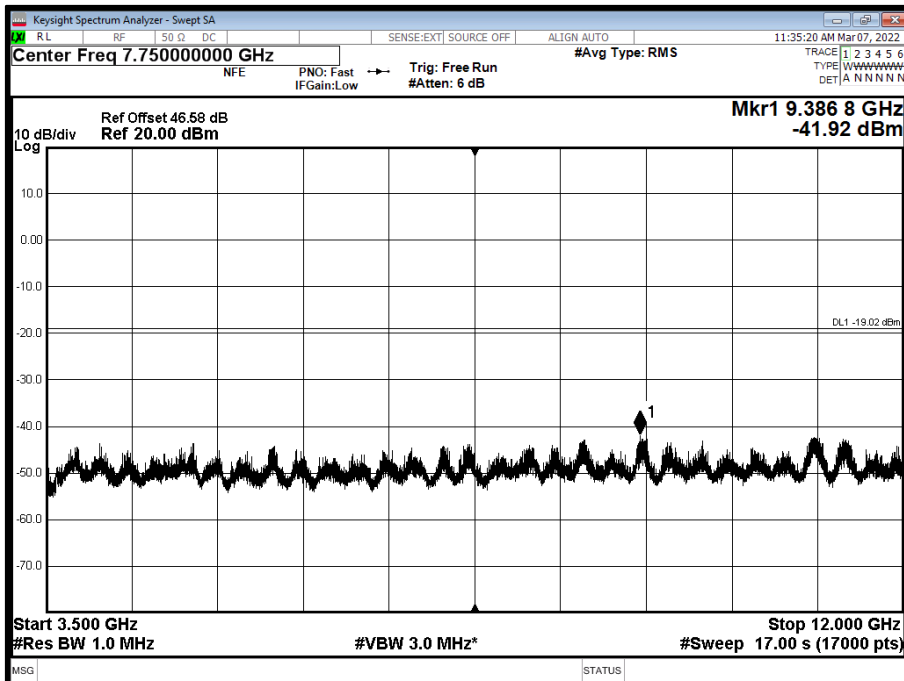



Antenna A - NR Modulation QPSK - NR Carrier Bandwidth 10.0 MHz 15 kHz SCS - Channel Position M - Band 3 - Range 12000 to 18000 MHz

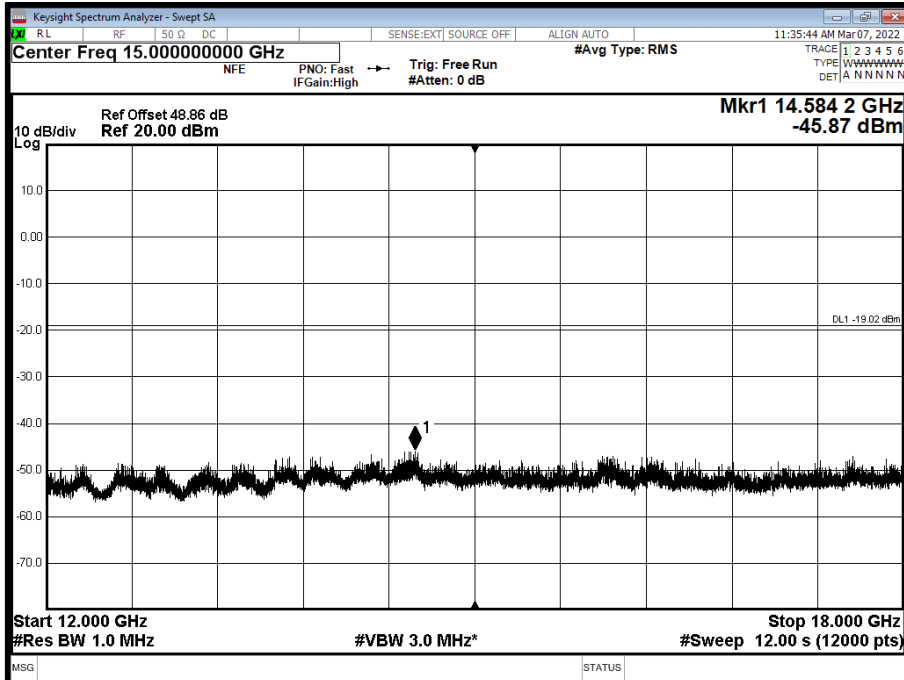

Antenna A - NR Modulation QPSK - NR Carrier Bandwidth 10.0 MHz 15 kHz SCS - Channel Position M - Band 4 - Range 18000 to 20000 MHz

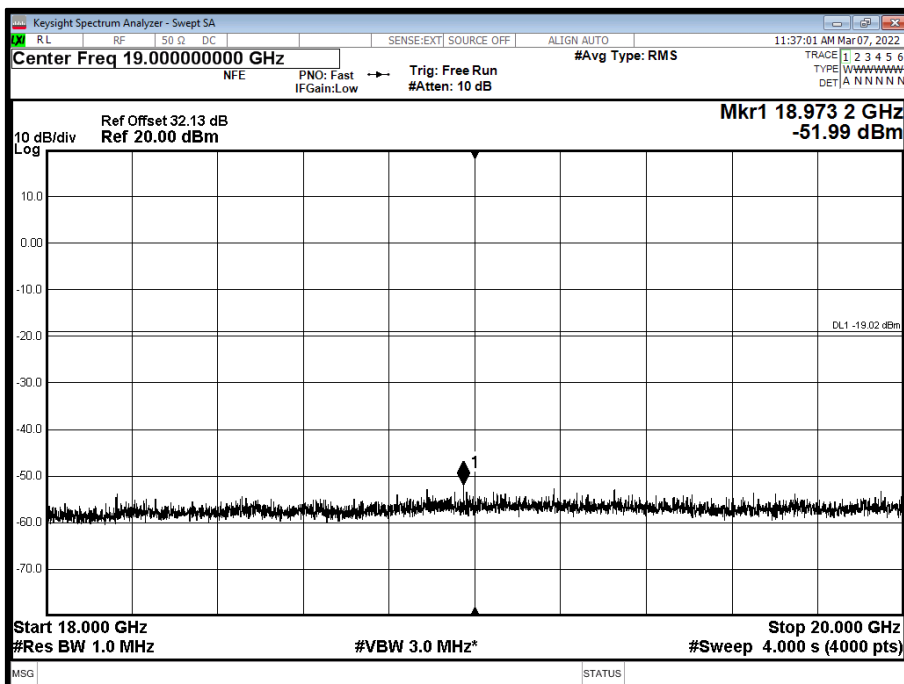



Antenna A - NR Modulation QPSK - NR Carrier Bandwidth 10.0 MHz 15 kHz SCS - Channel Position T - Band 1 - Range 0.009 to 3500 MHz

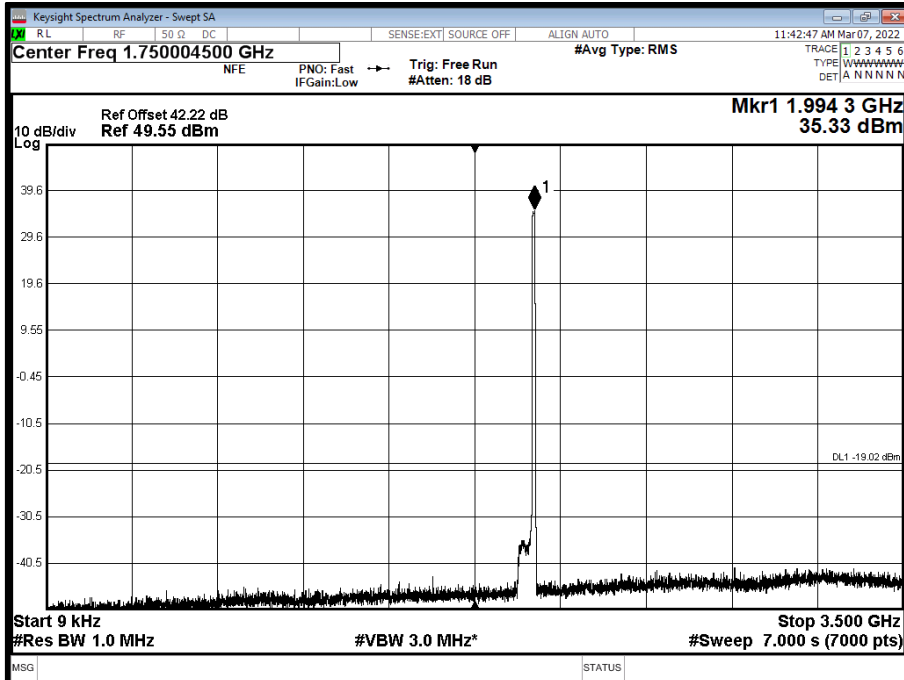

Antenna A - NR Modulation QPSK - NR Carrier Bandwidth 10.0 MHz 15 kHz SCS - Channel Position T - Band 2 - Range 3500 to 12000 MHz

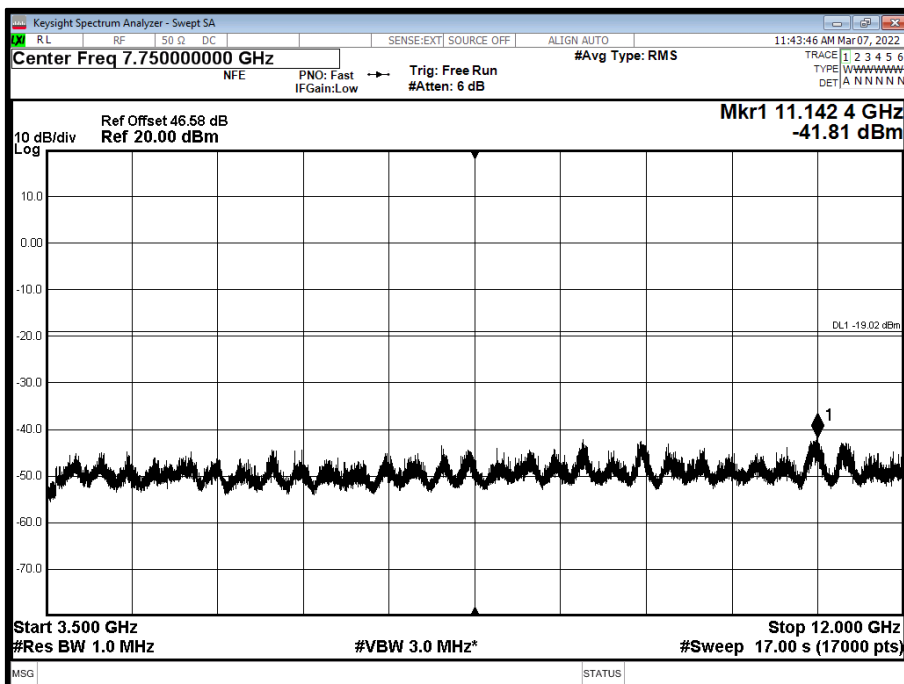



Antenna A - NR Modulation QPSK - NR Carrier Bandwidth 10.0 MHz 15 kHz SCS - Channel Position T - Band 3 - Range 12000 to 18000 MHz

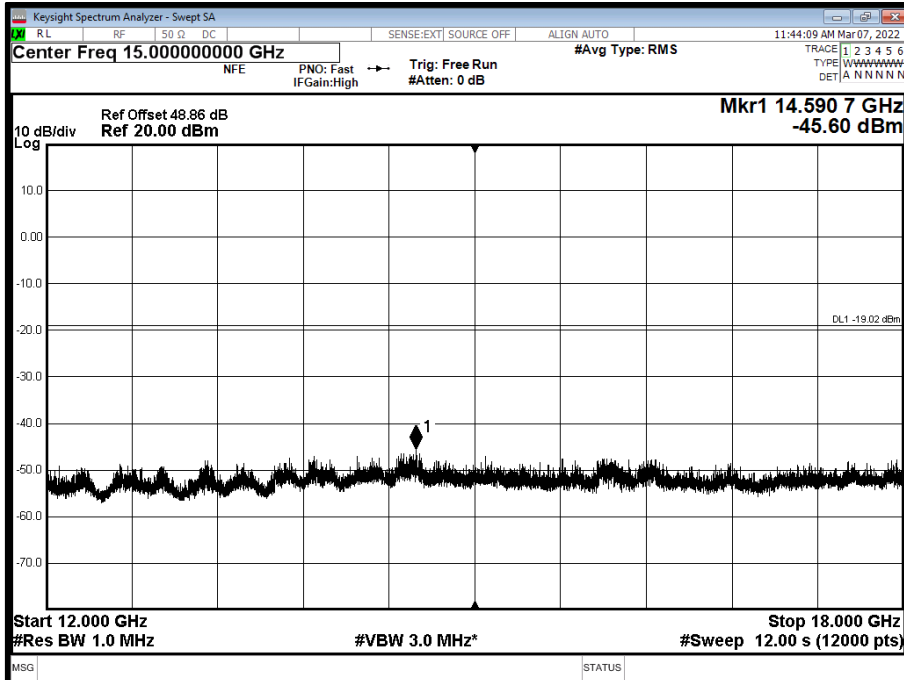

Antenna A - NR Modulation QPSK - NR Carrier Bandwidth 10.0 MHz 15 kHz SCS - Channel Position T - Band 4 - Range 18000 to 20000 MHz

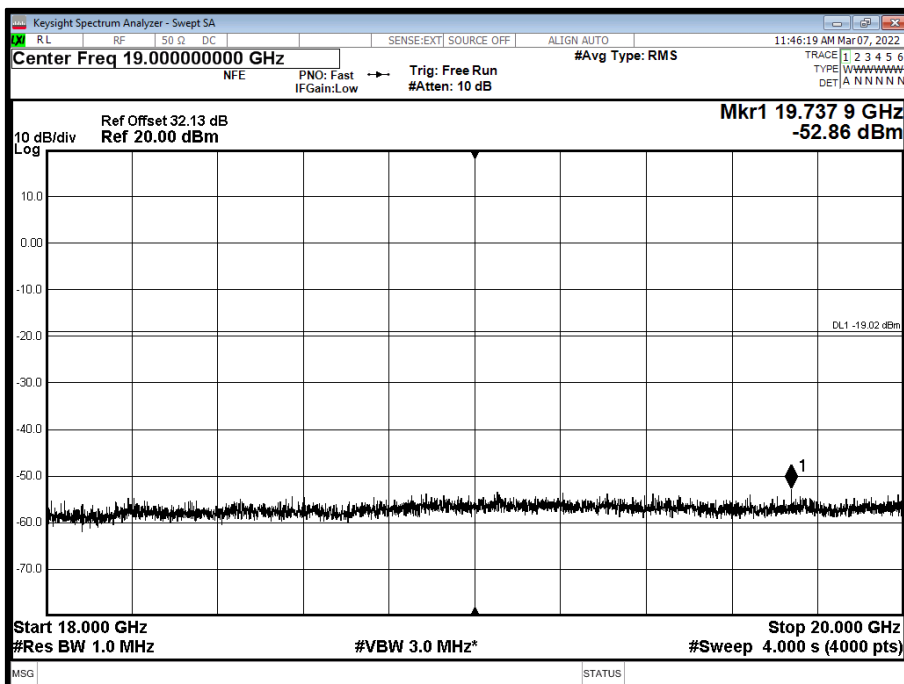



Antenna A - NR Modulation QPSK - NR Carrier Bandwidth 15.0 MHz 15 kHz SCS - Channel Position B - Band 1 - Range 0.009 to 3500 MHz

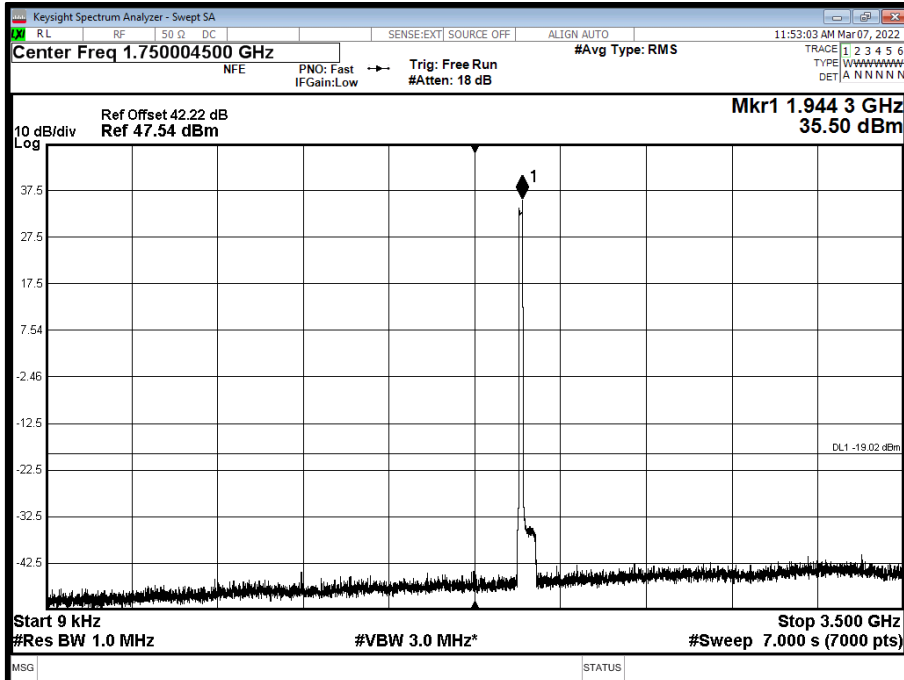

Antenna A - NR Modulation QPSK - NR Carrier Bandwidth 15.0 MHz 15 kHz SCS - Channel Position B - Band 2 - Range 3500 to 12000 MHz

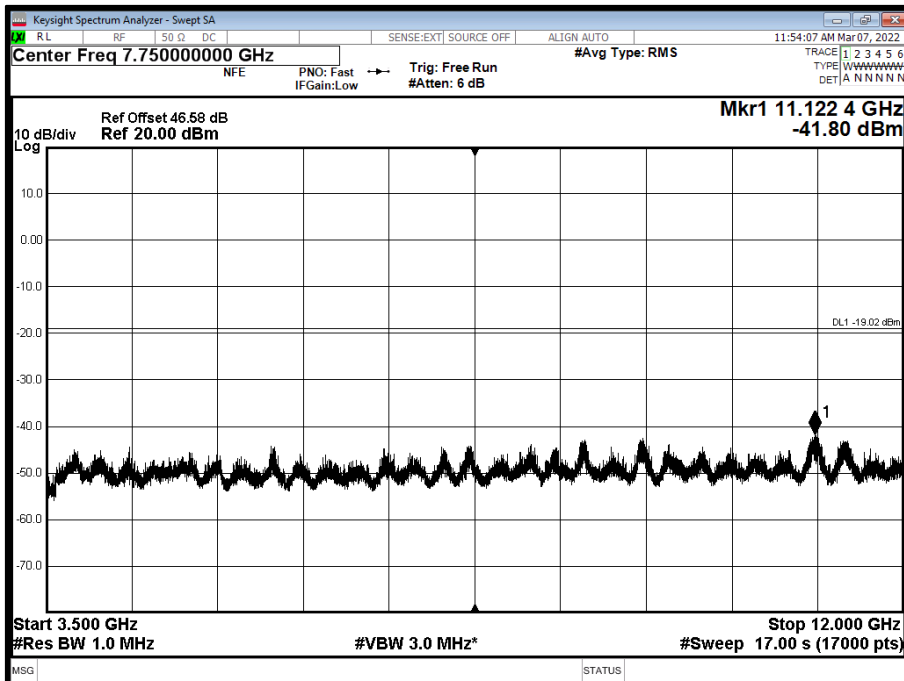



Antenna A - NR Modulation QPSK - NR Carrier Bandwidth 15.0 MHz 15 kHz SCS - Channel Position B - Band 3 - Range 12000 to 18000 MHz

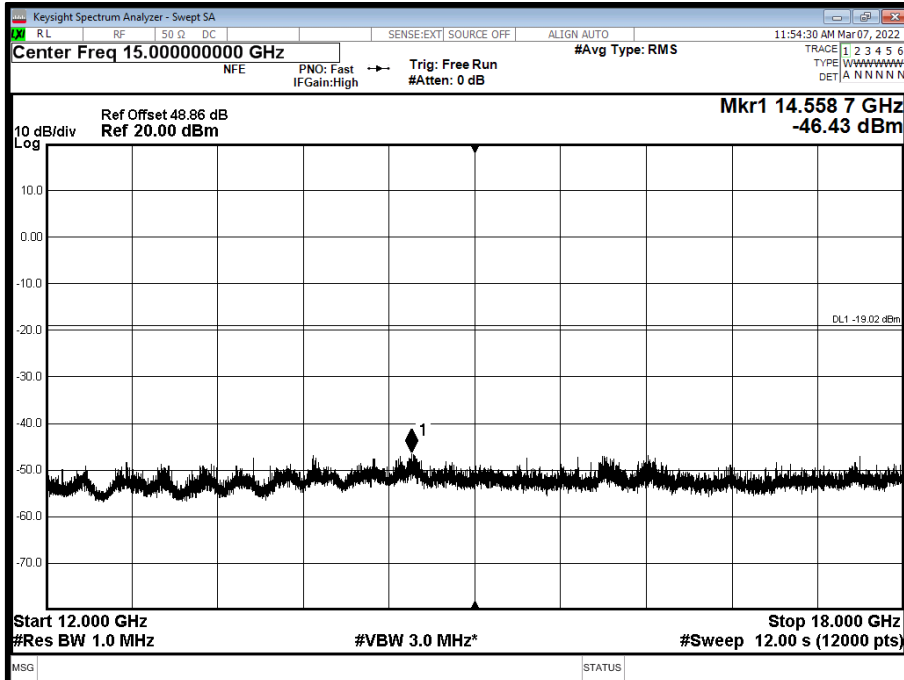

Antenna A - NR Modulation QPSK - NR Carrier Bandwidth 15.0 MHz 15 kHz SCS - Channel Position B - Band 4 - Range 18000 to 20000 MHz

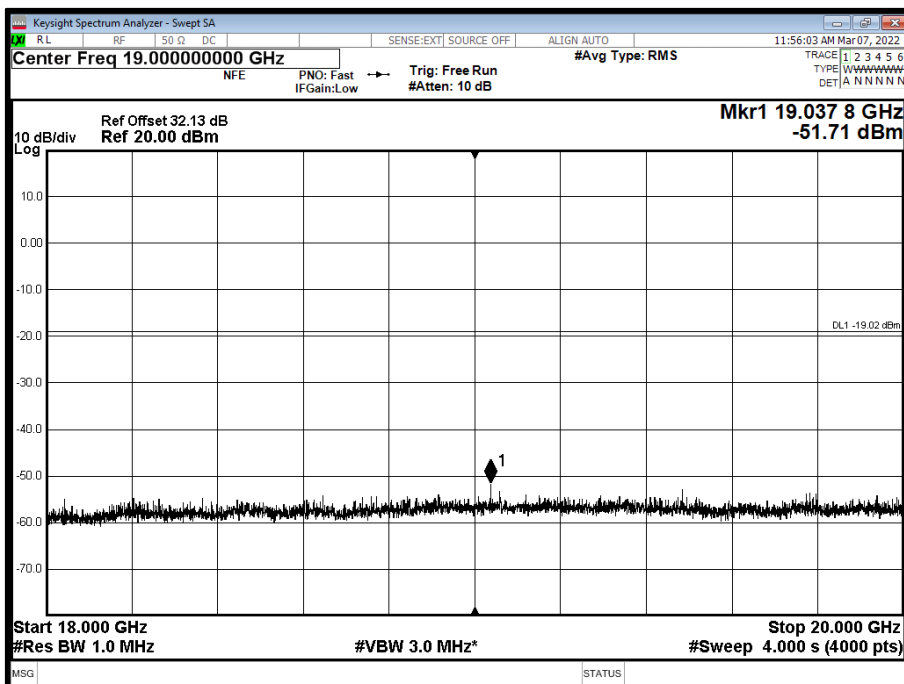



Antenna A - NR Modulation QPSK - NR Carrier Bandwidth 15.0 MHz 15 kHz SCS - Channel Position M - Band 1 - Range 0.009 to 3500 MHz

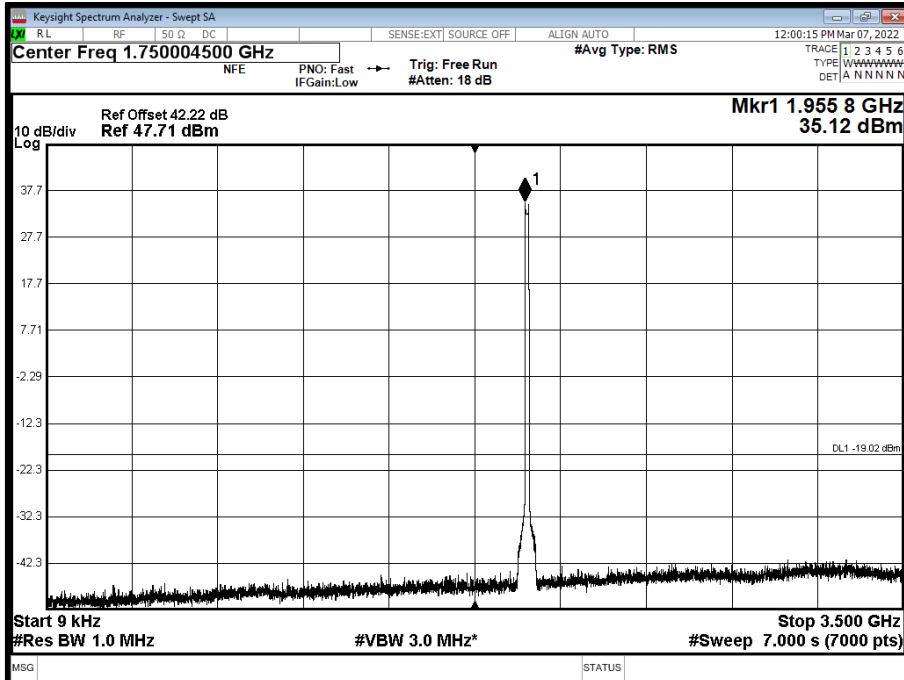

Antenna A - NR Modulation QPSK - NR Carrier Bandwidth 15.0 MHz 15 kHz SCS - Channel Position M - Band 2 - Range 3500 to 12000 MHz

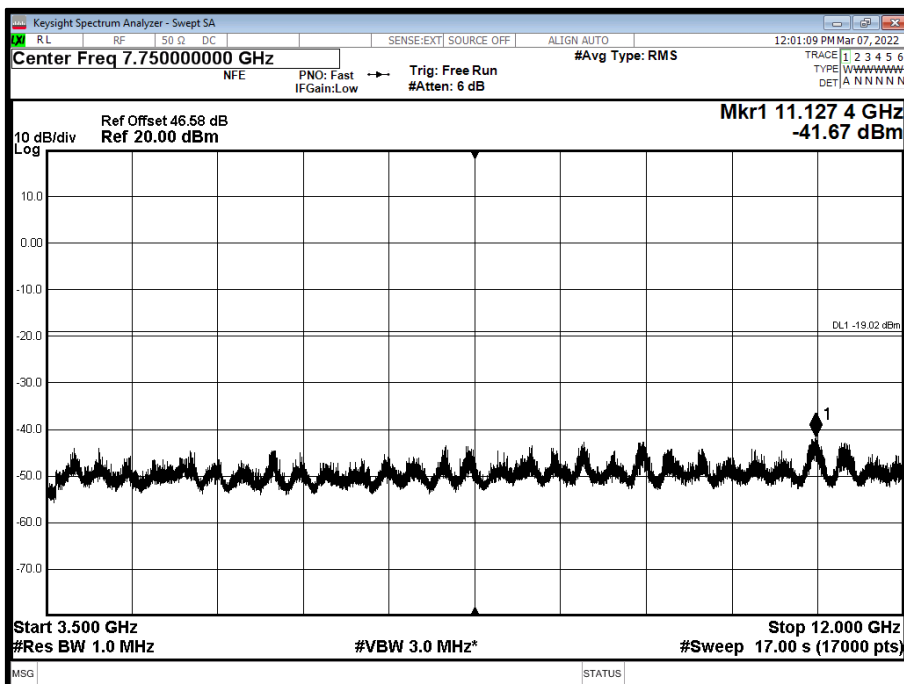



Antenna A - NR Modulation QPSK - NR Carrier Bandwidth 15.0 MHz 15 kHz SCS - Channel Position M - Band 3 - Range 12000 to 18000 MHz

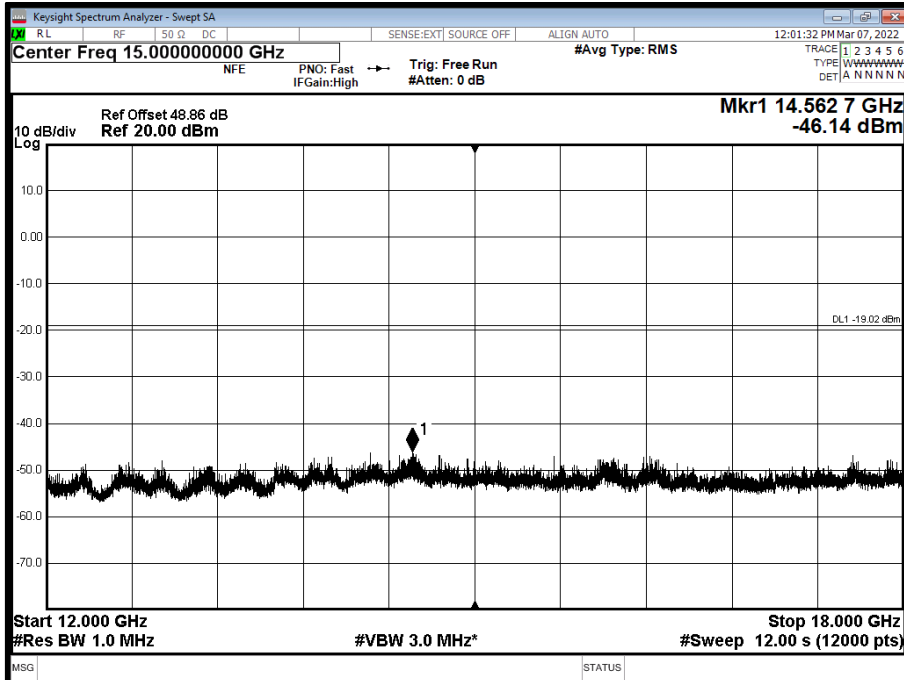

Antenna A - NR Modulation QPSK - NR Carrier Bandwidth 15.0 MHz 15 kHz SCS - Channel Position M - Band 4 - Range 18000 to 20000 MHz

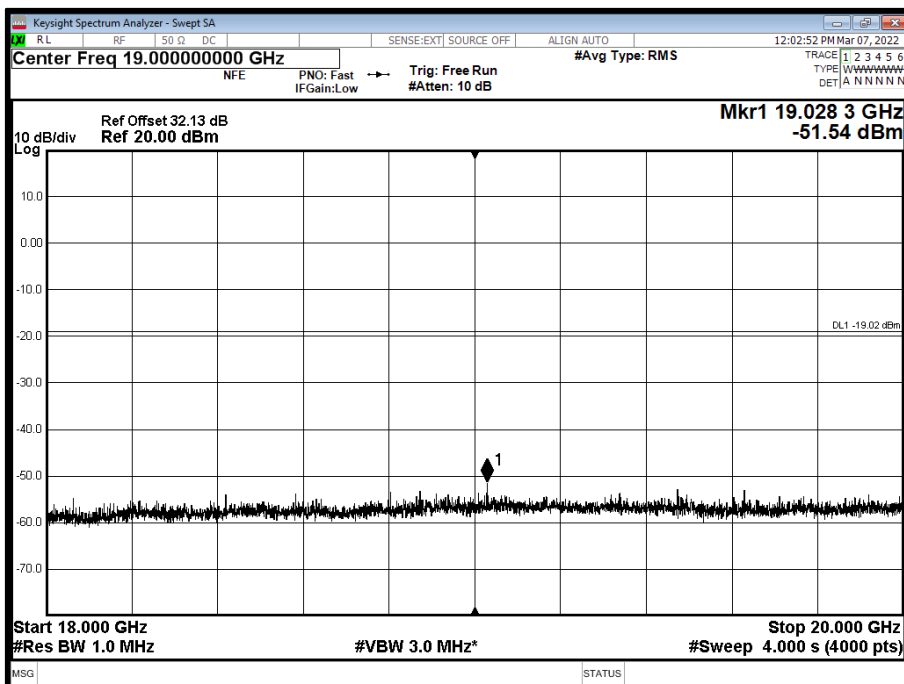



Antenna A - NR Modulation QPSK - NR Carrier Bandwidth 15.0 MHz 15 kHz SCS - Channel Position T - Band 1 - Range 0.009 to 3500 MHz

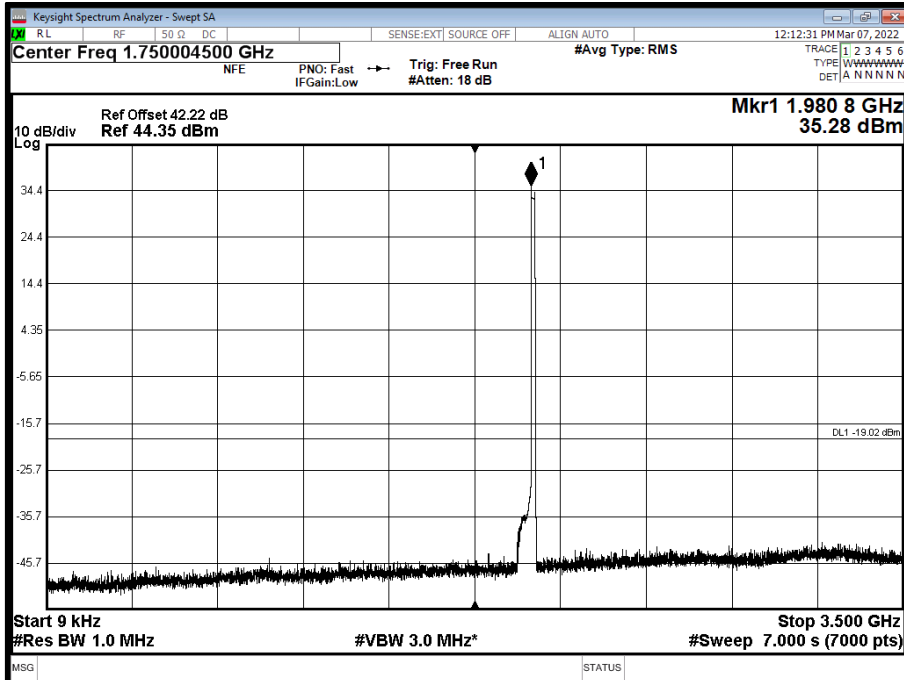

Antenna A - NR Modulation QPSK - NR Carrier Bandwidth 15.0 MHz 15 kHz SCS - Channel Position T - Band 2 - Range 3500 to 12000 MHz

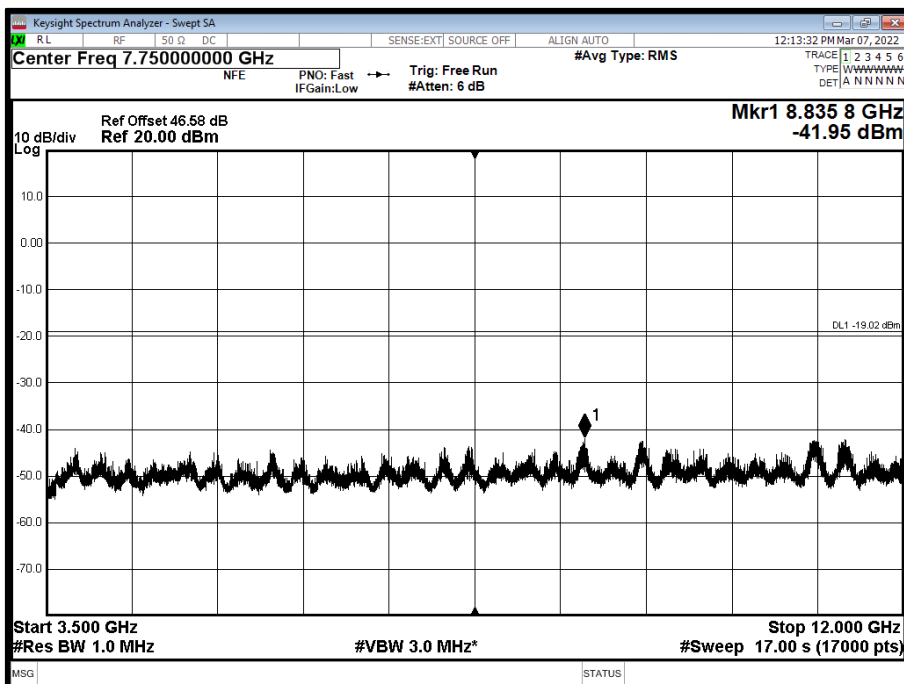



Antenna A - NR Modulation QPSK - NR Carrier Bandwidth 15.0 MHz 15 kHz SCS - Channel Position T - Band 3 - Range 12000 to 18000 MHz

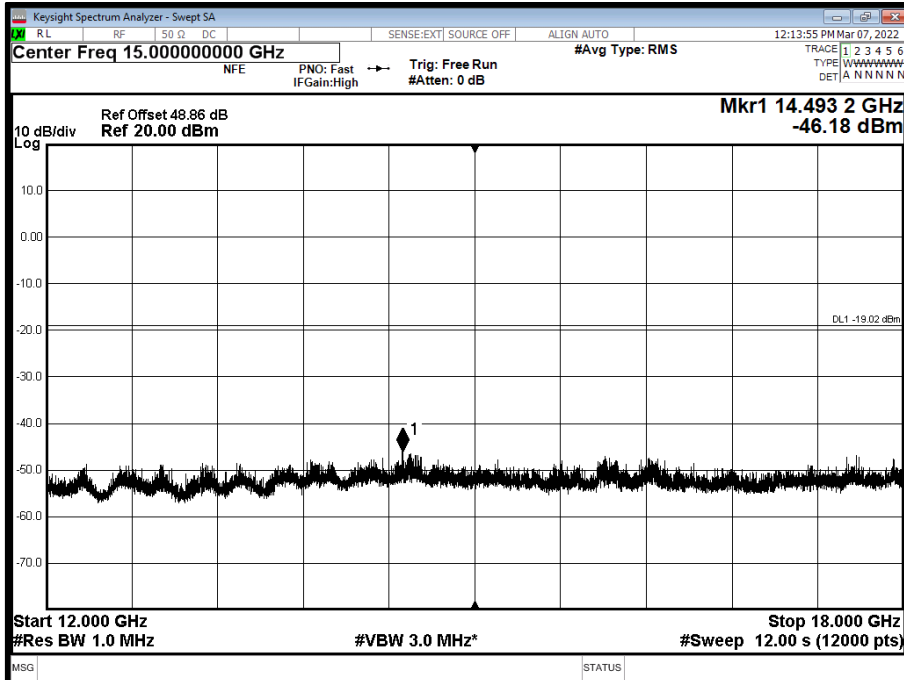

Antenna A - NR Modulation QPSK - NR Carrier Bandwidth 15.0 MHz 15 kHz SCS - Channel Position T - Band 4 - Range 18000 to 20000 MHz

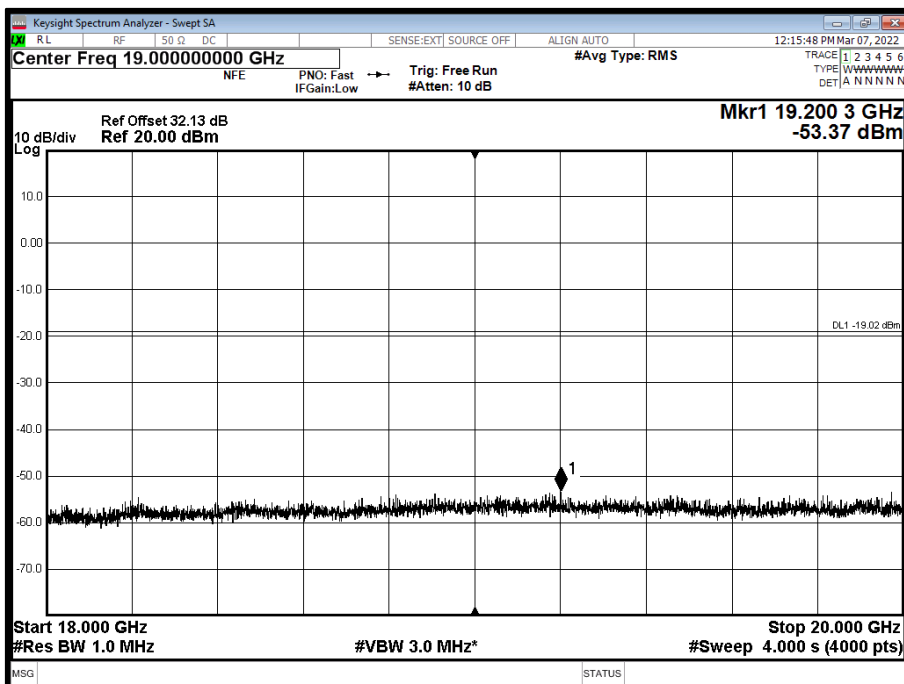



Antenna A - NR Modulation QPSK - NR Carrier Bandwidth 20.0 MHz 15 kHz SCS - Channel Position B - Band 1 - Range 0.009 to 3500 MHz

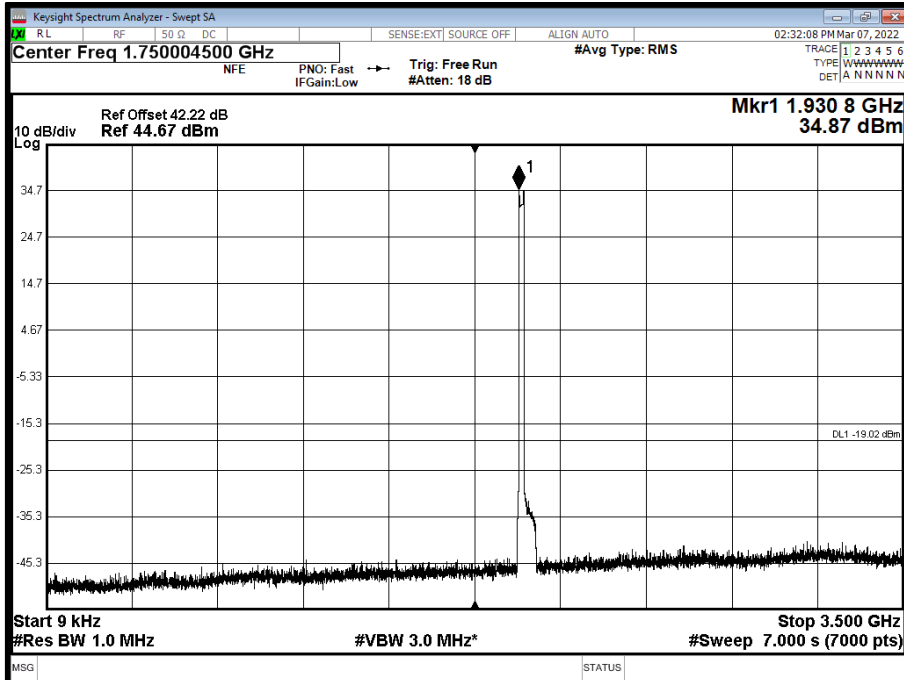

Antenna A - NR Modulation QPSK - NR Carrier Bandwidth 20.0 MHz 15 kHz SCS - Channel Position B - Band 2 - Range 3500 to 12000 MHz

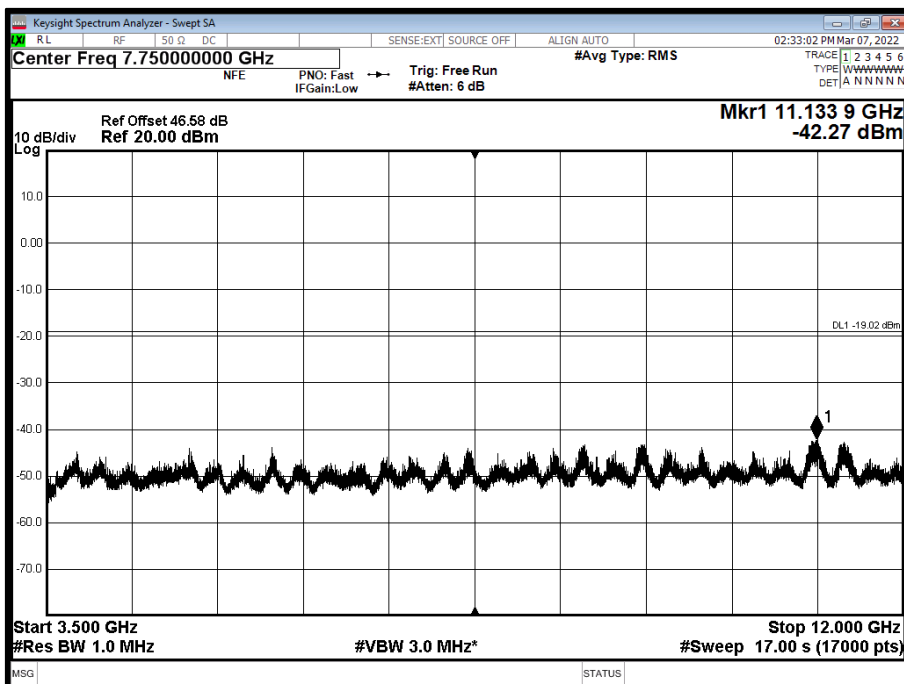



Antenna A - NR Modulation QPSK - NR Carrier Bandwidth 20.0 MHz 15 kHz SCS - Channel Position B - Band 3 - Range 12000 to 18000 MHz

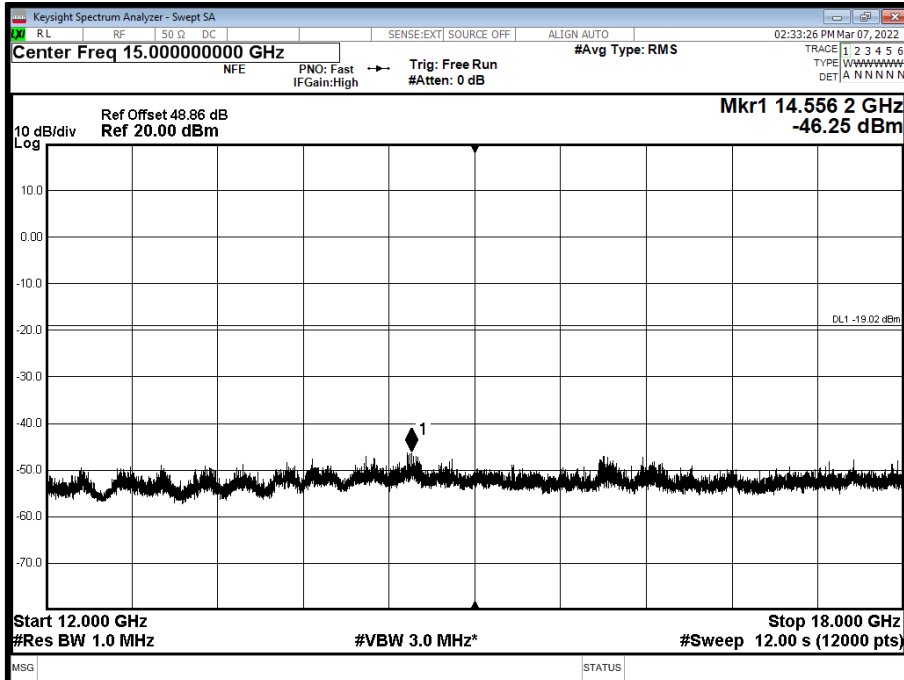

Antenna A - NR Modulation QPSK - NR Carrier Bandwidth 20.0 MHz 15 kHz SCS - Channel Position B - Band 4 - Range 18000 to 20000 MHz

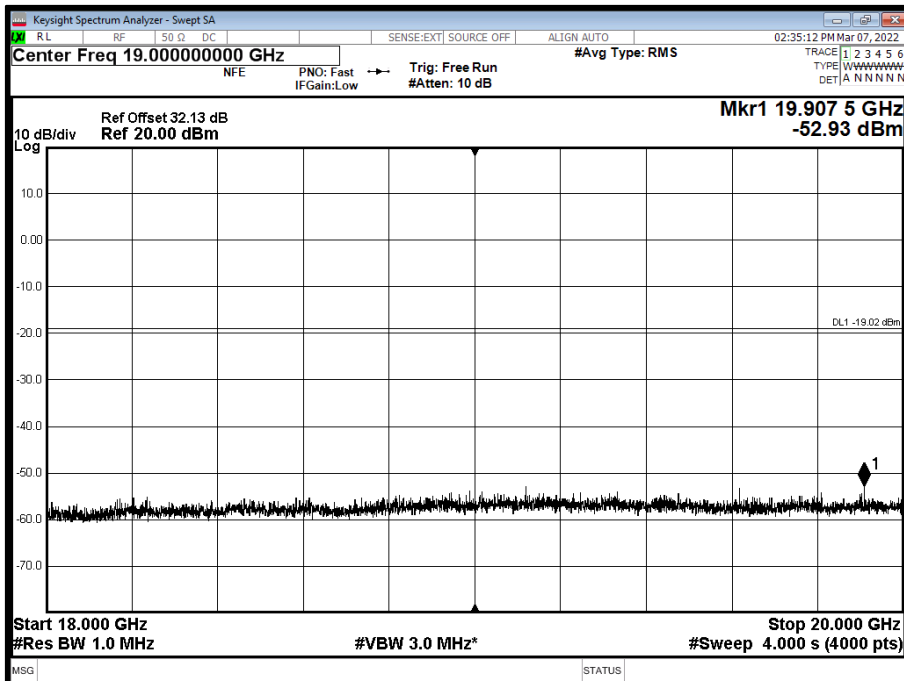



Antenna A - NR Modulation QPSK - NR Carrier Bandwidth 20.0 MHz 15 kHz SCS - Channel Position M - Band 1 - Range 0.009 to 3500 MHz

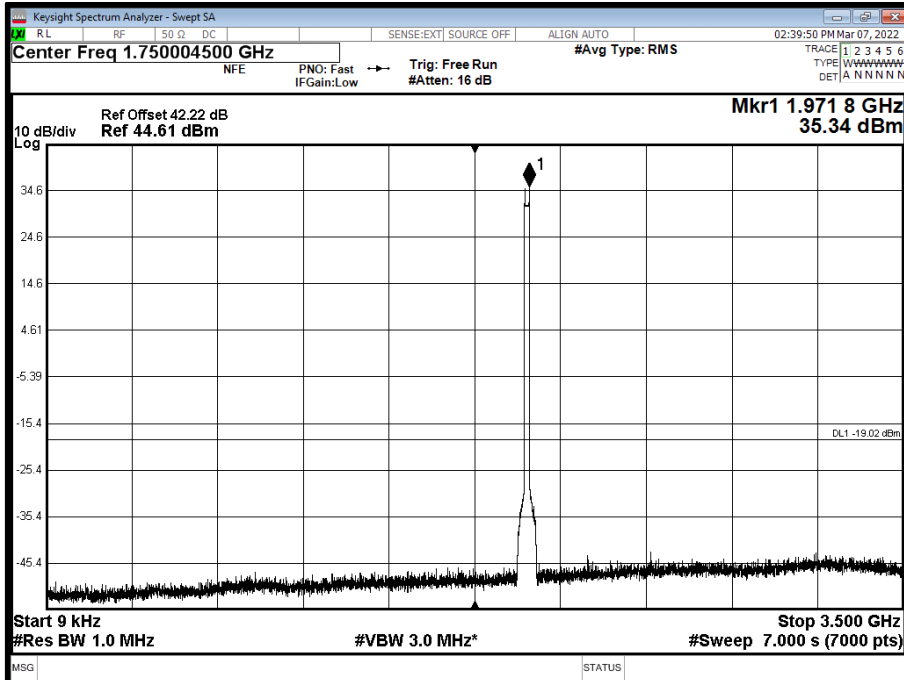

Antenna A - NR Modulation QPSK - NR Carrier Bandwidth 20.0 MHz 15 kHz SCS - Channel Position M - Band 2 - Range 3500 to 12000 MHz

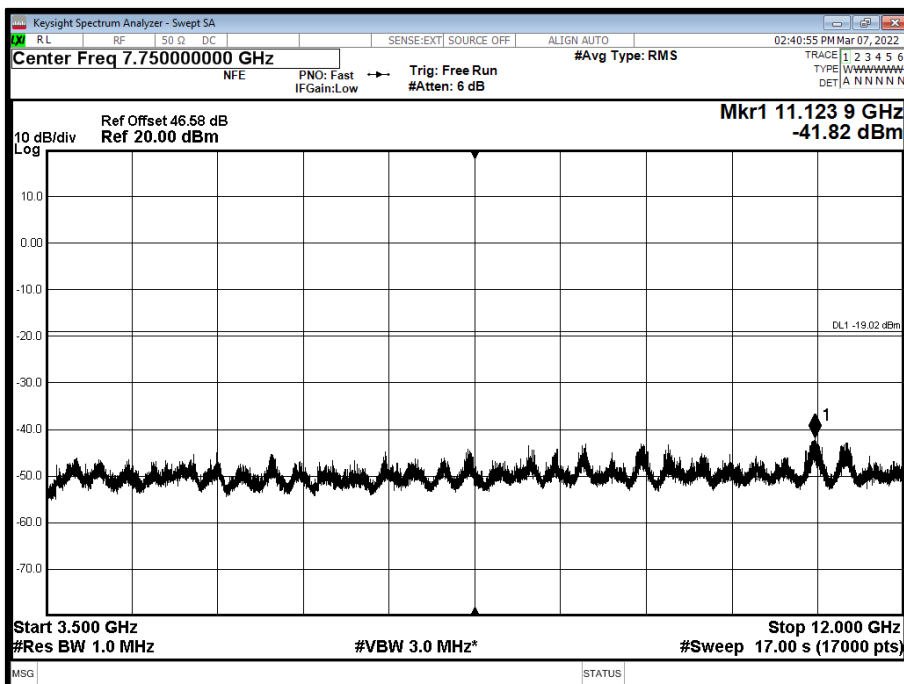



Antenna A - NR Modulation QPSK - NR Carrier Bandwidth 20.0 MHz 15 kHz SCS - Channel Position M - Band 3 - Range 12000 to 18000 MHz

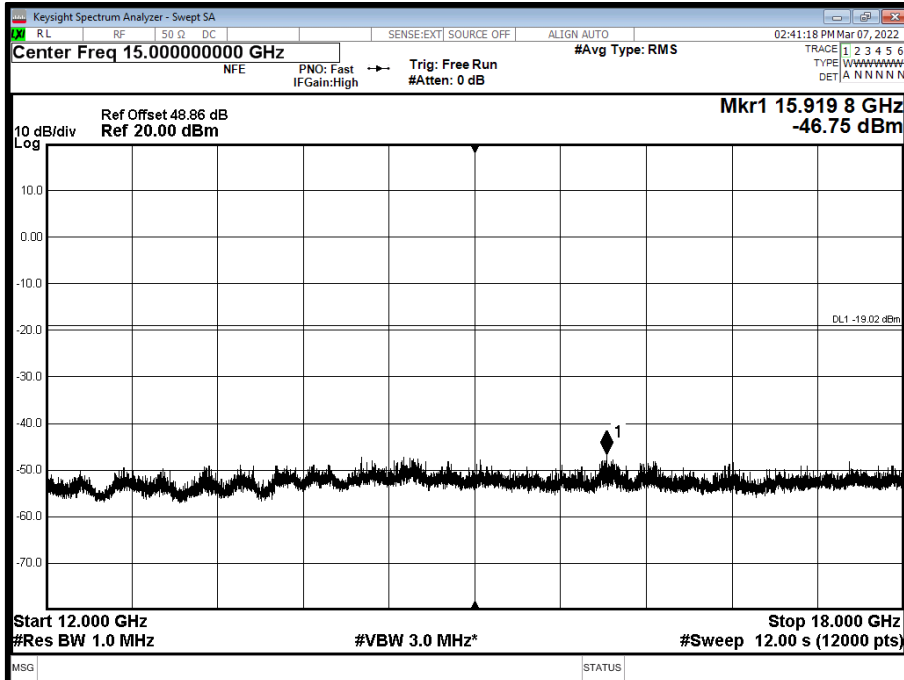

Antenna A - NR Modulation QPSK - NR Carrier Bandwidth 20.0 MHz 15 kHz SCS - Channel Position M - Band 4 - Range 18000 to 20000 MHz

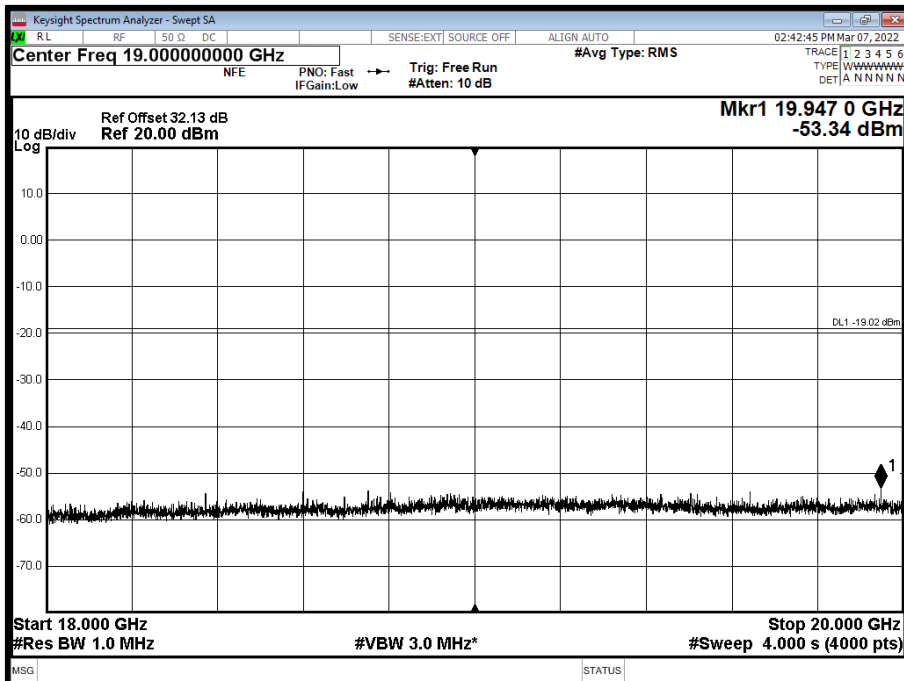



Antenna A - NR Modulation QPSK - NR Carrier Bandwidth 20.0 MHz 15 kHz SCS - Channel Position T - Band 1 - Range 0.009 to 3500 MHz

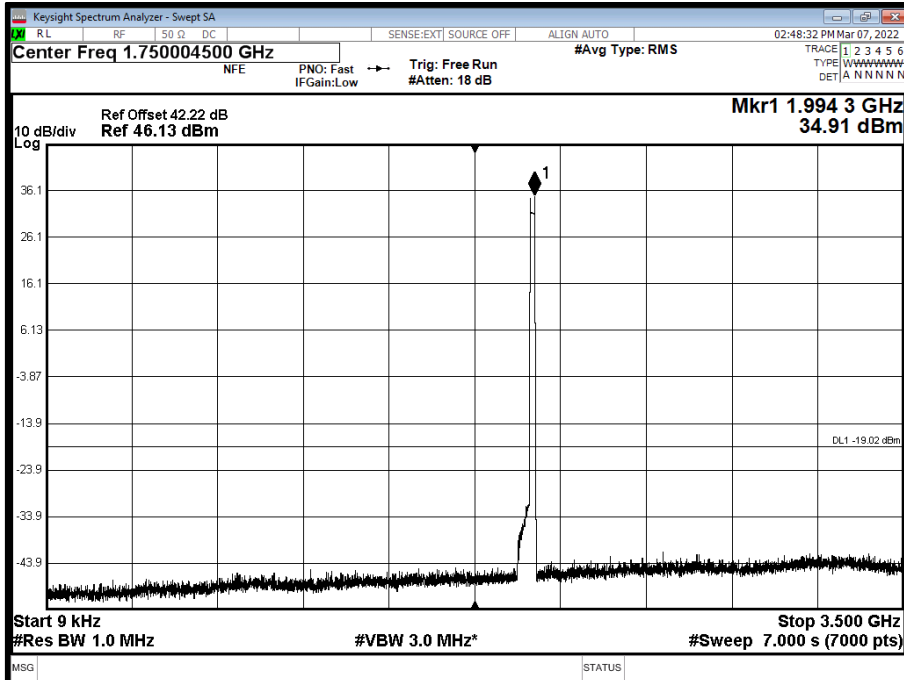

Antenna A - NR Modulation QPSK - NR Carrier Bandwidth 20.0 MHz 15 kHz SCS - Channel Position T - Band 2 - Range 3500 to 12000 MHz

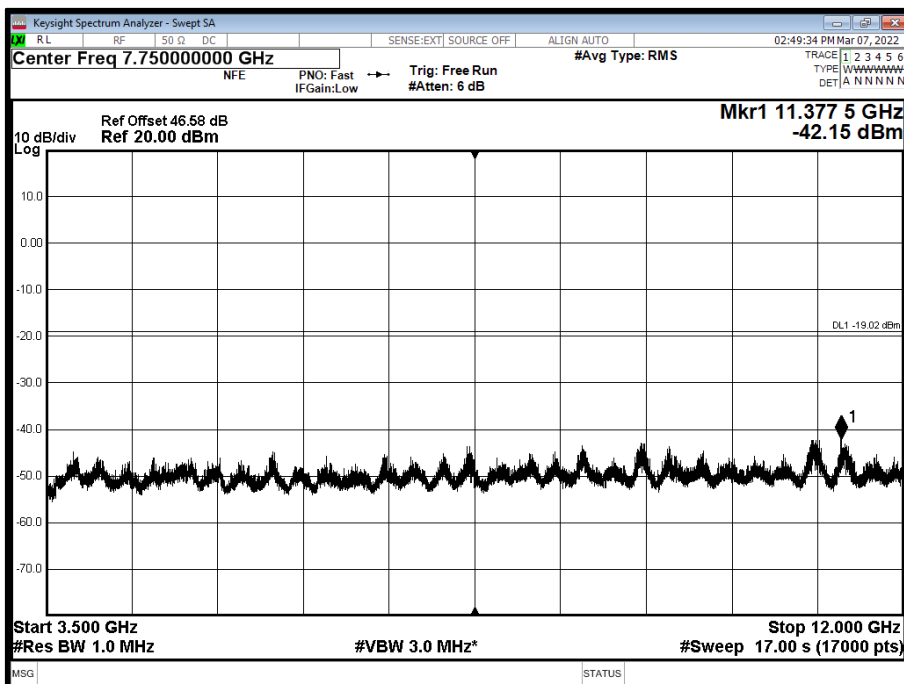



Antenna A - NR Modulation QPSK - NR Carrier Bandwidth 20.0 MHz 15 kHz SCS - Channel Position T - Band 3 - Range 12000 to 18000 MHz

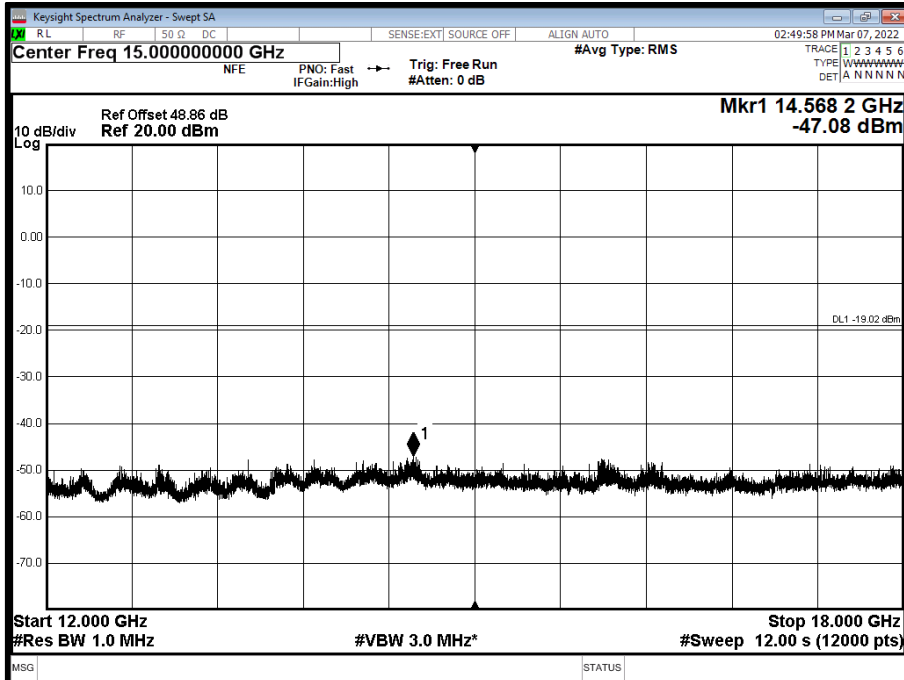

Antenna A - NR Modulation QPSK - NR Carrier Bandwidth 20.0 MHz 15 kHz SCS - Channel Position T - Band 4 - Range 18000 to 20000 MHz

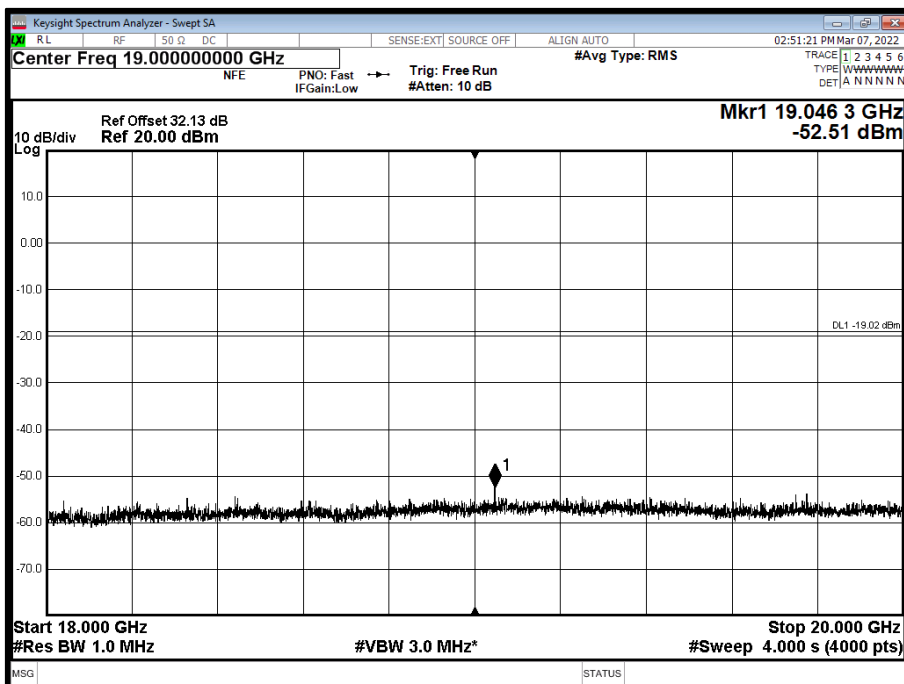

Configuration 2

Maximum Output Power 44.77 dBm



Antenna A - NR Modulation QPSK - NR Carrier Bandwidth 10.0 MHz 15 kHz SCS - Channel Position T - Band 1 - Range 0.009 to 3500 MHz

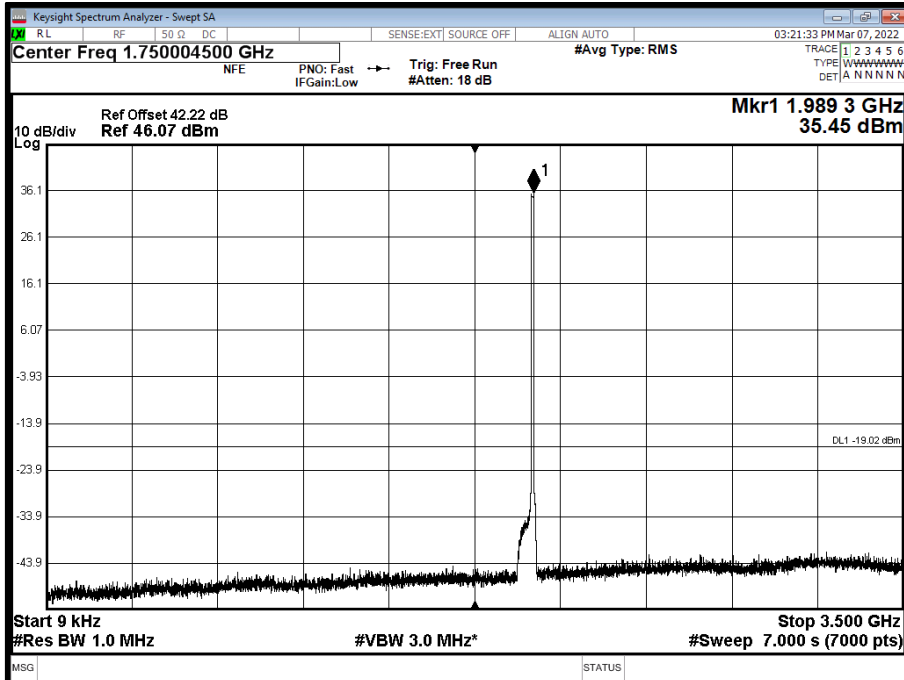

Antenna A - NR Modulation QPSK - NR Carrier Bandwidth 10.0 MHz 15 kHz SCS - Channel Position T - Band 2 - Range 3500 to 12000 MHz

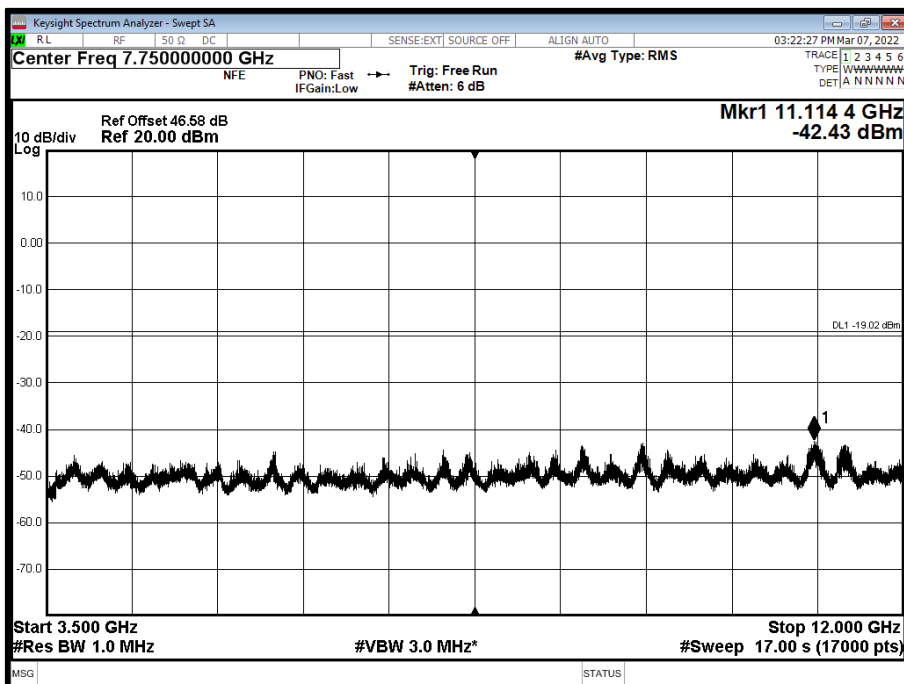



Antenna A - NR Modulation QPSK - NR Carrier Bandwidth 10.0 MHz 15 kHz SCS - Channel Position T - Band 3 - Range 12000 to 18000 MHz

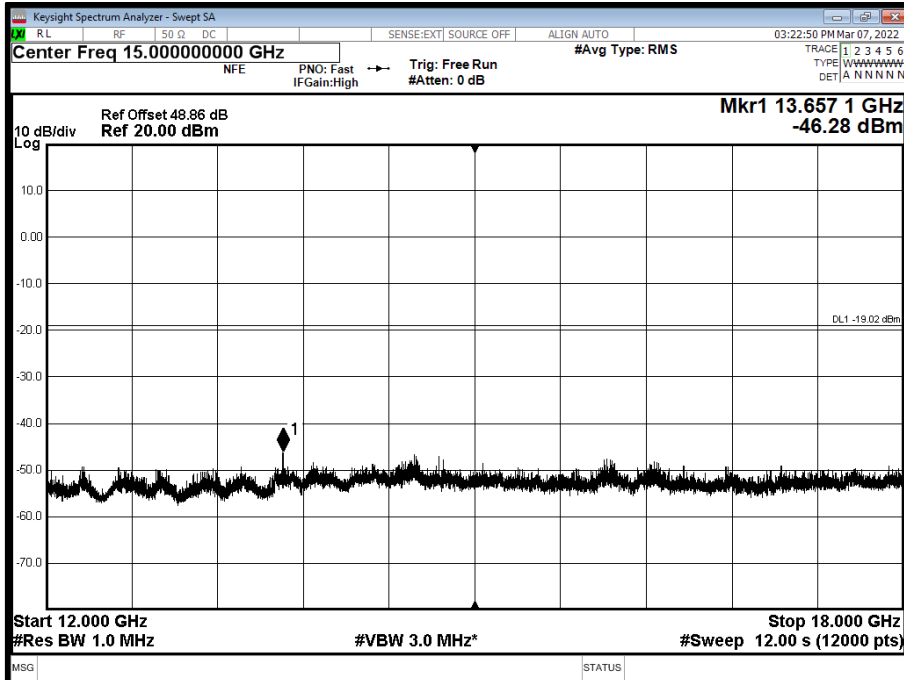

Antenna A - NR Modulation QPSK - NR Carrier Bandwidth 10.0 MHz 15 kHz SCS - Channel Position T - Band 4 - Range 18000 to 20000 MHz

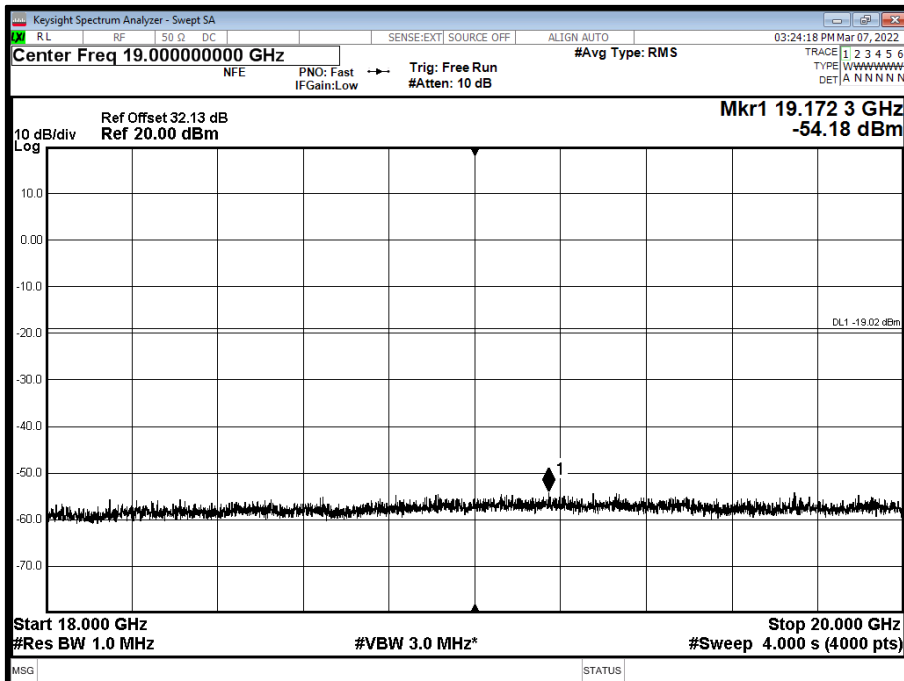



Antenna A - NR Modulation QPSK - NR Carrier Bandwidth 15.0 MHz 15 kHz SCS - Channel Position T - Band 1 - Range 0.009 to 3500 MHz

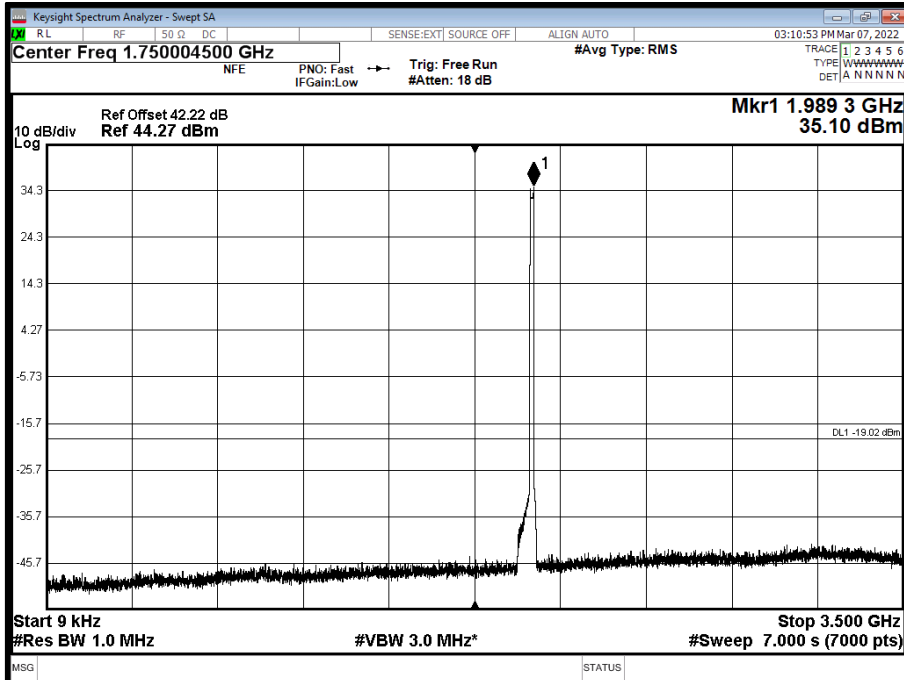

Antenna A - NR Modulation QPSK - NR Carrier Bandwidth 15.0 MHz 15 kHz SCS - Channel Position T - Band 2 - Range 3500 to 12000 MHz

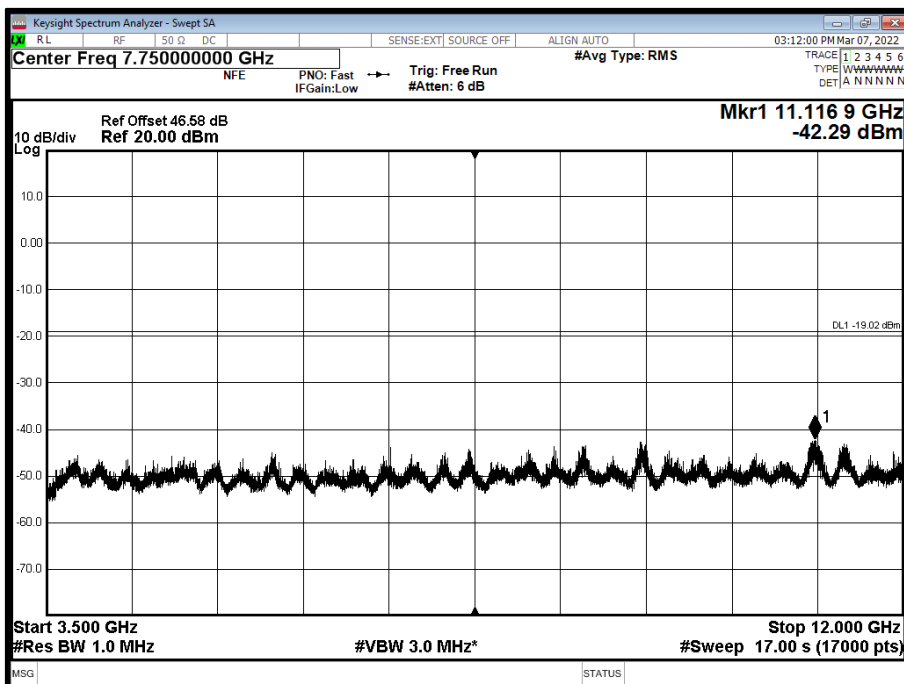



Antenna A - NR Modulation QPSK - NR Carrier Bandwidth 15.0 MHz 15 kHz SCS - Channel Position T - Band 3 - Range 12000 to 18000 MHz

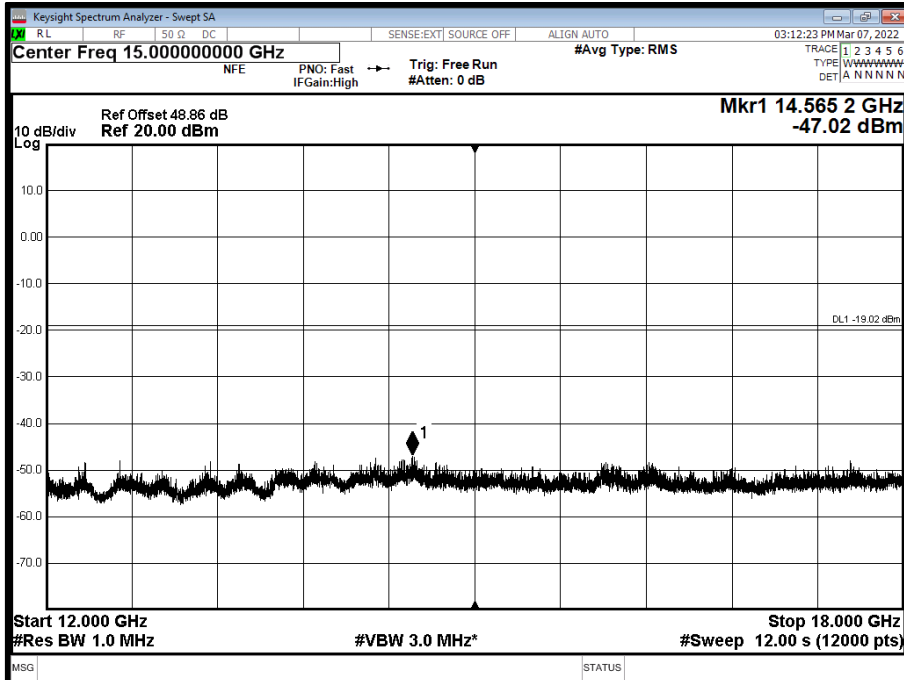

Antenna A - NR Modulation QPSK - NR Carrier Bandwidth 15.0 MHz 15 kHz SCS - Channel Position T - Band 4 - Range 18000 to 20000 MHz

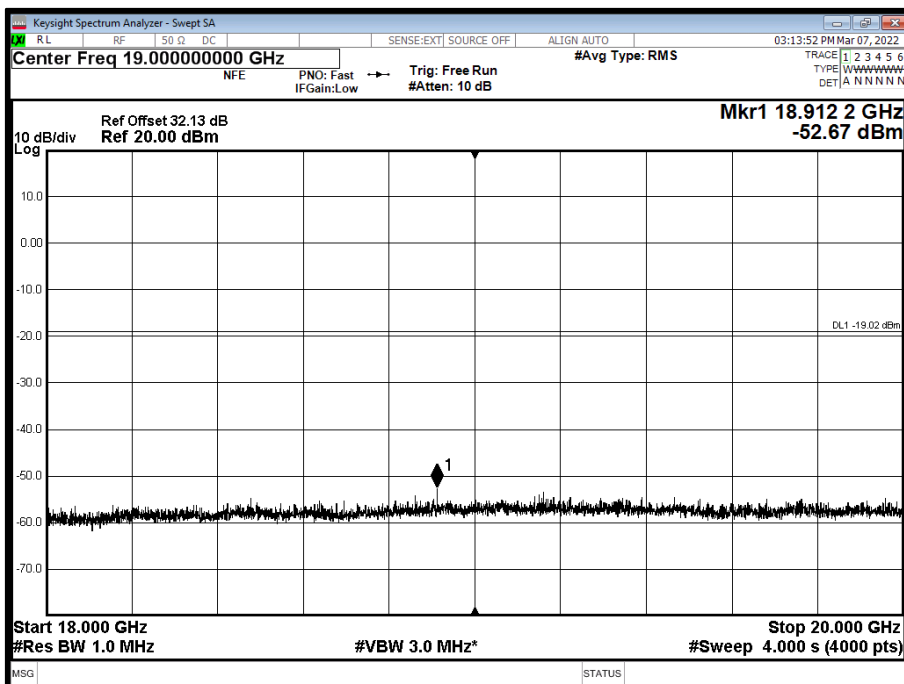



Antenna A - NR Modulation QPSK - NR Carrier Bandwidth 20.0 MHz 15 kHz SCS - Channel Position T - Band 1 - Range 0.009 to 3500 MHz

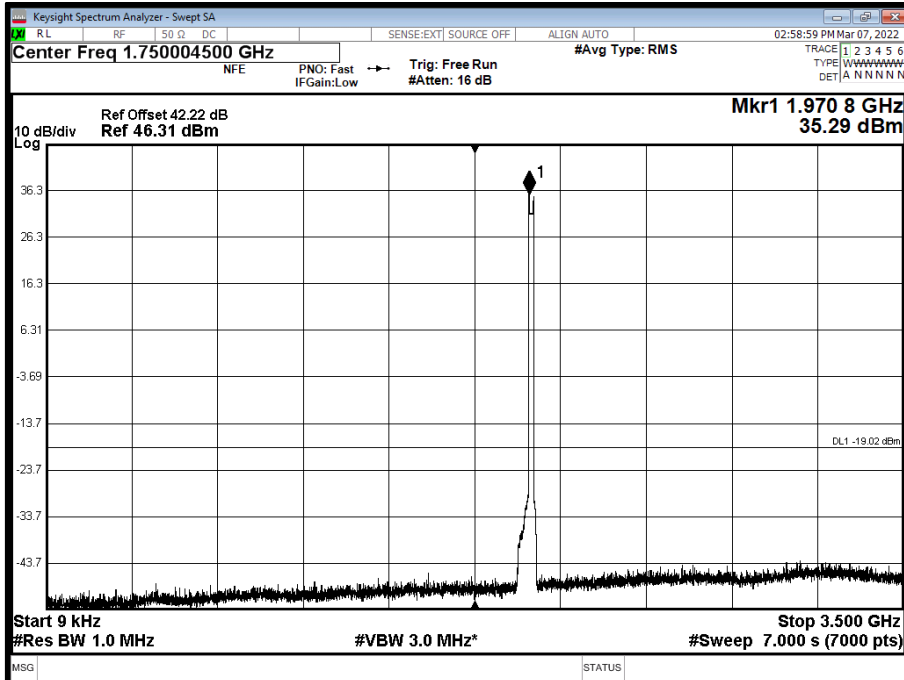

Antenna A - NR Modulation QPSK - NR Carrier Bandwidth 20.0 MHz 15 kHz SCS - Channel Position T - Band 2 - Range 3500 to 12000 MHz

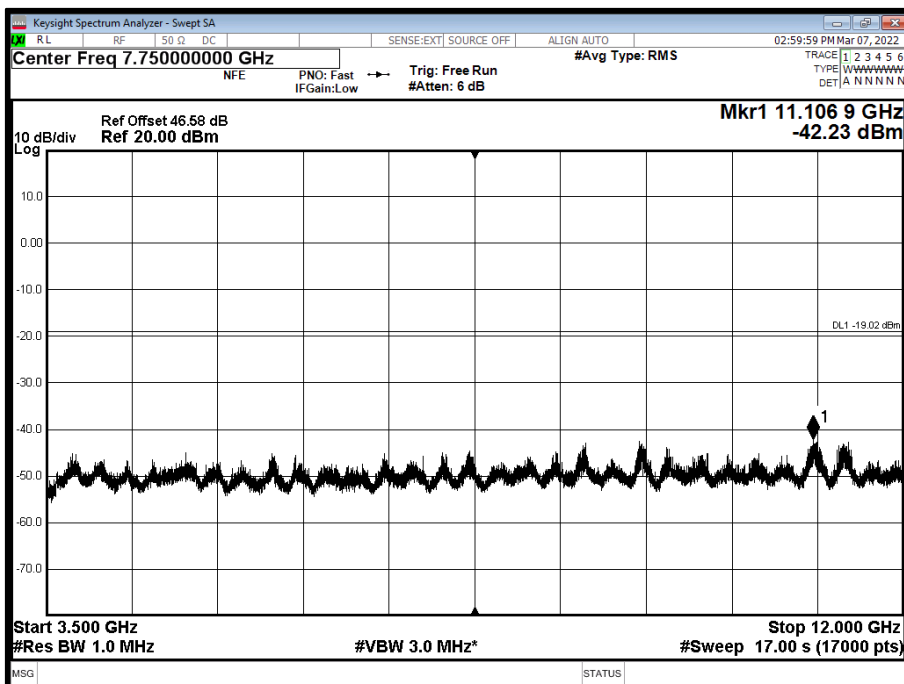



Antenna A - NR Modulation QPSK - NR Carrier Bandwidth 20.0 MHz 15 kHz SCS - Channel Position T - Band 3 - Range 12000 to 18000 MHz

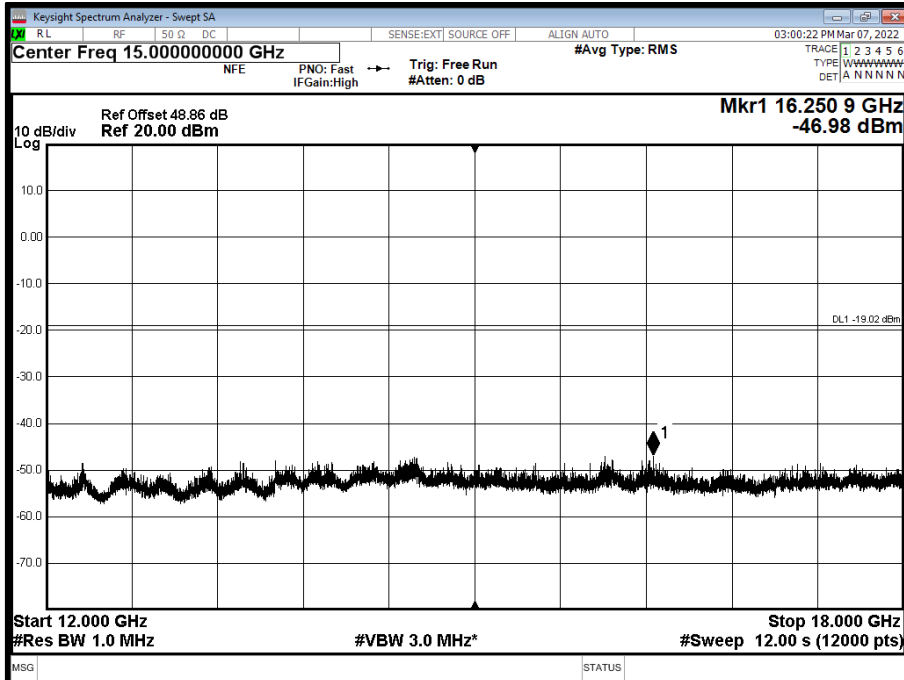

Antenna A - NR Modulation QPSK - NR Carrier Bandwidth 20.0 MHz 15 kHz SCS - Channel Position T - Band 4 - Range 18000 to 20000 MHz

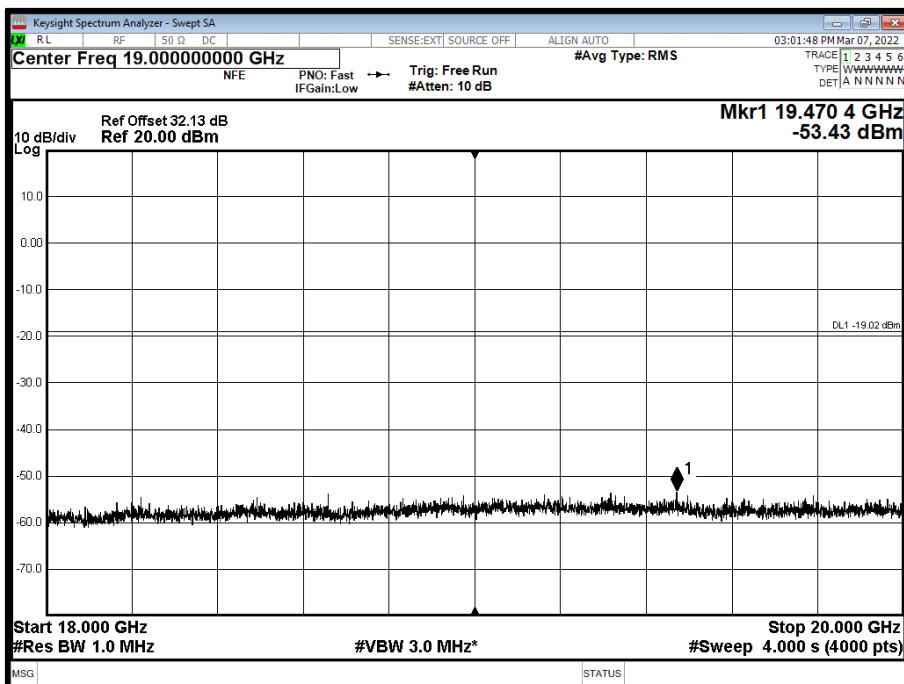

Limit	-13dBm
-------	--------



2.5 RADIATED EMISSIONS

2.5.1 Specification Reference

ISED RSS-GEN, Clause 6.13
Industry Canada RSS-133, Clause 6.5
FCC CFR 47 Part 2, Clause 2.1053

2.5.2 Date of Test and Modification State

30-March-2022 - Modification State 0

2.5.3 Test Equipment Used

The major items of test equipment used for the above tests are identified in Section 3.1.

2.5.4 Environmental Conditions

Ambient Temperature	21.4°C
Relative Humidity	36.6%

2.5.5 Test Method

The test was performed in accordance with ANSI C63.26 Clause 5. The EUT was configured as defined in ANSI C63.26, clause 5.5.2.3.2.

As a result of the conducted measurements that were performed on the EUT, it was established that 10 MHz was the bandwidth configuration which gave the highest output power and therefore deemed to be worst case operating mode. Testing was performed on the Top, Middle and Bottom channels for B25 and Top only for B2.

The EUT was set up on a support replicating typical installation conditions at a height of 0.8 m above the reference ground plane for measurements below 1GHz, (see setup photos) within a semi-anechoic chamber on a remotely controlled turntable. Above 1 GHz, the height was increased to 1.5 m above the reference ground plane.

Pre-scan and final measurements were made using a Field Strength method in accordance with ANSI C63.26 Clause 5.5.4. The readings were maximized by adjusting the antenna height, polarization and turntable azimuth, in accordance with the specification. Final results were then converted to eirp and are displayed in the plots below. The correction for field strength measurements to eirp at 3 m was 95.2 dB. An RBW of 1 MHz and VBW of 3 MHz was used for all measurements with a Peak detector and trace set to Max Hold. In all cases below where the limit line is exceeded – this is the intentional transmit frequency.

2.5.6 Test Results



Configuration 1

Maximum Output Power 44.77 dBm

Frequency (MHz)	Level (dBm)	Limit (dBm)	Margin (dB)	Detector	Angle (°)	Height (cm)	Polarisation
*							

Top - NR&NB-IoT - B25, 1990MHz, 30 MHz to 22.5 GHz

*No emissions found within 6 dB of the limit.

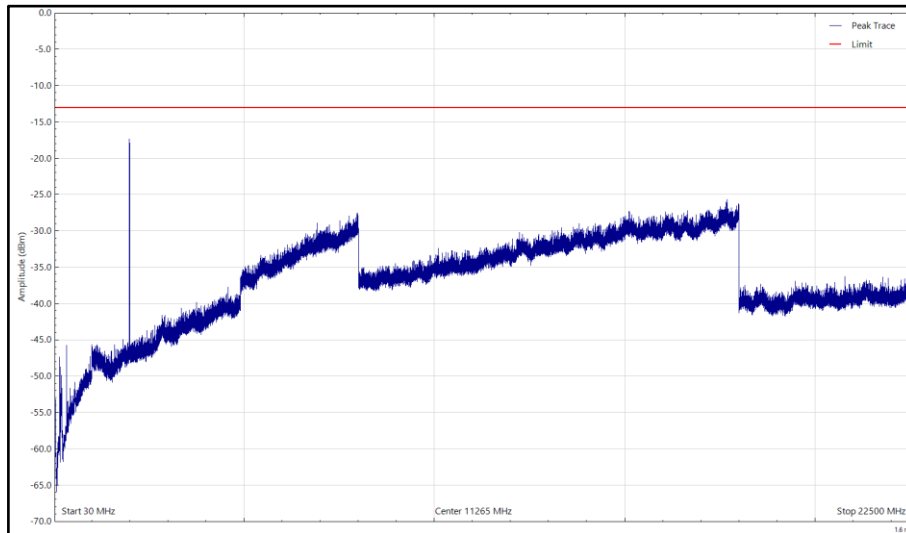

Top - NR&NB-IoT - B25, 1990MHz, 30 MHz to 22.5 GHz, Horizontal (Peak)

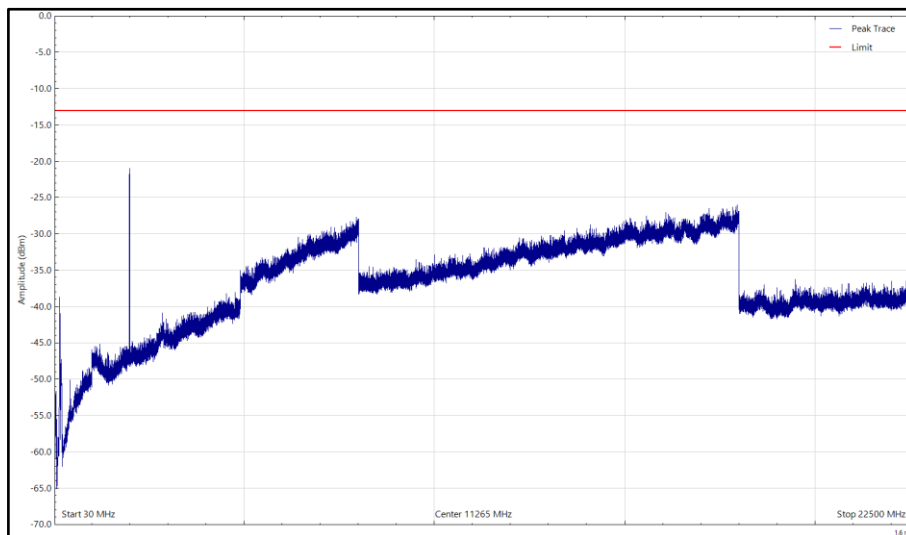

Top - NR&NB-IoT - B25, 1990MHz, 30 MHz to 22.5 GHz, Vertical (Peak)



Frequency (MHz)	Level (dBm)	Limit (dBm)	Margin (dB)	Detector	Angle (°)	Height (cm)	Polarisation
*							

Bot - NR&NB-IoT - B25, 1935MHz, 30 MHz to 22.5 GHz

*No emissions found within 6 dB of the limit.

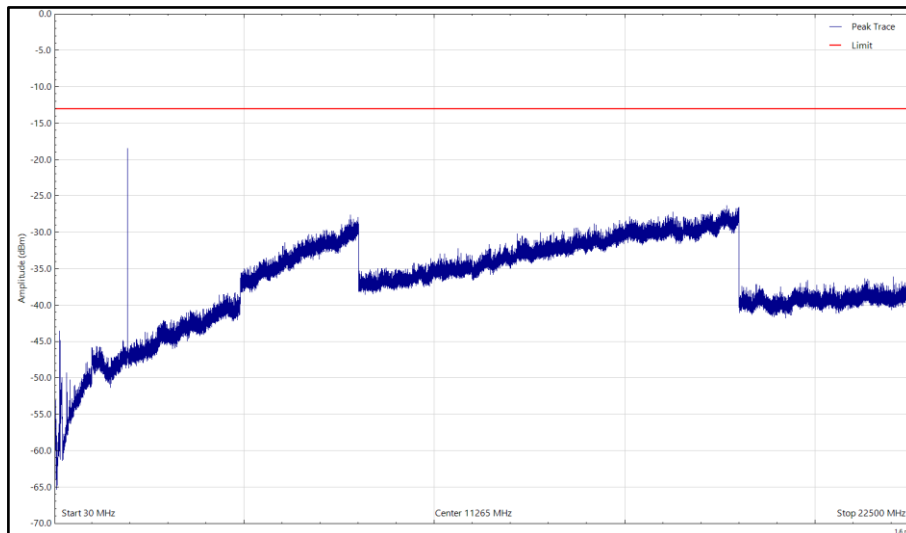

Bot - NR&NB-IoT - B25, 1935MHz, 30 MHz to 22.5 GHz, Horizontal (Peak)

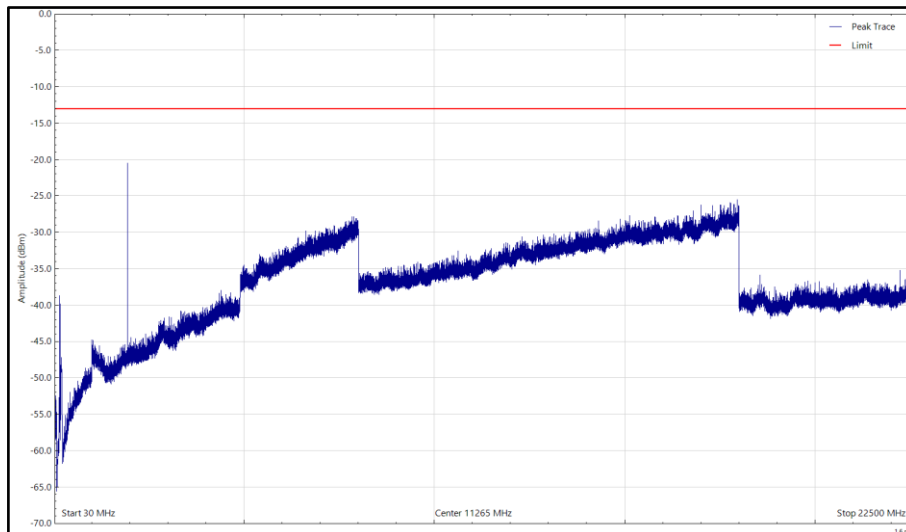

Bot - NR&NB-IoT - B25, 1935MHz, 30 MHz to 22.5 GHz, Vertical (Peak)



Frequency (MHz)	Level (dBm)	Limit (dBm)	Margin (dB)	Detector	Angle (°)	Height (cm)	Polarisation
*							

Mid - NR&NB-IoT - B25, 1962.5MHz, 30 MHz to 22.5 GHz

*No emissions found within 6 dB of the limit.

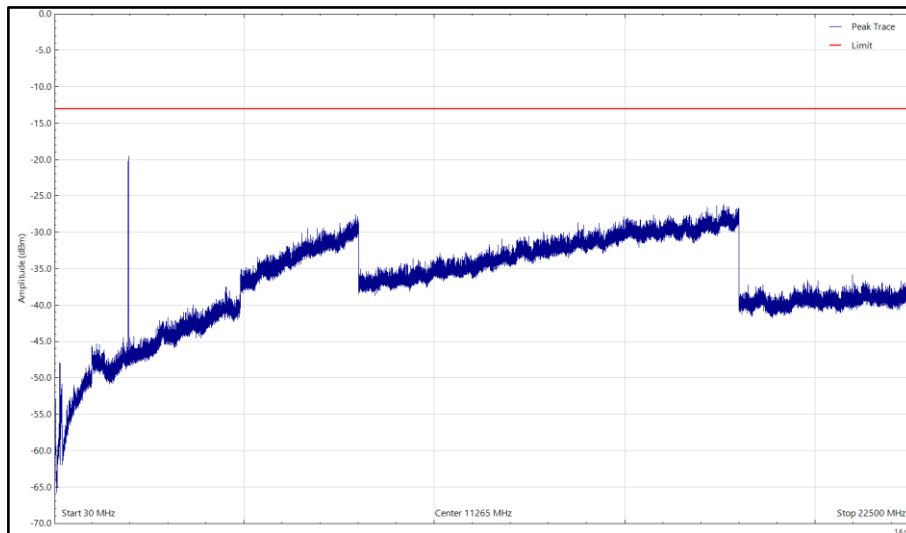

Mid - NR&NB-IoT - B25, 1962.5MHz, 30 MHz to 22.5 GHz, Horizontal (Peak)

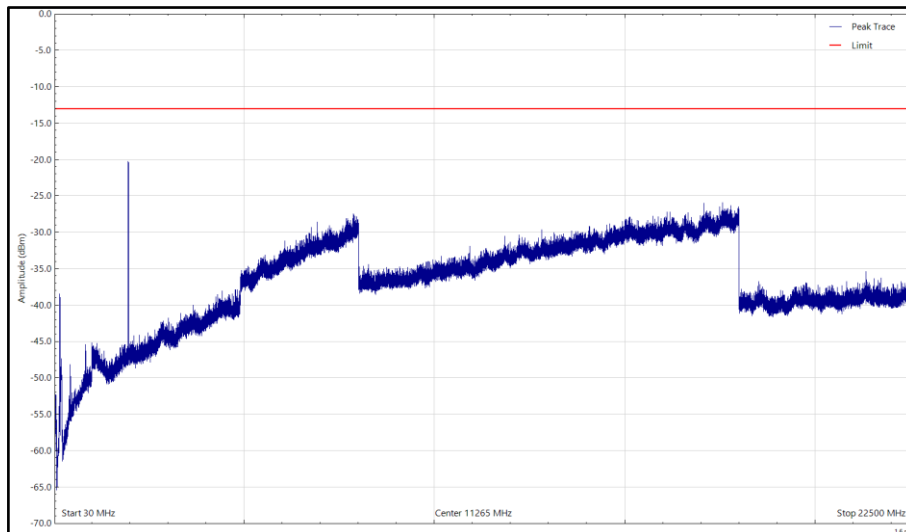

Mid - NR&NB-IoT - B25, 1962.5MHz, 30 MHz to 22.5 GHz, Vertical (Peak)



Configuration 2

Maximum Output Power 44.77 dBm

Frequency (MHz)	Level (dBm)	Limit (dBm)	Margin (dB)	Detector	Angle (°)	Height (cm)	Polarisation
*							

Top - NR&NB-IoT - B2, 1985MHz, 30 MHz to 22.5 GHz

*No emissions found within 6 dB of the limit.

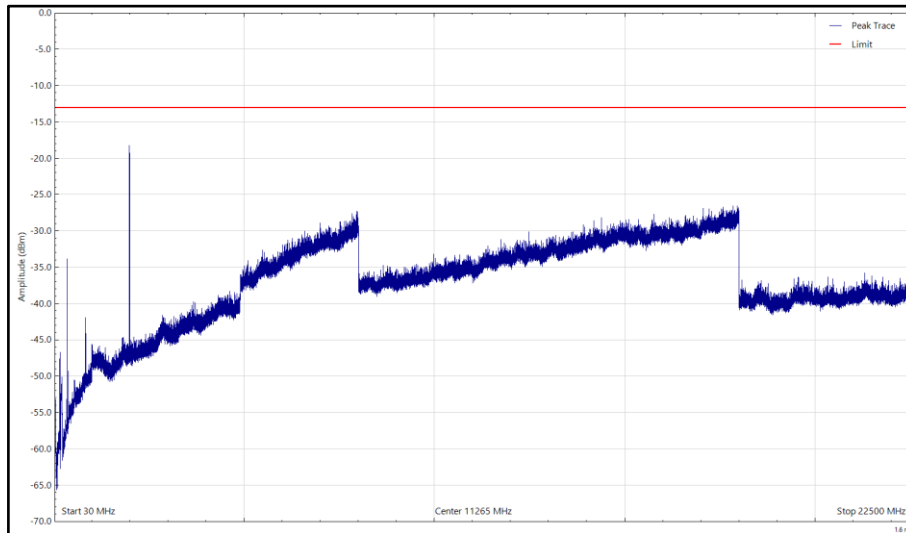

Top - NR&NB-IoT - B2, 1985MHz, 30 MHz to 22.5 GHz, Horizontal (Peak)

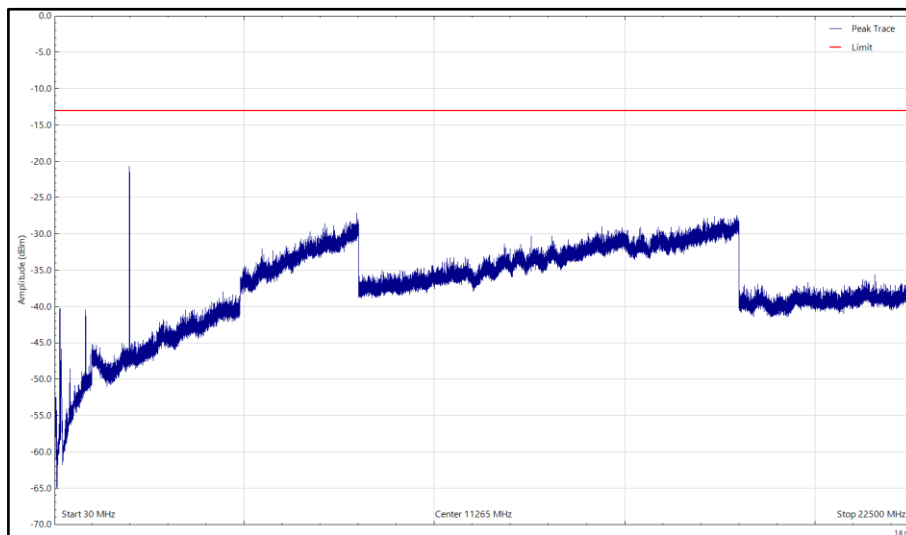

Top - NR&NB-IoT - B2, 1985MHz, 30 MHz to 22.5 GHz, Vertical (Peak)



No emissions were detected within 6dB of the limits however the highest emissions for each Band has been recorded below.

Channel/Band	Channel Frequency (MHz)	Polarisation	Angle (°)	Height (cm)	Frequency (MHz)	Level (dBm)
Bot - B25	1935MHz	Vertical	0	155	17944.491	-25.43
Mid - B25	1962.5MHz	Vertical	0	155	17573.429	-25.84
Top - B25	1990MHz	Horizontal	0	155	17682.447	-25.6
Top - B2	1985MHz	Horizontal	0	155	17948.991	-26.5



SECTION 3

TEST EQUIPMENT USED



3.1 TEST EQUIPMENT USED

List of absolute measuring and other principal items of test equipment.

Instrument	Manufacturer	Type No.	TE No.	Calibration Period (months)	Calibration Due
Hygrometer	PCE Instruments	PCE-THB-40	5475	12	06-Apr-2022
Frequency Standard	Spectracom	SecureSync 1200-0408-0601	4393	6	30-Jun-2022
Analyser	Keysight	N9030A	4654	12	24-Nov-2022
AC Power Supply	iTech	IT7324	5227	-	OP-MON
Multimeter	Fluke	79	0611	12	21-Dec-2022
Attenuator	Weinschel	48-40-43-LIM	5134	12	05-Jan-2023
Network Analyser	Keysight	N5235B	5361	12	29-Jun-2022
Occupied Bandwidth					
Hygrometer	PCE Instruments	PCE-THB-40	5475	12	06-Apr-2022
Frequency Standard	Spectracom	SecureSync 1200-0408-0601	4393	6	30-Jun-2022
Analyser	Keysight	N9030A	4654	12	24-Nov-2022
AC Power Supply	iTech	IT7324	5227	-	OP-MON
Multimeter	Fluke	79	0611	12	21-Dec-2022
Attenuator	Weinschel	48-40-43-LIM	5134	12	05-Jan-2023
Network Analyser	Keysight	N5235B	5361	12	29-Jun-2022
Band Edge					
Hygrometer	PCE Instruments	PCE-THB-40	5475	12	06-Apr-2022
Frequency Standard	Spectracom	SecureSync 1200-0408-0601	4393	6	30-Jun-2022
Analyser	Keysight	N9030A	4654	12	24-Nov-2022
AC Power Supply	iTech	IT7324	5227	-	OP-MON
Multimeter	Fluke	79	0611	12	21-Dec-2022
Attenuator	Weinschel	48-40-43-LIM	5134	12	05-Jan-2023
Network Analyser	Keysight	N5235B	5361	12	29-Jun-2022
Transmitter Spurious Emissions					
Hygrometer	PCE Instruments	PCE-THB-40	5475	12	06-Apr-2022
Frequency Standard	Spectracom	SecureSync 1200-0408-0601	4393	6	30-Jun-2022
Analyser	Keysight	N9030A	4654	12	24-Nov-2022
AC Power Supply	iTech	IT7324	5227	-	OP-MON
Multimeter	Fluke	79	0611	12	21-Dec-2022
Attenuator	Weinschel	48-40-43-LIM	5134	12	05-Jan-2023
Network Analyser	Keysight	N5235B	5361	12	29-Jun-2022
HPF	Advance Power Components	11SH10-3000/X18000-O/O	4411	12	02-Jul-2022
Waveguide filter	Quasar	QWS20SB-UBR-UBR-50	5789	12	04-May-2022
WG20 Coaxial Adapter	Quasar	QWC20SB-UBR-K-F	5785	-	OP-MON



Instrument	Manufacturer	Type No.	TE No.	Calibration Period (months)	Calibration Due
WG20 Coaxial Adapter	Quasar	QWC20SB-UBR-K-F	5786	-	OP-MON
Cable attenuator	Aralab	CSF6767C-C2S6500	5175	-	OP-MON
Radiated Emissions					
Antenna (DRG, 18 GHz to 40 GHz)	Link Microtek Ltd	AM180HA-K-TU2	230	24	27-Jul-2022
Antenna with attenuator (Bilog, 30 MHz to 3 GHz)	Schaffner	CBL6143	287	24	14-Oct-2022
Comb Generator	Schaffner	RSG1000	3034	-	TU
Emissions Software	TUV SUD	EmX V2.1.11	5125	-	N/A - Software
		V.2.1.11			
Cable (N-Type to N-Type, 8 m)	Teledyne	PR90-088-8MTR	5450	6	01-Apr-2022
Antenna (DRG, 7.5 GHz to 18 GHz)	Schwarzbeck	HWRD750	5610	12	15-Oct-2022
Turntable & Mast Controller	Maturo Gmbh	NCD/498/2799.01	5612	-	TU
Tilt Antenna Mast	Maturo Gmbh	TAM 4.0-P	5613	-	TU
Turntable	Maturo Gmbh	Turntable 1.5 SI-2t	5614	-	TU
Screened Room (12)	MVG	EMC-3	5621	36	11-Aug-2023
EMI Test Receiver	Rohde & Schwarz	ESW44	5912	12	17-Feb-2023
Thermo-Hygro-Barometer	PCE Instruments	PCE-THB-40	5481	12	31-Mar-2022
Antenna (DRG, 1 GHz to 10 GHz)	Schwarzbeck	BBHA 9120 B	5611	12	15-Oct-2022
Cable (SMA to SMA, 2 m)	Rhophase	3PS-1801A-2000-3PS	4113	12	27-Jan-2023
Multimeter	Fluke	177.00	3832.00	12.00	08-Jul-2022
Power Supply	Farnell	H 60/50	1095.00	TU	O/P Mon

N/A – Not Applicable

O/P Mon – Output Monitored with Calibrated Equipment

TU – Traceability Unscheduled



3.2 MEASUREMENT UNCERTAINTY

For a 95% confidence level, the measurement uncertainties for defined systems are:-

Test Discipline	Frequency / Parameter	MU
Conducted Maximum Peak Output Power	9 kHz to 40 GHz Amplitude	± 1.0 dB
Conducted Emissions	9 kHz to 40 GHz Amplitude	± 3.5 dB
Occupied Bandwidth	10 MHz Bandwidth	± 16.7 kHz
	15 MHz Bandwidth	
	20 MHz Bandwidth	
Band Edge	< 3.6 GHz Amplitude	± 0.6 dB
Radiated Spurious Emissions	30 MHz to 1 GHz	± 5.2 dB
	1 GHz to 40 GHz	± 6.3 dB

Measurement Uncertainty Decision Rule

Determination of conformity with the specification limits is based on the decision rule according to IEC Guide 115:2007, Clause 4.4.3 and 4.5.1. (Procedure 2). The measurement results are directly compared with the test limit to determine conformance with the requirements of the standard.

Risk: The uncertainty of measurement about the measured result is negligible with regard to the final pass/fail decision. The measurement result can be directly compared with the test limit to determine conformance with the requirement (compare IEC Guide 115). The level of risk to falsely accept and falsely reject items is further described in ILAC-G8



3.3 MEASUREMENT SOFTWARE USED

List of measurement software versions used for testing.

Instrument	Manufacturer	Type No.	TE No.	Software Version
Network Analyser	Keysight	N5235B	5361	A.22.08
HP-VEE Software	TUV SUD	HP_VEE	N/A	V3.29
Emissions Software	TUV SUD	EmX	5125	V.2.1.11



SECTION 4

ACCREDITATION, DISCLAIMERS AND COPYRIGHT



4.1 ACCREDITATION, DISCLAIMERS AND COPYRIGHT



Accred. no. 10363
Testing
ISO/IEC 17025

This report relates only to the actual item/items tested.

Our Swedac Accreditation does not cover opinions and interpretations and any expressed are outside the scope of our Swedac Accreditation.

Results of tests not covered by our Swedac Accreditation Schedule are marked NSA (Not Swedac Accredited).

© 2022 TÜV SÜD
TÜV SÜD Sverige

Postal Address: Djäknegatan 31, 211 35, Malmö, Sweden



ANNEX A

MODULE LIST



Configurations A & B			
Product	Product No	R-State	Serial No
Radio 4455	KRC 161 823/1	R1C	D829275242
Software Version:	CXP9013268/15	Revision:	R89JD