



Add value.
Inspire trust.



Report On

FCC Testing of the
Ericsson Radio 8843 B2 B66A, KRC 161 707/2, NR (2100 MHz) Base
Station in accordance with FCC CFR 47 Part 2 and FCC CFR 47 Part
27

COMMERCIAL-IN-CONFIDENCE

FCC: TA8AKRC161707-2

PREPARED BY

A handwritten signature in black ink, appearing to read 'Maggie Whiting'.

Maggie Whiting
Key Account Manager

APPROVED BY

A handwritten signature in black ink, appearing to read 'Steve Scarfe'.

Steve Scarfe
Authorised Signatory

DATED

10 February 2022

Document 75953954 Report 02 Issue 2

February 2022



CONTENTS

Section	Page No
1	REPORT INFORMATION 2
1.1	Report Details 3
1.2	Brief Summary of Results 4
1.3	Test Rationale..... 5
1.4	Configuration Description 6
1.5	Declaration of Build Status 7
1.6	Product Information 9
1.7	Test Setup 10
1.8	Test Conditions..... 12
1.9	Deviation From The Standard 12
1.10	Modification Record 12
1.11	Additional Information 12
2	TEST DETAILS 13
2.1	Maximum Peak Output Power and Peak to Average Ratio - Conducted..... 14
2.2	Occupied Bandwidth..... 21
2.3	Band Edge 27
2.4	Transmitter Spurious Emissions 31
2.5	Radiated Emissions 55
3	TEST EQUIPMENT USED 59
3.1	Test Equipment Used 60
3.2	Measurement Uncertainty 62
3.3	Measurement Software Used 63
4	ACCREDITATION, DISCLAIMERS AND COPYRIGHT..... 64
4.1	Accreditation, Disclaimers and Copyright..... 65
ANNEX A	Module Lists.....A.2



SECTION 1

REPORT INFORMATION



1.1 REPORT DETAILS

Manufacturer	Ericsson
Address	Torshamnsgatan 23 Kista SE-16480 Stockholm Sweden
Product Name & Product Number	Radio 8843 B2 B66A - KRC 161 707/2
Serial Number(s)	D16X961448
Software Version	CXP9013268/15 Revision R89AJ
Hardware Version	R1D
Test Specification/Issue/Date	FCC CFR 47 Part 2: 2020 FCC CFR 47 Part 27: 2020
Test Plan	Q1 2022 FCC_IC test plan for MR7602-1 NR-IoT V 1.1
Start of Test	03-December-2021
Finish of Test	26-January-2022
Name of Engineer(s)	Neil Rousell, Graeme Lawler
Related Document(s)	KDB 971168 D01 v02r02 KDB 662911 D01 v02r01 ANSI C63.26-2015

ENGINEERING STATEMENT

The measurements shown in this report were made in accordance with the procedures described on test pages. All reported testing was carried out on a sample equipment to demonstrate compliance with and FCC CFR 47 Part 2: 2020 and FCC CFR 47 Part 27: 2020. The sample tested was found to comply with the requirements defined in the applied rules.

Test Engineer(s);

Neil Rousell, Graeme Lawler

This report has been up issued to Issue 2 and should be read in place of Issue 1. This Report has been up issued to correct a typo in the Declaration of Build Status.



1.2 BRIEF SUMMARY OF RESULTS

A brief summary of results for each configuration, in accordance with FCC CFR 47 Part 2 and FCC CFR 47 Part 27 is shown below.

Section	Specification Clause		Test Description	Result
	FCC CFR 47 Part 2	FCC CFR 47 Part 27		
2.1	2.1046	27.50	Maximum Peak Output Power and Peak to Average Ratio - Conducted	Pass
2.2	2.1049	27.53	Occupied Bandwidth	Pass
2.3	2.1051	27.53	Band Edge	Pass
2.4	2.1051	27.53	Transmitter Spurious Emissions	Pass
2.5	2.1053	27.53	Radiated Emissions	Pass

Testing in this Report covers only B66A (2100 MHz)

For additional configurations and test cases not contained within this test report, refer to the following reports:

Document 75953954 Report 01 - Radio 8843 B2 B66A, KRC 161 707/2, NR (1900 MHz, B2)



1.3 TEST RATIONALE

The tests that have been selected are detailed in the customer Test Plan as defined in section 1.1 of this report. The Test Plan is based on the TÜV SÜD FCC Test Plan Rationale, available on request.



1.4 CONFIGURATION DESCRIPTION

RATs	Carriers	Pout (W)	NR Main carrier				Comment
			Position	BW	Freq	NR-ARFCN	
NR in NR/ESS Setup (NB IoT IB) QPSK	1	80	B	10	2115	423000	with 15 kHz SCS, QPSK
			M	10	2145	429000	with 15 kHz SCS, QPSK
			T	10	2175	435000	with 15 kHz SCS, QPSK
			B	15	2117.5	423500	with 15 kHz SCS, QPSK
			M	15	2145	429000	with 15 kHz SCS, QPSK
			T	15	2172.5	435100	with 15 kHz SCS, QPSK
			B	20	2120	424000	with 15 kHz SCS, QPSK
			M	20	2145	429000	with 15 kHz SCS, QPSK
			T	20	2170	434000	with 15 kHz SCS, QPSK
			T	10	2175	435000	with 15 kHz SCS, QPSK



1.5 DECLARATION OF BUILD STATUS

Equipment Description		
Technical Description: (Please provide a brief description of the intended use of the equipment including the technologies the product supports)		Multi-standard remote radio unit Radio 8843 B2 B66A 4Tx and 4Rx
Manufacturer:		Ericsson AB
Model:		Radio 8843 B2 B66A
Part Number:		KRC161707/2
Hardware Version:		R1D
Software Version:		CXP9013268/15 Revision R89AJ
FCC ID of the product under test		TA8AKRC161707-2
IC ID of the product under test		.-
Intentional Radiators		
RAT	LTE	NR ,SCS 15kHz
Frequency Range (MHz to MHz)	B2 , DL: 1930 - 1990 MHz, UL :1850 - 1910MHz B66A, DL:2110 - 2180 MHz, UL: 1710 - 1780MHz	B2, DL: 1930 - 1990 MHz, UL:1850 - 1910MHz B66A, DL:2110 - 2180 MHz, UL: 1710 - 1780MHz
Radio Configuration:	4 RX / 4 TX for normal power mode 2TX /2 RX for high power mode	4 RX / 4 TX for normal power mode 2TX /2 RX for high power mode
Output power per port	B2: 4 x 40W or 2 x 60W B66A: 4 x 60W or 2 x 80W	B2: 4 x 40W or 2 x 60W B66A: 4 x 60W or 2 x 80W
Conducted Declared Output Power (dBm)	B2 :46.0 /47,8	B2 :46.0 /47,8
Max output power per port (B2)	LTE 5MHz :40W Max output power per port LTE 10,15,20MHz:60W Max output power per port	NR 5MHz :40W Max output power per port NR 10,15,20MHz:60W Max output power per port
Conducted Declared Output Power (dBm)	B66A: 47,8 / 49,0	B66A: 47,8 / 49,0
Max output power per port (B66A)	LTE 5MHz :60W Max output power per port LTE 10,15,20MHz:80W Max output power per port	NR 5MHz :60W Max output power per port NR 10,15,20MHz:80W Max output power per port
Total RF bandwidth (IBW)	B2 :60MHz B66A: 70MHz	B2 :60MHz B66A: 70MHz
Supported Bandwidth(s) (MHz)	5, 10, 15, 20MHz	5, 10, 15, 20MHz
Modulation Scheme(s)	QPSK, 16QAM, 64QAM, 256QAM	QPSK, 16QAM, 64QAM, 256QAM
Antenna Gain (dBi)	17.8±0.5 (B2), 17.8±0.5 (B66)	17.8±0.5 (B2), 17.8±0.5 (B66)
Antenna Impedance(Ω)	50	50
ITU Emission Designator (From previously Declaration 2020-07-08)	B2 without NB IoT B2: 5MHz, BW: 4M51W7D B2 with NB IoT 10 MHz, BW: 9M4W7D 15 MHz, BW: 14M1W7D 20 MHz, BW: 18M5W7D 20+20 MHz, BW:38M5W7D (20+20 MHz, Carrier aggregation)	B2 without NB IoT 5 MHz, BW: 4M47W7D 10 MHz, BW: 9M29W7D 15 MHz, BW: 14M1W7D 20 MHz, BW: 17M3W7D 20+20 MHz, BW: 38M8W7D (20+20 MHz, Carrier aggregation)
ITU Emission Designator (From previously Declaration 2020-07-08)	B66A without NB IoT B66A: 5MHz, BW: 4M51W7D B66A with NB IoT 10 MHz, BW: 9M5W7D 15 MHz, BW: 14M1W7D 20 MHz, BW: 18M5W7D 20+20 MHz, BW:38M4W7D (20+20 MHz, Carrier aggregation)	B66A without NB IoT 5 MHz, BW: 4M47W7D 10 MHz, BW: 9M29W7D 15 MHz, BW: 14M1W7D 20 MHz, BW: 17M3W7D 20+20 MHz, BW: 38M8W7D (20+20 MHz, Carrier aggregation)



ITU Emission Designator(NR + NB IoT IB) Test Report No. 75953954 Report 01 Issue	.-	B2 with NB IoT IB: 10 MHz, BW: 9M45W7D 15 MHz, BW: 14M4W7D 20 MHz, BW: 19M2W7D	
ITU Emission Designator(NR + NB IoT IB) Test Report No. 75953954 Report 02 Issue	.-	B66A with NB IoT IB: 10 MHz, BW: 9M45W7D 15 MHz, BW: 14M4W7D 20 MHz, BW: 19M2W7D	
Duplex mode:	FDD	FDD	
Supported transmission modes:	4X4 MIMO	4X4 MIMO	
Maximum number of carriers	3	3	
Unintentional Radiators			
Highest frequency generated or used in the device or on which the device operates or tunes			Up to 10,1 Gbit/s
Lowest frequency generated or used in the device or on which the device operates or tunes if <30MHz			.-
Class A Digital Device (Use in commercial, industrial or business environment)			.-
Class B Digital Device (Use in residential environment)			Class B
DC Power Supply (Delete if Not Applicable)			
Nominal voltage:	-48V		
Extreme upper voltage:	-40V		
Extreme lower voltage:	-58.5V		
Max current:	32A		
Temperature			
Minimum temperature:	-40°C		
Maximum temperature:	55°C		
Ancillaries			
Manufacturer:	X	Part Number:	X
Model:	X	Model:	X
I hereby declare that I am entitled to sign on behalf of the manufacturer and that the information supplied is correct and complete.			
Name:	Afrah Ali sadiq		
Position held:	Regulatory Approval Engineer		
Email address:	Afrah.ali.sadiq@ericsson.com		
Telephone number:	.+46724650796		
Date:	03/02/2022		

No responsibility will be accepted by TÜV SÜD UK Limited as to the accuracy of the information declared in this document by the manufacturer.

1.6 PRODUCT INFORMATION

1.6.1 Technical Description

The Equipment Under Test (EUT) Radio 8843 B2 B66A - KRC 161 707/2 is an Ericsson AB Radio Unit working in the public mobile service Band 66A band which provides communication connections to Band 66A network. The EUT operates from a -48V DC supply.

The Equipment Under Test (EUT) is shown in the photograph below. A full technical description can be found in the Manufacturer's documentation.



Equipment Under Test



1.7 TEST SETUP

Conducted Test Set Up

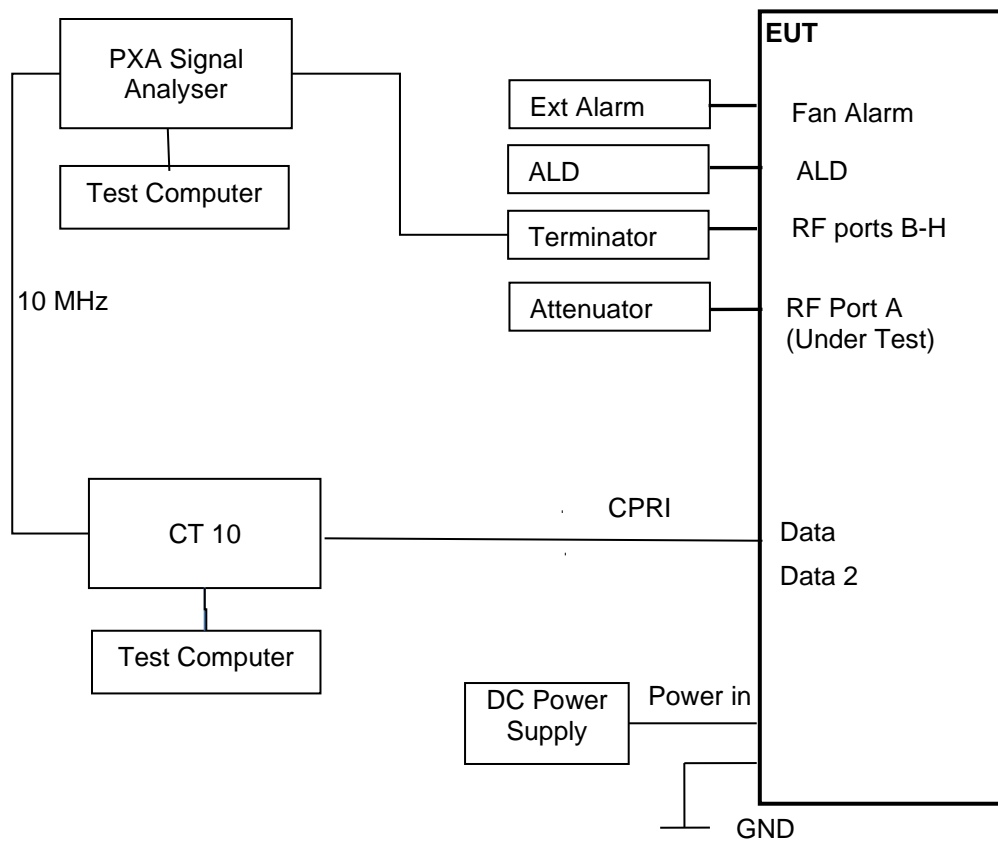

Radiated Test Set Up – Dashed line indicates equipment inside the Chamber for Radiated testing.

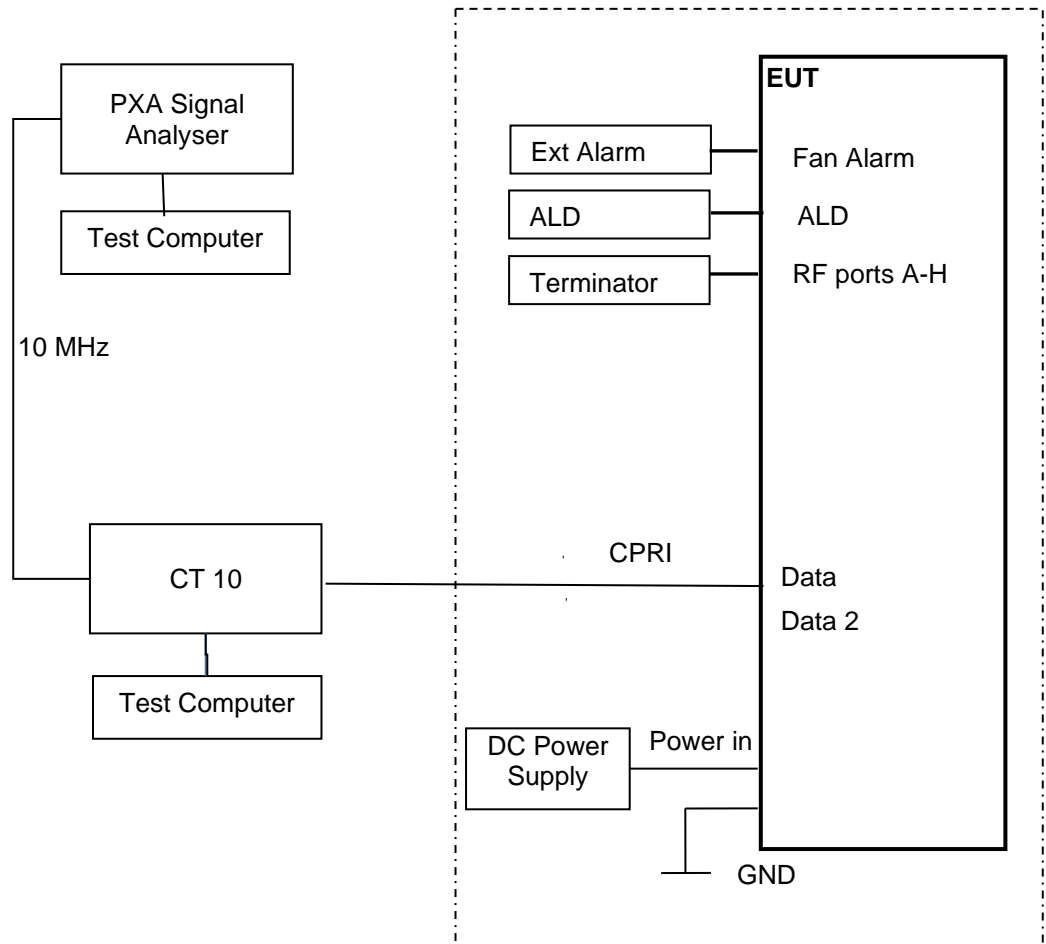



1.8 TEST CONDITIONS

For all tests the EUT was set up in accordance with the relevant test standard and to represent typical operating conditions. Tests were applied with the EUT situated as described in the Test Method for each Test.

The EUT was powered from a -48V DC supply.

FCC Measurement Facility Registration Number
90987 Octagon House, Fareham Test Laboratory
Postal Address: Octagon House, Concorde Way, Fareham, Hampshire, UK, PO15 5RL

Under our UKAS Accreditation, TÜV SÜD conducted the following tests Octagon House, Fareham Laboratory.

Test Name	Name of Engineer(s)
Maximum Peak Output Power and Peak to Average Ratio - Conducted	Neil Rousell
Occupied Bandwidth	Neil Rousell
Band Edge	Neil Rousell
Transmitter Spurious Emissions	Neil Rousell
Radiated Emissions	Paul Dickinson/Graeme Lawler

1.9 DEVIATION FROM THE STANDARD

No deviations from the applicable test standards or test plan were made during testing.

1.10 MODIFICATION RECORD

No modifications were made to the EUT during testing.

1.11 ADDITIONAL INFORMATION

Ericsson will limit this product through the software from operating across the whole of Band 66, it will be limited to Band 66A.

This EUT uses the same port for Tx and Rx and therefore RX Spurious Emissions has not been performed. Rx Spurious Emissions have been covered by testing to FCC Part 15B, which are covered by a separate test report.

Frequency Stability was verified at the time of the original certification and is covered by a separate report.



SECTION 2

TEST DETAILS



2.1 MAXIMUM PEAK OUTPUT POWER AND PEAK TO AVERAGE RATIO - CONDUCTED

2.1.1 Specification Reference

FCC CFR 47 Part 27, Clause 27.50
 FCC CFR 47 Part 2, Clause 2.1046

2.1.2 Date of Test and Modification State

03-December-2021 - Modification State 0

2.1.3 Test Equipment Used

The major items of test equipment used for the above tests are identified in Section 3.1.

2.1.4 Environmental Conditions

Ambient Temperature 22.6°C
 Relative Humidity 32.3%

2.1.5 Test Method

All measurements were made in accordance with FCC KDB 971168 D01, clause 5.2.1 and summed in accordance with FCC KDB 662911 D01.

2.1.6 Test Results

Configuration 1

Maximum Output Power 49.00 dBm

Antenna	NR Modulation	NR Carrier Bandwidth	Peak to Average Ratio (PAR) / Output Power / PSD				
			Channel Position B				
			PAR (dB)	Average Power/PSD		Total Power Port A + B + C + D	
dBm	dBm/MHz	dBm		dBm/MHz			
A	QPSK	10.0 MHz 15 kHz SCS	7.12	48.54	39.62	54.56	45.64
A	QPSK	15.0 MHz 15 kHz SCS	7.22	48.42	39.18	54.44	45.20
A	QPSK	20.0 MHz 15 kHz SCS	7.20	48.49	39.21	54.51	45.23

Remarks

Calculations: Total power = measured output power (port A) + 10log (NANT) where NANT = 4



Antenna A - NR Modulation QPSK - NR Carrier Bandwidth 10.0 MHz 15 kHz SCS - Channel Position B

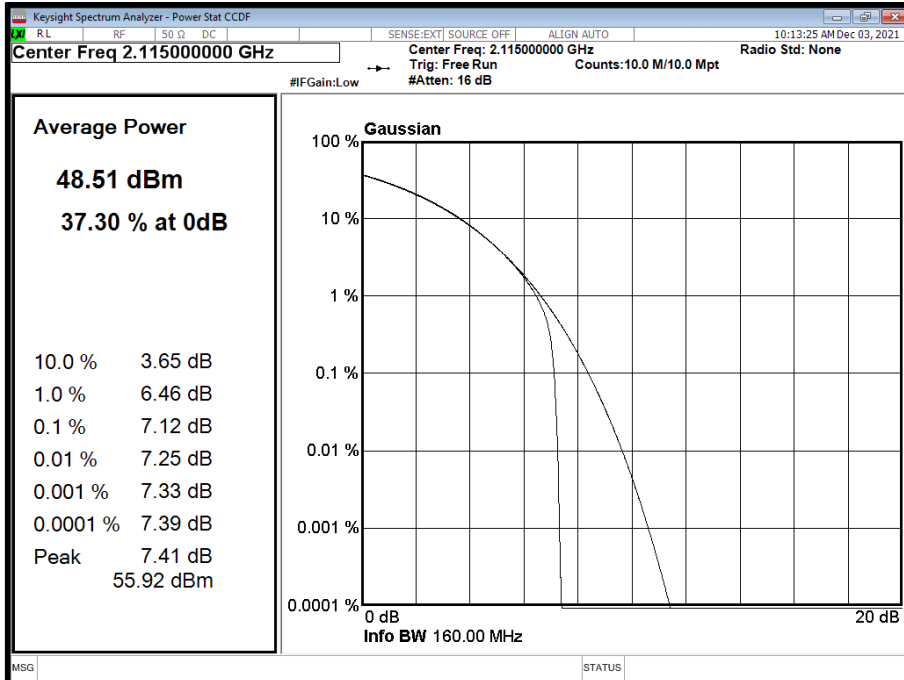

Antenna A - NR Modulation QPSK - NR Carrier Bandwidth 15.0 MHz 15 kHz SCS - Channel Position B

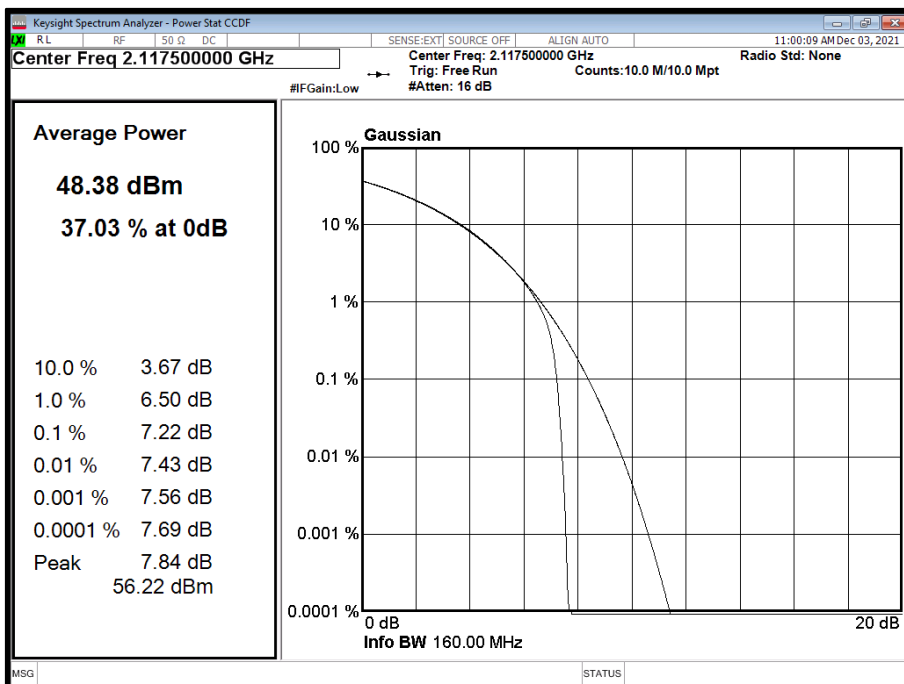



Antenna A - NR Modulation QPSK - NR Carrier Bandwidth 20.0 MHz 15 kHz SCS - Channel Position B

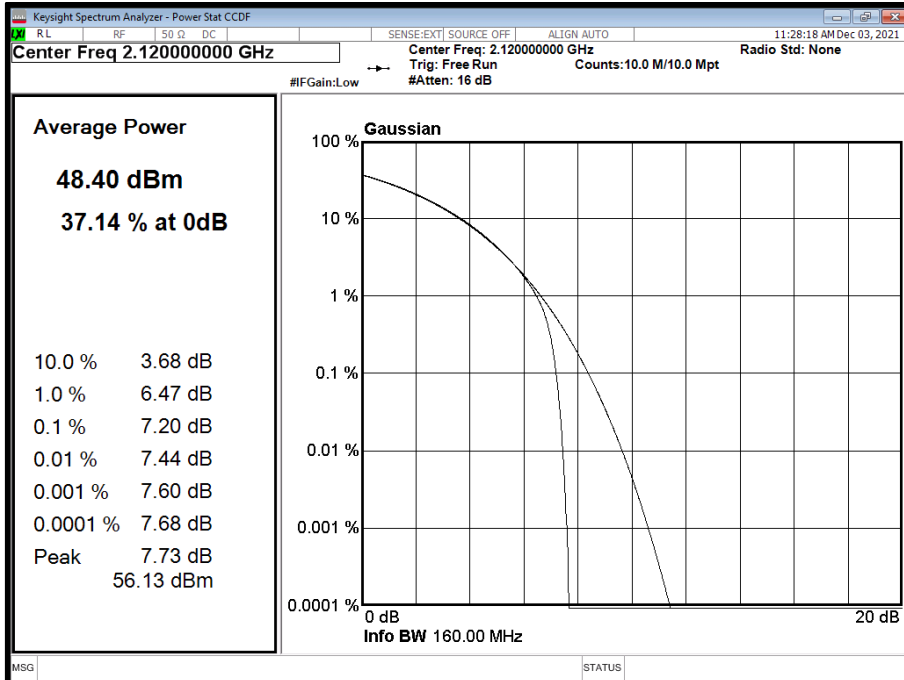

Configuration 1

Maximum Output Power 49.00 dBm

Antenna	NR Modulation	NR Carrier Bandwidth	Peak to Average Ratio (PAR) / Output Power / PSD				
			Channel Position M				
			PAR (dB)	Average Power/PSD		Total Power Port A + B + C + D	
	dBm	dBm/MHz	dBm	dBm/MHz			
A	QPSK	10.0 MHz 15 kHz SCS	7.10	48.88	39.93	54.90	45.95
A	QPSK	15.0 MHz 15 kHz SCS	7.16	48.81	39.52	54.83	45.54
A	QPSK	20.0 MHz 15 kHz SCS	7.14	48.80	39.43	54.82	45.45

Remarks

Calculations: Total power = measured output power (port A) + 10log (NANT) where NANT = 4



Antenna A - NR Modulation QPSK - NR Carrier Bandwidth 10.0 MHz 15 kHz SCS - Channel Position M

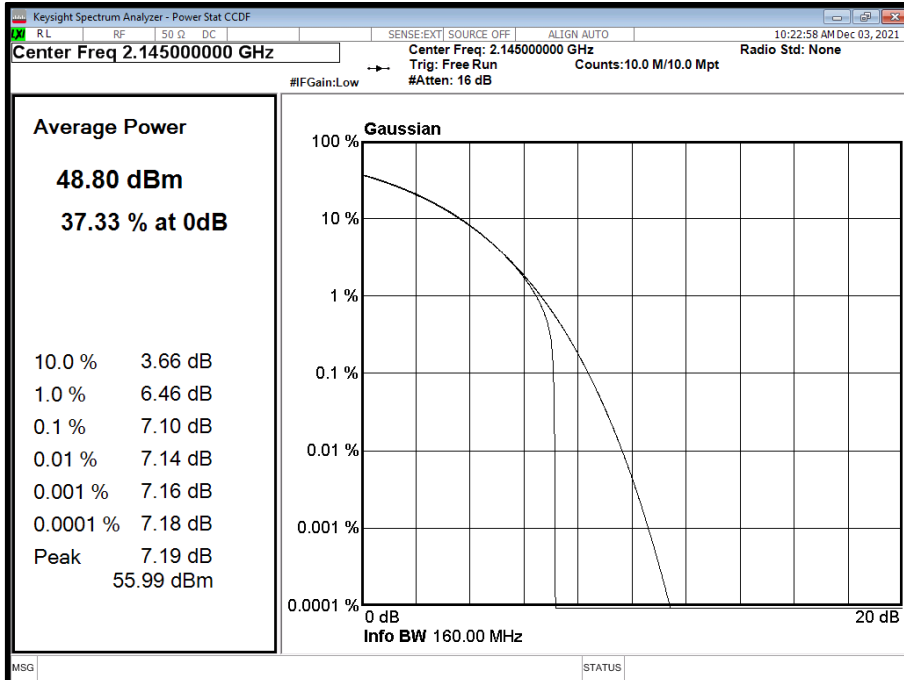

Antenna A - NR Modulation QPSK - NR Carrier Bandwidth 15.0 MHz 15 kHz SCS - Channel Position M

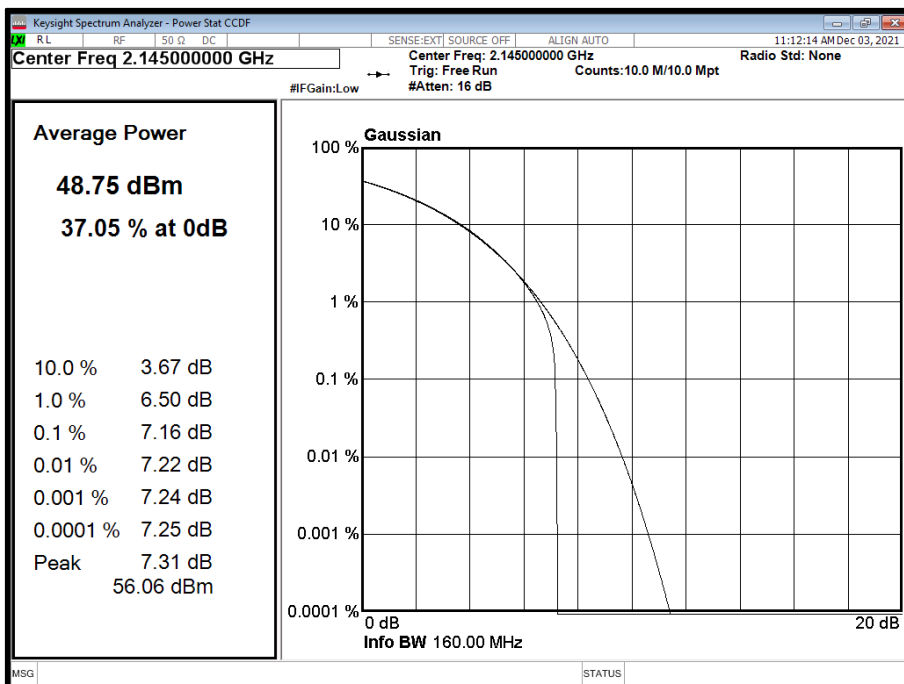



Antenna A - NR Modulation QPSK - NR Carrier Bandwidth 20.0 MHz 15 kHz SCS - Channel Position M

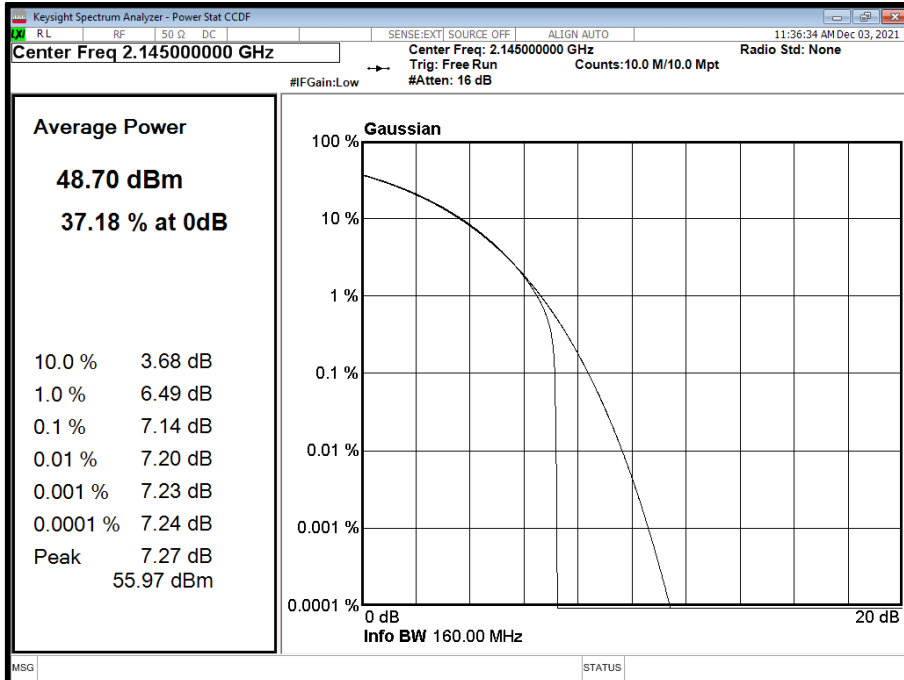

Configuration 1

Maximum Output Power 49.00 dBm

Antenna	NR Modulation	NR Carrier Bandwidth	Peak to Average Ratio (PAR) / Output Power / PSD				
			Channel Position T				
			PAR (dB)	Average Power/PSD		Total Power Port A + B + C + D	
			dBm	dBm/MHz	dBm	dBm/MHz	
A	QPSK	10.0 MHz 15 kHz SCS	7.13	48.40	39.66	54.42	45.68
A	QPSK	15.0 MHz 15 kHz SCS	7.24	48.29	39.06	54.31	45.08
A	QPSK	20.0 MHz 15 kHz SCS	7.26	48.50	39.07	54.52	45.09

Remarks

Calculations: Total power = measured output power (port A) + 10log (NANT) where NANT = 4



Antenna A - NR Modulation QPSK - NR Carrier Bandwidth 10.0 MHz 15 kHz SCS - Channel Position T

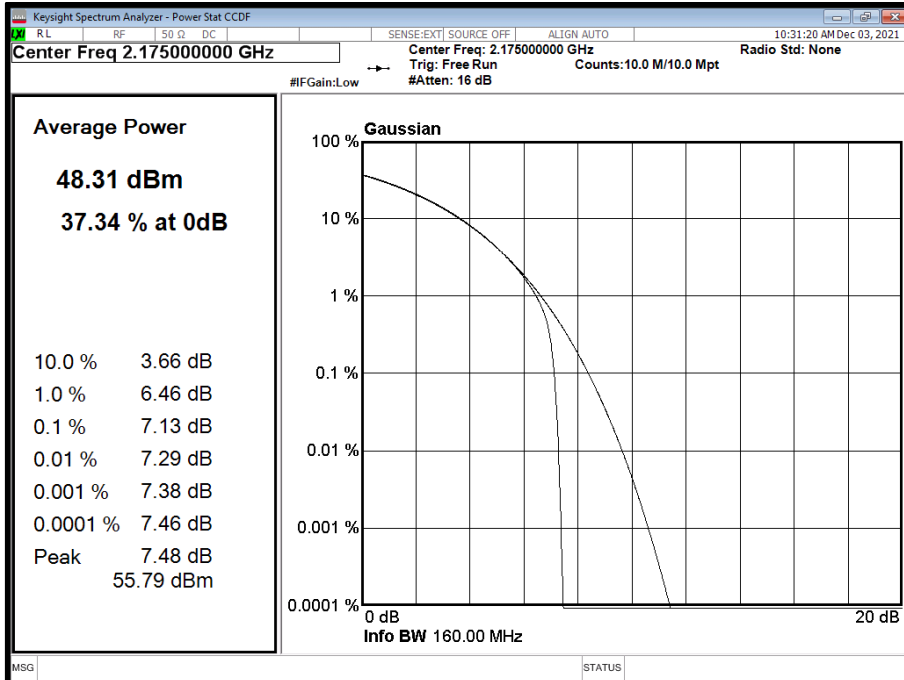

Antenna A - NR Modulation QPSK - NR Carrier Bandwidth 15.0 MHz 15 kHz SCS - Channel Position T

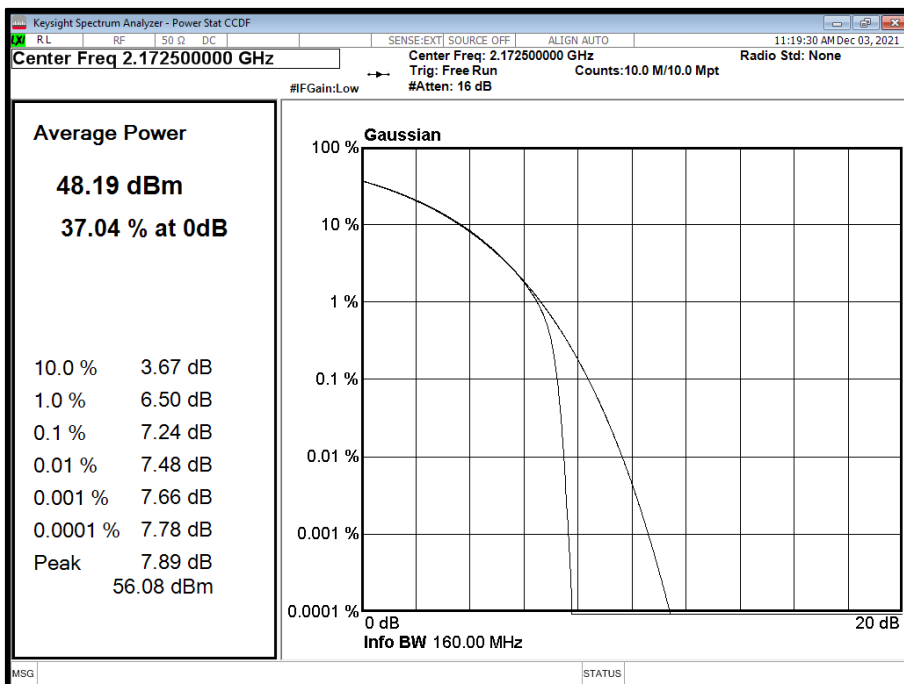



Antenna A - NR Modulation QPSK - NR Carrier Bandwidth 20.0 MHz 15 kHz SCS - Channel Position T

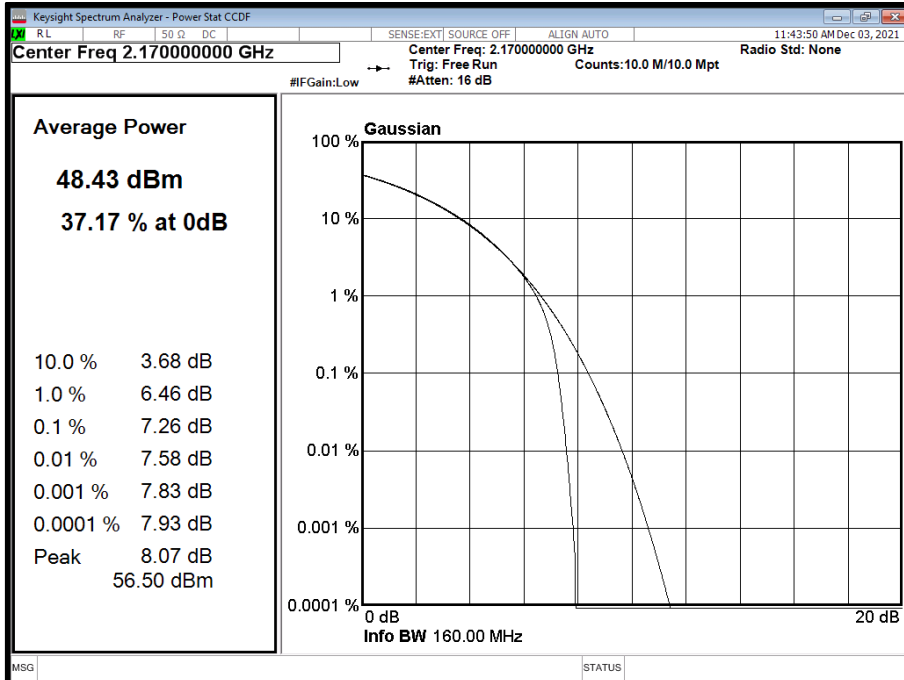

Limit	
Maximum rated output power (Non-Rural)	≤ 1640 W/MHz or ≤+62.15 dBm/MHz
Maximum rated output power (Rural)	≤ 3280 W/MHz or ≤+65.15 dBm/MHz
Peak to Average Ratio	13 dB

The radio unit was tested with maximum output power and without an antenna. ERP/EIRP compliance is addressed at the time of licensing, as required by the responsible FCC/ISED Bureau(s). Licensees are required to take into account maximum allowed antenna gain used in combination with the applicable power settings to prevent the radiated output power exceeding the limits.



2.2 OCCUPIED BANDWIDTH

2.2.1 Specification Reference

FCC CFR 47 Part 27, Clause 27.53
FCC CFR 47 Part 2, Clause 2.1049

2.2.2 Date of Test and Modification State

03-December-2021 - Modification State 0

2.2.3 Test Equipment Used

The major items of test equipment used for the above tests are identified in Section 3.1.

2.2.4 Environmental Conditions

Ambient Temperature	22.6°C
Relative Humidity	32.3%

2.2.5 Test Method

All measurements were made in accordance with FCC KDB 971168 D01, Clause 4.2 and 4.3. The Spectrum Analyser RBW was configured to be at least 1% of the channel bandwidth of the carrier to be measured.

For 26 dB Bandwidth, in accordance with KDB 971168 D01, a peak detector and a trace setting of Max Hold were used. The trace was allowed to stabilise. Using the Spectrum Analyser function, the 26dB measurement result was obtained.

4.2 Occupied bandwidth – relative measurement procedure

The reference value is the highest level of the spectral envelope of the modulated signal, unless otherwise specified in an applicable rule section.

Subclause 5.4.3 of ANSI C63.26-2015 is applicable.

4.3 Occupied bandwidth – power bandwidth (99 %) measurement procedure

Subclause 5.4.4 of ANSI C63.26-2015 is applicable (wherein the recommendation is to use the 99 % power bandwidth function of a spectrum analyzer).

2.2.6 Test Results

Configuration 1

Maximum Output Power 49.00 dBm



Antenna	NR Modulation	NR Carrier Bandwidth	Result (kHz)					
			Channel Position B		Channel Position M		Channel Position T	
			Occupied Bandwidth	-26 dB Bandwidth	Occupied Bandwidth	-26 dB Bandwidth	Occupied Bandwidth	-26 dB Bandwidth
A	QPSK	10.0 MHz 15 kHz SCS	9437.47	9805.33	9446.37	9800.65	9441.85	9808.67
A	QPSK	15.0 MHz 15 kHz SCS	14367.13	14810.85	14368.23	14804.03	14359.88	14804.33
A	QPSK	20.0 MHz 15 kHz SCS	19184.15	19748.21	19189.26	19743.83	19184.81	19753.34

Antenna A - NR Modulation QPSK - NR Carrier Bandwidth 10.0 MHz 15 kHz SCS - Channel Position B

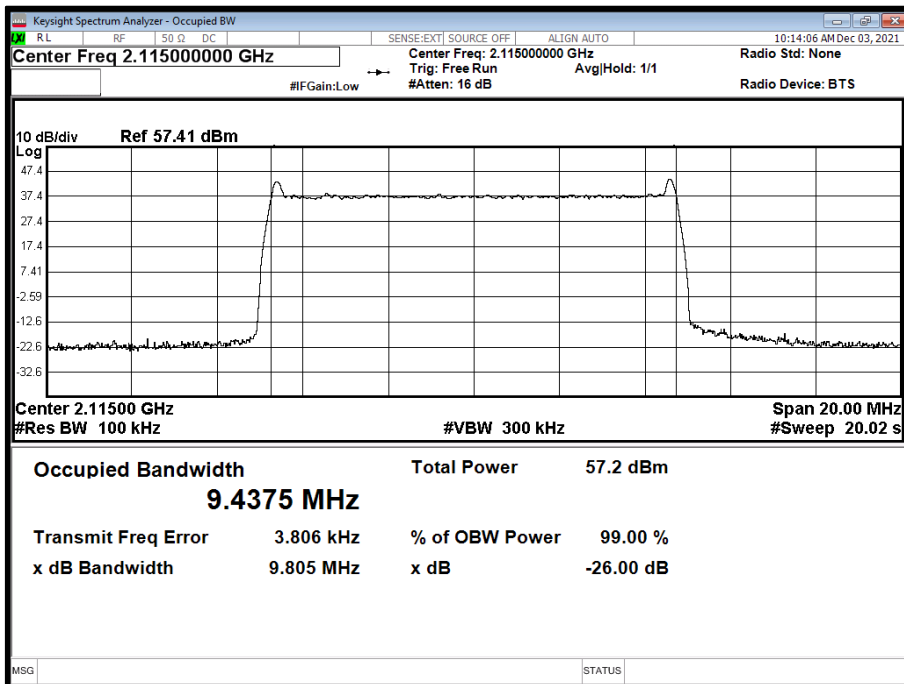



Antenna A - NR Modulation QPSK - NR Carrier Bandwidth 10.0 MHz 15 kHz SCS - Channel Position M

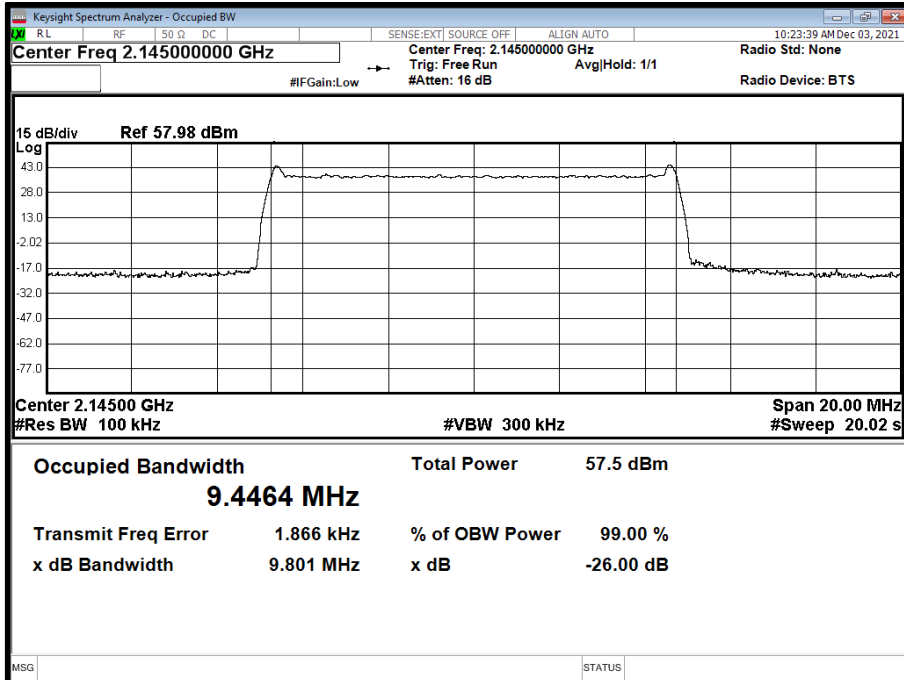

Antenna A - NR Modulation QPSK - NR Carrier Bandwidth 10.0 MHz 15 kHz SCS - Channel Position T

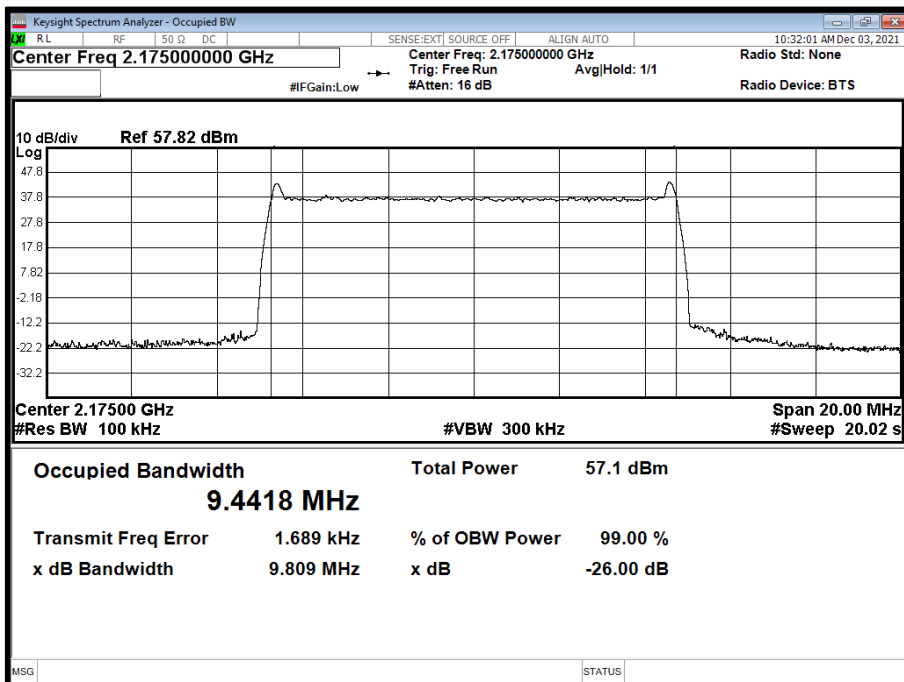



Antenna A - NR Modulation QPSK - NR Carrier Bandwidth 15.0 MHz 15 kHz SCS - Channel Position B

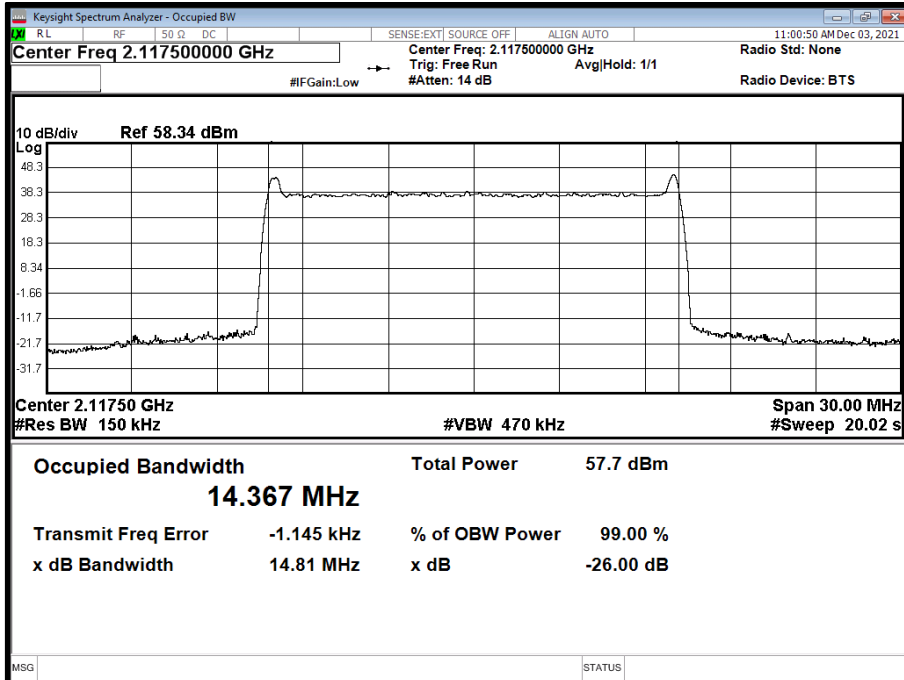

Antenna A - NR Modulation QPSK - NR Carrier Bandwidth 15.0 MHz 15 kHz SCS - Channel Position M

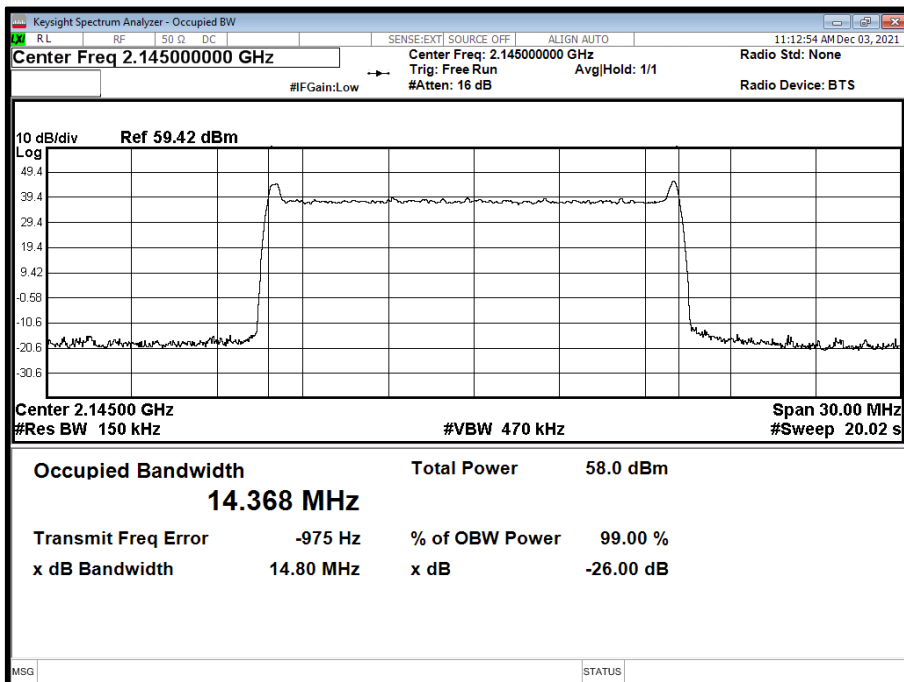



Antenna A - NR Modulation QPSK - NR Carrier Bandwidth 15.0 MHz 15 kHz SCS - Channel Position T

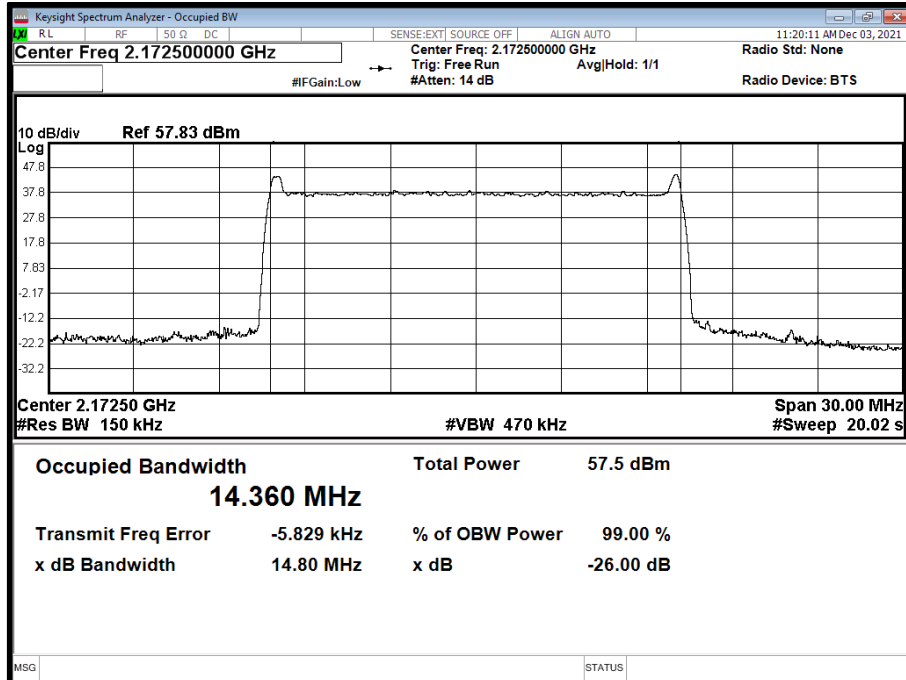

Antenna A - NR Modulation QPSK - NR Carrier Bandwidth 20.0 MHz 15 kHz SCS - Channel Position B

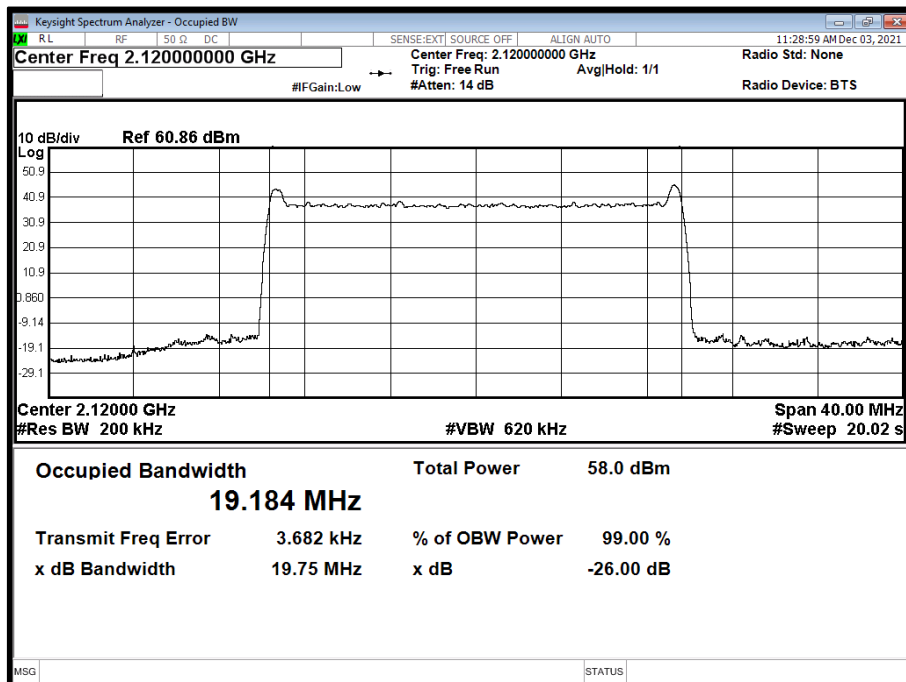



Antenna A - NR Modulation QPSK - NR Carrier Bandwidth 20.0 MHz 15 kHz SCS - Channel Position M

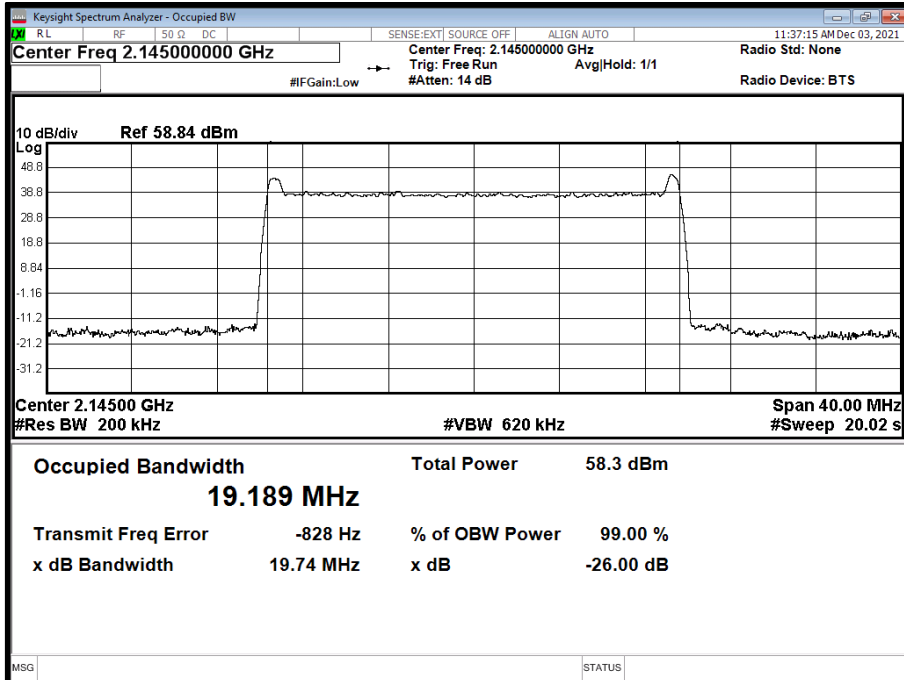

Antenna A - NR Modulation QPSK - NR Carrier Bandwidth 20.0 MHz 15 kHz SCS - Channel Position T

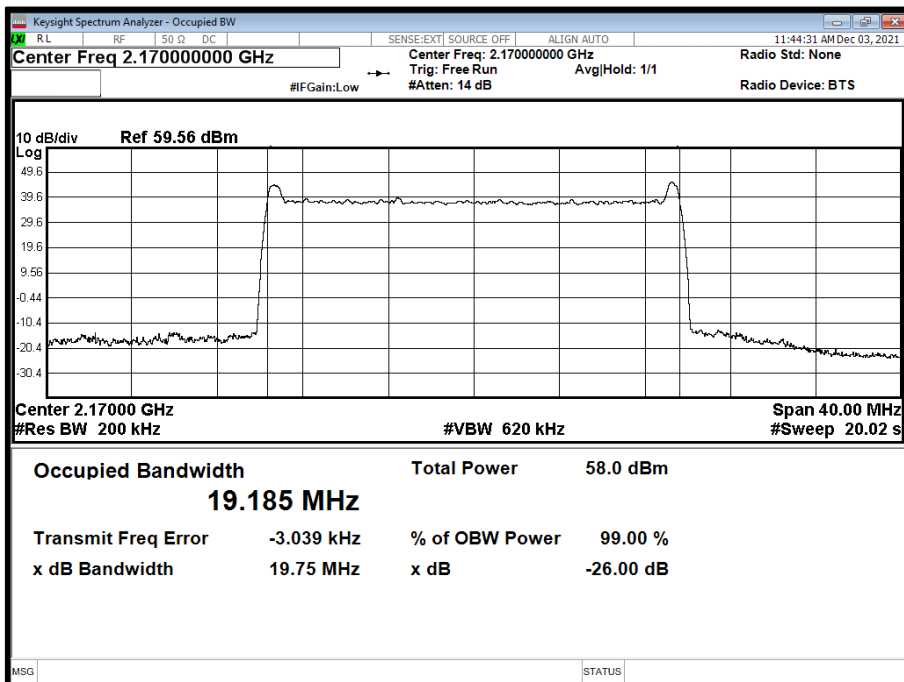



2.3 BAND EDGE

2.3.1 Specification Reference

FCC CFR 47 Part 27, Clause 27.53
FCC CFR 47 Part 2, Clause 2.1051

2.3.2 Date of Test and Modification State

03-December-2021 - Modification State 0

2.3.3 Test Equipment Used

The major items of test equipment used for the above tests are identified in Section 3.1.

2.3.4 Environmental Conditions

Ambient Temperature 22.6°C
Relative Humidity 32.3%

2.3.5 Test Method

All measurements were made in accordance with FCC KDB 971168 D01, Clause 6.0.

Band Edge measurements were used an Integration Bandwidth of at least 1% of the measured 26dB Bandwidth.

Each antenna port has been declared as being equivalent, therefore measurements were made on one antenna port only. To account for this, the limit was tightened by $10 * \text{Log}(N)$, where N is equal to the number of MIMO antenna ports.

For single port, the limit was calculated as being $-13 \text{ dBm} - 10 * \text{Log}(4) = -19 \text{ dBm}$.

2.3.6 Test Results

Configuration 1

Maximum Output Power 49.00 dBm

Antenna	NR Modulation	NR Carrier Bandwidth	Band Edge (MHz)	
			Channel Position B	Channel Position T
A	QPSK	10.0 MHz 15 kHz SCS	2,115.0	2,175.0
A	QPSK	15.0 MHz 15 kHz SCS	2,117.5	2,172.5
A	QPSK	20.0 MHz 15 kHz SCS	2,120.0	2,170.0

Remarks

Please confirm in this comment box, which procedure from KDB 971168 D01 is used for this test.



Antenna A - NR Modulation QPSK - NR Carrier Bandwidth 10.0 MHz 15 kHz SCS - Channel Position B

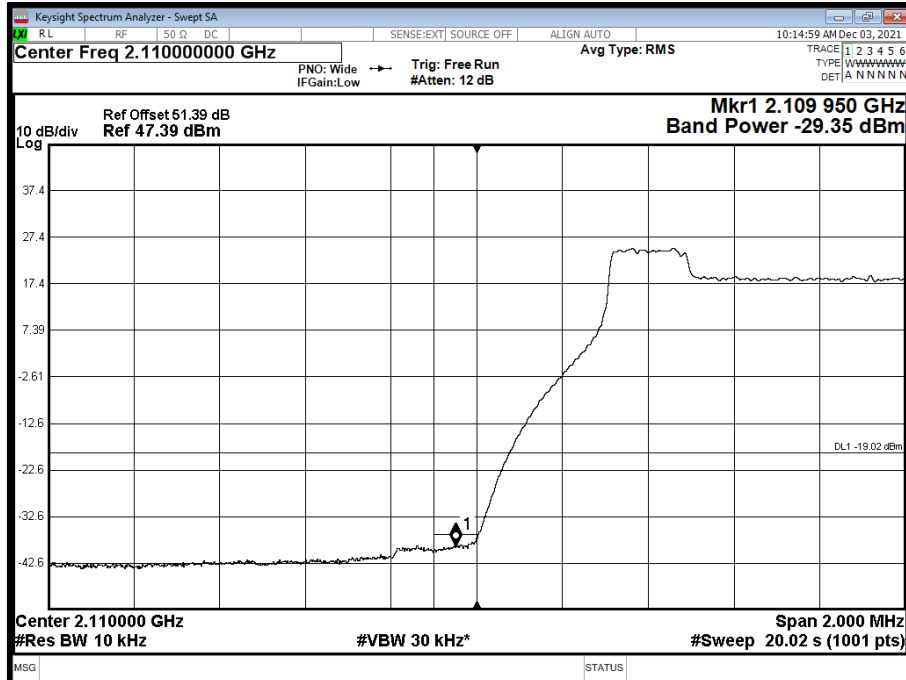

Antenna A - NR Modulation QPSK - NR Carrier Bandwidth 10.0 MHz 15 kHz SCS - Channel Position T

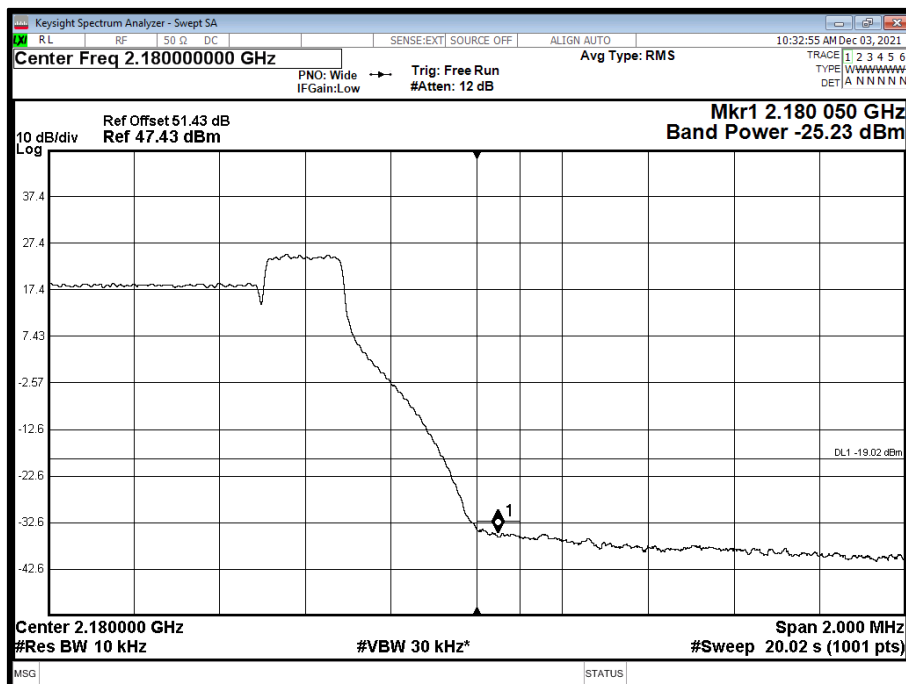



Antenna A - NR Modulation QPSK - NR Carrier Bandwidth 15.0 MHz 15 kHz SCS - Channel Position B

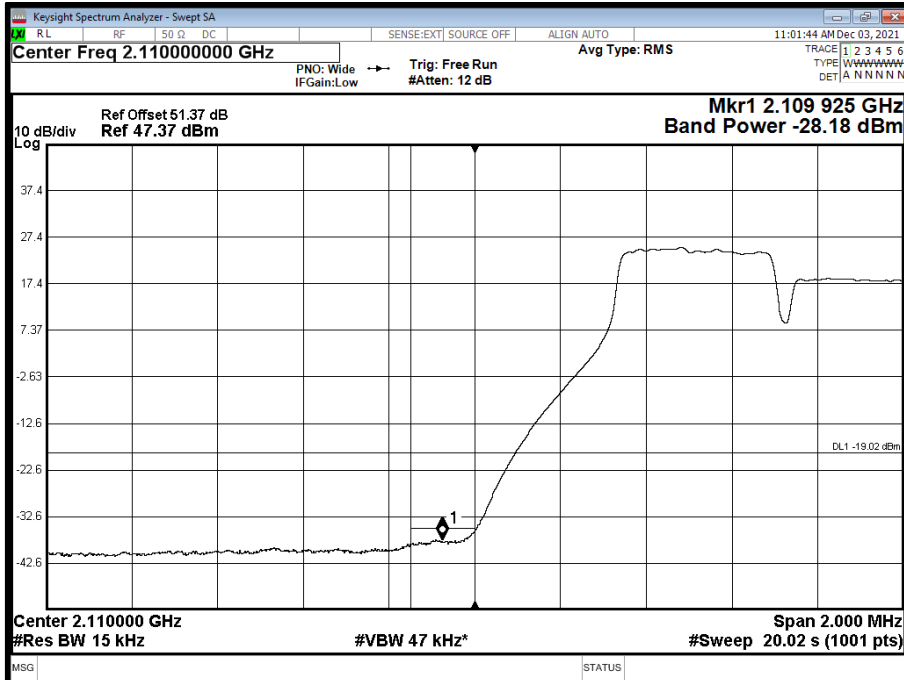

Antenna A - NR Modulation QPSK - NR Carrier Bandwidth 15.0 MHz 15 kHz SCS - Channel Position T

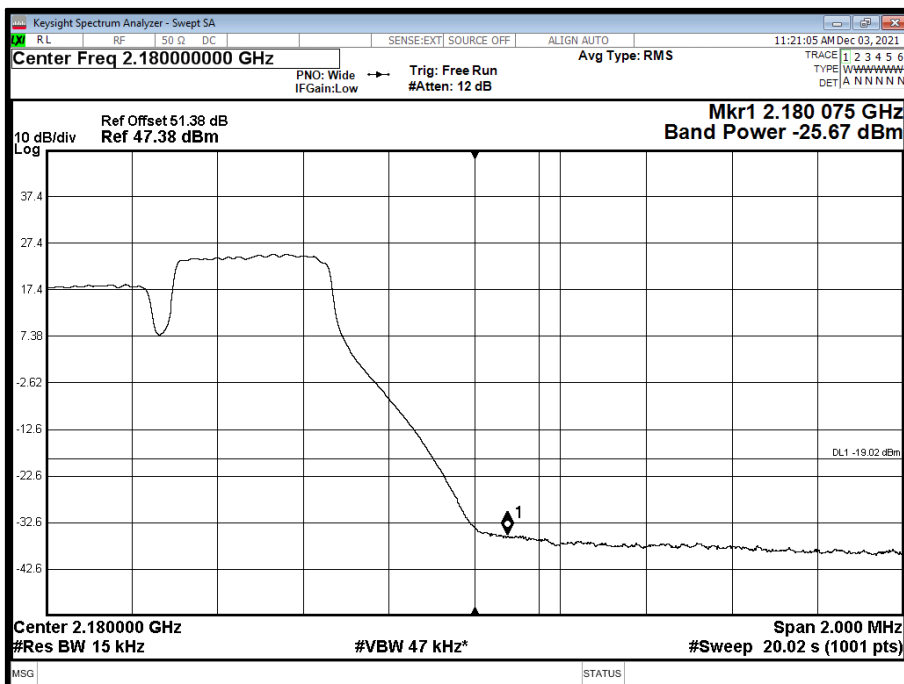



Antenna A - NR Modulation QPSK - NR Carrier Bandwidth 20.0 MHz 15 kHz SCS - Channel Position B

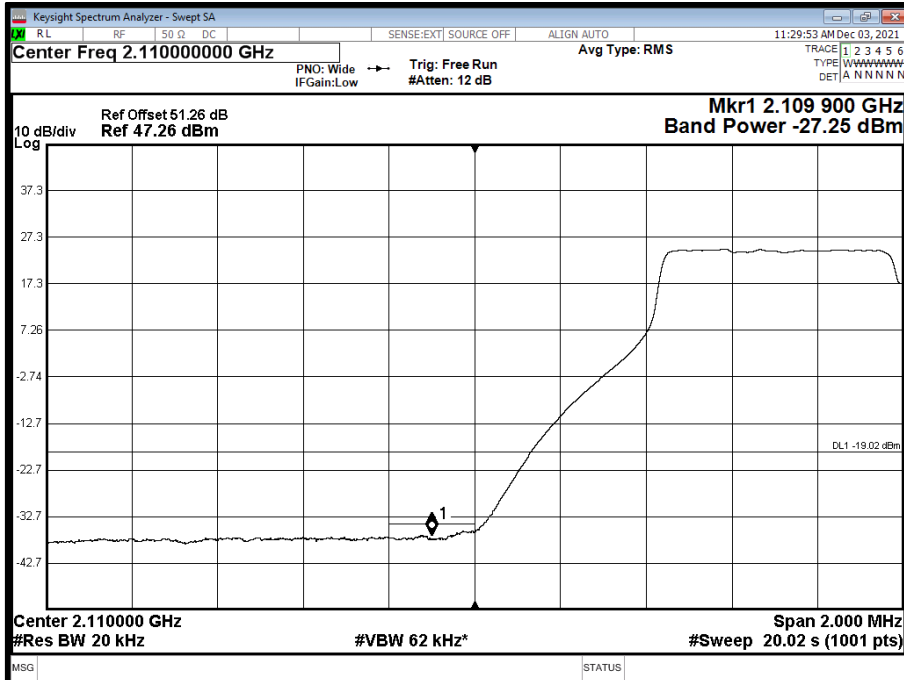

Antenna A - NR Modulation QPSK - NR Carrier Bandwidth 20.0 MHz 15 kHz SCS - Channel Position T

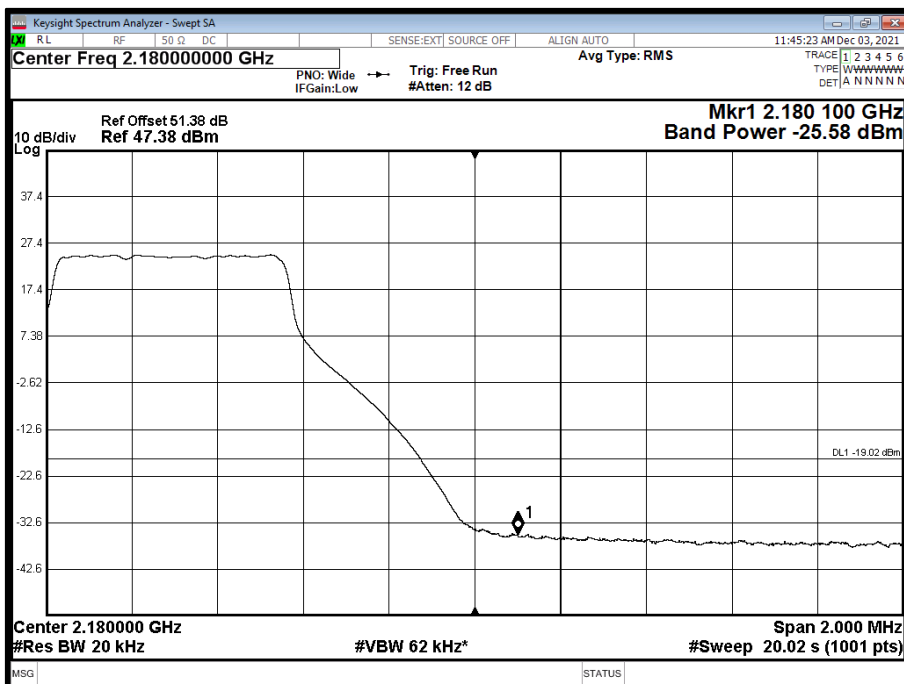

Limit	-19 dBm
-------	---------



2.4 TRANSMITTER SPURIOUS EMISSIONS

2.4.1 Specification Reference

FCC CFR 47 Part 27, Clause 27.53
FCC CFR 47 Part 2, Clause 2.1051

2.4.2 Date of Test and Modification State

03-December-2021 - Modification State 0

2.4.3 Test Equipment Used

The major items of test equipment used for the above tests are identified in Section 3.1.

2.4.4 Environmental Conditions

Ambient Temperature	22.6°C
Relative Humidity	32.3%

2.4.5 Test Method

All measurements were made in accordance with FCC KDB 971168 D01, Clause 6.1.

Each antenna port has been declared as being equivalent, therefore measurements were made on one antenna port only. To account for this, the limit was tightened by $10 * \text{Log}(N)$, where N is equal to the number of MIMO antenna ports.

For single port, the limit was calculated as being $-13 \text{ dBm} - 10 * \text{Log}(4) = -19 \text{ dBm}$.

2.4.6 Test Results

Configuration 1

Maximum Output Power 49.00 dBm



Antenna A - NR Modulation QPSK - NR Carrier Bandwidth 10.0 MHz 15 kHz SCS - Channel Position B - Band 1 - Range 0.009 to 3500 MHz

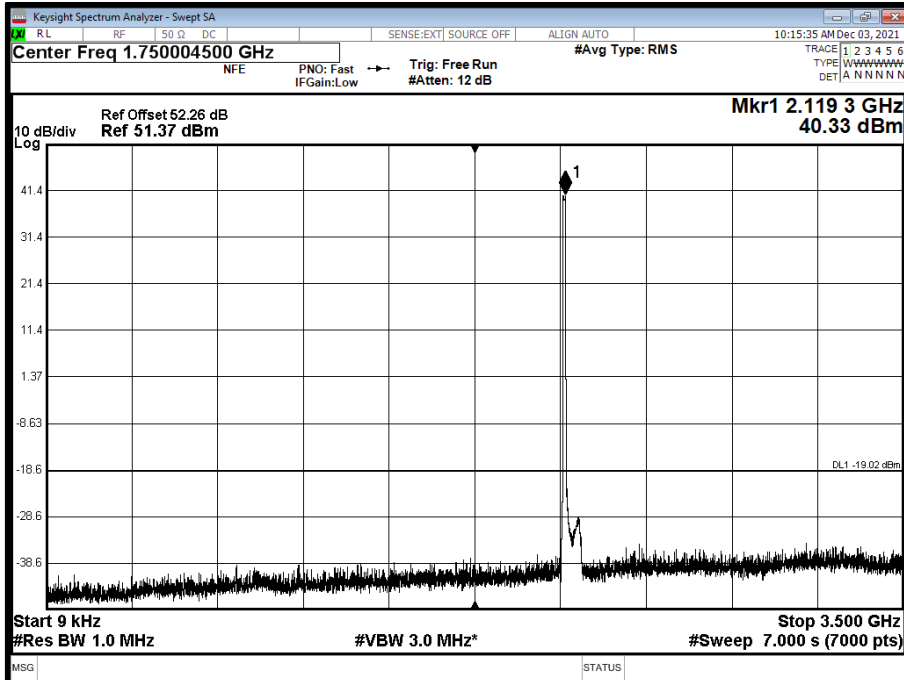

Antenna A - NR Modulation QPSK - NR Carrier Bandwidth 10.0 MHz 15 kHz SCS - Channel Position B - Band 2 - Range 3500 to 8000 MHz

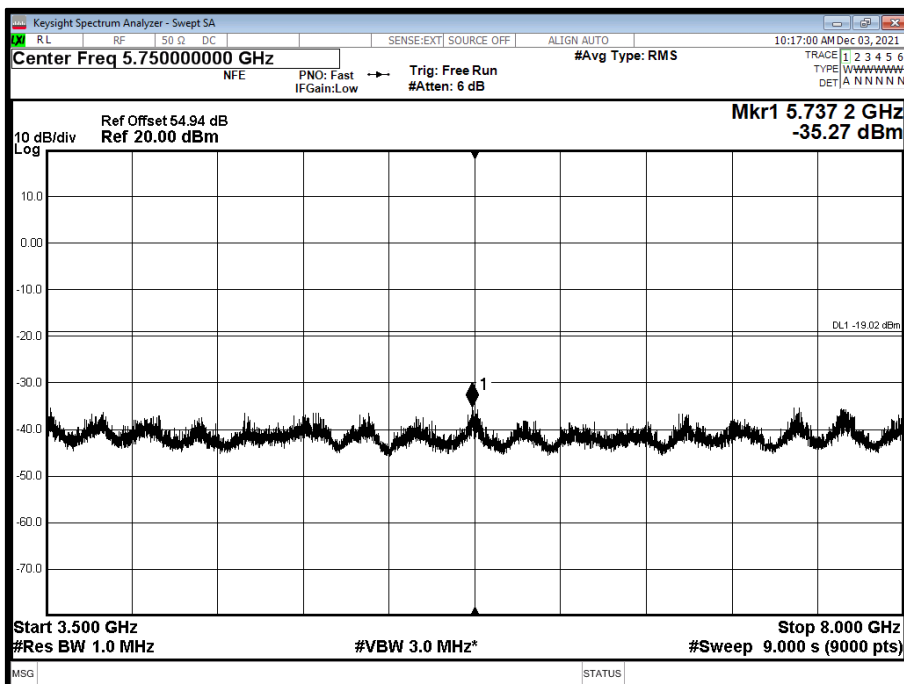



Antenna A - NR Modulation QPSK - NR Carrier Bandwidth 10.0 MHz 15 kHz SCS - Channel Position B - Band 3 - Range 8000 to 12000 MHz

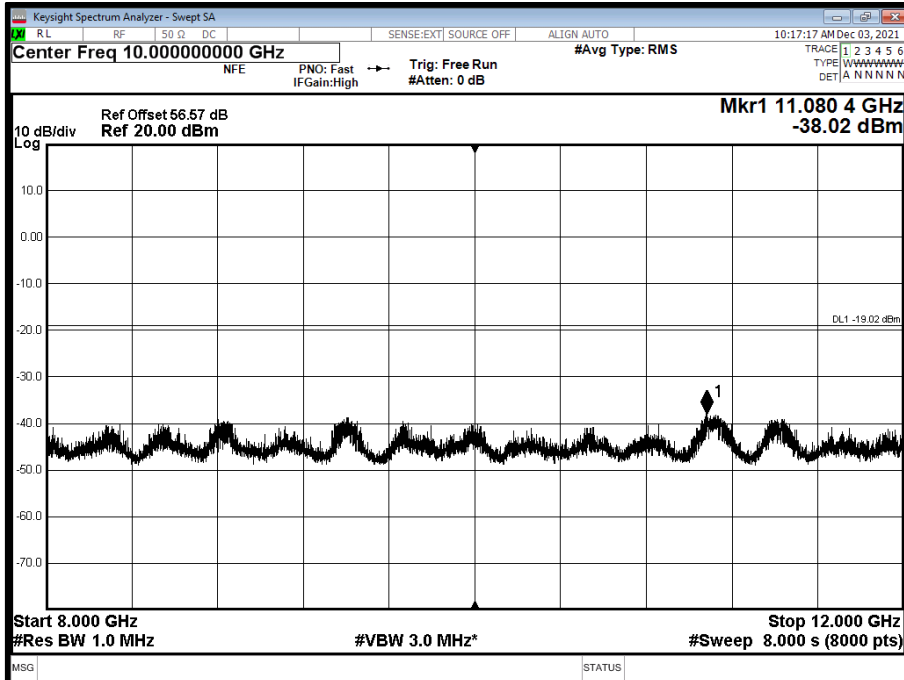

Antenna A - NR Modulation QPSK - NR Carrier Bandwidth 10.0 MHz 15 kHz SCS - Channel Position B - Band 4 - Range 12000 to 18000 MHz

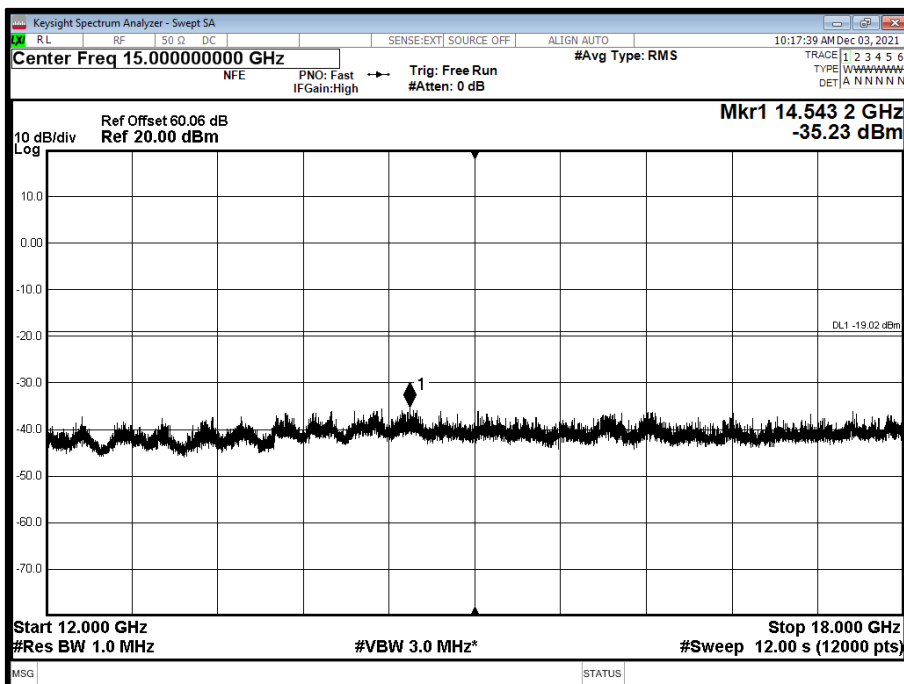



Antenna A - NR Modulation QPSK - NR Carrier Bandwidth 10.0 MHz 15 kHz SCS - Channel Position B - Band 5 - Range 18000 to 22000 MHz

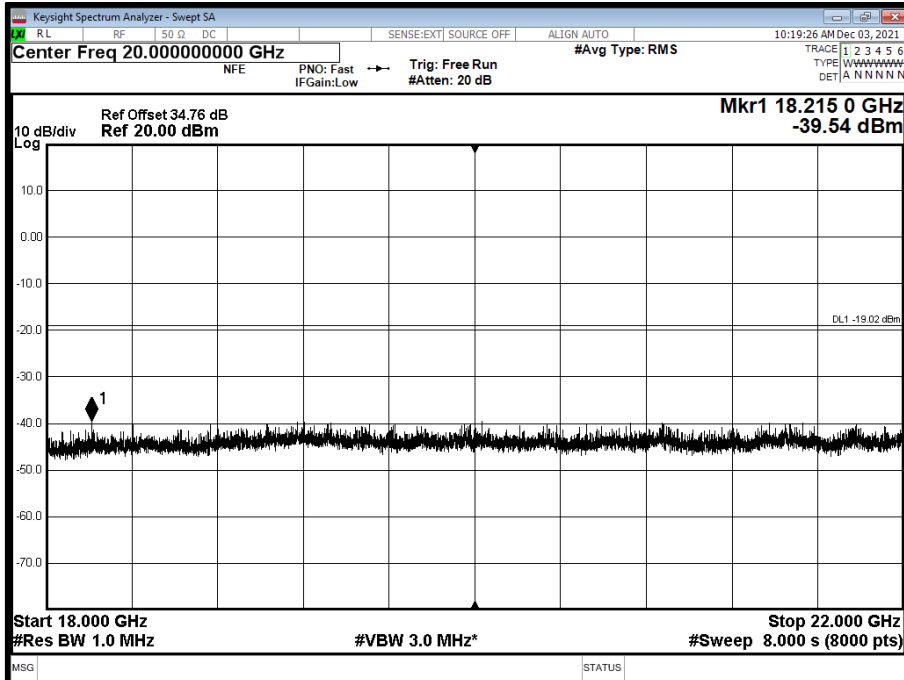

Antenna A - NR Modulation QPSK - NR Carrier Bandwidth 10.0 MHz 15 kHz SCS - Channel Position M - Band 1 - Range 0.009 to 3500 MHz

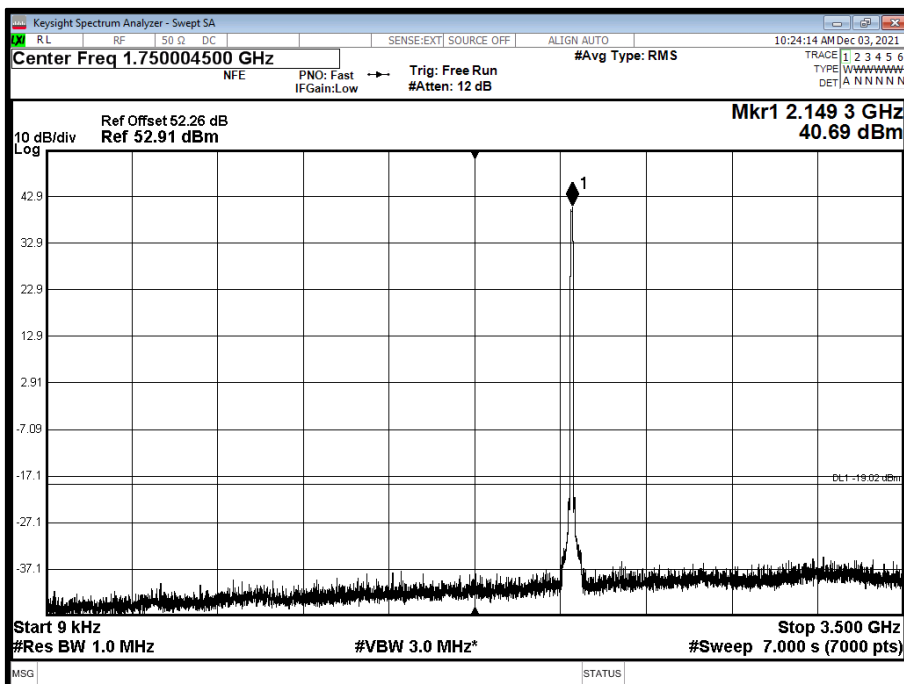



Antenna A - NR Modulation QPSK - NR Carrier Bandwidth 10.0 MHz 15 kHz SCS - Channel Position M - Band 2 - Range 3500 to 8000 MHz

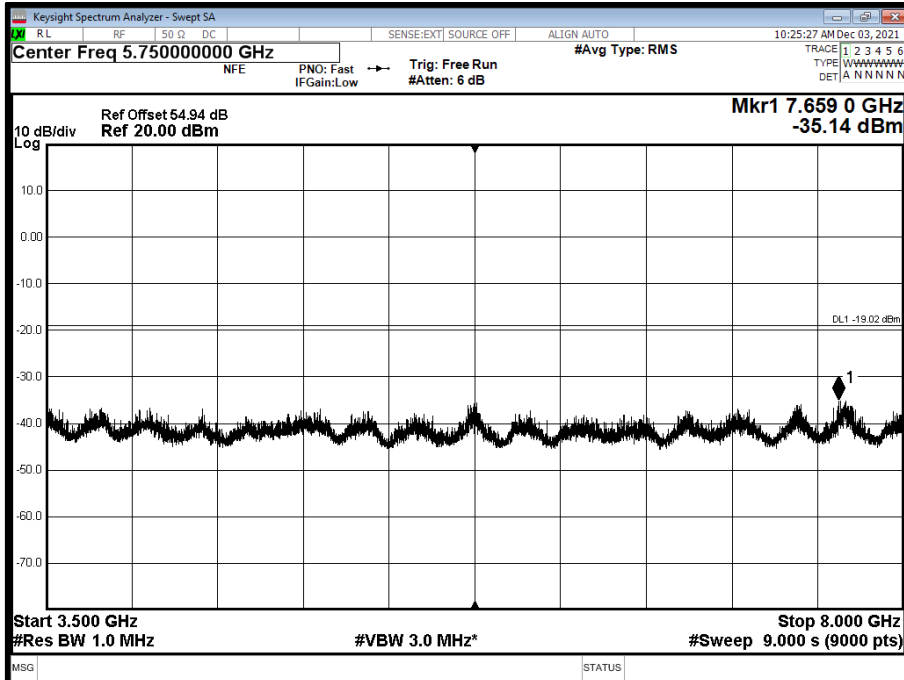

Antenna A - NR Modulation QPSK - NR Carrier Bandwidth 10.0 MHz 15 kHz SCS - Channel Position M - Band 3 - Range 8000 to 12000 MHz

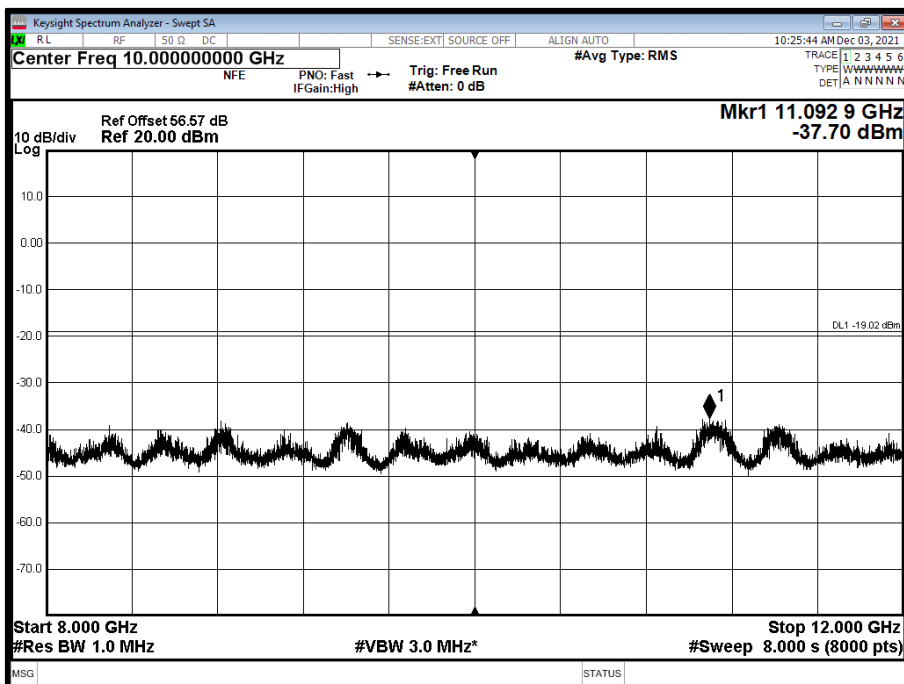



Antenna A - NR Modulation QPSK - NR Carrier Bandwidth 10.0 MHz 15 kHz SCS - Channel Position M - Band 4 - Range 12000 to 18000 MHz

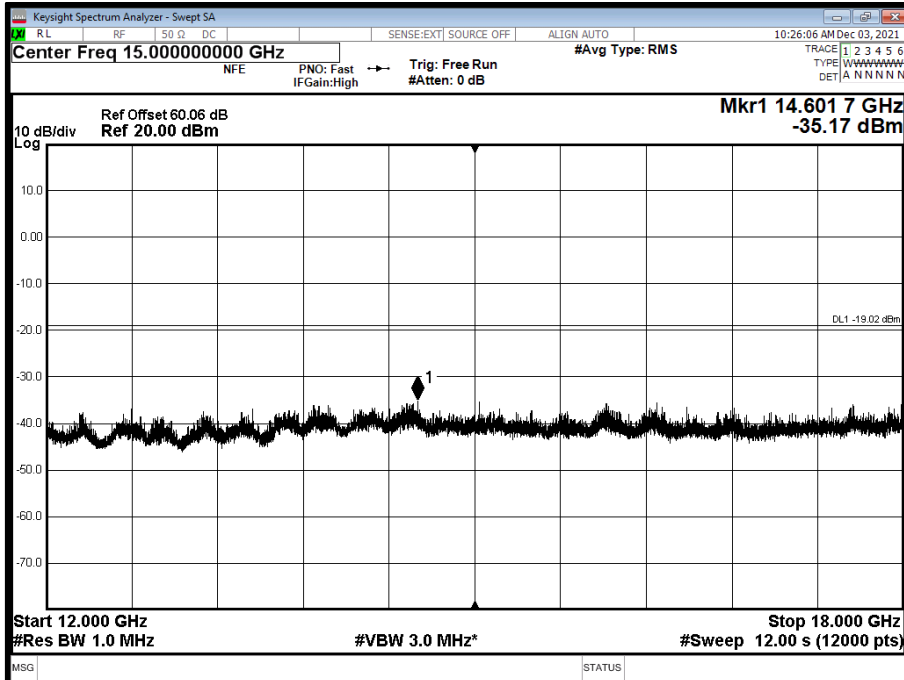

Antenna A - NR Modulation QPSK - NR Carrier Bandwidth 10.0 MHz 15 kHz SCS - Channel Position M - Band 5 - Range 18000 to 22000 MHz

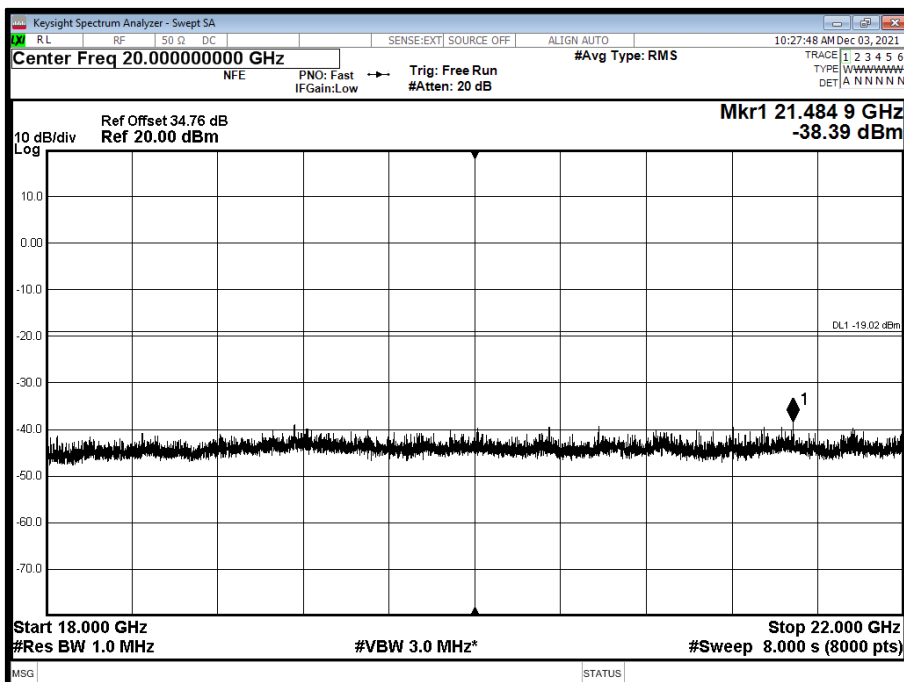



Antenna A - NR Modulation QPSK - NR Carrier Bandwidth 10.0 MHz 15 kHz SCS - Channel Position T - Band 1 - Range 0.009 to 3500 MHz

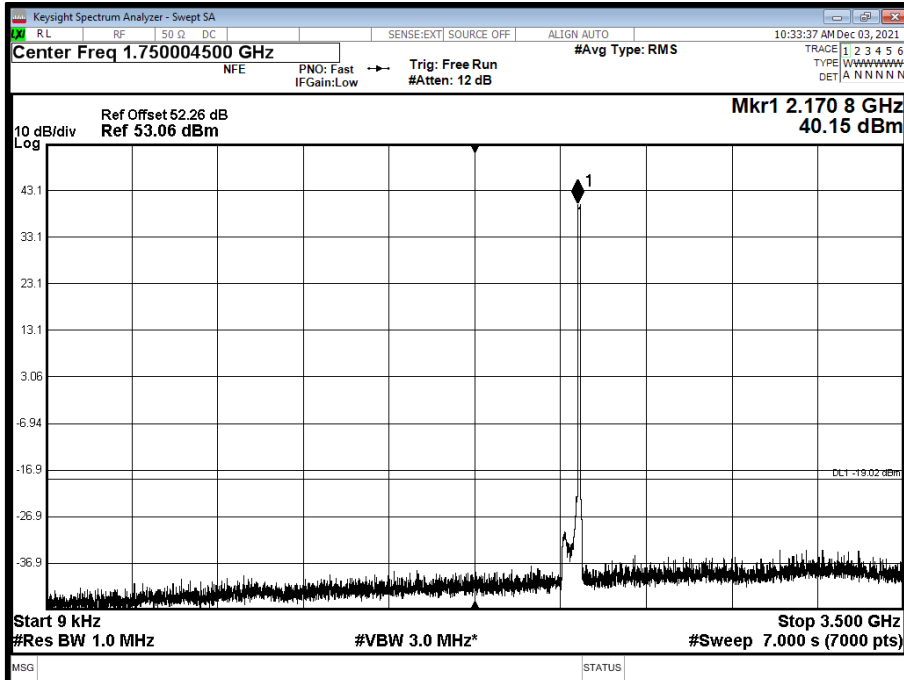

Antenna A - NR Modulation QPSK - NR Carrier Bandwidth 10.0 MHz 15 kHz SCS - Channel Position T - Band 2 - Range 3500 to 8000 MHz

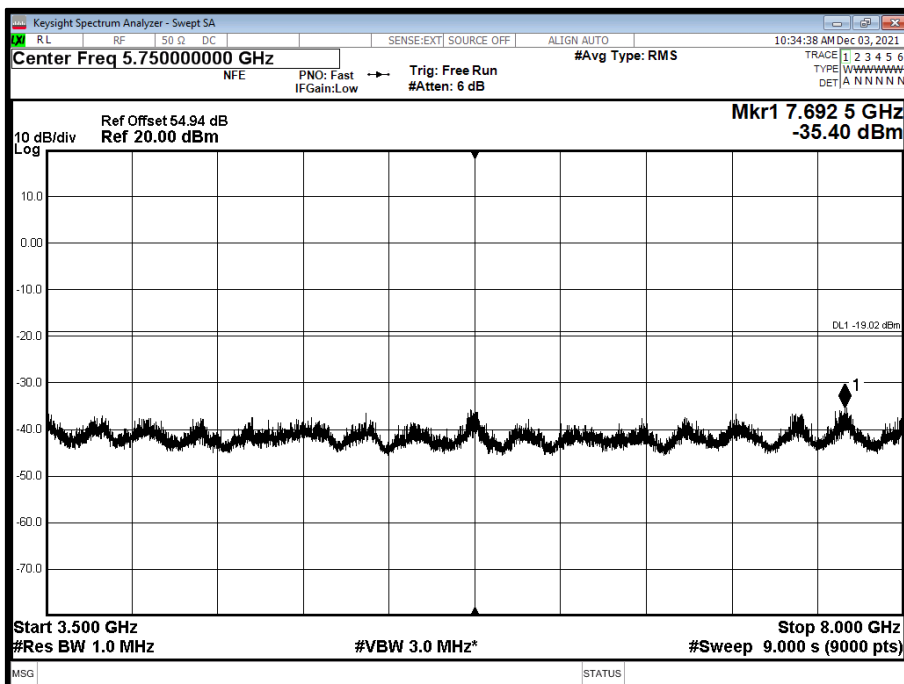



Antenna A - NR Modulation QPSK - NR Carrier Bandwidth 10.0 MHz 15 kHz SCS - Channel Position T - Band 3 - Range 8000 to 12000 MHz

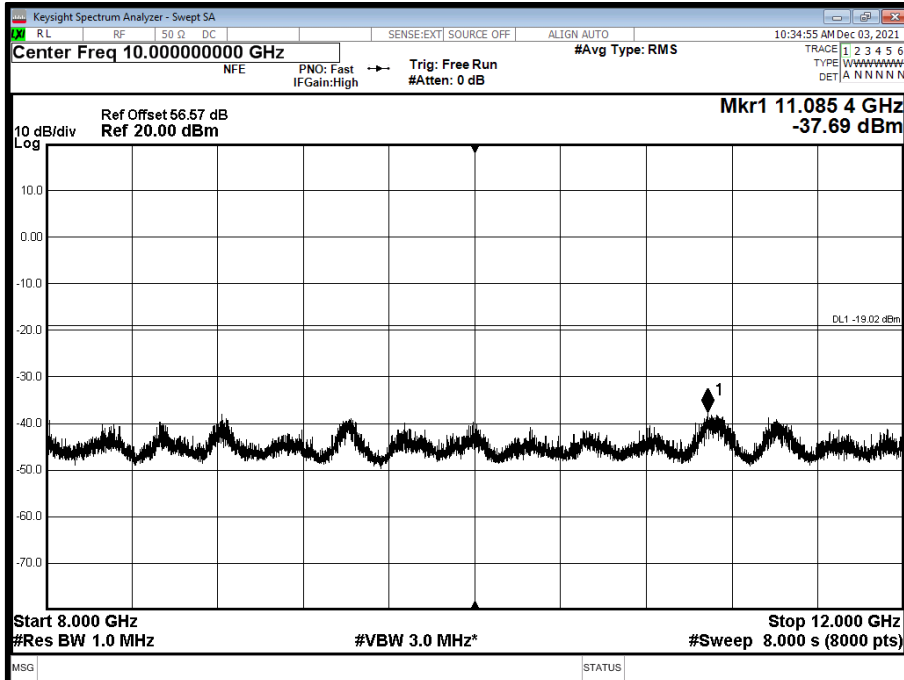

Antenna A - NR Modulation QPSK - NR Carrier Bandwidth 10.0 MHz 15 kHz SCS - Channel Position T - Band 4 - Range 12000 to 18000 MHz

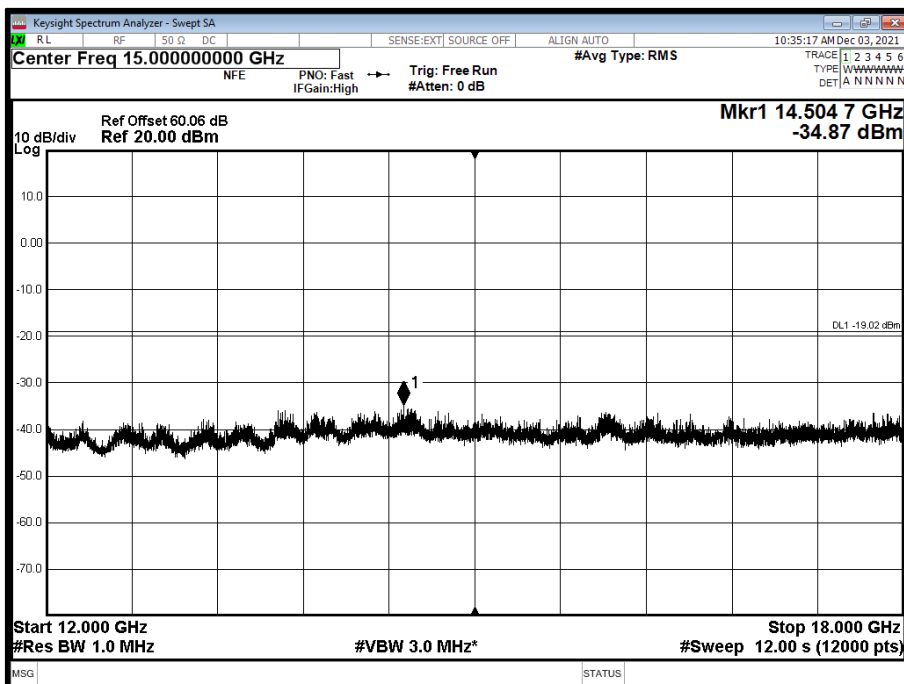



Antenna A - NR Modulation QPSK - NR Carrier Bandwidth 10.0 MHz 15 kHz SCS - Channel Position T - Band 5 - Range 18000 to 22000 MHz

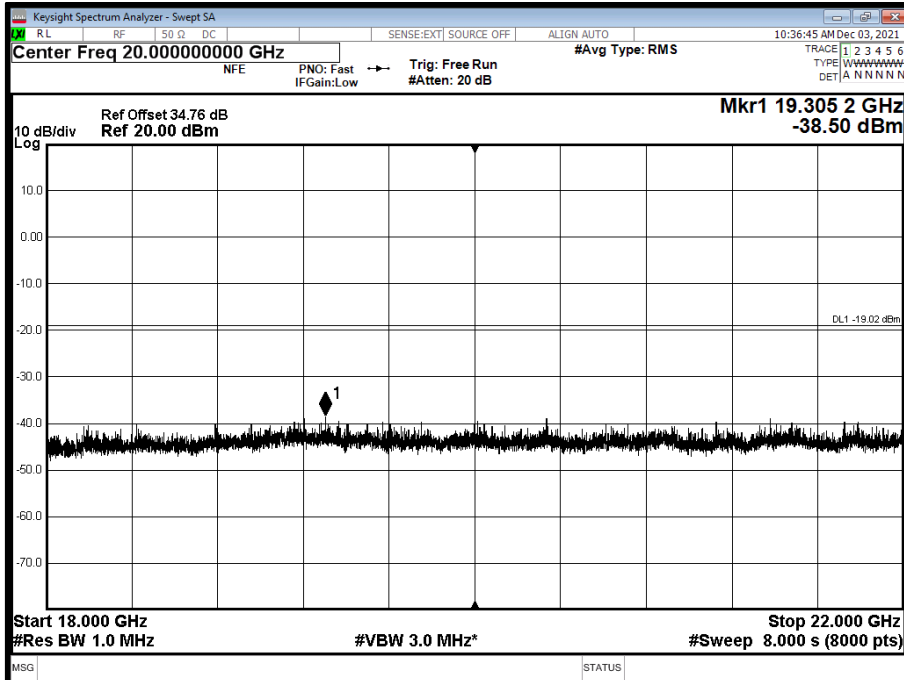

Antenna A - NR Modulation QPSK - NR Carrier Bandwidth 15.0 MHz 15 kHz SCS - Channel Position B - Band 1 - Range 0.009 to 3500 MHz

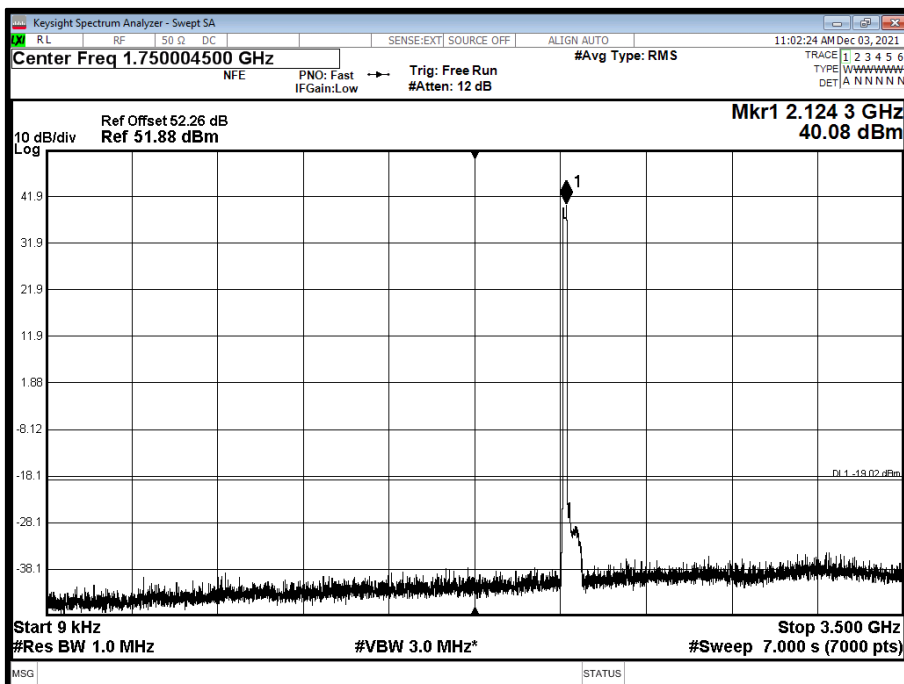



Antenna A - NR Modulation QPSK - NR Carrier Bandwidth 15.0 MHz 15 kHz SCS - Channel Position B - Band 2 - Range 3500 to 8000 MHz

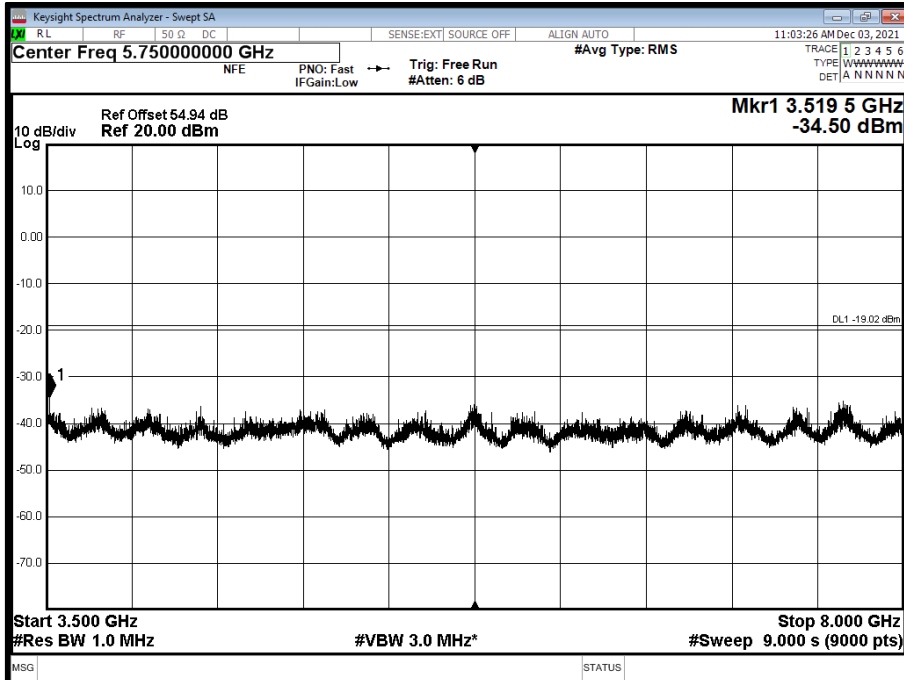

Antenna A - NR Modulation QPSK - NR Carrier Bandwidth 15.0 MHz 15 kHz SCS - Channel Position B - Band 3 - Range 8000 to 12000 MHz

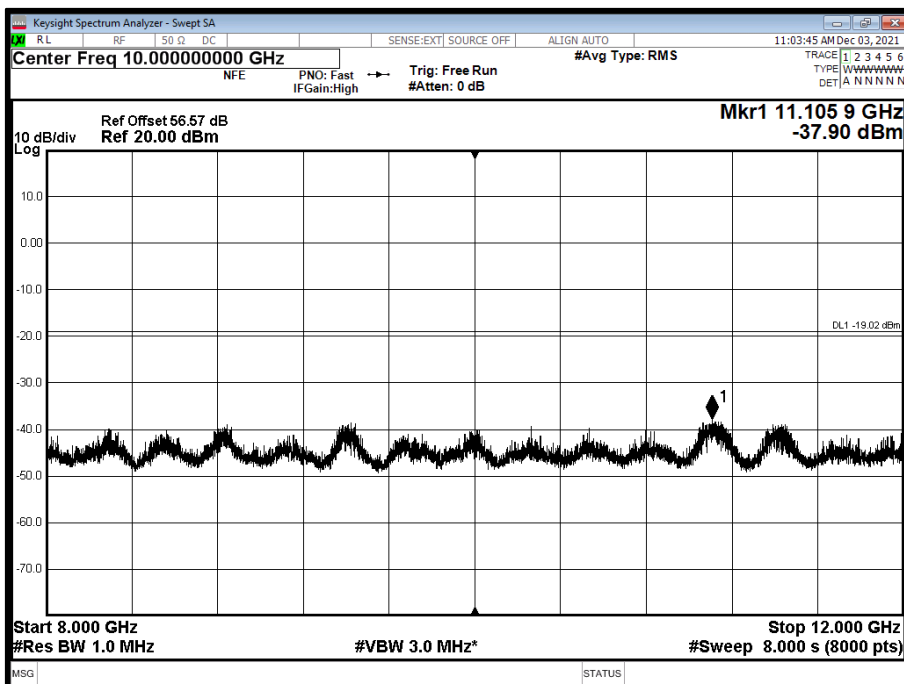



Antenna A - NR Modulation QPSK - NR Carrier Bandwidth 15.0 MHz 15 kHz SCS - Channel Position B - Band 4 - Range 12000 to 18000 MHz

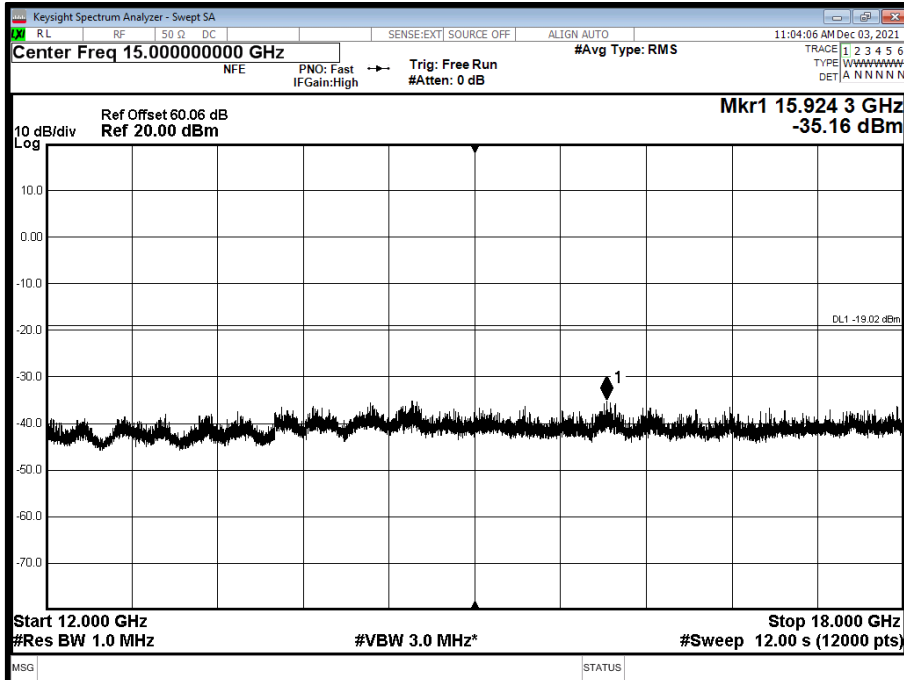

Antenna A - NR Modulation QPSK - NR Carrier Bandwidth 15.0 MHz 15 kHz SCS - Channel Position B - Band 5 - Range 18000 to 22000 MHz

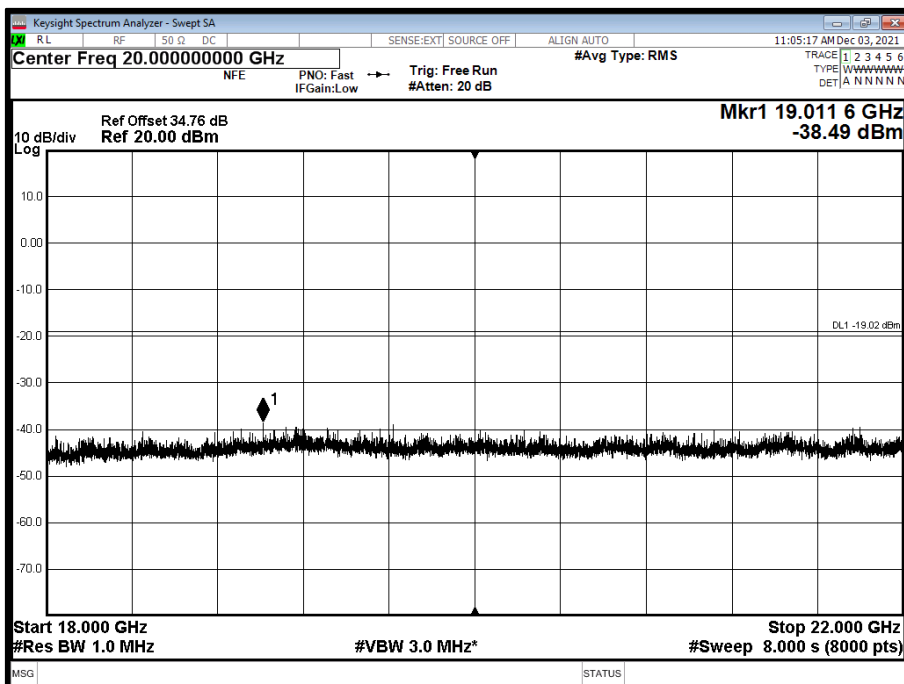



Antenna A - NR Modulation QPSK - NR Carrier Bandwidth 15.0 MHz 15 kHz SCS - Channel Position M - Band 1 - Range 0.009 to 3500 MHz

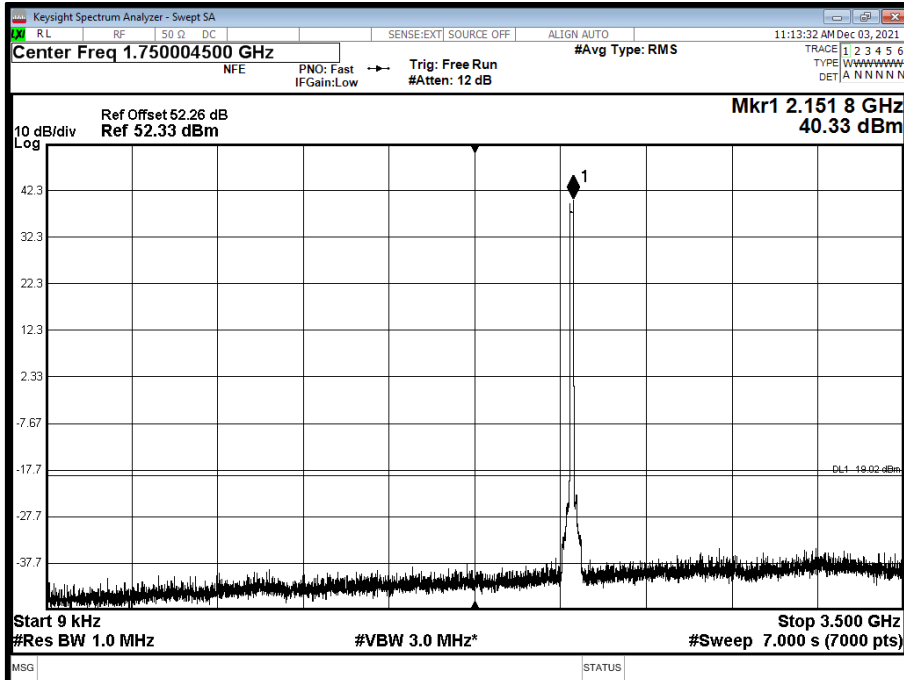

Antenna A - NR Modulation QPSK - NR Carrier Bandwidth 15.0 MHz 15 kHz SCS - Channel Position M - Band 2 - Range 3500 to 8000 MHz

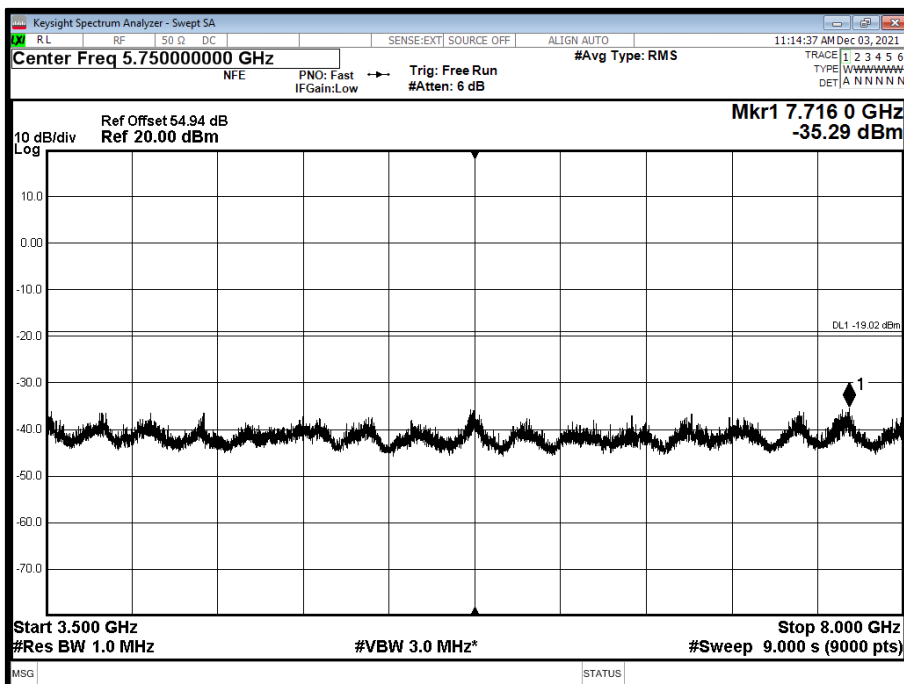



Antenna A - NR Modulation QPSK - NR Carrier Bandwidth 15.0 MHz 15 kHz SCS - Channel Position M - Band 3 - Range 8000 to 12000 MHz

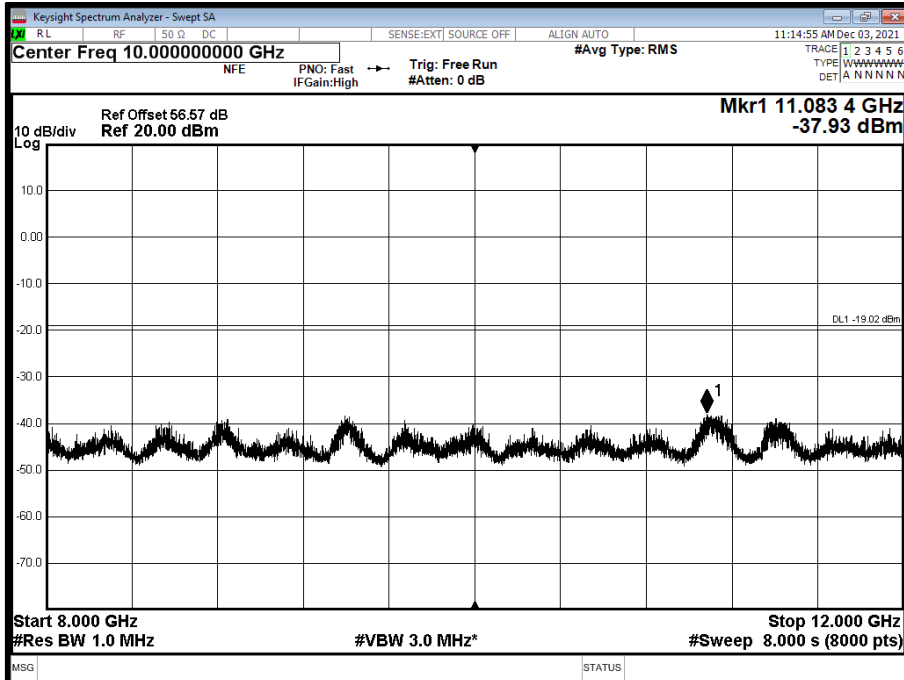

Antenna A - NR Modulation QPSK - NR Carrier Bandwidth 15.0 MHz 15 kHz SCS - Channel Position M - Band 4 - Range 12000 to 18000 MHz

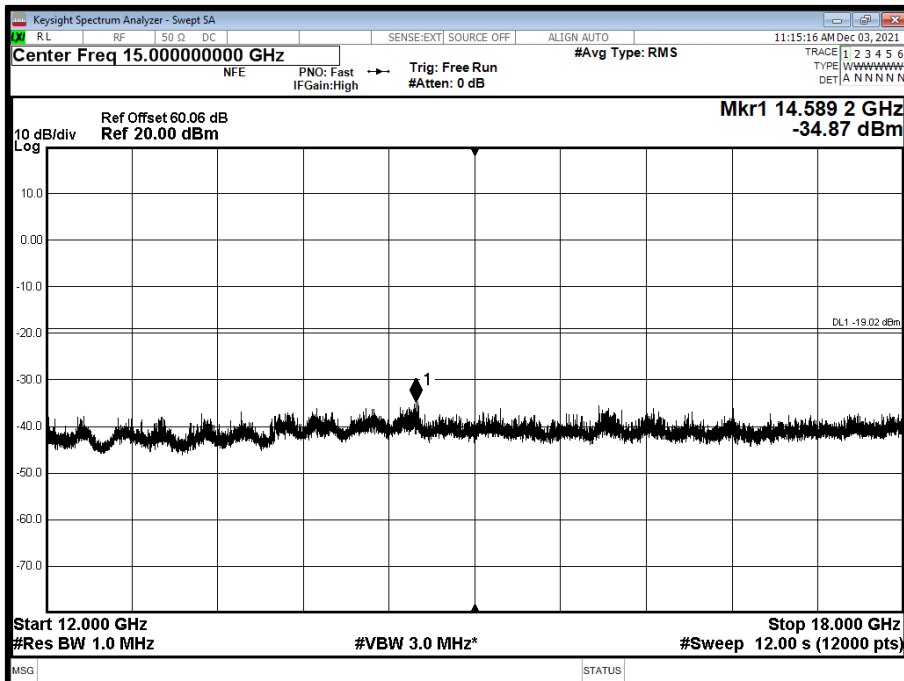



Antenna A - NR Modulation QPSK - NR Carrier Bandwidth 15.0 MHz 15 kHz SCS - Channel Position M - Band 5 - Range 18000 to 22000 MHz

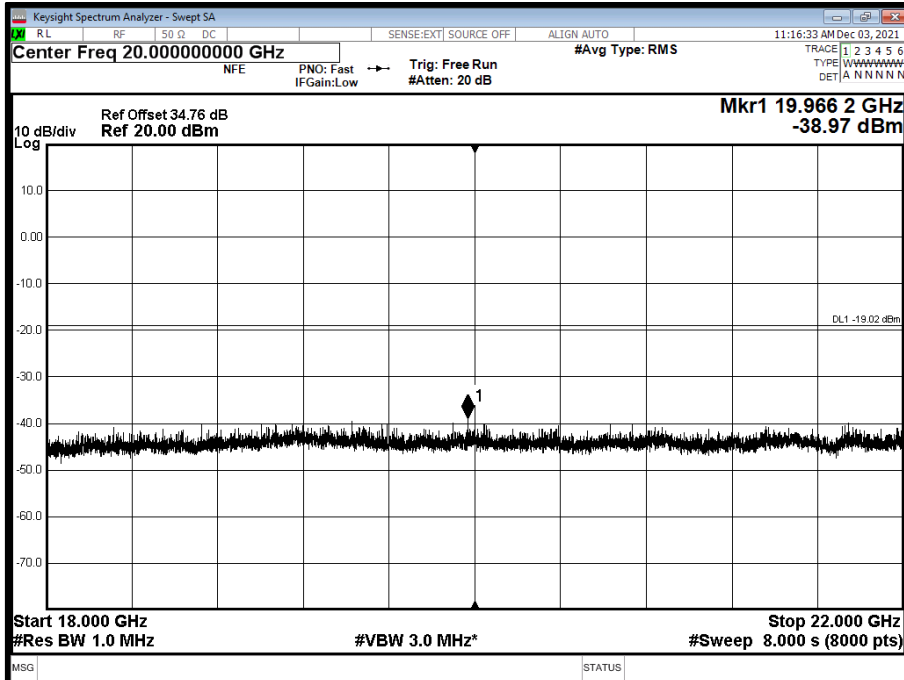

Antenna A - NR Modulation QPSK - NR Carrier Bandwidth 15.0 MHz 15 kHz SCS - Channel Position T - Band 1 - Range 0.009 to 3500 MHz

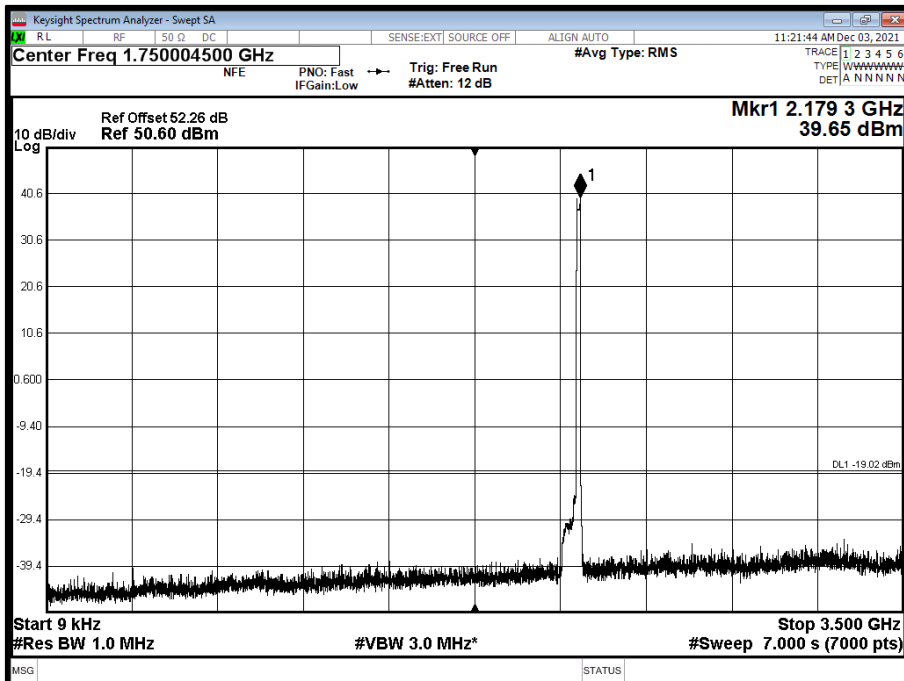



Antenna A - NR Modulation QPSK - NR Carrier Bandwidth 15.0 MHz 15 kHz SCS - Channel Position T - Band 2 - Range 3500 to 8000 MHz

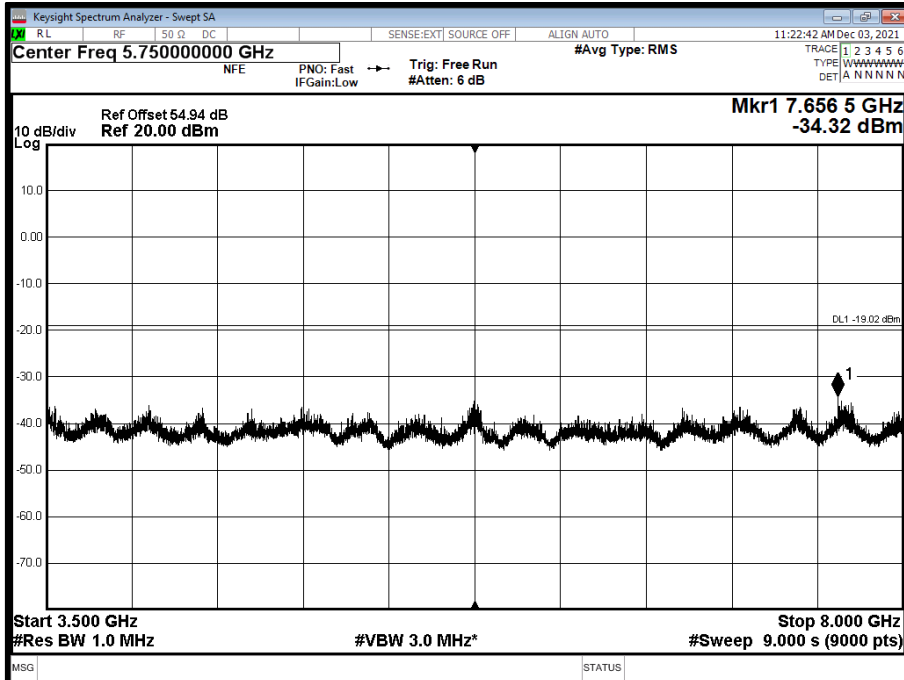

Antenna A - NR Modulation QPSK - NR Carrier Bandwidth 15.0 MHz 15 kHz SCS - Channel Position T - Band 3 - Range 8000 to 12000 MHz

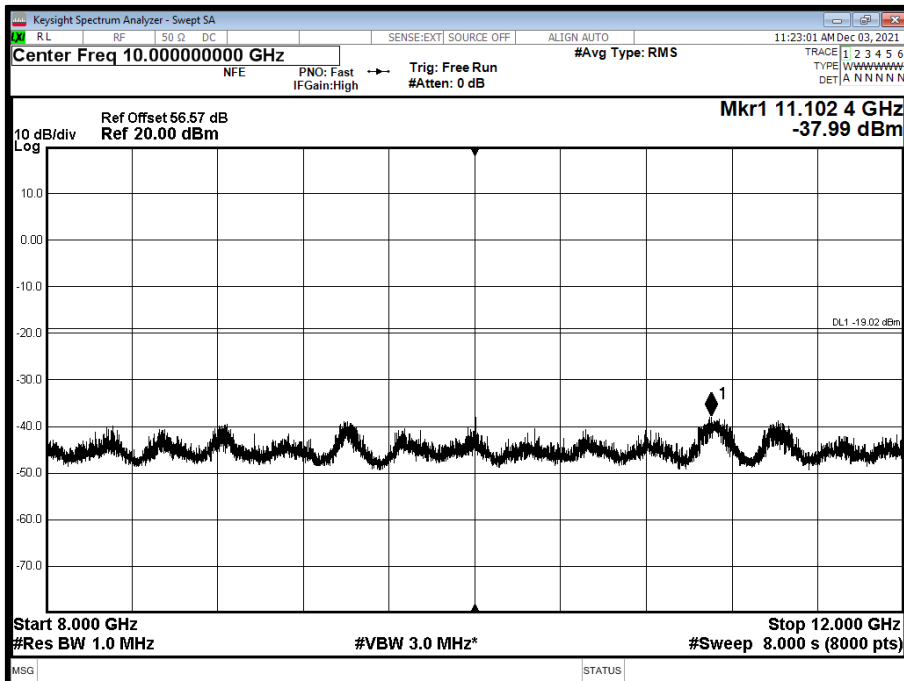



Antenna A - NR Modulation QPSK - NR Carrier Bandwidth 15.0 MHz 15 kHz SCS - Channel Position T - Band 4 - Range 12000 to 18000 MHz

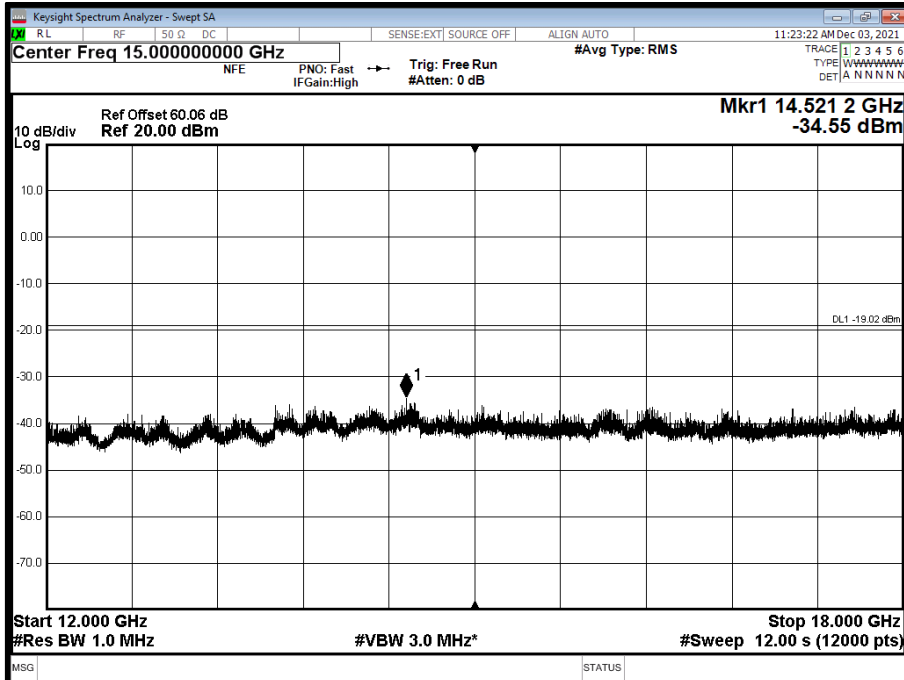

Antenna A - NR Modulation QPSK - NR Carrier Bandwidth 15.0 MHz 15 kHz SCS - Channel Position T - Band 5 - Range 18000 to 22000 MHz

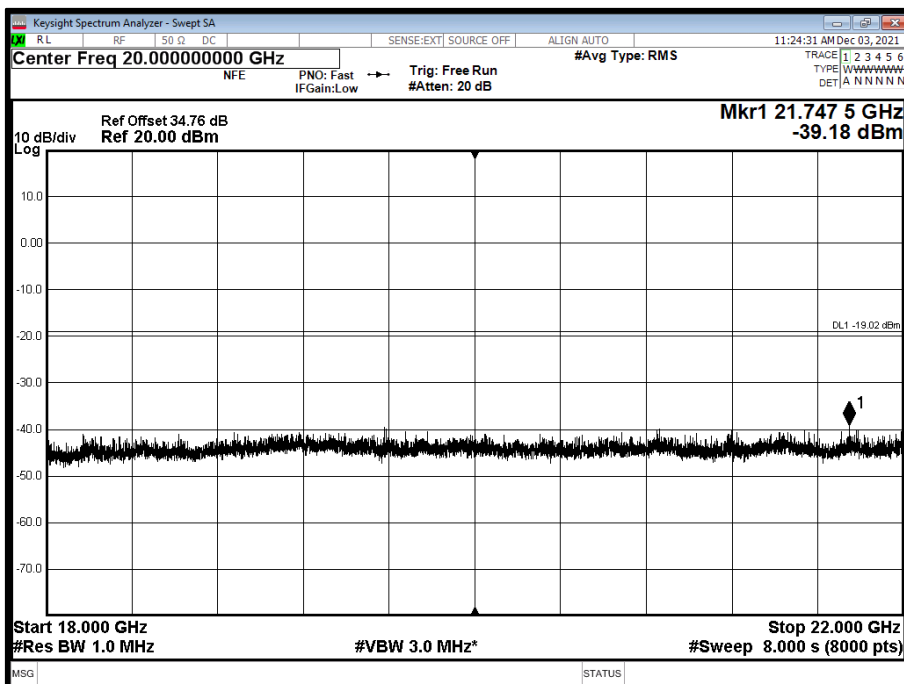



Antenna A - NR Modulation QPSK - NR Carrier Bandwidth 20.0 MHz 15 kHz SCS - Channel Position B - Band 1 - Range 0.009 to 3500 MHz

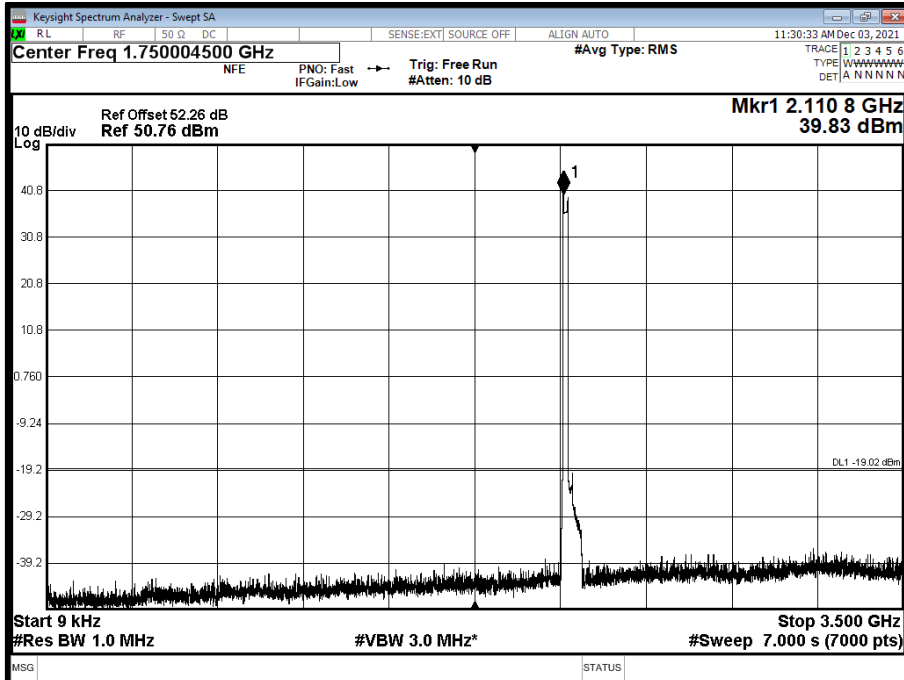

Antenna A - NR Modulation QPSK - NR Carrier Bandwidth 20.0 MHz 15 kHz SCS - Channel Position B - Band 2 - Range 3500 to 8000 MHz

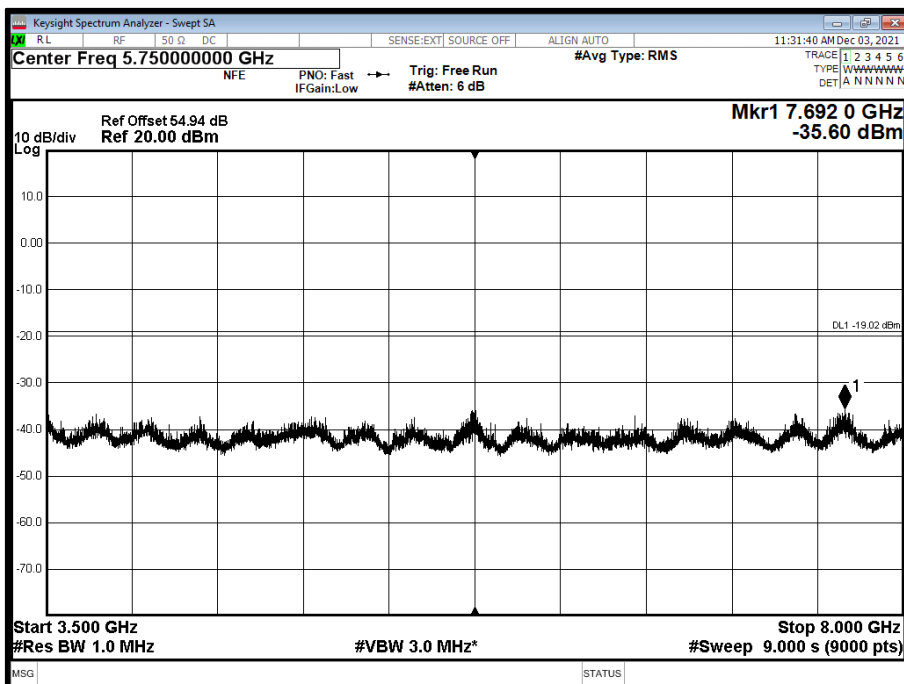



Antenna A - NR Modulation QPSK - NR Carrier Bandwidth 20.0 MHz 15 kHz SCS - Channel Position B - Band 3 - Range 8000 to 12000 MHz

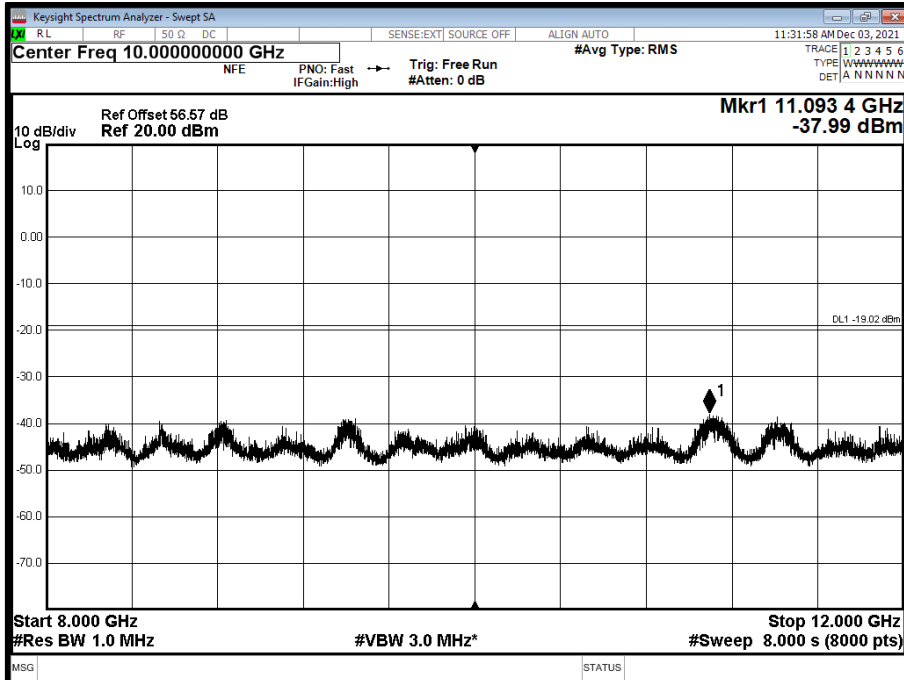

Antenna A - NR Modulation QPSK - NR Carrier Bandwidth 20.0 MHz 15 kHz SCS - Channel Position B - Band 4 - Range 12000 to 18000 MHz

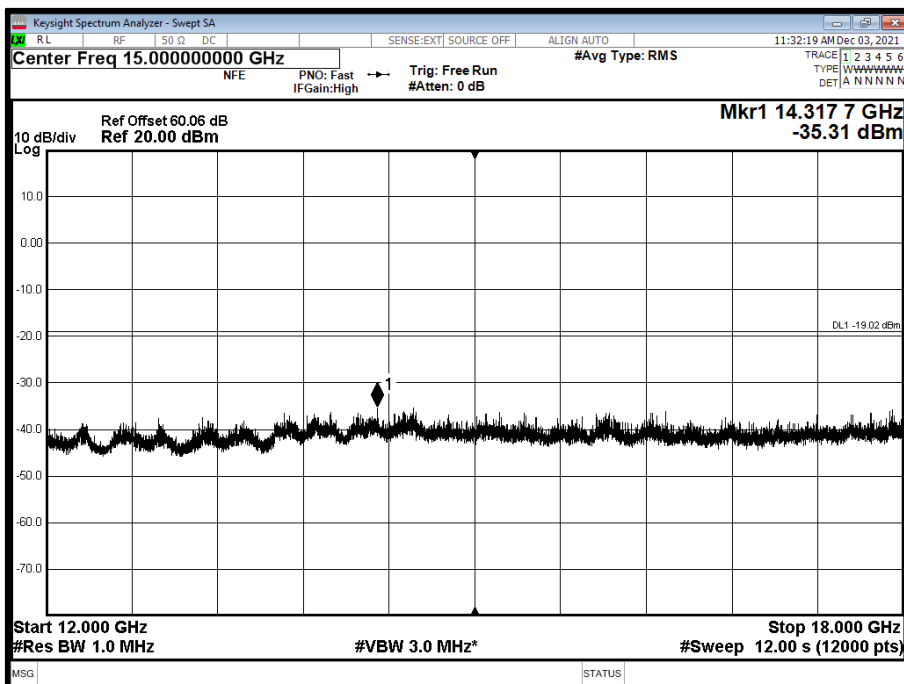



Antenna A - NR Modulation QPSK - NR Carrier Bandwidth 20.0 MHz 15 kHz SCS - Channel Position B - Band 5 - Range 18000 to 22000 MHz

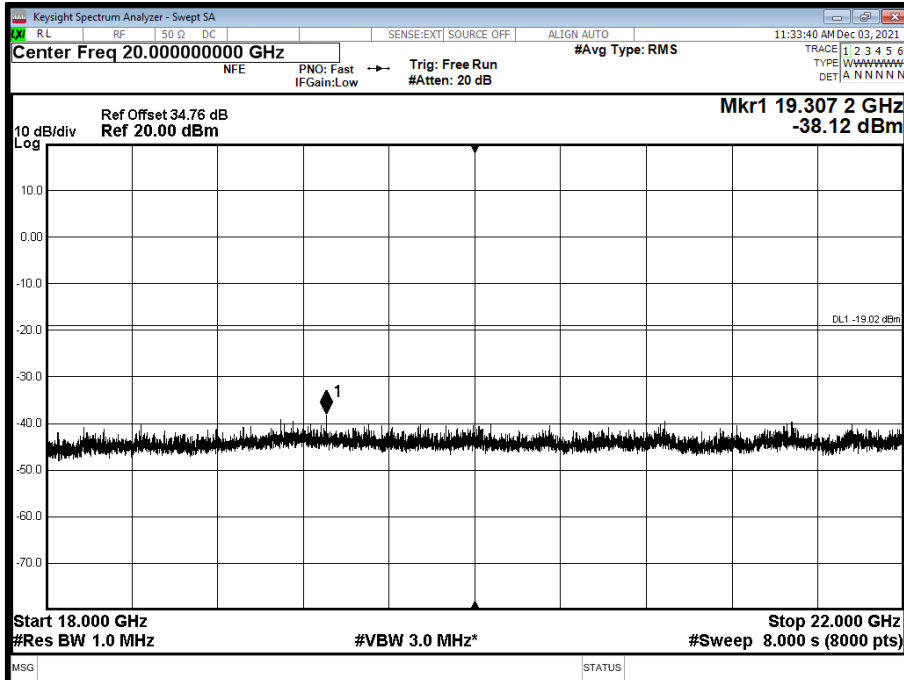

Antenna A - NR Modulation QPSK - NR Carrier Bandwidth 20.0 MHz 15 kHz SCS - Channel Position M - Band 1 - Range 0.009 to 3500 MHz

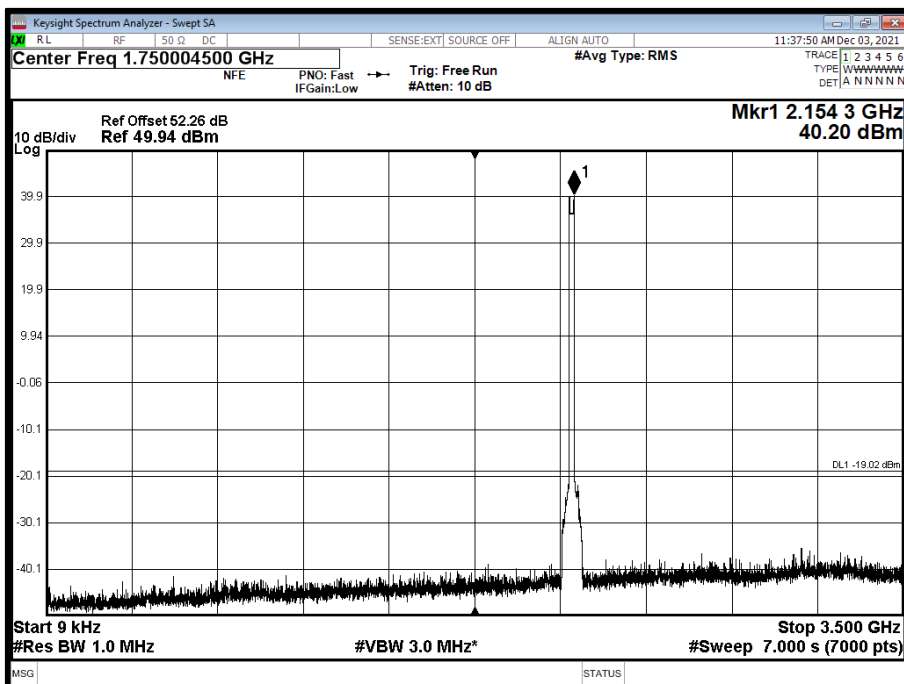



Antenna A - NR Modulation QPSK - NR Carrier Bandwidth 20.0 MHz 15 kHz SCS - Channel Position M - Band 2 - Range 3500 to 8000 MHz

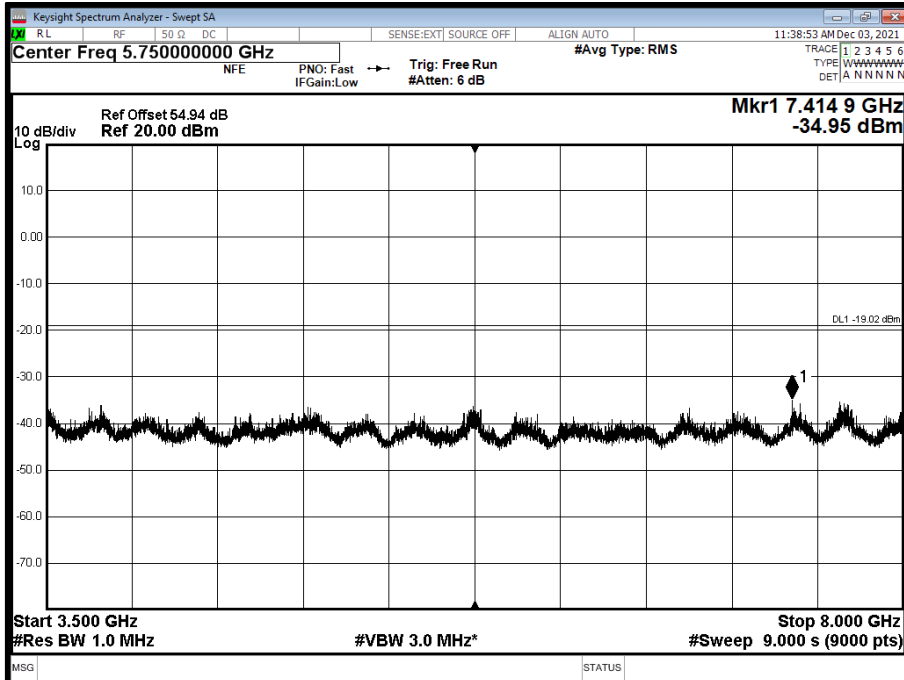

Antenna A - NR Modulation QPSK - NR Carrier Bandwidth 20.0 MHz 15 kHz SCS - Channel Position M - Band 3 - Range 8000 to 12000 MHz

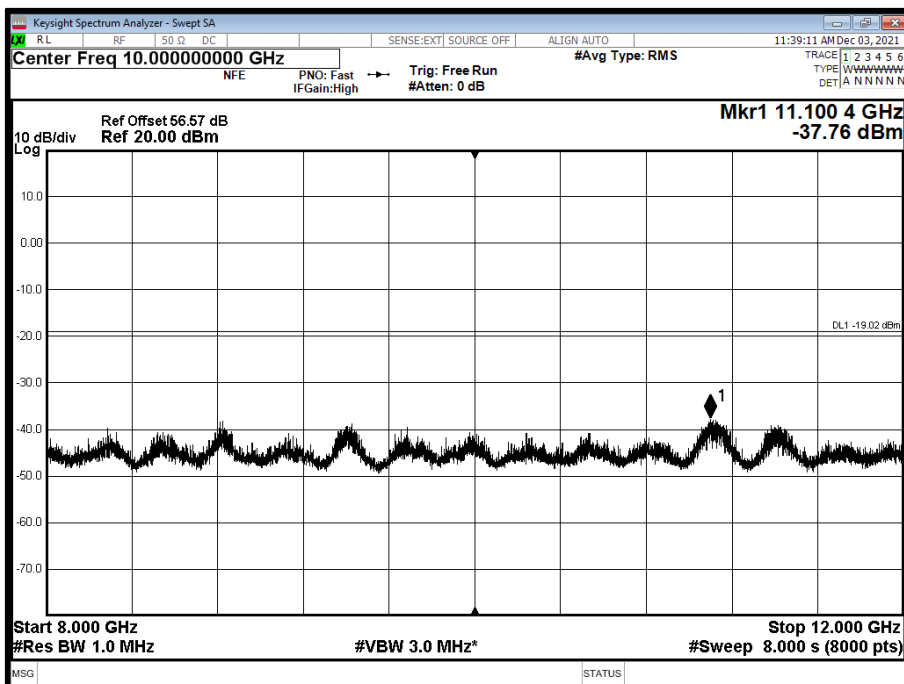



Antenna A - NR Modulation QPSK - NR Carrier Bandwidth 20.0 MHz 15 kHz SCS - Channel Position M - Band 4 - Range 12000 to 18000 MHz

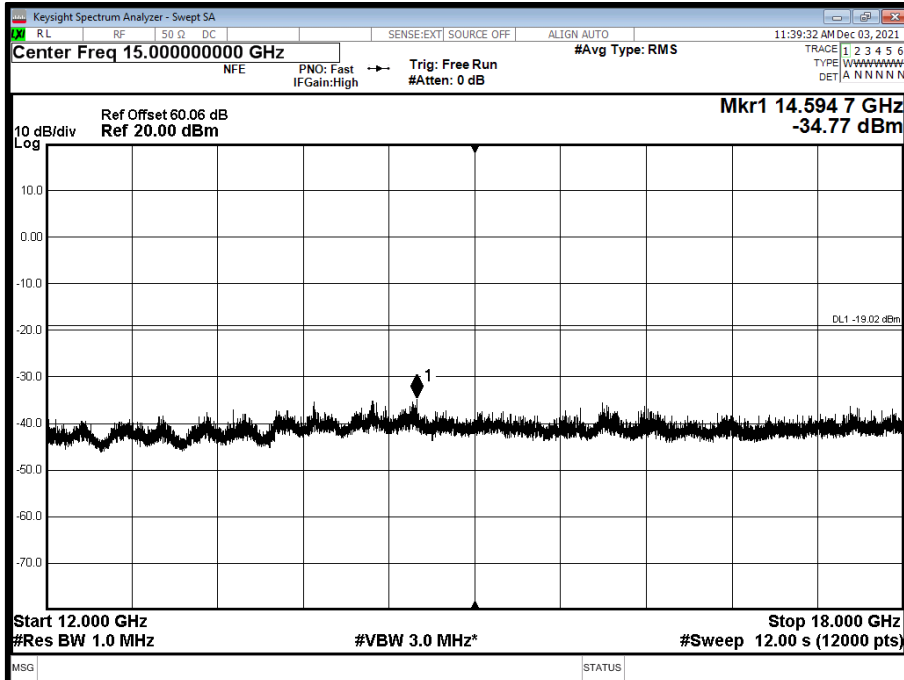

Antenna A - NR Modulation QPSK - NR Carrier Bandwidth 20.0 MHz 15 kHz SCS - Channel Position M - Band 5 - Range 18000 to 22000 MHz

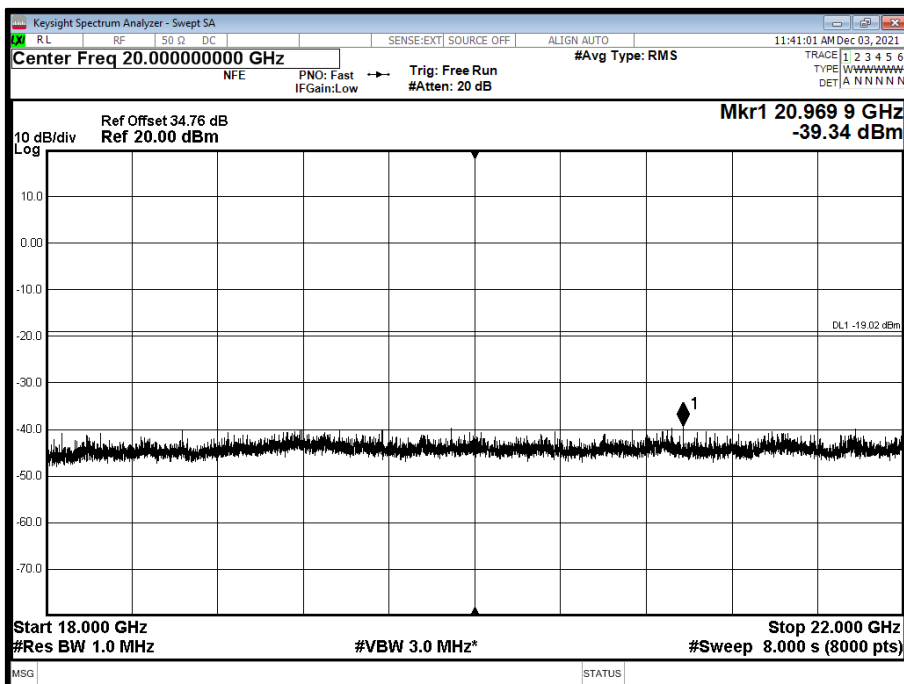



Antenna A - NR Modulation QPSK - NR Carrier Bandwidth 20.0 MHz 15 kHz SCS - Channel Position T - Band 1 - Range 0.009 to 3500 MHz

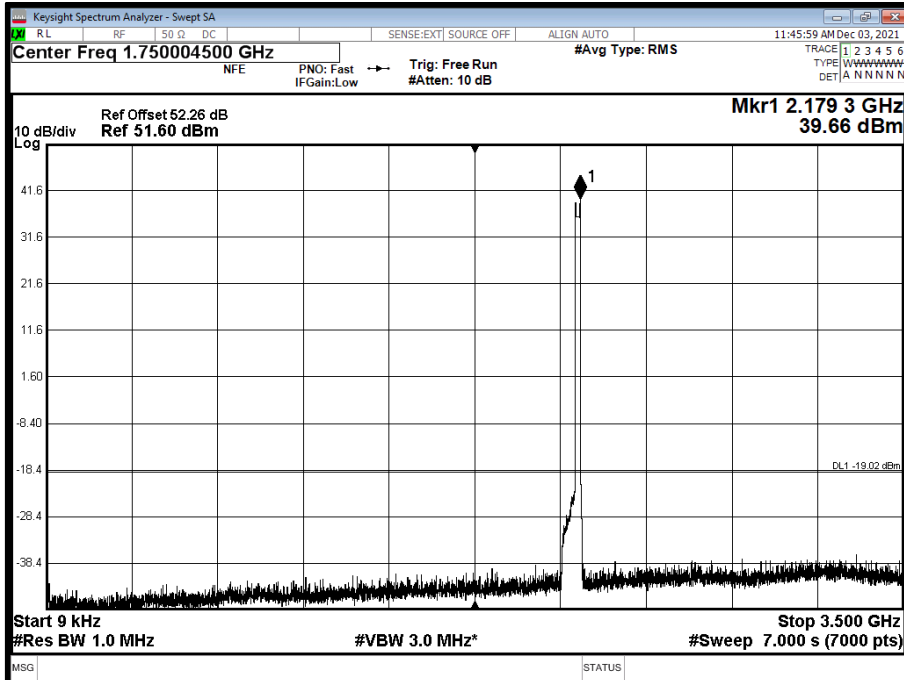

Antenna A - NR Modulation QPSK - NR Carrier Bandwidth 20.0 MHz 15 kHz SCS - Channel Position T - Band 2 - Range 3500 to 8000 MHz

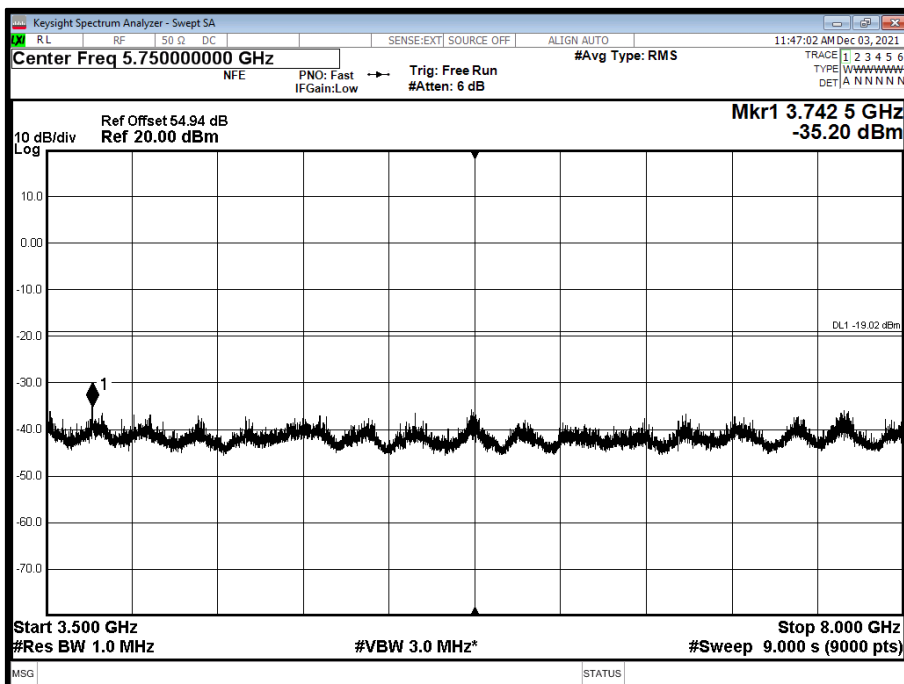



Antenna A - NR Modulation QPSK - NR Carrier Bandwidth 20.0 MHz 15 kHz SCS - Channel Position T - Band 3 - Range 8000 to 12000 MHz

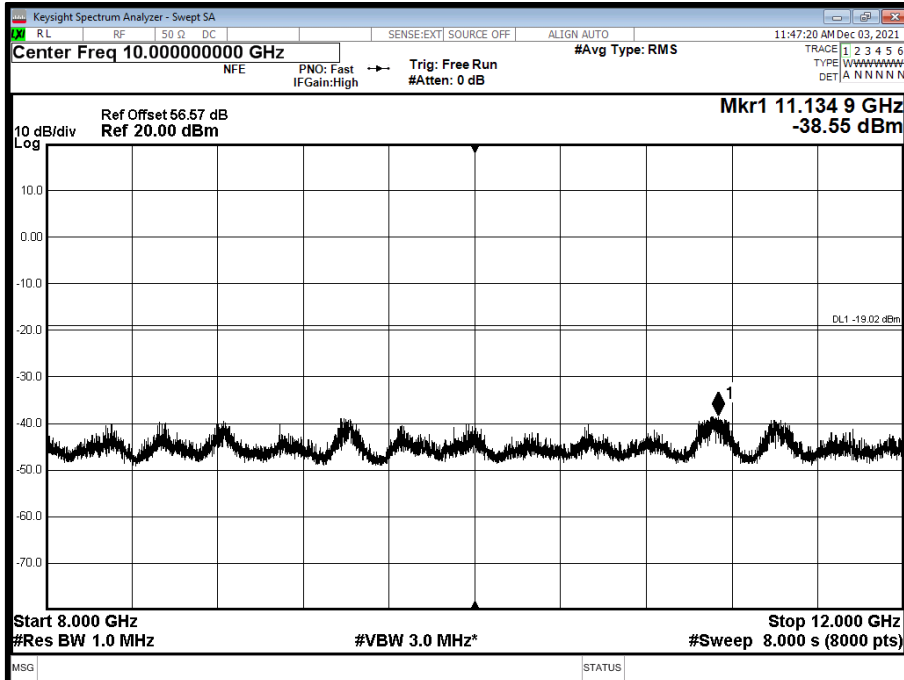

Antenna A - NR Modulation QPSK - NR Carrier Bandwidth 20.0 MHz 15 kHz SCS - Channel Position T - Band 4 - Range 12000 to 18000 MHz

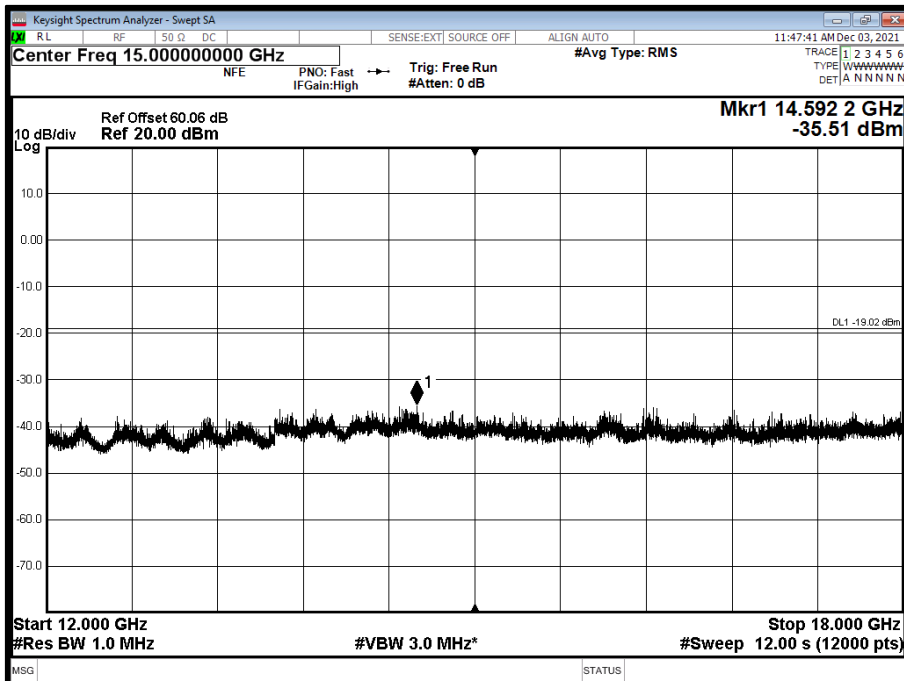



Antenna A - NR Modulation QPSK - NR Carrier Bandwidth 20.0 MHz 15 kHz SCS - Channel Position T - Band 5 - Range 18000 to 22000 MHz

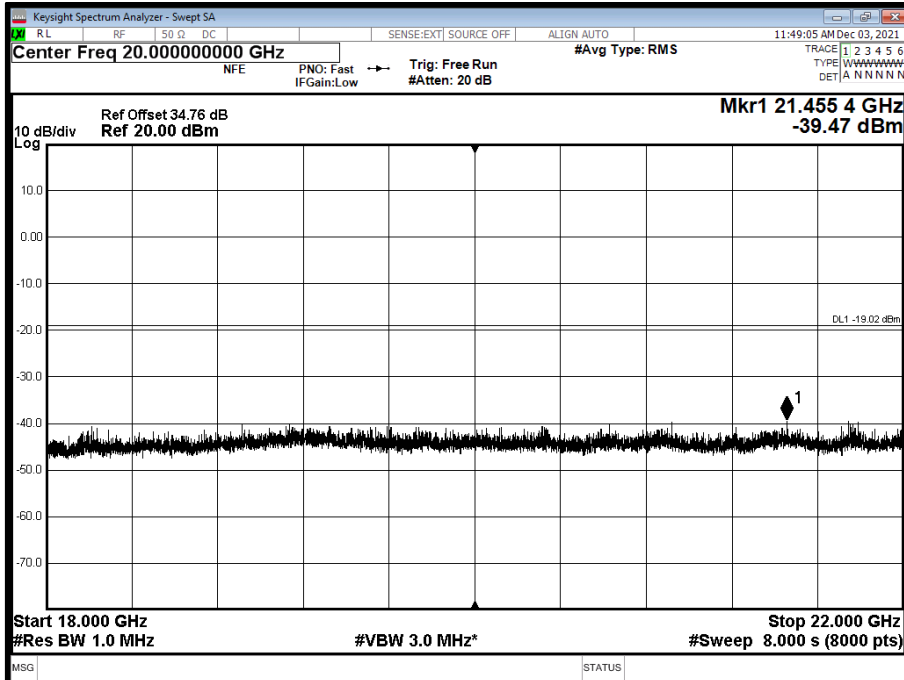

Limit	-19dBm
-------	--------



2.5 RADIATED EMISSIONS

2.5.1 Specification Reference

FCC CFR 47 Part 27, Clause 27.53
FCC CFR 47 Part 2, Clause 2.1053

2.5.2 Date of Test and Modification State

26-January-2022 - Modification State 0

2.5.3 Test Equipment Used

The major items of test equipment used for the above tests are identified in Section 3.1.

2.5.4 Environmental Conditions

Ambient Temperature	23.4°C
Relative Humidity	26%

2.5.5 Test Method

The test was performed in accordance with ANSI C63.26 Clause 5. The EUT was configured as defined in ANSI C63.26, clause 5.5.2.3.2.

As a result of the conducted measurements that were performed on the EUT, it was established that 10 MHz was the bandwidth configuration which gave the highest output power and therefore deemed to be worst case operating mode. Testing was performed on the Top, Middle and Bottom channels for single carrier

The EUT was set up on a support replicating typical installation conditions at a height of 0.8 m above the reference ground plane for measurements below 1GHz, (see setup photos) within a semi-anechoic chamber on a remotely controlled turntable. Above 1 GHz, the height was increased to 1.5 m above the reference ground plane.

Pre-scan and final measurements were made using a Field Strength method in accordance with ANSI C63.26 Clause 5.5.4. The readings were maximized by adjusting the antenna height, polarization and turntable azimuth, in accordance with the specification. Final results were then converted to eirp and are displayed in the plots below. The correction for field strength measurements to eirp at 3 m was 95.2 dB. An RBW of 1 MHz and VBW of 3 MHz was used for all measurements with a Peak detector and trace set to Max Hold. In all cases below where the limit line is exceeded – this is the intentional transmit frequency.

2.5.6 Test Results



Configuration 1

Maximum Output Power 49.00 dBm

Frequency (MHz)	Level (dBm)	Limit (dBm)	Margin (dB)	Detector	Angle (°)	Height (cm)	Polarisation
*							

Bot - NR&NB-IoT - B66A, 2115MHz, 30 MHz to 22 GHz

*No emissions found within 6 dB of the limit.

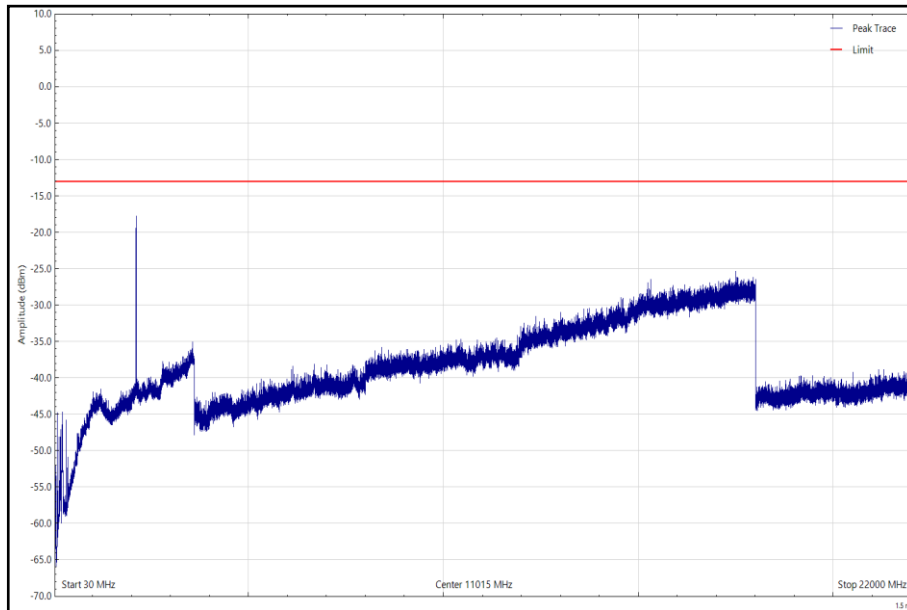

Bot - NR&NB-IoT - B66A, 2115MHz, 30 MHz to 22 GHz, Horizontal (Peak)

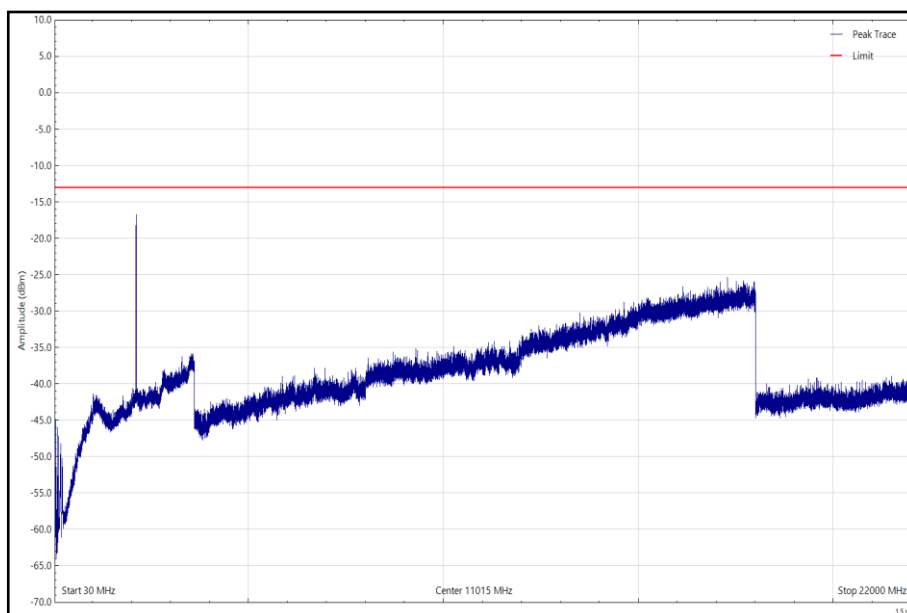

Bot - NR&NB-IoT - B66A, 2115MHz, 30 MHz to 22 GHz, Vertical (Peak)



Frequency (MHz)	Level (dBm)	Limit (dBm)	Margin (dB)	Detector	Angle (°)	Height (cm)	Polarisation
*							

Mid - NR&NB-IoT - B66A, 2145MHz, 30 MHz to 22 GHz

*No emissions found within 6 dB of the limit.

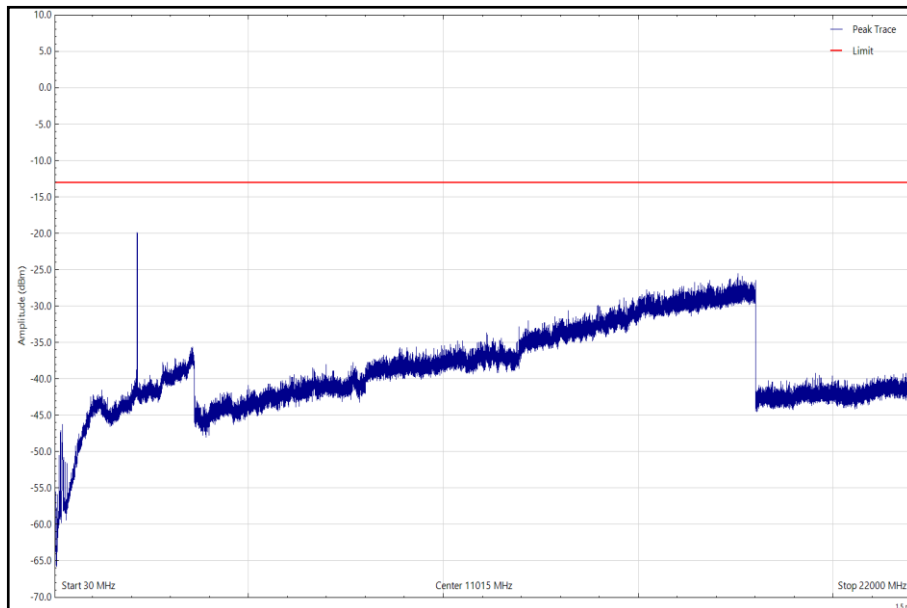

Mid - NR&NB-IoT - B66A, 2145MHz, 30 MHz to 22 GHz, Horizontal (Peak)

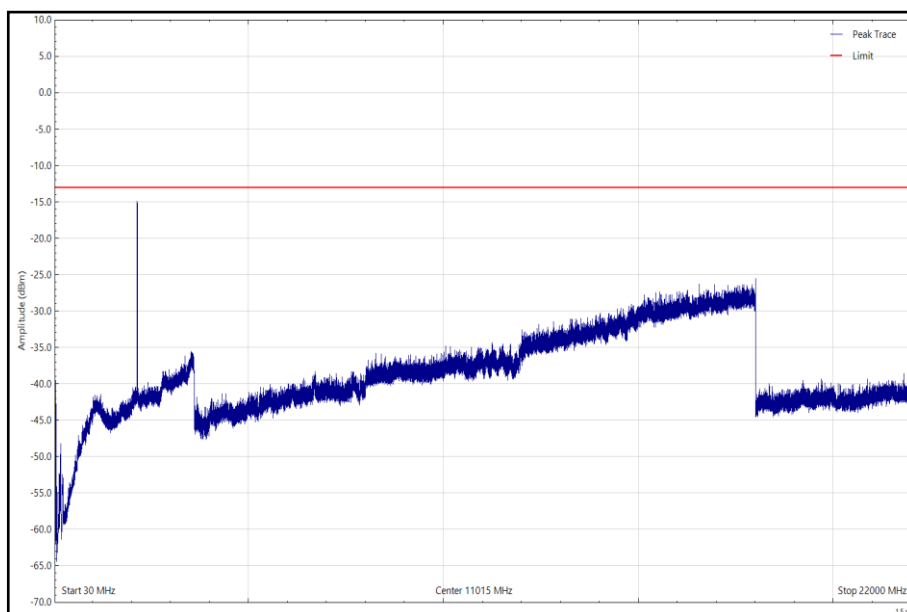

Mid - NR&NB-IoT - B66A, 2145MHz, 30 MHz to 22 GHz, Vertical (Peak)



Frequency (MHz)	Level (dBm)	Limit (dBm)	Margin (dB)	Detector	Angle (°)	Height (cm)	Polarisation
*							

Top - NR&NB-IoT - B66A, 2175MHz, 30 MHz to 22 GHz

*No emissions found within 6 dB of the limit.

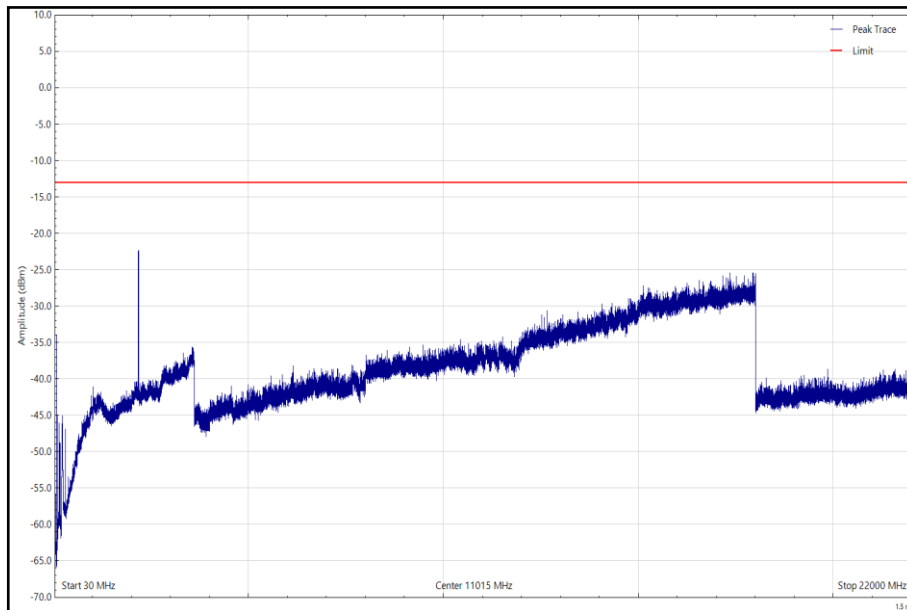

Top - NR&NB-IoT - B66A, 2175MHz, 30 MHz to 22 GHz, Horizontal (Peak)

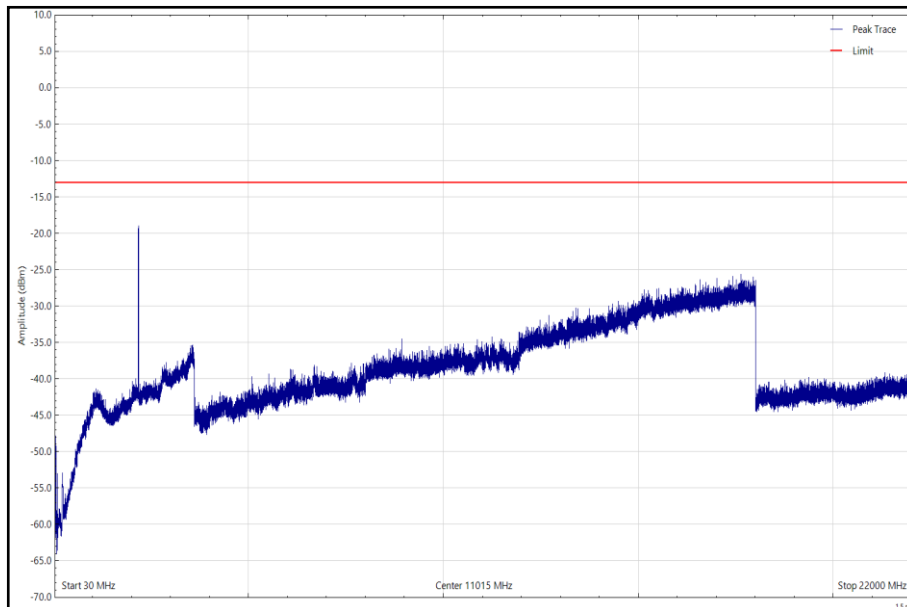

Top - NR&NB-IoT - B66A, 2175MHz, 30 MHz to 22 GHz, Vertical (Peak)

Limit

The power of any emission outside of the authorized operating frequency ranges must be attenuated below the transmitting power (P) by a factor of at least $43 + 10 \log(P)$ db.	$46 - (43 + 10 \log 49)$ = -13.9 dBm
--	---



SECTION 3

TEST EQUIPMENT USED



3.1 TEST EQUIPMENT USED

List of absolute measuring and other principal items of test equipment.

Instrument	Manufacturer	Type No.	TE No.	Calibration Period (months)	Calibration Due
Maximum Peak Output Power and Peak to Average Ratio - Conducted					
Hygrometer	PCE Instruments	PCE-THB-40	5475	12	06-Apr-2022
Rubidium Standard	Rohde & Schwarz	XSRM	1316	6	03-Dec-2021
Frequency Standard	Spectracom	SecureSync 1200-0408-0601	4393	6	03-Jan-2022
Analyser	Keysight	N9030A	4654	12	24-Nov-2022
Power Supply	Farnell	H60-25	1092	-	OP-MON
Multimeter	Fluke	79 Series II	3057	12	23-Aug-2022
Attenuator	Weinschel	48-40-43-LIM	5134	12	03-Dec-2021
Attenuator	Aeroflex / Weinschel	47-10-34	3166	12	13-Sep-2022
Network Analyser	Rohde & Schwarz	ZVA 40	3548	12	29-Jan-2022
Calibration Unit	Rohde & Schwarz	ZV-Z54	4368	12	30-Dec-2021
Occupied Bandwidth					
Hygrometer	PCE Instruments	PCE-THB-40	5475	12	06-Apr-2022
Rubidium Standard	Rohde & Schwarz	XSRM	1316	6	03-Dec-2021
Frequency Standard	Spectracom	SecureSync 1200-0408-0601	4393	6	03-Jan-2022
Analyser	Keysight	N9030A	4654	12	24-Nov-2022
Power Supply	Farnell	H60-25	1092	-	OP-MON
Multimeter	Fluke	79 Series II	3057	12	23-Aug-2022
Attenuator	Weinschel	48-40-43-LIM	5134	12	03-Dec-2021
Attenuator	Aeroflex / Weinschel	47-10-34	3166	12	13-Sep-2022
Network Analyser	Rohde & Schwarz	ZVA 40	3548	12	29-Jan-2022
Calibration Unit	Rohde & Schwarz	ZV-Z54	4368	12	30-Dec-2021
Band Edge					
Hygrometer	PCE Instruments	PCE-THB-40	5475	12	06-Apr-2022
Rubidium Standard	Rohde & Schwarz	XSRM	1316	6	03-Dec-2021
Frequency Standard	Spectracom	SecureSync 1200-0408-0601	4393	6	03-Jan-2022
Analyser	Keysight	N9030A	4654	12	24-Nov-2022
Power Supply	Farnell	H60-25	1092	-	OP-MON
Multimeter	Fluke	79 Series II	3057	12	23-Aug-2022
Attenuator	Weinschel	48-40-43-LIM	5134	12	03-Dec-2021
Attenuator	Aeroflex / Weinschel	47-10-34	3166	12	13-Sep-2022
Network Analyser	Rohde & Schwarz	ZVA 40	3548	12	29-Jan-2022
Calibration Unit	Rohde & Schwarz	ZV-Z54	4368	12	30-Dec-2021



Instrument	Manufacturer	Type No.	TE No.	Calibration Period (months)	Calibration Due
Transmitter Spurious Emissions					
Hygrometer	PCE Instruments	PCE-THB-40	5475	12	06-Apr-2022
Rubidium Standard	Rohde & Schwarz	XSRM	1316	6	03-Dec-2021
Frequency Standard	Spectracom	SecureSync 1200-0408-0601	4393	6	03-Jan-2022
Analyser	Keysight	N9030A	4654	12	24-Nov-2022
Power Supply	Farnell	H60-25	1092	-	OP-MON
Multimeter	Fluke	79 Series II	3057	12	23-Aug-2022
Attenuator	Weinschel	48-40-43-LIM	5134	12	03-Dec-2021
Attenuator	Aeroflex / Weinschel	47-10-34	3166	12	13-Sep-2022
Network Analyser	Rohde & Schwarz	ZVA 40	3548	12	29-Jan-2022
Calibration Unit	Rohde & Schwarz	ZV-Z54	4368	12	30-Dec-2021
HPF	Advance Power Components	11SH10-3000/X18000-O/O	4411	12	02-Jul-2022
Cable	Junkosha	MWX241-01000KMS	5414	12	23-Jun-2022
Cable	Rosenberger	LU1-001-2000	5020	12	07-Jan-2022
Waveguide filter	Quasar	QWS20SB-UBR-UBR-50	5789	12	04-May-2022
WG20 Coaxial Adapter	Quasar	QWC20SB-UBR-K-F	5785	-	OP-MON
WG20 Coaxial Adapter	Quasar	QWC20SB-UBR-K-F	5786	-	OP-MON
Cable attenuator	Aralab	CSF6767C-C2S6500	5175	-	OP-MON
Radiated Emissions					
Antenna (DRG, 18 GHz to 40 GHz)	Link Microtek Ltd	AM180HA-K-TU2	230	24	27-Jul-2022
Antenna with attenuator (Bilog, 30 MHz to 3 GHz)	Schaffner	CBL6143	287	24	14-Oct-2022
Pre-Amplifier (8 GHz to 18 GHz)	Phase One	PS04-0086	1533	12	05-Feb-2022
Pre-Amplifier (18 GHz to 40 GHz)	Phase One	PSO4-0087	1534	12	02-Aug-2022
Comb Generator	Schaffner	RSG1000	3034	-	TU
Multimeter	Fluke	79 Series II	3057	12	23-Aug-2022
Test Receiver	Rohde & Schwarz	ESU40	3506	12	18-Mar-2022
Cable 1503 2M 2.92(P)m 2.92(P)m	Rhophase	KPS-1503A-2000-KPS	4293	12	18-Nov-2022
Cable (K-Type to K-Type, 2 m)	Scott Cables	KPS-1501-2000-KPS	4526	6	06-Mar-2022
Cable (N-Type to N-Type, 1 m)	Rosenberger	LU7-036-1000	5031	12	23-Jul-2022
Emissions Software	TUV SUD	EmX V2.1.11 V.2.1.11	5125	-	Software
DRG Horn Antenna (7.5-18GHz)	Schwarzbeck	HWRD750	5216	12	01-Apr-2022
Digital Multimeter	Keysight Technologies	U1282A	5320	12	25-Aug-2022
Cable (sma-sma, 2 m)	Junkosha	MWX221-02000DMS	5428	12	20-Oct-2022
Cable (N-Type to N-Type, 8 m)	Teledyne	PR90-088-8MTR	5450	6	08-Mar-2022
Thermo-Hygro-Barometer	PCE Instruments	PCE-THB-40	5481	12	31-Mar-2022
Cable (K-Type to K-Type, 1 m)	Junkosha	MWX241-01000KMSKMS/A	5511	12	09-Apr-2022
1m K-Type Cable	Junkosha	MWX241-01000KMSKMS/A	5512	12	09-Apr-2022
2m K Type Cable	Junkosha	MWX241-02000KMSKMS/A	5524	12	24-Mar-2022
Antenna (DRG, 7.5 GHz to 18 GHz)	Schwarzbeck	HWRD750	5610	12	15-Oct-2022
Antenna (DRG, 1 GHz to 10 GHz)	Schwarzbeck	BBHA 9120 B	5611	12	15-Oct-2022
Turntable & Mast Controller	Maturo Gmbh	NCD/498/2799.01	5612	-	TU
Tilt Antenna Mast	Maturo Gmbh	TAM 4.0-P	5613	-	TU
Turntable	Maturo Gmbh	Turntable 1.5 SI-2t	5614	-	TU
Antenna (Bi-Log, 30 MHz to 1 GHz)	Teseq	CBL6111D	5615	24	16-Oct-2022
Screened Room (12)	MVG	EMC-3	5621	36	11-Aug-2023

N/A – Not Applicable

O/P Mon – Output Monitored with Calibrated Equipment



3.2 MEASUREMENT UNCERTAINTY

For a 95% confidence level, the measurement uncertainties for defined systems are:-

Test Discipline	Frequency / Parameter	MU
Conducted Maximum Peak Output Power	9 kHz to 40 GHz Amplitude	± 1.0 dB
Conducted Emissions	9 kHz to 40 GHz Amplitude	± 3.5 dB
Occupied Bandwidth	10 MHz Bandwidth	± 16.7 kHz
	15 MHz Bandwidth	
	20 MHz Bandwidth	
Band Edge	< 3.6 GHz Amplitude	± 0.6 dB
Radiated Spurious Emissions	30 MHz to 1 GHz	± 5.2 dB
	1 GHz to 40 GHz	± 6.3 dB

Measurement Uncertainty Decision Rule

Determination of conformity with the specification limits is based on the decision rule according to IEC Guide 115:2007, Clause 4.4.3 and 4.5.1. (Procedure 2). The measurement results are directly compared with the test limit to determine conformance with the requirements of the standard.

Risk: The uncertainty of measurement about the measured result is negligible with regard to the final pass/fail decision. The measurement result can be directly compared with the test limit to determine conformance with the requirement (compare IEC Guide 115). The level of risk to falsely accept and falsely reject items is further described in ILAC-G8



3.3 MEASUREMENT SOFTWARE USED

List of measurement software versions used for testing.

Instrument	Manufacturer	Type No.	TE No.	Software Version
PXA Signal Analyser	Keysight	N9030B	4654	A22.08
HP-VEE Software	TUV SUD	HP_VEE	N/A	V3.28



SECTION 5

ACCREDITATION, DISCLAIMERS AND COPYRIGHT



4.1 ACCREDITATION, DISCLAIMERS AND COPYRIGHT

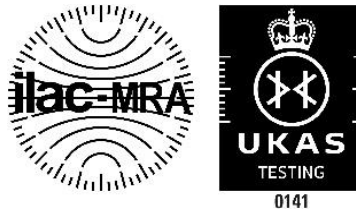

This report relates only to the actual item/items tested.

Our UKAS Accreditation does not cover opinions and interpretations and any expressed are outside the scope of our UKAS Accreditation.

Results of tests not covered by our UKAS Accreditation Schedule are marked NUA (Not UKAS Accredited).

© 2022 TÜV SÜD
TÜV SÜD

Postal Address :Octagon House, Concorde Way, Fareham, Hampshire, UK, PO15 5RL

ANNEX A

MODULE LIST

Configuration 1			
Product	Product No	R-State	Serial No
Radio 8843	KRC161 707/2	R1D	D16X961448
Software Version:	CXP9013268/15	Revision:	R89AJ