



**Add value.
Inspire trust.**



Report On

FCC Testing of the
Ericsson KRC 161 707/2 (Radio 8843 B2 B66A) NR (1900 MHz) Base
Station in accordance with FCC CFR 47 Part 2 and FCC CFR 47 Part
24

COMMERCIAL-IN-CONFIDENCE

FCC ID: TA8AKRC161707-2

PREPARED BY

A handwritten signature in black ink, appearing to read 'Maggie Whiting', written over a horizontal line.

Maggie Whiting
Key Account Manager

APPROVED BY

A handwritten signature in black ink, appearing to read 'Steve Scarfe', written over a horizontal line.

Steve Scarfe
Authorised Signatory

DATED

15 July 2019

Document 75946096 Report 07 Issue 1

July 2019



CONTENTS

Section	Page No
1	REPORT INFORMATION 2
1.1	Report Details 3
1.2	Brief Summary of Results 4
1.3	Configuration Description 5
1.4	Declaration of Build Status 6
1.5	Product Information 7
1.6	Test Setup 8
1.7	Test Conditions 9
1.8	Deviation From The Standard 9
1.9	Modification Record 9
1.10	Alternative Test Site 9
2	TEST DETAILS 10
2.1	Maximum Peak Output Power and Peak to Average Ratio - Conducted 11
2.2	Occupied Bandwidth 15
2.3	Band Edge 22
2.4	Transmitter Spurious Emissions 28
3	TEST EQUIPMENT USED 33
3.1	Test Equipment Used 34
3.2	Measurement Uncertainty 35
4	ACCREDITATION, DISCLAIMERS AND COPYRIGHT 36
4.1	Accreditation, Disclaimers and Copyright 37
ANNEX A	Module Lists A.2



SECTION 1

REPORT INFORMATION



1.1 REPORT DETAILS

Manufacturer	Ericsson
Address	Torshamnsgatan 23 Kista SE-16480 Stockholm Sweden
Product Name & Product Number	Radio 8842 B2 & KRC 161 707/2
Serial Number(s)	D16X996678
Software Version	CXP9013268_15 Revision R79CL
Hardware Version	R1D
Test Specification/Issue/Date	FCC CFR 47 Part 2: 2018 FCC CFR 47 Part 24: 2018 Industry Canada RSS-GEN: Issue 5 Amdt 1: 2019 Industry Canada RSS-133: Issue 6: 2013, Amdt Jan 2018
Start of Test	28 June 2019
Finish of Test	28 June 2019
Name of Engineer(s)	Brian Scarfe
Related Document(s)	KDB 971168 D01 v02r02 KDB 662911 D01 v02r01

ENGINEERING STATEMENT

The measurements shown in this report were made in accordance with the procedures described on test pages. All reported testing was carried out on a sample equipment to demonstrate compliance with FCC CFR 47 Part 24. The sample tested was found to comply with the requirements defined in the applied rules.

Test Engineer(s);

A handwritten signature in black ink, appearing to read 'Brian Scarfe', written over a horizontal line.

Brian Scarfe



1.2 BRIEF SUMMARY OF RESULTS

A brief summary of results for each configuration, in accordance with FCC CFR 47 Part 2 and FCC CFR 47 Part 24 is shown below.

Section	Specification Clause		Test Description	Result
	FCC CFR 47 Part 2	FCC CFR 47 Part 24		
2.1	2.1046	24.232 (a)	Maximum Peak Output Power and Peak to Average Ratio - Conducted	Pass
2.2	2.1049	24.238 (b)	Occupied Bandwidth	Pass
2.3	2.1051	24.238 (b)	Band Edge	Pass
2.4	2.1051	24.238 (a)	Transmitter Spurious Emissions	Pass

Measurement Uncertainty Decision Statement

Determination of conformity with the specification limits is based on the results of the compliance measurement and does not take into account measurement instrumentation uncertainty as defined in ANSI C63.26:2015 Clause 1.3.



1.3 CONFIGURATION DESCRIPTION

Configuration	RAT	No. Of carriers	Carrier Bandwidth	Carrier Frequency Configuration (MHz)		
				Bottom	Middle	Top
A	NR	1	5 MHz – SCS 15kHz	1932.5	-	1987.5
	NR	1	10 MHz – SCS 15kHz	1935.0	-	1985.0
	NR	1	15 MHz – SCS 15kHz	1937.5	-	1982.5
	NR	1	20 MHz – SCS 15kHz	1940.0	-	1980.0
	NR	1	20 MHz – SCS 60kHz	1940.0	-	1980.0
	NR	1	20 + 20 MHz – SCS 15kHz	-	1950.0+1970.0	-



1.4 DECLARATION OF BUILD STATUS

MAIN EUT	
MANUFACTURING DESCRIPTION	Radio Unit
MANUFACTURER	Ericsson AB
PRODUCT NAME	Radio 8843 B2 B66A
PART NUMBER	KRC161707/2
IC Model Name	NA
SERIAL NUMBER	D16X996678
HARDWARE VERSION	R1D
SOFTWARE VERSION	CXP9013268_15 R79CL
TRANSMITTER OPERATING RANGE	B2: 1930-1990 MHz B66A: 2110-2180 MHz.
MODULATIONS	NR & LTE: QPSK 16QAM 64QAM 256QAM
ITU DESIGNATION OF EMISSION	B2 LTE 5 MHz BW channel: 4M51W7D B2 LTE 10 MHz BW channel: 8M96W7D B2 LTE 15 MHz BW channel: 13M5W7D B2 LTE 20 MHz BW channel: 17M9W7D B2 LTE 20+20 MHz BW channel CA: 37M8W7D B66A LTE 5 MHz BW channel: 4M51W7D B66A LTE 10 MHz BW channel: 8M96W7D B66A LTE 15 MHz BW channel: 13M5W7D B66A LTE 20 MHz BW channel: 17M9W7D B66A LTE 20+20 MHz BW channel CA: 37M8W7D B2 NR 5 MHz BW channel: 4M47W7D B2 NR 10 MHz BW channel: 9M29W7D B2 NR 15 MHz BW channel: 14M1W7D B2 NR 20 MHz BW channel: 17M3W7D B2 NR 20+20 MHz BW channel CA: 38M8W7D B66A NR 5 MHz BW channel: 4M47W7D B66A NR 10 MHz BW channel: 9M29W7D B66A NR 15 MHz BW channel: 14M1W7D B66A NR 20 MHz BW channel: 17M3W7D B66A NR 20+20 MHz BW channel: 38M8W7D
OUTPUT POWER (RMS) (W or dBm)	B2: 4x40W or 2x60W B66A: 4x60W or 2x80W
FCC ID	TA8AKRC161707-2
IC ID	NA
TECHNICAL DESCRIPTION (a brief description of the intended use and operation)	Base station radio

Signature Audun B Helle
Audun Helle

Date 2019-07-12

No responsibility will be accepted by TÜV SÜD Product Service UK Limited as to the accuracy of the information declared in this document by the manufacturer.

1.5 PRODUCT INFORMATION

1.5.1 Technical Description

The Equipment Under Test (EUT) Radio 8843 B2 is an Ericsson AB Radio Unit working in the public mobile service 1900 MHz band which provides communication connections to 1900 MHz network. The Radio 8843 B2 operates from a -48 V DC and 240V AC supply.

The Equipment Under Test (EUT) is shown in the photograph below. A full technical description can be found in the Manufacturer's documentation.

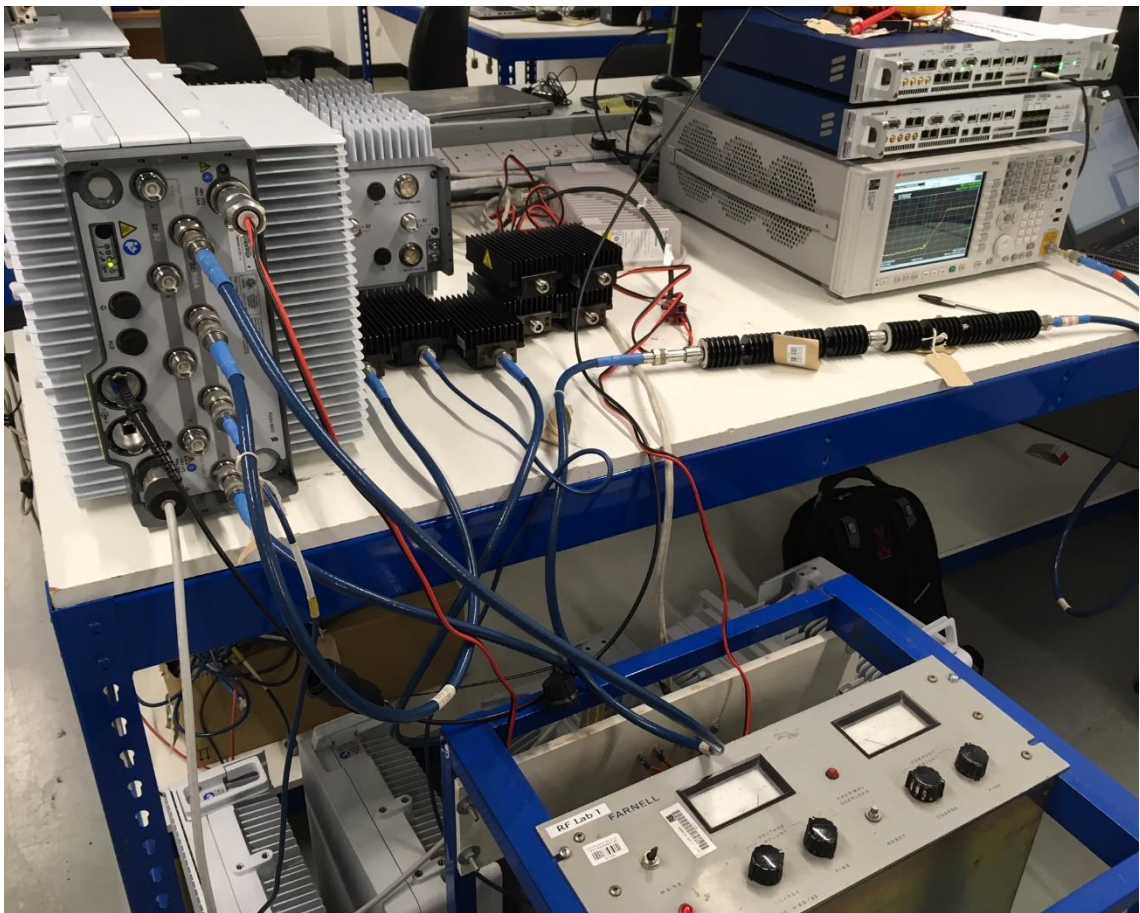

Equipment Under Test



1.6 TEST SETUP

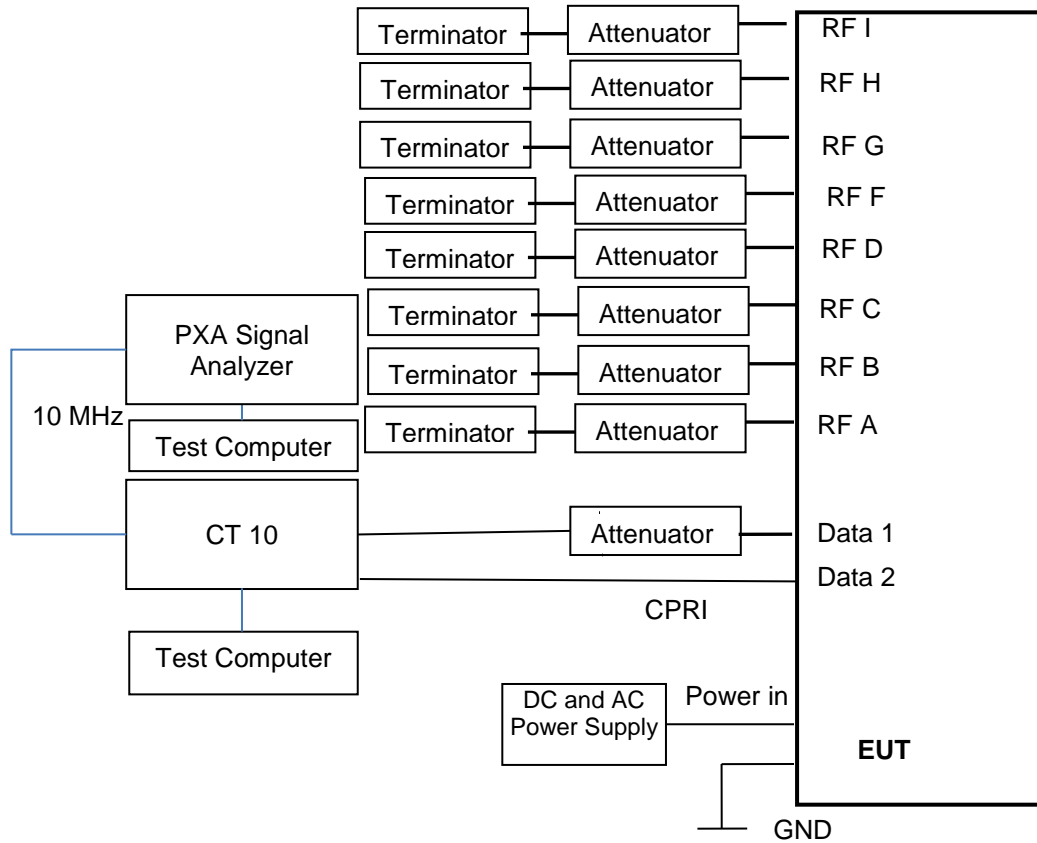



1.7 TEST CONDITIONS

For all tests the EUT was set up in accordance with the relevant test standard and to represent typical operating conditions. Tests were applied with the EUT situated in a shielded enclosure, test laboratories or a chamber as appropriate.

The EUT was powered from a -48V DC and 240V AC Supply.

FCC Measurement Facility Registration Number
90987 Octagon House, Fareham Test Laboratory

1.8 DEVIATION FROM THE STANDARD

No deviations from the applicable test standards or test plan were made during testing.

1.9 MODIFICATION RECORD

No modifications were made to the EUT during testing.

1.10 ALTERNATIVE TEST SITE

Under our group UKAS Accreditation, TÜV SÜD conducted the following tests at Ericsson in Fareham, UK.

Test Name	Name of Engineer(s)
Maximum Peak Output Power and Peak to Average Ratio - Conducted	Brian Scarfe
Occupied Bandwidth	Brian Scarfe
Band Edge	Brian Scarfe
Transmitter Spurious Emissions	Brian Scarfe



SECTION 2

TEST DETAILS



2.1 MAXIMUM PEAK OUTPUT POWER AND PEAK TO AVERAGE RATIO - CONDUCTED

2.1.1 Specification Reference

FCC CFR 47 Part 2, Clause 2.1046
 FCC CFR 47 Part 24, Clause 24.232 (a)

2.1.2 Date of Test and Modification State

28 June 2019 - Modification State 0

2.1.3 Test Equipment Used

The major items of test equipment used for the above tests are identified in Section 3.1.

2.1.4 Environmental Conditions

Ambient Temperature 24.3°C
 Relative Humidity 38.4%

2.1.5 Test Method

All measurements were made in accordance with FCC KDB 971168 D01, clause 5.2.1 and summed in accordance with FCC KDB 662911 D01.

2.1.6 Test Results

Configuration A

Maximum Output Power 47.8 dBm

Antenna	NR Modulation	NR Carrier Bandwidth	Peak to Average Ratio (PAR) / Output Power		
			Channel Position B		
			PAR (dB)	Average Power	
dBm	dBm/MHz				
A	QPSK	5.0 MHz 15 kHz SCS	6.77	47.03	41.11
A	QPSK	10.0 MHz 15 kHz SCS	-	47.15	-
A	QPSK	15.0 MHz 15 kHz SCS	-	47.06	-
A	QPSK	20.0 MHz 15 kHz SCS	-	47.14	-
A	QPSK	20.0 MHz 60 kHz SCS	-	47.27	-



Antenna A - NR Modulation QPSK - NR Carrier Bandwidth 5.0 MHz 15 kHz SCS - Channel Position B

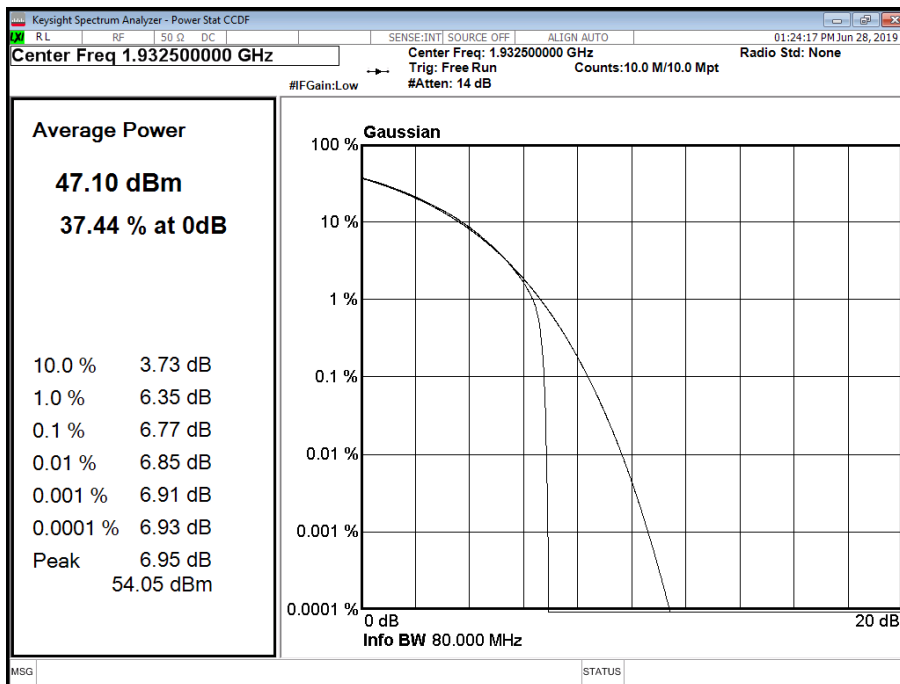

Configuration A

Maximum Output Power 47.8 dBm

Antenna	NR Modulation	NR Carrier Bandwidth	Peak to Average Ratio (PAR) / Output Power		
			Channel Position M		
			PAR (dB)	Average Power	
dBm	dBm/MHz				
A	QPSK	20.0 + 20.0 MHz 15 kHz SCS	-	47.42	-



Antenna A - NR Modulation QPSK - NR Carrier Bandwidth 20.0 + 20.0 MHz 15 kHz SCS - Channel Position M

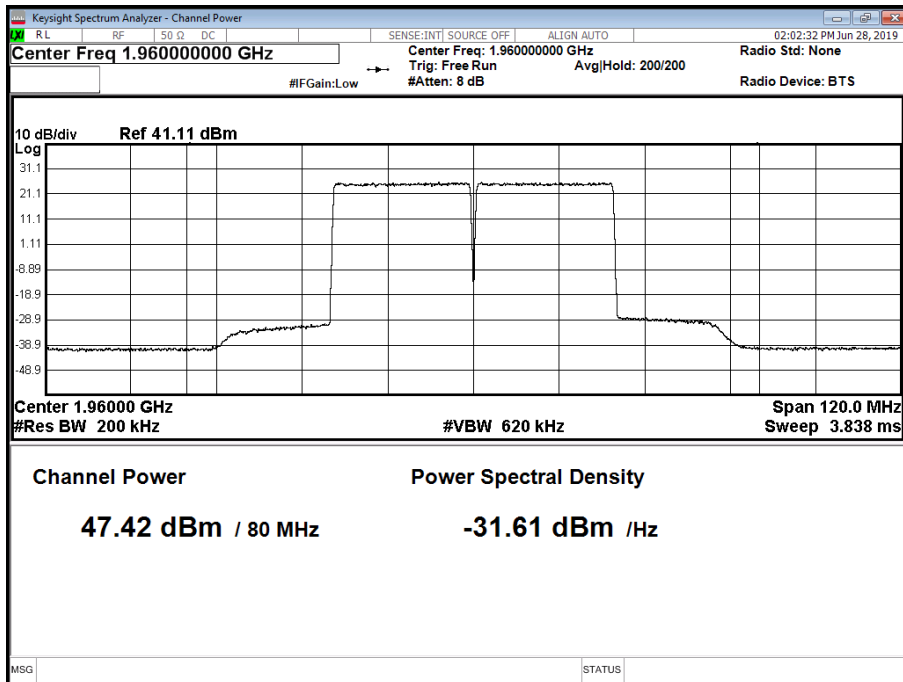

Configuration A

Maximum Output Power 47.8 dBm

Antenna	NR Modulation	NR Carrier Bandwidth	Peak to Average Ratio (PAR) / Output Power		
			Channel Position T		
			PAR (dB)	Average Power	
dBm	dBm/MHz				
A	QPSK	5.0 MHz 15 kHz SCS	6.76	46.92	41.02
A	QPSK	10.0 MHz 15 kHz SCS	-	47.11	-
A	QPSK	15.0 MHz 15 kHz SCS	-	47.00	-
A	QPSK	20.0 MHz 15 kHz SCS	-	47.23	-
A	QPSK	20.0 MHz 60 kHz SCS	-	47.26	-



Antenna A - NR Modulation QPSK - NR Carrier Bandwidth 5.0 MHz 15 kHz SCS - Channel Position T

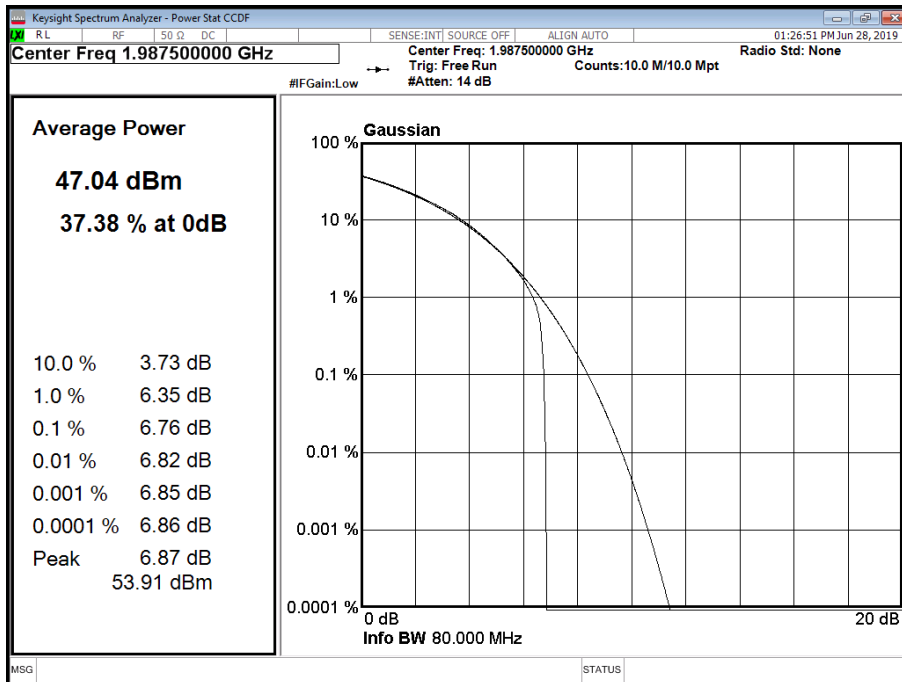

Limit	
Peak Power	≤500 W or ≤+57 dBm
Peak to Average Ratio	13 dB



2.2 OCCUPIED BANDWIDTH

2.2.1 Specification Reference

FCC CFR 47 Part 2, Clause 2.1049
 FCC CFR 47 Part 24, Clause 24.238 (b)

2.2.2 Date of Test and Modification State

28 June 2019 - Modification State 0

2.2.3 Test Equipment Used

The major items of test equipment used for the above tests are identified in Section 3.1.

2.2.4 Environmental Conditions

Ambient Temperature 24.3°C
 Relative Humidity 38.4%

2.2.5 Test Method

All measurements were made in accordance with FCC KDB 971168 D01.

2.2.6 Test Results

Configuration A

Maximum Output Power 47.8 dBm

Antenna	NR Modulation	NR Carrier Bandwidth	Result (KHz)					
			Channel Position B		Channel Position M		Channel Position T	
			Occupied Bandwidth	-26 dB Bandwidth	Occupied Bandwidth	-26 dB Bandwidth	Occupied Bandwidth	-26 dB Bandwidth
A	QPSK	5.0 MHz 15 kHz SCS	4,467.63	4,824.77	-	-	4,465.04	4,810.68
A	QPSK	10.0 MHz 15 kHz SCS	9,281.45	9,744.06	-	-	9,284.63	9,784.73
A	QPSK	15.0 MHz 15 kHz SCS	14,106.72	14,756.89	-	-	14,091.05	14,734.05
A	QPSK	20.0 MHz 15 kHz SCS	18,888.99	19,789.32	-	-	18,929.94	19,772.99
A	QPSK	20.0 MHz 60 kHz SCS	17,312.88	19,545.54	-	-	17,285.24	19,608.17
A	QPSK	20.0 + 20.0 MHz 15 kHz SCS	-	-	38,774.34	39,900.30	-	-



Antenna A - NR Modulation QPSK - NR Carrier Bandwidth 5.0 MHz 15 kHz SCS - Channel Position B

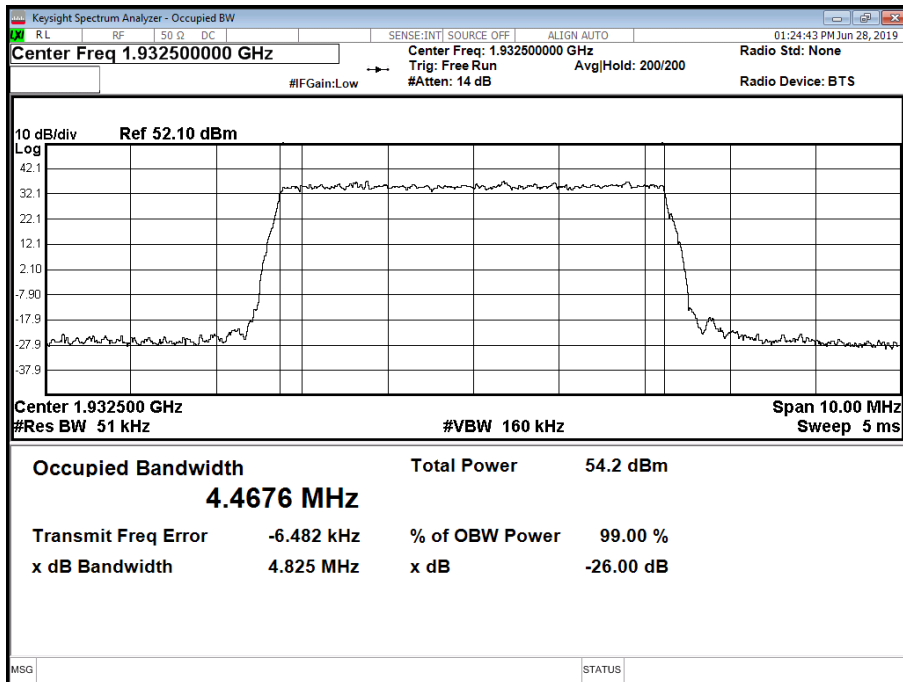

Antenna A - NR Modulation QPSK - NR Carrier Bandwidth 5.0 MHz 15 kHz SCS - Channel Position T

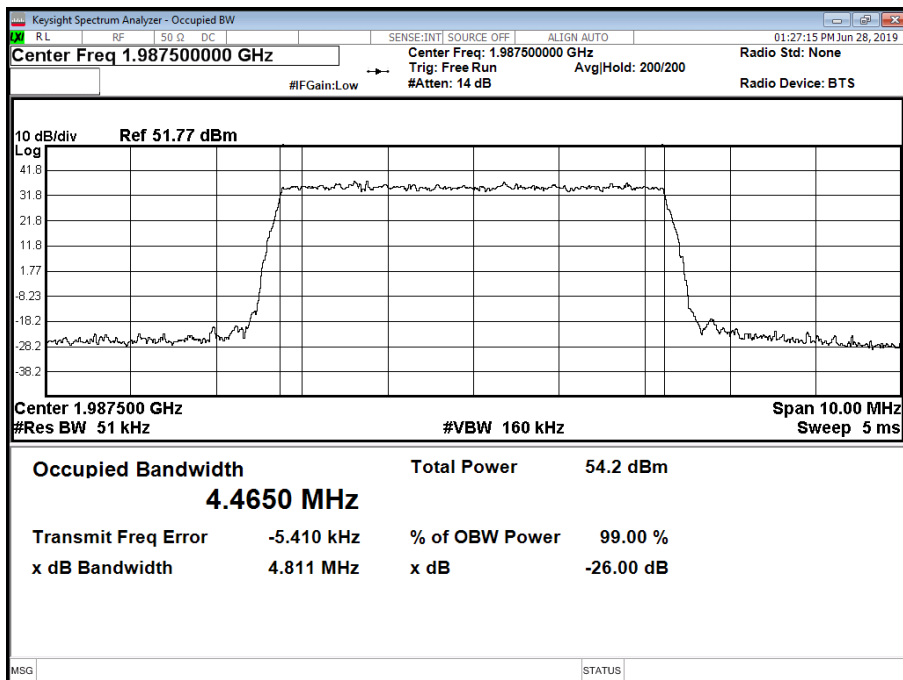



Antenna A - NR Modulation QPSK - NR Carrier Bandwidth 10.0 MHz 15 kHz SCS - Channel Position B

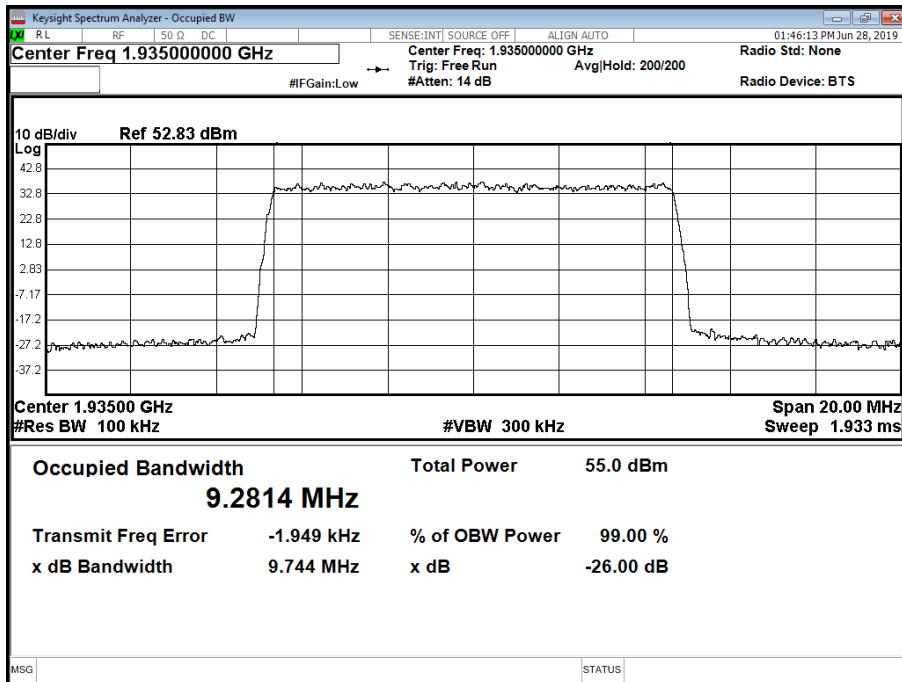

Antenna A - NR Modulation QPSK - NR Carrier Bandwidth 10.0 MHz 15 kHz SCS - Channel Position T

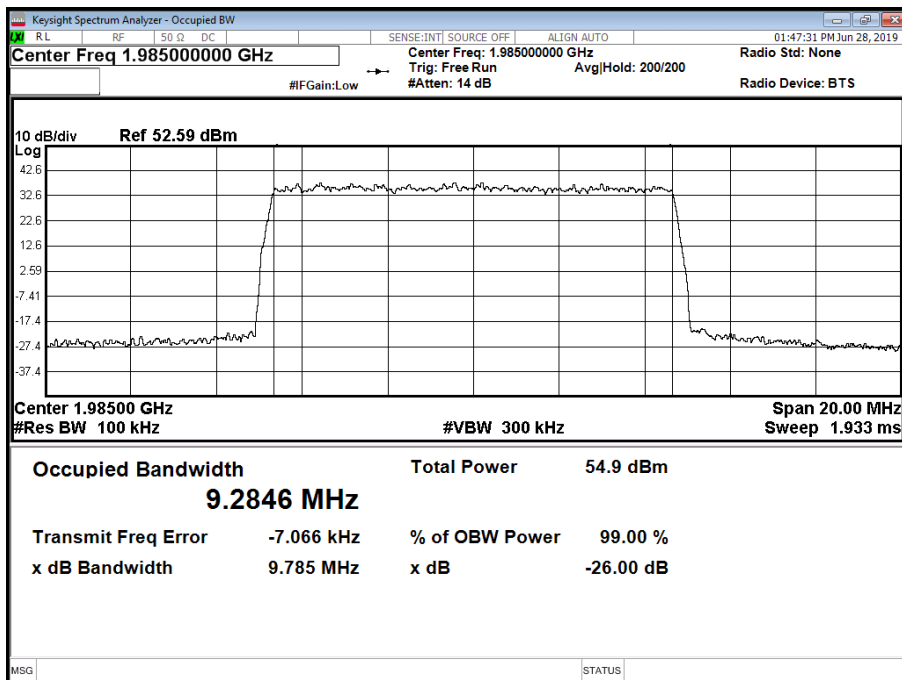



Antenna A - NR Modulation QPSK - NR Carrier Bandwidth 15.0 MHz 15 kHz SCS - Channel Position B

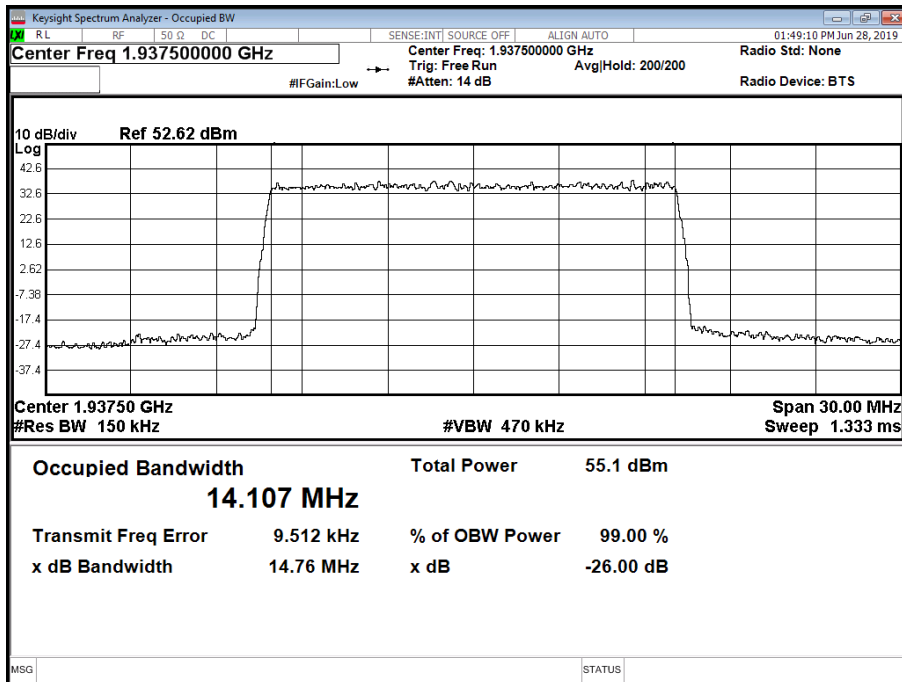

Antenna A - NR Modulation QPSK - NR Carrier Bandwidth 15.0 MHz 15 kHz SCS - Channel Position T

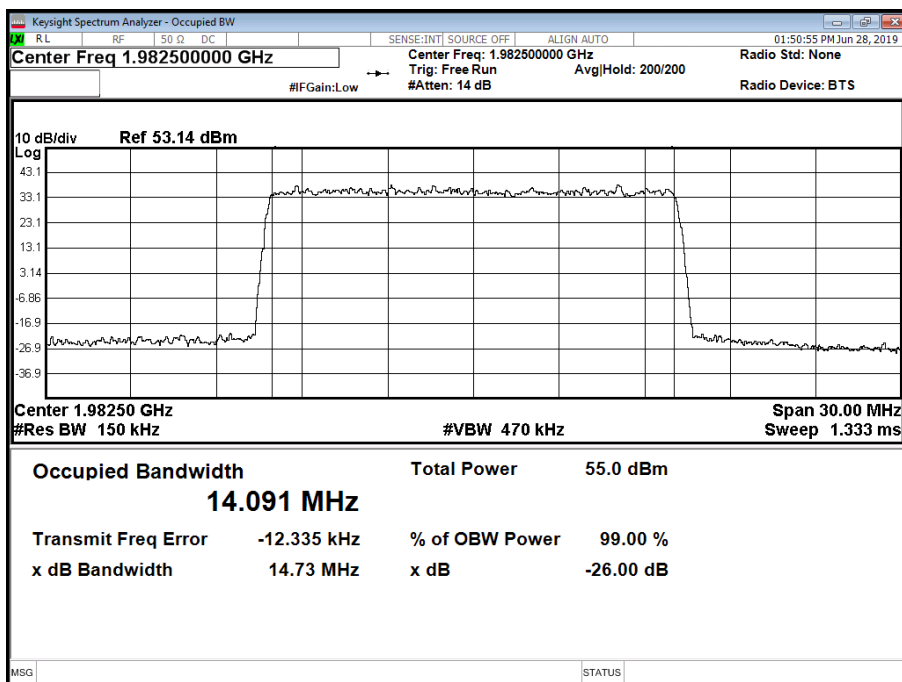



Antenna A - NR Modulation QPSK - NR Carrier Bandwidth 20.0 MHz 15 kHz SCS - Channel Position B

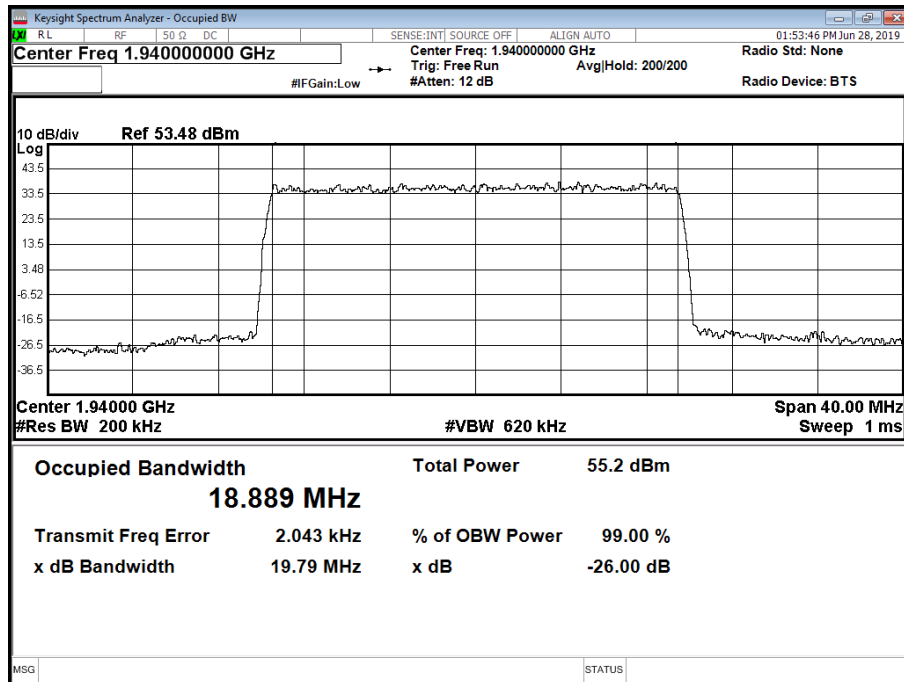

Antenna A - NR Modulation QPSK - NR Carrier Bandwidth 20.0 MHz 15 kHz SCS - Channel Position T

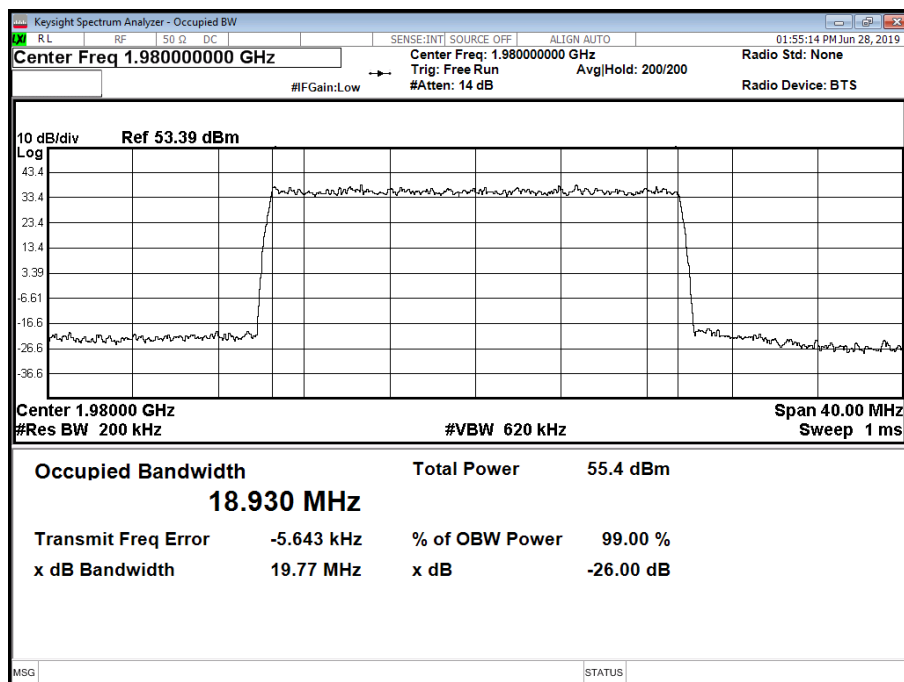



Antenna A - NR Modulation QPSK - NR Carrier Bandwidth 20.0 MHz 60 kHz SCS - Channel Position B

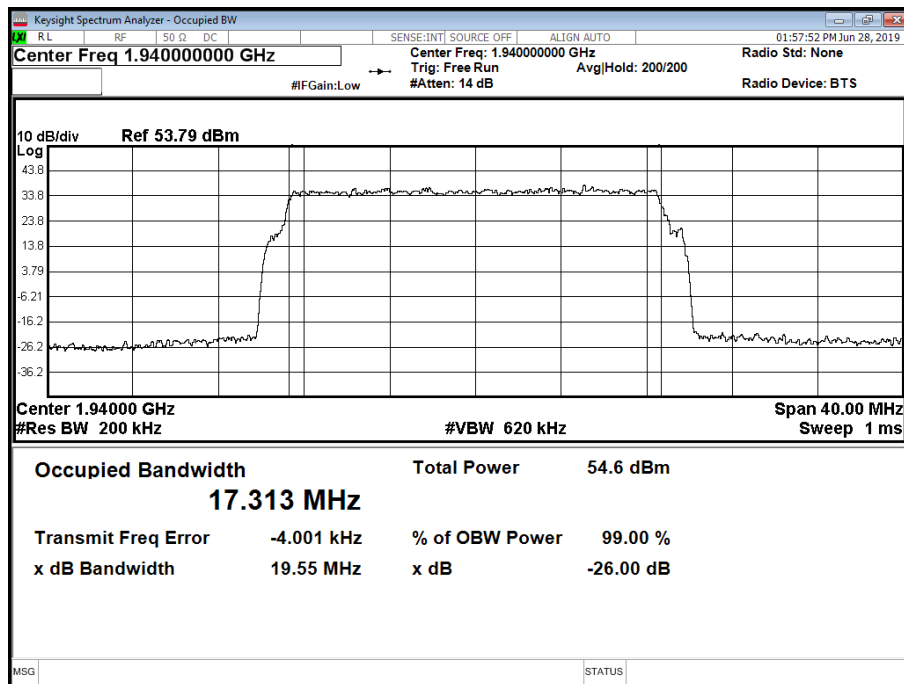

Antenna A - NR Modulation QPSK - NR Carrier Bandwidth 20.0 MHz 60 kHz SCS - Channel Position T

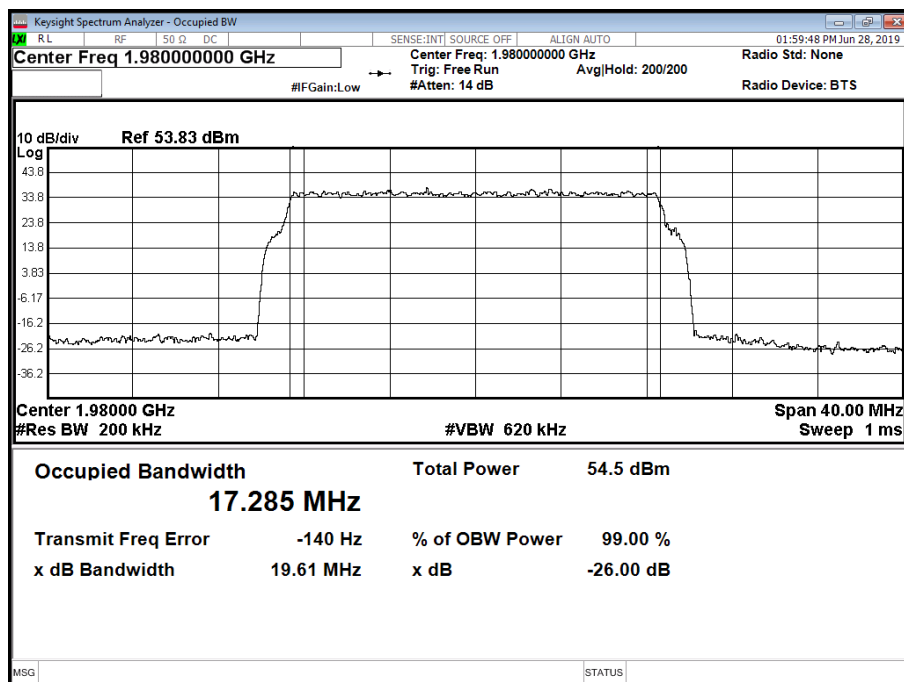



Antenna A - NR Modulation QPSK - NR Carrier Bandwidth 20.0 + 20.0 MHz 15 kHz SCS - Channel Position M

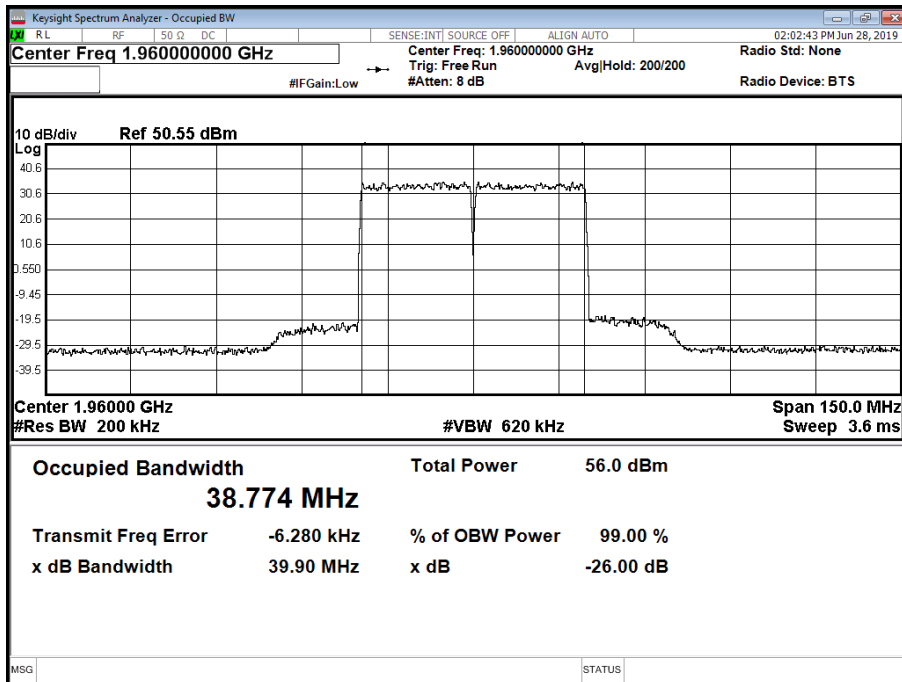



2.3 BAND EDGE

2.3.1 Specification Reference

FCC CFR 47 Part 2, Clause 2.1051
 FCC CFR 47 Part 24, Clause 24.238 (b)

2.3.2 Date of Test and Modification State

28 June 2019 - Modification State 0

2.3.3 Test Equipment Used

The major items of test equipment used for the above tests are identified in Section 3.1.

2.3.4 Environmental Conditions

Ambient Temperature 24.3°C
 Relative Humidity 38.4%

2.3.5 Test Method

All measurements were made in accordance with FCC KDB 971168 D01.

Each antenna port has been declared as being equivalent, therefore measurements were made on one antenna port only. To account for this, the limit was tightened by $10 * \text{Log}(N)$, where N is equal to the number of MIMO antenna ports.

For four carrier, the limit was calculated as being $-13 \text{ dBm} - 10 * \text{Log}(4) = -19 \text{ dBm}$.

For dual carrier, the limit was calculated as being $-13 \text{ dBm} - 10 * \text{Log}(2) = -16 \text{ dBm}$.

2.3.6 Test Results

Configuration A

Maximum Output Power 47.8 dBm

Antenna	NR Modulation	NR Carrier Bandwidth	Band Edge (MHz)	
			Channel Position B	Channel Position T
A	QPSK	5.0 MHz 15 kHz SCS	1,932.5	1,987.5
A	QPSK	10.0 MHz 15 kHz SCS	1,935.0	1,985.0
A	QPSK	15.0 MHz 15 kHz SCS	1,937.5	1,982.5
A	QPSK	20.0 MHz 15 kHz SCS	1,940.0	1,980.0
A	QPSK	20.0 MHz 60 kHz SCS	1,940.0	1,980.0
A	QPSK	20.0 + 20.0 MHz 15 kHz SCS		



Antenna A - NR Modulation QPSK - NR Carrier Bandwidth 5.0 MHz 15 kHz SCS - Channel Position B

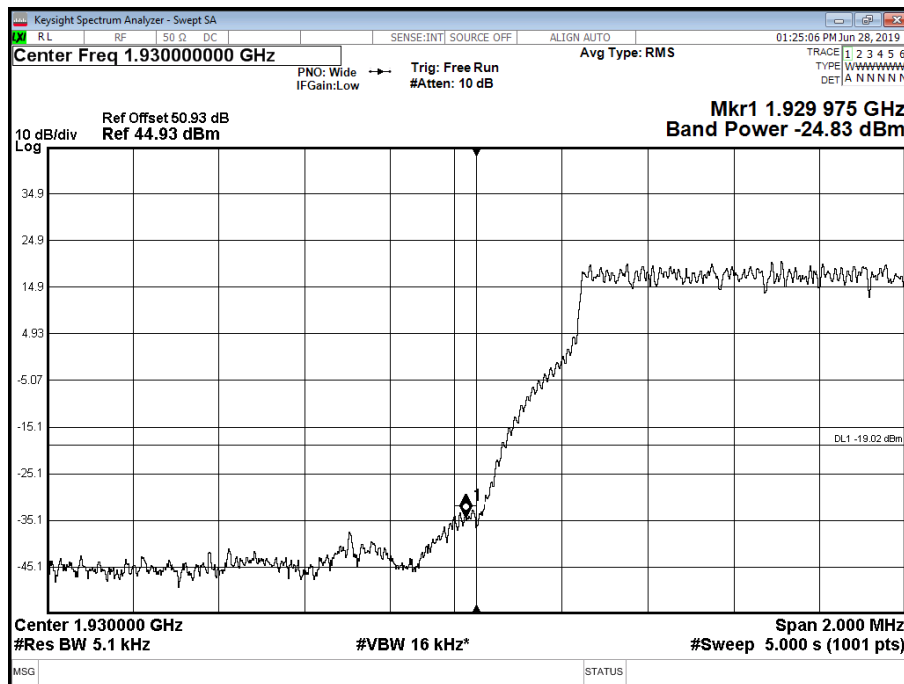

Antenna A - NR Modulation QPSK - NR Carrier Bandwidth 5.0 MHz 15 kHz SCS - Channel Position T

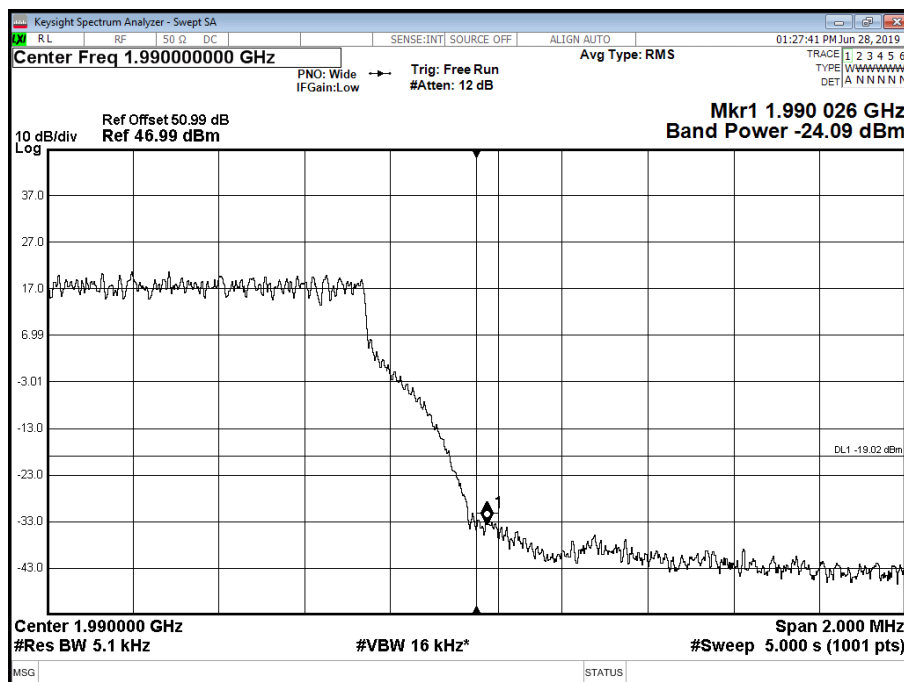



Antenna A - NR Modulation QPSK - NR Carrier Bandwidth 10.0 MHz 15 kHz SCS - Channel Position B

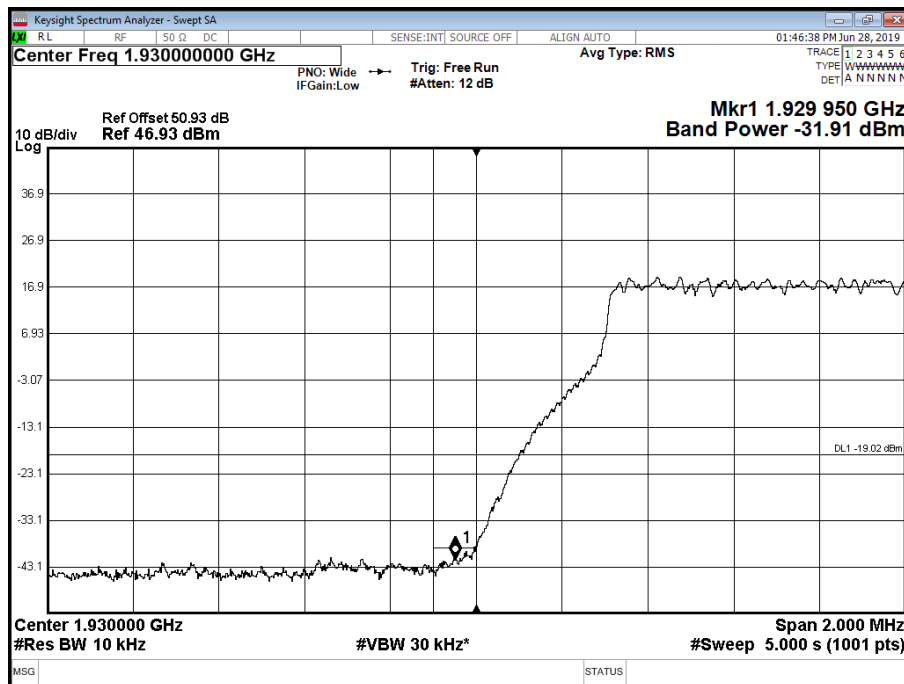

Antenna A - NR Modulation QPSK - NR Carrier Bandwidth 10.0 MHz 15 kHz SCS - Channel Position T

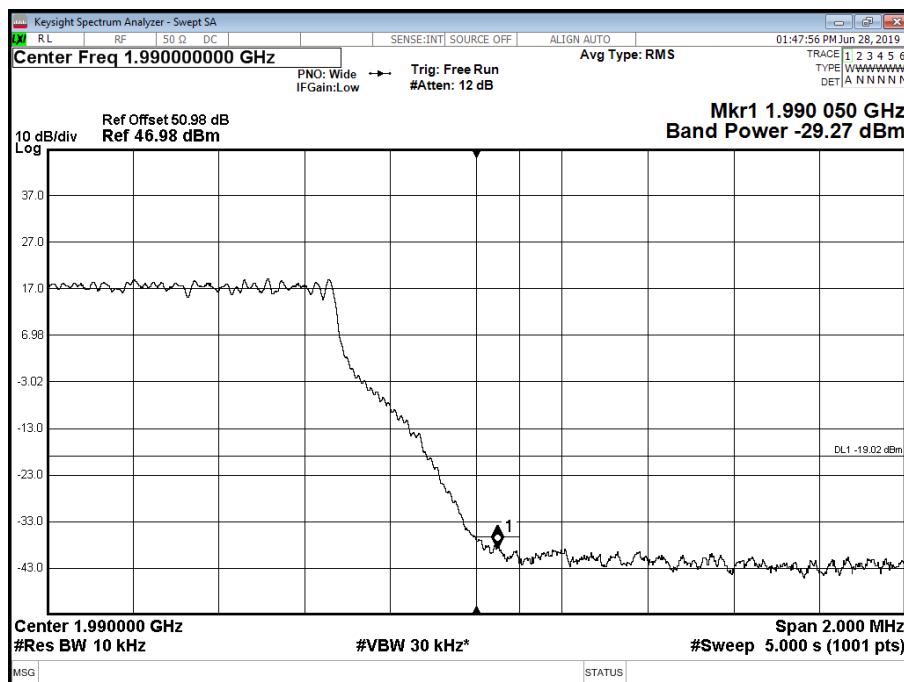



Antenna A - NR Modulation QPSK - NR Carrier Bandwidth 15.0 MHz 15 kHz SCS - Channel Position B

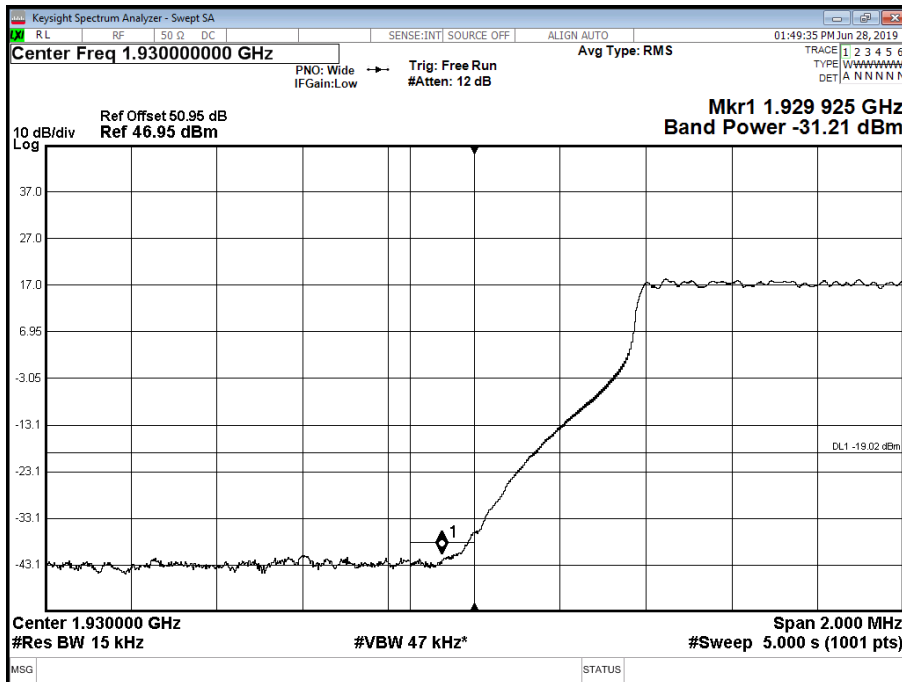

Antenna A - NR Modulation QPSK - NR Carrier Bandwidth 15.0 MHz 15 kHz SCS - Channel Position T

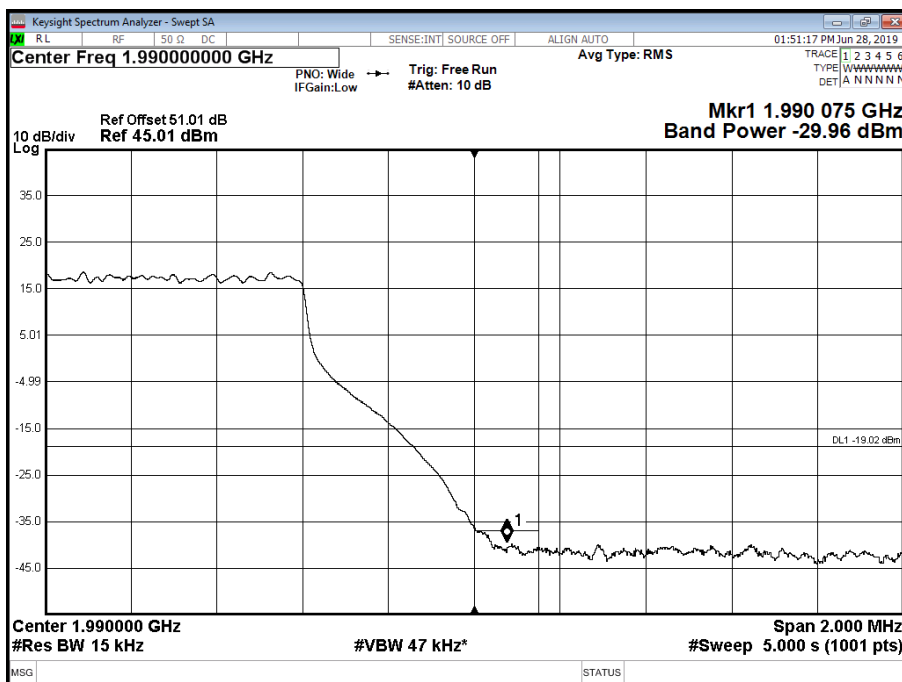



Antenna A - NR Modulation QPSK - NR Carrier Bandwidth 20.0 MHz 15 kHz SCS - Channel Position B

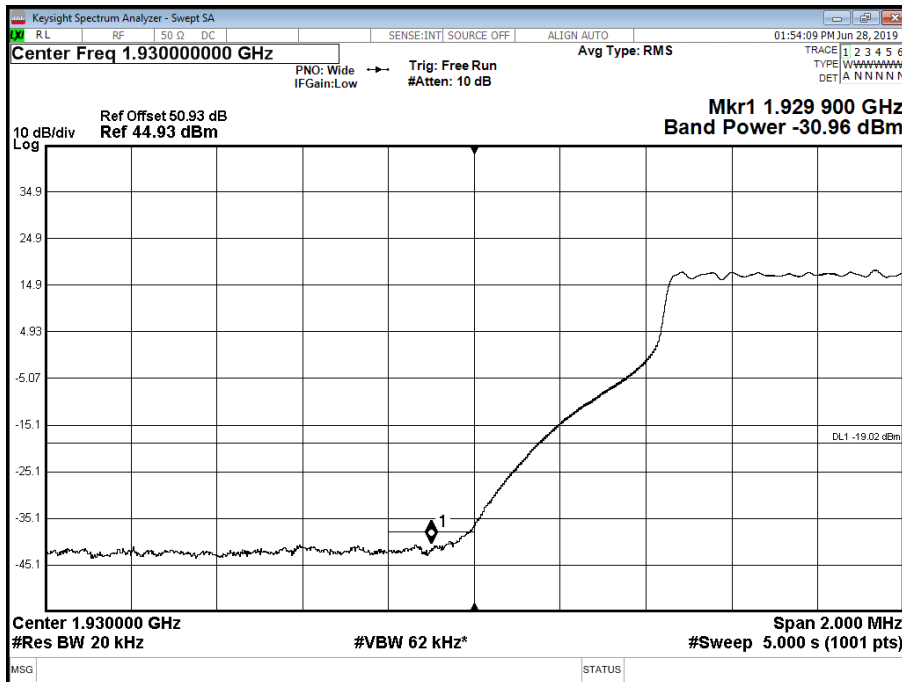

Antenna A - NR Modulation QPSK - NR Carrier Bandwidth 20.0 MHz 15 kHz SCS - Channel Position T

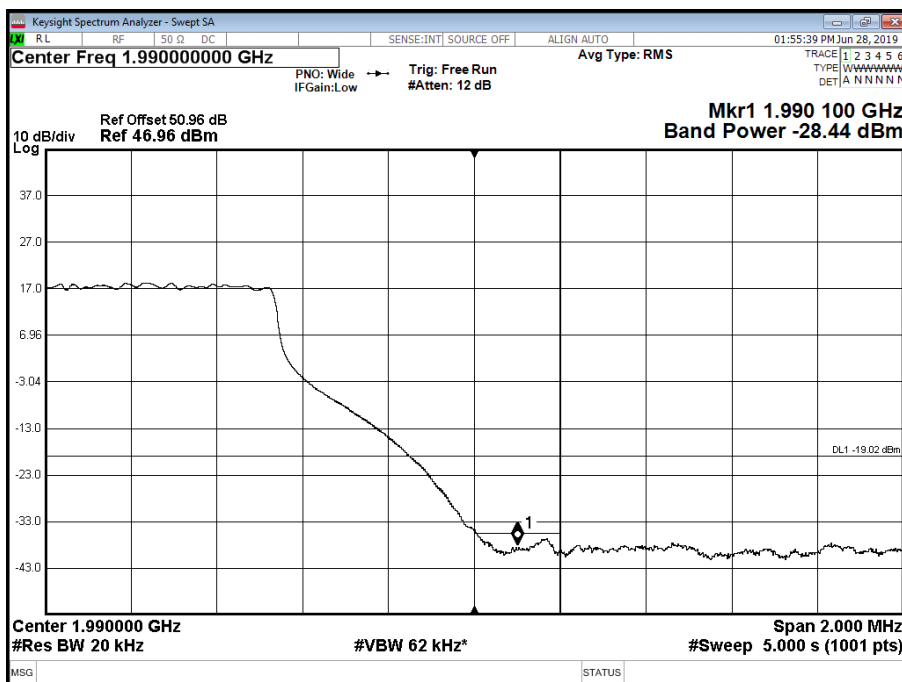



Antenna A - NR Modulation QPSK - NR Carrier Bandwidth 20.0 MHz 60 kHz SCS - Channel Position B

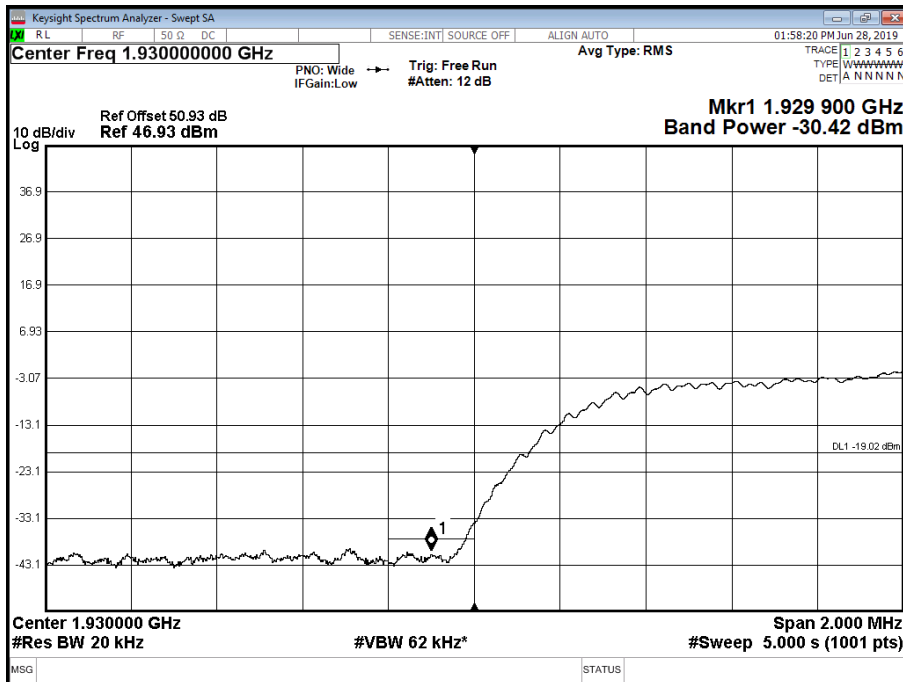

Antenna A - NR Modulation QPSK - NR Carrier Bandwidth 20.0 MHz 60 kHz SCS - Channel Position T

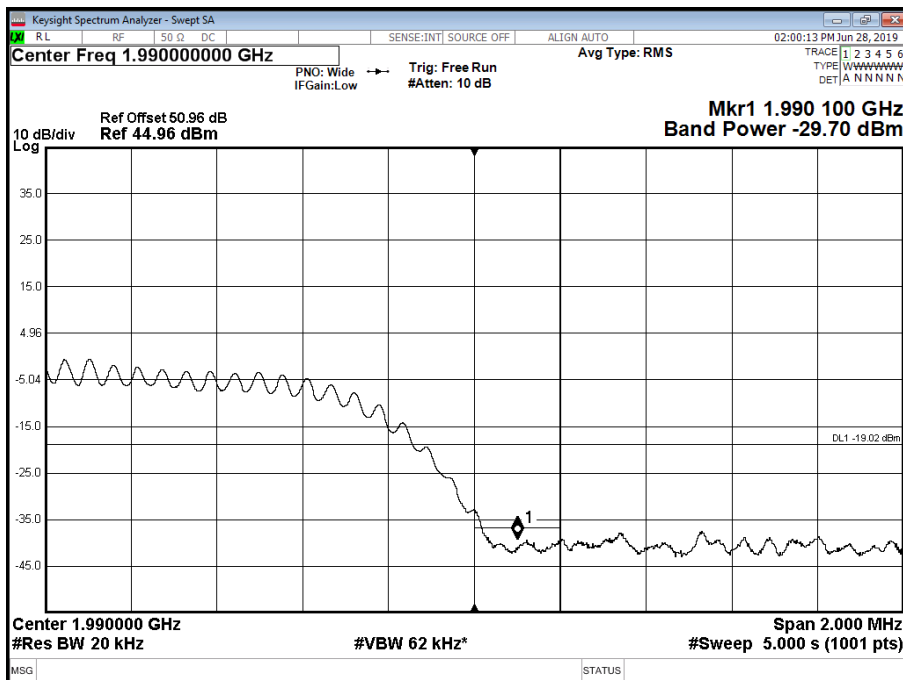

Limit	-19 dBm
-------	---------



2.4 TRANSMITTER SPURIOUS EMISSIONS

2.4.1 Specification Reference

FCC CFR 47 Part 2, Clause 2.1051
FCC CFR 47 Part 24, Clause 24.238 (a)

2.4.2 Date of Test and Modification State

28 June 2019 - Modification State 0

2.4.3 Test Equipment Used

The major items of test equipment used for the above tests are identified in Section 3.1.

2.4.4 Environmental Conditions

Ambient Temperature	24.3°C
Relative Humidity	38.4%

2.4.5 Test Method

All measurements were made in accordance with FCC KDB 971168 D01.

Each antenna port has been declared as being equivalent, therefore measurements were made on one antenna port only. To account for this, the limit was tightened by $10 * \text{Log}(N)$, where N is equal to the number of MIMO antenna ports.

For four carrier, the limit was calculated as being $-13 \text{ dBm} - 10 * \text{Log}(4) = -19 \text{ dBm}$.

For dual carrier, the limit was calculated as being $-13 \text{ dBm} - 10 * \text{Log}(2) = -16 \text{ dBm}$.

2.4.6 Test Results

Configuration A

Maximum Output Power 47.8 dBm



Antenna A - NR Modulation QPSK - NR Carrier Bandwidth 5.0 MHz 15 kHz SCS - Channel Position B - Band 1 - Range 0.009 to 4000 MHz

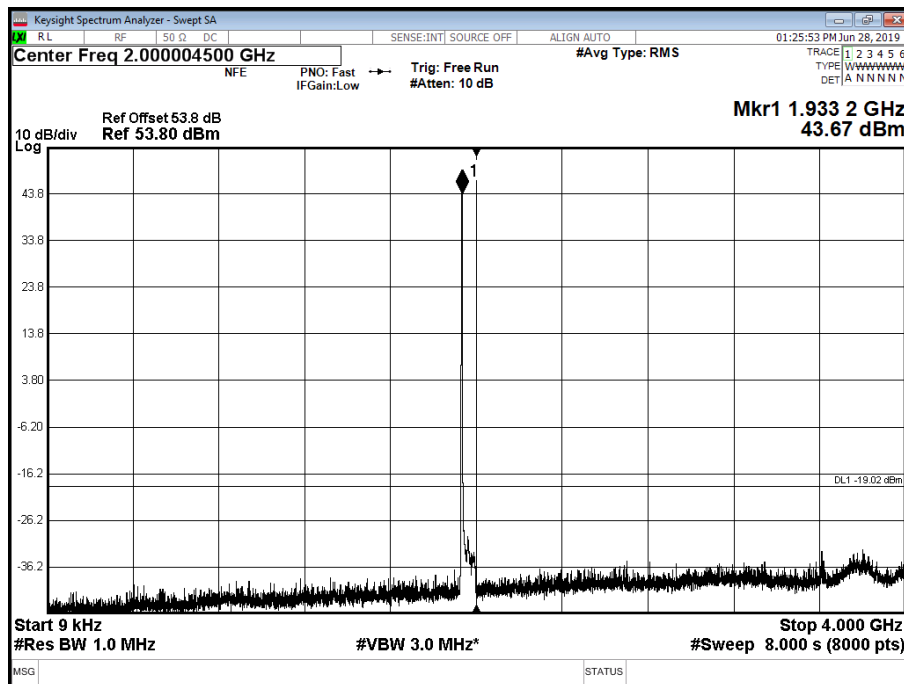

Antenna A - NR Modulation QPSK - NR Carrier Bandwidth 5.0 MHz 15 kHz SCS - Channel Position B - Band 2 - Range 4000 to 12000 MHz

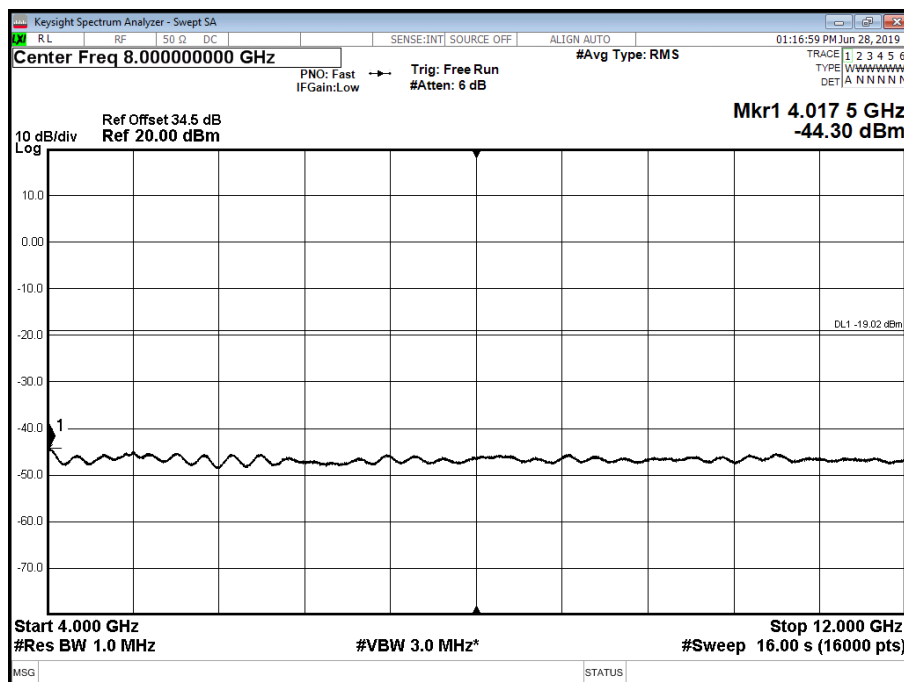



Antenna A - NR Modulation QPSK - NR Carrier Bandwidth 5.0 MHz 15 kHz SCS - Channel Position B - Band 3 - Range 12000 to 18000 MHz

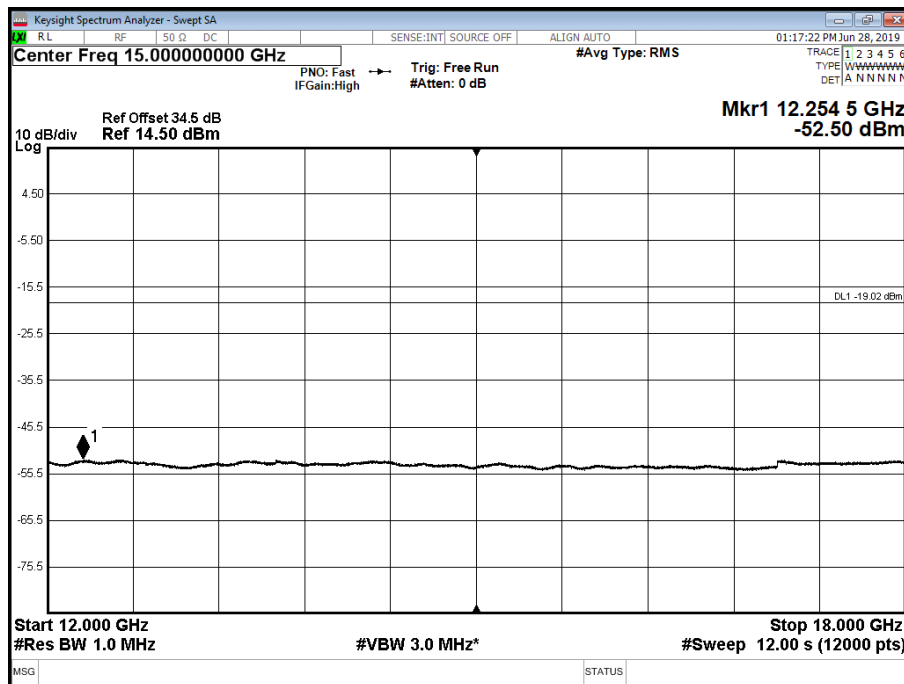

Antenna A - NR Modulation QPSK - NR Carrier Bandwidth 5.0 MHz 15 kHz SCS - Channel Position B - Band 4 - Range 18000 to 20000 MHz

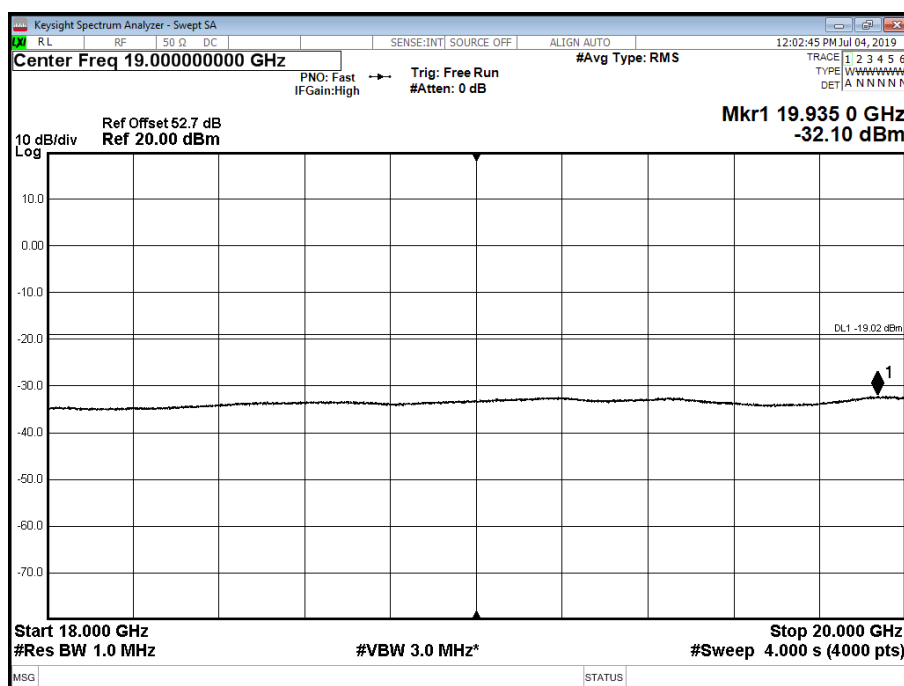



Antenna A - NR Modulation QPSK - NR Carrier Bandwidth 5.0 MHz 15 kHz SCS - Channel Position T - Band 1 - Range 0.009 to 4000 MHz

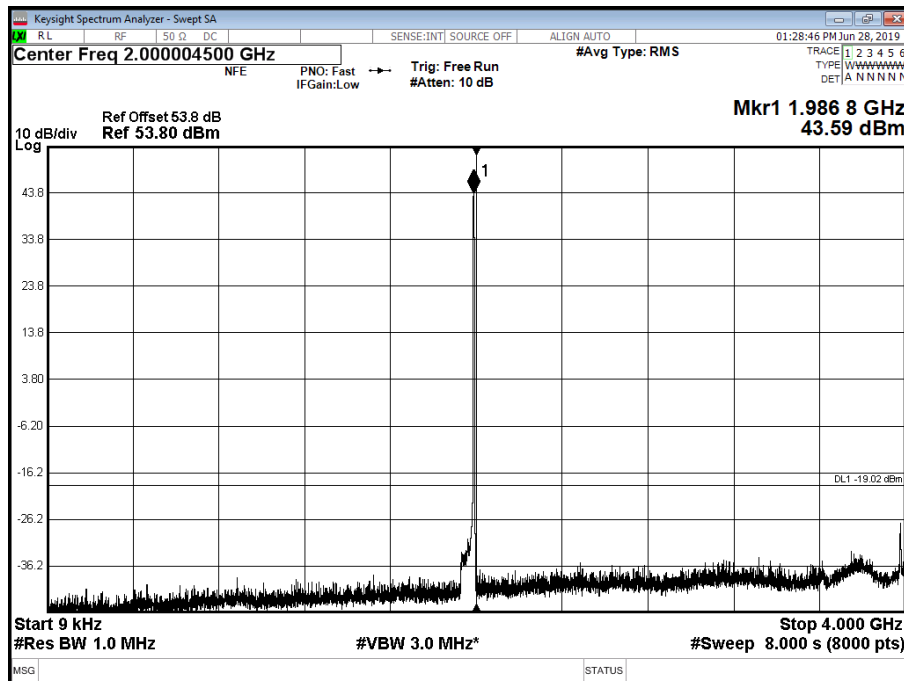

Antenna A - NR Modulation QPSK - NR Carrier Bandwidth 5.0 MHz 15 kHz SCS - Channel Position T - Band 2 - Range 4000 to 12000 MHz

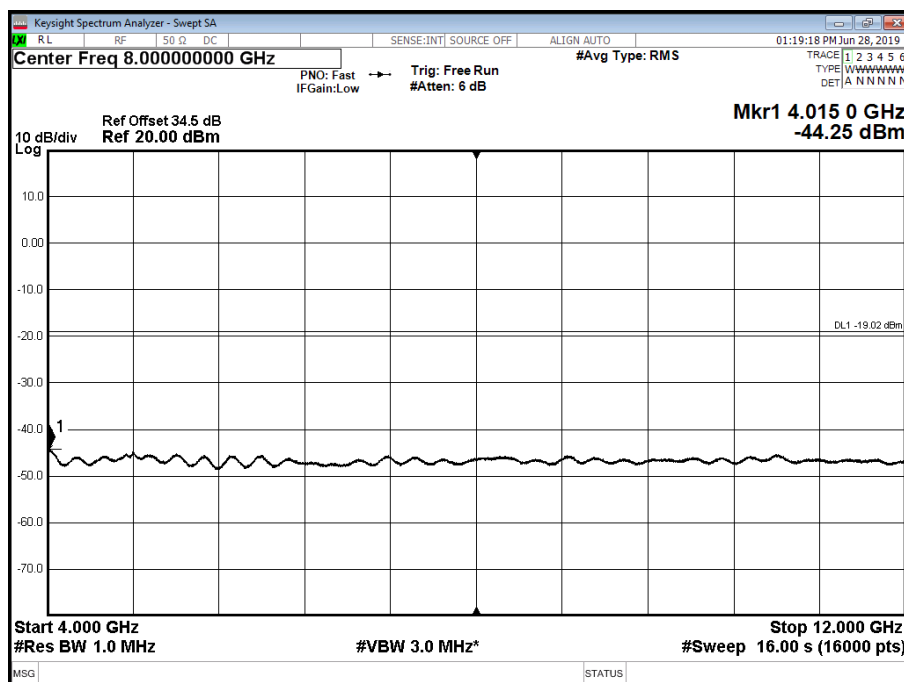



Antenna A - NR Modulation QPSK - NR Carrier Bandwidth 5.0 MHz 15 kHz SCS - Channel Position T - Band 3 - Range 12000 to 18000 MHz

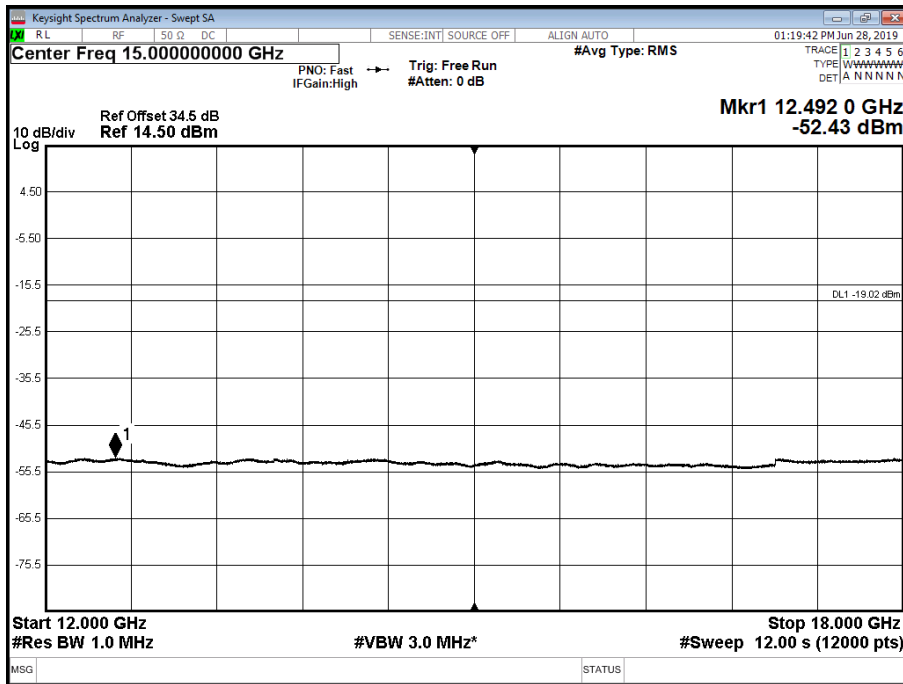

Antenna A - NR Modulation QPSK - NR Carrier Bandwidth 5.0 MHz 15 kHz SCS - Channel Position T - Band 3 - Range 18000 to 20000 MHz

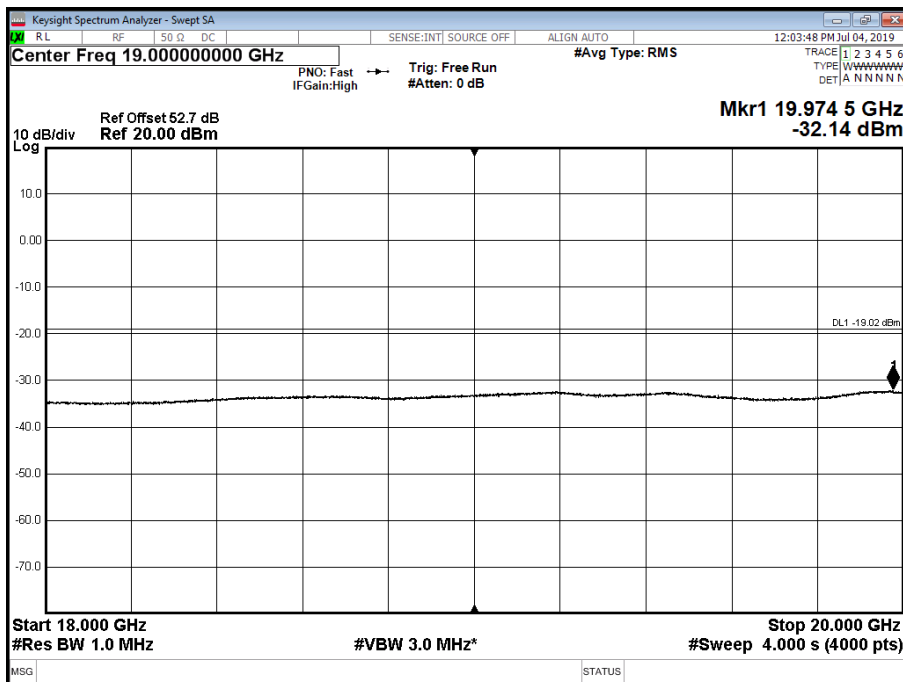

Limit	-19dBm
-------	--------



SECTION 3

TEST EQUIPMENT USED



3.1 TEST EQUIPMENT USED

List of absolute measuring and other principal items of test equipment.

Instrument	Manufacturer	Type No.	TE No.	Calibration Period (months)	Calibration Due
Maximum Peak Output Power and Peak to Average Ratio - Conducted					
PXA Signal Analyser	Keysight	N9030A	TE 004654	12	08-Oct-2019
Attenuator	API weinschel inc.	30dB	TE 005135	12	07-Nov-2019
Attenuator	API weinschel inc.	20dB	TE 005133	12	07-Nov-2019
Hydrometer	Rotronic	Hygropalm	TE 005264	12	02-May-2020
Occupied Bandwidth					
PXA Signal Analyser	Keysight	N9030A	TE 004654	12	08-Oct-2019
Attenuator	API weinschel inc.	30dB	TE 005135	12	07-Nov-2019
Attenuator	API weinschel inc.	20dB	TE 005133	12	07-Nov-2019
Hydrometer	Rotronic	Hygropalm	TE 005264	12	02-May-2020
Band Edge					
PXA Signal Analyser	Keysight	N9030A	TE 004654	12	08-Oct-2019
Attenuator	API weinschel inc.	30dB	TE 005135	12	07-Nov-2019
Attenuator	API weinschel inc.	20dB	TE 005133	12	07-Nov-2019
Hydrometer	Rotronic	Hygropalm	TE 005264	12	02-May-2020
Transmitter Spurious Emissions					
PXA Signal Analyser	Keysight	N9030A	TE 004654	12	08-Oct-2019
Attenuator	API weinschel inc.	30dB	TE 005135	12	07-Nov-2019
Attenuator	API weinschel inc.	20dB	TE 005133	12	07-Nov-2019
Highpass Filter	Wainwright	3000 -18000Mhz	TE 005219	12	15-Feb-2020
Hydrometer	Rotronic	Hygropalm	TE 005264	12	02-May-2020



3.2 MEASUREMENT UNCERTAINTY

For a 95% confidence level, the measurement uncertainties for defined systems are:

Test Discipline	Frequency / Parameter	MU
Conducted Maximum Peak Output Power	30 MHz to 20 GHz Amplitude	± 0.1 dB
Conducted Emissions	30 MHz to 20 GHz Amplitude	± 2.3 dB
Frequency Stability	30 MHz to 2 GHz	± 5.0 Hz
Occupied Bandwidth	Up to 20 MHz Bandwidth	± 1.1 Hz
Band Edge	30 MHz to 20 GHz Amplitude	± 2.3 dB



SECTION 4

ACCREDITATION, DISCLAIMERS AND COPYRIGHT



4.1 ACCREDITATION, DISCLAIMERS AND COPYRIGHT



This report relates only to the actual item/items tested.

Our UKAS Accreditation does not cover opinions and interpretations and any expressed are outside the scope of our UKAS Accreditation.

Results of tests not covered by our UKAS Accreditation Schedule are marked NUA (Not UKAS Accredited).

© 2019 TÜV SÜD



ANNEX A

MODULE LIST



Configuration A			
Product	Product No	R-State	Serial No
Radio 8843	KRC161707/2	R1D	D16X996678
CT10	LPC102487/1	R1C	T01F375047
Software Version:	CXP9013268_15	Revision:	R79CL