

RADIO TEST REPORT
No. 171100617SHA-001

Applicant : Ericsson AB
Isafjordsgatan 10 SE-164 80 Stockholm 16480 Sweden

Manufacturer : Ericsson AB
Isafjordsgatan 10 SE-164 80 Stockholm 16480 Sweden

Product Name : Radio 2205 B46

Product Number : KRC 161 609/2

TEST RESULT : PASS

SUMMARY

The equipment complies with the requirements according to the following standard(s) or specification:

47CFR Part 15 (2016): Radio Frequency Devices (Subpart E)

ANSI C63.10 (2013): American National Standard of Procedures for Compliance Testing of Unlicensed Wireless Devices

RSS-247 Issue 2 (February 2017): Digital Transmission Systems (DTSS), Frequency Hopping Systems (FHSs) and Licence - Exempt Local Area Network (LE-LAN) Devices

RSS-Gen Issue 4 (December 2014): General Requirements for Compliance of Radio Apparatus

Date of issue: November 1, 2017

Prepared by:



Nemo Li (Project engineer)

Reviewed by:



Daniel Zhao (Reviewer)

Contents

SUMMARY	1
REVISION HISTORY	4
1 GENERAL INFORMATION	5
1.1 DESCRIPTION OF EQUIPMENT UNDER TEST (EUT)	5
1.2 RF TECHNICAL INFORMATION	5
1.3 DESCRIPTION OF TEST FACILITY	7
2 TEST SPECIFICATIONS	8
2.1 RELATED DOCUMENTS	8
2.2 PRODUCT INFORMATION	8
2.3 CONFIGURATION DESCRIPTION	9
2.4 TEST SETUP	11
2.5 TEST CONDITION:	13
2.6 TEST ENVIRONMENT CONDITION:	13
2.7 DUTY CYCLE:	13
2.8 TEST SOFTWARE LIST:	18
2.9 INSTRUMENT LIST	19
2.10 MEASUREMENT UNCERTAINTY	20
2.11 TEST SUMMARY	21
3 MAXIMUM OUTPUT POWER AND EQUIVALENT ISOTROPICALLY RADIATED POWER (EIRP)	22
3.1 LIMIT	22
3.2 TEST METHOD	23
3.3 TEST RESULTS	24
4 POWER SPECTRUM DENSITY	43
4.1 LIMIT	43
4.2 TEST METHOD	43
4.3 TEST RESULTS	44
5 26 DB BANDWIDTH AND EMISSION BANDWIDTH (99%) AND 6 DB BANDWIDTH	122
5.1 LIMIT	122
5.2 TEST METHOD	122
5.3 TEST RESULTS	123
6 UNDESIRABLE EMISSION - CONDUCTED	177
6.1 LIMIT	177
6.2 TEST METHOD	177
6.3 TEST RESULTS	179
7 UNDESIRABLE EMISSION AT BAND EDGE	309
7.1 LIMIT	309
7.2 TEST METHOD	309
7.3 TEST RESULTS	311
8 UNDESIRABLE EMISSION - RADIATED	365
8.1 LIMIT	365
8.2 TEST METHOD	365

8.3 TEST RESULTS 367

9 CONDUCTED EMISSION 392

9.1 LIMIT 392

9.2 TEST METHOD 392

9.3 TEST RESULTS 393

10 FREQUENCY STABILITY 395

10.1 LIMIT 395

10.2 TEST RESULT: 395

Revision History

Issue No.	Version	Description	Date Issued
171100617SHA-001	Rev. 01	Initial issue of report	November 1, 2017

1 GENERAL INFORMATION

1.1 Description of Equipment Under Test (EUT)

EUT	: Remote Radio Unit
Product name	: Radio 2205 B46
Product number	: KRC 161 609/2
Serial Number(s)	: D826400479 D826400481
Hardware Version	: R1B
Software Version	: CXP9034873%2_R1B03
Description of EUT	: The equipment is the Remote Radio Part designed for use in LTE cellular telephone system and for LAA to extend benefits of LTE on unlicensed spectrum.
Rating	: 36V DC
Sample received date	: October 10, 2017
Date of test	: October 10, 2017 ~ October 31, 2017

1.2 RF Technical Information

Operating Frequency	: 5160 - 5250MHz
Range	: 5735 - 5850MHz
Type of Modulation	: LTE: QPSK, 16QAM, 64QAM, 256QAM
ITU Designation of Emission	: LTE: 20M0F9W
Number of Channels	: 5160 - 5250MHz Band: 4 channels 5735 - 5850MHz Band: 5 channels
Frequency of Channels	: 5160 - 5250MHz Band: 5180MHz, 5200MHz, 5220MHz, 5240MHz 5735 - 5850MHz Band: 5745MHz, 5765MHz, 5785MHz, 5805MHz, 5825MHz
Number of Carriers	: Maximum 3 carriers
Channel Bandwidth	: 20MHz
Output Power (RMS)	: Maximum 20.5dBm for ports be equipped with directional 9.5dBi antenna gain for FCC at band 5160 - 5250MHz. Maximum 8.5dBm for ports be equipped with directional 9.5dBi antenna gain for IC at band 5160 - 5250MHz.

Maximum 20.5dBm for ports be equipped with directional 9.5dBi antenna gain for FCC and IC at band 5735 - 5850MHz.

Maximum 25dBm for ports be equipped with directional 6.0dBi antenna gain for FCC at band 5160 - 5250MHz.

Maximum 12dBm for ports be equipped with directional 6.0dBi Antenna Gain for IC at band 5160 - 5250MHz.

Maximum 25dBm for ports be equipped with directional 6.0dBi Antenna Gain for FCC and IC at band 5735 - 5850MHz.

Instantaneous : 60MHz
Bandwidth
Number of Antenna : 2 TX ports
Ports
FCC ID : TA8AKRC161609-2
IC : 287AB-AS1616092

1.3 Description of Test Facility

Name : Intertek Testing Service Limited Shanghai
Address : Building 86, No. 1198 Qinzhou Road(North), Shanghai 200233, P.R. China
Telephone : 86 21 61278200
Telefax : 86 21 54262353

The test facility is recognized, certified, or accredited by these organizations :

- CNAS Accreditation Lab
Registration No. CNAS L0139
- FCC Accredited Lab
Designation Number: CN1175
- IC Registration Lab
Registration code No.: 2042B-1
- VCCI Registration Lab
Registration No.: R-4243, G-845, C-4723, T-2252
- NVLAP Accreditation Lab
NVLAP LAB CODE: 200849-0
- A2LA Accreditation Lab
Certificate Number: 3309.02

2 TEST SPECIFICATIONS

2.1 Related documents

47CFR Part 2 (2016)
ANSI/TIA-603-D:2010
3GPP TS 36.141 V13.6.0 (2017-01)
KDB 789033 D02 v01r04
KDB 662911 D01 v02r01

2.2 Product Information

The Equipment Under Test (EUT) is shown in the photograph below. The Radio 2205 B46 KRC 161 609/2 operates from a 36V DC with PSU AC 10 or PSU 48 05. A full technical description can be found in the Manufacturer's documentation.



2.3 Configuration Description

Configuration A

Configuration A1 – Maximum 20.5 dBm for ports equipped with directional 9.5dBi antenna at Band 5160 - 5250MHz for FCC.

Configuration A2 – Maximum 20.5 dBm for ports equipped with directional 9.5dBi antenna at Band 5735 - 5850MHz for FCC and IC.

Configuration A3 – Maximum 8.5 dBm for ports equipped with directional 9.5dBi antenna at Band 5160 - 5250MHz for IC.

Configuration B

Configuration B1 – Maximum 25.0 dBm for ports equipped with directional 6dBi antenna at Band 5160 - 5250MHz for FCC.

Configuration B2 – Maximum 25.0 dBm for ports equipped with directional 6dBi antenna at Band 5735 - 5850MHz for FCC and IC.

Configuration B3 – Maximum 12.0 dBm for ports equipped with directional 6dBi antenna at Band 5160 - 5250MHz for IC.

Configuration Code	Carrier(s)	Configuration Description
L-MIMO-SC	1C	LTE MIMO, Single Carrier
L-MIMO-MC 1	2C	LTE MIMO, Multi Carrier x2
L-MIMO-MC 2	3C	LTE MIMO, Multi Carrier x3

The settings below were deemed representative for all traffic scenarios when settings with different modulations, channel bandwidths, number for carriers and RF configurations have been tested to find the worst case setting. The settings below were used for all measurements unless otherwise noted:

LTE:

MIMO mode single carrier: E-TM1.1

MIMO mode multi carrier (x2): E-TM1.1

MIMO mode multi carrier (x3): E-TM1.1

MIMO mode single carrier: E-TM3.2

MIMO mode multi carrier (x2): E-TM3.2

MIMO mode multi carrier (x3): E-TM3.2

MIMO mode single carrier: E-TM3.1

MIMO mode multi carrier (x2): E-TM3.1

MIMO mode multi carrier (x3): E-TM3.1

MIMO mode single carrier: E-TM3.1a

MIMO mode multi carrier (x2): E-TM3.1a

MIMO mode multi carrier (x3): E-TM3.1a

The EUT includes two TX ports and it can be configured to transmit in MIMO mode for LTE carriers, MIMO mode for LTE was used for measurements as the worst configuration.

The complete testing was performed with the EUT transmitting at maximum RF power unless otherwise stated.

For LAA (Radio Access Technology) MIMO mode, all the Maximum Output Power and Maximum Power Spectral Density was tested on all TX output connector RF A and B. All the other TX measurements of LAA MIMO mode, were performed on the combined TX output connector RF A of the EUT as the representative port.

2.4 Test Setup

Test Setup, Conducted Measurement:

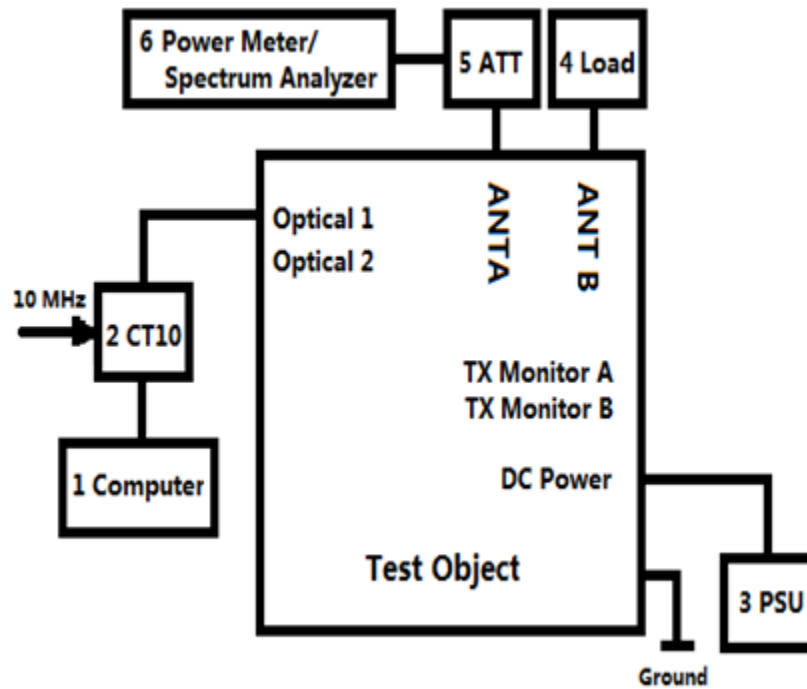

Product Name	Product Number	Version	Serial Number
Radio 2205 B46	KRC 161 609/2	R1B	D826400481

No.	Auxiliary Equipment	Product Number / Model Type	Version	Serial Number
1	Computer	HP EliteBook 8540w	--	CND1234694
2	CT10	LPC 102 487/1	R1C	T01F410050
3	PSU AC 10	BML 901 350/1	R1C	BW9A429444
	PSU 48 05	BMR 910 434/1	R1C	BW9A606175
4	Load	53K17R-005	--	--
5	20dB Attenuator	53AS102-K20	--	--

Test Setup, Radiated Measurement:

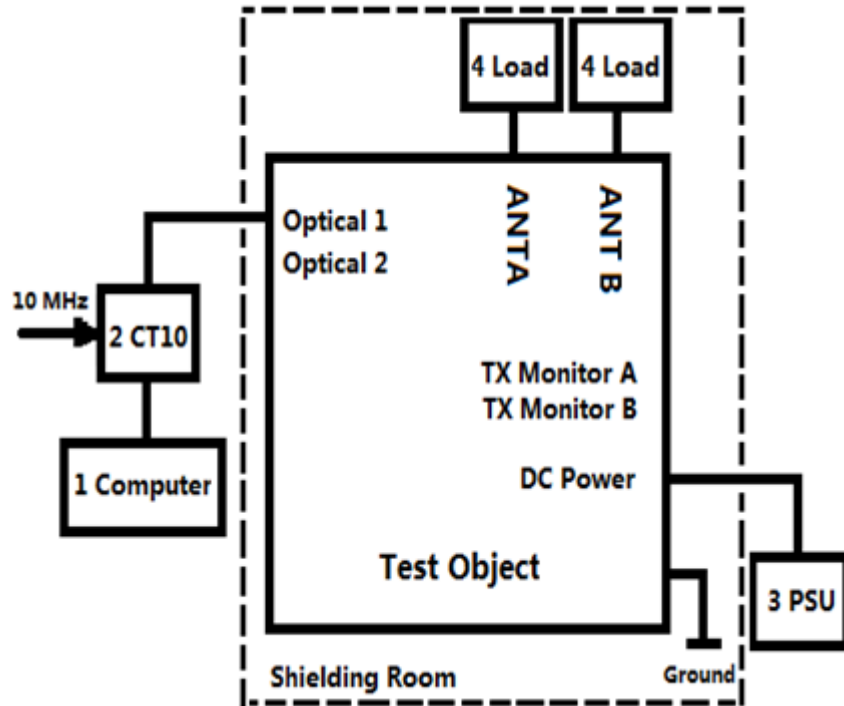

Product Name	Product Number	Version	Serial Number
Radio 2205 B46	KRC 161 609/2	R1B	D826400479

No.	Auxiliary Equipment	Product Number / Model Type	Version	Serial Number
1	Computer	EliteBook 8470w	--	BAMS-1001131391
2	CT10	LPC 102 487/1	R1C	T01F262515
3	PSU	PSU AC 08	R1B	BR83767592
4	Load	53K17R-005	--	--
	Load	53K17R-005	--	--

2.5 Test condition:

For all tests, the EUT was set up in accordance with the relevant test standard and to represent typical operating conditions. Tests were applied with the EUT situated in a shielded enclosure, test laboratories or a chamber as appropriate.

All test cases were tested with the EUT supplied with 36V DC via PSU AC 10 or PSU 48 05.

2.6 Test environment condition:

Temperature:	19-24°C
Humidity:	49-58% RH
Atmospheric Pressure:	100-101kPa

2.7 Duty cycle:

Modulation	Duty cycle (%)	Duty cycle factor (dB)
QPSK	67.86	1.68
16QAM	67.86	1.68
64QAM	67.86	1.68
256QAM	67.86	1.68

QPSK

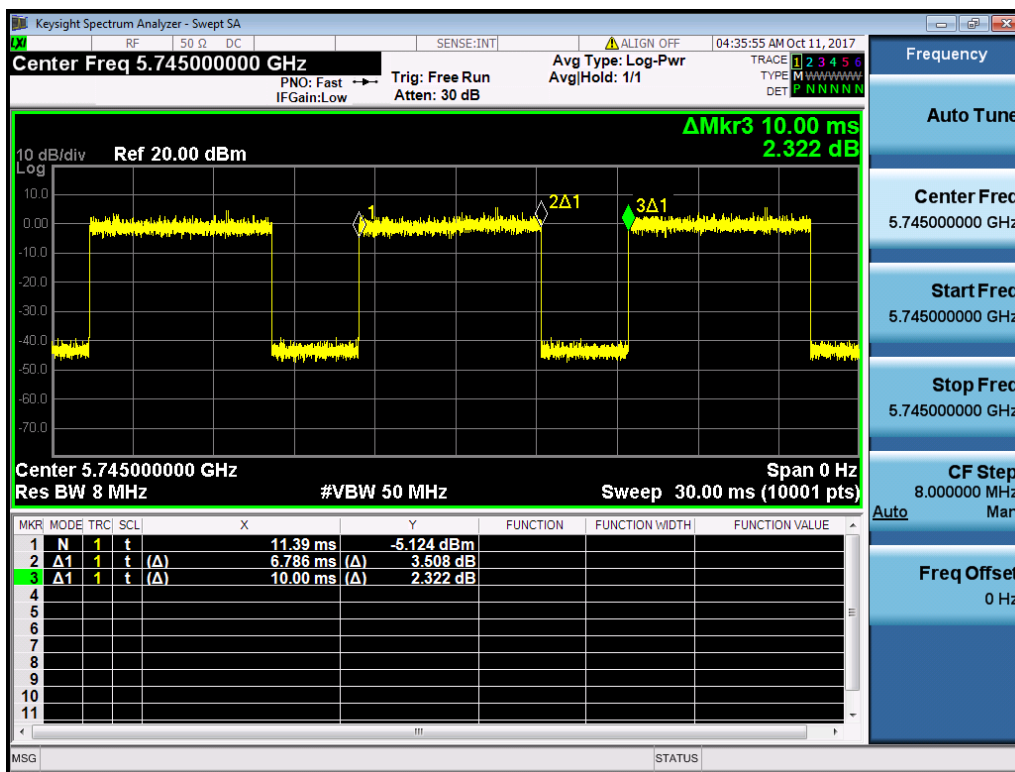
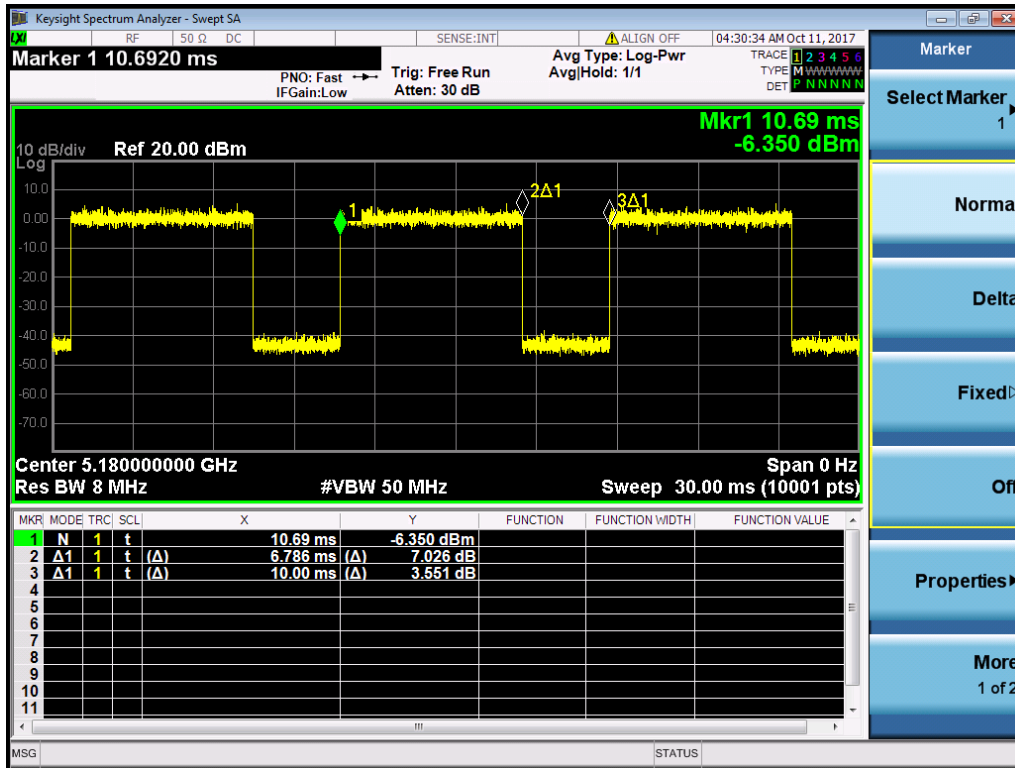

16QAM

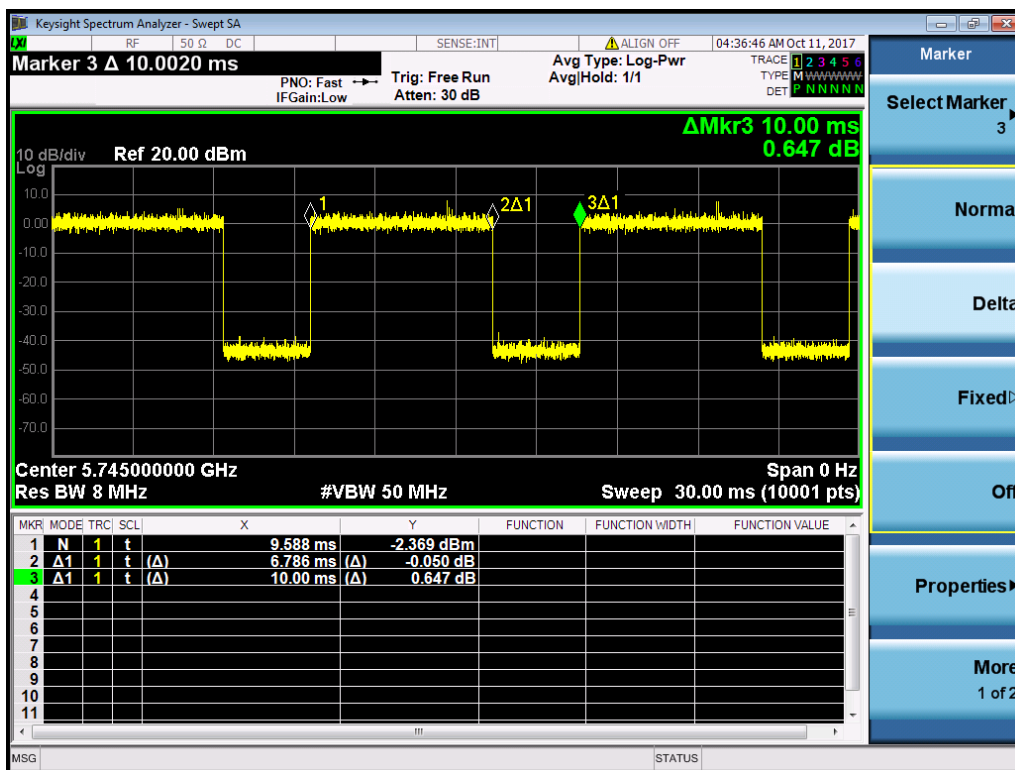
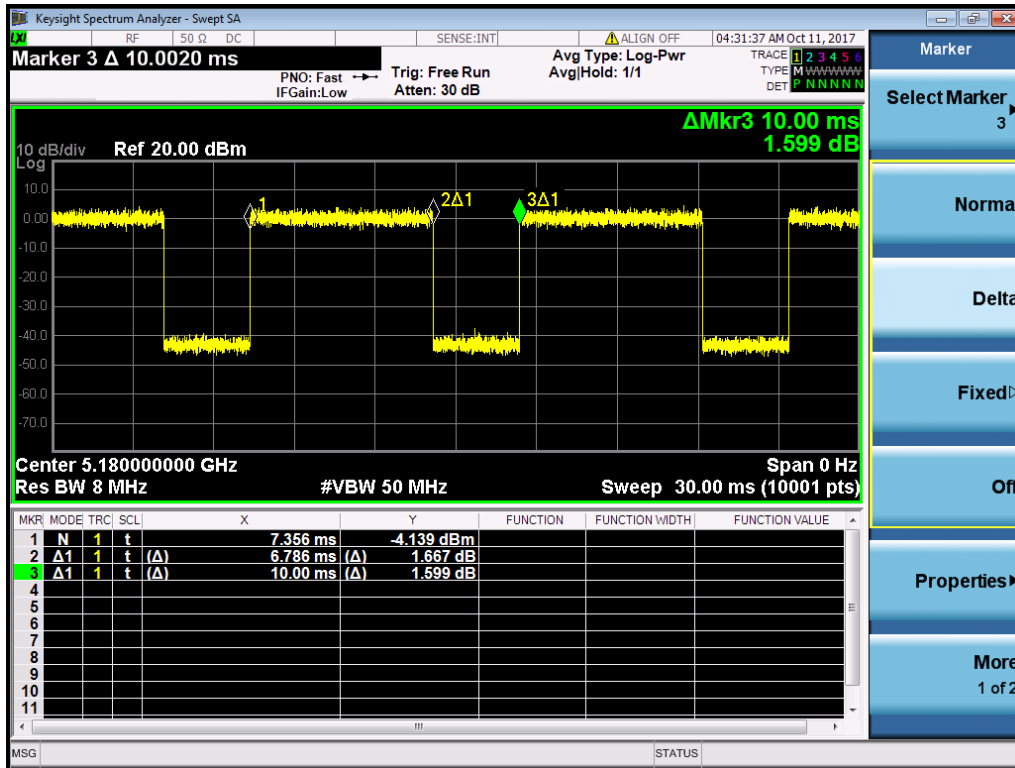

64QAM

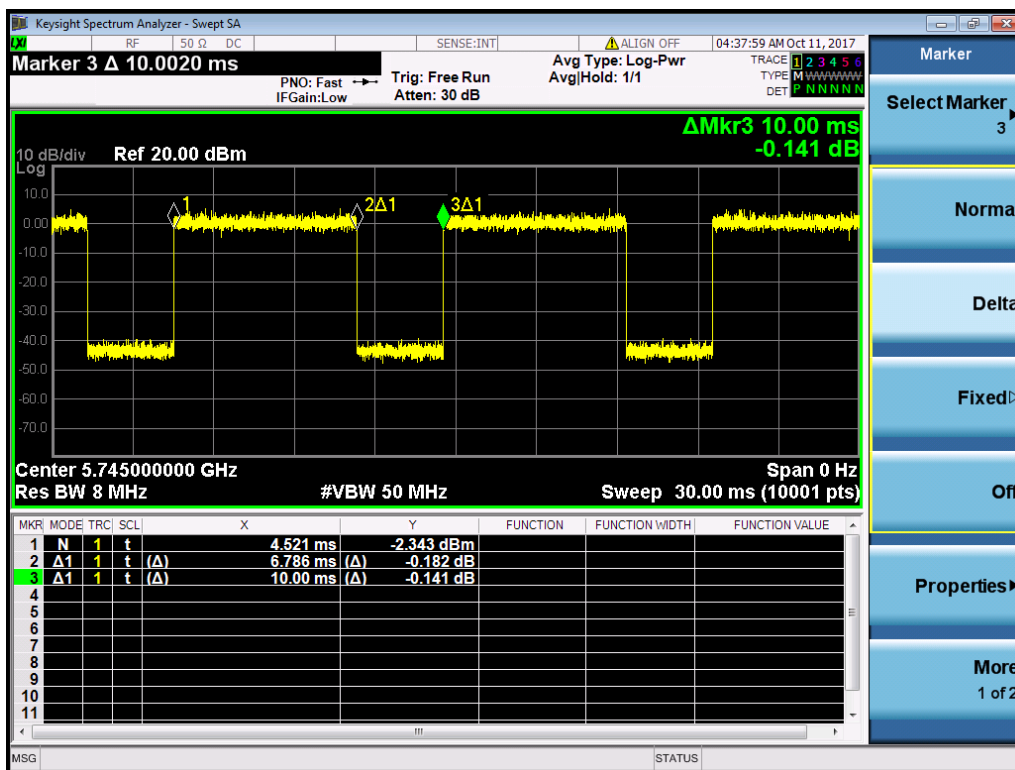
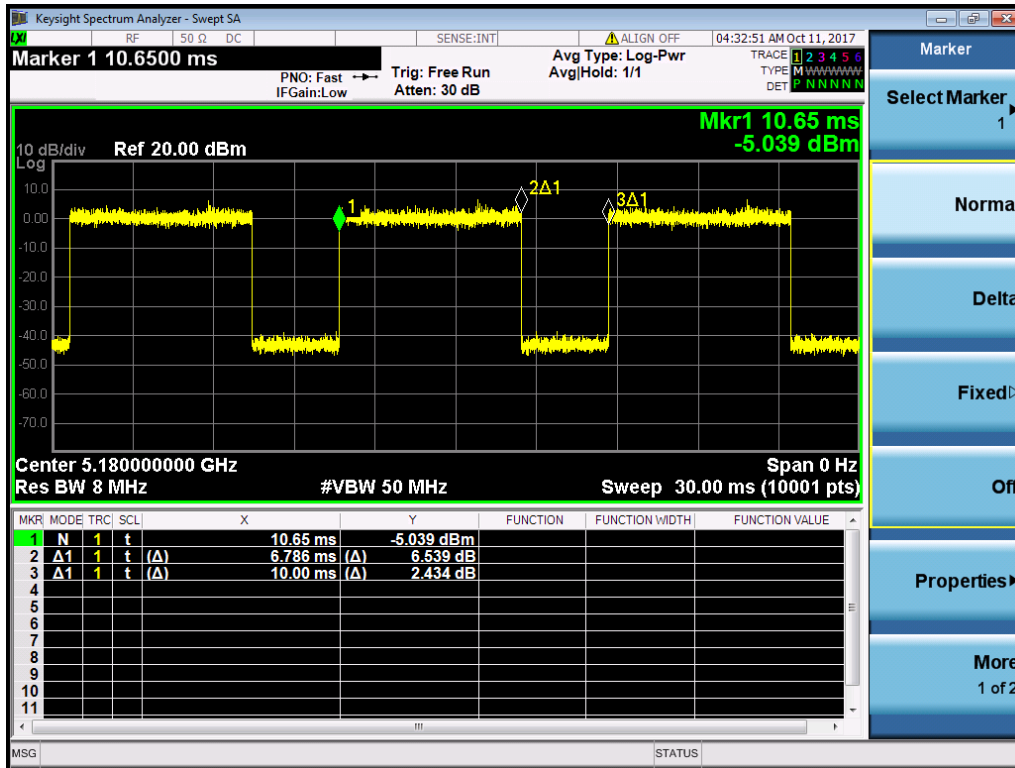

256QAM

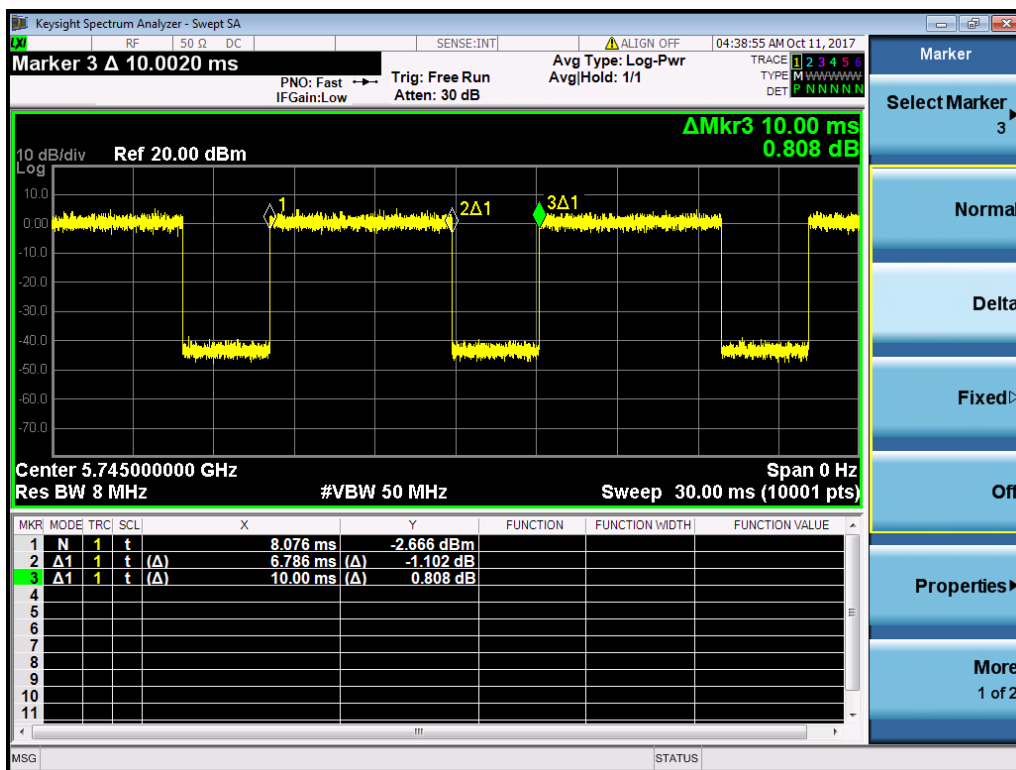
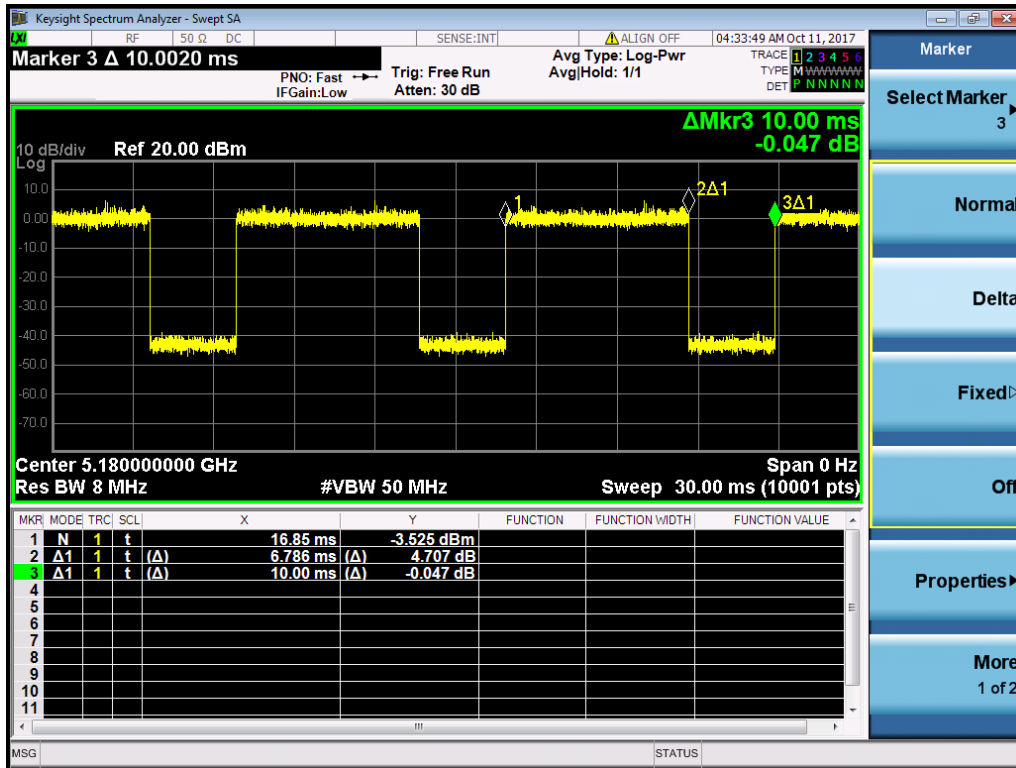

2.8 Test software list:

Test Items	Software	Manufacturer	Version
Conducted emission	ESxS-K1	R&S	V2.1.0
Radiated emission	ES-K1	R&S	V1.71

2.9 Instrument list

Conducted Emission					
Used	Equipment	Manufacturer	Type	Internal no.	Due date
<input checked="" type="checkbox"/>	Test Receiver	R&S	ESCS 30	EC 2107	2018-10-19
<input checked="" type="checkbox"/>	A.M.N.	R&S	ESH2-Z5	EC 3119	2017-12-01
<input checked="" type="checkbox"/>	A.M.N.	R&S	ENV 216	EC 3393	2018-07-30
Radiated Emission					
Used	Equipment	Manufacturer	Type	Internal no.	Due date
<input checked="" type="checkbox"/>	Test Receiver	R&S	ESIB 26	EC 3045	2018-10-19
<input checked="" type="checkbox"/>	Bilog Antenna	TESEQ	CBL 6112D	EC 4206	2018-05-30
<input checked="" type="checkbox"/>	Horn antenna	R&S	HF 906	EC 3049	2018-09-23
<input checked="" type="checkbox"/>	Horn antenna	TOYO	HAP18-26W	EC 4792-3	2020-07-09
<input checked="" type="checkbox"/>	Pre-amplifier	R&S	Pre-amp 18	EC 5881	2018-06-19
<input checked="" type="checkbox"/>	Horn antenna	ETS-Lindgren	3116C 3116C-PA	-	2018-12-29
<input checked="" type="checkbox"/>	Active loop antenna	Schwarzbeck	FMZB1519	EC 5345	2018-01-25
RF test					
Used	Equipment	Manufacturer	Type	Internal no.	Due date
<input checked="" type="checkbox"/>	PXA Signal Analyzer	Keysight	N9030A	EC 5338	2018-03-03
<input checked="" type="checkbox"/>	Power sensor/ Power meter	Agilent	N1911A/ N1921A	EC 4318	2018-05-12
Frequency Stability					
Used	Equipment	Manufacturer	Type	Internal no.	Due date
<input checked="" type="checkbox"/>	Signal Analyzer	Anritsu	MS2691A	ETC/L743	2018-08-14
<input checked="" type="checkbox"/>	Climate Test Chamber	ESPEC	SETH-Z-102U	EC 4819	2018-03-06
Tet Site					
Used	Equipment	Manufacturer	Type	Internal no.	Due date
<input checked="" type="checkbox"/>	Shielded room	Zhongyu	-	EC 2838	2018-01-08
<input checked="" type="checkbox"/>	Semi-anechoic chamber	Albatross project	-	EC 3048	2018-09-09

2.10 Measurement Uncertainty

Test Items	Expanded Uncertainty (k=2) (±)
Conducted maximum output power	0.74dB
RF conducted emission	2.89dB
Radiated Emissions in restricted frequency bands below 1GHz	4.90dB
Radiated Emissions in restricted frequency bands above 1GHz	5.02dB
Power line conducted emission	3.19dB
Frequency stability	0.84×10^{-7}

2.11 Test Summary

This report applies to tested sample only. The test results have been compared directly with the limits, and the measurement uncertainty is recorded. This report shall not be reproduced in part without written approval of Intertek Testing Service Shanghai.

SECTION	TEST ITEM	FCC REFERANCE	IC REFERANCE	RESULT
3	Maximum Output Power and Equivalent Isotropically Radiated Power (EIRP)	15.247 (a)(1)(3)	RSS-247 Issue 2 Clause 6	Pass
4	Maximum Power Spectral Density	15.407 (a)(5)	RSS-247 Issue 2 Clause 6	Pass
5	26 dB Bandwidth and 99% Occupied Bandwidth and 6dB Bandwidth	15.407 (a) 15.407 (e)	RSS-247 Issue 2 Clause 6	Pass
6	Undesirable Emission – Conducted	15.407 (b) 15.209	RSS-247 Issue 2 Clause 6	Pass
7	Undesirable Emission at Band Edge	15.407 (b) 15.209 15.205	RSS-247 Issue 2 Clause 6	Pass
8	Undesirable Emission – Radiated	15.407 (b) 15.209 15.205	RSS-247 Issue 2 Clause 6 RSS-Gen Issue 4 Clause 8.10	Pass
9	Conducted Emission	15.407 (b) 15.207	RSS-Gen Issue 4 Clause 8.8	Pass
10	Frequency Stability	15.407 (g)	RSS-Gen Issue 4 Clause 8.11	Pass

Notes: 1: NA =Not Applicable

2: This report is for the exclusive use of Intertek's Client and is provided pursuant to the agreement between Intertek and its Client. Intertek's responsibility and liability are limited to the terms and conditions of the agreement. Intertek assumes no liability to any party, other than to the Client in accordance with the agreement, for any loss, expense or damage occasioned by use of this report. Only the Client is authorized to permit copying or distribution of this report and then only in its entirety. Any use of the Intertek name or one of its marks for the sale or advertisement of the tested material, product or service must first be approved in writing by Intertek. The observations and test results in this report are relevant only to the sample tested. This report by itself does not imply that the material, product, or service is or has ever been under an Intertek certification program.

3 Maximum Output Power and Equivalent Isotropically Radiated Power (EIRP)

Test result: Pass

3.1 Limit

For an outdoor access point operating in the band 5.15 - 5.25 GHz, the maximum conducted output power over the frequency band of operation shall not exceed 1 W provided the maximum antenna gain does not exceed 6 dBi.

The maximum e.i.r.p. at any elevation angle above 30 degrees from the horizon must not exceed 125 mW (21 dBm).

For an indoor access point operating in the band 5.15 - 5.25 GHz, the maximum conducted output power over the frequency band of operation shall not exceed 1 W provided the maximum antenna gain does not exceed 6 dBi.

For fixed point-to-point access points operating in the band 5.15 - 5.25 GHz, the maximum conducted output power over the frequency band of operation shall not exceed 1 W.

For mobile and portable client devices in the 5.15 - 5.25 GHz band, the maximum conducted output power over the frequency band of operation shall not exceed 250 mW provided the maximum antenna gain does not exceed 6 dBi.

For Frequency Band 5.15 - 5.25 GHz, the maximum e.i.r.p. shall not exceed 200 mW or $10 + 10 \log_{10} B$, dBm, whichever power is less. B is the 99% emission bandwidth in megahertz. (IC)

For the band 5.725 - 5.85 GHz, the maximum conducted output power over the frequency band of operation shall not exceed 1 W.

If transmitting antennas of directional gain greater than 6dBi are used, the maximum conducted output power shall be reduced by the amount in dB that the directional gain of the antenna exceeds 6dBi.

3.2 Test Method

The test was applied in accordance with the test method requirements of FCC CFR 47 Part 15, Clause 15.407(a) and RSS-247 Clause 6.

Using a power meter, spectrum analyzer and attenuator(s), the output power of the EUT was measured at the antenna terminal in accordance with FCC KDB 789033 D02. The path loss between the EUT and the power sensor was measured and recorded for the test band. The path loss and duty cycle factor was entered as an offset into the power meter and spectrum analyzer.

The EUT was configured to transmit on maximum power on the configurations defined in the tables below. In case of the EUT was configured to MIMO mode, since the EUT transmits on two antennas simultaneously in the same frequency range for MIMO devices, i.e., TX MIMO mode, using the Measure-and-Sum approach, the output power at both antennas were tested, and the total output power were then summed mathematically in linear power units according to FCC KDB 662911 D01.

Outdoor Maximum EIRP was calculated in accordance with FCC CFR 47 Part 15, Clause 15.407 (a).

The RMS power was measured and Maximum EIRP calculated and recorded with the results being compared with the limits.

3.3 Test Results

Configuration A1

L-MIMO-SC

Maximum Output Power 20.5dBm per port:

Antenna	Modulation / Carrier bandwidth (MHz)	Conducted Output Power (dBm)		
		Channel Position B 5180MHz	Channel Position M 5220MHz	Channel Position T 5240MHz
A	QPSK / 20.0 MHz	20.78	20.72	20.60
B		20.53	20.44	20.40
Total		23.67	23.60	23.52

Antenna	Modulation / Carrier bandwidth (MHz)	Conducted Output Power (dBm)		
		Channel Position B 5180MHz	Channel Position M 5220MHz	Channel Position T 5240MHz
A	16QAM / 20.0 MHz	20.68	20.69	20.58
B		20.49	20.53	20.46
Total		23.60	23.62	23.53

Antenna	Modulation / Carrier bandwidth (MHz)	Conducted Output Power (dBm)		
		Channel Position B 5180MHz	Channel Position M 5220MHz	Channel Position T 5240MHz
A	64QAM / 20.0 MHz	20.68	20.78	20.54
B		20.49	20.52	20.50
Total		23.60	23.67	23.53

Antenna	Modulation / Carrier bandwidth (MHz)	Conducted Output Power (dBm)		
		Channel Position B 5180MHz	Channel Position M 5220MHz	Channel Position T 5240MHz
A	256QAM / 20.0 MHz	20.69	20.70	20.51
B		20.50	20.52	20.48
Total		23.61	23.63	23.51

L-MIMO-MC 1 (2C)

Maximum Output Power 20.5dBm per port:

Antenna	Modulation / Carrier bandwidth (MHz)	Conducted Output Power (dBm)		
		Channel Position B _{RFBW} 5180MHz+5220MHz	Channel Position M _{RFBW}	Channel Position T _{RFBW} 5200MHz+5240MHz
A	QPSK / 20.0 MHz	20.37	-	20.34
B		20.32	-	20.24
Total		23.36	-	23.30

Antenna	Modulation / Carrier bandwidth (MHz)	Conducted Output Power (dBm)		
		Channel Position B _{RFBW} 5180MHz+5220MHz	Channel Position M _{RFBW}	Channel Position T _{RFBW} 5200MHz+5240MHz
A	16QAM / 20.0 MHz	20.35	-	20.36
B		20.27	-	20.20
Total		23.32	-	23.29

Antenna	Modulation / Carrier bandwidth (MHz)	Conducted Output Power (dBm)		
		Channel Position B _{RFBW} 5180MHz+5220MHz	Channel Position M _{RFBW}	Channel Position T _{RFBW} 5200MHz+5240MHz
A	64QAM / 20.0 MHz	20.49	-	20.42
B		20.23	-	20.20
Total		23.38	-	23.33

Antenna	Modulation / Carrier bandwidth (MHz)	Conducted Output Power (dBm)		
		Channel Position B _{RFBW} 5180MHz+5220MHz	Channel Position M _{RFBW}	Channel Position T _{RFBW} 5200MHz+5240MHz
A	256QAM / 20.0 MHz	20.52	-	20.48
B		20.39	-	20.23
Total		23.47	-	23.37

L-MIMO-MC 2 (3C)

Maximum Output Power 20.5dBm per port:

Antenna	Modulation / Carrier bandwidth (MHz)	Conducted Output Power (dBm)		
		Channel Position B _{RFBW} 5180MHz+5200MHz+ 5220MHz	Channel Position M _{RFBW}	Channel Position T _{RFBW} 5200MHz+5220MHz+ 5240MHz
A	QPSK / 20.0 MHz	20.44	-	20.33
B		20.35	-	20.27
Total		23.41	-	23.31

Antenna	Modulation / Carrier bandwidth (MHz)	Conducted Output Power (dBm)		
		Channel Position B _{RFBW} 5180MHz+5200MHz+ 5220MHz	Channel Position M _{RFBW}	Channel Position T _{RFBW} 5200MHz+5220MHz+ 5240MHz
A	16QAM / 20.0 MHz	20.51	-	20.30
B		20.23	-	20.26
Total		23.39	-	23.29

Antenna	Modulation / Carrier bandwidth (MHz)	Conducted Output Power (dBm)		
		Channel Position B _{RFBW} 5180MHz+5200MHz+ 5220MHz	Channel Position M _{RFBW}	Channel Position T _{RFBW} 5200MHz+5220MHz+ 5240MHz
A	64QAM / 20.0 MHz	20.45	-	20.39
B		20.17	-	20.23
Total		23.33	-	23.32

Antenna	Modulation / Carrier bandwidth (MHz)	Conducted Output Power (dBm)		
		Channel Position B _{RFBW} 5180MHz+5200MHz+ 5220MHz	Channel Position M _{RFBW}	Channel Position T _{RFBW} 5200MHz+5220MHz+ 5240MHz
A	256QAM / 20.0 MHz	20.44	-	20.39
B		20.15	-	20.20
Total		23.31	-	23.31

Configuration A2

L-MIMO-SC

Maximum Output Power 20.5dBm per port:

Antenna	Modulation / Carrier bandwidth (MHz)	Conducted Output Power (dBm)		
		Channel Position B 5745MHz	Channel Position M 5785MHz	Channel Position T 5825MHz
A	QPSK / 20.0 MHz	20.38	20.57	20.65
B		20.31	20.51	20.62
Total		23.36	23.55	23.65

Antenna	Modulation / Carrier bandwidth (MHz)	Conducted Output Power (dBm)		
		Channel Position B 5745MHz	Channel Position M 5785MHz	Channel Position T 5825MHz
A	16QAM / 20.0 MHz	20.37	20.59	20.64
B		20.32	20.50	20.61
Total		23.36	23.56	23.64

Antenna	Modulation / Carrier bandwidth (MHz)	Conducted Output Power (dBm)		
		Channel Position B 5745MHz	Channel Position M 5785MHz	Channel Position T 5825MHz
A	64QAM / 20.0 MHz	20.46	20.62	20.64
B		20.40	20.49	20.60
Total		23.44	23.57	23.63

Antenna	Modulation / Carrier bandwidth (MHz)	Conducted Output Power (dBm)		
		Channel Position B 5745MHz	Channel Position M 5785MHz	Channel Position T 5825MHz
A	256QAM / 20.0 MHz	20.43	20.66	20.60
B		20.38	20.49	20.61
Total		23.42	23.59	23.62

L-MIMO-MC 1 (2C)

Maximum Output Power 20.5dBm per port:

Antenna	Modulation / Carrier bandwidth (MHz)	Conducted Output Power (dBm)		
		Channel Position B _{RFBW} 5745MHz+5785MHz	Channel Position M _{RFBW} 5765MHz+5805MHz	Channel Position T _{RFBW} 5785MHz+5825MHz
A	QPSK / 20.0 MHz	20.39	20.27	20.39
B		20.25	20.35	20.26
Total		23.34	23.32	23.34

Antenna	Modulation / Carrier bandwidth (MHz)	Conducted Output Power (dBm)		
		Channel Position B _{RFBW} 5745MHz+5785MHz	Channel Position M _{RFBW} 5765MHz+5805MHz	Channel Position T _{RFBW} 5785MHz+5825MHz
A	16QAM / 20.0 MHz	20.40	20.26	20.33
B		20.25	20.32	20.28
Total		23.34	23.30	23.32

Antenna	Modulation / Carrier bandwidth (MHz)	Conducted Output Power (dBm)		
		Channel Position B _{RFBW} 5745MHz+5785MHz	Channel Position M _{RFBW} 5765MHz+5805MHz	Channel Position T _{RFBW} 5785MHz+5825MHz
A	64QAM / 20.0 MHz	20.38	20.26	20.44
B		20.18	20.40	20.34
Total		23.30	23.34	23.40

Antenna	Modulation / Carrier bandwidth (MHz)	Conducted Output Power (dBm)		
		Channel Position B _{RFBW} 5745MHz+5785MHz	Channel Position M _{RFBW} 5765MHz+5805MHz	Channel Position T _{RFBW} 5785MHz+5825MHz
A	256QAM / 20.0 MHz	20.35	20.31	20.42
B		20.17	20.33	20.38
Total		23.28	23.33	23.41

L-MIMO-MC 2 (3C)

Maximum Output Power 20.5dBm per port:

Antenna	Modulation / Carrier bandwidth (MHz)	Conducted Output Power (dBm)		
		Channel Position B _{RFBW} 5745MHz+5765MHz+ 5785MHz	Channel Position M _{RFBW} 5765MHz+5785MHz+ 5805MHz	Channel Position T _{RFBW} 5785MHz+5805MHz+ 5825MHz
A	QPSK / 20.0 MHz	20.28	20.42	20.37
B		20.21	20.38	20.36
Total		23.26	23.26	23.41

Antenna	Modulation / Carrier bandwidth (MHz)	Conducted Output Power (dBm)		
		Channel Position B _{RFBW} 5745MHz+5765MHz+ 5785MHz	Channel Position M _{RFBW} 5765MHz+5785MHz+ 5805MHz	Channel Position T _{RFBW} 5785MHz+5805MHz+ 5825MHz
A	16QAM / 20.0 MHz	20.31	20.44	20.47
B		20.19	20.34	20.44
Total		23.26	23.40	23.47

Antenna	Modulation / Carrier bandwidth (MHz)	Conducted Output Power (dBm)		
		Channel Position B _{RFBW} 5745MHz+5765MHz+ 5785MHz	Channel Position M _{RFBW} 5765MHz+5785MHz+ 5805MHz	Channel Position T _{RFBW} 5785MHz+5805MHz+ 5825MHz
A	64QAM / 20.0 MHz	20.29	20.41	20.48
B		20.18	20.32	20.48
Total		23.25	23.38	23.49

Antenna	Modulation / Carrier bandwidth (MHz)	Conducted Output Power (dBm)		
		Channel Position B _{RFBW} 5745MHz+5765MHz+ 5785MHz	Channel Position M _{RFBW} 5765MHz+5785MHz+ 5805MHz	Channel Position T _{RFBW} 5785MHz+5805MHz+ 5825MHz
A	256QAM / 20.0 MHz	20.27	20.38	20.55
B		20.26	20.32	20.43
Total		23.28	23.36	23.50

Configuration A3

L-MIMO-SC

Maximum Output Power 8.5dBm per port:

Antenna	Modulation / Carrier bandwidth (MHz)	Conducted Output Power (dBm)		
		Channel Position B 5180MHz	Channel Position M 5220MHz	Channel Position T 5240MHz
A	QPSK / 20.0 MHz	8.81	8.68	8.58
B		8.50	8.49	8.39
Total		11.67	11.60	11.50

Antenna	Modulation / Carrier bandwidth (MHz)	Conducted Output Power (dBm)		
		Channel Position B 5180MHz	Channel Position M 5220MHz	Channel Position T 5240MHz
A	16QAM / 20.0 MHz	8.91	8.68	8.61
B		8.50	8.47	8.47
Total		11.72	11.59	11.55

Antenna	Modulation / Carrier bandwidth (MHz)	Conducted Output Power (dBm)		
		Channel Position B 5180MHz	Channel Position M 5220MHz	Channel Position T 5240MHz
A	64QAM / 20.0 MHz	8.88	8.65	8.64
B		8.53	8.44	8.46
Total		11.72	11.56	11.57

Antenna	Modulation / Carrier bandwidth (MHz)	Conducted Output Power (dBm)		
		Channel Position B 5180MHz	Channel Position M 5220MHz	Channel Position T 5240MHz
A	256QAM / 20.0 MHz	8.86	8.63	8.68
B		8.50	8.43	8.50
Total		11.70	11.55	11.61

L-MIMO-MC 1 (2C)

Maximum Output Power 8.5dBm per port:

Antenna	Modulation / Carrier bandwidth (MHz)	Conducted Output Power (dBm)		
		Channel Position B _{RFBW} 5180MHz+5220MHz	Channel Position M _{RFBW}	Channel Position T _{RFBW} 5200MHz+5240MHz
A	QPSK / 20.0 MHz	8.50	-	8.45
B		8.27	-	8.27
Total		11.40	-	11.38

Antenna	Modulation / Carrier bandwidth (MHz)	Conducted Output Power (dBm)		
		Channel Position B _{RFBW} 5180MHz+5220MHz	Channel Position M _{RFBW}	Channel Position T _{RFBW} 5200MHz+5240MHz
A	16QAM / 20.0 MHz	8.60	-	8.40
B		8.26	-	8.33
Total		11.45	-	11.38

Antenna	Modulation / Carrier bandwidth (MHz)	Conducted Output Power (dBm)		
		Channel Position B _{RFBW} 5180MHz+5220MHz	Channel Position M _{RFBW}	Channel Position T _{RFBW} 5200MHz+5240MHz
A	64QAM / 20.0 MHz	8.58	-	8.48
B		8.28	-	8.31
Total		11.45	-	11.41

Antenna	Modulation / Carrier bandwidth (MHz)	Conducted Output Power (dBm)		
		Channel Position B _{RFBW} 5180MHz+5220MHz	Channel Position M _{RFBW}	Channel Position T _{RFBW} 5200MHz+5240MHz
A	256QAM / 20.0 MHz	8.48	-	8.47
B		8.29	-	8.30
Total		11.40	-	11.40

L-MIMO-MC 2 (3C)

Maximum Output Power 8.5dBm per port:

Antenna	Modulation / Carrier bandwidth (MHz)	Conducted Output Power (dBm)		
		Channel Position B _{RFBW} 5180MHz+5200MHz+ 5220MHz	Channel Position M _{RFBW}	Channel Position T _{RFBW} 5200MHz+5220MHz+ 5240MHz
A	QPSK / 20.0 MHz	8.57	-	8.56
B		8.37	-	8.33
Total		11.49	-	11.46

Antenna	Modulation / Carrier bandwidth (MHz)	Conducted Output Power (dBm)		
		Channel Position B _{RFBW} 5180MHz+5200MHz+ 5220MHz	Channel Position M _{RFBW}	Channel Position T _{RFBW} 5200MHz+5220MHz+ 5240MHz
A	16QAM / 20.0 MHz	8.54	-	8.45
B		8.34	-	8.31
Total		11.46	-	11.39

Antenna	Modulation / Carrier bandwidth (MHz)	Conducted Output Power (dBm)		
		Channel Position B _{RFBW} 5180MHz+5200MHz+ 5220MHz	Channel Position M _{RFBW}	Channel Position T _{RFBW} 5200MHz+5220MHz+ 5240MHz
A	64QAM / 20.0 MHz	8.61	-	8.45
B		8.28	-	8.28
Total		11.46	-	11.38

Antenna	Modulation / Carrier bandwidth (MHz)	Conducted Output Power (dBm)		
		Channel Position B _{RFBW} 5180MHz+5200MHz+ 5220MHz	Channel Position M _{RFBW}	Channel Position T _{RFBW} 5200MHz+5220MHz+ 5240MHz
A	256QAM / 20.0 MHz	8.60	-	8.50
B		8.28	-	8.28
Total		11.46	-	11.41

Configuration B1

L-MIMO-SC

Maximum Output Power 25dBm per port:

Antenna	Modulation / Carrier bandwidth (MHz)	Conducted Output Power (dBm)		
		Channel Position B 5180MHz	Channel Position M 5220MHz	Channel Position T 5240MHz
A	QPSK / 20.0 MHz	25.12	25.11	25.05
B		24.95	24.96	24.85
Total		28.05	28.05	27.97

Antenna	Modulation / Carrier bandwidth (MHz)	Conducted Output Power (dBm)		
		Channel Position B 5180MHz	Channel Position M 5220MHz	Channel Position T 5240MHz
A	16QAM / 20.0 MHz	25.09	25.10	25.04
B		24.93	24.96	24.87
Total		28.02	28.04	27.97

Antenna	Modulation / Carrier bandwidth (MHz)	Conducted Output Power (dBm)		
		Channel Position B 5180MHz	Channel Position M 5220MHz	Channel Position T 5240MHz
A	64QAM / 20.0 MHz	25.09	25.14	25.01
B		24.98	24.92	24.82
Total		28.05	28.05	27.93

Antenna	Modulation / Carrier bandwidth (MHz)	Conducted Output Power (dBm)		
		Channel Position B 5180MHz	Channel Position M 5220MHz	Channel Position T 5240MHz
A	256QAM / 20.0 MHz	25.16	25.18	25.00
B		24.90	25.00	24.87
Total		28.05	28.11	27.95

L-MIMO-MC 1 (2C)

Maximum Output Power 25dBm per port:

Antenna	Modulation / Carrier bandwidth (MHz)	Conducted Output Power (dBm)		
		Channel Position B _{RFBW} 5180MHz+5220MHz	Channel Position M _{RFBW}	Channel Position T _{RFBW} 5200MHz+5240MHz
A	QPSK / 20.0 MHz	24.87	-	24.82
B		24.67	-	24.72
Total		27.79	-	27.78

Antenna	Modulation / Carrier bandwidth (MHz)	Conducted Output Power (dBm)		
		Channel Position B _{RFBW} 5180MHz+5220MHz	Channel Position M _{RFBW}	Channel Position T _{RFBW} 5200MHz+5240MHz
A	16QAM / 20.0 MHz	24.93	-	24.77
B		24.67	-	24.68
Total		27.82	-	27.74

Antenna	Modulation / Carrier bandwidth (MHz)	Conducted Output Power (dBm)		
		Channel Position B _{RFBW} 5180MHz+5220MHz	Channel Position M _{RFBW}	Channel Position T _{RFBW} 5200MHz+5240MHz
A	64QAM / 20.0 MHz	24.82	-	24.70
B		24.65	-	24.70
Total		27.75	-	27.71

Antenna	Modulation / Carrier bandwidth (MHz)	Conducted Output Power (dBm)		
		Channel Position B _{RFBW} 5180MHz+5220MHz	Channel Position M _{RFBW}	Channel Position T _{RFBW} 5200MHz+5240MHz
A	256QAM / 20.0 MHz	24.84	-	24.80
B		24.71	-	24.65
Total		27.79	-	27.74

L-MIMO-MC 2 (3C)

Maximum Output Power 25dBm per port:

Antenna	Modulation / Carrier bandwidth (MHz)	Conducted Output Power (dBm)		
		Channel Position B _{RFBW} 5180MHz+5200MHz+ 5220MHz	Channel Position M _{RFBW}	Channel Position T _{RFBW} 5200MHz+5220MHz+ 5240MHz
A	QPSK / 20.0 MHz	24.84	-	24.80
B		24.75	-	24.66
Total		27.81	-	27.74

Antenna	Modulation / Carrier bandwidth (MHz)	Conducted Output Power (dBm)		
		Channel Position B _{RFBW} 5180MHz+5200MHz+ 5220MHz	Channel Position M _{RFBW}	Channel Position T _{RFBW} 5200MHz+5220MHz+ 5240MHz
A	16QAM / 20.0 MHz	24.82	-	24.79
B		24.74	-	24.68
Total		27.79	-	27.75

Antenna	Modulation / Carrier bandwidth (MHz)	Conducted Output Power (dBm)		
		Channel Position B _{RFBW} 5180MHz+5200MHz+ 5220MHz	Channel Position M _{RFBW}	Channel Position T _{RFBW} 5200MHz+5220MHz+ 5240MHz
A	64QAM / 20.0 MHz	24.80	-	24.77
B		24.75	-	24.62
Total		27.79	-	27.71

Antenna	Modulation / Carrier bandwidth (MHz)	Conducted Output Power (dBm)		
		Channel Position B _{RFBW} 5180MHz+5200MHz+ 5220MHz	Channel Position M _{RFBW}	Channel Position T _{RFBW} 5200MHz+5220MHz+ 5240MHz
A	256QAM / 20.0 MHz	24.81	-	24.76
B		24.73	-	24.61
Total		27.78	-	27.70

Configuration B2

L-MIMO-SC

Maximum Output Power 25dBm per port:

Antenna	Modulation / Carrier bandwidth (MHz)	Conducted Output Power (dBm)		
		Channel Position B 5745MHz	Channel Position M 5785MHz	Channel Position T 5825MHz
A	QPSK / 20.0 MHz	24.99	25.14	25.22
B		24.85	24.94	25.08
Total		27.93	28.06	28.16

Antenna	Modulation / Carrier bandwidth (MHz)	Conducted Output Power (dBm)		
		Channel Position B 5745MHz	Channel Position M 5785MHz	Channel Position T 5825MHz
A	16QAM / 20.0 MHz	24.93	25.16	25.22
B		24.84	24.93	25.06
Total		27.90	28.06	28.15

Antenna	Modulation / Carrier bandwidth (MHz)	Conducted Output Power (dBm)		
		Channel Position B 5745MHz	Channel Position M 5785MHz	Channel Position T 5825MHz
A	64QAM / 20.0 MHz	24.93	25.17	25.26
B		24.87	24.90	25.04
Total		27.91	28.05	28.17

Antenna	Modulation / Carrier bandwidth (MHz)	Conducted Output Power (dBm)		
		Channel Position B 5745MHz	Channel Position M 5785MHz	Channel Position T 5825MHz
A	256QAM / 20.0 MHz	24.94	25.10	25.10
B		24.93	24.89	25.03
Total		27.95	28.01	28.08

L-MIMO-MC 1 (2C)

Maximum Output Power 25dBm per port:

Antenna	Modulation / Carrier bandwidth (MHz)	Conducted Output Power (dBm)		
		Channel Position B _{RFBW} 5745MHz+5785MHz	Channel Position M _{RFBW} 5765MHz+5805MHz	Channel Position T _{RFBW} 5785MHz+5825MHz
A	QPSK / 20.0 MHz	24.73	24.80	24.93
B		24.75	24.82	24.53
Total		27.75	27.82	27.75

Antenna	Modulation / Carrier bandwidth (MHz)	Conducted Output Power (dBm)		
		Channel Position B _{RFBW} 5745MHz+5785MHz	Channel Position M _{RFBW} 5765MHz+5805MHz	Channel Position T _{RFBW} 5785MHz+5825MHz
A	16QAM / 20.0 MHz	24.75	24.81	24.90
B		24.68	24.78	24.72
Total		27.73	27.81	27.83

Antenna	Modulation / Carrier bandwidth (MHz)	Conducted Output Power (dBm)		
		Channel Position B _{RFBW} 5745MHz+5785MHz	Channel Position M _{RFBW} 5765MHz+5805MHz	Channel Position T _{RFBW} 5785MHz+5825MHz
A	64QAM / 20.0 MHz	24.74	24.78	24.84
B		24.60	24.83	24.69
Total		27.68	27.82	27.78

Antenna	Modulation / Carrier bandwidth (MHz)	Conducted Output Power (dBm)		
		Channel Position B _{RFBW} 5745MHz+5785MHz	Channel Position M _{RFBW} 5765MHz+5805MHz	Channel Position T _{RFBW} 5785MHz+5825MHz
A	256QAM / 20.0 MHz	24.76	24.84	24.92
B		24.65	24.85	24.79
Total		27.72	27.86	27.87

L-MIMO-MC 2 (3C)

Maximum Output Power 25dBm per port:

Antenna	Modulation / Carrier bandwidth (MHz)	Conducted Output Power (dBm)		
		Channel Position B _{RFBW} 5745MHz+5765MHz+ 5785MHz	Channel Position M _{RFBW} 5765MHz+5785MHz+ 5805MHz	Channel Position T _{RFBW} 5785MHz+5805MHz+ 5825MHz
A	QPSK / 20.0 MHz	24.78	24.90	24.94
B		24.68	24.82	24.89
Total		27.74	27.87	27.93

Antenna	Modulation / Carrier bandwidth (MHz)	Conducted Output Power (dBm)		
		Channel Position B _{RFBW} 5745MHz+5765MHz+ 5785MHz	Channel Position M _{RFBW} 5765MHz+5785MHz+ 5805MHz	Channel Position T _{RFBW} 5785MHz+5805MHz+ 5825MHz
A	16QAM / 20.0 MHz	24.81	24.82	24.96
B		24.72	24.80	24.86
Total		27.78	27.82	27.92

Antenna	Modulation / Carrier bandwidth (MHz)	Conducted Output Power (dBm)		
		Channel Position B _{RFBW} 5745MHz+5765MHz+ 5785MHz	Channel Position M _{RFBW} 5765MHz+5785MHz+ 5805MHz	Channel Position T _{RFBW} 5785MHz+5805MHz+ 5825MHz
A	64QAM / 20.0 MHz	24.80	24.86	24.93
B		24.76	24.76	24.87
Total		27.79	27.82	27.91

Antenna	Modulation / Carrier bandwidth (MHz)	Conducted Output Power (dBm)		
		Channel Position B _{RFBW} 5745MHz+5765MHz+ 5785MHz	Channel Position M _{RFBW} 5765MHz+5785MHz+ 5805MHz	Channel Position T _{RFBW} 5785MHz+5805MHz+ 5825MHz
A	256QAM / 20.0 MHz	24.79	24.93	24.88
B		24.66	24.86	24.83
Total		27.74	27.91	27.87

Configuration B3

L-MIMO-SC

Maximum Output Power 12.0dBm per port:

Antenna	Modulation / Carrier bandwidth (MHz)	Conducted Output Power (dBm)		
		Channel Position B 5180MHz	Channel Position M 5220MHz	Channel Position T 5240MHz
A	QPSK / 20.0 MHz	12.05	12.02	12.03
B		11.91	11.87	11.79
Total		14.99	14.96	14.93

Antenna	Modulation / Carrier bandwidth (MHz)	Conducted Output Power (dBm)		
		Channel Position B 5180MHz	Channel Position M 5220MHz	Channel Position T 5240MHz
A	16QAM / 20.0 MHz	12.04	12.02	12.03
B		11.92	11.86	11.78
Total		14.99	14.95	14.92

Antenna	Modulation / Carrier bandwidth (MHz)	Conducted Output Power (dBm)		
		Channel Position B 5180MHz	Channel Position M 5220MHz	Channel Position T 5240MHz
A	64QAM / 20.0 MHz	12.12	11.98	12.00
B		11.87	11.84	11.76
Total		15.01	14.92	14.90

Antenna	Modulation / Carrier bandwidth (MHz)	Conducted Output Power (dBm)		
		Channel Position B 5180MHz	Channel Position M 5220MHz	Channel Position T 5240MHz
A	256QAM / 20.0 MHz	12.11	11.98	11.98
B		11.91	11.83	11.86
Total		15.03	14.92	14.93

L-MIMO-MC 1 (2C)

Maximum Output Power 12.0dBm per port:

Antenna	Modulation / Carrier bandwidth (MHz)	Conducted Output Power (dBm)		
		Channel Position B _{RFBW} 5180MHz+5220MHz	Channel Position M _{RFBW}	Channel Position T _{RFBW} 5200MHz+5240MHz
A	QPSK / 20.0 MHz	11.74	-	11.77
B		11.61	-	11.54
Total		14.69	-	14.67

Antenna	Modulation / Carrier bandwidth (MHz)	Conducted Output Power (dBm)		
		Channel Position B _{RFBW} 5180MHz+5220MHz	Channel Position M _{RFBW}	Channel Position T _{RFBW} 5200MHz+5240MHz
A	16QAM / 20.0 MHz	11.82	-	11.76
B		11.60	-	11.59
Total		14.73	-	14.69

Antenna	Modulation / Carrier bandwidth (MHz)	Conducted Output Power (dBm)		
		Channel Position B _{RFBW} 5180MHz+5220MHz	Channel Position M _{RFBW}	Channel Position T _{RFBW} 5200MHz+5240MHz
A	64QAM / 20.0 MHz	11.80	-	11.74
B		11.60	-	11.64
Total		14.72	-	14.70

Antenna	Modulation / Carrier bandwidth (MHz)	Conducted Output Power (dBm)		
		Channel Position B _{RFBW} 5180MHz+5220MHz	Channel Position M _{RFBW}	Channel Position T _{RFBW} 5200MHz+5240MHz
A	256QAM / 20.0 MHz	11.88	-	11.73
B		11.59	-	11.64
Total		14.75	-	14.70

L-MIMO-MC 2 (3C)

Maximum Output Power 12.0dBm per port:

Antenna	Modulation / Carrier bandwidth (MHz)	Conducted Output Power (dBm)		
		Channel Position B _{RFBW} 5180MHz+5200MHz+ 5220MHz	Channel Position M _{RFBW}	Channel Position T _{RFBW} 5200MHz+5220MHz+ 5240MHz
A	QPSK / 20.0 MHz	11.90	-	11.87
B		11.72	-	11.74
Total		14.83	-	14.82

Antenna	Modulation / Carrier bandwidth (MHz)	Conducted Output Power (dBm)		
		Channel Position B _{RFBW} 5180MHz+5200MHz+ 5220MHz	Channel Position M _{RFBW}	Channel Position T _{RFBW} 5200MHz+5220MHz+ 5240MHz
A	16QAM / 20.0 MHz	11.90	-	11.93
B		11.70	-	11.72
Total		14.82	-	14.84

Antenna	Modulation / Carrier bandwidth (MHz)	Conducted Output Power (dBm)		
		Channel Position B _{RFBW} 5180MHz+5200MHz+ 5220MHz	Channel Position M _{RFBW}	Channel Position T _{RFBW} 5200MHz+5220MHz+ 5240MHz
A	64QAM / 20.0 MHz	11.88	-	11.94
B		11.68	-	11.72
Total		14.80	-	14.85

Antenna	Modulation / Carrier bandwidth (MHz)	Conducted Output Power (dBm)		
		Channel Position B _{RFBW} 5180MHz+5200MHz+ 5220MHz	Channel Position M _{RFBW}	Channel Position T _{RFBW} 5200MHz+5220MHz+ 5240MHz
A	256QAM / 20.0 MHz	11.87	-	11.97
B		11.68	-	11.77
Total		14.79	-	14.89

Maximum Output Power and Maximum E.I.R.P.

	Configuration A1	Configuration A2	Configuration A3	Configuration B1	Configuration B2	Configuration B3
Maximum Total Output Power (dBm)	23.67	23.65	11.72	28.11	28.17	15.03
Maximum E.I.R.P. (dBm)	33.17	33.15	21.22	34.11	34.17	21.03
Outdoor Maximum E.I.R.P *	< 16.67	< 16.65	-	< 19.11	< 19.17	-

“*” The Maximum Gain at elevation angle above 30 degrees was less than -7dBi for Configuration A and less than -9dBi for Configuration B.

Configuration A3 E.I.R.P. limit calculation:

Frequency range (MHz)	Modulation	Min 99% emission Bandwidth (MHz)	10+10log B (dBm)	Chosen Limit (dBm)
5150 - 5250	QPSK	17.896	22.53	22.53
	16QAM	17.856	22.52	22.52
	64QAM	17.870	22.52	22.52
	256QAM	17.888	22.53	22.53

Note: Chosen limit is 23dBm or 10dBm + 10logB(99% OBW), which is lesser

Configuration B3 E.I.R.P. limit calculation:

Frequency range (MHz)	Modulation	Min 99% emission Bandwidth (MHz)	10+10log B (dBm)	Chosen Limit (dBm)
5150 - 5250	QPSK	17.794	22.50	22.50
	16QAM	17.869	22.52	22.52
	64QAM	17.864	22.52	22.52
	256QAM	17.881	22.52	22.52

Note: Chosen limit is 23dBm or 10dBm + 10logB(99% OBW), which is lesser

4 Power Spectrum Density

Test result: Pass

4.1 Limit

For an outdoor access point operating in the band 5.15-5.25 GHz, the maximum power spectral density shall not exceed 17 dBm in any 1 megahertz band.

For an indoor access point operating in the band 5.15-5.25 GHz, the maximum power spectral density shall not exceed 17 dBm in any 1 megahertz band.

For mobile and portable client devices in the 5.15-5.25 GHz band, the maximum power spectral density shall not exceed 11 dBm in any 1 megahertz band.

For the band 5.725-5.85 GHz, the maximum power spectral density shall not exceed 30 dBm in any 500 kHz band.

For the 5.15-5.25 GHz The e.i.r.p. spectral density shall not exceed 10 dBm in any 1.0 MHz band. (IC)

If the transmitting antenna of directional gain greater than 6dBi is used, the power shall be reduced by the amount in dB that the directional gain of the antenna exceeds 6dBi. If there have a beam forming type, the limit should be the less of original and original + (6 - antenna gain - beamforming gain).

4.2 Test method

The test was applied in accordance with the test method requirements of FCC CFR 47 Part 15, Clause 15.407(a) and RSS-247 Clause 6.

Using a Spectrum Analyzer and attenuator(s), the Power Spectral Density (PSD) of the EUT was measured at the antenna terminal. The path loss between the EUT and the Spectrum Analyzer was measured and recorded for the test band. The path loss and duty cycle factor were entered as an offset into Spectrum Analyzer.

The EUT was configured to transmit on maximum power on the configurations defined in the tables below. Since the EUT transmits on two antennas simultaneously in the same frequency range for MIMO devices, i.e., TX MIMO mode, using the Measure-and-Sum approach, the PSD at both antennas were tested, and the total PSD were then summed mathematically in linear power units according to FCC KDB 662911 D01.

The PSD was measured and recorded with the results being compared with the limits.

4.3 Test Results

Configuration A1

L-MIMO-SC

Maximum Output Power 20.5dBm per port:

Antenna	Modulation / Carrier bandwidth (MHz)	Power Spectrum Density (dBm)		
		Channel Position B 5180MHz	Channel Position M 5220MHz	Channel Position T 5240MHz
A	QPSK / 20.0 MHz	8.747	8.467	8.581
B		8.721	8.849	8.693
Total		11.744	11.672	11.648

Antenna	Modulation / Carrier bandwidth (MHz)	Power Spectrum Density (dBm)		
		Channel Position B 5180MHz	Channel Position M 5220MHz	Channel Position T 5240MHz
A	16QAM / 20.0 MHz	9.399	9.645	9.443
B		9.149	9.402	9.198
Total		12.286	12.535	12.333

Antenna	Modulation / Carrier bandwidth (MHz)	Power Spectrum Density (dBm)		
		Channel Position B 5180MHz	Channel Position M 5220MHz	Channel Position T 5240MHz
A	64QAM / 20.0 MHz	8.542	8.856	8.537
B		8.797	8.545	8.452
Total		11.682	11.714	11.505

Antenna	Modulation / Carrier bandwidth (MHz)	Power Spectrum Density (dBm)		
		Channel Position B 5180MHz	Channel Position M 5220MHz	Channel Position T 5240MHz
A	256QAM / 20.0 MHz	8.861	8.876	8.747
B		8.734	8.685	8.622
Total		11.808	11.792	11.695

Channel Position B - QPSK - Antenna A/ Bandwidth 20.0 MHz

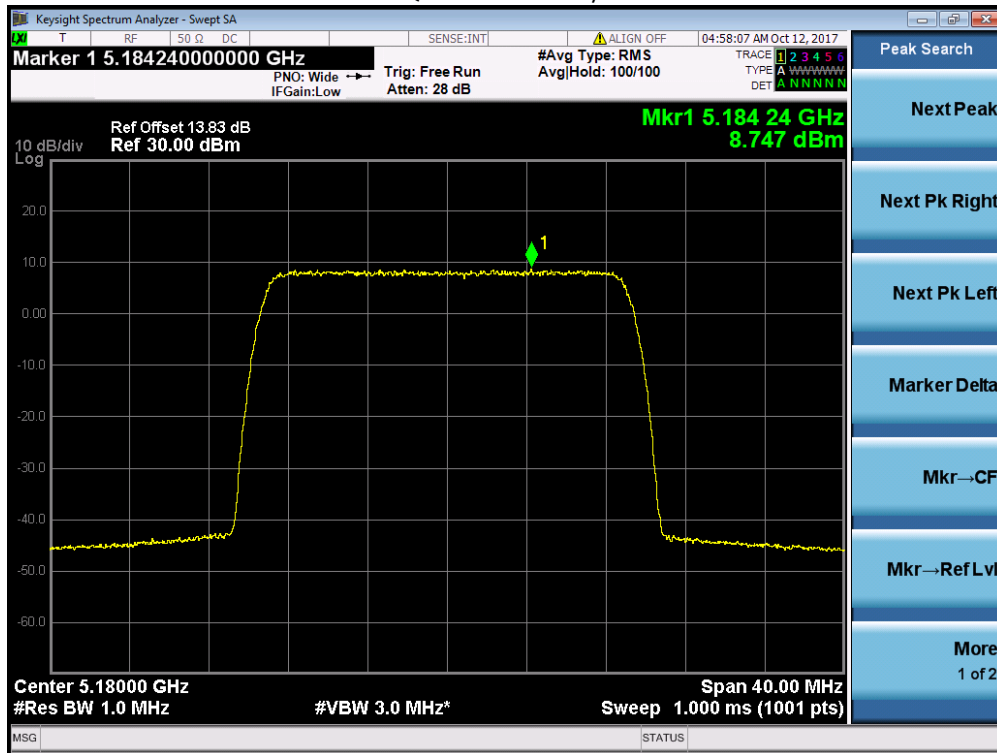

Channel Position B - QPSK - Antenna B/ Bandwidth 20.0 MHz

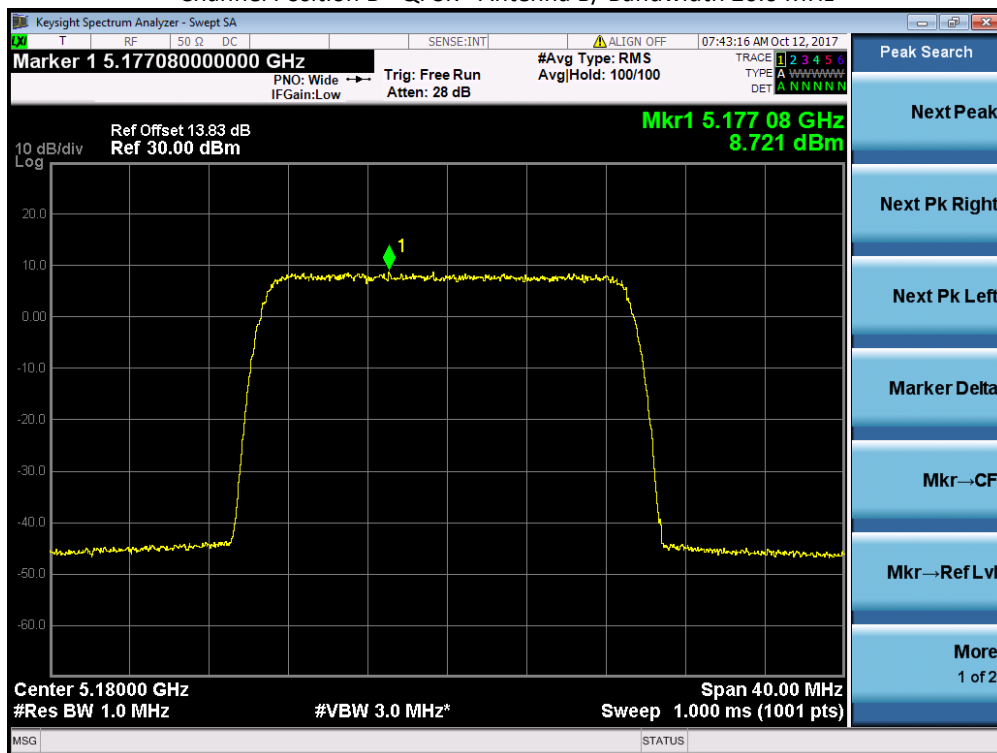

Channel Position M – QPSK - Antenna A/ Bandwidth 20.0 MHz

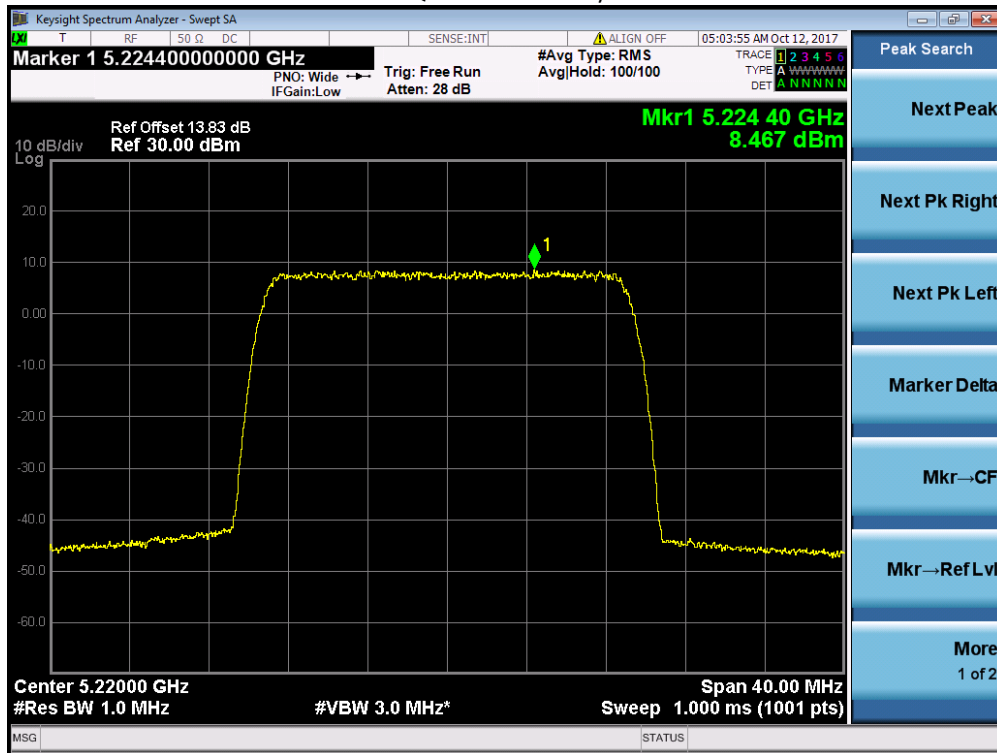

Channel Position M - QPSK - Antenna B/ Bandwidth 20.0 MHz

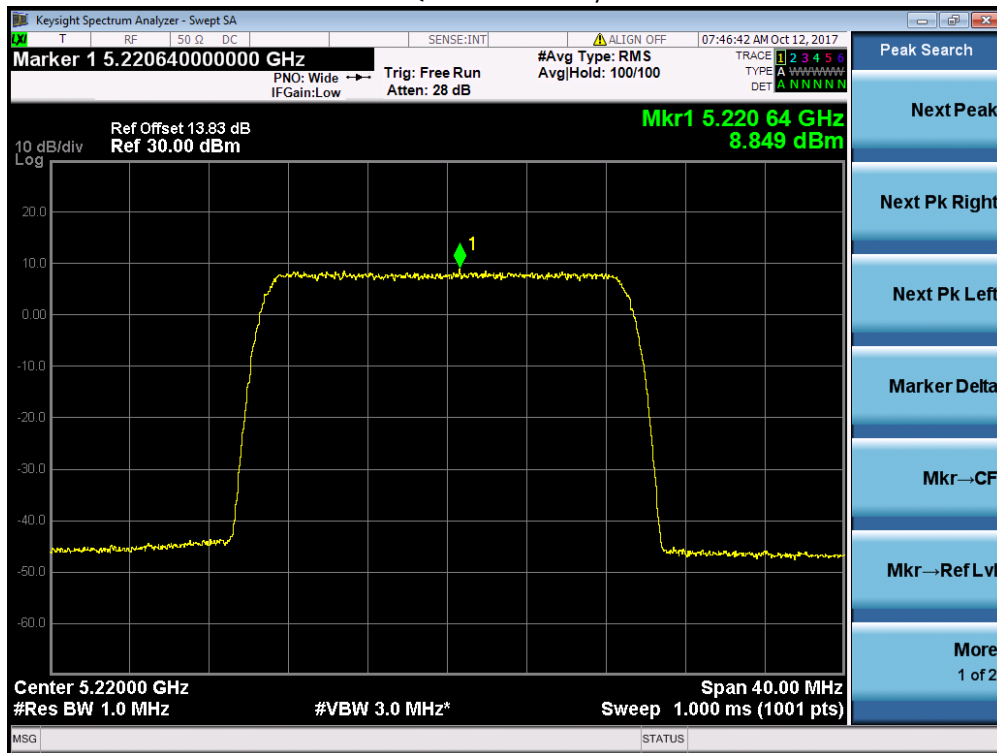

Channel Position T - QPSK - Antenna A/ Bandwidth 20.0 MHz

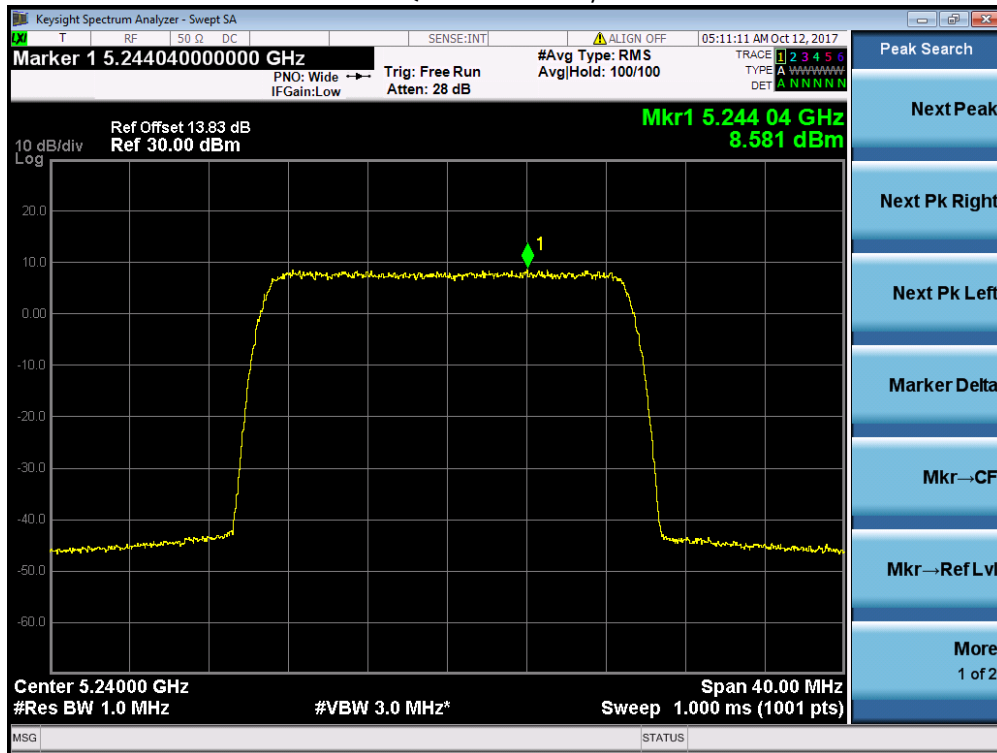

Channel Position T - QPSK - Antenna B/ Bandwidth 20.0 MHz

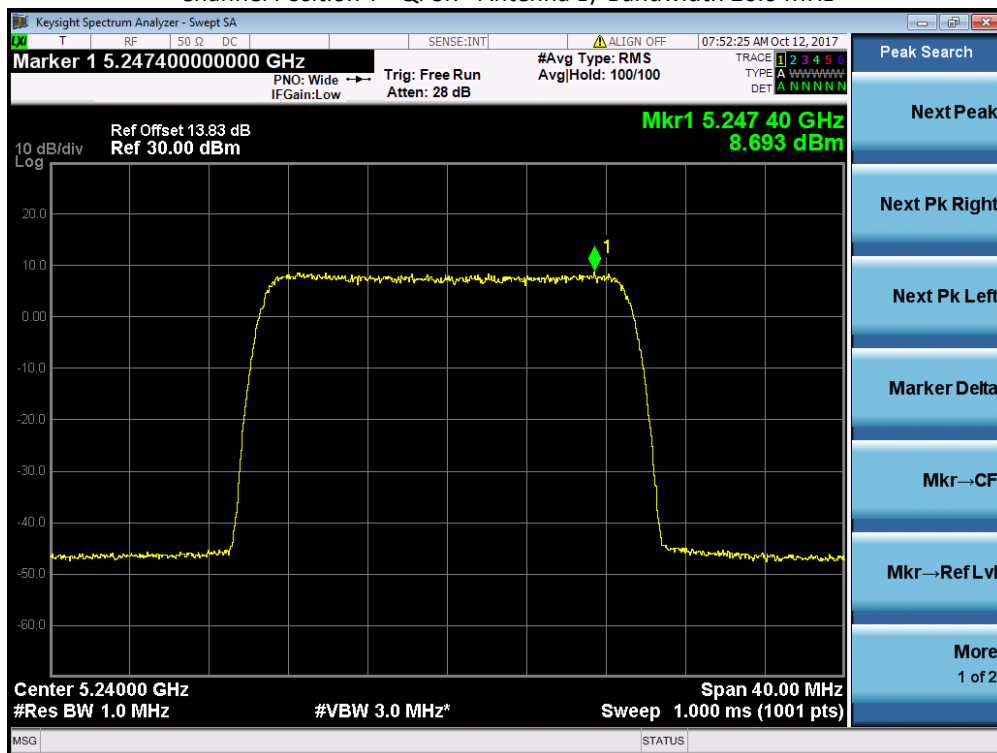

Channel Position B - 16QAM - Antenna A/ Bandwidth 20.0 MHz

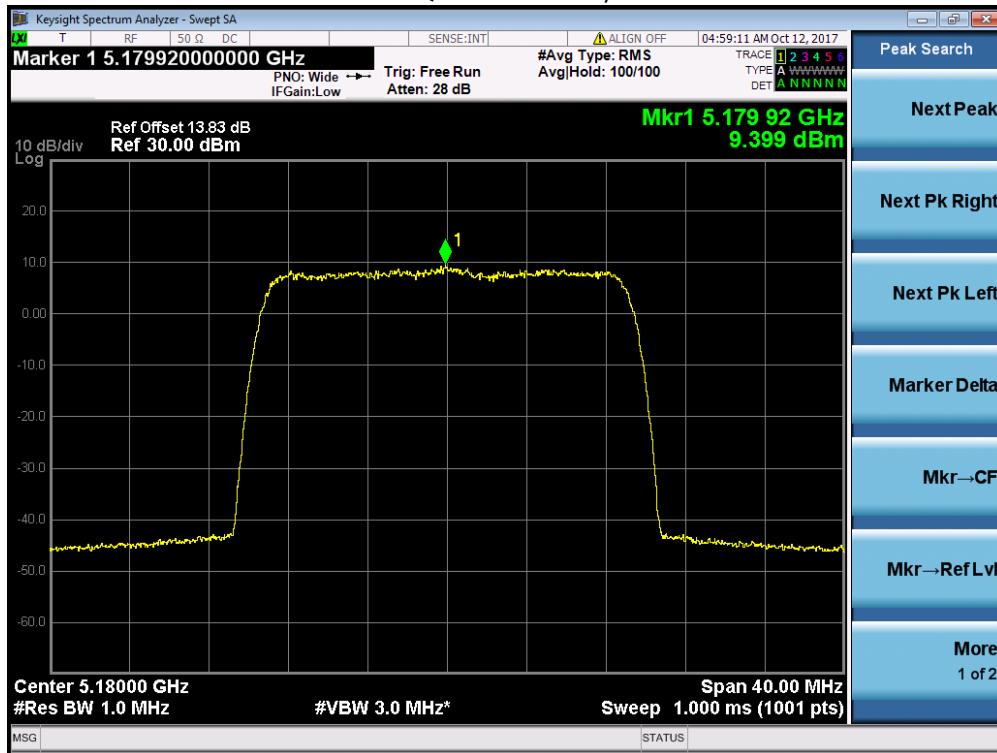

Channel Position B - 16QAM - Antenna B/ Bandwidth 20.0 MHz

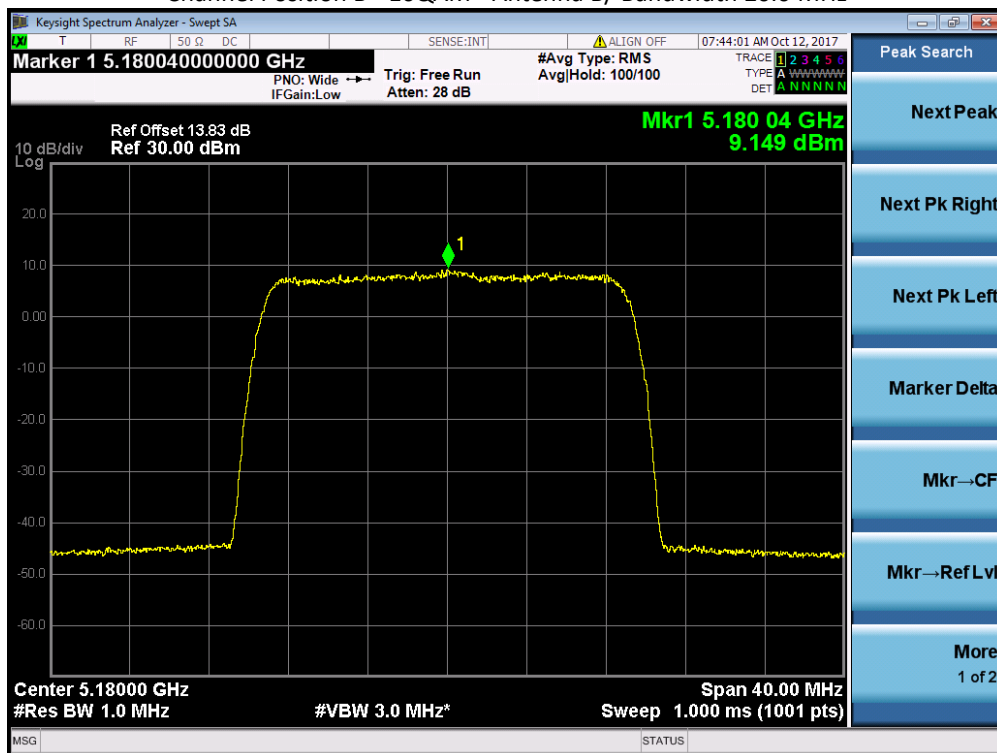

Channel Position M - 16QAM - Antenna A/ Bandwidth 20.0 MHz

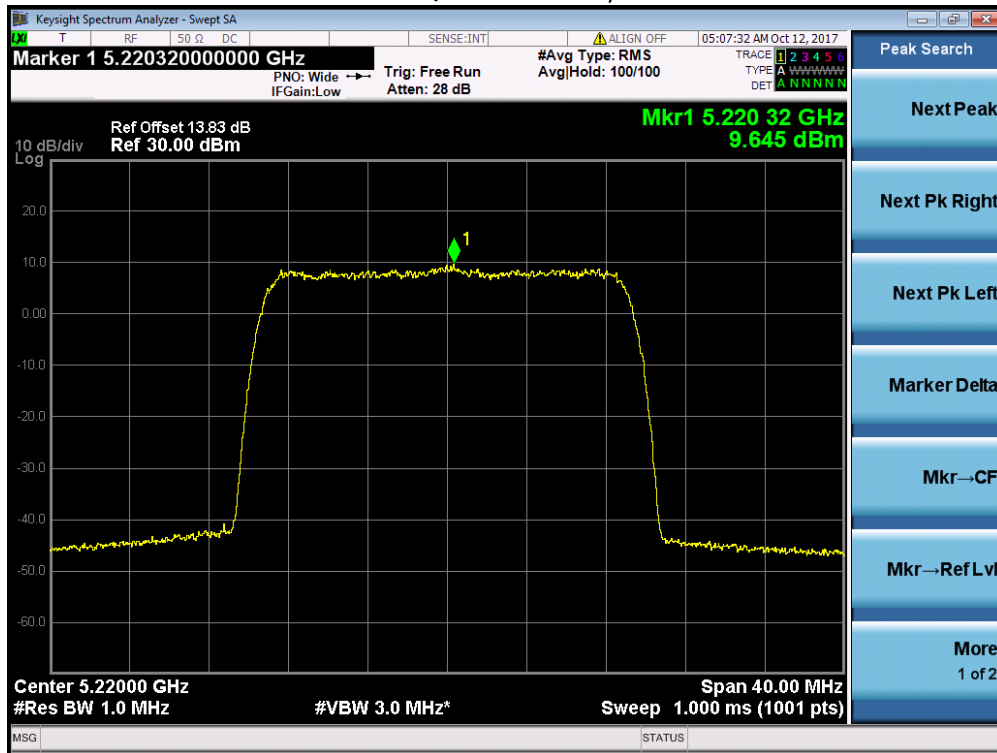

Channel Position M - 16QAM - Antenna B/ Bandwidth 20.0 MHz

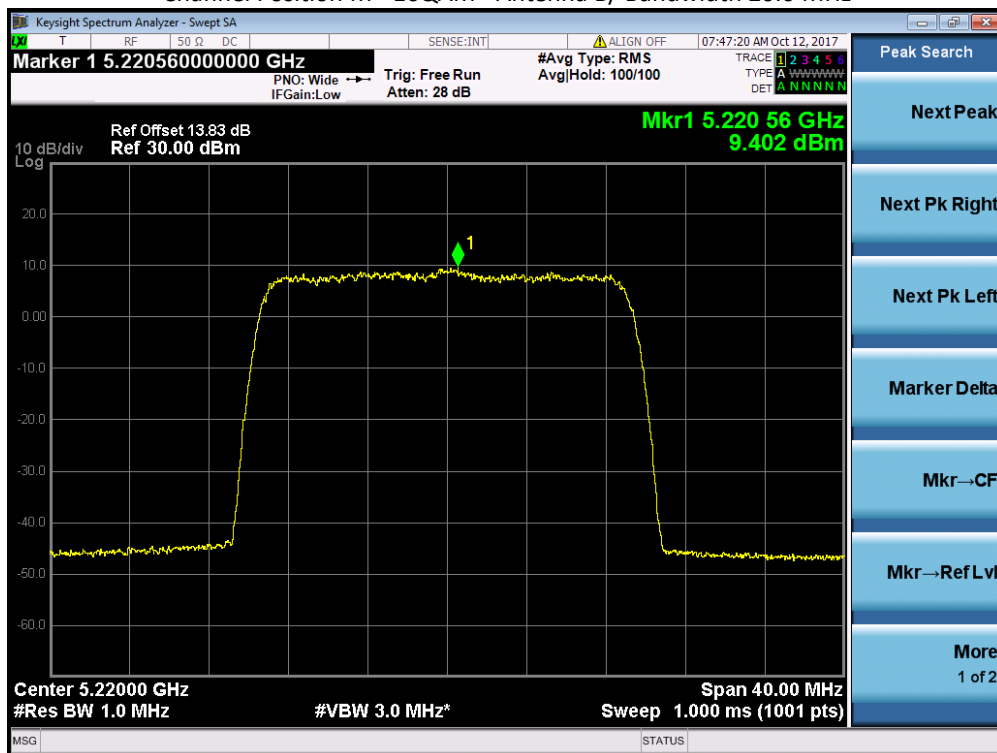

Channel Position T - 16QAM - Antenna A/ Bandwidth 20.0 MHz

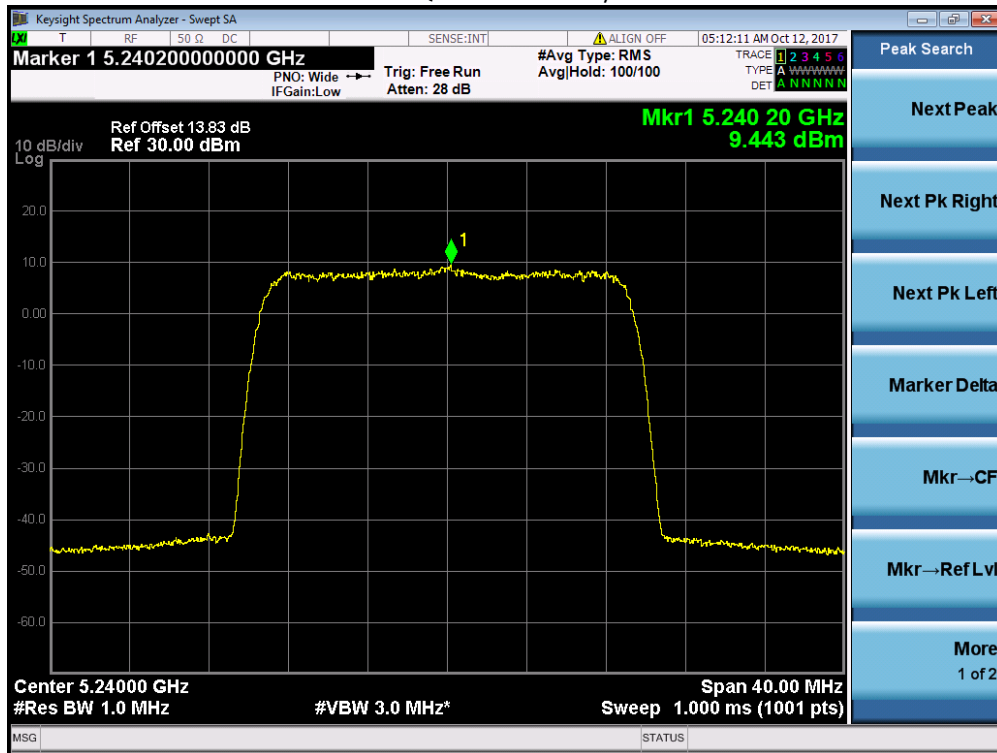

Channel Position T - 16QAM - Antenna B/ Bandwidth 20.0 MHz

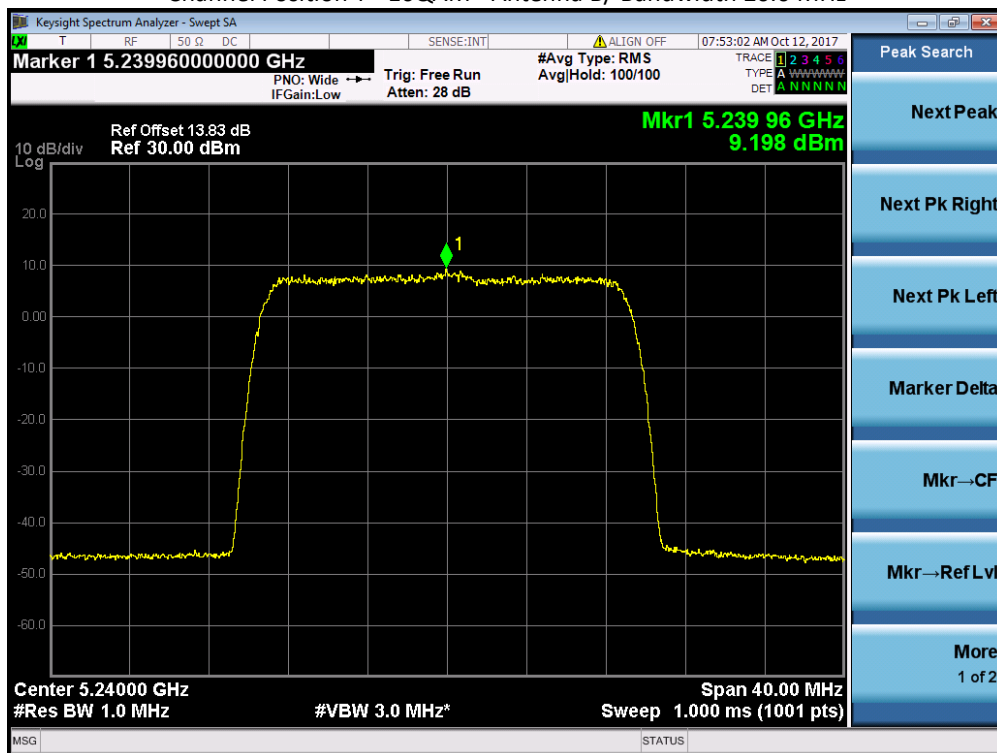

Channel Position B - 64QAM - Antenna A/ Bandwidth 20.0 MHz

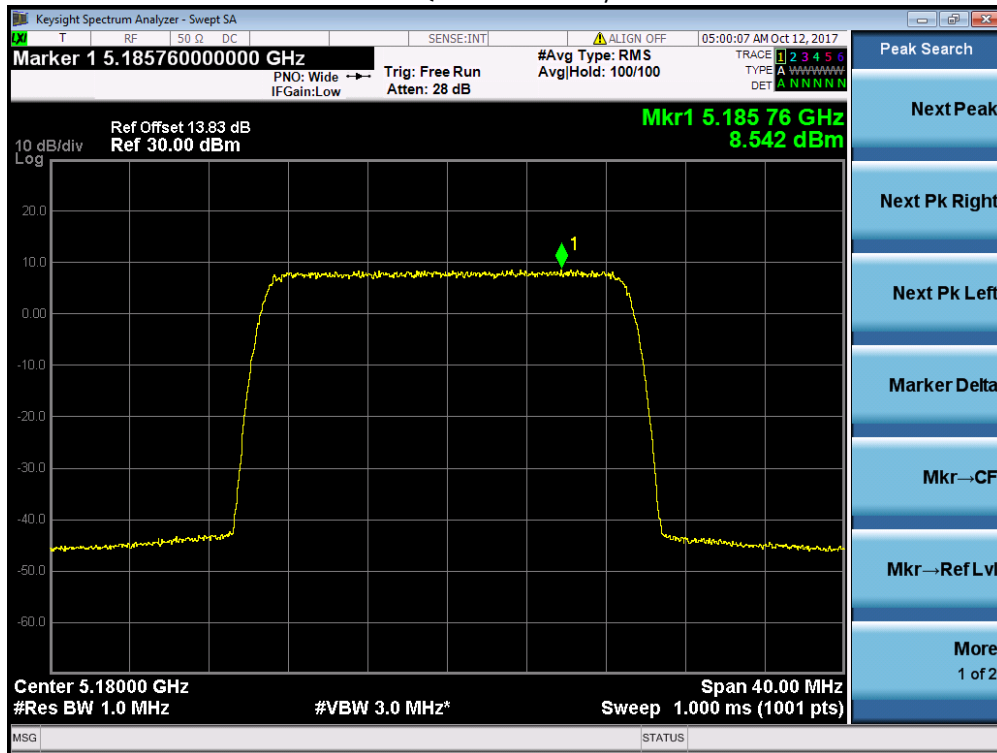

Channel Position B - 64QAM - Antenna B/ Bandwidth 20.0 MHz

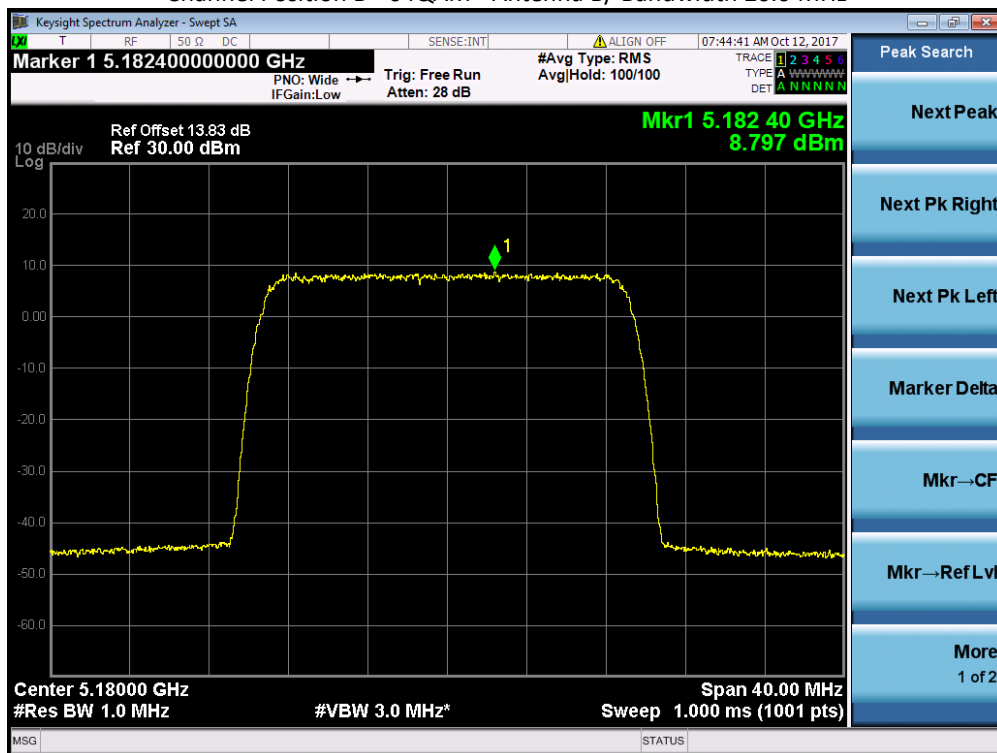

Channel Position M - 64QAM - Antenna A/ Bandwidth 20.0 MHz

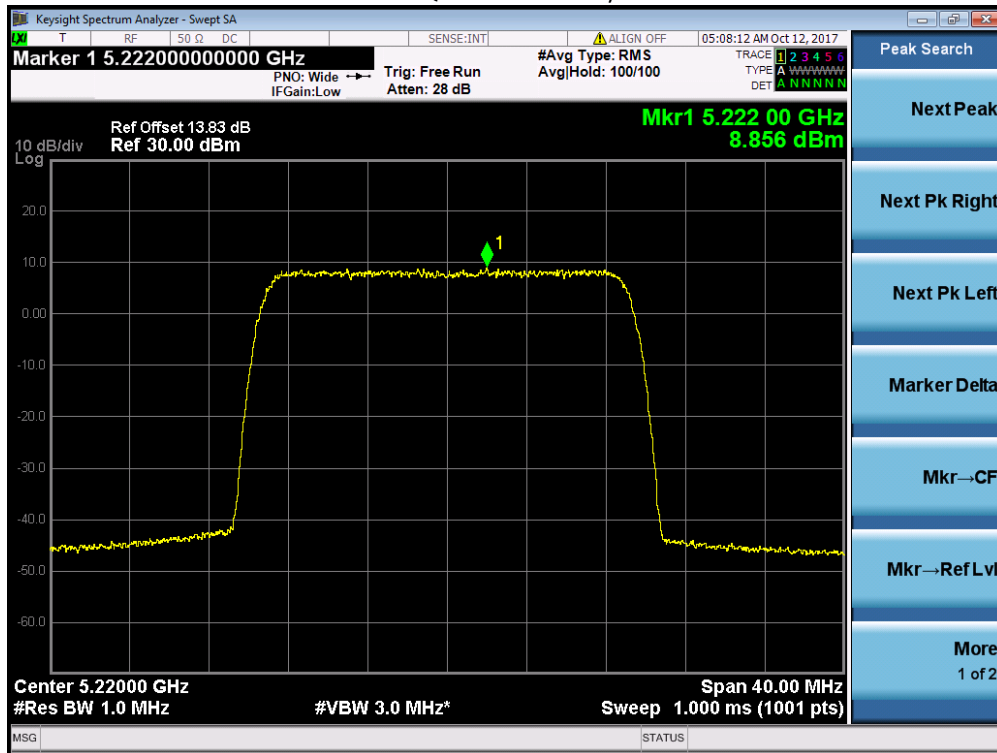

Channel Position M - 64QAM - Antenna B/ Bandwidth 20.0 MHz

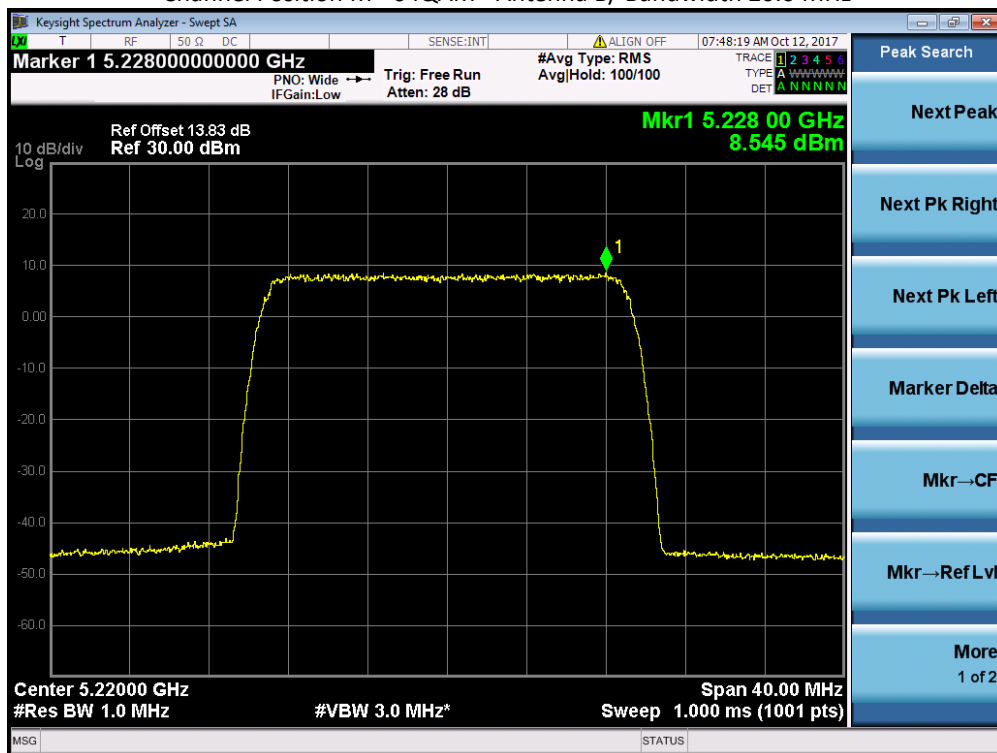

Channel Position T - 64QAM - Antenna A/ Bandwidth 20.0 MHz

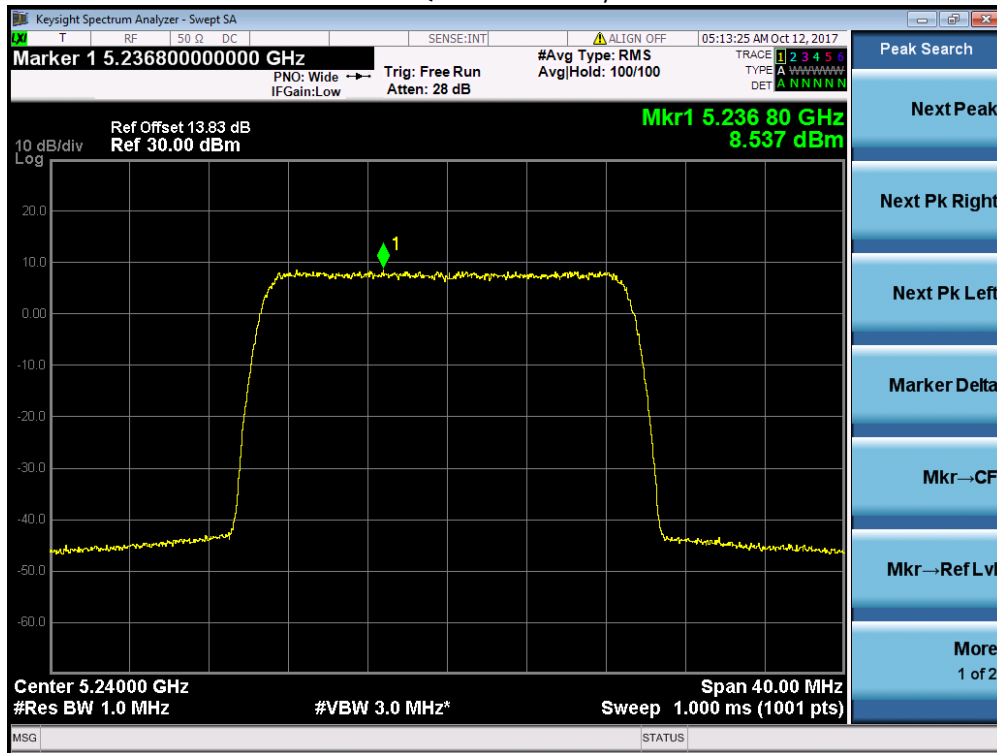

Channel Position T - 64QAM - Antenna B/ Bandwidth 20.0 MHz

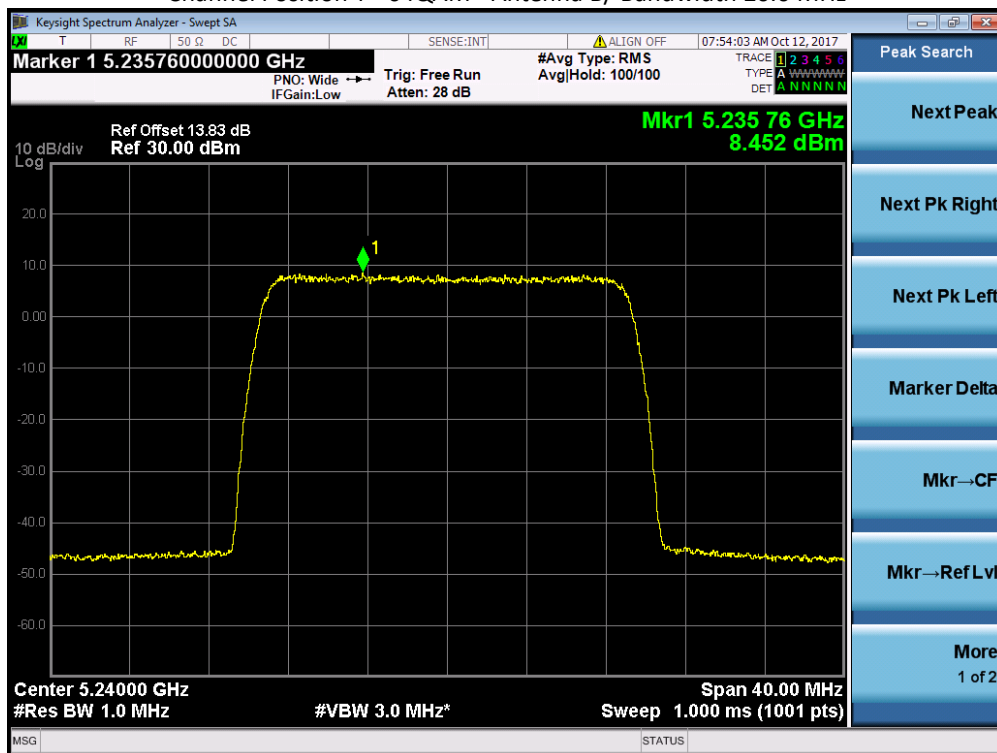

Channel Position B - 256QAM - Antenna A/ Bandwidth 20.0 MHz

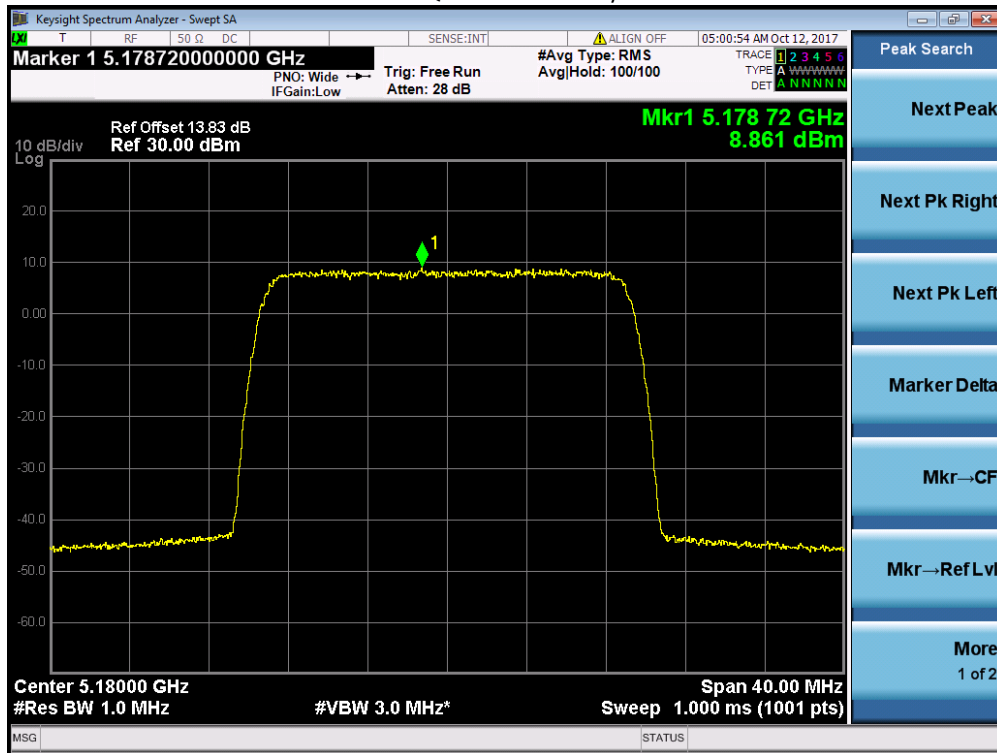

Channel Position B - 256QAM - Antenna B/ Bandwidth 20.0 MHz

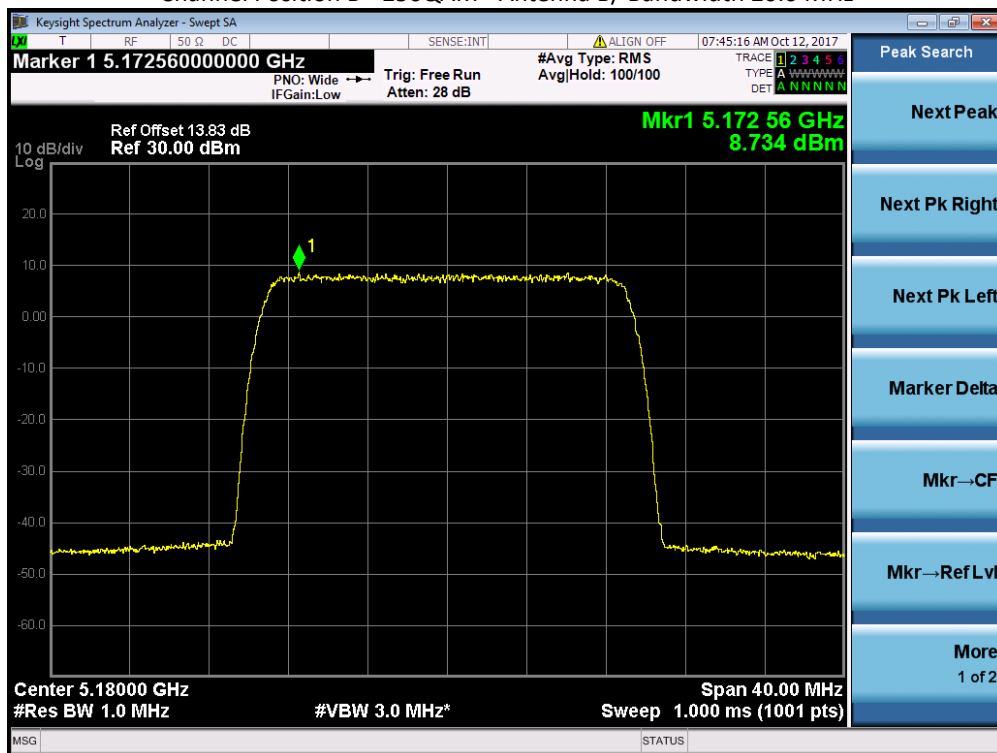

Channel Position M - 256QAM - Antenna A/ Bandwidth 20.0 MHz

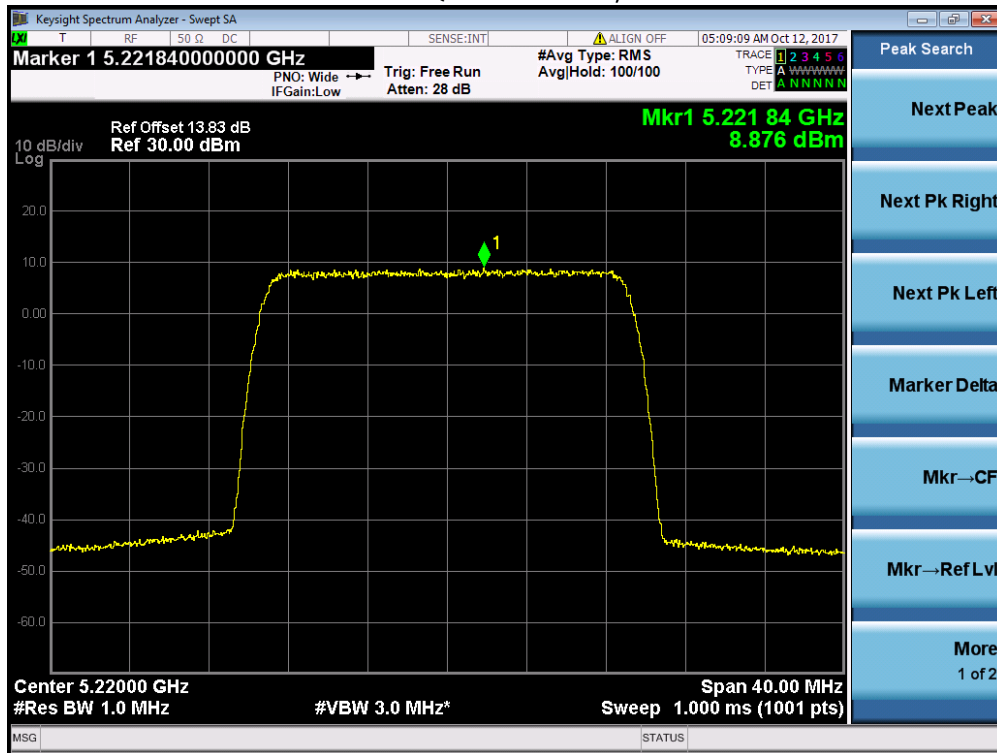

Channel Position M - 256QAM - Antenna B/ Bandwidth 20.0 MHz

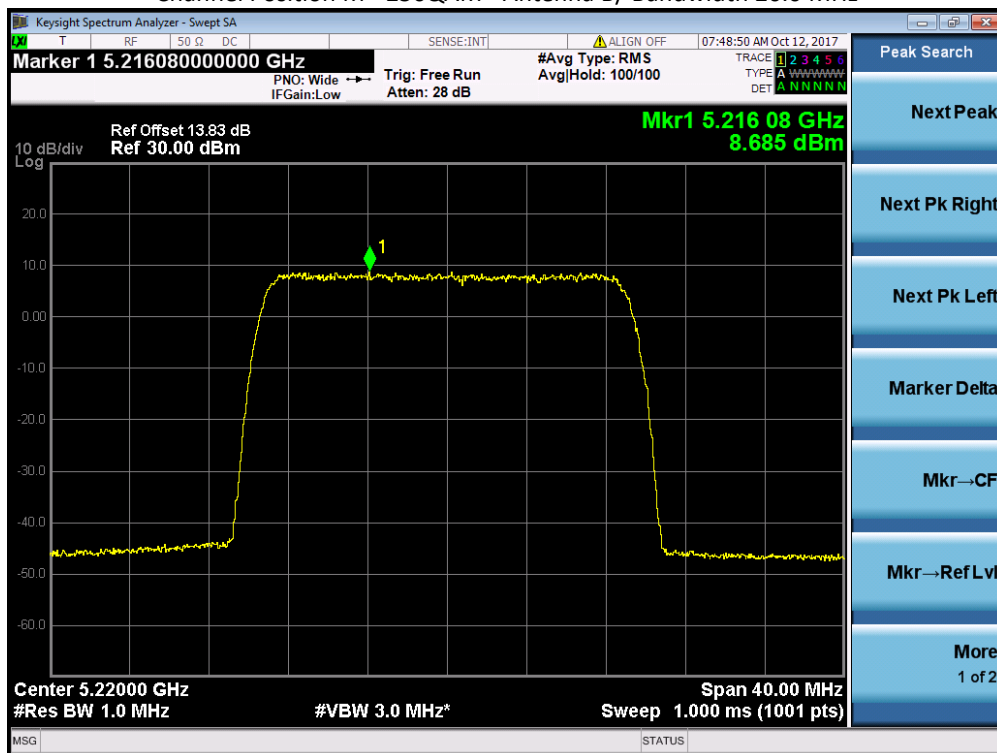

Channel Position T - 256QAM - Antenna A/ Bandwidth 20.0 MHz

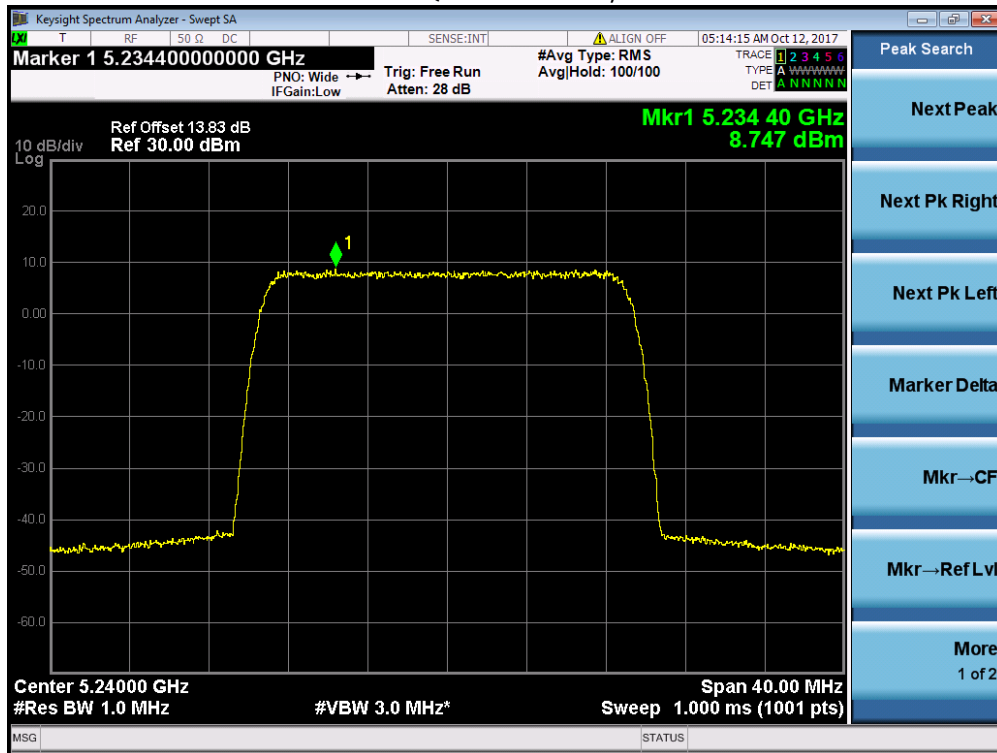

Channel Position T - 256QAM - Antenna B/ Bandwidth 20.0 MHz

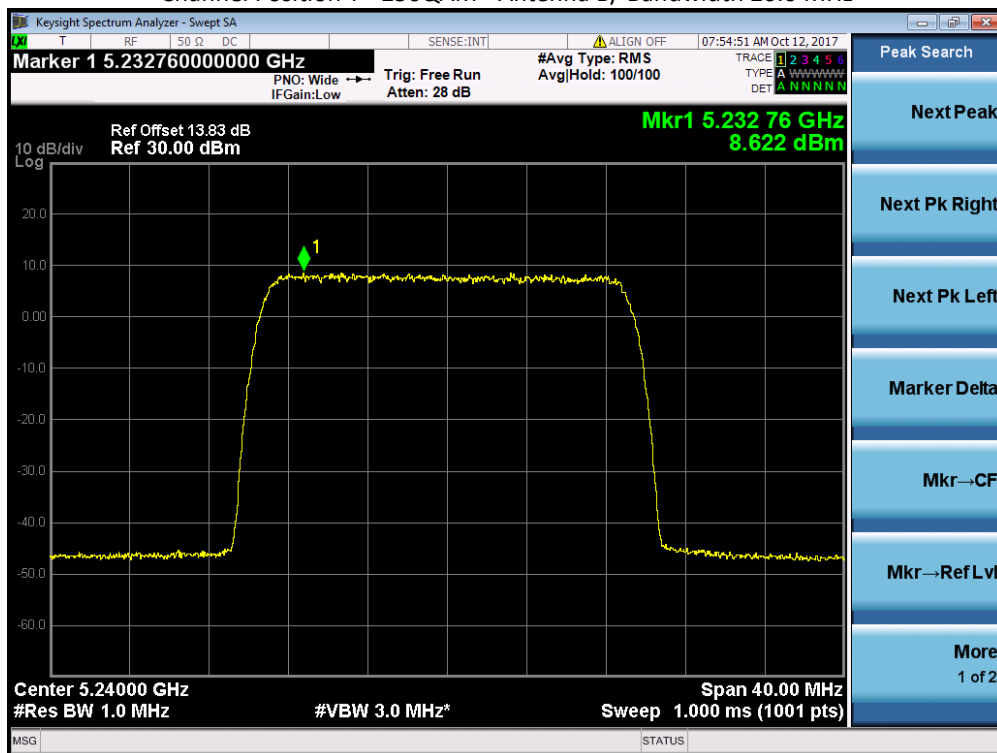

Configuration A2

L-MIMO-SC

Maximum Output Power 20.5dBm per port:

Antenna	Modulation / Carrier bandwidth (MHz)	Power Spectrum Density (dBm)		
		Channel Position B 5745MHz	Channel Position M 5785MHz	Channel Position T 5825MHz
A	QPSK / 20.0 MHz	6.971	7.130	7.114
B		6.842	6.465	6.618
Total		9.917	9.821	9.883

Antenna	Modulation / Carrier bandwidth (MHz)	Power Spectrum Density (dBm)		
		Channel Position B 5745MHz	Channel Position M 5785MHz	Channel Position T 5825MHz
A	16QAM / 20.0 MHz	7.464	7.635	7.603
B		7.034	6.654	7.770
Total		10.265	10.182	10.698

Antenna	Modulation / Carrier bandwidth (MHz)	Power Spectrum Density (dBm)		
		Channel Position B 5745MHz	Channel Position M 5785MHz	Channel Position T 5825MHz
A	64QAM / 20.0 MHz	6.510	6.974	6.924
B		6.879	6.642	6.514
Total		9.709	9.821	9.734

Antenna	Modulation / Carrier bandwidth (MHz)	Power Spectrum Density (dBm)		
		Channel Position B 5745MHz	Channel Position M 5785MHz	Channel Position T 5825MHz
A	256QAM / 20.0 MHz	6.792	6.946	7.073
B		6.598	6.581	6.670
Total		9.706	9.778	9.886

Channel Position B - QPSK - Antenna A/ Bandwidth 20.0 MHz

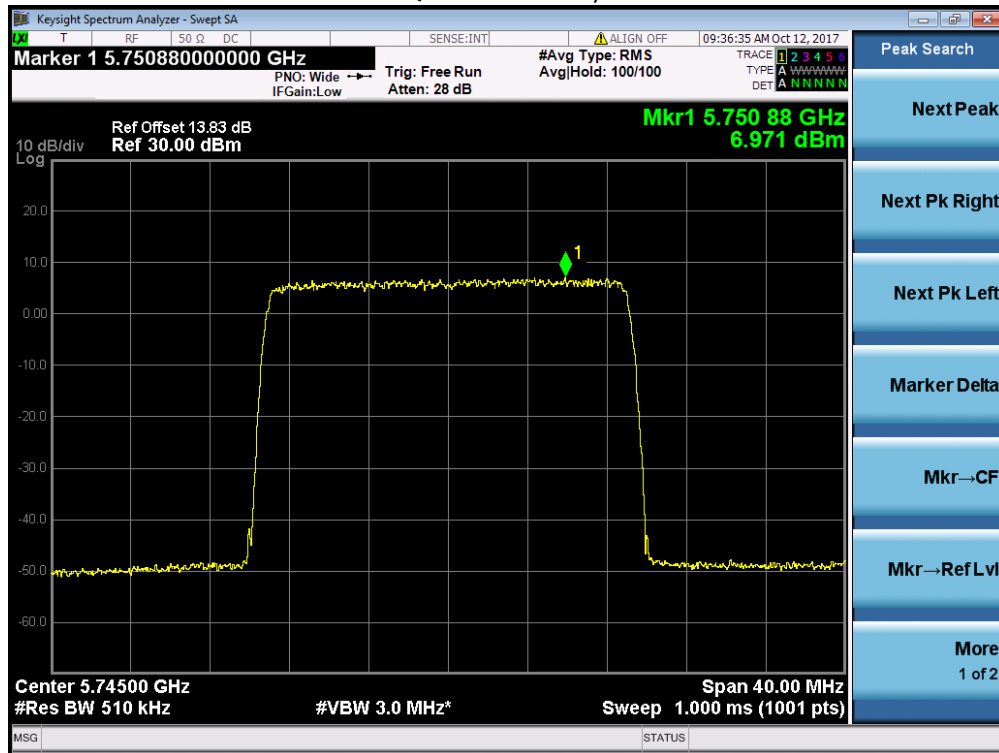

Channel Position B - QPSK - Antenna B/ Bandwidth 20.0 MHz

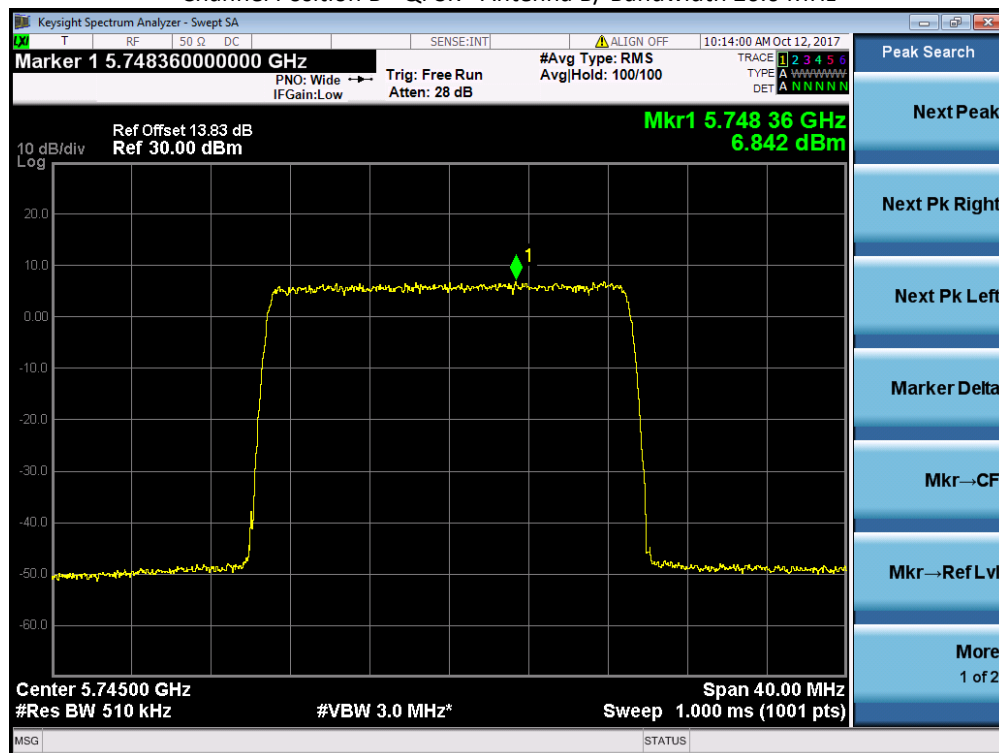

Channel Position M – QPSK - Antenna A/ Bandwidth 20.0 MHz

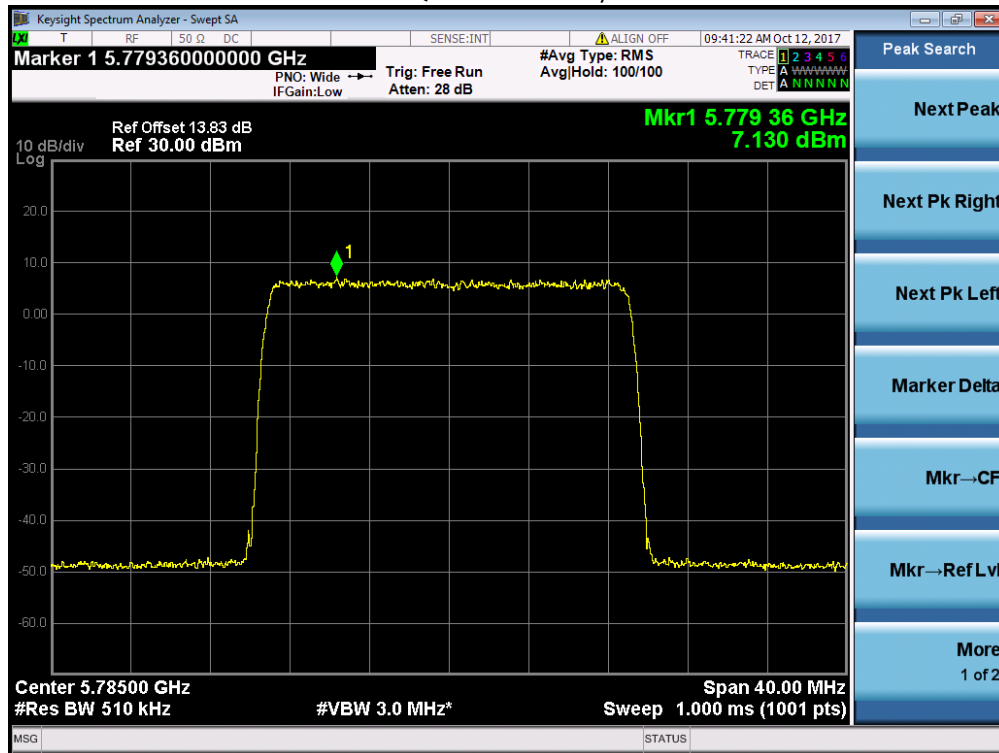

Channel Position M - QPSK - Antenna B/ Bandwidth 20.0 MHz

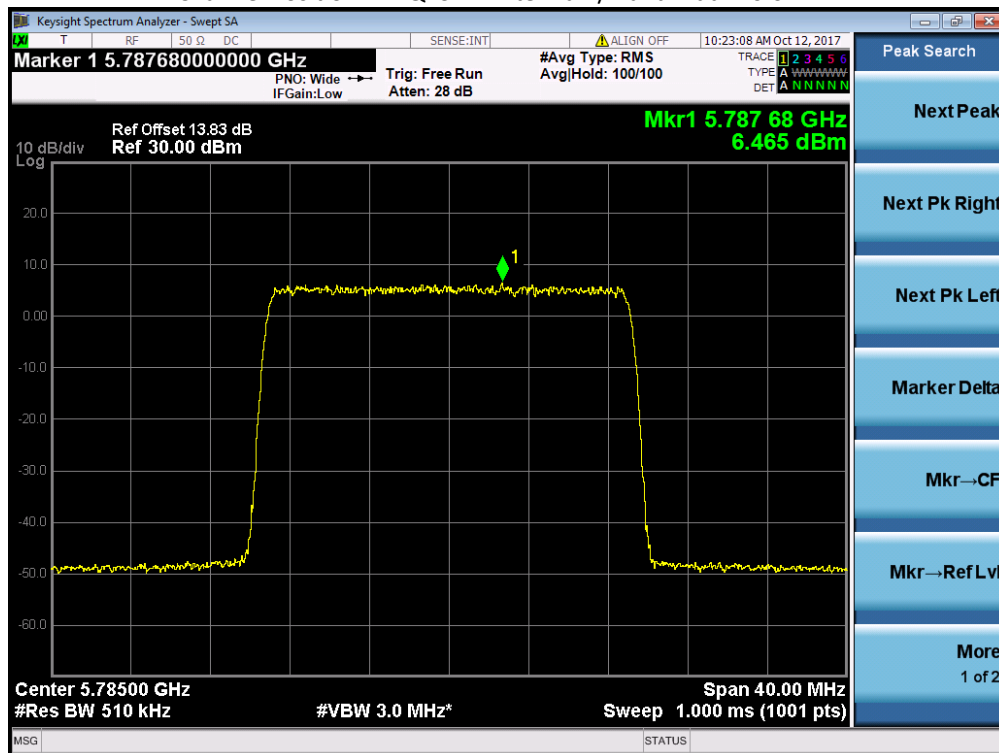

Channel Position T - QPSK - Antenna A/ Bandwidth 20.0 MHz

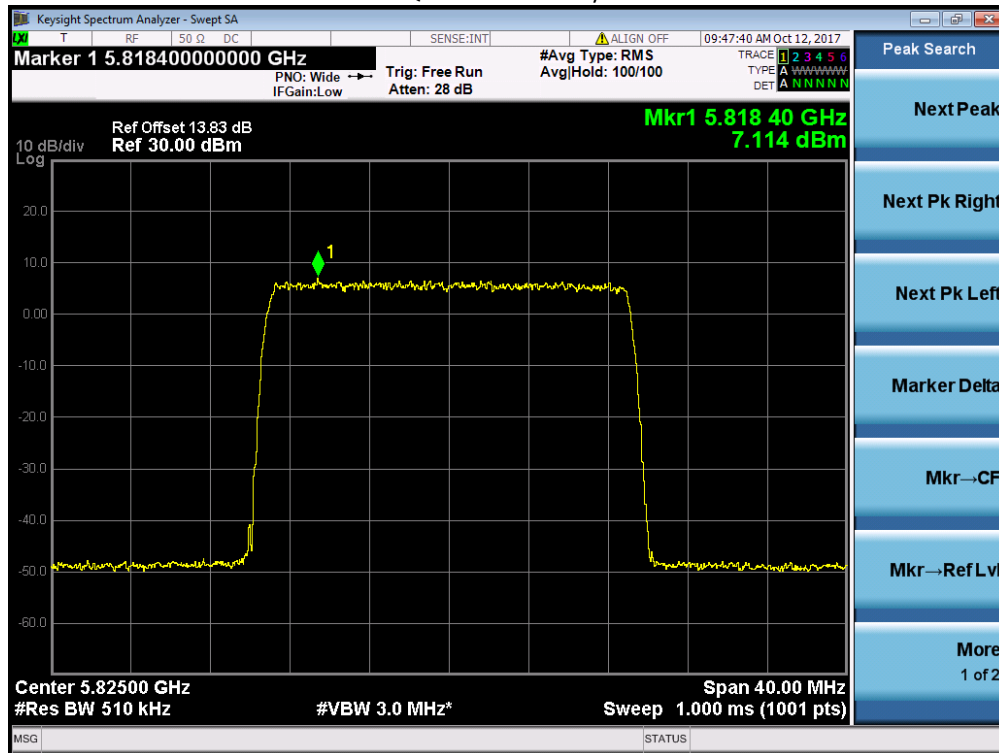

Channel Position T - QPSK - Antenna B/ Bandwidth 20.0 MHz

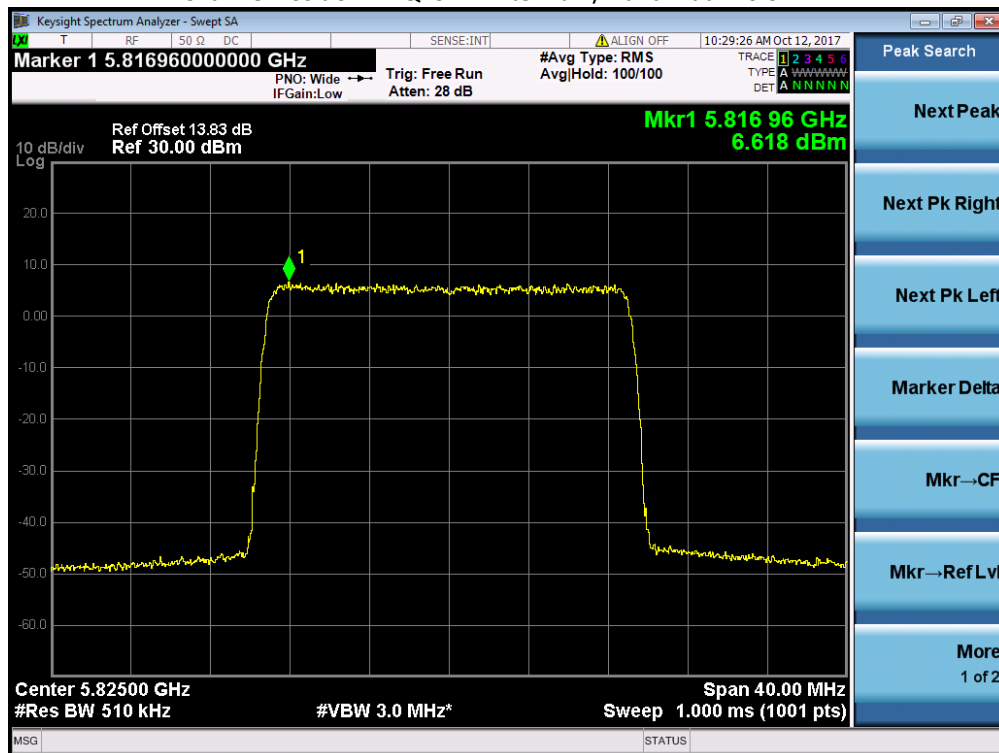

Channel Position B - 16QAM - Antenna A/ Bandwidth 20.0 MHz

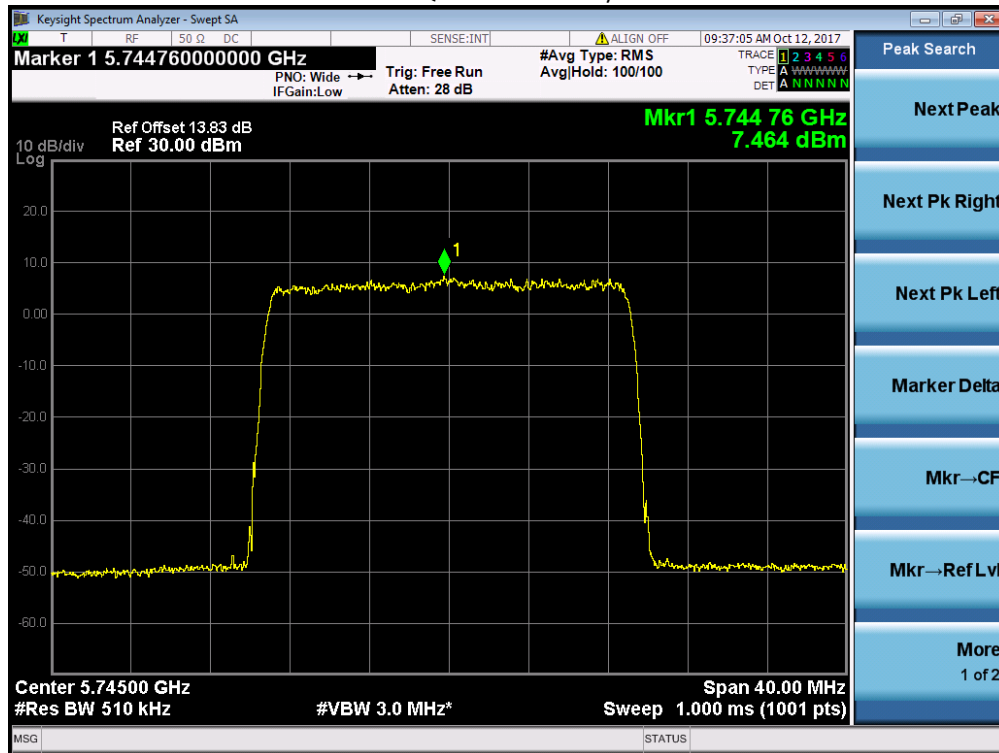

Channel Position B - 16QAM - Antenna B/ Bandwidth 20.0 MHz

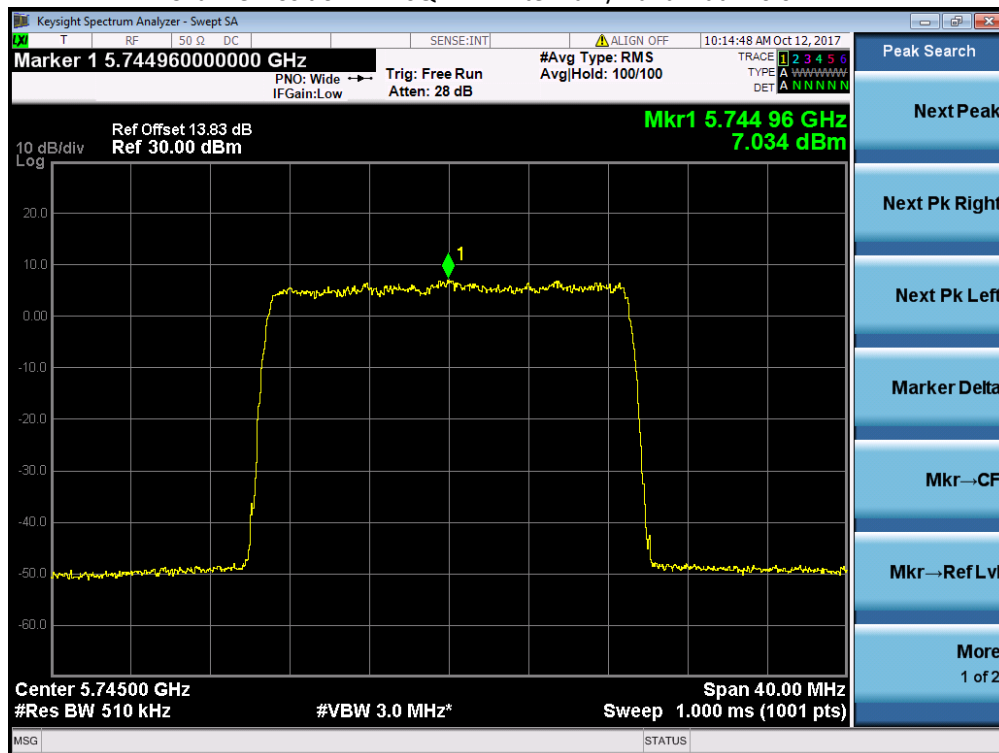

Channel Position M - 16QAM - Antenna A/ Bandwidth 20.0 MHz

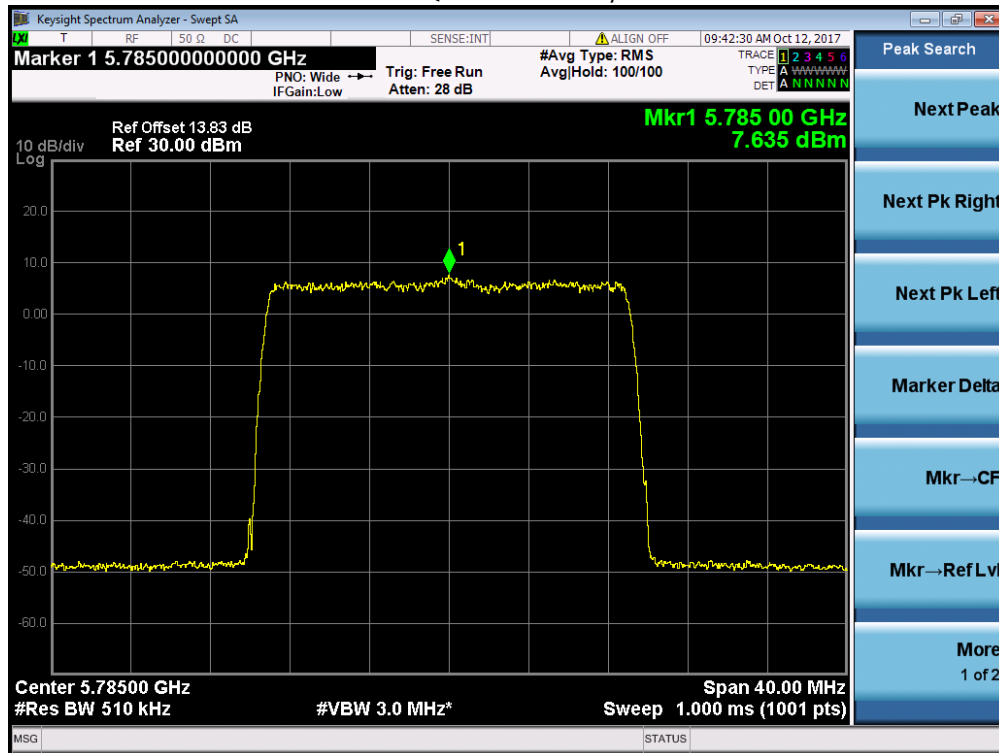

Channel Position M - 16QAM - Antenna B/ Bandwidth 20.0 MHz

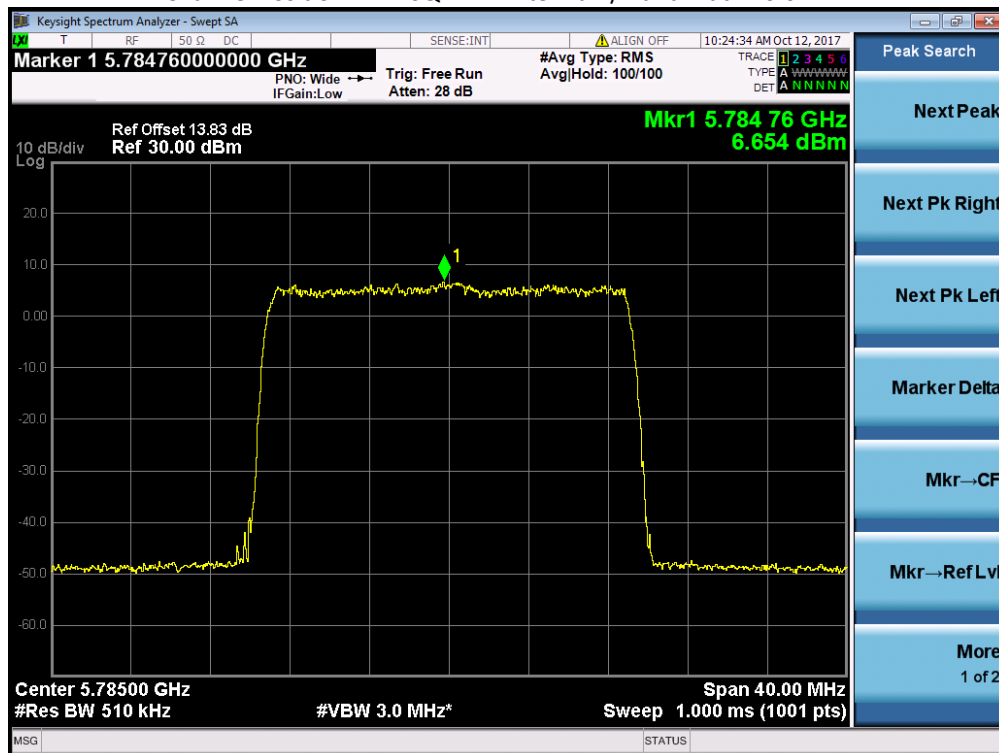

Channel Position T - 16QAM - Antenna A/ Bandwidth 20.0 MHz

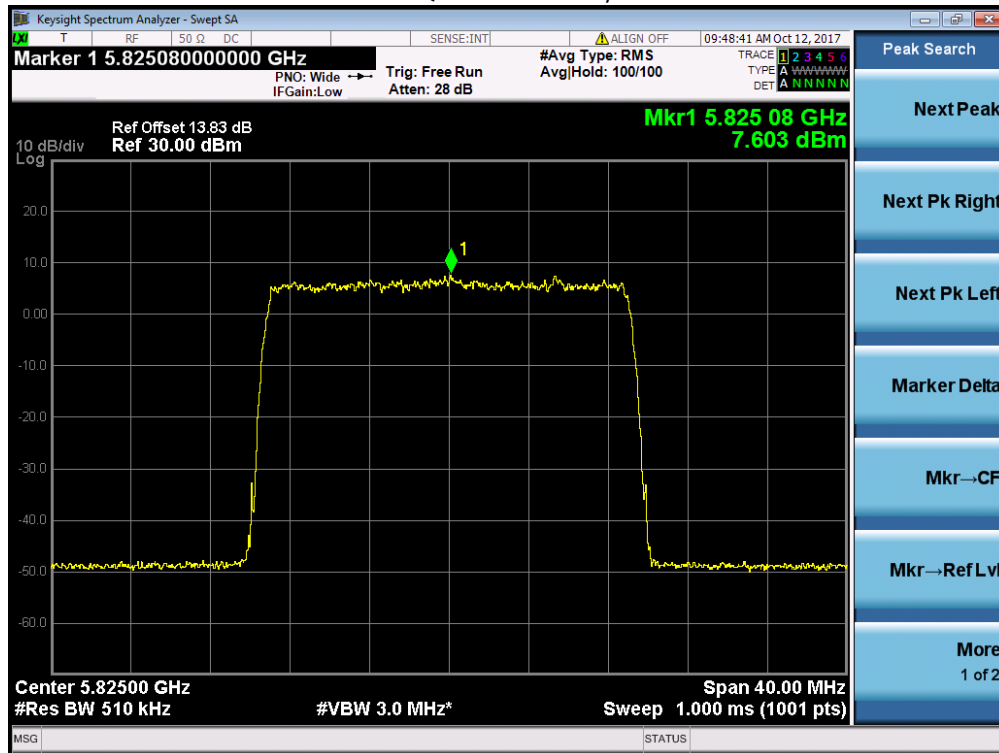

Channel Position T - 16QAM - Antenna B/ Bandwidth 20.0 MHz

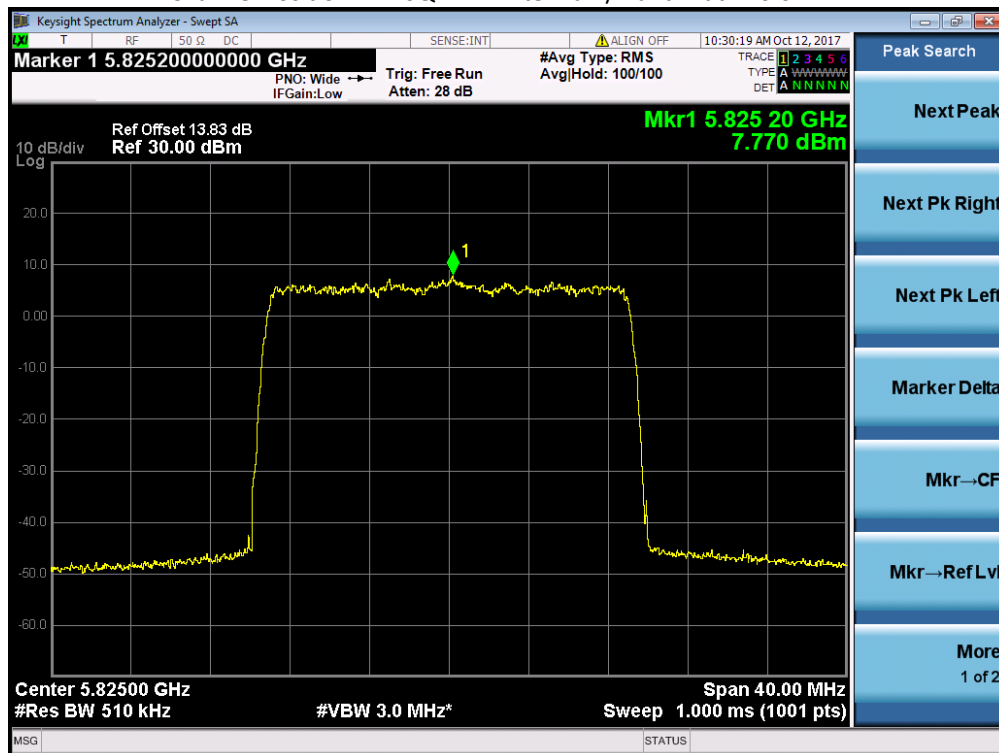

Channel Position B - 64QAM - Antenna A/ Bandwidth 20.0 MHz

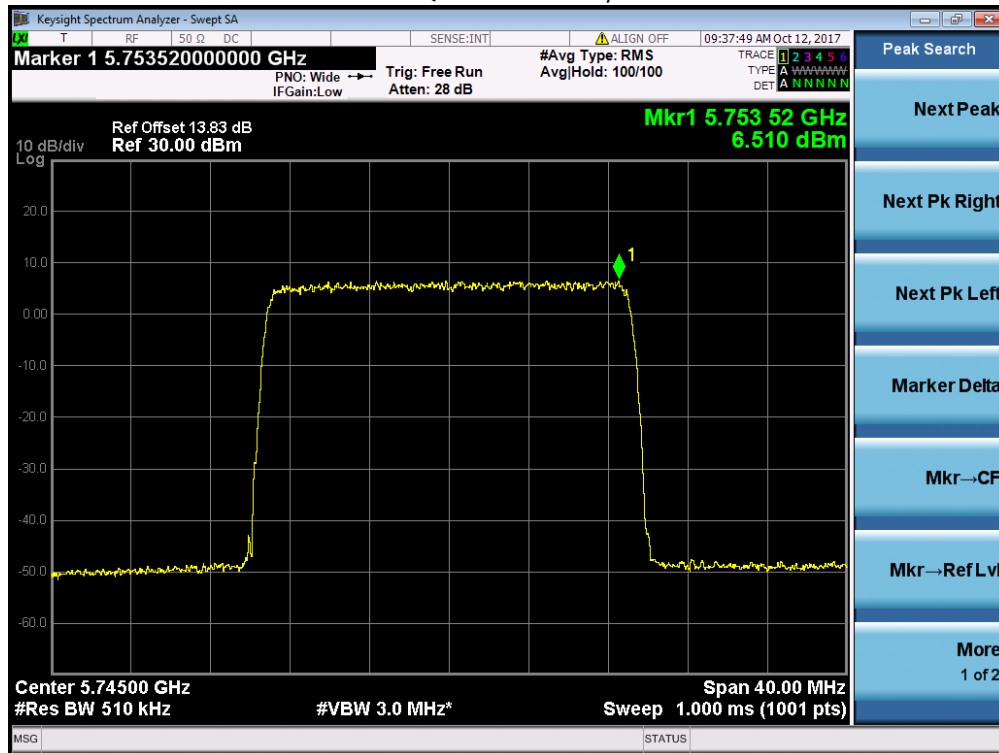

Channel Position B - 64QAM - Antenna B/ Bandwidth 20.0 MHz

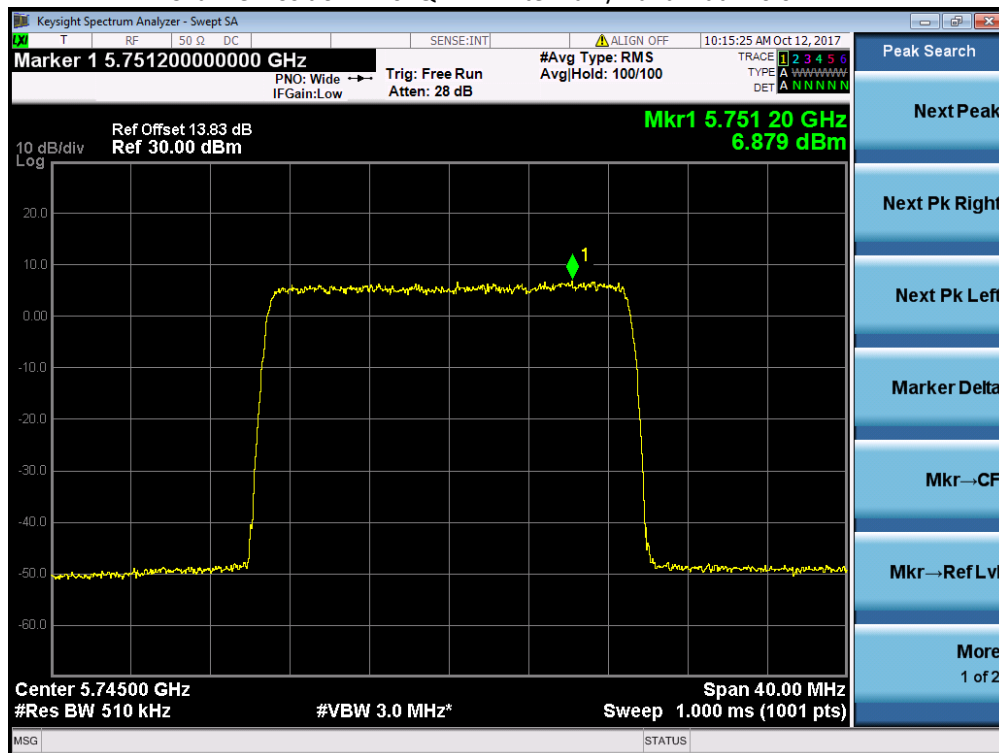

Channel Position M - 64QAM - Antenna A/ Bandwidth 20.0 MHz

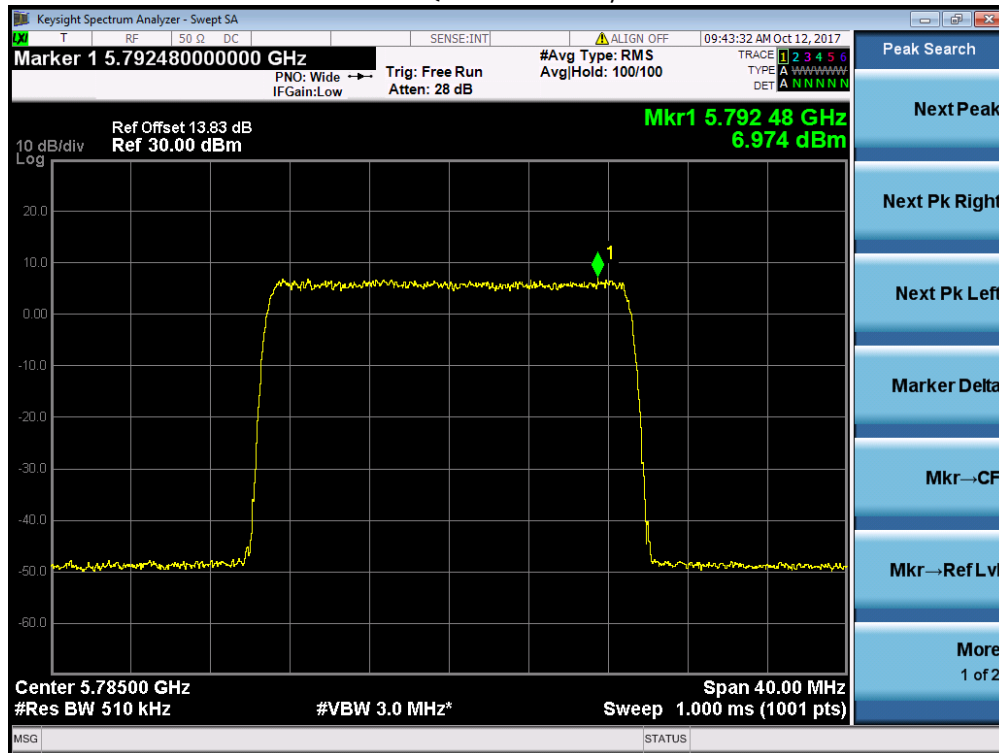

Channel Position M - 64QAM - Antenna B/ Bandwidth 20.0 MHz

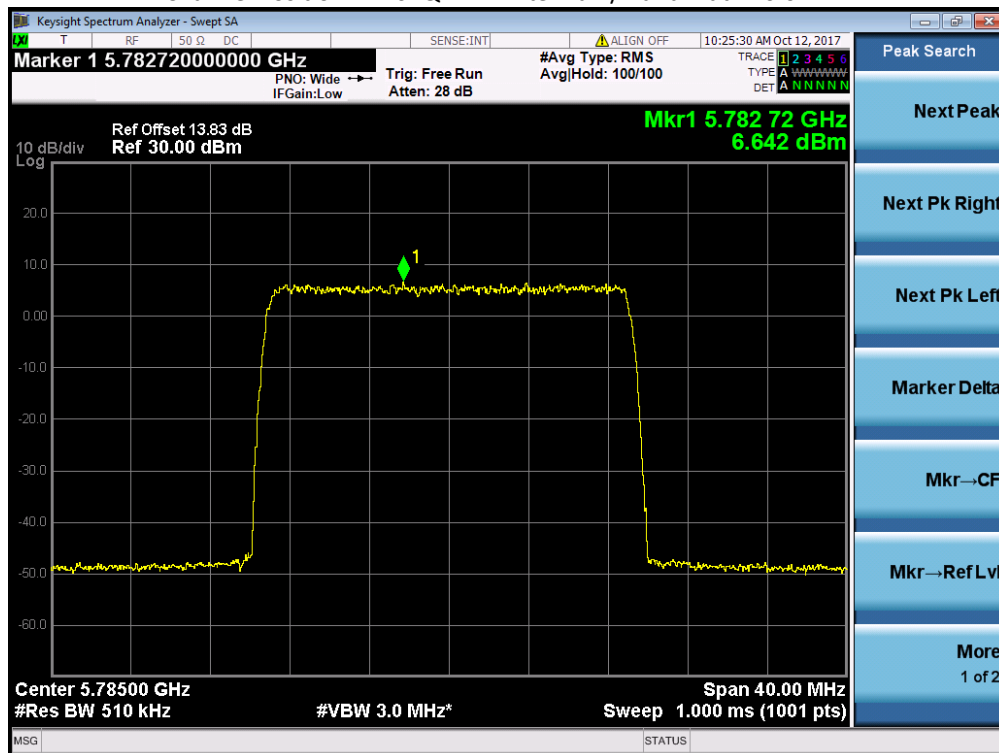

Channel Position T - 64QAM - Antenna A/ Bandwidth 20.0 MHz

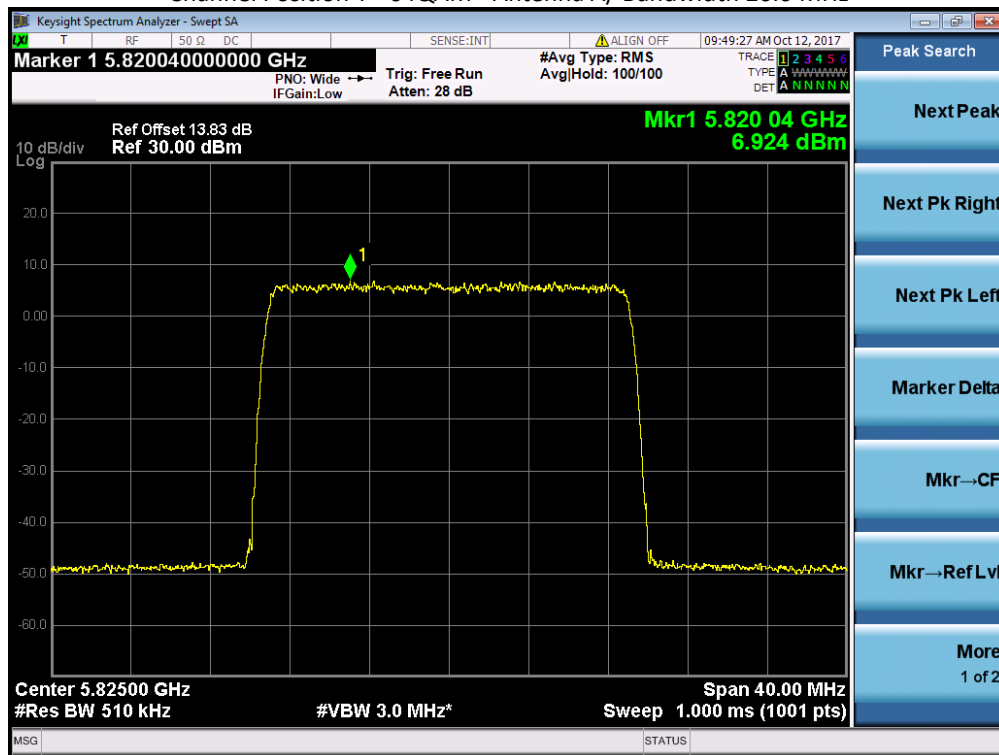

Channel Position T - 64QAM - Antenna B/ Bandwidth 20.0 MHz

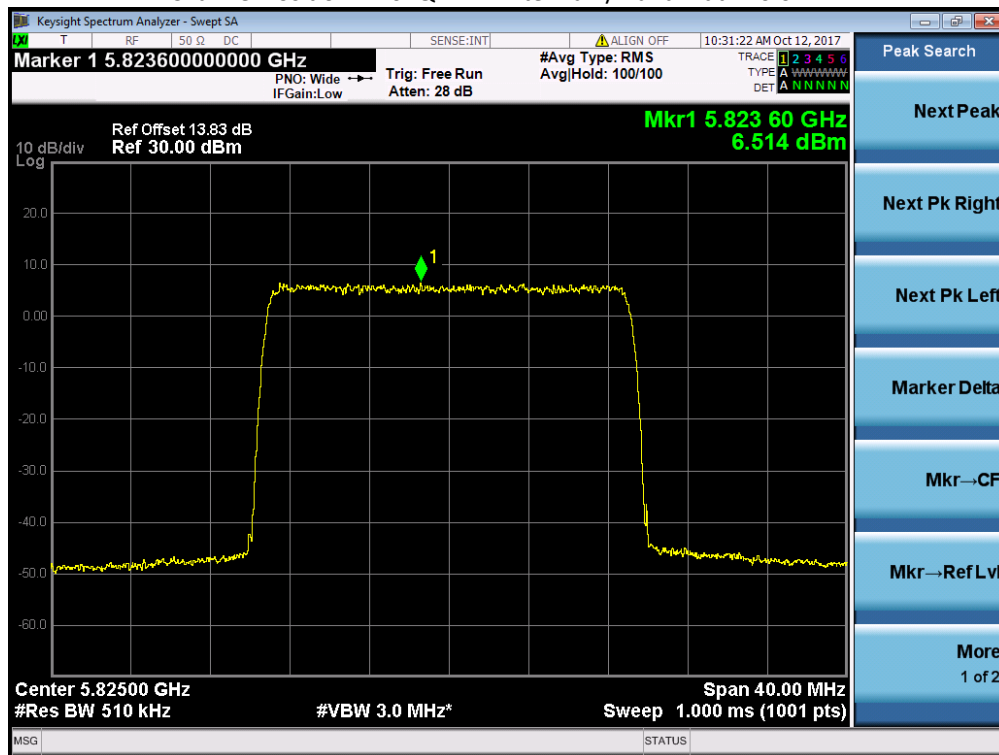

Channel Position B - 256QAM - Antenna A/ Bandwidth 20.0 MHz

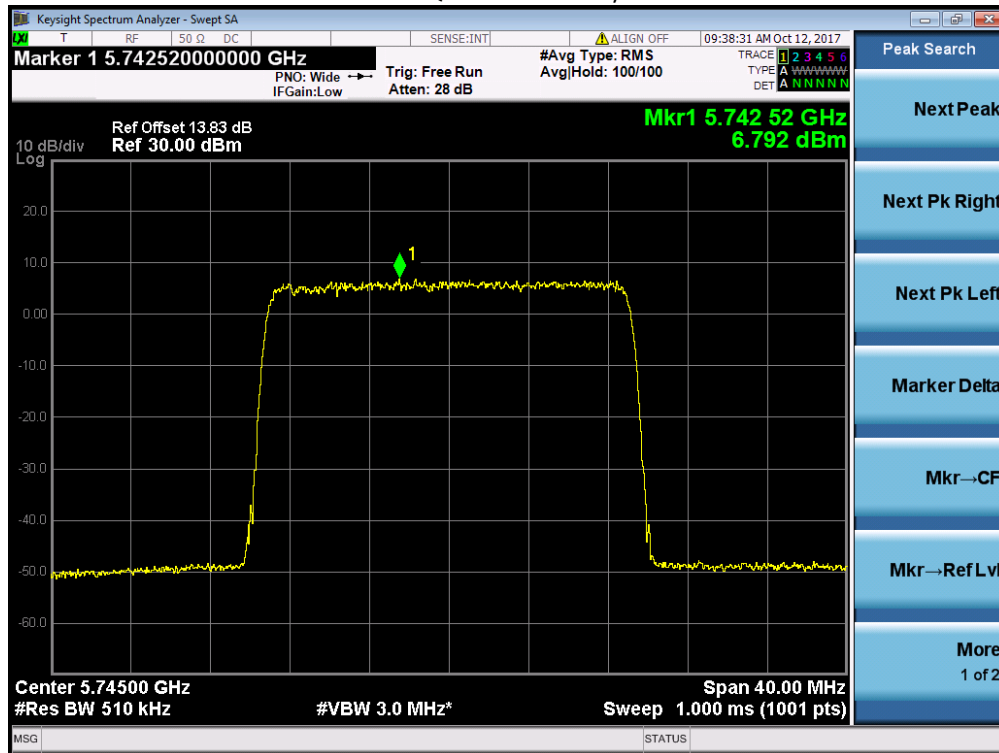

Channel Position B - 256QAM - Antenna B/ Bandwidth 20.0 MHz

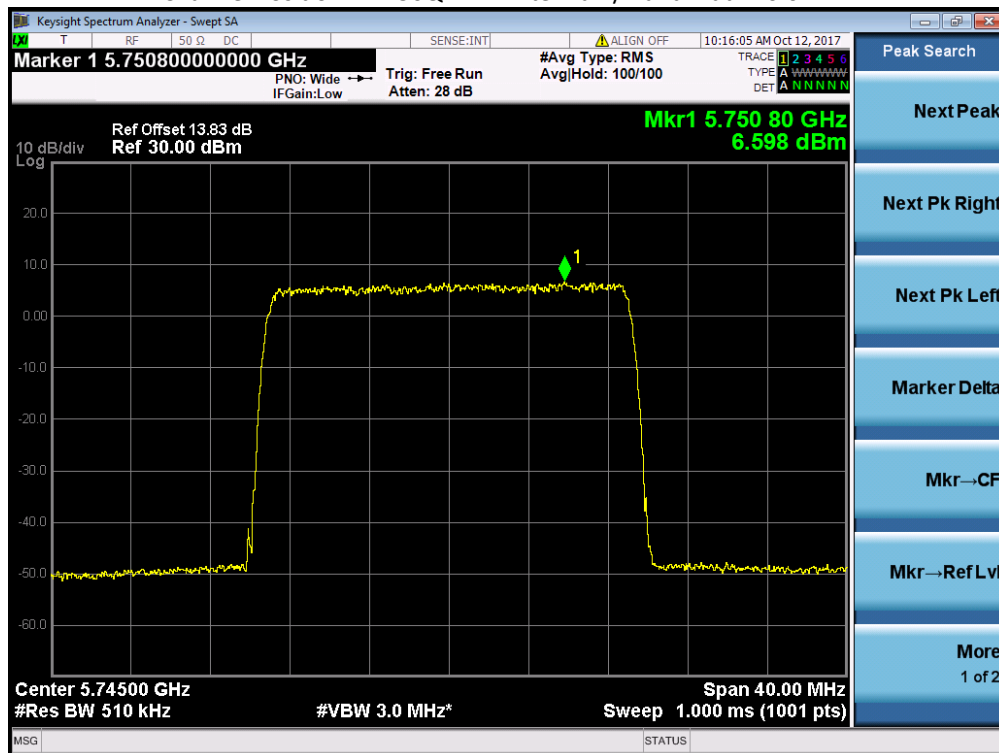

Channel Position M - 256QAM - Antenna A/ Bandwidth 20.0 MHz

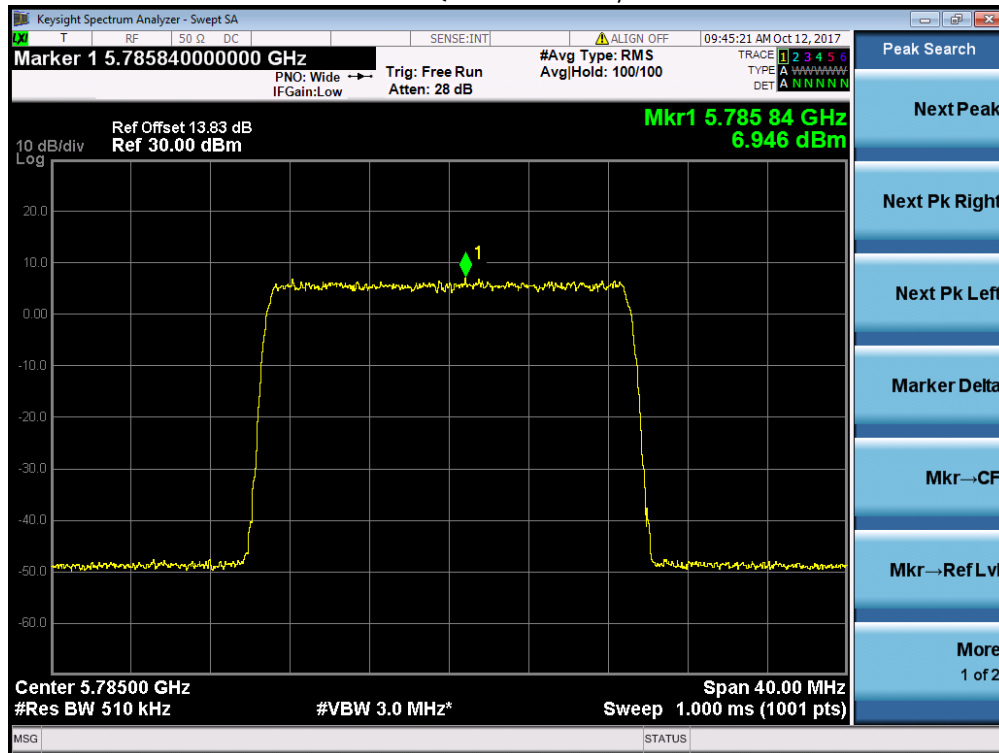

Channel Position M - 256QAM - Antenna B/ Bandwidth 20.0 MHz

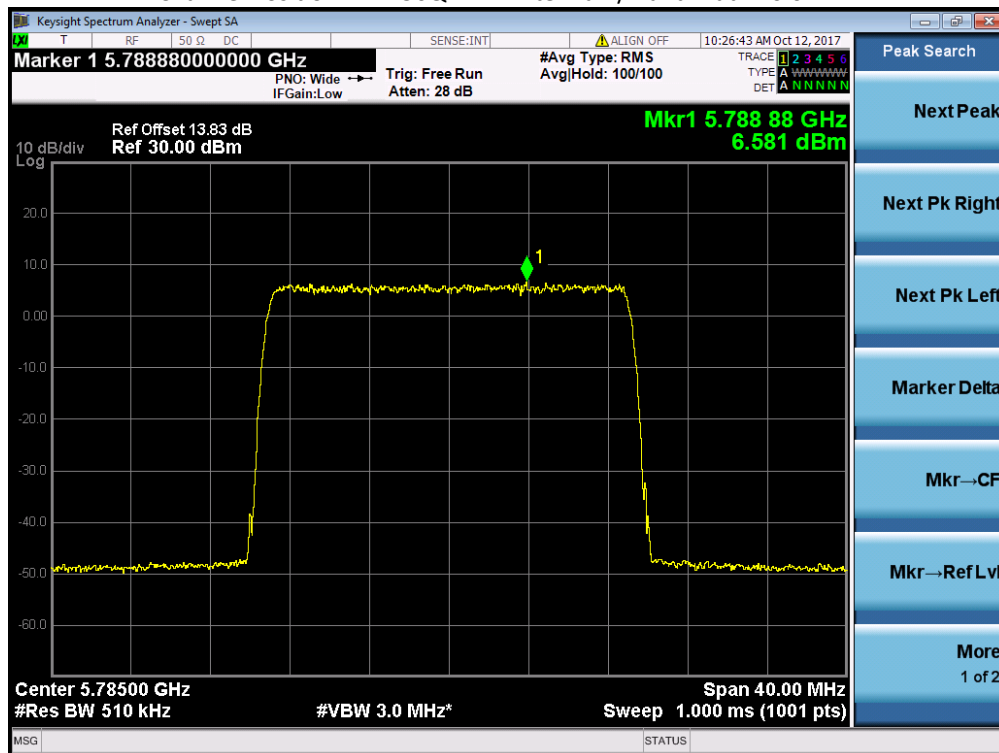

Channel Position T - 256QAM - Antenna A/ Bandwidth 20.0 MHz

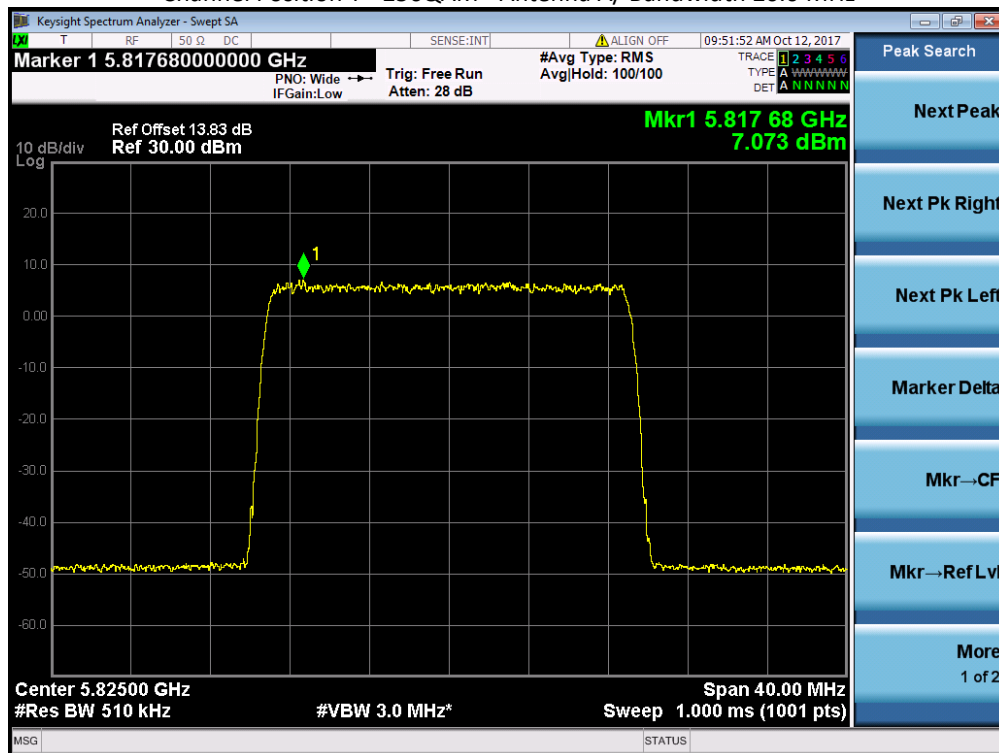

Channel Position T - 256QAM - Antenna B/ Bandwidth 20.0 MHz

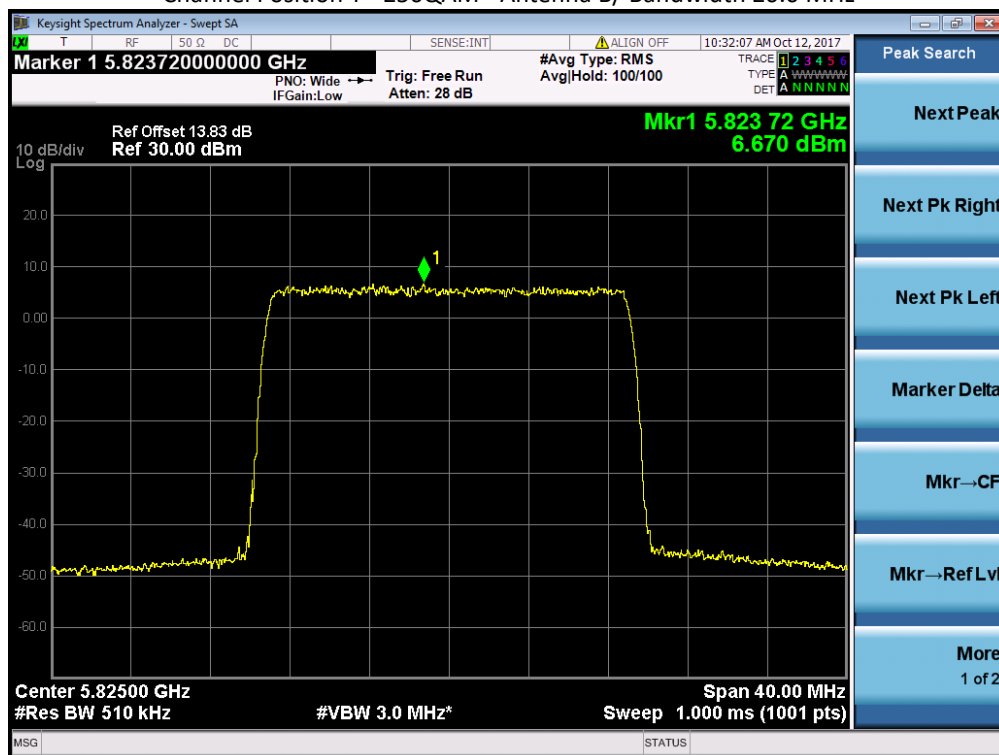

Configuration A3

L-MIMO-SC

Maximum Output Power 8.5dBm per port:

Antenna	Modulation / Carrier bandwidth (MHz)	Power Spectrum Density (dBm)		
		Channel Position B 5180MHz	Channel Position M 5220MHz	Channel Position T 5240MHz
A	QPSK / 20.0 MHz	-3.971	-4.060	-4.258
B		-3.900	-4.220	-4.396
Total		-0.925	-1.129	-1.316

Antenna	Modulation / Carrier bandwidth (MHz)	Power Spectrum Density (dBm)		
		Channel Position B 5180MHz	Channel Position M 5220MHz	Channel Position T 5240MHz
A	16QAM / 20.0 MHz	-3.184	-3.415	-3.195
B		-3.362	-3.755	-3.181
Total		-0.262	-0.571	-0.178

Antenna	Modulation / Carrier bandwidth (MHz)	Power Spectrum Density (dBm)		
		Channel Position B 5180MHz	Channel Position M 5220MHz	Channel Position T 5240MHz
A	64QAM / 20.0 MHz	-3.836	-4.126	-4.025
B		-3.879	-4.337	-4.247
Total		-0.847	-1.220	-1.124

Antenna	Modulation / Carrier bandwidth (MHz)	Power Spectrum Density (dBm)		
		Channel Position B 5180MHz	Channel Position M 5220MHz	Channel Position T 5240MHz
A	256QAM / 20.0 MHz	-3.945	-4.237	-3.974
B		-4.170	-4.170	-4.403
Total		-1.046	-1.193	-1.173

Channel Position B - QPSK - Antenna A/ Bandwidth 20.0 MHz

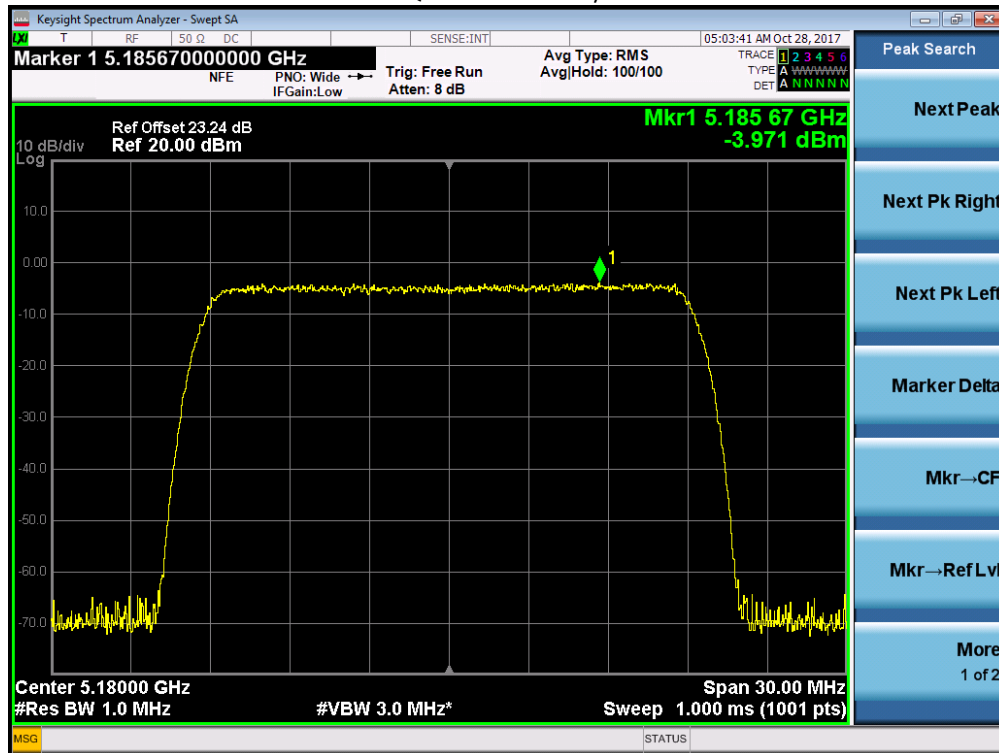

Channel Position B - QPSK - Antenna B/ Bandwidth 20.0 MHz

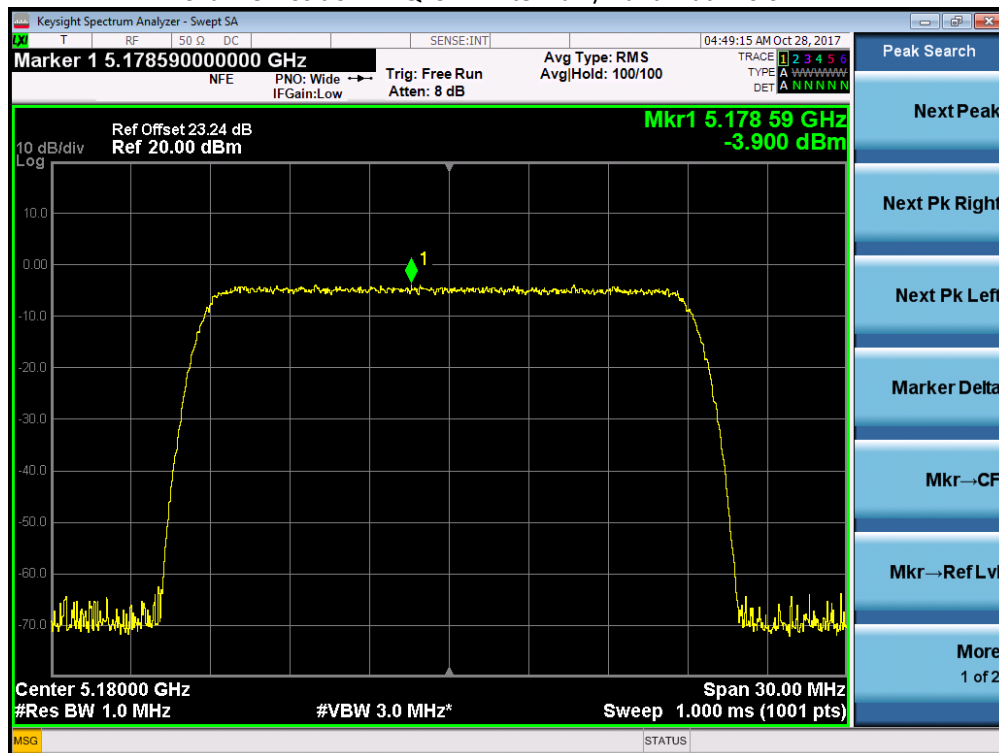

Channel Position M – QPSK - Antenna A/ Bandwidth 20.0 MHz

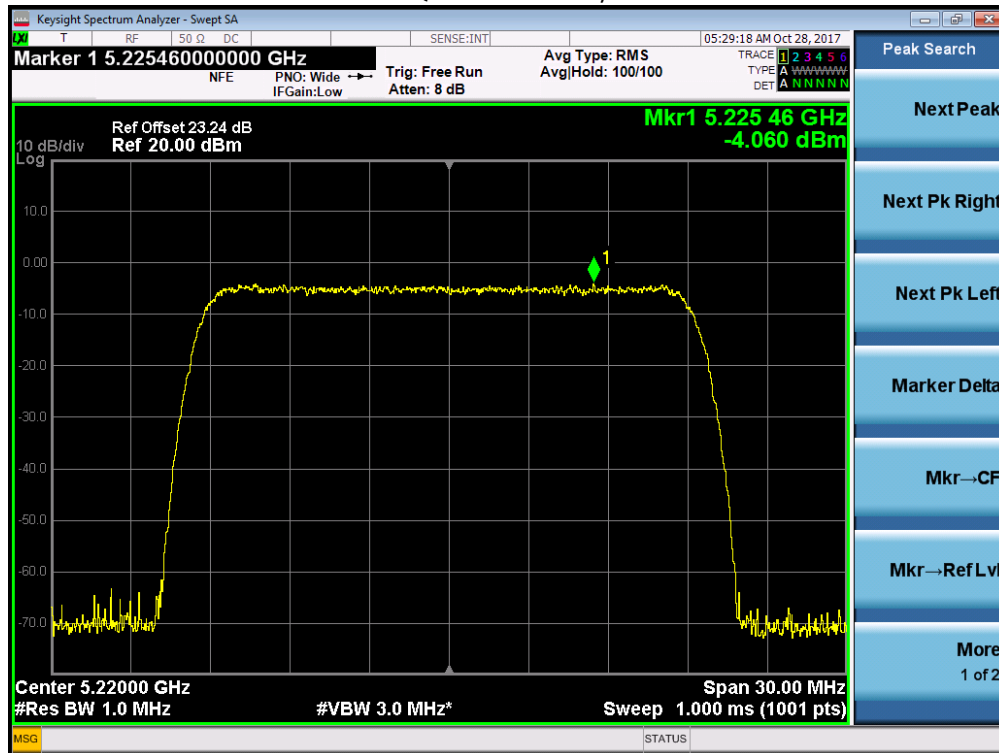

Channel Position M - QPSK - Antenna B/ Bandwidth 20.0 MHz

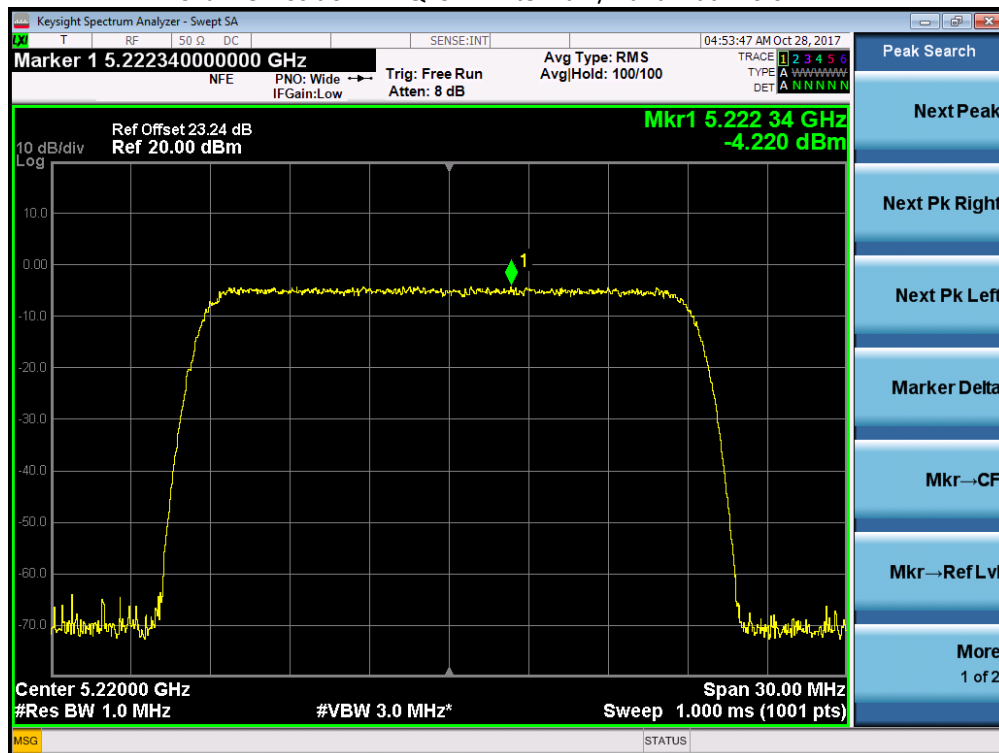

Channel Position T - QPSK - Antenna A/ Bandwidth 20.0 MHz

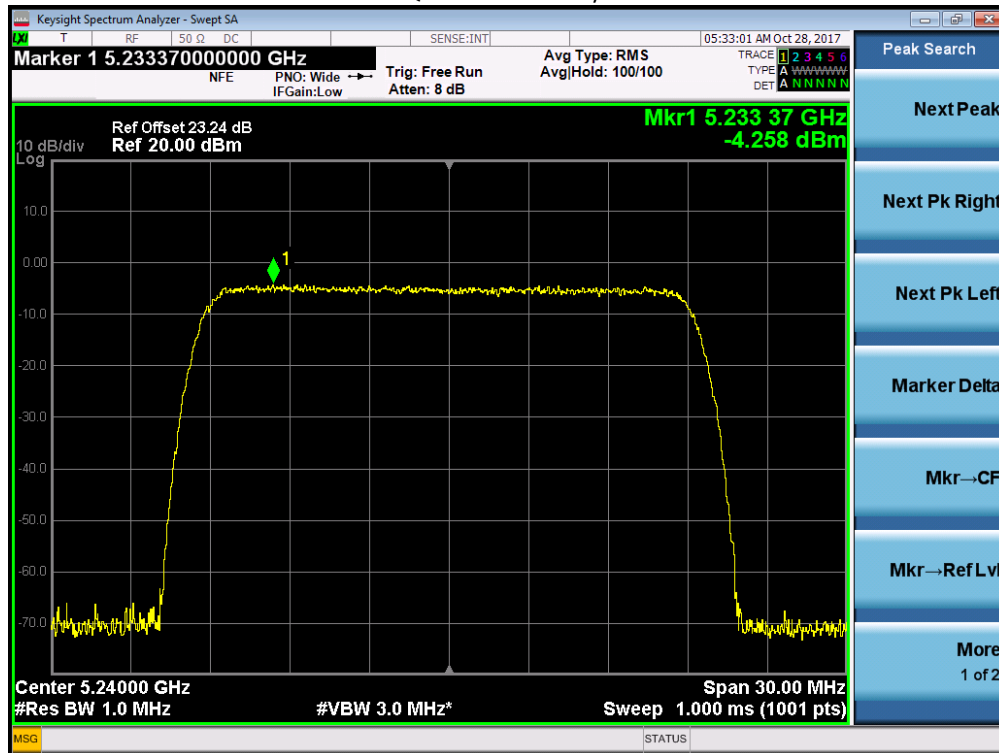

Channel Position T - QPSK - Antenna B/ Bandwidth 20.0 MHz

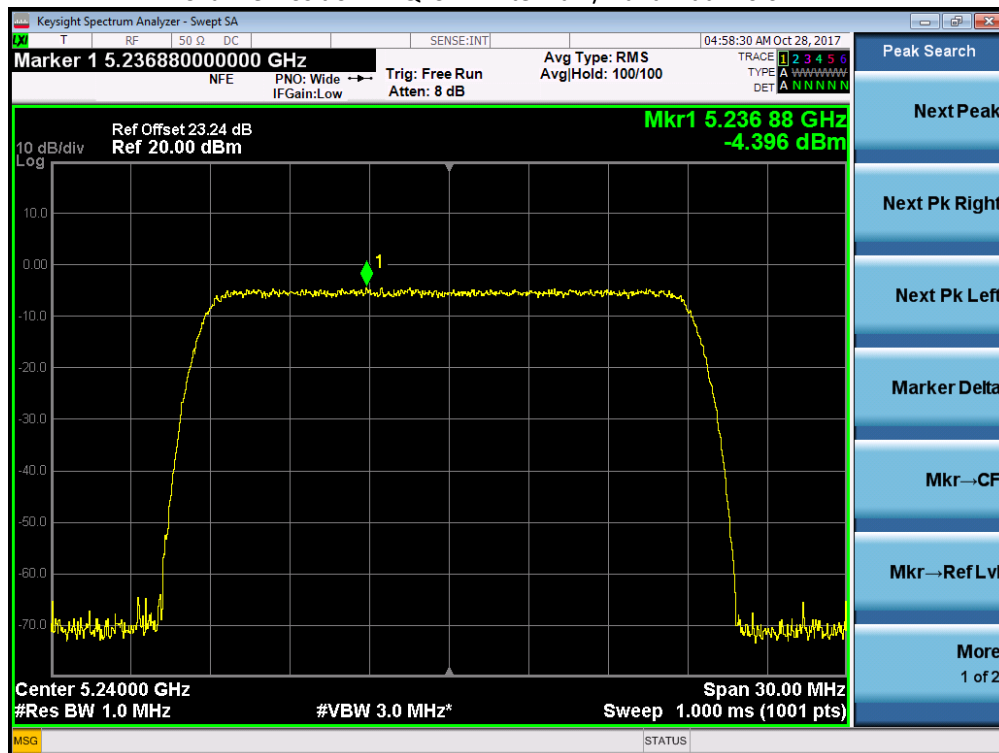

Channel Position B - 16QAM - Antenna A/ Bandwidth 20.0 MHz

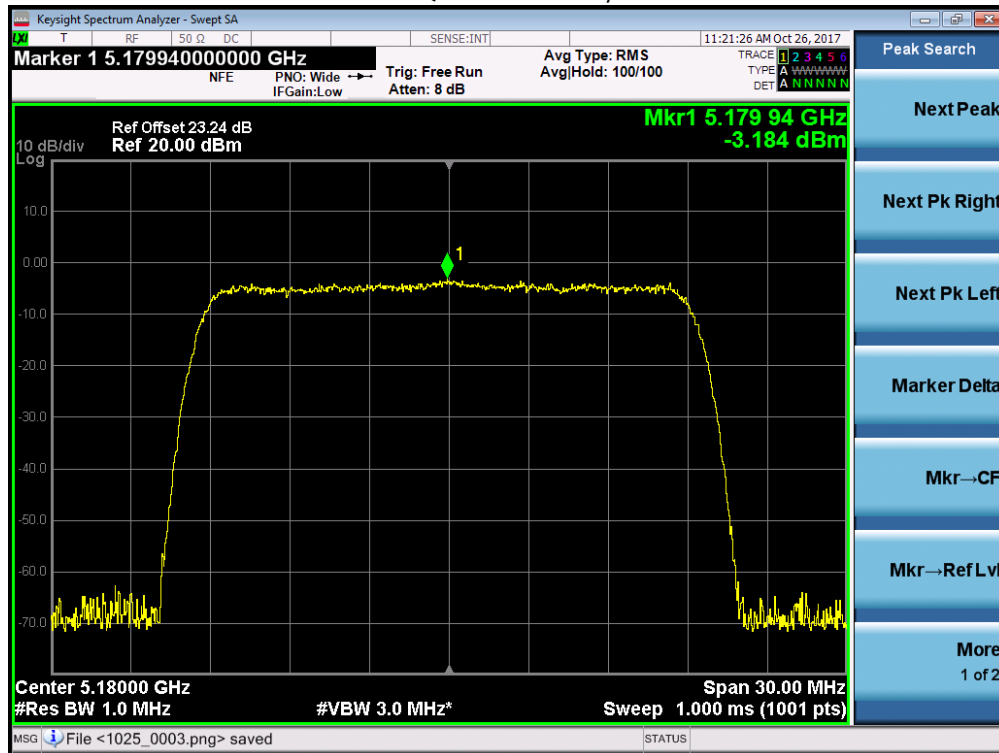

Channel Position B - 16QAM - Antenna B/ Bandwidth 20.0 MHz

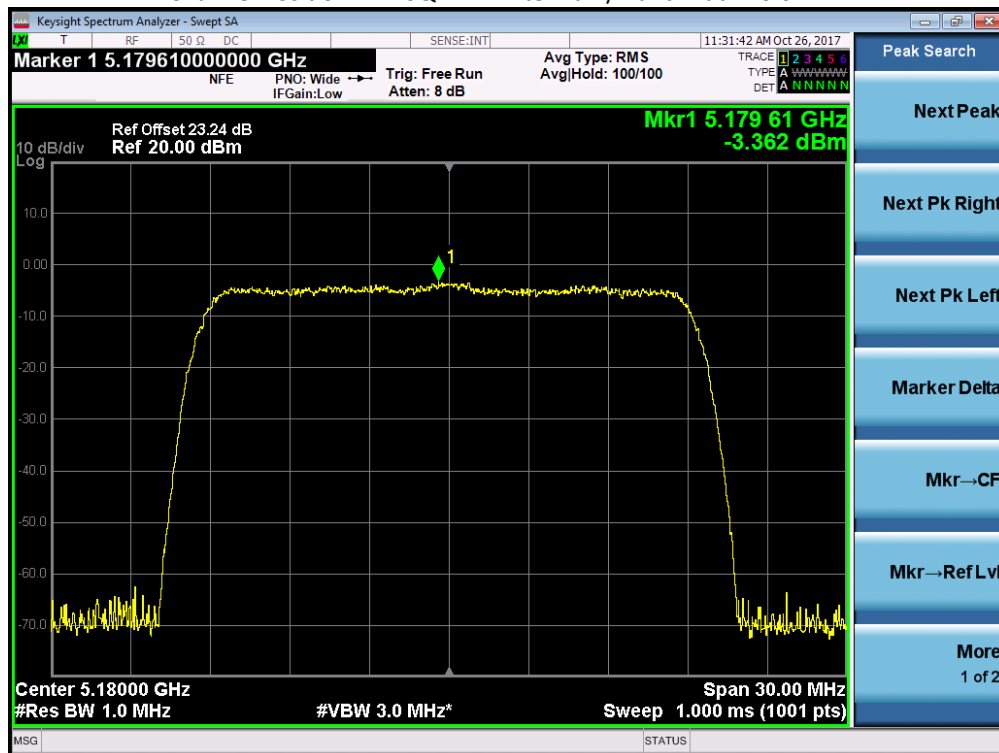

Channel Position M - 16QAM - Antenna A/ Bandwidth 20.0 MHz

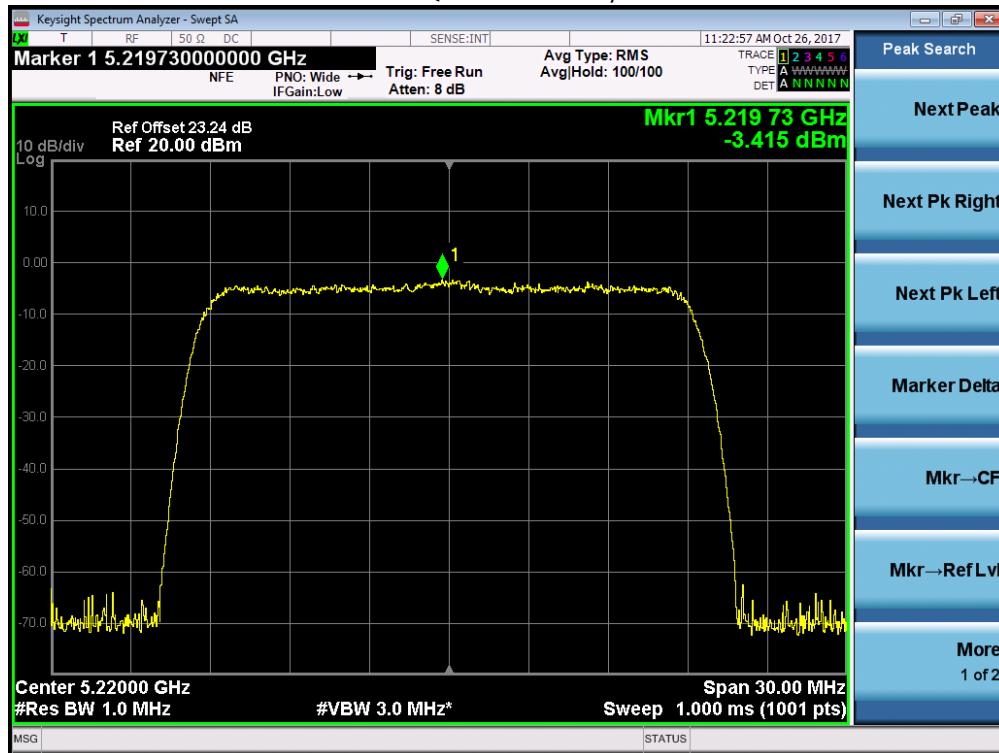

Channel Position M - 16QAM - Antenna B/ Bandwidth 20.0 MHz

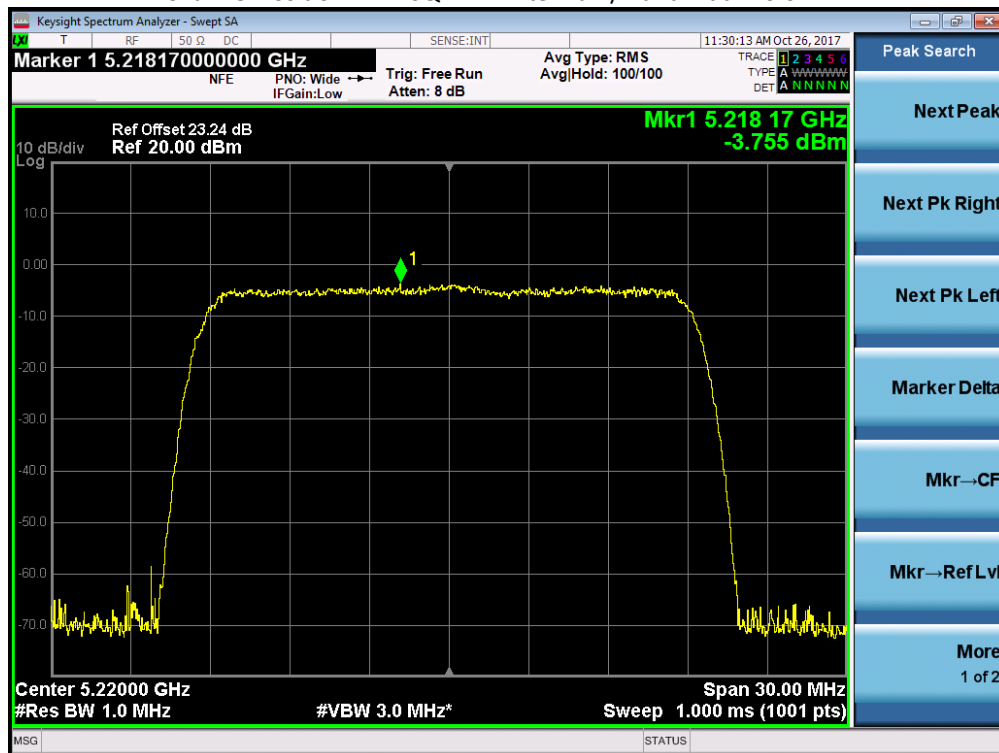

Channel Position T - 16QAM - Antenna A/ Bandwidth 20.0 MHz

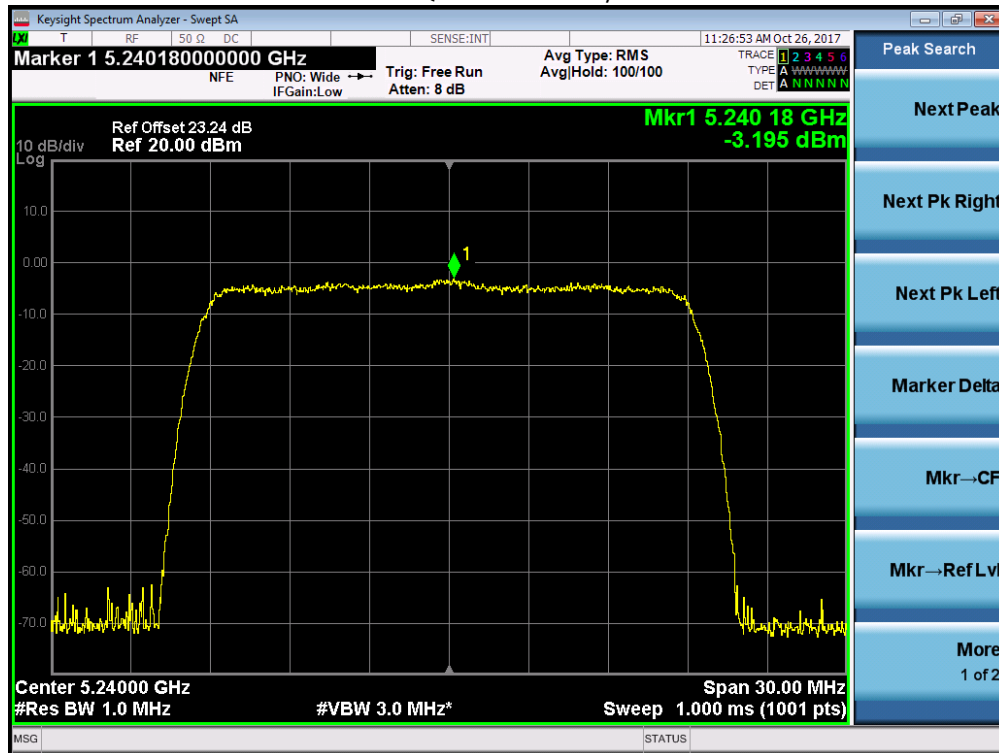

Channel Position T - 16QAM - Antenna B/ Bandwidth 20.0 MHz

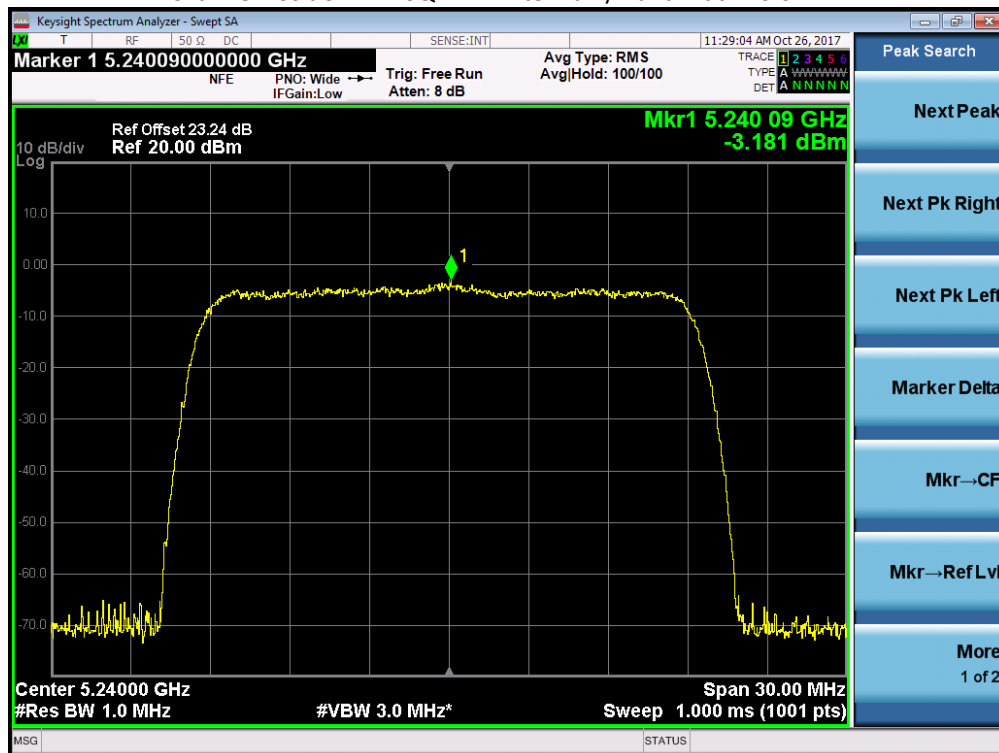

Channel Position B - 64QAM - Antenna A/ Bandwidth 20.0 MHz

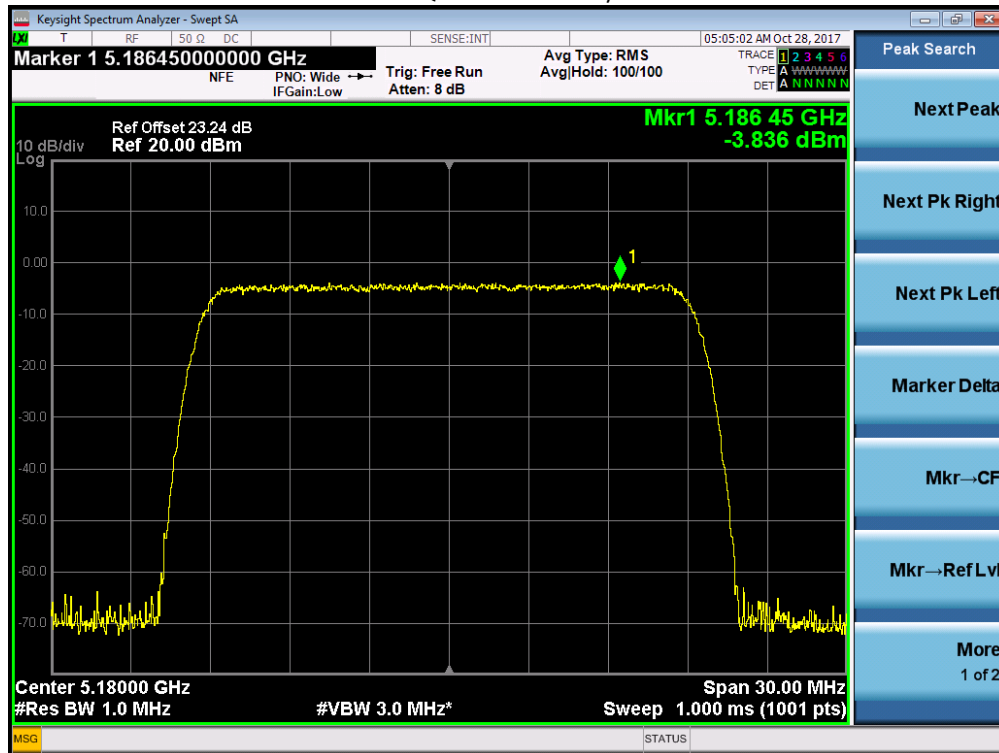

Channel Position B - 64QAM - Antenna B/ Bandwidth 20.0 MHz

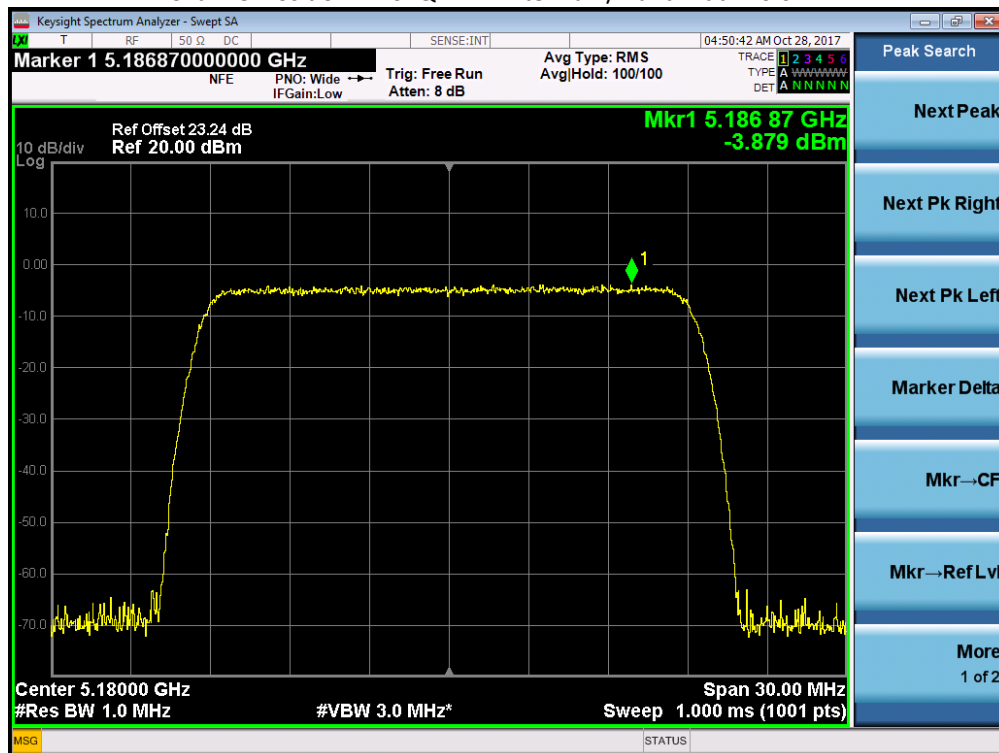

Channel Position M - 64QAM - Antenna A/ Bandwidth 20.0 MHz

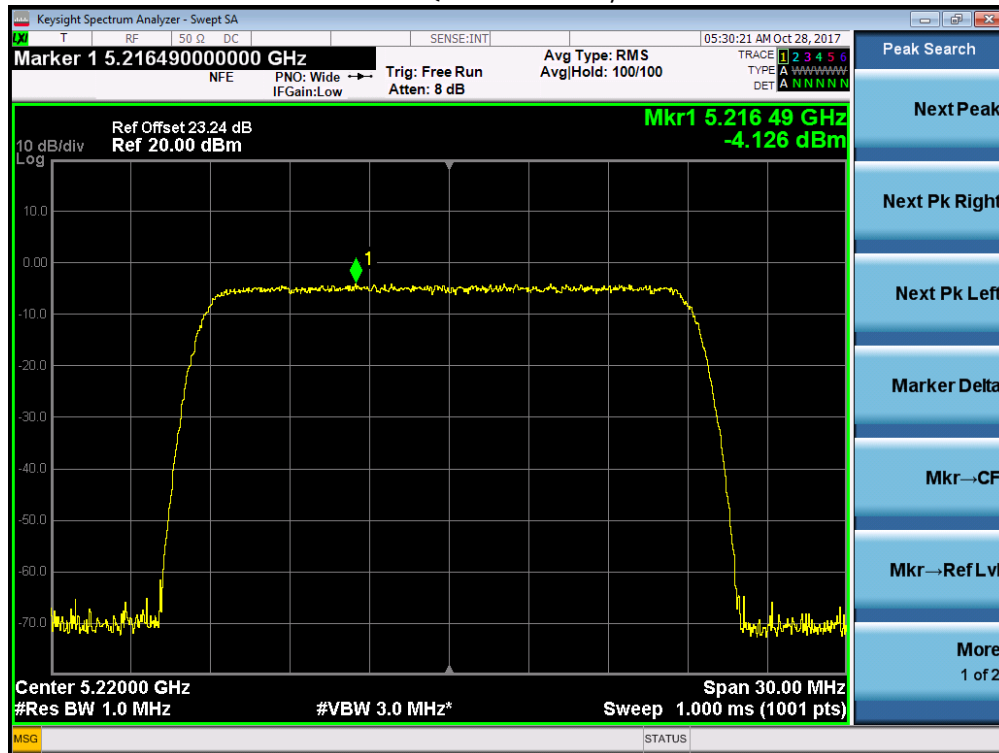

Channel Position M - 64QAM - Antenna B/ Bandwidth 20.0 MHz

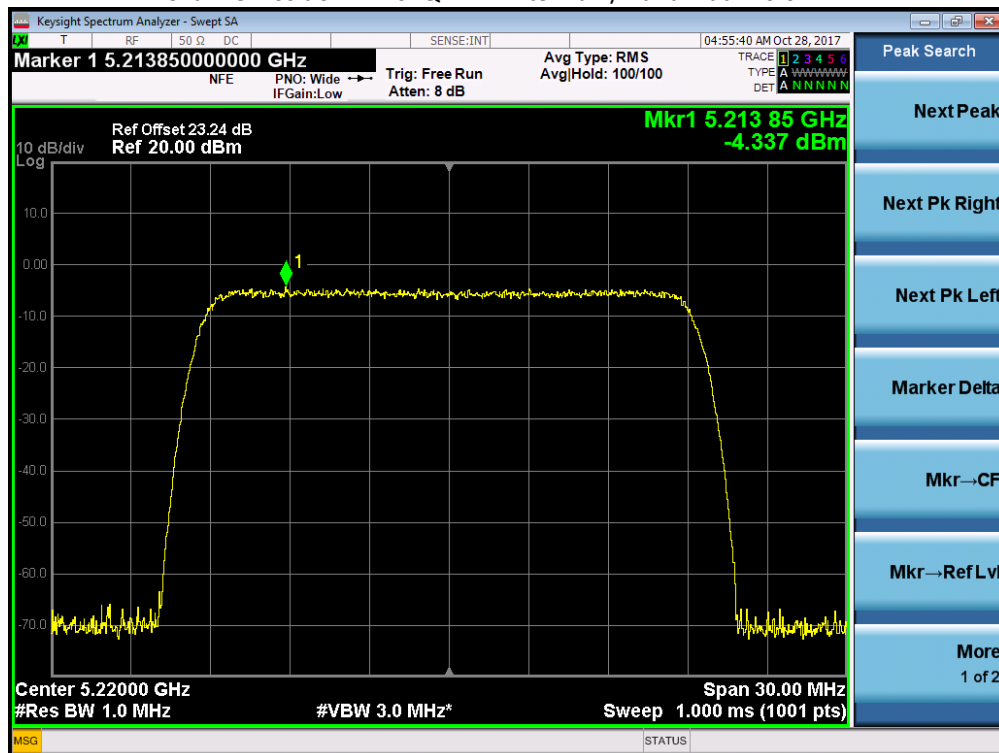

Channel Position T - 64QAM - Antenna A/ Bandwidth 20.0 MHz

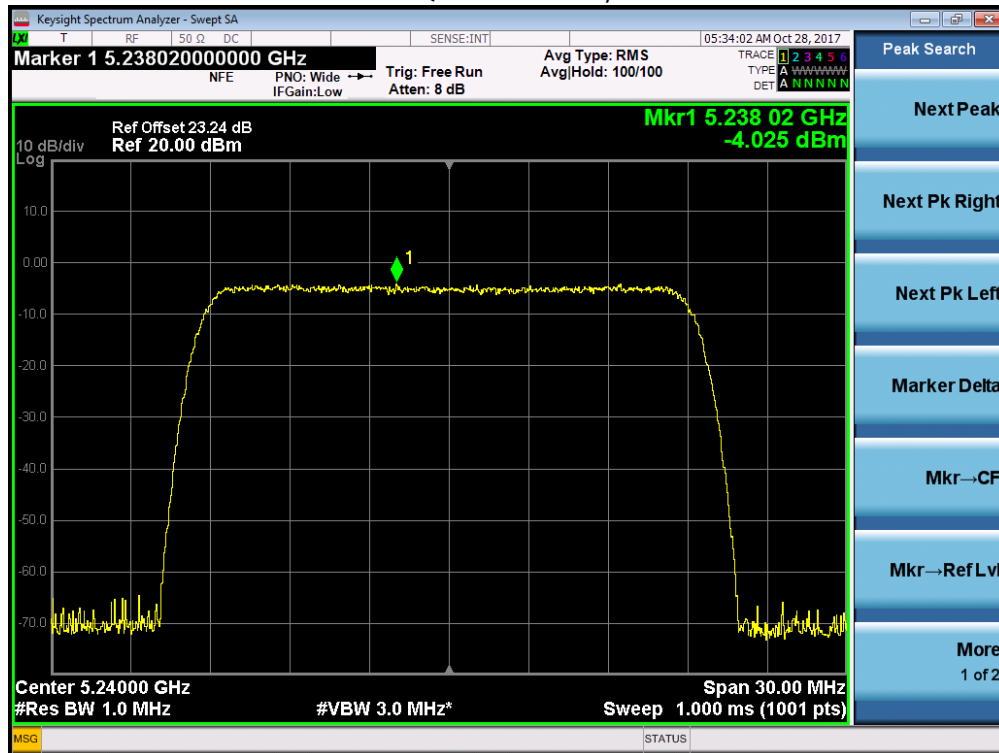

Channel Position T - 64QAM - Antenna B/ Bandwidth 20.0 MHz

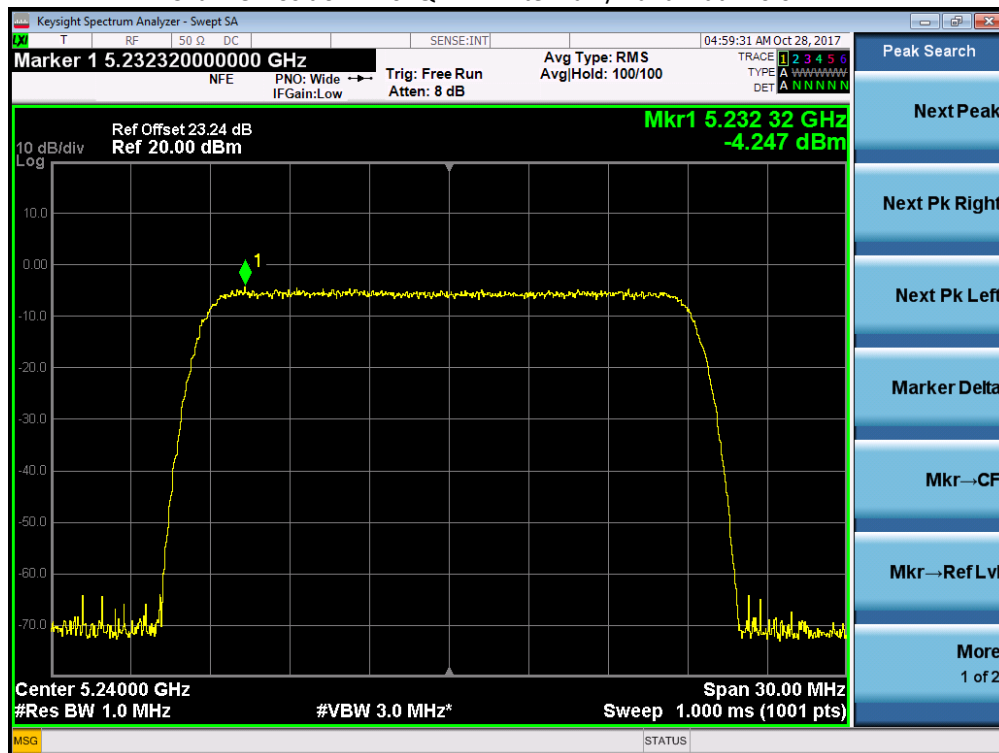

Channel Position B - 256QAM - Antenna A/ Bandwidth 20.0 MHz

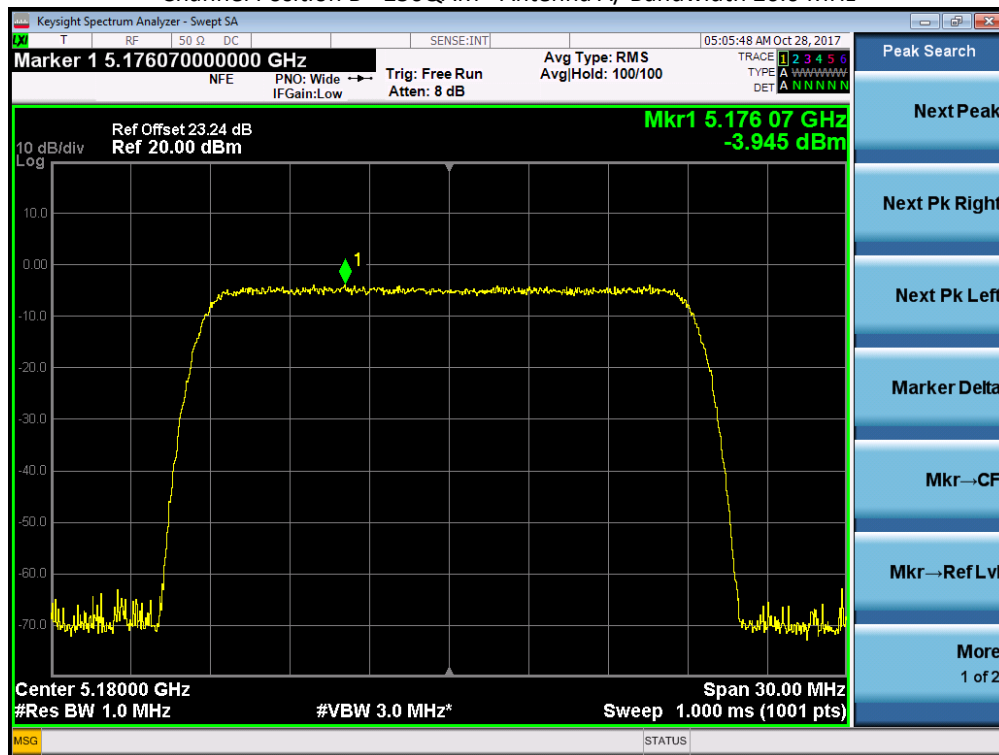

Channel Position B - 256QAM - Antenna B/ Bandwidth 20.0 MHz

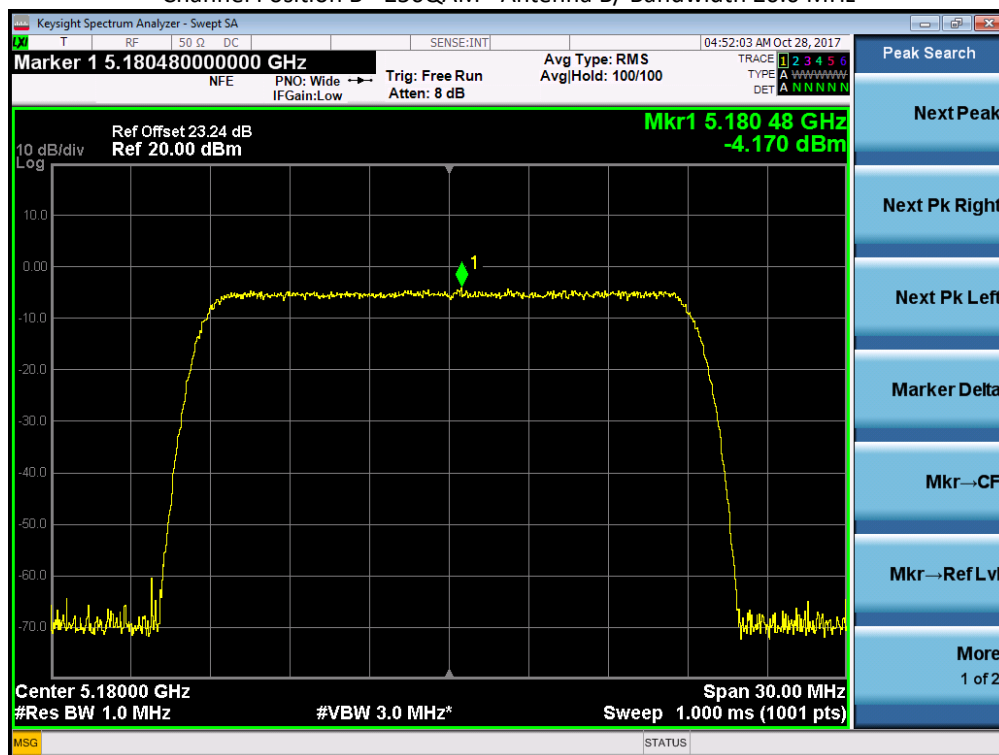

Channel Position M - 256QAM - Antenna A/ Bandwidth 20.0 MHz

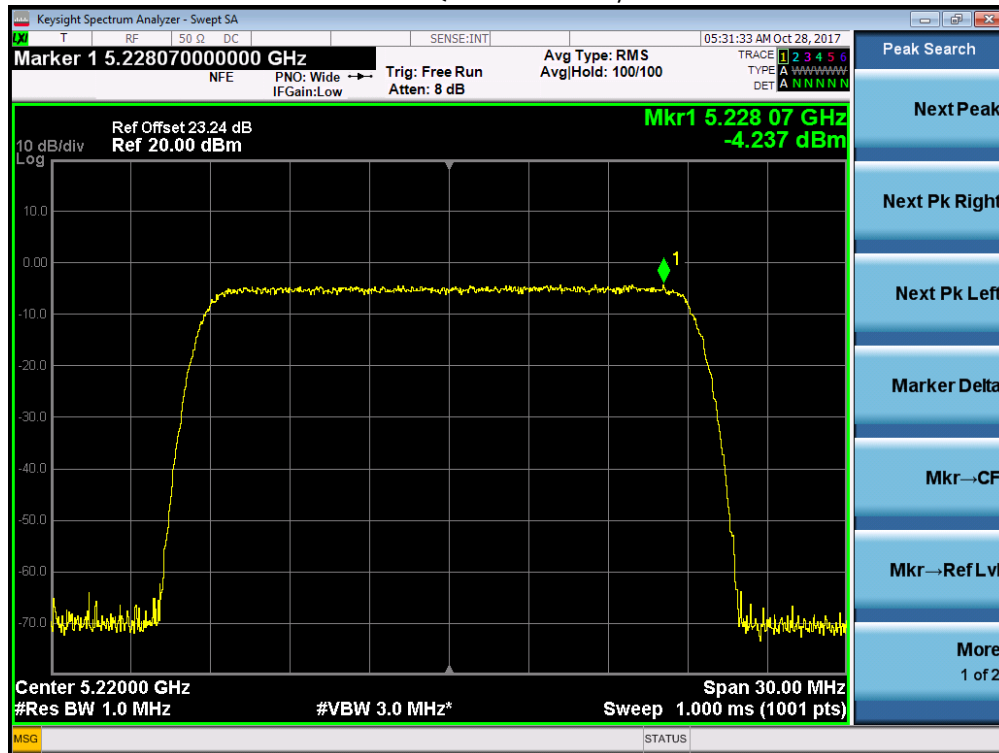

Channel Position M - 256QAM - Antenna B/ Bandwidth 20.0 MHz

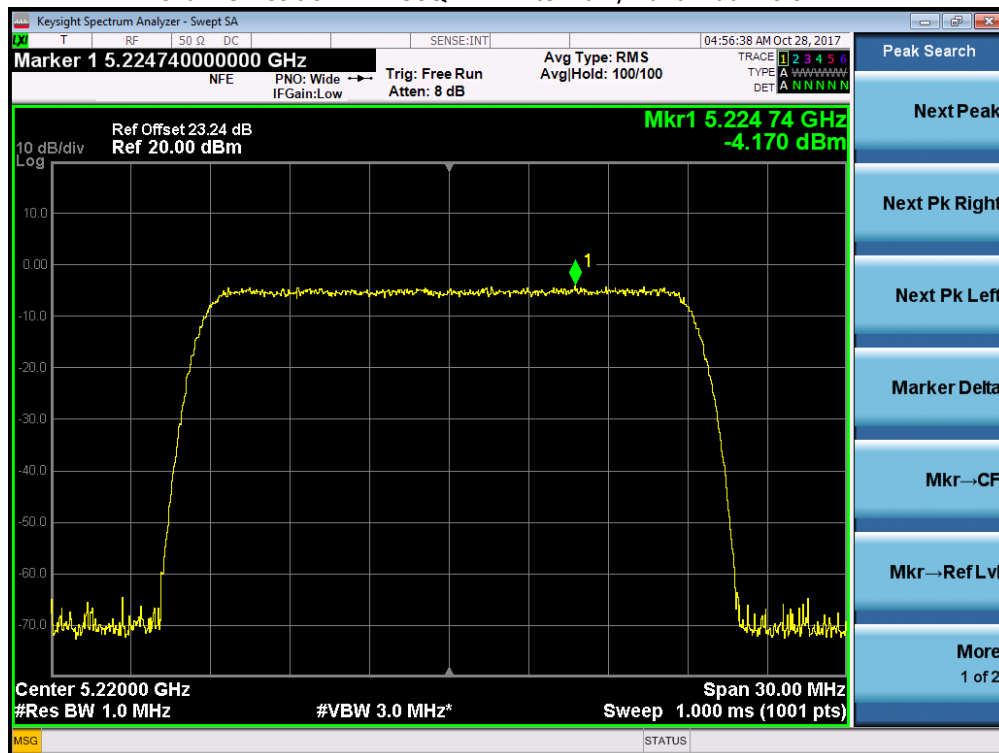

Channel Position T - 256QAM - Antenna A/ Bandwidth 20.0 MHz

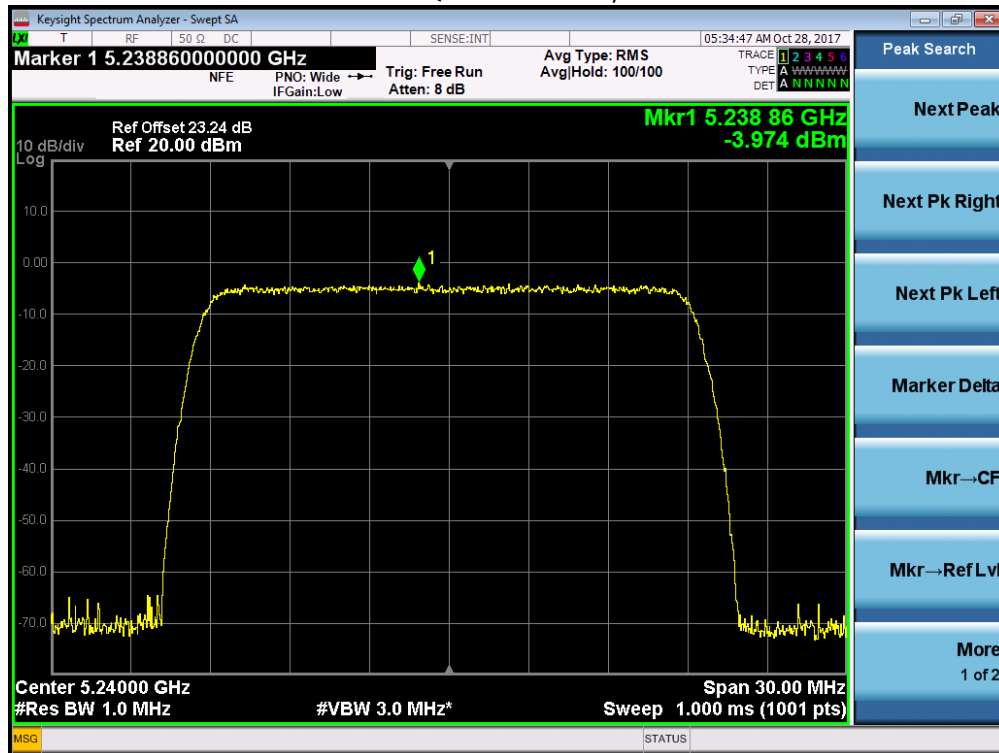

Channel Position T - 256QAM - Antenna B/ Bandwidth 20.0 MHz

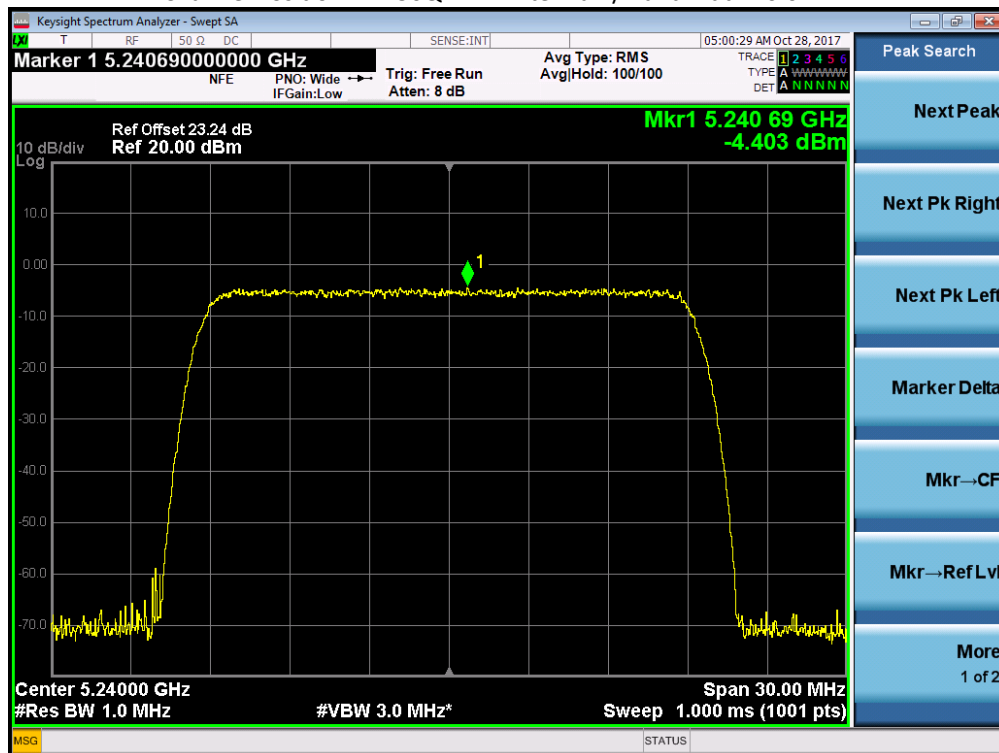

Configuration B1

L-MIMO-SC

Maximum Output Power 25dBm per port:

Antenna	Modulation / Carrier bandwidth (MHz)	Power Spectrum Density (dBm)		
		Channel Position B 5180MHz	Channel Position M 5220MHz	Channel Position T 5240MHz
A	QPSK / 20.0 MHz	13.200	12.956	12.777
B		13.419	13.280	12.905
Total		16.321	16.131	15.852

Antenna	Modulation / Carrier bandwidth (MHz)	Power Spectrum Density (dBm)		
		Channel Position B 5180MHz	Channel Position M 5220MHz	Channel Position T 5240MHz
A	16QAM / 20.0 MHz	13.344	13.330	13.322
B		13.623	13.488	13.287
Total		16.496	16.420	16.315

Antenna	Modulation / Carrier bandwidth (MHz)	Power Spectrum Density (dBm)		
		Channel Position B 5180MHz	Channel Position M 5220MHz	Channel Position T 5240MHz
A	64QAM / 20.0 MHz	13.308	12.830	12.828
B		13.276	13.067	12.648
Total		16.302	15.960	15.749

Antenna	Modulation / Carrier bandwidth (MHz)	Power Spectrum Density (dBm)		
		Channel Position B 5180MHz	Channel Position M 5220MHz	Channel Position T 5240MHz
A	256QAM / 20.0 MHz	13.365	13.234	12.800
B		13.281	13.067	12.656
Total		16.334	16.162	15.739

Channel Position B - QPSK - Antenna A/ Bandwidth 20.0 MHz

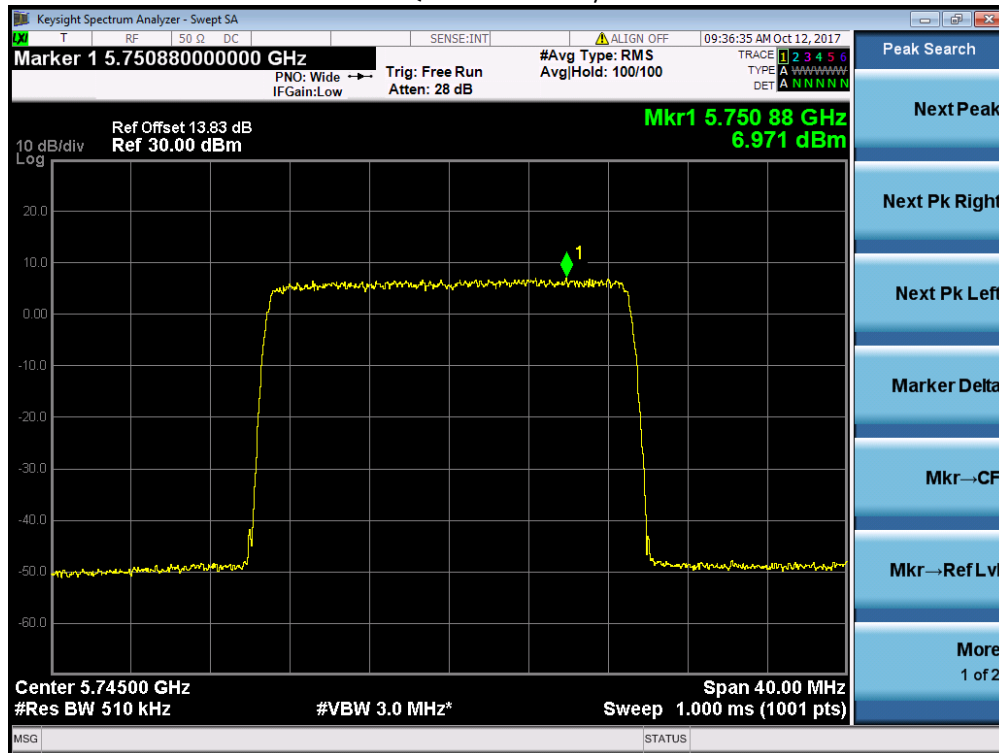

Channel Position B - QPSK - Antenna B/ Bandwidth 20.0 MHz

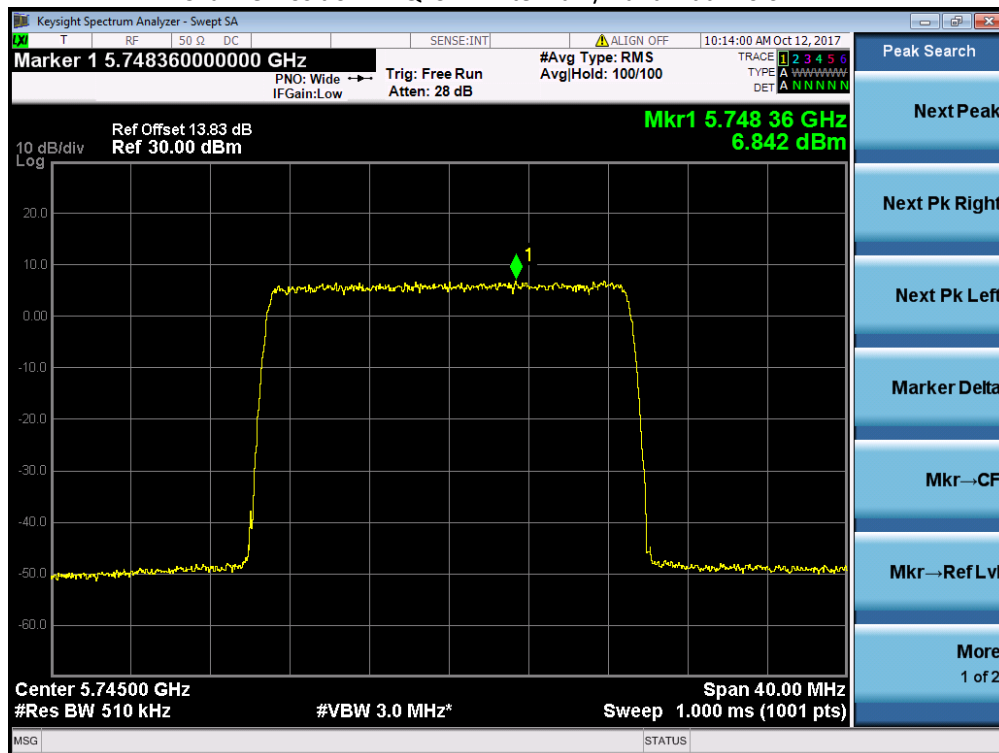

Channel Position M – QPSK - Antenna A/ Bandwidth 20.0 MHz

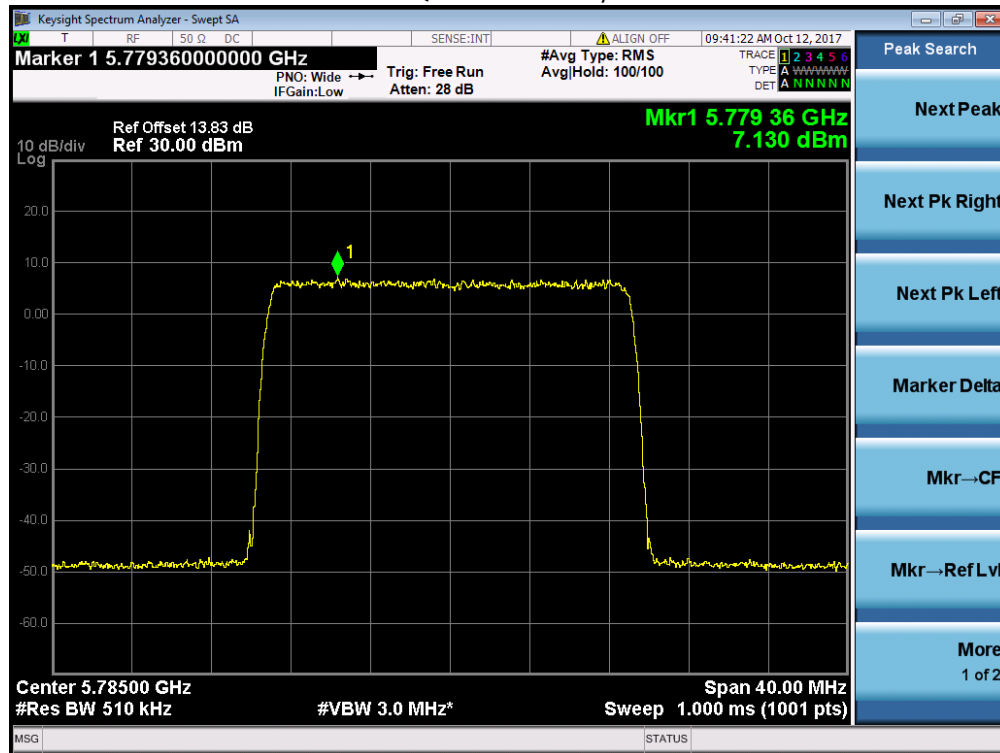

Channel Position M - QPSK - Antenna B/ Bandwidth 20.0 MHz

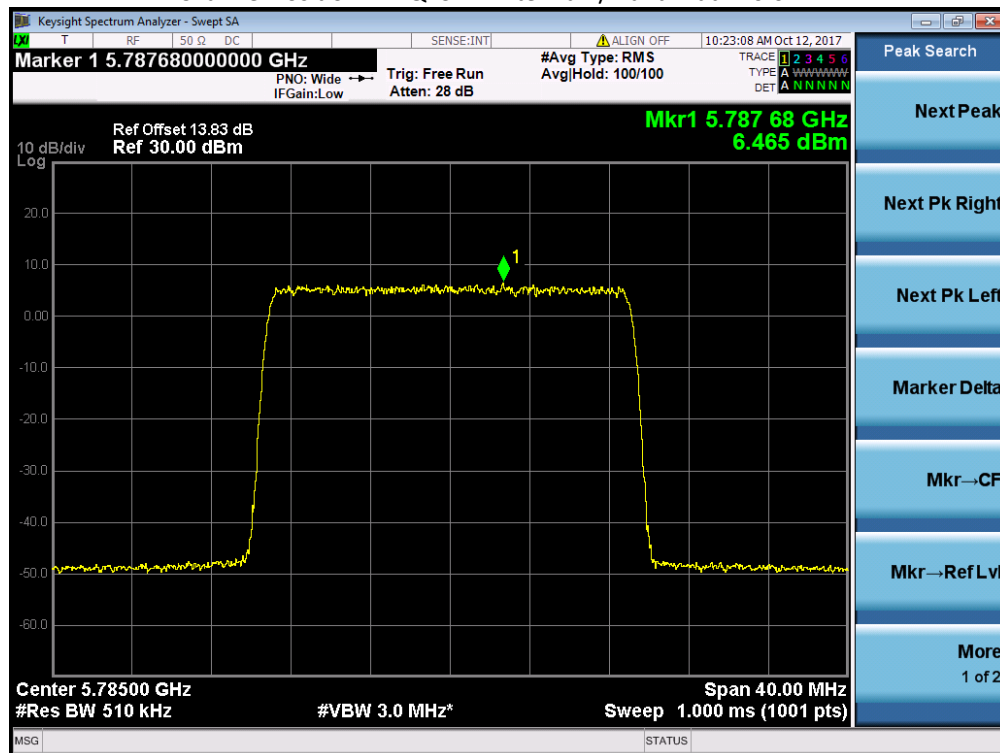

Channel Position T - QPSK - Antenna A/ Bandwidth 20.0 MHz

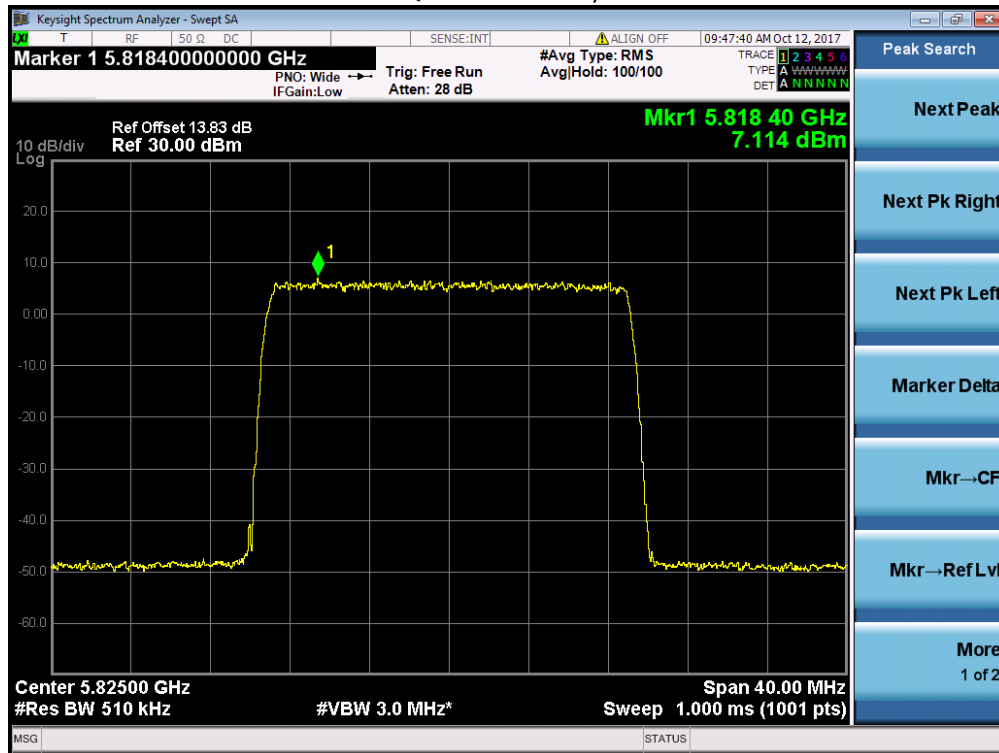

Channel Position T - QPSK - Antenna B/ Bandwidth 20.0 MHz

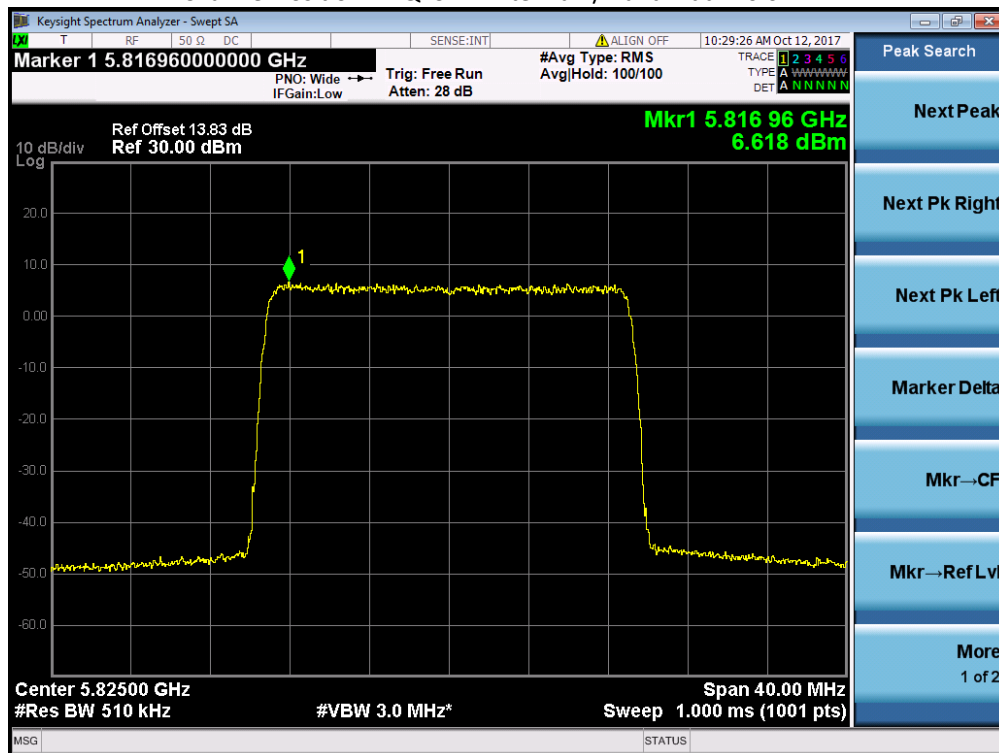

Channel Position B - 16QAM - Antenna A/ Bandwidth 20.0 MHz

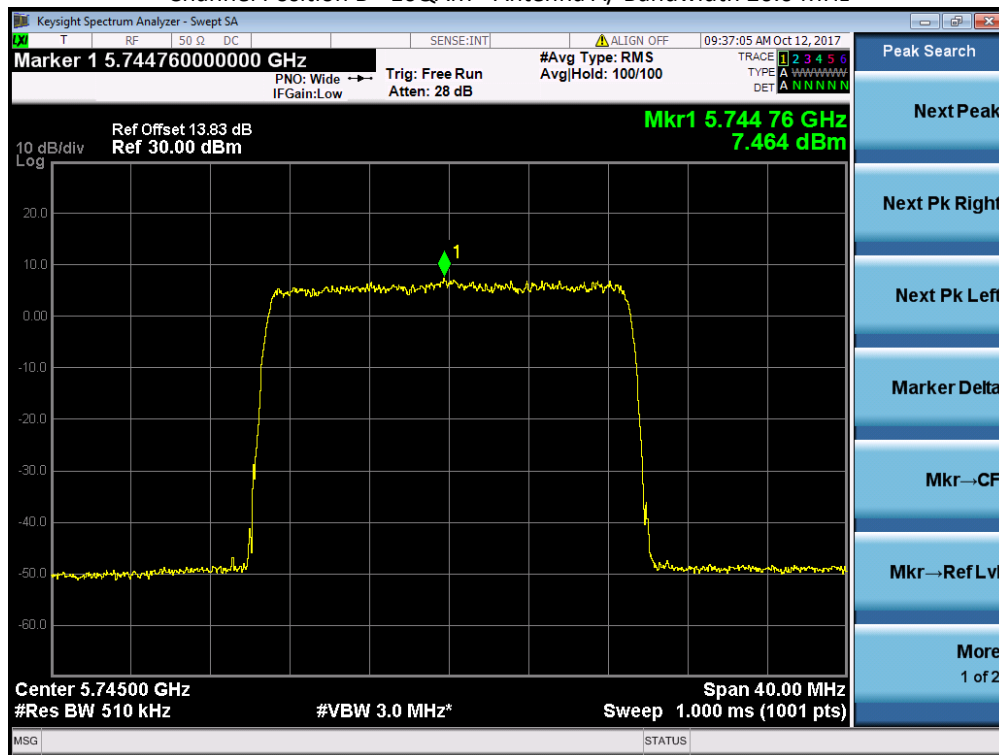

Channel Position B - 16QAM - Antenna B/ Bandwidth 20.0 MHz

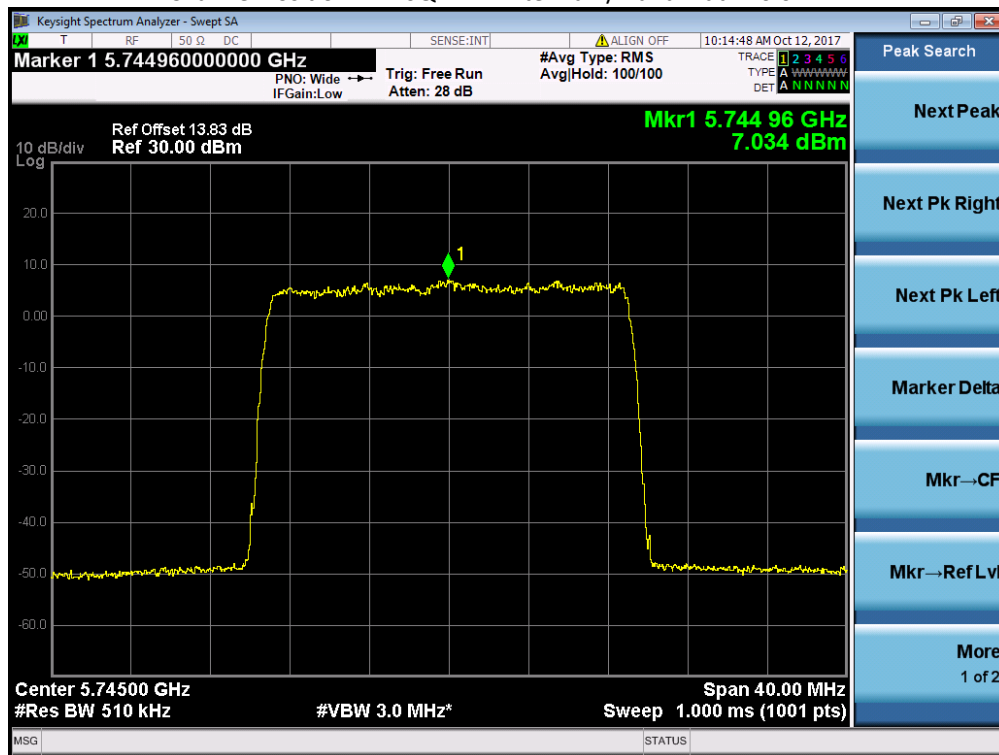

Channel Position M - 16QAM - Antenna A/ Bandwidth 20.0 MHz

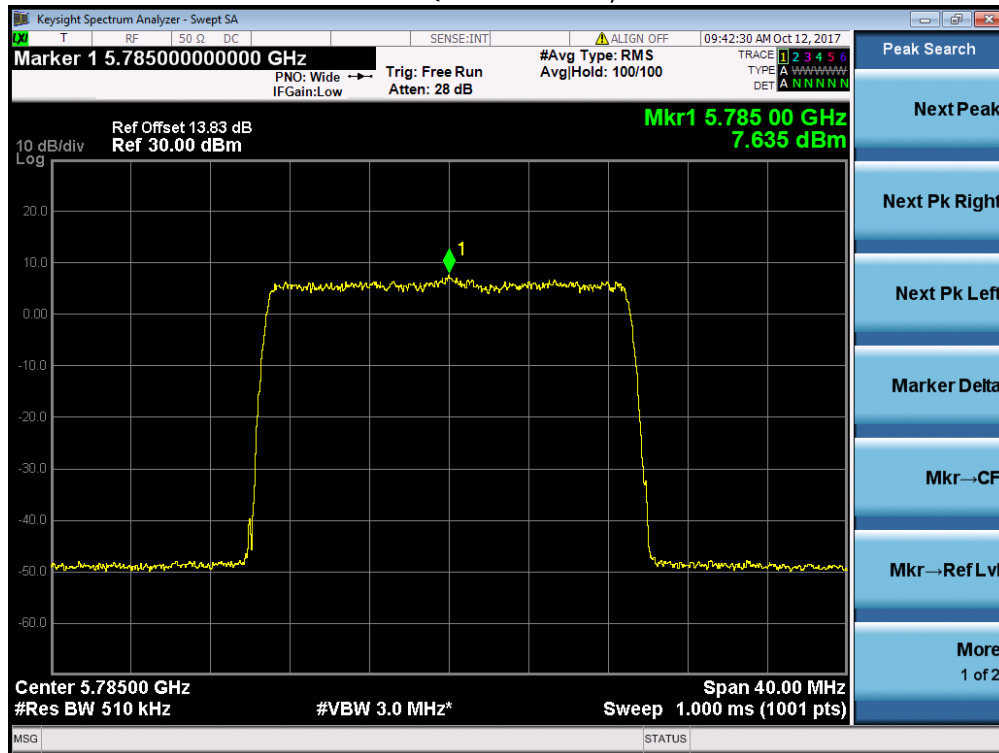

Channel Position M - 16QAM - Antenna B/ Bandwidth 20.0 MHz

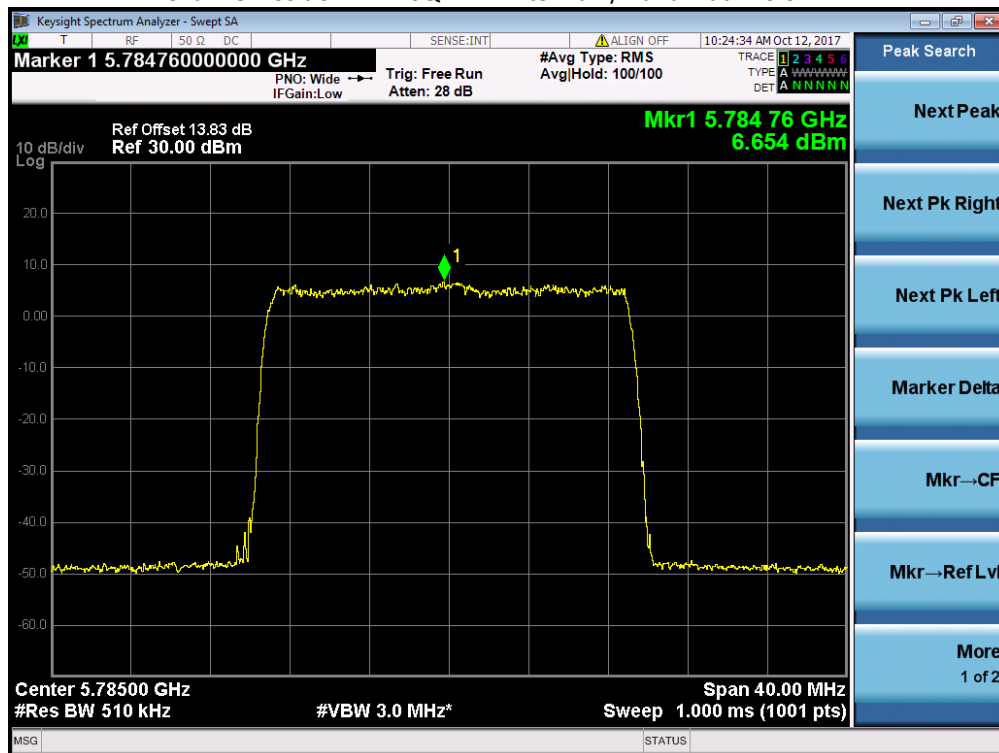

Channel Position T - 16QAM - Antenna A/ Bandwidth 20.0 MHz

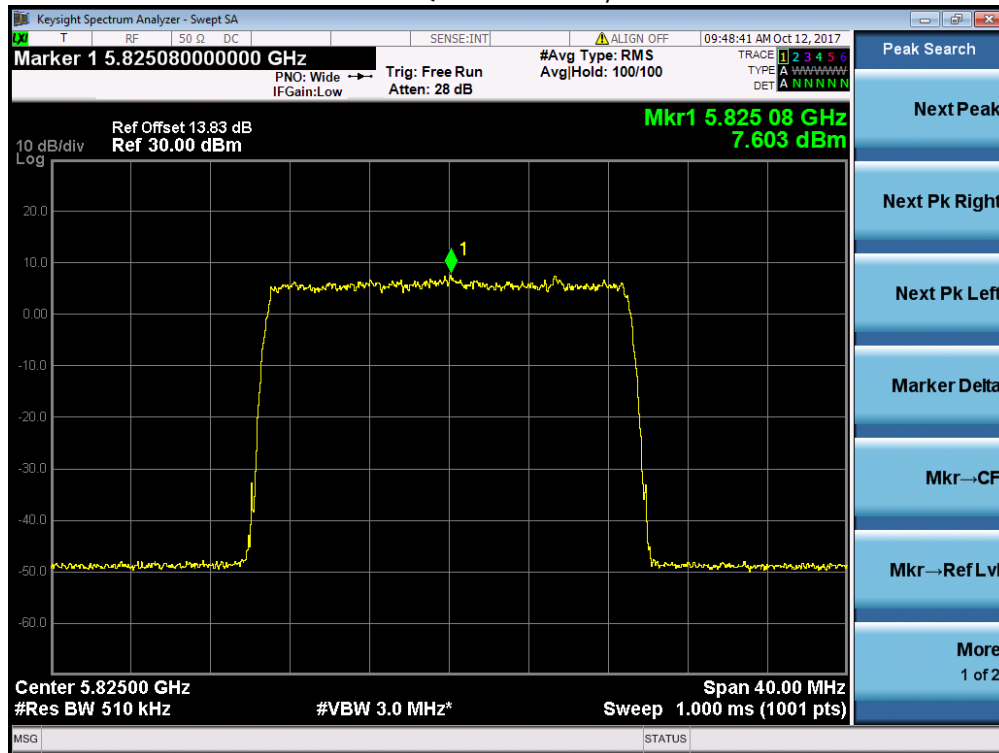

Channel Position T - 16QAM - Antenna B/ Bandwidth 20.0 MHz

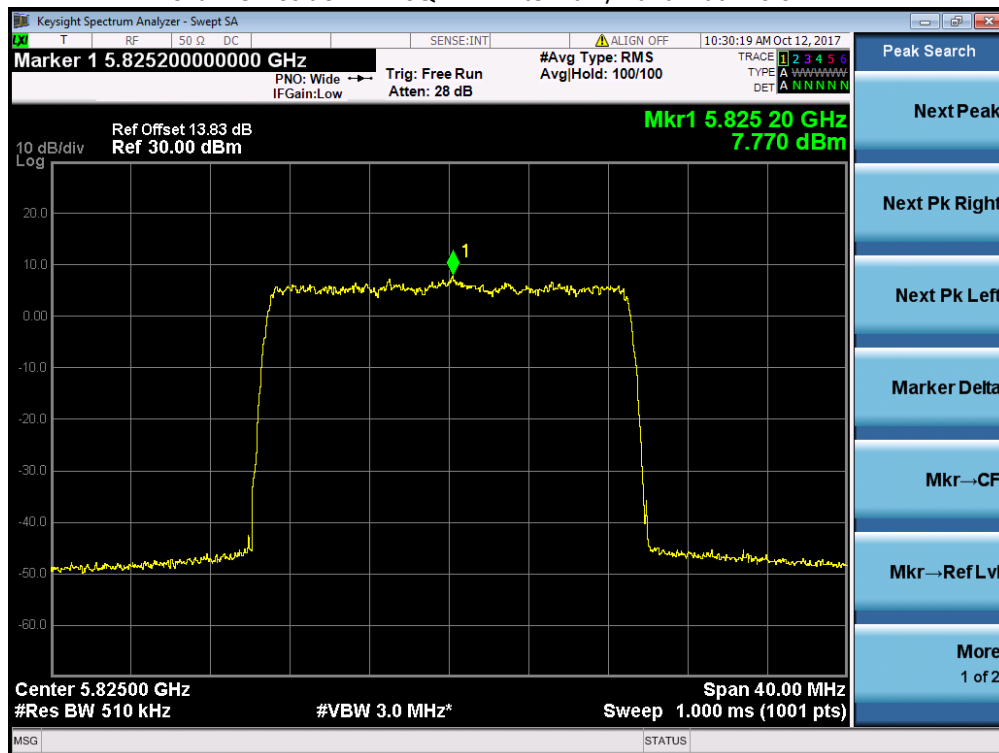

Channel Position B - 64QAM - Antenna A/ Bandwidth 20.0 MHz

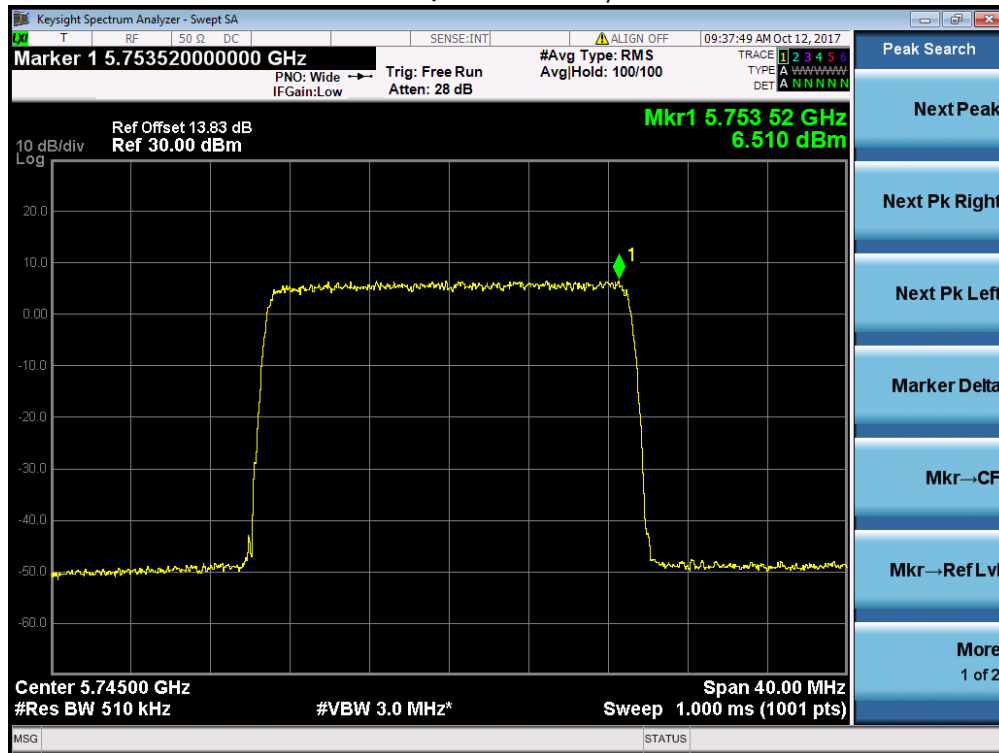

Channel Position B - 64QAM - Antenna B/ Bandwidth 20.0 MHz

